



CATALOGUE 2020/2021 TRUCK AND BUS



www.ufilters.com

HEAVY DUTY RANGE



INDEX



THE AFTERMARKET BUSINESS UNIT	002
GLOBAL PRESENCE	004
THE GROUP BY NUMBERS	005
CATALOGUE	006
GUARANTEE	007
TRANSLATIONS	008
NEW REFERENCES	012
REPLACED REFERENCES	016
NOTES	019
APPLICATIONS	025



THE AFTERMARKET BUSINESS UNIT



THE BEST OFFER FOR THE INDEPENDENT AFTERMARKET

Based in Verona, Italy, the Aftermarket Business Unit has been an independent entity since 2014 with a clear development strategy.

Comprising more than 100 professionals all over the world, it brings together various departments to offer excellent customer service: from product development to marketing (with the constant support of the sales force), from logistics (ensuring a precise, fast and flexible service) to quality (making sure the OE standards are always the same in the aftermarket range) and customer service (always alongside the customer).

Thirteen sales offices guarantee a widespread presence in all the key business for UFI Filters: Europe, China, India, North and South America and North Africa.

Aftermarket products are sold in over 70 countries in partnership with the leading distributors. The range consists of more than 2,850 car, heavy duty, agricultural and motorbike references.

The range is always being updated, taking full advantage of the powerfully innovative stimulus of the OE field to offer customers the best possible service. It guarantees a European car parc coverage of over 98% for each line: oil, fuel, air and cabin air.



OIL FILTERS

Spin-on, immersion and ecological solutions, with innovative filtration materials that ensure top engine performance with less consumption.



DIESEL FILTERS

Fitted with pioneering, exclusive filtering materials, they guarantee optimum engine protection and water-diesel separation of >95%.



PETROL AND LPG FILTERS

Filter the impurities from petrol and LPG, meeting the needs of the latest engines.



AIR FILTERS

Filter the impurities from the air, protecting the engine from corrosion and preventing any clogging of the injectors.



CABIN AIR FILTERS

Anti-pollen and activated carbon versions for the best air quality and comfort inside the passenger compartment, even in difficult environmental conditions.



GLOBAL PRESENCE

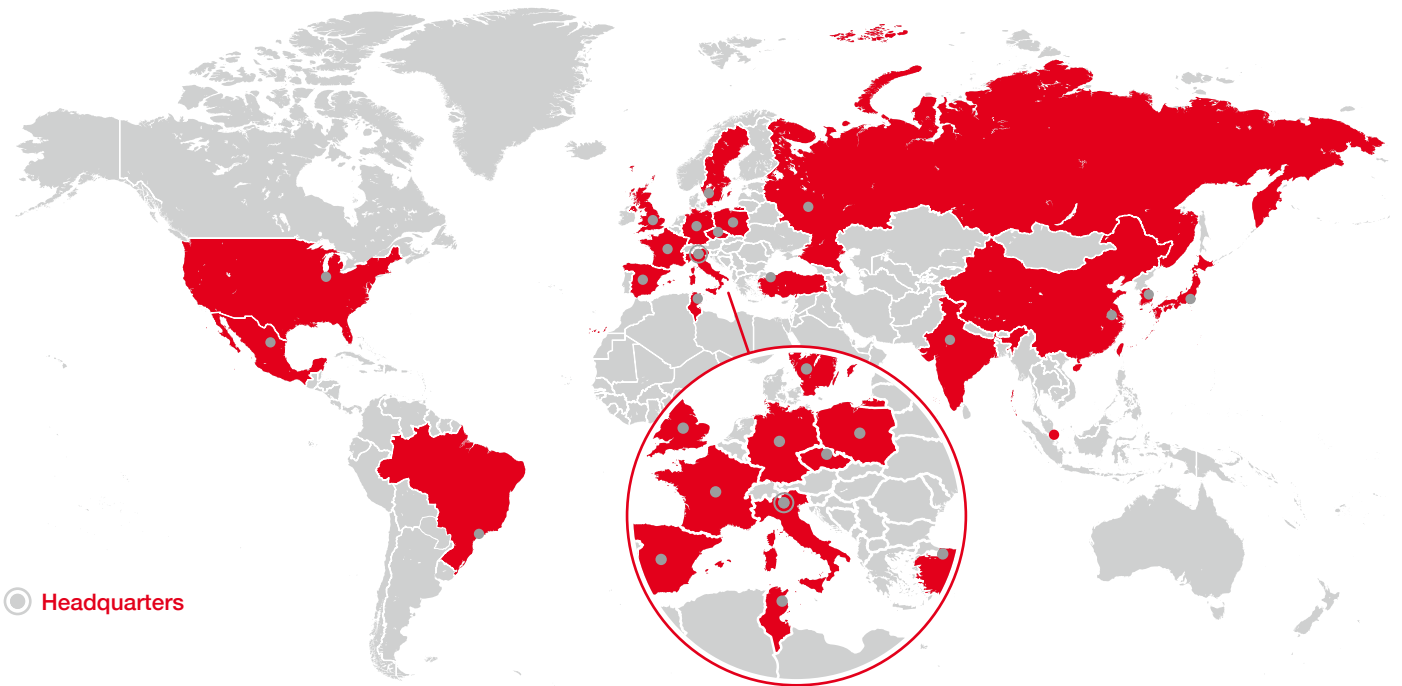

● Headquarters

19 PRODUCTION SITES, 3 INNOVATION CENTERS, 55 COMMERCIAL OFFICES

HEADQUARTERS

- UFI Filters S.p.A. Nogarole Rocca (IT)

19 PRODUCTION SITES

- UFI Filters S.p.A. (Nogarole Rocca, IT)
- UFI Filters S.p.A. (Marcaria, IT)
- Planet Filters S.p.A. (IT)
- Plastic Technology S.p.A. (IT)
- UFI Filters Czech s.r.o. (CZ)
- UFI Filters Poland Sp Zoo (PL)
- Sofima Filters S.A (TN)
- UFI Filters do Brasil LTDA (BR)
- UFI Filters México, S de RL de CV (MX)
- UFI Filters India Pvt. Ltd (Bawal, IN)

- UFI Filters India Pvt. Ltd (Belgaum, IN)
- Sofima Filters India Pvt. Ltd (Bahadurgarh, IN)
- Sofima Automotive Filter Shanghai Co, Ltd (CN)
- UFI Filters Shanghai Co, Ltd. (CN)
- Sofima Industrial Filter Shanghai Co, Ltd (CN)
- Sofima Automotive Filter Changchun Co, Ltd (CN)
- Sofima Trading Shanghai Co, Ltd (CN)
- Sofima Automotive Filters Chongqing (CN)
- UFI Filters Korea Co, Ltd. (KR)

3 INNOVATION CENTERS

- UFI Innovation Center S.r.l. (IT)
- UFI Innovation Center India Pvt. Ltd (IN)
- UFI Filters Shanghai Co, Ltd (CN)

18 COMMERCIAL OFFICES

IN EMEA

- Italy
- France
- Germany
- Poland
- Russia
- Spain
- Sweden
- Tunisia

- Turkey
- United Kingdom

32 COMMERCIAL OFFICES IN ASIA

- China
- India
- Japan
- Korea
- Singapore

5 COMMERCIAL OFFICES IN THE AMERICAS

- United States
- Brazil

THE GROUP BY NUMBERS



1971

Founded in **1971**, it's now a world leader in filtration technology and thermal management.



10

10 application sectors: from automotive (LV/HD), industry and hydraulics to special applications.



4.000

19 production plants and over **4,000 employees** in **19 countries** worldwide.



F1

Present everywhere, from **F1** cars to the **ExoMars** spacecraft.



95%

95% of vehicles manufacturers worldwide choose UFI Filters.



168

168 specialised technicians in the innovation and development centers in Italy and China.



206

206 patents at international level.



5%

5% of turnover reinvested in **R&D**.



6

6 lines of filters supplied: air, oil, fuel, cabin air, hydraulics and transmission.



>250

>250 co-branded products with the biggest OEM's.



CATALOGUE

EN

Although the content of this catalogue has been prepared with the utmost care and attention, it cannot be considered binding. Original part numbers are given for reference purposes only and cannot under any circumstances be printed on customer invoices. Original references for vehicle and engine manufacturers may be subject to modifications, and UFI FILTERS can not, therefore, accept any responsibility for inaccuracies that may have arisen. Should you have any doubts, we recommend that you consult your UFI FILTERS distributor for further information. This catalogue replaces and supersedes any previous editions.

IT

Le indicazioni contenute in questo catalogo sono state elaborate con la maggiore cura possibile, tuttavia non sono vincolanti. In caso di dubbio vi preghiamo di consultare il distributore UFI FILTERS. I codici dei costruttori di veicoli e di motori sono unicamente richiamati allo scopo di facilitarne la comparazione interna senza per altro stabilirne l'originalità. Non possiamo inoltre ritenerci responsabili per le variazioni apportate dai costruttori di veicoli e di motori susseguenti all'uscita di questo catalogo. I numeri originali indicati in questo catalogo non possono in alcun caso apparire sulle fatture della clientela. Questo catalogo sostituisce tutte le edizioni precedenti.

FR

Les informations techniques contenues dans ce catalogue ont été contrôlées avec le plus grand soin. Toutefois, celles-ci peuvent faire l'objet de modifications et sont données à titre indicatif. Elles ne sauraient engager la responsabilité de UFI FILTERS en cas de dysfonctionnement. Nous vous recommandons de consulter votre distributeur pour plus de précision et de toujours vous référer aux données et préconisations des constructeurs. Ce catalogue annule et remplace la version précédente.

DE

Die in diesem Katalog enthaltenen Informationen Angaben sind mit der größten Sorgfalt erarbeitet worden, dabei sind sie nicht bindend. Im Zweifelsfall bitten wir Sie einen UFI FILTERS Wiederverkäufer zu konsultieren. Die Artikelnummern der Fahrzeughersteller und Motorenhersteller sind lediglich zu Vergleichszwecken aufgeführt um die Vergleichbarkeit zu erleichtern ohne auf die Herkunft hinzuweisen. Ebenso sind wir nicht verantwortlich für Änderungen, die von den Fahrzeugherstellern und Motorenherstellern nach Erscheinen dieses Katalogs vorgenommen werden. Die in diesem Katalog aufgeführten Originalnummern dürfen auf keinen Fall auf Kundenrechnungen erscheinen. Dieser Katalog ersetzt alle vorangegangenen.

ES

Las indicaciones contenidas en este catálogo han sido elaboradas con el mayor cuidado posible, si bien no nos responsabilizamos de cualquier posible error. En caso de duda, sirvanse consultar a su Distribuidor UFI. Las referencias originales de los constructores de los vehículos y de los motores se dan únicamente a efectos de comparación. Los constructores pueden modificar en cualquier momento las denominaciones de sus fabricados. Por tanto, UFI no se hace responsable de las variaciones que pudieran producirse después de la edición de este catálogo. En ningún caso, las referencias originales indicadas en este catálogo pueden aparecer en las facturas a los clientes. Este catálogo sustituye cualquier publicación anterior.

GUARANTEE



EN

The production methods used for UFI branded filters guarantee the highest possible levels of quality and safety for our products. We maintain these levels of both quality and safety through the rigorous controls that are carried out on raw materials, during the production process, and on the finished product. Thanks to these methods and tests, UFI branded filters guarantee maximum performance. Should an imperfect product reach the market in spite of our quality control procedures, then subject to testing in our laboratory UFI FILTERS is willing to assume the responsibility for any damage caused by said product.

IT

Tutte le fasi di produzione dei filtri UFI sono state concepite in modo tale da garantire il massimo della sicurezza qualitativa dei prodotti. La costanza della qualità ed un alto standard qualitativo vengono assicurati mediante rigorosi controlli sulla qualità delle materie prime in entrata, durante ed alla fine del ciclo produttivo. Pertanto i filtri UFI garantiscono una perfetta funzionalità. Se, nonostante i nostri accurati controlli prima, durante e dopo la produzione, un pezzo non perfetto dovesse giungere sul mercato, UFI FILTERS è disposta ad assumersi la responsabilità per i danni provocati dal filtro imperfetto.

FR

UFI FILTERS assure un très haut niveau de qualité dans la fabrication des filtres qui sont commercialisés dans sa gamme. Les méthodes de production sont rigoureusement contrôlées ainsi que la qualité des matières premières utilisées. De nombreux tests sont effectués et permettent de garantir les meilleures performances des produits. Toutefois, si l'un des produits commercialisés par UFI FILTERS était reconnu comme étant défectueux par le service "Contrôle Qualité" cela donnerai lieu à une prise en charge, par UFI FILTERS, de toutes les dépenses qui découleraient de ce défaut.

DE









Sämtliche Schritte der Produktion von UFI Filtern sind ausgerichtet, um ein Höchstmaß an qualitativer Sicherheit der Produkte zu bieten. Rigorose Qualitätskontrollen beim Wareneingang des Rohmaterials, während und am Ende der Produktion sichern ständig einen hohen Qualitätsstandard. Daher garantieren UFI Filter eine perfekte Funktion. Sollte trotz unserer Kontrollen vor, während und nach der Produktion, doch ein nicht einwandfreies Teil in den Handel gelangen, ist UFI FILTERS bereit die Schadenhaftung nach den gesetzlichen Bestimmungen zu übernehmen.

ES

Cada paso en la fabricación del filtro UFI se ejecuta de modo que se garantiza la mejor calidad y fiabilidad del producto. La constancia y alto nivel de calidad están aseguradas mediante rigurosos ensayos de calidad, tanto de las materias primas como durante todo el proceso de producción. Por tanto, el filtro UFI esta virtualmente garantizado para funcionar perfectamente. No obstante, si a pesar de los exhaustivos ensays previos, un filtro defectuoso llegara al mercado, UFI acepta la responsabilidad del daño, única y directamente atribuible a un defecto de fabricación en el filtro.



TRANSLATIONS

EN	IT	FR	DE	ES
 Model	Modello	Modèle	Modellreihe	Modelo
 Engine	Motore	Moteur	Motor	Motor
kW kW	kW	kW	kW	kW
HP HP	CV	CH	PS	CV
 Year of construction	Anno di costruzione	Année de fabrication	Baujahr	Año de fabricación
 Oil	Olio	Huile	Öl	Aceite
 Fuel	Carburante	Carburant	Kraftstoff	Carburante
 Air	Aria	Air	Luft	Aire
 Cabin Air filters / Other filters	Filtri abitacolo / Altri filtri	Filtres a air pour habitacle / Filtres spéciaux	Innenraumfilter / Sonstige Filter	Habitáculo / Otros filtros
 For life filter	Filtro per la vita	Filter longue durée	Lifetime-Filter	Filtro de por vida
 No filter fitted	Non monta filtri	Aucun filtre monté	Kein Filter verbaut	No equipa filtro
1st passage	1.passaggio	1er passage	Vorfilter	Primario
2nd passage	2.passaggio	2ème passage	Feinfilter	Secundario
2WD	2WD	2 roues motrices	2 Antriebsräder	2 ruedas motrices
4WD	4WD	4 roues motrices	4 Antriebsräder	4 ruedas motrices
K-Jetronic	K-Jetronic	K-Jetronic	K-Jetronic	K-Jetronic
L-Jetronic	L-Jetronic	L-Jetronic	L-Jetronic	L-Jetronic
Middle East	Medio Oriente	Moyen-Orient	Mittlerer Orient	Oriente Medio
2 filters	N.2 filtri	2 filtres	2 Filter	2 filtros
Normal Power	Normal Power	Puissance Normale	Normalleistung	Potencia normal
System-Porsche	System-Porsche	System-Porsche	System-Porsche	System-Porsche
to engine No.	a motore N.	jusqu'au moteur n°	bis Motor Nr.	hasta motor núm.
on request	a richiesta	sur demande	auf Anfrage	a petición
to series No.	a serie N.	jusqu'à la série n°	bis zur Baureihe Nr.	hasta serie núm.
to frame No.	a telaio N.	jusqu'au châssis n°	bis zum Rahmen Nr.	hasta bastidor núm.
adapter for passenger compartment filter	adattatore per filtro abitacolo	adaptateur pour filtre d'habitacle	Adapter für Innenraumluftfilter	adaptador para filtro habitáculo
with activated carbons	ai carboni attivi	aux charbons actifs	mit Aktivkohlen	de carbón activo
with activated carbons, to frame No.	ai carboni attivi, a telaio N.	aux charbons actifs, jusqu'au châssis n°	mit Aktivkohlen, bis zum Rahmen Nr.	de carbón activo, hasta bastidor núm.
with activated carbons, with pump	ai carboni attivi, con pompa	aux charbons actifs, avec pompe	mit Aktivkohlen, mit Pumpe	de carbón activo, con bomba
with activated carbons, from frame No.	ai carboni attivi, da telaio N.	aux charbons actifs, du châssis n°	mit Aktivkohlen, von Rahmen Nr.	de carbón activo, desde bastidor núm.
with activated carbons, assembly	ai carboni attivi, montaggio	aux charbons actifs, montage	mit Aktivkohlen, zusammenbau	de carbón activo, montaje
some	alcuni	certains	einige	algunos
spin-on	avvitabile	à visser	schraubbar	roscado
spin-on with drain	avvitabile con spurgo	à visser avec purge	schraubbar mit Ablass	roscado con purgador



EN	IT	FR	DE	ES
spin-on without drain	avvitabile senza spurgo	à visser sans purge	schraubbar ohne Ablass	roscado sin purgador
by-pass	by-pass	en dérivation	Nebenstrom	by-pass
carburetor	carburatore	carburateur	Vergaser	carburador
with	con	avec	mit	con
with automatic gearbox	con cambio automatico	avec boîte de vitesses automatique	mit Automatikgetriebe	con cambio automático
with manual gearbox	con cambio manuale	avec boîte de vitesses manuelle	mit Schaltgetriebe	con cambio manual
with carburetor	con carburatore	avec carburateur	mit Vergaser	con carburador
with single carburetor	con carburatore singolo	avec carburateur individuel	mit Einzelvergaser	con carburador individual
with air-conditioner	con climatizzatore	avec climatiseur	mit Klimaanlage	con climatizador
with air-conditioner (spare part only)	con climatizzatore (solo ricambio)	avec climatiseur (rechange uniquement)	mit Klimaanlage (nur Ersatzteil)	con climatizador (sólo repuesto)
with automatic air-conditioner	con climatizzatore automatico	avec climatiseur automatique	mit automatischer Klimaanlage	con climatizador automático
with automatic air-conditioner and R.H.D.	con climatizzatore automatico e guida a destra	avec climatiseur automatique et conduite à droite	mit automatischer Klimaanlage und Rechtslenker	con climatizador automático y conducción a derecha
with automatic air-conditioner and L.H.D.	con climatizzatore automatico e guida a sinistra	avec climatiseur automatique et conduite à gauche	mit automatischer Klimaanlage und Linkslenker	con climatizador automático y conducción a izquierda
with air-conditioner with automatic gearbox	con climatizzatore con cambio automatico	avec climatiseur avec boîte de vitesses automatique	mit Klimaanlage mit Automatikgetriebe	con climatizador con cambio automático
with air-conditioner with manual gearbox	con climatizzatore con cambio manuale	avec climatiseur avec boîte de vitesses manuelle	mit Klimaanlage mit Schaltgetriebe	con climatizador con cambio manual
with air-conditioner from	con climatizzatore da	avec climatiseur du	mit Klimaanlage von	con climatizador desde
with air-conditioner and R.H.D.	con climatizzatore e guida a destra	avec climatiseur et conduite à droite	mit Klimaanlage und Rechtslenker	con climatizador y conducción derecha
with air-conditioner and L.H.D.	con climatizzatore e guida a sinistra	avec climatiseur et conduite à gauche	mit Klimaanlage und Linkslenker	con climatizador y conducción izquierda
with air-conditioner and L.H.D. (spare part only)	con climatizzatore e guida a sinistra (solo ricambio)	avec climatiseur et conduite à gauche (rechange uniquement)	mit Klimaanlage und Linkslenker (nur Ersatzteil)	con climatizador y conducción izquierda (sólo repuesto)
with manual air-conditioner	con climatizzatore manuale	avec climatiseur manuel	mit manueller Klimaanlage	con climatizador manual
with air-conditioner without recirculation and L.H.D.	con climatizzatore senza ricircolo e guida a sinistra	avec climatiseur sans recirculation et conduite à gauche	mit Klimaanlage ohne Rezirkulation und Linkslenker	con climatizador sin recirculación y conducción izquierda
with activated carbon air-conditioner	con climatizzatore, ai carboni attivi	avec climatiseur, aux charbons actifs	mit Klimaanlage mit Aktivkohlen	con climatizador, de carbón activo
with air-conditioner, assembly	con climatizzatore, montaggio	avec climatiseur, montage	mit Klimaanlage, zusammenbau	con climatizador, montaje
with air-conditioner, dusty areas	con climatizzatore, per zone polverose	avec climatiseur, des zones poussiéreuses	mit Klimaanlage, staubige Gebiete	con climatizador, para zonas polvorientas
with hexagonal release nut	con dado di smontaggio esagonale	avec écrou de démontage hexagonal	mit Sechskantlösemutter	con tuerca de desmontaje hexagonal
with double carburetor	con doppio carburatore	avec carburateur double	mit Doppelvergaser	con doble carburador
with filter	con filtro	avec filtre	mit Filter	con filtro
with dry air filter	con filtro aria a secco	avec filtre à air à sec	mit Trockenluftfilter	con filtro seco de aire
with gasoline filter with pressure regulator	con filtro benzina con regolatore di pressione	avec filtre à essence avec régulateur de pression	mit Benzinflter mit Druckregler	con filtro de gasolina equipado de regulador de presión
with gasoline filter without pressure regulator	con filtro benzina senza regolatore di pressione	avec filtre à essence sans régulateur de pression	mit Benzinflter ohne Druckregler	con filtro de gasolina sin regulador de presión
with metal complete filter	con filtro completo in metallo	avec filtre complet en métal	mit Kompletfilter aus Metall	con filtro completo en metal
with plastic complete filter	con filtro completo in plastica	avec filtre complet en plastique	mit Kompletfilter aus Plastik	con filtro completo en plástico
with heated fuel filter, spare part only	con filtro gasolio riscaldato, solo ricambio	filtre à carburant avec réchauffeur, en rechange uniquement	Kraftstofffilter beheizt, nur Ersatzteil	filtro de combustible con calentador, sólo recambio
with oil filter equipped with aluminium cover	con filtro olio completo con coperchio in alluminio	avec filtre à huile complet avec couvercle en aluminium	mit komplettem Ölfilter mit Alu-Deckel	con filtro de aceite equipado de tapa en aluminio
with oil filter equipped with plastic cover	con filtro olio completo con coperchio in plastica	avec filtre à huile complet avec couvercle en plastique	mit komplettem Ölfilter mit Kunststoffdeckel	con filtro de aceite equipado de tapa en plástico



TRANSLATIONS

EN	IT	FR	DE	ES
with R.H.D.	con guida a destra	avec conduite à droite	mit Rechtslenker	con conducción a derecha
with activated carbon R.H.D.	con guida a destra, ai carboni attivi	avec conduite à droite, aux charbons actifs	mit Rechtslenker mit Aktivkohlen	con conducción a derecha, de carbón activo
with R.H.D., assembly	con guida a destra, montaggio	avec conduite à droite, montage	mit Rechtslenker, zusammenbau	con conducción a derecha, montaje
with L.H.D.	con guida a sinistra	avec conduite à gauche	mit Linkslenker	con conducción a izquierda
with activated carbon L.H.D.	con guida a sinistra, ai carboni attivi	avec conduite à gauche, aux charbons actifs	mit Linkslenker mit Aktivkohlen	con conducción a izquierda, de carbón activo
with L.H.D., assembly	con guida a sinistra, montaggio	avec conduite à gauche, montage	mit Linkslenker, zusammenbau	con conducción a izquierda, montaje
with cabin filter kit, spare part only	con kit filtro abitacolo, solo ricambio	avec kit filtre d'habitable, rechange uniquement	mit Innenraumluftfiltersatz, nur Ersatzteil	con kit filtro habitáculo, sólo repuesto
with antipollution assembly with pump	con montaggio antinquinamento con pompa	avec montage antipollution avec pompe	mit Umweltschutzmontage mit Pumpe	con montaje anticontaminación con bomba
with pump and heater	con pompa e riscaldatore	avec pompe et réchauffeur	mit Pumpe und Vorwärmer	con bomba y calentador
with in-line pump	con pompa in linea	avec pompe en ligne	mit Reiheneinspritzpumpe	con bomba en línea
with rotary pump	con pompa rotativa	avec pompe rotative	mit Verteilereinspritzpumpe	con bomba rotativa
with facility for water sensor	con predisposizione per sensore acqua	avec raccord pour sonde de niveau d'eau	mit Anschluss für einen Wassersensor	con conexión para el sensor del agua
with oil radiator	con radiatore dell'olio	avec radiateur à huile	mit Ölkühler	con radiador de aceite
with oil cooling	con raffreddamento dell'olio	avec refroidissement de l'huile	mit Ölkühlung	con enfriador del aceite
with exhaust gas recirculation (EGR/AGR)	con ricircolo dei gas di scarico (EGR/AGR)	avec recyclage des gaz d'échappement (EGR/AGR)	mit Abgasrückführung (EGR/AGR)	con recirculación de los gases de escape (EGR/AGR)
with fuel oil heater	con riscaldatore nafta	avec réchauffeur gazole	mit Gasölerwärmer	con calentador de gasóleo
with water presence sensor	con sensore presenza acqua	avec capteur de présence d'eau	mit Wasserfühler	con sensor de presencia agua
with servobrake	con servofreno	avec servofrein	mit Servobremse	con servofreno
with drain	con spurgo	avec purge	mit Ablass	con purgador
short case	contenitore corto	boîtier court	kurzer Behälter	caja corta
long case	contenitore lungo	boîtier long	langer Behälter	caja larga
from engine No.	da motore N.	du moteur n°	von Motor Nr.	desde motor núm.
from series No.	da serie N.	de la série n°	von Baureihe Nr.	desde serie núm.
from frame No.	da telaio N.	du châssis n°	von Rahmen Nr.	desde bastidor núm.
excluding cold countries	escluso paesi freddi	à l'exclusion des pays froids	ausgeschlossen kalte Länder	excluido países fríos
excluding warm areas	escluso per zone calde	à l'exclusion des zones chaudes	ausgeschlossen warme Gebiete	excluido para zonas calientes
excluding dusty areas	escluso per zone polverose	à l'exclusion des zones poussiéreuses	ausgeschlossen Staubgebiete	excluido para zonas polvorientas
thread	filetto	filet	Gewinde	rosca
air filter right side	filtro aria destro	filtre à air côté droit	Luftfilter rechts	filtro de aire lado derecho
air filter left side	filtro aria sinistro	filtre à air côté gauche	Luftfilter links	filtro de aire lado izquierdo
complete filter	filtro completo	filtre complet	kompletter Filter	filtro completo
complete filter with R.H.D. and disassembly key	filtro completo con guida a destra e chiave di smontaggio	filtre complet avec conduite à droite et clé de démontage	kompletter Filter mit Rechtslenker und Löseschlüssel	filtro completo con conducción derecha y llave de desmontaje
complete filter with L.H.D. and disassembly key	filtro completo con guida a sinistra e chiave di smontaggio	filtre complet avec conduite à gauche et clé de démontage	kompletter Filter mit Linkslenker und Löseschlüssel	filtro completo con conducción izquierda y llave de desmontaje
complete filter with sensor and disassembly key	filtro completo con sensore e chiave di smontaggio	filtre complet avec capteur et clé de démontage	Komplettfilter mit Wassersensor und Löseschlüssel	filtro completo con sensor y llave de desmontaje
complete filter and disassembly key	filtro completo e chiave di smontaggio	filtre complet et clé de démontage	kompletter Filter und Löseschlüssel	filtro completo y llave de desmontaje
complete filter without sensor and disassembly key	filtro completo senza sensore e chiave di smontaggio	filtre complet sans capteur et clé de démontage	Komplettfilter ohne Wassersensor und Löseschlüssel	filtro completo sin sensor y llave de desmontaje
engine filter	filtro motore	filtre moteur	Motorfilter	filtro motor
tank filter	filtro per serbatoio	filtre pour réservoir	Filter für Behälter	filtro para depósito



EN	IT	FR	DE	ES
primary filter, foam spare part only	filtro primario, solo ricambio in spugna	filtre primaire, rechange en éponge uniquement	Hauptfilter, nur Ersatzteil aus Schaumstoff	filtro primario, sólo repuesto en espuma
secondary filter	filtro secundario	filtre secondaire	Nebenfilter	filtro secundario
metal bottoms	fondelli in metallo	fonds en métal	Deckel aus Metall	tapas metálicas
plastic bottoms	fondelli in plastica	fonds en plastique	Deckel aus Kunststoff	tapas en plástico
full-flow	full-flow	plein débit	Hauptstrom	full-flow
cartridge	immersione	immersion	Patrone	inmersión
paper	in carta	en papier	aus Papier	en papel
cloth	in panno	en tissu	aus Gewebe	en tela
injection	iniezione	injection	Einspritzung	inyección
models with metal case, foam spare part	modelli con contenitore in metallo, ricambio spugna	modèles avec corps en tôle, rechange éponge	Modelle mit Blechbehälter, Ersatzteil aus Schaumstoff	modelos con caja metálica, repuesto espuma
export models	modelli di esportazione	modèles d'exportation	Exportmodelle	modelos para exportación
models made in France	modelli prodotti in Francia	modèles produits au France	In Frankreich hergestellte Modelle	modelos fabricados en Francia
models made in Japan	modelli prodotti in Giappone	modèles produits au Japon	In Japan hergestellte Modelle	modelos fabricados en Japón
models made in India	modelli prodotti in India	modèles produits au Inde	In Indien hergestellte Modelle	modelos fabricados en la India
models made in UK	modelli prodotti in UK	modèles produits au UK	In UK hergestellte Modelle	modelos fabricados en UK
assembly	montaggio	montage	Zusammenbau	montaje
or	oppure	ou	oder	o
tropical countries	paesi tropicali	pays tropicaux	Tropische Länder	países tropicales
for cold countries	per paesi freddi	pour pays froids	für kalter Länder	para países fríos
prefilter	prefiltro	préfiltre	Vorfilter	prefiltro
without ABS	senza ABS	sans ABS	ohne ABS	sin ABS
without air-conditioner	senza climatizzatore	sans climatiseur	ohne Klimaanlage	sin climatizador
without air-conditioner with automatic gearbox	senza climatizzatore con cambio automatico	sans climatiseur avec boîte de vitesses automatique	ohne Klimaanlage mit Automatikgetriebe	sin climatizador con cambio automático
without air-conditioner with manual gearbox	senza climatizzatore con cambio manuale	sans climatiseur avec boîte de vitesses manuelle	ohne Klimaanlage mit Schaltgetriebe	sin climatizador con cambio manual
without air-conditioner and L.H.D.	senza climatizzatore e guida a sinistra	sans climatiseur et conduite à gauche	ohne Klimaanlage und Linkslenker	sin climatizador y conducción izquierda
without activated carbon air-conditioner	senza climatizzatore, ai carboni attivi	sans climatiseur, aux charbons actifs	ohne Klimaanlage mit Aktivkohlen	sin climatizador, de carbón activo
without oil radiator	senza radiatore dell'olio	sans radiateur à huile	ohne Ölkühler	sin radiador de aceite
without oil cooling	senza raffreddamento dell'olio	sans refroidissement d'huile	ohne Ölkühlung	sin enfriador de aceite
without fuel oil heater	senza riscaldatore nafta	sans réchauffeur gazole	ohne Gasölerwärmer	sin calentador de gasóleo
without water presence sensor	senza sensore presenza acqua	sans capteur de présence d'eau	ohne Wasserfühler	sin sensor de presencia agua
without bracket	senza staffa	sans collier de fixation	ohne Halterung	sin soportes
power steering	servosterzo	direction assistée	Hydrolenkung	servodirección
EFI only	solo EFI	EFI uniquement	nur EFI	sólo EFI
spare part only	solo ricambio	rechange uniquement	nur Ersatzteil	sólo repuesto
foam spare part only	solo ricambio spugna	rechange éponge uniquement	nur Schaumstoffersatzteil	sólo repuesto espuma
drive	trasmissione	transmission	Antrieb	transmisión
automatic drive	trasmissione automatica	transmission automatique	Automatikantrieb	transmisión automática
manual drive	trasmissione manuale	transmission manuelle	manueller Antrieb	transmisión manual
front drive	trazione anteriore	traction avant	Vorderradantrieb	tracción delantera
rear drive	trazione posteriore	traction arrière	Hinterradantrieb	tracción trasera
hot areas	zone calde	zones chaudes	Tropenausführung	zonas calientes
dusty areas	zone polverose	zones poussiéreuses	staubige Gebiete	zonas polvorientas
dusty areas, with activated carbons	zone polverose, ai carboni attivi	zones poussiéreuses, aux charbons actifs	staubige Gebiete, mit Aktivkohlen	zonas polvorientas, de carbón activo
dusty areas, assembly	zone polverose, montaggio	zones poussiéreuses, montage	staubige Gebiete, zusammenbau	zonas polvorientas, montaje



NEW REFERENCES

CODE CODICE / REF. ART.-NR / REFERENCIA	APPLICATIONS APPLICAZIONI / AFFECTATIONS ANWENDUNGEN / APLICACIONES	ORIGINAL REFERENCES RIFERIMENTI ORIGINALI / CORRESPONDANCES CONSTRUCTEURS VERGLEICHNUMMERN FAHRZEUGHERSTELLER / REFERENCIAS ORIGINALES
S 0VGT A	ASTRA, HEULIEZ BUS, IRISBUS, IVECO, KAROSA, RENAULT V.I.	2996238, 5001858063, 500339085, 5801543241, 5801962827, 89500339085
S 1411 GC	NISSAN, RENAULT TRUCKS	16400-LC40A, 16400-LC41A, 7485145388
S 3436 C*	MAN, MERCEDES BENZ	4157573, 9408350047, A9408350047, 7424993604
S 3437 C*	MERCEDES BENZ	K165317N50, 9738350247, A9738350247, B67582412
S 3438 C*	MERCEDES BENZ	9408350247, A9408350247, B67582415, 7424993603
S 3439 C*	MAN, MERCEDES BENZ, NEOPLAN	36.77910.0020, 81.77910.0027, 81.77910.0011, 81.77910.0012, 81.77910.0155, 83.77910.0027, 300142A
S 3440 C*	MAN, MERCEDES BENZ, NEOPLAN	K165314N50, H14-002-499, 84.77910.0002, 88.77910.0002, 0018352747, A0018352747, H14002499, 1804170086
S 3441 C*	MERCEDES BENZ	3568303118, A3568303118
S 3442 C*	MERCEDES BENZ	3568304218, A3568304218, 5021188409
S 3443 C*	MERCEDES BENZ	K129231, H14-002-484, H14-002-484-1, 0018351547, A0018351547
S 3444 C*	MAN	50313477, K129233, K129233N50, 36.77910.6005, 81.77910.0021, 0018357147, 0028351447, 0028352547, A0028351447, A0028352547, A0018357147
S 3445 C*	VOLVO	20746873, 21130158, 70326723, 85107862
S 3446 C*	NEOPLAN	210811001, N1011033282, 11033282, 180412710, 11033282
S 3447 C*	NEOPLAN	36.77910.6003, 36.77910.6007, 36.77910.6013, 83.77910.0608, 0018354947, 0018355547, A0018354947, A0018355547, 18355547, 1101194A, 1101194B, 1103462A
S 3448 C*	MAN, MERCEDES BENZ	K165305N50, 88.77910.0003, 0008307518, A0008307518
S 3449 C*	MERCEDES BENZ	0018356247, A0018356247, 1100895A, 1100895B
S 3450 C*	MERCEDES BENZ	0018356147, A0018356147, 1101120A
S 3451 C*	MERCEDES BENZ	K129232N50, 0018359147, A0018359147, 1302907A, 1302907B
S 3452 C*	SCANIA	7424993600, 1326180
S 3453 C*	MERCEDES BENZ	K165310N50, 0008309618, 9608300218, A0008309618, A9608300218
S 3454 C*	RENAULT TRUCKS	K165308, K165308N50, 7482348995, 23515118, 23515329, 82348995
S 3455 C*	RENAULT TRUCKS	K165307, 7482379897
S 3456 C*	MERCEDES BENZ	K165319N50, 6288350347, A6288350347
S 3457 C*	MAN, MERCEDES BENZ, SCANIA	0008308018, 0008308118, A0008308018, A0008308118, 11114845B, 11114854C, 11117394A, 1114854B, 22301111, 22740074, 2283473, 2283474, 36.77910.0029, 36.77910.6009, 500023843
S 3458 C*	MERCEDES BENZ	H14-004-483-1, 0008307318, A0008307318, 0000-007-636
S 3459 C*	MERCEDES BENZ	K165309, 0008309518, 9608300018, A0008309518, A9608300018
S 3460 C*	DAF	1829399, 1950785
S 3572 R	FORD OTOSAN	GC46-6744-AC, J1J6-6744-AA, T221771
S 3614 R*	KAMAZ	6W.23.614.00
S 3698 R*	HEULIEZ BUS, RENAULT TRUCKS, RENAULT V.I.	5001021176, 5010240400, 5010295195
S 3A41 A	MAN, VOLKSWAGEN	65.08405.0000, 2N0129620
S 3B55 A*	MAN	81.08405.0032
S 4059 NR	KAMAZ	6W.24.059.00
S 4064 NR	KAMAZ	6W.24.064.00
S 4069 NR*	IVECO	2997378, 42554067, 504143664, 504166113
S 4163 NR*	FORD	GC46-9176-C
S 4166 NR*	FORD	GC46-9176-AC
S 4260 CA	VOLVO	5021185583, 20409908
S 4345 CA*	MERCEDES BENZ	7424993606, 9408350147, A9408350147, B67582414

(*) in preparation, in preparazione, en préparation, in Vorbereitung, en preparacòn



CODE CODICE / REF. ART.-NR / REFERENCIA	APPLICATIONS APPLICAZIONI / AFFECTATIONS ANWENDUNGEN / APLICACIONES	ORIGINAL REFERENCES RIFERIMENTI ORIGINALI / CORRESPONDANCES CONSTRUCTEURS VERGLEICHNUMMERN FAHRZEUGHERSTELLER / REFERENCIAS ORIGINALES
S 4346 CA*	ASTRA, IVECO	2994583, 7424993607
S 4347 CA*	DAF, GINAF, TATRA	1362168, 1825431, 7424993605
S 4348 CA*	IVECO	2994769, 7424990731
S 4349 CA*	MERCEDES BENZ	K165321, 0008309718, 9608300118, A0008309718, A9608300118
S 4350 CA*	RENAULT TRUCKS	K165320, K165320N50, 7482351184, 7482499570, 23515118, 23515329, 82351184
S 4351 CA*	DAF	1953595
S 4352 CA*	DAF	1953596
S 4405 U*	ASTRA, DAF, IVECO, RENAULT TRUCKS, TATRA	V837079423, 0008821335, 378-3187, 68087337AA, K68087337AA, 11503650, 2880298, 2888182, 5303604, 1847823, 1927474, 2014774, 4602317, 02934690, 4601354, 4602317, F835201110090, V837079423, K68087337AA, S17K0-E0011, 1-87610234-0, 8-98169403-0, 5801667204, 5802310802, 58086593, P234568320, RE554498, 2934690, 4601354, 21496421, 21516231, 959987, 47364243, 20452-LC40A, 24516516, 52215-16516, 7421574991, 7485138439, 0120-302-811, 21496419, 21516229, 23381562, 2309124
S 4406 U*	CASE IH, IVECO, NEW HOLLAND, STEIGER	V837073366, 84247272, 84247272, 28802299, 4906272, 42561177, 42561177, 84247272, 7420877958, 20877958
S 4470 NR*	IRISBUS, KAROSA, POWERLINK, YINGTAI	31701062, 3355903, 939404, 1236385, 5006002224, VA32G6200100, YN02PU1004S002, 7381816, 5021192681, 5006002224
S 4471 NR*	RENAULT TRUCKS, RENAULT V.I.	503139140, SC1463776, 5010359706, 2177745/1
S 4472 NR*	KAESSBOHRER, MERCEDES BENZ	80766454, 72437086, 5717961, 0013022790, 04291642, F339202060120, F842201060010, 42549295, 500086381, 504086268, 504272431, AT365870, 10356007, 11081663, 9831699, 0004771602, A0004771602, 7424993622, 21088101
S 4473 NR*	MAN	01182242, 1000279420, 51.12503.0059, 51.12503.0060, 51.12503.0099
S 4474 NR*	ASTRA, IVECO	5801620130
S 4475 NR*	RENAULT TRUCKS	5001858091, 5001846015
S 4476 NR*	VOLVO TRUCKS	20782330, 21005832, 21380490
S 4477 NR*	RENAULT TRUCKS, VOLVO	21764966, 21764968, 7421764968, 7421764981
S 4478 NR*	DAF	72515622, J329289, 256-8753, 3329289, 3329289, 47400033, 4136470, 9414101307, 4377880, 43778801, E12977622, L4377880, 11NB70010, RE160384, 1310368H2, BF2486, CUFS1000, 5614398, 9830513, 4136090, 4136330, 57536400006, X57536400006, 7424993629, 330560688, 1273400211, 1273400212, 1273400213, 15271319, 86029143
S 4479 NR*	MERCEDES BENZ, RENAULT TRUCKS, SCANIA	K117927N50, 3905873M91, 0004771702, A0004771702, 90.A03.98, 7420754418, 7421380500, 7424993623, 1780730, 20754418, 21380500
S 4480 NR*	HEULIEZ BUS, IVECO	0021703110, 504292579, 5801729418, 13780-52R40
S 5169 PE	ASTRA, IVECO	5802108699, 12838655
S 5234 PE*	BOVA (VDL BOVA), DAF, GINAF, JONCKHEERE (VDL GROUP), SOLARIS, TEMSA, VAN HOOL, VDL BUS & COACH	1397765, 5021185681, 170445000
S 5235 PE*	MAN, NEOPLAN	51.05501.0009, 51.05501.0013, 51.05504.0013, 51.05504.0115, 51.05504.0126
S 5236 PE*	MERCEDES BENZ	0019965630, 0019965631, 10731569, 6052241, 9361800009, 9361840225, A9361800009, A9361840225
S 5237 PE*	MERCEDES BENZ	0007731870, A4701800009, A4701800109
S 5238 PE*	VOLVO	20779040, 22038968, 7420779040, 7421990552, 7422051238
S 5239 PE*	MAN	ACP0287860, 51.05501.0011, 51.05504.0118
S 5240 PE*	DAF, TATRA	1928868, 2129253
S 5663 PO*	IRISBUS, KAESSBOHRER, MAN, MERCEDES BENZ, NEOPLAN, SOLBUS, VOLVO	3095859, 42544766, 832-199-83-950, 832-199-84-510, 832-199-97-290, 81.33118.6004, 81.33901.6046, 0002701198, 0002701698, 0002702398, A0002701198, A0002701698, A0002702398, 5001855259, 59.3355.10, 91.3301.10, 91.3301.11

(*) in preparation, in preparazione, en préparation, in Vorbereitung, en preparacón



NEW REFERENCES

CODE CODICE / REF. ART.-NR / REFERENCIA	APPLICATIONS APPLICAZIONI / AFFECTATIONS ANWENDUNGEN / APLICACIONES	ORIGINAL REFERENCES RIFERIMENTI ORIGINALI / CORRESPONDANCES CONSTRUCTEURS VERGLEICHNUMMERN FAHRZEUGHERSTELLER / REFERENCIAS ORIGINALES
S 5664 PO*	DAF, IVECO, MAN, RENAULT TRUCKS, TATRA	1855687, 2027058, 42568992, 81.47307.0009, 0004604283, 0004662904, A0004604283, A0004662904, 5021185611, 7421519716, 7420580233, 20580233, 21519716, 763160114534, 763160114534-01, 7632141110
S 5903 PO*	IRISBUS, RENAULT TRUCKS, SISU AUTO	5001021174, 236-GB-245M, 5001858001, 5010437143
S 5904 PO*	BOVA (VDL BOVA), JONCKHEERE (VDL GROUP), TATRA, VAN HOOL	1643072, 1872106, 7424993655
S 5905 PO*	DAF, TATRA	1928869, 120302573
S 6024 NE*	BOVA (VDL BOVA), DAF, GINAF, JONCKHEERE (VDL GROUP), SOLARIS, TATRA, TEMSA, VAN HOOL, VDL BUS & COACH	1616361, 1643080, 1699168
S 6146 NE*	BOVA (VDL BOVA), DAF, GINAF, JONCKHEERE (VDL GROUP), SOLARIS, VAN HOOL, VDL BUS & COACH	1450184, 1811391
S 6147 NE*	IRIZAR, SCANIA	1736248, 1736250, 1736251, 1794863, 1865227, 1920628, 2003505, 2022753, 2022754
S 6148 NE*	MERCEDES BENZ	000773186.0, K165036N50, 10873023, 53006464, A9360900351, A9360903855
S 6149 NE*	MITSUBISHI-FUSO	ME195160, ME222133, ME222135, 16403-WK900
S 6150 NE*	MAN	51.12503.0086
S 7342 A	RENAULT TRUCKS, RENAULT V.I.	5010064372, 5010094145
S 7343 A	HEULIEZ BUS, RENAULT TRUCKS, RENAULT V.I.	7411394, 5001020327, 5010064371, 5010094154, 5010305203
S 7368 A	RENAULT TRUCKS, RENAULT V.I.	1930788, AZ39761, 7615043, CV9686, 5000953712, CV9686, 68560449
S 7372 A	RENAULT TRUCKS	5000751674, 5010094146
S 7405 A	MAN	81.08304.0084
S 7428 A	BOVA (VDL BOVA), DAF	0754718, 1314531, 1318919, 754718
S 7431 A	KAESSBOHRER, MAN	831-914-91-90, 831-914-91-900, 81.08304.0072, 83.08405.0000
S 7432 A*	MAN	81.08304.0069, 81.08304.0073
S 7474 A*	MERCEDES BENZ	0030941604, A0030941604
S 7479 A*	DAF	K306535, MAK1629
S 7482 A*	IVECO, MAN	81.08304.0079, 81.08304.0095
S 7484 A	VOLVO	21041296, 3979928
S 7564 A	ASTRA, VAN HOOL, VOLVO CONSTRUCTION EQUIPMENT	10044851, 10582248, 11033998, 11033998-3, 11064358, 128075, 15272252, 84069017
S 7565 A	ASTRA, VOLVO CONSTRUCTION EQUIPMENT	128076, 10044849, 15272253, 11033999, 110339991, 84069018
S 7A01 A	IVECO, NEW HOLLAND, STEIGER	483-3089, 5801470547, 5801856860, 5801896633
S 7B36 A	SCANIA	1869993, 1869995
S 7B39 A	RENAULT TRUCKS, VOLVO	7421337443, 7421337557, 21337443, 21337557
S 7B45 A*	DAF	1638054, 1931680, 1931684
S 7B80 A	KING LONG	1109100C9F0, 1109ZB1-020
S 7B81 A	KING LONG	1109100C9F0, 1109ZB1-030
S 7C13 A	SCANIA	1869992, 1869994
S 7C16 A	IVECO	5801400571
S 7D41 A	SCANIA	1335681, 1869991
S 7E35 A	MAN	81.08405.0033
S 7F13 A*	MERCEDES BENZ	0040947404, A0040947404
S 7F14 A*	BOVA (VDL BOVA), DAF, TATRA, VAN HOOL	1527755, 1681575, 1821580, 1891431, K015857, K039455, 4329012462

(*) in preparation, in preparazione, en préparation, in Vorbereitung, en preparacòn



CODE CODICE / REF. ART.-NR / REFERENCIA	APPLICATIONS APPLICAZIONI / AFFECTATIONS ANWENDUNGEN / APLICACIONES	ORIGINAL REFERENCES RIFERIMENTI ORIGINALI / CORRESPONDANCES CONSTRUCTEURS VERGLEICHNUMMERN FAHRZEUGHERSTELLER / REFERENCIAS ORIGINALES
S 7F15 A*	DAF	1433690, 1644642, 1667999, 1672463, APUC43, 7424992237
S 7F16 A*	KING LONG, MAN	81.08405.0022, 7424993633
S 7F17 A*	MAN	81.08405.0023, 4522232, 5021192696
S 7F18 A*	VOLVO	20411815, 20882320, 21716424
S 7F19 A*	VOLVO	20411816
S 7F20 A*	MERCEDES BENZ	0040947204, A0040947204
S 7F21 A*	MERCEDES BENZ	0040946804, A0040946804
S 7F22 A*	MERCEDES BENZ	0040946904, A0040946904
S 7F23 A*	RENAULT TRUCKS, VOLVO	1527760, K005686, K014712, K039453, K039453X00, K137956K50, K137956X50, 5001865404, 7421267793, 7421602383, 7485135854, 20754416, 21267818, 21602385, 21602385-LH, 22937189, 4329012452
S 7F24 A*	MERCEDES BENZ, RENAULT TRUCKS	1527758, I138789F, I138789F/004, 81.52102.0016, 0004292497, 0004293995, 0004294895, 0004295495, 000429549528, A0004293995, A0004294895, A0004295495, A000429549528, 5000295422, 4324102202
S 7F25 A*	MAN	K165284, 81.08405.0031, 0499-000-469
S 7F26 A*	SCANIA	2343432
S 7F27 A*	MAN	81.08405.0037
S 7F28 A*	MAN	81.08401.0036, 81.08405.0036
S 7F29 A*	MAN	81.08405.0038
S 7F30 A*	SCANIA	K087957, K115979X00, 1774598, 2081360, 2307617, 2484686, 2562323
S 7F31 A*	KAESSBOHRER, MERCEDES BENZ	0040944604, A0040944604
S 8137 RH*	HEULIEZ BUS, IRISBUS, IVECO, RENAULT V.I.	5006143641, 5010197265, 5010197266, 7425986969
S 9007 AR*	SCANIA	342988, 378396



REPLACED REFERENCES

OLD
VECCHIO / ANCIEN
ALT / ANTIGUA

NEW
NUOVO / NOUVEAU
NEU / NUEVA

S 0003 DR		S 3003 DR
S 0110 NR		S 8501 NR
S 0800 R		S 9710 R
S 0920 R		S 5124 PE
S 0938 A		S 0946 A
S 1003 DR		S 5003 DR
S 1079 PE		S 5112 PE
S 1437 NR		S 4437 NR
S 1480 A		S 3066 A
S 1500 B	(solo / only / seulement / nur MERCEDES BENZ)	S 1583 B
S 1501 B	(solo / only / seulement / nur ALFA ROMEO, BMW, CITROËN)	S 1510 B
S 1501 B	(solo / only / seulement / nur BEDFORD, OPEL, VAUXHALL)	S 1611 B
S 1504 B	(solo / only / seulement / nur BOSCH 0 450 905 005)	S 1511 B
S 1504 B	(solo / only / seulement / nur BOSCH 0 450 905 021)	S 1699 B
S 1510 B	(solo / only / seulement / nur AC DELCO GF 516, GF 635)	S 1611 B
S 1560 R	(solo / only / seulement / nur VAG GROUP)	S 1563 R
S 1561 R		S 0420 R
S 1584 B		S 1500 B
S 1600 R	(solo / only / seulement / nur SCANIA)	S 2329 R
S 1600 R	(solo / only / seulement / nur SKODA)	S 3285 R
S 1600 R	(solo / only / seulement / nur VOLVO)	S 3257 R
S 1620 R		S 1621 R
S 1622 B		S 1666 B
S 1819 B		S 1832 B
S 1820 B		S 1833 B
S 1857 B		S 4857 B
S 1880 R	(solo / only / seulement / nur AUSTIN, ROVER)	S 8540 R
S 1926 B		S 9261 B
S 2030 A		S 3066 A
S 2326 R		S 5030 R
S 2340 R		S 3458 R
S 2400 R	(escluso / except / sauf / ausser CITROËN, FIAT, PEUGEOT)	S 4900 R
S 2530 R	(solo / only / seulement / nur ALFA ROMEO)	S 9150 R
S 3002 A		S 3017 A
S 3008 C		S 3007 C
S 3018 A		S 3017 A
S 3029 C		S 4105 CA
S 3031 A		S 6640 A
S 3036 C		S 3084 C
S 3037 A		S 6720 A
S 3042 A		S 3041 A
S 3043 A		S 3041 A
S 3065 A		S 3066 A
S 3080 PO		S 3081 PO
S 3084 A		S 3007 A
S 3097 C		S 3218 C
S 3181 R	(solo / only / seulement / nur LAND ROVER)	S 3297 R
S 3191 A		S 3265 A

(*) in preparation, in preparazione, en préparation, in Vorbereitung, en preparacòn



OLD
VECCHIO / ANCIEN
ALT / ANTIGUA

NEW
NUOVO / NOUVEAU
NEU / NUEVA

S 3201 R		S 3298 R
S 3210 NR		S 0999 NR
S 3277 R		S 0320 R
S 3282 A		S 3462 A / S 3463 A
S 3283 R		S 0320 R
S 3285 R		S 3435 R
S 3291 A		S 3322 A
S 3402 A		S 1212 A
S 3405 R		S 3293 R
S 3431 R		S 2210 R
S 3440 R	(solo / only / seulement / nur VOLVO)	S 3279 R
S 3478 A		S 3477 A
S 3570 NR		S 0300 NR
S 3630 PO		S 5124 PE
S 3631 PO		S 5132 PE
S 3860 A		S 5002 A
S 3956 A		S 3955 A
S 3998 A		S 6930 A
S 4003 DR		S 3003 DR
S 4008 NR		S 1008 NR
S 4061 NR		S 1061 NR
S 4108 NR		S 4113 NR
S 4240 R	(solo / only / seulement / nur HYUNDAI)	S 6901 R
S 4377 NR		S 4378 NR
S 4381 NR	(solo / only / seulement / nur VOLVO)	S 4379 NR
S 4448 NR		S 4432 NR
S 4600 R	(solo / only / seulement / nur SKODA)	S 3285 R
S 4802 A		S 3417 A
S 5025 PE		S 5067 PE
S 5055 PE		S 5093 PE
S 5057 PE		S 5060 PE
S 5156 GC		S 5175 GC
S 5381 PO		S 5131 PE
S 5417 GC		S 5430 GC
S 5538 PO		S 5099 PE
S 5549 PO		S 5133 PE
S 5583 PO		S 5095 PE
S 5700 R	(solo / only / seulement / nur SKODA)	S 3285 R
S 5800 R	(solo / only / seulement / nur DAF, IVECO, KHD)	S 5802 R
S 6002 NE		S 6014 NE
S 6046 NE		S 6052 NE
S 6049 NE		S 6065 NE
S 6741 A		S 6740 A
S 6900 R	(escluso / except / sauf / ausser OPEL, VAUXHALL)	S 6901 R
S 7150 R		S 6210 R
S 7191 A		S 9630 A
S 7212 A		S 7544 A
S 7264 A		S 0VGT A



REPLACED REFERENCES

OLD
VECCHIO / ANCIEN
ALT / ANTIGUA

NEW
NUOVO / NOUVEAU
NEU / NUEVA

S 7389 A		S 7626 A
S 7391 A		S 7563 A
S 7392 A		S 7625 A
S 7398 A		S 7627 A
S 7610 R		S 3297 R
S 8280 PO		S 5162 PE
S 8500 NR	(solo / only / seulement / nur BEDFORD, OPEL, VAUXHALL)	S 8501 NR
S 8500 NR	(solo / only / seulement / nur MAN)	S 4378 NR
S 8540 R	(solo / only / seulement / nur SAAB)	S 3298 R
S 8580 A		S 9360 A
S 8800 R		S 0230 R
S 8910 A		S 5810 A
S 9000 B	(solo / only / seulement / nur VAG GROUP)	S 1012 B
S 9330 R		S 3280 R

NOTES



A large grid of small dots for taking notes, covering the majority of the page.



NOTES

A large grid of small dots for taking notes, covering the majority of the page.

NOTES



A large grid of small dots for taking notes.



NOTES

A large grid of small dots for taking notes, covering the majority of the page.

NOTES



A large grid of small dots for taking notes.



NOTES

A large grid of small dots for taking notes, covering the majority of the page.

INDEX > INDICE > INHALTSVERZEICHNIS

A

ASTRA.....	1 - 15
ATKINSON.....	15 - 17
AUWAERTER.....	17 - 18
AVELING BARFORD.....	18 - 21
AVIA.....	21 - 27
AWD.....	27
AYATS.....	27

B

BEDFORD.....	28 - 34
BELL EQUIPMENT.....	34
BERKHOF (VDL).....	35
BMC.....	35 - 36
BOVA (VDL BOVA).....	36 - 42
BREDA-MENARINI.....	42
BREMACH.....	42 - 43
BUESSING.....	43 - 52

C

CACCIAMALI.....	52
CARRIER.....	52 - 54
CATERPILLAR.....	54 - 56

D

DAF.....	56 - 75
DENNIS.....	75
DENNIS EAGLE.....	75
DRESSER HAULPAK.....	75
DROEGMOELLER.....	75 - 76

E

E.R.F.....	76 - 77
EUCLID.....	77 - 79

F

FAUN.....	79 - 82
FODEN.....	82 - 86
FORD.....	86 - 88
FORD OTOSAN.....	88
FREIGHTLINER.....	88

G

GINAF.....	88 - 96
GUY.....	96 - 97

H

HAULAMATIC.....	97
HEATHFIELD.....	98 - 99
HEULIEZ BUS.....	99 - 100

I

IFA.....	101
IKARUS.....	101
INBUS.....	101 - 102
IRISBUS.....	102 - 119
IRIZAR.....	119 - 122

INDEX > INDICE > INHALTSVERZEICHNIS

ISUZU.....	122
IVECO.....	123 -212

J

JONCKHEERE (VDL GROUP).....	212 -213
-----------------------------	----------

K

KAELBLE.....	213 -216
KAESSBOHRER.....	216 -230
KAMAZ.....	230 -235
KAROSA.....	235
KARSAN.....	235
KING LONG.....	235 -237
KOCKUM.....	237 -238
KOMATSU.....	238

L

LEYLAND.....	238 -241
LIEBHERR.....	241

M

MACK.....	242
MAN.....	242 -355
MENARINI.....	355
MERCEDES BENZ.....	355 -481
MERCEDES BENZ UNIMOG.....	481 -489
MITSUBISHI-FUSO.....	489 -490
MOXY.....	490 -491
MULTICAR.....	491

N

NAVISTAR.....	491
NEOPLAN.....	491 -500
NISSAN.....	500 -502

O

OPTARE GROUP.....	502 -503
-------------------	----------

P

PADANE.....	503 -504
PEGASO.....	504 -521
PERLINI.....	521
PETTER.....	522
PLAXTON.....	522

R

RENAULT TRUCKS.....	522 -563
RENAULT TRUCKS (E).....	563 -564
RENAULT V.I.....	564 -570
RENAULT V.I. (E).....	570

S

SCANIA.....	570 -614
SEDDON ATKINSON.....	614 -619
SISU AUTO.....	619 -621
SOLARIS.....	621 -623
SOLBUS.....	623 -624

INDEX > INDICE > INHALTSVERZEICHNIS

STEYR / DAIMLER / PUCH..... 624 -627

T

TALBOT (E)..... 627 -631
TATRA..... 632 -633
TEMSA..... 633 -635
TEREX..... 635 -637
THERMO KING..... 637 -638

U

UMBRAMECCANICA..... 638

V

VAN HOOL..... 638 -643
VDL BUS & COACH..... 643
VISEON BUS..... 643 -644
VOLKSWAGEN..... 644
VOLVO..... 644 -680
VOLVO CONSTRUCTION EQUIPMENT..... 680 -683

Z

ZASTAVA (YUGO)..... 683 -684
ZETTELMEYER..... 684
ZF..... 684

Applications - Applicazioni
Affectations - Anwendungen
Aplicaciones..... 685 -690

Cross references - Corrispondenze
Correspondances - Vergleichsnummern
Cruce de referencias..... 691 -720

Sizes - Dimensionario - Dimensions
Abmessungen - Dimensiones..... 721 -736

S 0012 O	S 0230 R	KAELBLE KAESSBOHRER KAROSA MAN RENAULT TRUCKS STEYR / DAIMLER / PUCH ZETTELMEYER	AWD BEDFORD CARRIER CATERPILLAR FODEN FORD HAULAMATIC LEYLAND THERMO KING VOLVO CONSTRUCTION EQUIPMENT	IRISBUS IVECO KAROSA RENAULT V.I.	S 1410 NR	S 1999 NR	MERCEDES BENZ NEOPLAN OPTARE GROUP PADANE RENAULT TRUCKS RENAULT V.I. SCANIA SISU AUTO SOLARIS VOLVO VOLVO CONSTRUCTION EQUIPMENT ZF
THERMO KING	ASTRA INBUS IVECO PADANE PERLINI VAN HOOL ZASTAVA (YUGO)	S 0550 A	S 0840 A	S 1005 A	NISSAN	ASTRA HEULIEZ BUS IRISBUS IVECO	RENAULT TRUCKS RENAULT V.I. SCANIA SISU AUTO SOLARIS VOLVO VOLVO CONSTRUCTION EQUIPMENT ZF
S 0050 A	S 0270 A	AUWAERTER DAF IVECO RENAULT V.I. SCANIA VOLVO CONSTRUCTION EQUIPMENT	S 0850 A	S 1013 B	S 1411 GC	S 1H20 NR	S 2320 NR
SCANIA	IVECO	S 0580 PO	CARRIER RENAULT TRUCKS RENAULT V.I.	BEDFORD	NISSAN RENAULT TRUCKS	IRISBUS IVECO KARSAN	MERCEDES BENZ OPTARE GROUP
S 0060 A	S 0280 PO	S 0610 NR	S 0900 R	S 1028 B	S 1411 N	S 2003 DR	S 2329 R
FODEN HEATHFIELD IVECO KAESSBOHRER RENAULT TRUCKS SEDDON ATKINSON TATRA	AVELING BARFORD LEYLAND PETTER	IVECO VOLVO CONSTRUCTION EQUIPMENT	LEYLAND RENAULT TRUCKS SEDDON ATKINSON	BREMACH IVECO	AUWAERTER BUESSING DROEGMOELLER FAUN IFA IKARUS IVECO KAELBLE KAESSBOHRER KOCKUM MAN NEOPLAN RENAULT TRUCKS SCANIA STEYR / DAIMLER / PUCH TATRA THERMO KING VAN HOOL VOLVO VOLVO CONSTRUCTION EQUIPMENT	ASTRA IVECO	KAESSBOHRER KOCKUM MOXY PERLINI SCANIA VOLVO CONSTRUCTION EQUIPMENT
S 0070 A	S 0300 O	S 0620 R	S 0950 A	S 1050 A	S 1450 A	S 2030 R	S 2370 A
HEULIEZ BUS VOLVO	ASTRA CARRIER DROEGMOELLER FAUN KAELBLE MERCEDES BENZ STEYR / DAIMLER / PUCH THERMO KING	AVIA BMC BREDI-MENARINI DAF GINAF HEULIEZ BUS IRISBUS IVECO KAMAZ KING LONG NISSAN OPTARE GROUP SOLBUS	AWD CATERPILLAR FODEN HEULIEZ BUS IKARUS IRISBUS IVECO MACK PADANE RENAULT TRUCKS RENAULT TRUCKS (E) RENAULT V.I. SEDDON ATKINSON SISU AUTO VOLVO VOLVO CONSTRUCTION EQUIPMENT	AUWAERTER DROEGMOELLER KAESSBOHRER KAMAZ KAROSA MAN NEOPLAN PEGASO PERLINI SOLARIS STEYR / DAIMLER / PUCH TATRA TEMSA	AUWAERTER DAF IVECO KAELBLE MERCEDES BENZ MERCEDES BENZ UNIMOG RENAULT V.I. STEYR / DAIMLER / PUCH VOLVO CONSTRUCTION EQUIPMENT	PETTER	ASTRA BEDFORD INBUS SEDDON ATKINSON
S 0101 N	S 0310 NR	S 0650 A	S 0920 R	S 1070 A	S 1506 A	S 2070 A	S 2450 A
IKARUS IVECO KAELBLE KAESSBOHRER MAN RENAULT TRUCKS STEYR / DAIMLER / PUCH VAN HOOL VOLVO	SCANIA	AVIA NISSAN	BREMACH IVECO MULTICAR OPTARE GROUP	MERCEDES BENZ MERCEDES BENZ UNIMOG	AUWAERTER DAF IVECO KAELBLE MERCEDES BENZ MERCEDES BENZ UNIMOG RENAULT V.I. STEYR / DAIMLER / PUCH VOLVO CONSTRUCTION EQUIPMENT	VOLVO	AUWAERTER AVIA DAF FAUN IVECO KAELBLE KAESSBOHRER MAN MERCEDES BENZ MERCEDES BENZ UNIMOG NISSAN PEGASO RENAULT TRUCKS RENAULT TRUCKS (E) RENAULT V.I. SCANIA STEYR / DAIMLER / PUCH TALBOT (E) VOLKSWAGEN VOLVO VOLVO CONSTRUCTION EQUIPMENT
S 0120 R	S 0420 R	S 0660 A	S 0940 A	S 1071 B	S 1506 A	S 2161 N	S 2370 A
IVECO	AVELING BARFORD AVIA CARRIER FODEN GUY HAULAMATIC HEATHFIELD LEYLAND NISSAN PEGASO RENAULT TRUCKS SEDDON ATKINSON VOLVO VOLVO CONSTRUCTION EQUIPMENT	ATKINSON	ATKINSON AVELING BARFORD FAUN FODEN IVECO KAELBLE KAESSBOHRER KOCKUM LEYLAND	BREMACH IVECO MULTICAR	AUWAERTER DAF IVECO KAELBLE MERCEDES BENZ MERCEDES BENZ UNIMOG RENAULT V.I. STEYR / DAIMLER / PUCH VOLVO CONSTRUCTION EQUIPMENT	ASTRA AUWAERTER DROEGMOELLER KAESSBOHRER MERCEDES BENZ MERCEDES BENZ UNIMOG NEOPLAN	ASTRA BEDFORD INBUS SEDDON ATKINSON
S 0122 O	S 0450 A	S 0710 NR	S 0950 A	S 1080 PO	S 1563 R	S 2162 N	S 2450 A
MERCEDES BENZ	AUWAERTER DAF DROEGMOELLER HEULIEZ BUS IVECO KAELBLE KAESSBOHRER MAN MERCEDES BENZ MERCEDES BENZ UNIMOG NEOPLAN PEGASO RENAULT TRUCKS RENAULT TRUCKS (E) RENAULT V.I. SCANIA STEYR / DAIMLER / PUCH THERMO KING VAN HOOL ZASTAVA (YUGO)	IVECO VAN HOOL	AVIA DAF IVECO MAN MERCEDES BENZ UNIMOG NISSAN PEGASO RENAULT TRUCKS STEYR / DAIMLER / PUCH VOLKSWAGEN	AVELING BARFORD VOLVO	BREMACH UMBRAMECCANICA	ASTRA BOVA (VDL BOVA) DROEGMOELLER KAELBLE KAESSBOHRER MAN MERCEDES BENZ NEOPLAN PADANE ZETTELMEYER	AUWAERTER AVIA DAF FAUN IVECO KAELBLE KAESSBOHRER MAN MERCEDES BENZ MERCEDES BENZ UNIMOG NISSAN PEGASO RENAULT TRUCKS RENAULT TRUCKS (E) RENAULT V.I. SCANIA STEYR / DAIMLER / PUCH TALBOT (E) VOLKSWAGEN VOLVO VOLVO CONSTRUCTION EQUIPMENT
S 0130 R	S 0710 NR	S 0760 A	S 0999 NR	S 1200 R	S 1600 R	S 2163 N	S 2460 A
DAF	ASTRA INBUS IVECO PADANE PERLINI VAN HOOL ZASTAVA (YUGO)	IRISBUS IVECO RENAULT TRUCKS SISU AUTO	AWD CATERPILLAR FODEN FORD HAULAMATIC HEATHFIELD IKARUS INBUS IVECO LEYLAND MOXY RENAULT TRUCKS RENAULT V.I. SEDDON ATKINSON VAN HOOL	AVELING BARFORD VOLVO	RENAULT TRUCKS	ASTRA IVECO	FORD
S 0150 A	S 0768 A	S 0810 NR	S 0950 A	S 1220 R	S 1670 A	S 2220 NR	S 2510 O
ASTRA ATKINSON BEDFORD FODEN FORD GUY HAULAMATIC HEATHFIELD IKARUS INBUS IVECO LEYLAND MOXY RENAULT TRUCKS RENAULT V.I. SEDDON ATKINSON VAN HOOL	BOVA (VDL BOVA) DAF JONCKHEERE (VDL GROUP) VAN HOOL	IVECO	AVIA DAF IVECO MAN MERCEDES BENZ UNIMOG NISSAN PEGASO RENAULT TRUCKS STEYR / DAIMLER / PUCH VOLKSWAGEN	PEGASO RENAULT TRUCKS (E) RENAULT V.I. (E) SEDDON ATKINSON TALBOT (E)	BREMACH RENAULT TRUCKS	AVIA BERKHOF (VDL) BMC DAF DENNIS GINAF HEULIEZ BUS IRISBUS IVECO KAMAZ KING LONG NISSAN OPTARE GROUP SOLARIS SOLBUS VAN HOOL VDL BUS & COACH	MERCEDES BENZ MERCEDES BENZ UNIMOG
S 0201 N	S 0770 R	S 0810 NR	S 0950 A	S 1270 R	S 1910 PO	S 2234 Z	S 2530 PO
AUWAERTER BUESSING FAUN IKARUS IVECO KAELBLE KAESSBOHRER KOCKUM RENAULT TRUCKS SCANIA STEYR / DAIMLER / PUCH THERMO KING VAN HOOL VOLVO VOLVO CONSTRUCTION EQUIPMENT	ASTRA INBUS IVECO PADANE PERLINI VAN HOOL ZASTAVA (YUGO)	BOVA (VDL BOVA) DAF JONCKHEERE (VDL GROUP) VAN HOOL	AVIA DAF IVECO MAN MERCEDES BENZ UNIMOG NISSAN PEGASO RENAULT TRUCKS STEYR / DAIMLER / PUCH VOLKSWAGEN	FORD PETTER	BUESSING CATERPILLAR DAF DRESSER HAULPAK IKARUS RENAULT TRUCKS RENAULT V.I.	BELL EQUIPMENT BMC BOVA (VDL BOVA) DAF GINAF HEULIEZ BUS IRISBUS IRIZAR IVECO KAESSBOHRER MAN	AUWAERTER DROEGMOELLER KAELBLE KAESSBOHRER MAN MERCEDES BENZ MERCEDES BENZ UNIMOG NEOPLAN RENAULT TRUCKS STEYR / DAIMLER / PUCH
S 0210 R	S 0770 R	S 0810 NR	S 0950 A	S 1307 A	S 1940 A	S 1970 A	S 2570 A
IVECO	ASTRA INBUS IVECO PADANE PERLINI VAN HOOL ZASTAVA (YUGO)	BOVA (VDL BOVA) DAF JONCKHEERE (VDL GROUP) VAN HOOL	AVIA DAF IVECO MAN MERCEDES BENZ UNIMOG NISSAN PEGASO RENAULT TRUCKS STEYR / DAIMLER / PUCH VOLKSWAGEN	IVECO MAN MERCEDES BENZ NEOPLAN PEGASO PERLINI STEYR / DAIMLER / PUCH	IVECO MERCEDES BENZ UNIMOG STEYR / DAIMLER / PUCH	MAN	FORD IVECO LEYLAND VOLVO CONSTRUCTION EQUIPMENT
S 0220 O	S 0770 R	S 0810 NR	S 0950 A	S 1307 A	S 1940 A	S 1970 A	S 2570 A
MERCEDES BENZ	ASTRA INBUS IVECO PADANE PERLINI VAN HOOL ZASTAVA (YUGO)	BOVA (VDL BOVA) DAF JONCKHEERE (VDL GROUP) VAN HOOL	AVIA DAF IVECO MAN MERCEDES BENZ UNIMOG NISSAN PEGASO RENAULT TRUCKS STEYR / DAIMLER / PUCH VOLKSWAGEN	IVECO MAN MERCEDES BENZ NEOPLAN PEGASO PERLINI STEYR / DAIMLER / PUCH	IVECO MERCEDES BENZ UNIMOG STEYR / DAIMLER / PUCH	MAN	FORD IVECO LEYLAND VOLVO CONSTRUCTION EQUIPMENT
S 0230 R	S 0770 R	S 0810 NR	S 0950 A	S 1307 A	S 1940 A	S 1970 A	S 2570 A
ASTRA INBUS IVECO PADANE PERLINI VAN HOOL ZASTAVA (YUGO)	ASTRA INBUS IVECO PADANE PERLINI VAN HOOL ZASTAVA (YUGO)	BOVA (VDL BOVA) DAF JONCKHEERE (VDL GROUP) VAN HOOL	AVIA DAF IVECO MAN MERCEDES BENZ UNIMOG NISSAN PEGASO RENAULT TRUCKS STEYR / DAIMLER / PUCH VOLKSWAGEN	IVECO MAN MERCEDES BENZ NEOPLAN PEGASO PERLINI STEYR / DAIMLER / PUCH	IVECO MERCEDES BENZ UNIMOG STEYR / DAIMLER / PUCH	MAN	FORD IVECO LEYLAND VOLVO CONSTRUCTION EQUIPMENT

S 2610 NR...
... S 4157 NR

S 2610 NR MERCEDES BENZ	S 3030 A MERCEDES BENZ	HEULIEZ BUS INBUS IRISBUS IRIZAR IVECO	SISU AUTO S 3241 R	FAUN HAULAMATIC HEATHFIELD KOCKUM PERLINI RENAULT V.I. TEREX VOLVO VOLVO CONSTRUCTION EQUIPMENT	S 3444 C IVECO MAN MERCEDES BENZ SOLARIS VISEON BUS	S 3497 R DAF KAMAZ	S 4089 NR DAF
S 2650 A AUWAERTER DAF IFA IVECO KAELBLE KAESSBOHRER KAMAZ MAN MERCEDES BENZ MERCEDES BENZ UNIMOG NEOPLAN NISSAN PEGASO RENAULT TRUCKS RENAULT TRUCKS (E) RENAULT V.I. RENAULT V.I. (E) SCANIA STEYR / DAIMLER / PUCH TALBOT (E) TEMSA VOLVO CONSTRUCTION EQUIPMENT	S 3048 C MAN STEYR / DAIMLER / PUCH S 3051 A VOLVO VOLVO CONSTRUCTION EQUIPMENT S 3053 C MAN S 3054 C MERCEDES BENZ S 3055 C IVECO S 3056 C MERCEDES BENZ S 3059 A MERCEDES BENZ OPTARE GROUP S 3059 C MERCEDES BENZ S 3062 C DAF S 3066 C SCANIA S 3072 C MERCEDES BENZ SISU AUTO S 3078 C ASTRA IVECO S 3080 A MERCEDES BENZ S 3081 C HEULIEZ BUS IRISBUS IVECO KAESSBOHRER KAROSA KING LONG MAN MERCEDES BENZ NEOPLAN RENAULT V.I. SCANIA VOLVO S 3081 PO ASTRA AYATS BERKHOF (VDL) BMC BOVA (VDL BOVA) BREDA-MENARINI DAF E.R.F. GINAF	JONCKHEERE (VDL GROUP) KAESSBOHRER KAMAZ KAROSA KING LONG MAN MERCEDES BENZ MERCEDES BENZ UNIMOG MOXY NEOPLAN OPTARE GROUP PLAXTON RENAULT TRUCKS RENAULT V.I. SCANIA SISU AUTO SOLARIS SOLBUS STEYR / DAIMLER / PUCH TATRA TEMSA THERMO KING VAN HOOL VDL BUS & COACH VISEON BUS VOLKSWAGEN VOLVO VOLVO CONSTRUCTION EQUIPMENT S 3082 A MERCEDES BENZ S 3089 C VOLVO S 3092 C DAF S 3102 R NISSAN S 3106 R RENAULT V.I. S 3137 C MERCEDES BENZ S 3139 C DAF GINAF TATRA S 3161 C IVECO S 3165 C MAN NEOPLAN S 3180 PO AVELING BARFORD AVIA SEDDON ATKINSON S 3217 C DAF RENAULT TRUCKS SISU AUTO S 3221 C MERCEDES BENZ	S 3257 R HEULIEZ BUS VOLVO S 3260 R ASTRA IVECO S 3275 R BOVA (VDL BOVA) DAF LEYLAND S 3279 C KAESSBOHRER KING LONG MAN MERCEDES BENZ NEOPLAN VISEON BUS S 3280 R UMBRAMECCANICA S 3283 C IRISBUS KAESSBOHRER MAN MERCEDES BENZ NEOPLAN SCANIA SOLBUS TEMSA VAN HOOL VISEON BUS S 3288 R ASTRA HEULIEZ BUS IRISBUS IVECO KAROSA RENAULT V.I. S 3289 C SCANIA S 3292 R E.R.F. MAN NEOPLAN PEGASO SOLARIS STEYR / DAIMLER / PUCH TEMSA VAN HOOL VISEON BUS VOLKSWAGEN S 3300 PO IVECO S 3301 PO ASTRA AVELING BARFORD BEDFORD DRESSER HAULPAK EUCLID	S 3315 C IVECO S 3330 A UMBRAMECCANICA S 3340 A MERCEDES BENZ OPTARE GROUP S 3373 A MERCEDES BENZ S 3408 R BOVA (VDL BOVA) DAF LEYLAND SOLARIS S 3409 R AVELING BARFORD DRESSER HAULPAK EUCLID FODEN FORD KOMATSU PERLINI SEDDON ATKINSON VOLVO CONSTRUCTION EQUIPMENT S 3425 R MULTICAR S 3436 C MAN MERCEDES BENZ S 3437 C MERCEDES BENZ S 3438 C MERCEDES BENZ S 3439 C MAN MERCEDES BENZ NEOPLAN S 3440 C MAN MERCEDES BENZ NEOPLAN SOLARIS S 3441 C MERCEDES BENZ S 3442 C MERCEDES BENZ S 3443 C MERCEDES BENZ	S 3445 C VOLVO S 3446 C NEOPLAN S 3447 C NEOPLAN S 3448 C MAN MERCEDES BENZ NEOPLAN S 3450 A ASTRA CATERPILLAR EUCLID PERLINI TEREX VOLVO CONSTRUCTION EQUIPMENT S 3451 C MERCEDES BENZ S 3452 C SCANIA S 3453 C MERCEDES BENZ S 3454 C RENAULT TRUCKS S 3455 C RENAULT TRUCKS S 3456 C SOLARIS S 3457 C IVECO MAN MERCEDES BENZ SCANIA SOLARIS TEMSA VISEON BUS VOLVO S 3458 C MAN SOLARIS VISEON BUS VOLVO S 3459 C MERCEDES BENZ S 3460 C DAF	S 3541 A RENAULT TRUCKS S 3570 A MERCEDES BENZ S 3572 R FORD OTOSAN S 3577 R ISUZU S 3592 R LIEBHERR S 3698 R HEULIEZ BUS RENAULT TRUCKS RENAULT V.I. S 3940 A DAF IVECO KAELBLE MERCEDES BENZ UNIMOG PEGASO RENAULT TRUCKS RENAULT V.I. STEYR / DAIMLER / PUCH VOLVO CONSTRUCTION EQUIPMENT S 3B55 A MAN DROEGMOELLER FAUN KAELBLE MERCEDES BENZ MERCEDES BENZ UNIMOG S 4006 NR MERCEDES BENZ KAMAZ S 4035 NR MAN S 4059 NR KAMAZ S 4064 NR KAMAZ S 4068 NR IVECO S 4077 NR MERCEDES BENZ S 4080 PO LEYLAND	S 4107 NR MERCEDES BENZ OPTARE GROUP S 4112 NR MERCEDES BENZ S 4120 NR NISSAN OPTARE GROUP PLAXTON RENAULT TRUCKS SISU AUTO VOLVO S 4120 R HEULIEZ BUS IKARUS OPTARE GROUP PADANE PLAXTON RENAULT TRUCKS SISU AUTO VOLVO VOLVO CONSTRUCTION EQUIPMENT S 4121 NR KAESSBOHRER MERCEDES BENZ S 4138 NR ISUZU KING LONG LIEBHERR VOLVO S 4142 NR DAF GINAF TATRA VAN HOOL S 4143 NR BOVA (VDL BOVA) DAF GINAF JONCKHEERE (VDL GROUP) KAESSBOHRER MERCEDES BENZ MOXY SCANIA S 4146 NR RENAULT TRUCKS SISU AUTO VOLVO S 4149 NR MERCEDES BENZ S 4150 NR MERCEDES BENZ S 4154 NR LIEBHERR S 4157 NR RENAULT TRUCKS VOLVO

**APPLICATIONS > APPLICAZIONI >
AFFECTATIONS > ANWENDUNGEN > APLICACIONES**

S 4158 NR VOLVO	S 4345 CA MERCEDES BENZ	S 4395 NR ASTRA IRISBUS IVECO	S 4416 NR MERCEDES BENZ	S 4770 A RENAULT TRUCKS RENAULT TRUCKS (E) RENAULT V.I.	VAN HOOL VDL BUS & COACH	MERCEDES BENZ UNIMOG	S 5400 NR ASTRA AUWAERTER FAUN FODEN FORD IVECO KAESSBOHRER NEOPLAN
S 4159 NR KING LONG	S 4346 CA ASTRA IVECO	S 4396 NR	S 4444 NR NISSAN	S 4940 A AUWAERTER BREMACH IVECO MERCEDES BENZ MULTICAR NISSAN STEYR / DAIMLER / PUCH UMBRAECCANICA	S 5046 PE AYATS BREDA-MENARINI E.R.F. MAN NEOPLAN PLAXTON TEMSA VAN HOOL VISEON BUS	S 5133 PE KAESSBOHRER MERCEDES BENZ NEOPLAN	S 5147 PE MAN
S 4161 CA MERCEDES BENZ	S 4347 CA DAF GINAF TATRA	S 4401 U	S 4450 A VOLVO VOLVO CONSTRUCTION EQUIPMENT	S 5003 DR ASTRA CACCIAMALI IVECO MENARINI PADANE	S 5060 A BREMACH IVECO	S 5156 PE MERCEDES BENZ MITSUBISHI-FUSO	S 5401 NR ASTRA IVECO PADANE VAN HOOL
S 4177 CA MAN NEOPLAN	S 4348 CA IVECO	S 4402 R	S 4461 NR PLAXTON RENAULT TRUCKS SISU AUTO VOLVO	S 5005 PE MAN	S 5062 PE FREIGHTLINER KAESSBOHRER KAMAZ MERCEDES BENZ	S 5159 PE MERCEDES BENZ	S 5427 GC MULTICAR
S 4211 N IVECO	S 4348 NR FORD OTOSAN	S 4403 U	S 4470 NR IRISBUS KAROSA	S 5006 PE BELL EQUIPMENT KAESSBOHRER MERCEDES BENZ SISU AUTO	S 5081 PE BOVA (VDL BOVA) DAF GINAF JONCKHEERE (VDL GROUP) SOLARIS TATRA TEMSA VAN HOOL	S 5169 PE ASTRA IVECO	S 5446 PO AVELING BARFORD GUY LEYLAND
S 4225 CA MERCEDES BENZ SISU AUTO	S 4349 CA MERCEDES BENZ	S 4404 U	S 4471 NR RENAULT TRUCKS RENAULT V.I.	S 5007 PE MERCEDES BENZ MERCEDES BENZ UNIMOG OPTARE GROUP	S 5087 OC IVECO	S 5181 PE IRIZAR SCANIA	S 5450 A ASTRA EUCALID PERLINI TEREX VOLVO CONSTRUCTION EQUIPMENT
S 4260 CA VOLVO	S 4350 CA RENAULT TRUCKS	S 4405 U	S 4472 NR KAESSBOHRER MERCEDES BENZ	S 5011 PE MULTICAR	S 5095 PE MAN MERCEDES BENZ MERCEDES BENZ UNIMOG MULTICAR OPTARE GROUP	S 5234 PE BOVA (VDL BOVA) DAF GINAF JONCKHEERE (VDL GROUP) SOLARIS TEMSA VAN HOOL VDL BUS & COACH	S 5536 PO MAN PEGASO VOLKSWAGEN
S 4270 A IVECO TEREX VOLVO CONSTRUCTION EQUIPMENT	S 4351 CA DAF	S 4406 U	S 4473 NR MAN	S 5013 PE MERCEDES BENZ OPTARE GROUP	S 5097 PE BREDA-MENARINI DENNIS EAGLE RENAULT TRUCKS VOLVO	S 5235 PE MAN NEOPLAN	S 5569 PO VOLVO CONSTRUCTION EQUIPMENT
S 4281 CA MERCEDES BENZ	S 4352 CA DAF	S 4407 NR	S 4474 NR ASTRA IVECO	S 5016 PE E.R.F. MAN NEOPLAN TEMSA VAN HOOL	S 5099 PE MERCEDES BENZ MERCEDES BENZ UNIMOG	S 5236 PE MERCEDES BENZ	S 5600 R AVELING BARFORD FODEN FORD LEYLAND PEGASO RENAULT TRUCKS
S 4311 N ASTRA IVECO	S 4370 A ASTRA VOLVO CONSTRUCTION EQUIPMENT	S 4408 NR	S 4475 NR RENAULT TRUCKS	S 5020 NR VOLVO	S 5102 PE ASTRA IVECO	S 5237 PE MERCEDES BENZ	S 5601 R MULTICAR
S 4314 CA MERCEDES BENZ	S 4378 NR AYATS DROEGMOELLER E.R.F. KAESSBOHRER MAN MERCEDES BENZ NEOPLAN SOLARIS STEYR / DAIMLER / PUCH TEMSA VAN HOOL VOLKSWAGEN	S 4409 NR	S 4476 NR MERCEDES BENZ RENAULT TRUCKS VOLVO	S 5022 PE NISSAN RENAULT TRUCKS	S 5111 PE IVECO	S 5238 PE OPTARE GROUP RENAULT TRUCKS SISU AUTO VOLVO	S 5603 R MULTICAR
S 4323 NR HEULIEZ BUS IKARUS IRISBUS KAESSBOHRER KAMAZ KOCKUM MAN MOXY PADANE PERLINI RENAULT TRUCKS RENAULT TRUCKS (E) RENAULT V.I. SCANIA VAN HOOL VOLVO VOLVO CONSTRUCTION EQUIPMENT	S 4380 PO ATKINSON AVELING BARFORD AVIA AWD BEDFORD FORD GUY HAULAMATIC HEATHFIELD KOCKUM LEYLAND RENAULT V.I. RENAULT V.I. (E) SEDDON ATKINSON VOLVO CONSTRUCTION EQUIPMENT	S 4410 NR	S 4477 NR RENAULT TRUCKS VOLVO	S 5026 PE BELL EQUIPMENT BREDA-MENARINI KAESSBOHRER MERCEDES BENZ MERCEDES BENZ UNIMOG NEOPLAN OPTARE GROUP	S 5124 PE DROEGMOELLER KAESSBOHRER MERCEDES BENZ MERCEDES BENZ UNIMOG NEOPLAN	S 5239 PE MERCEDES BENZ	S 5606 R MULTICAR
S 4329 NR ASTRA CACCIAMALI IVECO MENARINI	S 4391 NR MULTICAR	S 4411 NR	S 4478 NR DAF	S 5036 PE NISSAN RENAULT TRUCKS	S 5131 PE ASTRA IVECO	S 5240 PE MAN	S 5613 PO MULTICAR
S 4337 NR DAF SOLARIS	S 4394 NR IVECO MULTICAR RENAULT TRUCKS	S 4412 NR	S 4479 NR MERCEDES BENZ RENAULT TRUCKS SCANIA	S 5044 PE SCANIA	S 5132 PE MERCEDES BENZ MERCEDES BENZ UNIMOG	S 5246 PE DAF TATRA	S 5619 PO IRIZAR MAN SCANIA
S 4341 NR IRIZAR MOXY SCANIA	S 4408 NR IVECO MULTICAR RENAULT TRUCKS	S 4413 NR	S 4480 NR HEULIEZ BUS	S 5045 PE DAF GINAF SOLARIS	S 5133 PE MAN MERCEDES BENZ	S 5250 A MERCEDES BENZ	S 5630 R DAF
		S 4414 NR	S 4481 NR			S 5270 A AUWAERTER KAESSBOHRER MAN MERCEDES BENZ RENAULT TRUCKS TALBOT (E) ZETTELMEYER	S 5650 A IVECO
		S 4415 NR	S 4482 NR			S 5277 GC RENAULT TRUCKS	S 5663 PO IRISBUS KAESSBOHRER MAN MERCEDES BENZ

S 4158 NR...
... S 5663 PO

**APPLICATIONS > APPLICAZIONI >
AFFECTATIONS > ANWENDUNGEN > APLICACIONES**

**S 5663 PO...
... S 7284 A**

NEOPLAN SOLBUS VOLVO S 5664 PO DAF IVECO MAN RENAULT TRUCKS TATRA S 5700 R ZASTAVA (YUGO) S 5800 R SEDDON ATKINSON THERMO KING VOLVO VOLVO CONSTRUCTION EQUIPMENT S 5802 R DAF IVECO LEYLAND S 5812 A RENAULT TRUCKS S 5820 R BREMACH IVECO S 5900 PO RENAULT TRUCKS RENAULT V.I. S 5902 PO BOVA (VDL BOVA) DAF GINAF JONCKHEERE (VDL GROUP) VAN HOOL S 5903 PO IRISBUS RENAULT TRUCKS SISU AUTO S 5904 PO BOVA (VDL BOVA) JONCKHEERE (VDL GROUP) TATRA VAN HOOL S 5905 PO DAF TATRA S 5911 N IVECO S 6001 NE BELL EQUIPMENT FREIGHTLINER KAESSBOHRER KAMAZ MAN MERCEDES BENZ SISU AUTO S 6004 NE E.R.F. MAN NEOPLAN	TEMSA S 6008 NE SCANIA S 6009 NE DAF GINAF SOLARIS VAN HOOL S 6010 NE IRIZAR SCANIA S 6011 NE AYATS BREDA-MENARINI E.R.F. MAN NEOPLAN OPTARE GROUP PLAXTON TEMSA VAN HOOL VISEON BUS S 6016 NE E.R.F. MAN NEOPLAN S 6017 NE BELL EQUIPMENT MERCEDES BENZ MERCEDES BENZ UNIMOG NEOPLAN OPTARE GROUP S 6024 NE BOVA (VDL BOVA) DAF GINAF JONCKHEERE (VDL GROUP) SOLARIS TATRA TEMSA VAN HOOL VDL BUS & COACH S 6034 NE BREMACH IVECO S 6039 NE BREDA-MENARINI DENNIS EAGLE RENAULT TRUCKS VOLVO S 6043 NE IVECO S 6044 NE ASTRA IVECO S 6059 NE MAN NEOPLAN RENAULT TRUCKS S 6062 NE ASTRA MAN	S 6063 NE AYATS MAN STEYR / DAIMLER / PUCH TEMSA S 6064 NE MAN S 6072 NE IVECO S 6080 NE IVECO S 6088 NE AYATS IRISBUS MAN NEOPLAN VAN HOOL VISEON BUS S 6089 NE DAF KAESSBOHRER MERCEDES BENZ MERCEDES BENZ UNIMOG S 6100 R PEGASO S 6146 NE BOVA (VDL BOVA) DAF GINAF JONCKHEERE (VDL GROUP) SOLARIS VAN HOOL VDL BUS & COACH S 6147 NE IRIZAR SCANIA S 6148 NE MERCEDES BENZ MERCEDES BENZ UNIMOG S 6150 NE MAN S 6180 PO AVELING BARFORD S 6181 N AVELING BARFORD BEDFORD HEATHFIELD LEYLAND S 6270 A ASTRA EUCLID S 6290 PO MAN RENAULT TRUCKS S 6303 A IVECO	S 6311 N MULTICAR S 6370 A AUWAERTER MERCEDES BENZ S 6380 PO AVELING BARFORD CARRIER FORD S 6449 PO MAN PEGASO RENAULT V.I. SOLBUS VOLVO S 6450 A VOLVO S 6481 N AVELING BARFORD AWD BEDFORD FORD KOCKUM PETTER VOLVO VOLVO CONSTRUCTION EQUIPMENT DAF RENAULT TRUCKS S 6550 A ASTRA ATKINSON BEDFORD FODEN FORD GUY HEATHFIELD IKARUS IVECO KAELBLE KOCKUM KOMATSU LEYLAND MAN MENARINI PERLINI RENAULT TRUCKS RENAULT V.I. SEDDON ATKINSON TEREX VOLVO CONSTRUCTION EQUIPMENT S 6645 N AVIA PEGASO S 6650 A PETTER BOVA (VDL BOVA) DAF FORD IVECO KAELBLE STEYR / DAIMLER / PUCH ZETTELMEYER	S 6870 A VOLVO S 6911 N IVECO S 6940 A EUCLID MENARINI S 7002 A AUWAERTER S 7004 A FORD S 7008 A CATERPILLAR S 7010 A AVELING BARFORD EUCLID TEREX VOLVO CONSTRUCTION EQUIPMENT S 7011 A ATKINSON AVELING BARFORD EUCLID FODEN HEATHFIELD TEREX S 7017 A IVECO S 7023 A AVELING BARFORD FODEN S 7024 A BEDFORD EUCLID FODEN TEREX S 7026 A AVELING BARFORD S 7028 A BUESSING KAESSBOHRER MAN S 7033 A CATERPILLAR S 7039 A CATERPILLAR S 7040 A CATERPILLAR S 7041 A CATERPILLAR S 7045 A LEYLAND	S 7091 A VOLVO VOLVO CONSTRUCTION EQUIPMENT S 7092 A VOLVO S 7107 A BUESSING S 7111 NC ATKINSON AVELING BARFORD AVIA AWD BEDFORD BREMACH DAF FODEN FORD GUY HAULAMATIC HEATHFIELD IVECO KOCKUM LEYLAND MAN MOXY NISSAN PEGASO PETTER RENAULT TRUCKS RENAULT TRUCKS (E) RENAULT V.I. RENAULT V.I. (E) SCANIA SEDDON ATKINSON TALBOT (E) UMBRAMECCANICA VAN HOOL VOLVO VOLVO CONSTRUCTION EQUIPMENT ZASTAVA (YUGO) S 7112 NC ATKINSON AVELING BARFORD AWD FODEN FORD KOCKUM SEDDON ATKINSON VOLVO CONSTRUCTION EQUIPMENT S 7129 A DAF IVECO KAELBLE MERCEDES BENZ UNIMOG PEGASO RENAULT TRUCKS RENAULT V.I. STEYR / DAIMLER / PUCH TEMSA VOLVO CONSTRUCTION EQUIPMENT S 7138 A DAF S 7139 A BEDFORD S 7142 A IVECO S 7143 A ASTRA	S 7144 A ASTRA S 7160 A VOLVO S 7161 A VOLVO S 7165 A MULTICAR S 7168 A IVECO S 7170 A IVECO PEGASO S 7183 A IVECO S 7185 A MERCEDES BENZ S 7186 A SCANIA S 7187 A DAF IVECO MAN MERCEDES BENZ NEOPLAN PEGASO SOLARIS S 7200 N INBUS IVECO S 7213 A KAESSBOHRER MERCEDES BENZ NEOPLAN S 7214 A SCANIA S 7217 A ASTRA PERLINI S 7218 A ASTRA PERLINI S 7221 A ASTRA MENARINI S 7222 A ASTRA MENARINI S 7259 A ASTRA AVIA BMC	BOVA (VDL BOVA) DAF E.R.F. GINAF HEULIEZ BUS IRISBUS IVECO KAESSBOHRER KAMAZ KAROSA KING LONG MAN MERCEDES BENZ MERCEDES BENZ UNIMOG NEOPLAN RENAULT TRUCKS RENAULT V.I. SCANIA SOLARIS STEYR / DAIMLER / PUCH TEMSA VAN HOOL VOLKSWAGEN VOLVO S 7260 PO AYATS BREDA-MENARINI DROEGMOELLER IKARUS KAELBLE KAESSBOHRER MAN NEOPLAN RENAULT TRUCKS SOLARIS TEMSA VAN HOOL S 7261 PO ASTRA BOVA (VDL BOVA) DROEGMOELLER EUCLID KAELBLE KAESSBOHRER MAN MERCEDES BENZ NEOPLAN PADANE VAN HOOL ZETTELMEYER S 7266 A IVECO S 7276 A VOLVO S 7277 A VOLVO S 7278 A VOLVO S 7279 A MERCEDES BENZ S 7280 A MERCEDES BENZ S 7281 A VOLVO S 7284 A RENAULT TRUCKS RENAULT V.I. SISU AUTO
---	--	---	--	---	--	--	--

APPLICATIONS > APPLICAZIONI >
AFFECTATIONS > ANWENDUNGEN > APLICACIONES

S 7A86 A AVIA BMC BOVA (VDL BOVA) DAF GINAF HEULIEZ BUS KING LONG SOLBUS TATRA TEMSA VAN HOOL VDL BUS & COACH	S 7F17 A MAN S 7F18 A VOLVO S 7F19 A VOLVO S 7F20 A MERCEDES BENZ S 7F21 A MERCEDES BENZ S 7F22 A MERCEDES BENZ S 7F23 A RENAULT TRUCKS VOLVO S 7F24 A MERCEDES BENZ UNIMOG RENAULT TRUCKS SCANIA S 7F25 A MAN S 7F26 A SCANIA S 7F27 A MAN S 7F28 A MAN S 7F29 A MAN S 7F30 A SCANIA S 7F31 A KAESSBOHRER MERCEDES BENZ S 8020 R ASTRA IVECO S 8110 NR BOVA (VDL BOVA) DAF LEYLAND NEOPLAN VAN HOOL S 8111 NC AWD BEDFORD CARRIER DAF HEATHFIELD LEYLAND MOXY NISSAN	PEGASO RENAULT TRUCKS SEDDON ATKINSON S 8137 RH HEULIEZ BUS IRISBUS IVECO RENAULT V.I. S 8260 PO AUWAERTER DROEGMOELLER KAESSBOHRER MERCEDES BENZ PADANE S 8270 A ASTRA EUCLID S 8310 R BREMACH MULTICAR RENAULT TRUCKS S 8350 A CATERPILLAR S 8381 NC AVELING BARFORD BEDFORD CARRIER DAF GUY LEYLAND RENAULT TRUCKS VOLVO S 8410 AR ASTRA INBUS IVECO MENARINI PADANE S 8450 A VOLVO S 8500 NR AVIA BOVA (VDL BOVA) BREMACH IVECO MULTICAR PEGASO RENAULT TRUCKS UMBRAMECCANICA VOLVO S 8501 NR FORD IVECO MOXY SCANIA SEDDON ATKINSON STEYR / DAIMLER / PUCH UMBRAMECCANICA VOLVO CONSTRUCTION EQUIPMENT S 8502 A MAN MERCEDES BENZ UNIMOG STEYR / DAIMLER / PUCH	S 8570 A DAF IRIZAR IVECO LEYLAND SCANIA SOLARIS S 8600 R AUWAERTER BOVA (VDL BOVA) DAF FAUN FORD INBUS IVECO KAELEBLE KAESSBOHRER NEOPLAN PADANE RENAULT TRUCKS RENAULT TRUCKS (E) RENAULT V.I. RENAULT V.I. (E) STEYR / DAIMLER / PUCH TALBOT (E) VAN HOOL VOLVO CONSTRUCTION EQUIPMENT ZETTELMEYER S 8605 HP RENAULT V.I. S 8760 A IVECO S 8790 PO AUWAERTER BUSSING DAF FAUN IVECO KAELEBLE KAESSBOHRER MAN MERCEDES BENZ PERLINI RENAULT TRUCKS (E) SCANIA SEDDON ATKINSON TALBOT (E) VAN HOOL VOLVO S 8840 A RENAULT TRUCKS RENAULT TRUCKS (E) S 8940 A FODEN MOXY RENAULT TRUCKS RENAULT V.I. S 8950 A ATKINSON AVELING BARFORD FAUN FORD GUY HAULAMATIC HEATHFIELD LEYLAND RENAULT TRUCKS SEDDON ATKINSON TATRA	S 9006 AR OPTARE GROUP PLAXTON RENAULT TRUCKS VOLVO VOLVO CONSTRUCTION EQUIPMENT S 9007 AR SCANIA S 9030 R IVECO KAMAZ KAROSA S 9080 PO MERCEDES BENZ S 9091 N AVIA MAN RENAULT TRUCKS RENAULT V.I. S 9240 A RENAULT TRUCKS S 9320 NR OPTARE GROUP RENAULT TRUCKS SISU AUTO VOLVO S 9380 A NISSAN RENAULT TRUCKS S 9400 R AVELING BARFORD AVIA AWD FODEN NISSAN RENAULT TRUCKS SEDDON ATKINSON VOLVO ZASTAVA (YUGO) S 9490 PO DROEGMOELLER MERCEDES BENZ S 9570 A MERCEDES BENZ S 9600 NR MERCEDES BENZ MERCEDES BENZ UNIMOG MULTICAR S 9610 R IVECO NISSAN VAN HOOL S 9710 R AVIA IVECO PEGASO ZASTAVA (YUGO)	S 9870 A DAF S 9960 NC UMBRAMECCANICA S 9990 A ATKINSON AVELING BARFORD EUCLID FODEN HEATHFIELD TEREX VOLVO CONSTRUCTION EQUIPMENT
S 7B01 A MAN S 7B10 A RENAULT TRUCKS VOLVO S 7B11 A GINAF IRISBUS IVECO S 7B36 A SCANIA S 7B39 A RENAULT TRUCKS VOLVO S 7B45 A DAF S 7B80 A KING LONG S 7B81 A KING LONG S 7C13 A SCANIA S 7C16 A IVECO S 7D41 A SCANIA S 7E35 A MAN S 7F13 A MERCEDES BENZ S 7F14 A BOVA (VDL BOVA) DAF TATRA VAN HOOL S 7F15 A DAF S 7F16 A KING LONG MAN					

S 7A86 A ...
... S 9990 A

**CROSS REFERENCES > CORRISPONDENZE >
CORRESPONDANCES > VERGLEICHNUMMERN > CRUCE DE REFERENCIAS**

BALDWIN	SOFIMA								
B114	S 5601 R	BT267	S 0700 R	PA1911	S 8940 A	PA3754	S 7168 A	RS3870	S 7421 A
B114		BT292	S 7600 R	PA1912	S 4370 A	PA3760	S 7187 A	RS3871	S 7422 A
(O/OR)		BT347	S 9710 R	PA1940	S 5650 A	PA3765	S 7213 A	RS3888	S 7409 A
B132	S 5603 R	BT348	S 9610 R	PA2001	S 7808 A	PA3766	S 7431 A	RS3922	S 7516 A
B163	S 1600 R	BT5	S 5700 R	PA2081	S 2810 A	PA3767	S 7285 A	RS3952	S 7371 A
B178	S 7500 R	BT8302	S 0230 R	PA2312	S 8840 A	PA3768	S 7278 A	RS3992	S 7506 A
B2	S 5600 R	BT9408	S 0VGT A	PA2330	S 7359 A	PA3807	S 1070 A	RS3993	S 7507 A
B202		BW5141	S 9006 AR	PA2358	S 7033 A	PA3836	S 1506 A	RS3998	S 7558 A
(FORD)	S 7330 R	C200K	S 4000 O	PA2363	S 7313 A	PA3838	S 7280 A	RS3999	S 7559 A
B218	S 9030 R	CA30103	S 7F22 A	PA2364	S 7312 A	PA3839	S 3089 C	RS4549	S 7405 A
B229		CA30104	S 7F21 A	PA2384	S 7008 A	PA3857	S 7474 A	RS4562	S 7A15 A
(SCANIA)	S 2329 R	CA30105	S 7F20 A	PA2385	S 7041 A	PA3876	S 7544 A	RS4638	S 7615 A
B233	S 1600 R	CV15002	S 7266 A	PA2391	S 7045 A	PA3925	S 7576 A	RS4642	S 7F18 A
B236	S 8600 R	F834F	S 2161 N	PA2398	S 4770 A	PA3980	S 3053 C	RS4643	S 7F19 A
B246	S 3102 R	F950F	S 2162 N	PA2405	S 2450 A	PA4390	S 3340 A	RS4775	S 8502 A
B253	S 9400 R	F953F	S 0101 N	PA2409	S 7945 A	PA4612	S 3062 C	RS4794	S 7A17 A
B297	S 5600 R	LL1894	S 5450 A	PA2416	S 0950 A	PA4758	S 7A14 A	RS4861	S 7428 A
B34	S 1600 R	LL2330	S 7359 A	PA2418FN	S 0850 A	PA4912	S 3221 C	RS4959	S 7573 A
B403	S 8600 R	LL2363	S 7313 A	PA2419	S 2850 A	PA4928	S 3092 C	RS4963	S 7970 A
B7001	S 3280 R	LL2418FN	S 0850 A	PA2426FN	S 7170 A	PA4938	S 3066 C	RS4966	S 7347 A
B7031	S 5802 R	LL2453	S 7315 A	PA2427	S 7670 A	PA4945	S 3436 C	RS4967	S 7345 A
B7054	S 0900 R	LL2783	S 7017 A	PA2453	S 7315 A	PA4947	S 3055 C	RS4968	S 7625 A
B7113	S 1220 R	OAS98000	S 7A86 A	PA2454	S 7314 A	PA4955	S 3165 C	RS4969	S 7626 A
B7187	S 3275 R	P102	S 2510 O	PA2461	S 7143 A	PA4956	S 3072 C	RS5301	S 2764 A
B76	S 0900 R	P106	S 3081 PO	PA2462	S 7144 A	PA5330	S 3217 C	RS5313	S 7A44 A
B7600	S 0900 R	P106HD	S 3081 PO	PA2474	S 2650 A	PA5336	S 3078 C	RS5342	S 7383 A
B7685	S 4120 R	P15	S 6380 PO	PA2475	S 0450 A	PA5339	S 3048 C	RS5343	S 7469 A
B76SS	S 4402 R	P171	S 4080 PO	PA2501	S 1005 A	PA5340	S 3054 C	RS5351	S 7406 A
B96	S 3409 R	P172	S 4080 PO	PA2540	S 7607 A	PA5341	S 3139 C	RS5356	S 7600 A
B975	S 5800 R	P174	S 0280 PO	PA2563	S 7308 A	PA5365	S 7390 A	RS5358	
BA5374	S 7259 A	P176	S 6180 PO	PA2641	S 2570 A	PA5426	S 3373 A	RS5358	S 7A50 A
BA5375	S 7344 A	P177	S 1080 PO	PA2707	S 0070 A	PA5445	S 7B80 A	RS5358	
BA5376	S 7393 A	P190	S 7380 PO	PA2757	S 2070 A	PA5446	S 7B81 A	(MERCEDÉS BENZ)	S 7A12 A
BA5379	S 7A66 A	P198	S 5446 PO	PA2767	S 4940 A	PA5475	S 3161 C	RS5360	S 7A16 A
BA5566	S 7F23 A	P20HD	S 3300 PO	PA2773	S 7338 A	PA5476	S 4346 CA	RS5361	S 7616 A
BC110	S 5900 PO	P20HD	S 3301 PO	PA2774	S 7337 A	PA5477	S 4177 CA	RS5362	S 7639 A
BC40009	S 5905 PO	P235	S 0580 PO	PA2775	S 7A34 A	PA5492	S 4225 CA	RS5390	S 7643 A
BC7173	S 5903 PO	P242	S 8260 PO	PA2776	S 1050 A	PA5493	S 3289 C	RS5408	S 7484 A
BD232	S 3003 DR	P294	S 7261 PO	PA2783	S 7017 A	PA5647	S 3441 C	RS5413	S 7B45 A
BD321	S 5003 DR	P40003	S 5236 PE	PA2785	S 6870 A	PA639	S 7002 A	RS5422	S 7695 A
BD322	S 3003 DR	P7015	S 5124 PE	PA2786	S 7578 A	PA645	S 7023 A	RS5431	S 7F15 A
BD323	S 3003 DR	P7016	S 5549 PO	PA2787	S 7549 A	PE17000	S 4405 U	RS5438	S 7F17 A
BD325	S 5003 DR	P7017	S 5099 PE	PA2792	S 0650 A	PF231	S 1411 N	RS5440	S 7A29 A
BD7120	S 3003 DR	P7052	S 9490 PO	PA2798	S 7091 A	PF312	S 4311 N	RS5483	S 7575 A
BD7168	S 2003 DR	P7145	S 5005 PE	PA2801	S 0050 A	PF46003	S 6043 NE	RS5484	S 7608 A
BD7169	S 3577 R	P7188	S 5036 PE	PA2812	S 6370 A	PF7596	S 9091 N	RS5508	S 7637 A
BF1215	S 7600 NR	P7190	S 5016 PE	PA2813	S 8570 A	PF7735	S 6017 NE	RS5535	S 7627 A
BF1217	S 0999 NR	P7192	S 5006 PE	PA2814	S 1450 A	PF7761	S 6001 NE	RS5542	S 7B36 A
BF1276	S 8500 NR	P721	S 5007 PE	PA2835	S 3940 A	PF7767	S 6009 NE	RS5549	S 7649 A
BF1329	S 4143 NR	P7232	S 2530 PO	PA2836	S 7129 A	PF7896	S 6008 NE	RS5671	S 7A26 A
BF13290	S 4143 NR	P7329	S 5045 PE	PA2837	S 1940 A	PF7935	S 6011 NE	RS5692	S 7650 A
BF13660	S 4461 NR	(MAN)	S 5046 PE	PA2838	S 3570 A	PF7936	S 6010 NE	RS5730	S 7A03 A
BF1386-O	S 4157 NR	(RENAULT TRUCKS, VOLVO)	S 5097 PE	PA2845	S 0950 A	PF7938	S 6039 NE		
BF13870	S 4146 NR	P7330	S 5234 PE	PA2847	S 5270 A	PF7947	S 6146 NE	BELL EQUIPMENT	SOFIMA
BF13880	S 4158 NR	P7495	S 5087 OC	PA2862	S 7479 A	PF834	S 7411 N	221512	S 6001 NE
BF13910	S 4121 NR	P7502	S 5181 PE	PA2865	S 7107 A	PF838	S 8381 NC	221578	S 5036 PE
BF46037	S 4150 NR	P7505	S 5156 PE	PA2866	S 7638 A	PF950	S 1411 N	221899	S 6017 NE
BF587D	S 8501 NR	PA1608	S 7026 A	PA2869	S 7839 A	PF9829KIT	S 6147 NE		
BF7522	S 9960 NC	PA1621-2	S 7011 A	PA2888	S 4450 A	PF986	S 6311 N	BMC	SOFIMA
BF7525	S 0810 NR	PA1630-2	S 9990 A	PA2891	S 7940 A	PF9865	S 6072 NE	52RS001779	S 7408 A
BF7532	S 1410 NR	PA1636FN	S 0060 A	PA2914	S 0270 A	PT108	S 3180 PO	52RS018345	S 7422 A
BF7539	S 5020 NR	PA1637FN	S 6940 A	PA2915	S 7161 A	PT108HHD	S 3180 PO	52RS018346	S 7421 A
BF7593	S 0610 NR	PA1646FN	S 0940 A	PA2942	S 7160 A	PT12	S 4380 PO		
BF7644	S 5020 NR	PA1649	S 7010 A	PA2945	S 7185 A	PT29	S 1080 PO		
BF7663	S 4329 NR	PA1667FN	S 2950 A	PA2955	S 7368 A	PT385	S 3301 PO	BOSCH	SOFIMA
BF7756	S 4416 NR	PA1669	S 8350 A	PA2981	S 9570 A	PT385E	S 3301 PO	0450136001	S 5401 NR
BF7778	S 4006 NR	PA1681FN	S 8950 A	PA2982	S 7186 A	PT670	S 1910 PO	0450904077	S 1013 B
BF783	S 0710 NR	PA1690FN	S 0840 A	PA2984	S 7548 A	PT670E	S 1910 PO	0450905930	S 4416 NR
BF788	S 5400 NR	PA1706	S 9990 A	PA3405	S 3330 A	PT691	S 8790 PO	0450906161	S 7600 NR
BF7886	S 0712 NR	PA1718	S 7808 A	PA3408	S 7139 A	PT722	S 5569 PO	0450906174	S 7600 NR
BF7908	S 4341 NR	PA1750FN	S 0940 A	PA3414	S 7A22 A	PT9374	S 5613 PO	0450906267	S 7600 NR
BF7942	S 4089 NR	PA1797	S 7040 A	PA3446	S 3051 A	RS3544	S 7356 A	0450906288	S 4391 NR
BF797	S 0510 NR	PA1815	S 7039 A	PA3449	S 7974 A	RS3700	S 7A35 A	0450906292	S 7600 NR
BF825	S 7112 NC	PA1822FN	S 0850 A	PA3477	S 7614 A	RS3701	S 7A36 A	0450906296	S 5427 GC
BF884	S 8111 NC	PA1846	S 7945 A	PA3484	S 0550 A	RS3714	S 1970 A	0450906296	S 7600 NR
BF900	S 6710 NR	PA1865FN	S 6650 A	PA3494	S 7277 A	RS3722	S 7286 A	0450906374	S 4391 NR
BF957	S 4510 NR	PA1880	S 7024 A	PA3558	S 1307 A	RS3727	S 7357 A	0451103003	S 1270 R
BF970	S 0810 NR	PA1884	S 0150 A	PA3566	S 7343 A	RS3728	S 7284 A	0451103004	S 2329 R
BF980	S 8110 NR	PA1885	S 6550 A	PA3572	S 7342 A	RS3729	S 7404 A	0451103007	S 6100 R
BF988	S 5400 NR	PA1886	S 4270 A	PA3597	S 7028 A	RS3744		0451103009	S 2030 R
BT215	S 1380 R	PA1893	S 2840 A	PA3605	S 7183 A	(DAF)	S 9870 A	0451103011	S 1600 R
BT216	S 9400 R	PA1894	S 5450 A	PA3606	S 7987 A	RS3744		0451103013	S 2030 R
BT217	S 0420 R	PA1895	S 6270 A	PA3679	S 7361 A	(ALTRE/OTHER APPL.)	S 7423 A	0451103022	S 1270 R
BT237	S 0420 R	PA1902FN	S 2370 A	PA3681	S 7092 A	RS3745	S 7408 A	0451103023	S 6100 R
BT251	S 0420 R	PA1905	S 3450 A	PA3685	S 5250 A	RS3764	S 7A13 A	0451103025	S 1600 R
		PA1906	S 8270 A	PA3699	S 7165 A	RS3826	S 7564 A	0451103029	
					S 7372 A	RS3827	S 7565 A		



CROSS REFERENCES > CORRISPONDENZE > CORRESPONDANCES > VERGLEICHNUMMERN > CRUCE DE REFERENCIAS

(ALFA ROMEO)	S 1600 R	0451203061	S 5601 R	1457429073	S 8450 A	1457429655	S 6001 NE	1457431325	S 7411 N
0451103029		0451203078	S 0700 R	1457429080	S 2810 A	1457429675	S 6710 NR	1457431326	S 1411 N
(ALTRE/OTHER APPL.)	S 1270 R	0451203087	S 1563 R	1457429101	S 4080 PO	1457429676	S 8110 NR	1457431329	S 7411 N
0451103033	S 2030 R	0451203087		1457429105	S 3081 PO	1457429678	S 8111 NC	1457431336	S 1411 N
0451103040	S 6100 R	(ALTRE/OTHER APPL.)	S 1560 R	1457429106	S 3081 PO	1457429681	S 0710 NR	1457431360	S 1411 N
0451103044	S 1270 R	0451203088		1457429107	S 5005 PE	1457429700	S 4080 PO	1457431426	S 3081 PO
0451103046	S 2030 R	(O/OR)	S 5603 R	1457429109	S 6481 N	1457429706	S 1080 PO	1457431428	S 3180 PO
0451103060	S 6100 R	0451203088	S 5601 R	1457429115	S 3180 PO	1457429709	S 1080 PO	1457431430	S 0530 PO
0451103063	S 5600 R	0451203090	S 9610 R	1457429116	S 5013 PE	1457429710	S 6180 PO	1457431431	S 0530 PO
0451103074	S 7500 R	0451203102	S 3106 R	1457429117	S 3180 PO	1457429732	S 5133 PE	1457431432	S 2530 PO
0451103089	S 0130 R	0451203108	S 7330 R	1457429125	S 0530 PO	1457429735	S 8260 PO	1457431458	S 7411 N
0451103100	S 1600 R	0451203112	S 8310 R	1457429128	S 5006 PE	1457429740	S 7261 PO	1457431482	S 8790 PO
0451103101	S 1380 R	0451203125	S 3280 R	1457429130	S 2530 PO	1457429741	S 7260 PO	1457431483	S 0122 O
0451103107	S 1600 R	0451203152	S 0700 R	1457429137	S 5016 PE	1457429750	S 1080 PO	1457431484	S 4000 O
0451103122	S 1600 R	0451203154	S 1600 R	1457429162	S 0300 O	1457429779	S 7185 A	1457431485	S 0300 O
0451103126	S 1600 R	0451203177	S 8310 R	1457429165	S 8790 PO	1457429780	S 7168 A	1457431487	S 0012 O
0451103128	S 6100 R	0451203178	S 8310 R	1457429170	S 0122 O	1457429794	S 0850 A	1457431707	S 6017 NE
0451103134	S 2030 R	0451203196	S 5630 R	1457429172	S 0122 O	1457429820	S 3081 PO	1457431710	S 6004 NE
0451103136	S 6100 R	0451203199	S 3003 DR	1457429174	S 5613 PO	1457429822	S 1940 A	1457432108	S 0660 A
0451103148	S 0130 R	0451203201	S 3003 DR	1457429175	S 4000 O	1457429824	S 1450 A	1457432138	S 1506 A
0451103167	S 1600 R	0451203212	S 7330 R	1457429176	S 4000 O	1457429825	S 6180 PO	1457432187	S 2070 A
0451103191	S 1600 R	0451203218	S 7600 R	1457429180	S 0300 O	1457429826	S 6180 PO	1457432188	S 8570 A
0451103219	S 3257 R	0451203220	S 5802 R	1457429182	S 0300 O	1457429845	S 3330 A	1457432192	S 7998 A
0451103221		0451203223	S 8310 R	1457429190	S 0012 O	1457429850	S 7004 A	1457432193	S 7170 A
(N.10 FILTRI/FILTERS)	S 3257 R	0451203226	S 5800 R	1457429191	S 0012 O	1457429854	S 5250 A	1457433042	S 7970 A
0451103222	S 3257 R	0451203227	S 5800 R	1457429200	S 4000 O	1457429868	S 0660 A	1457433200	S 0840 A
0451103228	S 2030 R	0451203228	S 3497 R	1457429201	S 4000 O	1457429874	S 0050 A	1457433202	S 8940 A
0451103238	S 5630 R	0451203234	S 5800 R	1457429205	S 6481 N	1457429882	S 7107 A	1457433203	S 2840 A
0451103251		0451300003	S 4120 R	1457429209	S 6481 N	1457429883	S 7940 A	1457433204	S 7550 A
(CHRYSLER, JEEP A.M.C.)	S 1600 R	0451300004	S 1220 R	1457429210	S 6181 N	1457429884	S 7813 A	1457433205	S 2370 A
0451103252	S 3280 R	0451301001	S 8600 R	1457429214	S 6181 N	1457429885	S 7165 A	1457433231	
0451103253		0451301184	S 0120 R	1457429215	S 7111 NC	1457429886	S 7839 A	(RENAULT)	S 9240 A
(O/OR)	S 5603 R	0451301207	S 3292 R	1457429219	S 7111 NC	1457429887	S 2850 A	1457433332	S 7356 A
0451103253	S 5601 R	0451403001	S 9030 R	1457429220	S 8381 NC	1457429888	S 7186 A	1457433560	S 7383 A
0451103257	S 8310 R	0451403077	S 0900 R	1457429224	S 8381 NC	1457429891	S 7288 A	1457433562	S 7214 A
0451103274	S 6100 R	0451403200	S 5003 DR	1457429260	S 2510 O	1457429899	S 1670 A	1457433564	S 7428 A
0451103282	S 2329 R	0451403208	S 3275 R	1457429265	S 2510 O	1457429901	S 7808 A	1457433601	S 3030 A
0451103289	S 3425 R	0986450506	S 4416 NR	1457429266	S 2510 O	1457429932	S 0650 A	1457433610	S 3940 A
0451103343	S 4402 R	0986450695		1457429270	S 5446 PO	1457429933	S 2950 A	1457433611	S 7129 A
0451103346	S 5601 R	(BR), (RA)	S 7111 NC	1457429271	S 5026 PE	1457429941	S 4940 A	1457433625	S 1540 A
0451103353	S 0130 R	0986452001	S 5600 R	1457429273	S 7510 O	1457429946	S 0950 A	1457433626	S 3059 A
0451103357	S 3102 R	0986452003	S 1600 R	1457429274	S 7510 O	1457429950	S 2450 A	1457433631	S 4770 A
0451103902		0986452005	S 3102 R	1457429276	S 5381 PO	1457429951	S 0060 A	1457433632	S 8840 A
(N.10 FILTRI/FILTERS)	S 1600 R	0986452551	S 3102 R	1457429277	S 3631 PO	1457429965	S 5270 A	1457433633	S 0940 A
0451103903		0986452903	S 1600 R	1457429278	S 5095 PE	1457429966	S 2650 A	1457433634	S 7945 A
(N.10 FILTRI/FILTERS)	S 1270 R	0986452905	S 3102 R	1457429279	S 9091 N	1457429967	S 0270 A	1457433649	S 0070 A
0451103904		0986626755	S 7562 A	1457429305	S 7510 O	1457429968	S 7987 A	1457433651	S 7187 A
(N.10 FILTRI/FILTERS)	S 2030 R	0986626758	S 7284 A	1457429354	S 2162 N	1457429969	S 1050 A	1457433666	S 9990 A
0451103906		0986626762	S 7405 A	1457429359	S 2161 N	1457429975	S 0450 A	1457433668	S 2570 A
(O/OR) (N.10 FILTRI/FILTERS)	S 5603 R	0986626763	S 7573 A	1457429410	S 6490 PO	1457429976	S 0150 A	1457433670	S 7161 A
0451103906		0986626768	S 7A44 A	1457429413	S 6490 PO	1457429977	S 6550 A	1457433671	S 7160 A
(N.10 FILTRI/FILTERS)	S 5601 R	0986626778	S 7A59 A	1457429420	S 0580 PO	1457429978	S 0070 A	1457433672	S 4370 A
0451104001	S 5600 R	0986626779	S 7544 A	1457429423	S 0580 PO	1457429979	S 7281 A	1457433673	S 7033 A
0451104003	S 3241 R	0986626780	S 7546 A	1457429435	S 7380 PO	1457429980	S 1070 A	1457433675	S 0060 A
0451104004	S 7600 R	0986626781	S 7576 A	1457429436	S 7380 PO	1457429982	S 0050 A	1457433676	S 6940 A
0451104010	S 0900 R	0986626784	S 7639 A	1457429440	S 6380 PO	1457429985	S 6370 A	1457433678	S 7138 A
0451104013	S 3010 R	0986626785	S 7945 A	1457429441	S 6380 PO	1457429989	S 2810 A	1457433703	S 3082 A
0451104015	S 8600 R	0986626789	S 9870 A	1457429445	S 4380 PO	1457429991	S 3570 A	1457433721	S 7638 A
0451104018	S 2003 DR	0986626790	S 7404 A	1457429449	S 4380 PO	1457429998	S 9570 A	1457433724	S 7614 A
0451104063	S 5600 R	0986626792	S 7406 A	1457429465	S 3301 PO	1457429999	S 2070 A	1457433727	S 3373 A
0451104065	S 3241 R	0986626795	S 7A16 A	1457429469	S 3301 PO	1457431021	S 0201 N	1457433728	S 7279 A
0451104066	S 7600 R	0986626798	S 7A03 A	1457429470	S 1910 PO	1457431028	S 9091 N	1457433729	S 7280 A
0451104067	S 9400 R	0986626799	S 7484 A	1457429474	S 1910 PO	1457431085	S 6311 N	1457433730	S 7469 A
0451104508	S 3280 R	0986626810	S 3080 A	1457429490	S 0280 PO	1457431086	S 7411 N	1457433731	S 7343 A
0451104511		0986626871	S 3082 A	1457429493	S 0280 PO	1457431101	S 1411 N	1457433735	S 7183 A
(O/OR)	S 5603 R	0986627577	S 5603 R	1457429494	S 0280 PO	1457431144	S 0201 N	1457433748	S 3080 A
0451104511	S 5601 R	0986627624	S 5630 R	1457429515	S 3081 PO	1457431147	S 0101 N	1457433787	S 7482 A
0451104514	S 1270 R	0986628259	S 7F14 A	1457429525	S 6180 PO	1457431156	S 0201 N	1457433793	S 7A15 A
0451104520	S 5630 R	0986B03535		1457429529	S 6180 PO	1457431158	S 0101 N	1457433900	S 1970 A
0451104522	S 3003 DR	(BR)	S 2450 A	1457429540	S 3180 PO	1457431159	S 0201 N	1457433901	S 7213 A
0451105001	S 8600 R	0986TF0007	S 5011 PE	1457429545	S 6290 PO	1457431161	S 0101 N	1457433902	S 7361 A
0451105067	S 8600 R	0986TF0011	S 5013 PE	1457429546	S 6290 PO	1457431164	S 0101 N	1457433903	S 7286 A
0451105188	S 8600 R	0986TF0045	S 3280 R	1457429556	S 4380 PO	1457431168	S 0101 N	1457433904	S 7358 A
0451203001	S 0420 R	0986TF0182	S 7411 N	1457429557	S 4380 PO	1457431190	S 0201 N	1457434011	S 7111 NC
0451203002	S 5800 R	0986TF0187	S 6001 NE	1457429559	S 4380 PO	1457431202	S 1411 N	1457434050	S 5401 NR
0451203006	S 5700 R	0986TF0219	S 6009 NE	1457429570	S 5446 PO	1457431240	S 1411 N	1457434053	S 8500 NR
0451203007	S 3241 R	0986TF0248	S 5095 PE	1457429573	S 5446 PO	1457431250	S 1411 N	1457434057	S 5401 NR
0451203008	S 3102 R	0986TF0249	S 4461 NR	1457429590	S 1910 PO	1457431260	S 6311 N	1457434058	S 8500 NR
0451203009	S 9400 R	0986TF0253	S 7645 A	1457429595	S 7260 PO	1457431261	S 7411 N	1457434061	S 8500 NR
0451203010	S 0420 R	0986TF0254	S 4143 NR	1457429600	S 9490 PO	1457431270	S 1411 N	1457434062	S 5401 NR
0451203011	S 5700 R	0986TF0255	S 6010 NE	1457429606	S 9080 PO	1457431271	S 1411 N	1457434068	S 5401 NR
0451203012		0986TF0259	S 7B36 A	1457429619	S 5011 PE	1457431273	S 1411 N	1457434071	S 8500 NR
(O/OR)	S 5603 R	1457429027	S 0660 A	1457429624	S 5124 PE	1457431311	S 7411 N	1457434072	S 5401 NR
0451203012	S 5601 R	1457429033	S 8950 A	1457429625	S 5536 PO	1457431313	S 1411 N	1457434073	S 5401 NR
0451203058	S 5700 R	1457429034	S 4450 A	1457429629	S 2530 PO	1457431314	S 6311 N	1457434075	S 8500 NR
0451203059	S 3241 R	1457429035	S 0550 A	1457429645	S 8260 PO	1457431315	S 6311 N	1457434083	S 8500 NR
0451203061		1457429038	S 7002 A	1457429646	S 5124 PE	1457431320	S 1411 N	1457434087	S 7111 NC
(O/OR)	S 5603 R	1457429039	S 6450 A	1457429647	S 5099 PE	1457431324	S 6311 N	1457434093	S 8500 NR

**CROSS REFERENCES > CORRISPONDENZE >
CORRESPONDANCES > VERGLEICHNUMMERN > CRUCE DE REFERENCIAS**

1457434094	S 8500 NR	1987431187	S 3283 C	9455160352	S 5401 NR	F026402003	S 4006 NR	M1198	S 3442 C
1457434095	S 2610 NR	1987431188	S 3444 C	9457200230	S 4000 O	F026402017	S 9320 NR	M1204	S 3439 C
1457434096	S 2610 NR	1987431194	S 4346 CA	9457200400	S 0280 PO	F026402025	S 4143 NR	M1205	S 3081 C
1457434101	S 8500 NR	1987431197	S 3441 C	9457200420	S 4080 PO	F026402028	S 6011 NE	M1208	S 3279 C
1457434105	S 8501 NR	1987431198	S 3442 C	9457200780	S 3301 PO	F026402029	S 6016 NE	M1211	S 3448 C
1457434106		1987431204	S 3439 C	9457201810	S 3180 PO	F026402030	S 2220 NR	M1220	S 3446 C
(ALTRE/OTHER APPL.)	S 8500 NR	1987431205	S 3081 C	9457202360	S 6380 PO	F026402031	S 6146 NE	M2003	S 3023 C
1457434106		1987431208	S 3279 C	9457202800	S 6490 PO	F026402032	S 6024 NE	M2043	S 3059 C
(MAN)	S 4378 NR	1987431211	S 3448 C	9457208210	S 0530 PO	F026402036	S 1999 NR	M2150	S 3072 C
1457434107	S 8500 NR	1987431220	S 3446 C	9457208530	S 2530 PO	F026402038	S 4142 NR	M2151	S 3053 C
1457434108	S 2610 NR	1987431451	S 4260 CA	9457208540	S 7380 PO	F026402045	S 1071 B	M2152	S 3062 C
1457434110	S 8500 NR	1987431454	S 4225 CA	9457208570	S 6290 PO	F026402056	S 4107 NR	M2153	S 3066 C
1457434113	S 8500 NR	1987431458	S 4177 CA	9457209100	S 5536 PO	F026402065	S 4077 NR	M2213	S 3137 C
1457434119	S 8501 NR	1987432003	S 3023 C	9457216030	S 4380 PO	F026402070	S 6039 NE	M2258	S 3161 C
1457434123	S 9600 NR	1987432043	S 3059 C	9457216560	S 1080 PO	F026402071	S 4408 NR	N0506	S 4416 NR
1457434150	S 8500 NR	1987432150	S 3072 C	9457241270	S 4000 O	F026402094	S 8500 NR	N1028	S 9091 N
1457434153	S 2610 NR	1987432151	S 3053 C	9457241310	S 0300 O	F026402099	S 6072 NE	N1158	S 0101 N
1457434154		1987432152	S 3062 C	9457280400	S 8600 R	F026402104	S 4112 NR	N1159	S 0201 N
(CARTA APPROTOL./ROLLED PAPER)	S 5401 NR	1987432153	S 3066 C	9457280600	S 6100 R	F026402118	S 4461 NR	N1260	S 6311 N
1457434154		1987432213	S 3137 C	9457281800	S 9030 R	F026402127	S 8501 NR	N1261	S 7411 N
(CARTA PIEGHET./PLEATED PAPER)	S 4323 NR	1987432258	S 3161 C	9457282160	S 5800 R	F026402141	S 4120 NR	N1270	S 1411 N
1457434157	S 9600 NR	1987432343	S 4281 CA	9457282340	S 5600 R	F026402146	S 6147 NE	N1324	S 6311 N
1457434159	S 8500 NR	1987434001	S 7259 A	9457283080	S 7500 R	F026402155	S 6034 NE	N1325	S 7411 N
1457434177		1987435069	S 3315 C	9457283710	S 6100 R	F026402748	S 6044 NE	N1326	S 1411 N
(ALTRE/OTHER APPL.)	S 8500 NR	1987435535	S 4348 CA	9457429125	S 0530 PO	F026402798	S 4472 NR	N1707	S 6017 NE
1457434177		1987435581	S 4351 CA	986B03010	S 7A50 A	F026402838	S 4150 NR	N1710	S 6004 NE
(MAN)	S 4378 NR	74010	S 8500 NR	9879993000	S 1411 N	F026402840	S 4149 NR	N2003	S 4006 NR
1457434180	S 0810 NR	8472088950	S 0510 NR	9879993002	S 6181 N	F026404006	S 2234 Z	N2017	S 9320 NR
1457434200	S 8111 NC	9450732000	S 5700 R	9879993003	S 6311 N	F026404008	S 7B11 A	N2025	S 4143 NR
1457434201	S 7111 NC	9450732001	S 5700 R	9879993004	S 7411 N	F026407004	S 5603 R	N2028	S 6011 NE
1457434204	S 0710 NR	9450732005	S 1600 R	9879993013	S 9091 N	F026407024	S 5820 R	N2029	S 6016 NE
1457434205	S 0610 NR	9450732008	S 5600 R	9879993015	S 8381 NC	F026407042	S 5062 PE	N2030	S 2220 NR
1457434220	S 8111 NC	9450732012	S 7600 R	9879993016	S 1411 N	F026407045	S 5081 PE	N2031	S 6146 NE
1457434221	S 7111 NC	9450732013	S 8600 R	9879993023	S 4211 N	F026407051	S 5046 PE	N2032	S 6024 NE
1457434252	S 3010 N	9450732014	S 1600 R	9879993036	S 7111 NC	F026407059	S 5900 PO	N2036	S 1999 NR
1457434281	S 1410 NR	9450732018	S 0700 R	9879993039	S 0510 NR	F026407060	S 5903 PO	N2038	S 4142 NR
1457434293	S 4408 NR	9450732019	S 8310 R	A310	S 3023 C	F026407083	S 0920 R	N2045	S 1071 B
1457434294	S 5020 NR	9450732030	S 1600 R	A405	S 3059 C	F026407100	S 5181 PE	N2056	S 4107 NR
1457434295	S 4378 NR	9450732032	S 3003 DR	A425	S 3072 C	F026407101	S 0620 R	N2065	S 4077 NR
1457434331	S 9600 NR	9450733000	S 0710 NR	A755	S 3053 C	F026407110	S 8137 RH	N2070	S 6039 NE
1457434402	S 0999 NR	9450733001	S 0610 NR	A756	S 3062 C	F026407112	S 5159 PE	N2071	S 4408 NR
1457434407	S 0310 NR	9451080060	S 8500 NR	A757	S 3066 C	F026407117	S 3592 R	N2094	S 8500 NR
1457434408	S 9960 NC	9451160001	S 2450 A	D0012	S 4401 U	F026407118	S 2234 Z	N2099	S 6072 NE
1457434415	S 9600 NR	9451160002	S 5270 A	D0230	S 4401 U	F026407119	S 5904 PO	N2104	S 4112 NR
1457434419	S 4337 NR	9451160003	S 0150 A	D302	S 2610 NR	F026407120	S 5044 PE	N2118	S 4461 NR
1457434421	S 0712 NR	9451160004	S 0450 A	D505	S 9600 NR	F026407129	S 0620 R	N2127	S 8501 NR
1457434428	S 4341 NR	9451160005	S 6550 A	D6002	S 4402 U	F026407136	S 8310 R	N2141	S 4120 NR
1457434432		9451160006	S 2950 A	D6033	S 4405 U	F026407191	S 5235 PE	N2155	S 6034 NE
(ALTRE/OTHER APPL.)	S 5400 NR	9451160008	S 0950 A	D6042	S 4401 U	F026407217	S 5102 PE	N2748	S 6044 NE
1457434432		9451160009	S 0840 A	D701	S 8500 NR	F026408903		N2798	S 4472 NR
(IVECO)	S 4329 NR	9451160010	S 0270 A	D800	S 7600 NR	(N.10 FILTR/FILTERS)	S 1600 R	N2840	S 4149 NR
1457434437	S 2320 NR	9451160012	S 2650 A	F00BH40012	S 4401 U	F026408904		N4050	S 5401 NR
1457434439	S 4444 NR	9451160014	S 3570 A	F00BH40017	S 4401 U	(N.10 FILTR/FILTERS)	S 7600 R	N4077	S 1013 B
1457434446	S 9320 NR	9451160016	S 0650 A	F00BH40230	S 4401 U	G01	S 7111 NC	N4105	S 8501 NR
1457434447	S 4378 NR	9451160018	S 8950 A	F026400022	S 7390 A	G02		N4106	
1457434451	S 4444 NR	9451160026	S 0060 A	F026400055	S 3340 A	(MAN)	S 4378 NR	(MAN)	S 4378 NR
1457434900	S 7111 NC	9451160028	S 0940 A	F026400067	S 8502 A	G02		N4106	
1457434901	S 7111 NC	9451160030	S 0550 A	F026400073	S 7627 A	(ALTRE/OTHER APPL.)	S 8500 NR	(ALTRE/OTHER APPL.)	S 8500 NR
1457434903	S 7111 NC	9451160032	S 7002 A	F026400076	S 7546 A	G03	S 8111 NC	N4123	S 9600 NR
1457434904	S 7111 NC	9451160034	S 6370 A	F026400077	S 7544 A	G04	S 9091 N	N4150	S 8500 NR
1457434905	S 7111 NC	9451160036	S 8450 A	F026400085	S 6870 A	G09	S 7600 NR	N4153	S 2610 NR
1457434909	S 7111 NC	9451160038	S 4940 A	F026400086	S 7284 A	H03	S 1600 R	N4154	
1457434910	S 7111 NC	9451160042	S 7839 A	F026400088	S 7639 A	H07	S 6100 R	(CARTA APPROTOL./ROLLED PAPER)	S 5401 NR
1457436002	S 4402 U	9451160044	S 1070 A	F026400145	S 7643 A	H11	S 2030 R	N4154	
1457436006	S 4402 U	9451160050	S 6450 A	F026400189	S 7695 A	H33	S 5630 R	(CARTA PIEGHET./PLEATED PAPER)	S 4323 NR
1457436033	S 4405 U	9451160052	S 0050 A	F026400190	S 7A44 A	H47	S 1270 R	N4159	S 8500 NR
1457436042	S 4401 U	9451160054	S 9990 A	F026400197	S 7576 A	H54	S 3280 R	N4180	S 0810 NR
1457437001	S 5013 PE	9451160056	S 7987 A	F026400211	S 7F16 A	H61	S 3102 R	N4200	S 8111 NC
1487434901	S 7259 A	9451730701	S 0660 A	F026400245	S 7694 A	H62		N4201	S 7111 NC
1986452001	S 5600 R	9451730734	S 1506 A	F026400248	S 7637 A	(O/OP)	S 5603 R	N4205	S 0610 NR
1986452002	S 5600 R	9451732600	S 3301 PO	F026400249	S 7573 A	H62	S 5601 R	N4281	S 1410 NR
1986452003	S 1600 R	9451732602	S 6180 PO	F026400252	S 7516 A	H64	S 7510 O	N4293	S 4408 NR
1986452005	S 3102 R	9451732603	S 3081 PO	F026400253	S 7A14 A	H65	S 3003 DR	N4294	S 5020 NR
1987430052	S 0050 A	9451732606	S 0580 PO	F026400257	S 7A23 A	L205	S 7940 A	N4295	S 4378 NR
1987431003	S 3023 C	9451733000	S 7111 NC	F026400259	S 3541 A	L309	S 0660 A	N4331	S 9600 NR
1987431043	S 3059 C	9451733001	S 7200 N	F026400272	S 7B45 A	L503	S 2810 A	N4402	S 0999 NR
1987431150	S 3072 C	9451733003	S 5401 NR	F026400282	S 7B10 A	L512	S 9240 A	N4407	S 0310 NR
1987431151	S 3053 C	9451733006	S 8111 NC	F026400284	S 7F13 A	M1154	S 3221 C	N4408	S 9960 NC
1987431152	S 3062 C	9451733100	S 6911 N	F026400288	S 7383 A	M1163	S 3165 C	N4419	S 4337 NR
1987431153	S 3066 C	9451733300	S 4211 N	F026400307	S 0VGT A	M1166	S 3078 C	N4421	S 0712 NR
1987431154	S 3221 C	9455160084	S 3010 N	F026400314	S 7423 A	M1167	S 3089 C	N4428	S 4341 NR
1987431157	S 3054 C	9455160246	S 7111 NC	F026400321	S 7645 A	M1169	S 3139 C	N4432	
1987431163	S 3165 C	9455160251	S 2610 NR	F026400327	S 7A11 A	M1172	S 3289 C	(ALTRE/OTHER APPL.)	S 5400 NR
1987431166	S 3078 C	9455160317	S 8500 NR	F026400330	S 7608 A	M1173	S 3217 C	N4432	
1987431167	S 3089 C	9455160326	S 8110 NR	F026400483	S 7E35 A	M1187	S 3283 C	(IVECO)	S 4329 NR
1987431169	S 3139 C	9455160328	S 8111 NC	F026400536	S 7B10 A	M1188	S 3444 C	N4437	S 2320 NR
1987431172	S 3289 C	9455160329	S 0101 N	F026400563	S 7C16 A	M1194	S 4346 CA	N4439	S 4444 NR
1987431173	S 3217 C	9455160330	S 0201 N	F026400601	S 7D41 A	M1197	S 3441 C	N4446	S 9320 NR

B



**CROSS REFERENCES > CORRISPONDENZE >
CORRESPONDANCES > VERGLEICHNUMMERN > CRUCE DE REFERENCIAS**

N4447	S 4378 NR	P3357	S 3102 R	S0245	S 7694 A	S9874	S 0050 A	1A-3479	S 0810 NR
N4451	S 4444 NR	P4010	S 0900 R	S0249	S 7573 A	S9882	S 7107 A	1B-7716	S 7033 A
N5930	S 4416 NR	P4013	S 3010 R	S0252	S 7516 A	S9885	S 7165 A	1M-3333	S 7002 A
N6174	S 7600 NR	P4015	S 8600 R	S0253	S 7A14 A	S9886	S 7839 A	1N-4864	S 7308 A
N6267	S 7600 NR	P4018	S 2003 DR	S0257	S 7A23 A	S9887	S 2850 A	1N-8164	S 3450 A
N6288	S 4391 NR	P4063	S 5600 R	S0259	S 3541 A	S9888	S 7186 A	1N-8165	S 5450 A
N6295	S 5427 GC	P4065	S 3241 R	S0282	S 7B10 A	S9891	S 7288 A	1P-2299	S 0810 NR
N6374	S 4391 NR	P4066	S 7600 R	S0284	S 7F13 A	S9899	S 1670 A	1P-5415	S 7040 A
N9209	S 6481 N	P4067	S 9400 R	S0288	S 7383 A	S9932	S 0650 A	1P-6450	
N9214	S 6181 N	P5067	S 8600 R	S0307	S 0VGT A	S9933	S 2950 A	(ESTERNA/OUTER) +	S 7033 A
N9224	S 8381 NC	P5188	S 8600 R	S0314	S 7423 A	S9941	S 4940 A	1P-7716	S 7033 A
N9354	S 2162 N	P7004	S 5603 R	S0321	S 7645 A	S9946	S 0950 A	1P-7730	
N9359	S 2161 N	P7024	S 5820 R	S0327	S 7A11 A	S9950	S 2450 A	(ESTERNA/OUTER) +	S 7008 A
N9655	S 6001 NE	P7042	S 5062 PE	S0330	S 7608 A	S9965	S 5270 A	1P-7730	
N9675	S 6710 NR	P7045	S 5081 PE	S0536	S 7B10 A	S9966	S 2650 A	(INTERNA/INNER) +	S 7041 A
N9676	S 8110 NR	P7051	S 5046 PE	S0563	S 7C16 A	S9968	S 7987 A	1P-8482	S 7041 A
N9681	S 0710 NR	P7059	S 5900 PO	S0601	S 7D41 A	S9969	S 1050 A	1P-8483	S 7008 A
O136	S 3257 R	P7060	S 5903 PO	S2108	S 0660 A	S9975	S 0450 A	1R-0511	S 0810 NR
O200	S 0130 R	P7083	S 0920 R	S2138	S 1506 A	S9979	S 7281 A	1R-0658	S 0900 R
O219	S 6100 R	P7100	S 5181 PE	S2187	S 2070 A	S9980	S 1070 A	1R-0711	S 0810 NR
O231	S 1270 R	P7101	S 0620 R	S2188	S 8570 A	S9985	S 6370 A	1R-0734	S 7600 R
O232	S 5700 R	P7112	S 5159 PE	S2192	S 7998 A	S9991	S 3570 A	1R-0739	S 0900 R
O307	S 2329 R	P7117	S 3592 R	S2193	S 7170 A	S9998	S 9570 A	1R-0740	S 0810 NR
O313	S 1600 R	P7118	S 2234 Z	S3042	S 7970 A	Z4006	S 2234 Z	1R-1807	S 0900 R
O314	S 1600 R	P7120	S 5044 PE	S3200	S 0840 A	Z4008	S 7B11 A	1S-1479	
O407	S 7330 R	P7129	S 0620 R	S3202	S 8940 A	Z8259	S 7F14 A	(ESTERNA/OUTER) +	S 8350 A
O414	S 0122 O	P7136	S 8310 R	S3203	S 2840 A			1S-2373	
O516	S 3102 R	P7191	S 5235 PE	S3204	S 7550 A			(ESTERNA/OUTER) +	S 8350 A
O530	S 2030 R	P7217	S 5102 PE	S3205	S 2370 A			1W-3300	S 0900 R
O626		P8903		S3231	S 9240 A			1W-3636	S 7314 A
(O/OR)	S 5603 R	(N.10 FILTRI/FILTERS)	S 1600 R	S3332	S 7356 A			1W-3637	S 7315 A
O626	S 5601 R	P8904		S3560	S 7383 A			1W-7399	S 1910 PO
O702	S 7510 O	(N.10 FILTRI/FILTERS)	S 7600 R	S3562	S 7214 A			1W-8633	S 0810 NR
O810	S 2510 O	P9105	S 3081 PO	S3564	S 7428 A			222-9020	S 7506 A
P0003	S 4120 R	P9107	S 5005 PE	S3601	S 3030 A			222-9021	S 7507 A
P0004	S 1220 R	P9116	S 5013 PE	S3610	S 3940 A			245-3818	S 7558 A
P1184	S 0120 R	P9117	S 3180 PO	S3611	S 7129 A			245-3819	S 7559 A
P1207	S 3292 R	P9125	S 0530 PO	S3625	S 1540 A			256-8753	S 4478 NR
P2001	S 5600 R	P9128	S 5006 PE	S3626	S 3059 A			2M-0934	S 7002 A
P2003	S 1600 R	P9130	S 2530 PO	S3631	S 4770 A			2M-2626	S 7002 A
P2005	S 3102 R	P9137	S 5016 PE	S3632	S 8840 A			2M-5522	S 7023 A
P3001	S 0420 R	P9165	S 8790 PO	S3634	S 7945 A			2M-6446	S 7023 A
P3001/1	S 9030 R	P9170	S 0122 O	S3649	S 0070 A			2M-7941	S 7023 A
P3002	S 5800 R	P9174	S 5613 PO	S3651	S 7187 A			2M-8549	S 7002 A
P3004	S 2329 R	P9175	S 4000 O	S3668	S 2570 A			2M-8708	S 7023 A
P3010	S 0420 R	P9180	S 0300 O	S3670	S 7161 A			2M-9282	S 7002 A
P3012		P9265	S 2510 O	S3671	S 7160 A			2M-9285	S 7002 A
(O/OR)	S 5603 R	P9270	S 5446 PO	S3672	S 4370 A			2M-934	S 7002 A
P3012	S 5601 R	P9271	S 5026 PE	S3678	S 7138 A			2P-1482	
P3029	S 1270 R	P9274	S 7510 O	S3703	S 3082 A			(ESTERNA/OUTER) +	S 7033 A
P3033	S 2030 R	P9276	S 5381 PO	S3721	S 7638 A			2P-4004	S 0900 R
P3058	S 5700 R	P9277	S 3631 PO	S3727	S 3373 A			2S-0555	S 7002 A
P3060	S 6100 R	P9278	S 5095 PE	S3728	S 7279 A			2S-0648	S 7023 A
P3074	S 7500 R	P9413	S 6490 PO	S3729	S 7280 A			2S-555	S 7002 A
P3077	S 0900 R	P9441	S 6380 PO	S3730	S 7469 A			2S-5648	S 7023 A
P3087	S 1563 R	P9493	S 0280 PO	S3731	S 7343 A			2S-6605	S 7002 A
P3087		P9494	S 0280 PO	S3735	S 7183 A			2S-6610	S 7023 A
(ALTRE/OTHER APPL.)	S 1560 R	P9559	S 4380 PO	S3748	S 3080 A			2S-9982	S 7002 A
P3101	S 1380 R	P9590	S 1910 PO	S3787	S 7482 A			2W-3236	S 8111 NC
P3108	S 7330 R	P9600	S 9490 PO	S3793	S 7A15 A			2Y-8096	S 0900 R
P3125	S 3280 R	P9606	S 9080 PO	S3900	S 1970 A			378-3187	S 4405 U
P3152	S 0700 R	P9619	S 5011 PE	S3901	S 7213 A			3I-0105	S 7314 A
P3154	S 1600 R	P9625	S 5536 PO	S3902	S 7361 A			3I-0215	S 7308 A
P3178	S 8310 R	P9629	S 2530 PO	S3903	S 7286 A			3I0241	S 7607 A
P3201	S 3003 DR	P9646	S 5124 PE	S6755	S 7562 A			3S-1812	
P3208	S 3275 R	P9647	S 5099 PE	S6758	S 7284 A			(ESTERNA/OUTER) +	S 8350 A
P3218	S 7600 R	P9676	S 8110 NR	S6763	S 7573 A			3S-2298	
P3219	S 3257 R	P9732	S 5133 PE	S6768	S 7444 A			(ESTERNA/OUTER) +	S 8350 A
P3220	S 5802 R	P9735	S 8260 PO	S6778	S 7A59 A			3S-4737	
P3223	S 8310 R	P9740	S 7261 PO	S6779	S 7544 A			(ESTERNA/OUTER) +	S 7039 A
P3226	S 5800 R	P9750	S 1080 PO	S6780	S 7546 A			3S-4737	
P3227/1	S 5800 R	P9820	S 3081 PO	S6784	S 7639 A			(INTERNA/INNER) +	S 7040 A
P3228	S 2030 R	R1451	S 4260 CA	S6789	S 9870 A			3S-4745	S 7040 A
P3228/1	S 3497 R	R1454	S 4225 CA	S6790	S 7404 A			3S-4746	S 7039 A
P3234/1	S 5800 R	R1458	S 4177 CA	S6792	S 7406 A			3S-9606	S 7002 A
P3238	S 5630 R	R2343	S 4281 CA	S6795	S 7A16 A			3Y-0900X	S 0900 R
P3251		R5535	S 4348 CA	S6798	S 7A03 A			3Y-900X	S 0900 R
(CHRYSLER, JEEP A.M.C.)	S 1600 R	S0022	S 7390 A	S6799	S 7484 A			470-7408	S 6043 NE
P3252	S 3280 R	S0055	S 3340 A	S9033	S 8950 A			476-2687	S 6044 NE
P3253		S0067	S 8502 A	S9035	S 0550 A			4M-3803	S 7010 A
(O/OR)	S 5603 R	S0073	S 7627 A	S9080	S 2810 A			4N-6274	
P3253	S 5601 R	S0076	S 7546 A	S9779	S 7185 A			(ESTERNA/OUTER) +	S 7033 A
P3257	S 8310 R	S0077	S 7544 A	S9780	S 7168 A			4N-6275	
P3274	S 6100 R	S0085	S 6870 A	S9794	S 0850 A			(ESTERNA/OUTER) +	S 7033 A
P3289	S 3425 R	S0086	S 7284 A	S9822	S 1940 A			4N-9164	S 3450 A
P3343	S 4402 R	S0088	S 7639 A	S9824	S 1450 A			4W-4840	S 1910 PO
P3346	S 5601 R	S0189	S 7695 A	S9845	S 3330 A			4W-4926	S 1910 PO
P3353	S 0130 R	S0190	S 7A44 A	S9854	S 5250 A			5A-6717	S 0810 NR

BUESSING	SOFIMA	
7633141101	S 8790 PO	
801150215	S 0201 N	
801150237	S 1411 N	
801155191	S 7028 A	
801155196	S 7987 A	
801160154	S 0201 N	
801160157	S 1411 N	
801195128	S 0530 PO	
801195131	S 1910 PO	
801195135	S 7107 A	
801195973	S 0530 PO	
807200756	S 8790 PO	
90801155191	S 7028 A	
90801155196	S 7987 A	
90801195131	S 1910 PO	
CARRIER	SOFIMA	
11649	S 8381 NC	
11667	S 6481 N	
11690	S 6481 N	
21026	S 6380 PO	
21043	S 6380 PO	
210811001	S 3446 C	
2530053	S 1600 R	
2911649	S 8381 NC	
291170504	S 6481 N	
291170562	S 6481 N	
2921026	S 6380 PO	
295011008	S 1411 N	
295011009	S 1411 N	
3000302	S 0810 NR	
300030200	S 0810 NR	
3000323	S 0420 R	
300032300	S 0420 R	
300032300P12	S 0420 R	
3021026	S 6380 PO	
66U12155	S 0840 A	
66U12901	S 0201 N	
66U12911	S 7411 N	
940768	S 7111 NC	
941070	S 6650 A	
941392	S 8111 NC	
CATERPILLAR	SOFIMA	
106-3969	S 7A35 A	
106-3973	S 7A36 A	
110-6326	S 7356 A	
110-6326E	S 7356 A	
129-0373	S 4159 NR	
131-8902	S 7356 A	
132-7168	S 7A35 A	
133-5673	S 4159 NR	
142-1339	S 9870 A	
142-1340	S 7421 A	
142-1403	S 7422 A	
142-1404	S 7408 A	
156-9328	S 7607 A	

**CROSS REFERENCES > CORRISPONDENZE >
CORRESPONDANCES > VERGLEICHNUMMERN > CRUCE DE REFERENCIAS**

5B-5937	S 1910 PO	9F-6426	S 1910 PO	DN323		MA118	S 1506 A	MA526	S 2450 A
5C-1791	S 0420 R	9F-6427	S 1910 PO	(ALTRE/OTHER APPL.)	S 8500 NR	MA124	S 2810 A	MA527	S 5270 A
5M-1840	S 7023 A	9F-6430	S 1910 PO	DN829	S 7600 NR	MA129	S 0660 A	MA529	S 3570 A
5M-4118	S 7002 A	9F-6700	S 1910 PO	DN873	S 9960 NC	MA1366	S 3082 A	MA530	S 2070 A
5S-0484	S 1910 PO	9L-2047	S 9990 A	DN876	S 0999 NR	MA1401	S 1970 A	MA531	S 2650 A
5S-1225		9L-3420	S 9990 A	DN916	S 4329 NR	MA1402	S 7409 A	MA532	S 0070 A
(ESTERNA/OUTER) +	S 7039 A	9M-1030	S 7002 A	DN993	S 4391 NR	MA1403	S 7357 A	MA533	S 7974 A
5S-1225		9M-4798		DN993/T	S 5427 GC	MA1404	S 7284 A	MA534	S 7839 A
(INTERNA/INNER) +	S 7040 A	(ESTERNA/OUTER) +	S 8350 A	DN994	S 4408 NR	MA1405	S 7008 A	MA535	S 0950 A
5S-4282	S 7039 A	9M-5511		DN997	S 5020 NR	MA1406	S 7033 A	MA536	S 2370 A
5S-484	S 1910 PO	(ESTERNA/OUTER) +	S 8350 A	DN999	S 0310 NR	MA1412	S 7356 A	MA537	S 0550 A
5S-5484	S 1910 PO	9M-6372	S 7002 A	DNW1909	S 4408 NR	MA1412/A	S 7356 A	MA538	S 0050 A
5W-2716	S 7670 A	9M-6373	S 7002 A	DNW1992	S 1H20 NR	MA1413	S 3541 A	MA539	S 4940 A
5W-2717	S 7017 A	9M-6377	S 7023 A	DNW2507	S 4121 NR	MA1418	S 7970 A	MA541	S 0060 A
5W-3394	S 5400 NR	9M-6379	S 7023 A	DNW2509	S 4158 NR	MA1419	S 7347 A	MA542	S 7170 A
5W-3407	S 9030 R	9M-9377	S 7023 A	DNW2510	S 4138 NR	MA142	S 5060 A	MA543	S 8950 A
5W-5887	S 7600 R	9N-5860	S 0510 NR	DNW2511	S 4157 NR	MA1420	S 7345 A	MA544	S 2950 A
5W-5889	S 0850 A	9S-2598		DO1806	S 3292 R	MA1421	S 7421 A	MA550	S 0270 A
5W-5890	S 2850 A	(ESTERNA/OUTER) +	S 7039 A	DO1817	S 3425 R	MA1422	S 7422 A	MA551	S 6370 A
5W-6017	S 8600 R	9S-2598		DO1819	S 3102 R	MA1423	S 7337 A	MA555	S 2840 A
5W-6081	S 7111 NC	(INTERNA/INNER) +	S 7040 A	DO1835	S 5820 R	MA1424	S 7405 A	MA557	S 8840 A
5Z-1221		9Y-4402	S 4510 NR	DO1838	S 0920 R	MA1425	S 7221 A	MA560	S 7987 A
(INTERNA/INNER) +	S 8270 A	9Y-4449	S 5600 R	DO1843	S 0620 R	MA1427	S 7423 A	MA561	S 9990 A
5Z-1221		9Y-4456	S 3301 PO	DO209	S 5630 R	MA1428	S 7564 A	MA562	S 1070 A
(ESTERNA/OUTER) +	S 6270 A	9Y-4506	S 1270 R	DO218	S 2030 R	MA1429	S 7565 A	MA564	S 7550 A
676987	S 7111 NC	9Y-6803	S 7024 A	DO223		MA1430	S 7222 A	MA566	S 2850 A
6A-6110V	S 0950 A	9Y-6804	S 2840 A	(FORD)	S 1270 R	MA1431	S 7371 A	MA567	S 1050 A
6I-6582	S 8940 A	9Y-6805	S 8940 A	DO223		MA1432	S 7A15 A	MA568	S 8940 A
6L-3313	S 7010 A	9Y-6806	S 4370 A	(ALTRE/OTHER APPL.)	S 1600 R	MA1433	S 7F15 A	MA570	S 6650 A
6L-7440	S 0810 NR	9Y-6809	S 4370 A	DO223		MA1436	S 7A17 A	MA573	S 5450 A
6L-7543	S 0060 A	9Y-6820	S 8950 A	(SCANIA)	S 2329 R	MA1438		MA574	S 7004 A
6M-3217	S 0060 A	9Y-6827	S 7945 A	DO223		(ALTRE/OTHER APPL.)	S 7637 A	MA575	S 3450 A
6N-3784	S 0810 NR	9Y-6828	S 6550 A	(VOLVO)	S 3257 R	MA1438		MA577	S 7165 A
6N-6064	S 4270 A	9Y-6834	S 0940 A	DO225		(SCANIA)	S 7A50 A	MA578	S 7278 A
6N-6071	S 5450 A	9Y-6838	S 0060 A	(NISSAN)	S 3102 R	MA1441	S 7625 A	MA579	S 6870 A
6N-6072	S 3450 A	9Y-6839	S 0840 A	DO225		MA1444	S 7608 A	MA581	S 7279 A
6Z-1489		9Y-6840	S 2950 A	(ALTRE/OTHER APPL.)	S 5600 R	MA1445	S 7575 A	MA585	S 7280 A
(ESTERNA/OUTER) +	S 7039 A	9Y-6841	S 8950 A	DO225/B		MA1446	S 7431 A	MA586	S 7638 A
6Z-1489		9Y-6843	S 2370 A	(ALTRE/OTHER APPL.)	S 9400 R	MA1447	S 7432 A	MA587	S 7A22 A
(INTERNA/INNER) +	S 7040 A	9Y-7803	S 2850 A	DO225/C		MA1449	S 7651 A	MA588	S 0840 A
7C-8300	S 1005 A	9Y-7806	S 9990 A	(O/OR) (VAG, VOLVO)	S 5603 R	MA1450	S 7573 A	MA614	S 9240 A
7C-8301	S 6940 A	9Y-7808	S 0150 A	DO225/C		MA1452	S 7506 A	MA629	S 7138 A
7C-8302	S 7945 A	9Y-7811	S 6550 A	(VAG, VOLVO)	S 5601 R	MA1453	S 7372 A	MA641	S 1540 A
7C-8303	S 8840 A	9Y-7813	S 0850 A	DO225/C		MA1455	S 7615 A	MA669	S 3330 A
7E-0975	S 0850 A	9Y-7814	S 7170 A	(ALTRE/OTHER APPL.)	S 5600 R	MA1457	S 7214 A	MA700	S 7160 A
7M-0926	S 7002 A			DO225/D	S 5603 R	MA1458	S 7695 A	MA701	S 4370 A
7M-1045	S 7023 A			DO227	S 6100 R	MA1465	S 7A24 A	MA705	S 7144 A
7M-2045	S 7023 A			DO228	S 8310 R	MA1467	S 7342 A	MA706	S 7028 A
7M-2654	S 7023 A			DO236	S 7600 R	MA1474	S 0VGT A	MA707	S 7024 A
7M-3800	S 1910 PO	DA990	S 8410 AR	DE220	S 7259 A	MA1475	S 7482 A	MA715	S 7992 A
7M-4862		DE2202	S 7393 A	DE2202	S 7344 A	MA1486	S 7639 A	MA718	S 7011 A
(ESTERNA/OUTER) +	S 8350 A	DE2203	S 7344 A	DE2203	S 7A66 A	MA1487	S 3373 A	MA719	S 7017 A
7M-5979	S 7023 A	DE2204	S 7A66 A	DE2204	S 7A66 A	MA1488	S 7217 A	MA721	S 4450 A
7M-7176	S 1910 PO	DF207	S 3003 DR	DF207	S 3003 DR	(DAF, IVECO, KHD)	S 7218 A	MA722	S 7023 A
7M-8903	S 7023 A	DF887	S 5003 DR	DF887	S 5003 DR	DO265	S 8760 A	MA723	S 7010 A
7M-9045	S 8350 A	DF888	S 3003 DR	DF888	S 3003 DR	(ALTRE/OTHER APPL.)	S 7546 A	MA724	S 6940 A
7M-926	S 7002 A	DF889	S 3003 DR	DF889	S 3003 DR	DO269	S 7619 A	MA725	S 2570 A
7N-1308	S 7041 A	DF890	S 2003 DR	DF890	S 2003 DR	DO270	S 7616 A	MA726	S 1450 A
7S-1224		DF891	S 5003 DR	DF891	S 5003 DR	DO278	S 7383 A	MA730	S 7945 A
(ESTERNA/OUTER) +	S 8350 A	DN1904	S 4416 NR	DN1904	S 4416 NR	DO288	S 3340 A	MA731	S 3940 A
7S-1778		DN1908	S 2320 NR	DN1908	S 2320 NR	DO294	S 1380 R	MA3402	S 8570 A
(ESTERNA/OUTER) +	S 8350 A	DN1913	S 1410 NR	DN1913	S 1410 NR	DO298	S 0420 R	MA3403	S 7670 A
7S-3642		DN1925	S 4107 NR	DN1925	S 4107 NR	DO300	S 0900 R	MA3406	S 7548 A
(ESTERNA/OUTER) +	S 7039 A	DN1926	S 0712 NR	DN1926	S 0712 NR	DO478	S 5549 PO	MA3407	S 7940 A
7S-3642		DN1962	S 2220 NR	DN1962	S 2220 NR	DO5505	S 4120 R	MA3409	S 7129 A
(INTERNA/INNER) +	S 7040 A	DN1963	S 4395 NR	DN1963	S 4395 NR	DO5513	S 3288 R	MA3414	S 7277 A
7W-2326	S 0420 R	DN1983	S 4323 NR	DN1983	S 4323 NR	DO5517	S 4402 R	MA3416	S 7286 A
7W-2327	S 9400 R	DN220	S 7111 NC	DN220	S 7111 NC	DO812	S 3280 R	MA3422	S 7186 A
7W-2328	S 1380 R	DN221	S 0610 NR	DN221	S 0610 NR	DO814	S 3260 R	MA3425	S 7576 A
7W-5313	S 7008 A	DN222	S 8111 NC	DN222	S 8111 NC	DO821	S 9710 R	MA3426	S 9870 A
7W-5316	S 8350 A	DN244	S 2610 NR	DN244	S 2610 NR	DO822	S 9610 R	MA3431	S 7285 A
7W-5495	S 7033 A	DN246	S 0510 NR	DN246	S 0510 NR	DO840	S 7500 R	MA3436	S 2670 A
7W-5495E	S 7033 A	DN249	S 3010 N	DN249	S 3010 N	DO852	S 0130 R	MA3440	S 7142 A
7W-7424	S 8840 A	DN253	S 9600 NR	DN253	S 9600 NR	DO874	S 9030 R	MA3443	S 1005 A
7W-7425	S 1005 A	DN256	S 5400 NR	DN256	S 5400 NR	DO875	S 1220 R	MA384	S 7143 A
8L-5897		DN258	S 0710 NR	DN258	S 0710 NR	DO879	S 3280 R	MA389	S 0050 A
(ESTERNA/OUTER) +	S 5450 A	DN264	S 0810 NR	DN264	S 0810 NR	DO886	S 3257 R	MA420	S 7185 A
8L-5897		DN2705	S 4077 NR	DN2705	S 4077 NR	DO918	S 1563 R	MA422	S 6270 A
(INTERNA/INNER) +	S 3450 A	DN2709	S 4112 NR	DN2709	S 4112 NR	DO933		MA430	S 8270 A
8M-1907	S 7023 A	DN273	S 4510 NR	DN273	S 4510 NR	(IRENAULT VI, VOLVO)	S 4120 R	MA431	S 1670 A
8M-9921	S 7002 A	DN297	S 8110 NR	DN297	S 8110 NR	DOC2211	S 5900 PO	MA506	S 5250 A
8N-4301	S 1910 PO	DN301		DN301		DOC2213	S 5903 PO	MA510	S 5650 A
8N-5313	S 7008 A	(FORD, OPEL, VAUXHALL)	S 8501 NR	MA1034	S 3030 A		S 3030 A	MA511	S 9570 A
8N-5316	S 8350 A	DN301		MA1049	S 3059 A		S 3059 A	MA519	S 7614 A
8N-5495	S 7033 A	(ALTRE/OTHER APPL.)	S 8500 NR	MA1066	S 3080 A		S 3080 A	MA520	S 7343 A
8S-9476		DN306	S 6710 NR	MA1078	S 7544 A		S 7544 A	MA521	S 7358 A
(ESTERNA/OUTER) +	S 8350 A	DN323		MA1108	S 0760 A		S 0760 A	MA523	S 7168 A
8U-2601	S 7170 A	(MAN)	S 4378 NR	MA1140	S 5812 A		S 5812 A	MA525	S 1307 A



**CROSS REFERENCES > CORRISPONDENZE >
CORRESPONDANCES > VERGLEICHNUMMERN > CRUCE DE REFERENCIAS**

MA797	S 7288 A	ML479/A	S 5013 PE	1640920	S 7A16 A	695633	S 0950 A	P10-8674	S 4370 A
MA798	S 7161 A	ML48	S 7380 PO	1640921	S 7573 A	699387	S 7259 A	P10-9086	S 4270 A
MA799	S 7338 A	ML480	S 8790 PO	1643070	S 5081 PE	754718	S 7428 A	P10-9155	S 5450 A
MA800	S 7187 A	ML483	S 9490 PO	1643072	S 5904 PO	905480	S 3081 PO	P10-9159	S 3450 A
MA801	S 7474 A	ML486		1643080	S 6024 NE	ACHD040	S 7A17 A	P10-9200	S 6270 A
MA802	S 1940 A	(MERCEDES BENZ 102 180 01 09)	S 9080 PO	1644642	S 7F15 A	APUC43	S 7F15 A	P11-0544	S 6650 A
MA809	S 7183 A	ML495	S 5124 PE	1649425	S 4403 U	CBU1124	S 3497 R	P11-0545	S 0840 A
MB007	S 1013 B	ML497	S 2530 PO	1657522	S 7A16 A	CBU2676	S 3497 R	P11-0546	S 2950 A
MB016	S 1028 B	ML499	S 5636 PO	1657523	S 7573 A	MAK1629	S 7479 A	P11-0547	S 2950 A
MB7	S 1013 B	ML61	S 4380 PO	1658991	S 3062 C			P11-0551	S 0060 A
MBNA007	S 1013 B	ML77	S 3180 PO	1659691	S 3092 C			P11-0554	S 2370 A
MBNA016	S 1028 B	ML82	S 7510 O	1664524	S 7A59 A			P11-0555	S 4370 A
MC1245	S 3023 C	NC2011	S 3023 C	1667999	S 7F15 A			P11-0556	S 0150 A
MG007	S 7411 N	NC2038	S 3059 C	1672463	S 7F15 A			P11-0557	S 8940 A
MG010	S 4211 N	NC2043	S 3053 C	1674458	S 4403 U			P11-0558	S 6550 A
MG010/F	S 7200 N	NC2059	S 3072 C	1679397	S 7650 A			P11-0559	S 2840 A
MG011	S 6911 N	NC2125CA	S 4281 CA	1681575	S 7F14 A			P11-0560	S 7945 A
MG019	S 4311 N	NC2160	S 3089 C	1683353	S 6089 NE	DBA-3745	S 7F22 A	P11-1809	S 9990 A
MG020	S 8381 NC	NC2167CA	S 4225 CA	1686587	S 7A86 A	DBA-3746	S 7F21 A	P11-1809	S 9990 A
MG029	S 6181 N	NC2313	S 3161 C	1699168	S 6024 NE	E50-0150	S 0840 A	P11-2031	S 0940 A
MG034	S 6481 N	NC2319	S 3078 C	1706238	S 0620 R	E50-0160	S 2950 A	P11-2339	S 8950 A
MG038	S 9091 N	NC2345	S 3137 C	1726060	S 7573 A	E50-0170	S 8950 A	P11-2830	S 7011 A
MG052	S 6311 N	NC2345CA	S 4161 CA	1782420	S 7A66 A	E50-0190	S 0060 A	P11-3093	S 0060 A
MG07	S 7411 N	NC2352	S 3066 C	1784782	S 7A66 A	E50-0226	S 4370 A	P11-3179	S 4270 A
MG086	S 1411 N			1789050	S 6009 NE	E50-0665	S 0060 A	P11-3341	S 2370 A
MG087	S 5911 N			1791192	S 4403 U	E50-0900	S 7968 A	P11-3343	S 4370 A
MG088	S 2161 N			1811391	S 3139 C	E50-3067	S 0840 A	P11-3374	S 2370 A
MG089	S 0201 N	0114786	S 8600 R	1815766	S 6146 NE	E70-0119	S 0850 A	P11-3501	S 5650 A
MG094	S 0101 N	0229348	S 3081 PO	1819795	S 4403 U	P-17056	S 9990 A	P11-3986	S 2950 A
MG1653	S 6001 NE	0267714	S 3275 R	1821580	S 4403 U	P-18490	S 9990 A	P11-4931	S 3450 A
MG1654	S 6072 NE	0267715	S 3408 R	1825427	S 7F14 A	P01-7056	S 9990 A	P11-5069	S 7313 A
MG1657	S 6017 NE	0611049	S 5802 R	1825431	S 3062 C	P01-7787	S 7002 A	P11-5070	S 7312 A
MG1659	S 6011 NE	0667078	S 8570 A	1829399	S 4347 CA	P01-8065	S 7023 A	P11-5115	S 8950 A
MG1665	S 6004 NE	0691954	S 2234 Z	1847823	S 3460 C	P01-8367	S 7023 A	P11-5623	S 0150 A
MG1678	S 6010 NE	0699387	S 7259 A	1855687	S 4405 U	P01-8490	S 9990 A	P11-6501	S 0150 A
MG3604	S 6059 NE	0754718	S 7428 A	1857106	S 5664 PO	P01-8706	S 8350 A	P11-6502	S 8940 A
MG3605	S 6062 NE	110371	S 1910 PO	1891431	S 5904 PO	P10-0400	S 7023 A	P11-6541	S 8940 A
MG3606	S 6063 NE	110376	S 0550 A	192143	S 7F14 A	P10-0689	S 7026 A	P11-6711	S 7045 A
MG3607	S 6064 NE	112294	S 2650 A	1921967	S 5630 R	P10-0890	S 7011 A	P11-7092	S 4770 A
MG3619	S 6009 NE	1146384	S 7641 A	1927720	S 7573 A	P10-1204	S 9990 A	P11-7331	S 6940 A
MG3624	S 6044 NE	1147590	S 0768 A	1927474	S 7138 A	P10-1222	S 2950 A	P11-7431	S 0940 A
ML011	S 0012 O	114786	S 8600 R	1928868	S 4405 U	P10-1224	S 2950 A	P11-7433	S 6270 A
ML013/A	S 1080 PO	1155727	S 7641 A	1928869	S 5240 PE	P10-1234	S 0060 A	P11-7434	S 6550 A
ML014	S 6180 PO	1295090	S 9870 A	1931680	S 5905 PO	P10-1237	S 0940 A	P11-7435	S 4270 A
ML018	S 0580 PO	1296851	S 4143 NR	1931684	S 7B45 A	P10-1240	S 6940 A	P11-7437	S 6550 A
ML020	S 3300 PO	130614	S 0130 R	1933740	S 7B45 A	P10-1246	S 8950 A	P11-7439	S 0150 A
ML021	S 6290 PO	1310891	S 5902 PO	1948921	S 7573 A	P10-1275	S 0840 A	P11-7441	S 5450 A
ML026	S 3081 PO	1310901	S 3010 R	1950784	S 5081 PE	P10-2090	S 7010 A	P11-7443	S 7945 A
ML030	S 5011 PE	1314531	S 7428 A	1950785	S 3217 C	P10-2629	S 0840 A	P11-7781	S 7314 A
ML031	S 0280 PO	1316123	S 3408 R	1953595	S 3460 C	P10-2745	S 6650 A	P11-7782	S 7315 A
ML032	S 4000 O	1317409	S 7409 A	1953596	S 4351 CA	P10-3285	S 7023 A	P11-7797	S 8840 A
ML048	S 7380 PO	1318695	S 4337 NR	2014774	S 4352 CA	P10-3443	S 2950 A	P11-7809	S 9990 A
ML061	S 4380 PO	1318919	S 7428 A	2027058	S 4405 U	P10-3535	S 9990 A	P11-8159	S 0060 A
ML077	S 3180 PO	1322255	S 3062 C	211340	S 5664 PO	P10-3568	S 0060 A	P11-8160	S 8950 A
ML082	S 7510 O	1322259	S 3092 C	2114402	S 6490 PO	P10-3712	S 0940 A	P11-8166	S 2370 A
ML11	S 0012 O	1346885	S 7A15 A	2124657	S 7573 A	P10-3988	S 7372 A	P11-8343	S 0940 A
ML13/A	S 1080 PO	1353115	S 7371 A	2129253	S 7F14 A	P10-4873	S 2950 A	P11-9007	S 2950 A
ML14	S 6180 PO	1362124	S 3139 C	224788	S 5240 PE	P10-4972	S 8950 A	P11-9100	S 7170 A
ML1711	S 5005 PE	1362168	S 4347 CA	229348	S 6100 R	P10-5229	S 0840 A	P11-9136	S 0850 A
ML1713	S 5006 PE	1363023	S 7A16 A	236481	S 3081 PO	P10-5259	S 2950 A	P11-9167	S 7033 A
ML1714	S 5045 PE	1363024	S 7573 A	237617	S 6490 PO	P10-5289	S 2950 A	P11-9234	S 0940 A
ML1734	S 5016 PE	1363025	S 7A16 A	247138	S 7002 A	P10-5359	S 2950 A	P11-9235	S 4270 A
ML1750	S 5111 PE	1376481	S 5902 PO	247139	S 8110 NR	P10-5368	S 0850 A	P11-9237	S 7945 A
ML18	S 0580 PO	138364	S 8381 NC	248126	S 6710 NR	P10-5389	S 2950 A	P11-9239	S 9990 A
ML20	S 3300 PO	1385791	S 7A15 A	265045	S 0530 PO	P10-5399	S 2950 A	P11-9244	S 9990 A
ML21	S 6290 PO	1391510	S 7393 A	267714	S 2450 A	P10-5501	S 2950 A	P11-9247	S 0060 A
ML26	S 3081 PO	1397764	S 5045 PE	267715	S 3275 R	P10-5555	S 6650 A	P11-9340	S 0840 A
ML31	S 0280 PO	1397765	S 5234 PE	302043	S 3408 R	P10-5571	S 8950 A	P11-9363	S 0850 A
ML32	S 4000 O	1397766	S 6009 NE	3329289	S 8790 PO	P10-5629	S 0840 A	P11-9371	S 8270 A
ML406	S 6380 PO	1399494	S 0620 R	37H7937	S 4478 NR	P10-5703	S 7040 A	P11-9372	S 7024 A
ML411	S 1910 PO	1399760	S 2220 NR	393561	S 8111 NC	P10-6042	S 2950 A	P11-9373	S 2840 A
ML412	S 2510 O	1433649	S 4142 NR	4602317	S 7187 A	P10-6277	S 9990 A	P11-9374	S 8940 A
ML417	S 0122 O	1433690	S 7F15 A	482247138	S 4405 U	P10-6287	S 9990 A	P11-9375	S 4370 A
ML418	S 0300 O	1438836	S 6089 NE	494251	S 8110 NR	P10-6375	S 7002 A	P11-9409	S 0850 A
ML4504	S 5062 PE	1450184	S 6146 NE	505412	S 7111 NC	P10-6441	S 7024 A	P11-9410	S 2850 A
ML4519	S 5026 PE	1506635	S 7A66 A	506337	S 7839 A	P10-6587	S 0150 A	P11-9417	S 7023 A
ML452	S 4080 PO	1527755	S 7F14 A	548257	S 0550 A	P10-6600	S 0060 A	P11-9596	S 7002 A
ML4520	S 5046 PE	1527758	S 7F24 A	607179	S 7411 N	P10-6632	S 7945 A	P11-9613	S 4370 A
ML4534	S 5159 PE	1527760	S 7F23 A	611049	S 0450 A	P10-6769	S 6550 A	P11-9674	S 8950 A
ML4541	S 5235 PE	1529635	S 5902 PO	661049	S 5802 R	P10-6775	S 2840 A	P11-9676	S 8950 A
ML4546	S 5102 PE	1529639	S 4143 NR	667078	S 5802 R	P10-6834	S 8940 A	P11-9694	S 9990 A
ML4559	S 5044 PE	1529699	S 6089 NE	671490	S 8570 A	P10-7445	S 8950 A	P11-9696	S 0940 A
ML4560	S 5181 PE	1600428	S 3217 C	690260	S 8600 R	P10-7447	S 8950 A	P11-9697	S 7002 A
ML4563	S 5097 PE	1616361	S 6024 NE	691280	S 7600 R	P10-7475	S 8950 A	P11-9699	S 7023 A
ML461	S 8260 PO	1618993	S 4089 NR	691954	S 1450 A	P10-7672	S 6550 A	P11-9775	S 2950 A
ML462	S 7261 PO	1629393	S 5081 PE	692380	S 2234 Z	P10-7703	S 2950 A	P11-9776	S 0840 A
ML477	S 0530 PO	1638006	S 7573 A	694218	S 3940 A	P10-7868	S 0850 A	P11-9778	S 7670 A
ML479	S 5013 PE	1638054	S 7B45 A	694450	S 1050 A	P10-7959	S 7039 A	P12-0022	S 7170 A
					S 7023 A	P10-8668	S 2370 A	P12-0113	S 0840 A

**CROSS REFERENCES > CORRISPONDENZE >
CORRESPONDANCES > VERGLEICHNUMMERN > CRUCE DE REFERENCIAS**

P12-0114	S 2950 A	P14-0123	S 2450 A	P50-0174	S 7484 A	P55-0727	S 3408 R	P77-0141	S 2850 A
P12-0395	S 7008 A	P14-0131	S 0650 A	P50-0228	S 7474 A	P55-0747	S 4143 NR	P77-0149	S 7143 A
P12-0407	S 7041 A	P14-0136	S 2650 A	P50-2222	S 8020 R	P55-0761	S 5036 PE	P77-0198	S 2850 A
P12-0712	S 0060 A	P14-0185	S 7028 A	P50-2392	S 6062 NE	P55-0762	S 6001 NE	P77-0227	S 6450 A
P12-0841	S 7945 A	P14-0186	S 4940 A	P50-2507	S 2003 DR	P55-0763		P77-0234	S 8450 A
P12-0842	S 6550 A	P14-0187	S 0950 A	P50-2517	S 4461 NR	(N.1 FILTRO/FILTER)	S 5133 PE	P77-0504	S 0270 A
P12-1200	S 0840 A	P14-0188	S 5270 A	P50-2596	S 3592 R	P55-0764	S 5132 PE	P77-1000	S 6870 A
P12-1333	S 7002 A	P14-0633	S 6370 A	P50-5982	S 4461 NR	P55-0765	S 5016 PE	P77-1004	S 5650 A
P12-1673	S 2370 A	P14-5700	S 6550 A	P50-6078	S 6034 NE	P55-0766	S 5099 PE	P77-1073	S 7222 A
P12-1674	S 0150 A	P14-8113	S 6650 A	P52-8708	S 7091 A	P55-0767	S 5131 PE	P77-1504	S 2570 A
P12-1675	S 6550 A	P14-8969	S 0840 A	P53-0645	S 7107 A	P55-0768	S 5007 PE	P77-1507	S 0550 A
P12-2073	S 0850 A	P14-8970	S 6650 A	P53-3882	S 7A35 A	P55-0769	S 5062 PE	P77-1508	S 2650 A
P12-2074	S 2850 A	P15-0706	S 5650 A	P53-3884	S 7A36 A	P55-0778	S 4142 NR	P77-1509	S 7028 A
P12-2154	S 8950 A	P15-1097	S 1005 A	P53-4435	S 7617 A	P55-0812	S 5081 PE	P77-1510	S 6370 A
P12-2156	S 8940 A	P15-1951	S 7987 A	P53-5089	S 3051 A	P55-0820	S 5046 PE	P77-1515	S 7299 A
P12-2157	S 2840 A	P15-8665	S 7040 A	P53-7876	S 9870 A	P55-0860	S 0101 N	P77-1516	S 0270 A
P12-2328	S 0060 A	P17-2463	S 5569 PO	P53-7877	S 7408 A	P55-0861	S 1411 N	P77-1519	S 4770 A
P12-2329	S 0150 A	P18-1000	S 6940 A	P53-9465	S 4450 A	P55-0863	S 6024 NE	P77-1523	S 7368 A
P12-2330	S 6550 A	P18-1002	S 7945 A	P55-0004	S 0712 NR	P55-0880		P77-1528	S 8450 A
P12-2492	S 8950 A	P18-1007	S 8840 A	P55-0006	S 3241 R	(AIFO, CLAAS, NEW HOLLAND)	S 4480 NR	P77-1534	S 5650 A
P12-2510	S 0840 A	P18-1031	S 9990 A	P55-0008	S 5600 R	P55-0881	S 2220 NR	P77-1543	S 8950 A
P12-2512	S 0840 A	P18-1033	S 7011 A	P55-0041	S 7261 PO	P55-0882	S 3257 R	P77-1547	S 2950 A
P12-2514	S 2950 A	P18-1034	S 0150 A	P55-0052	S 0280 PO	P55-0903	S 1H2O NR	P77-1551	S 6450 A
P12-2517	S 0060 A	P18-1035	S 0940 A	P55-0060	S 7411 N	P55-0904	S 1999 NR	P77-1558	S 1050 A
P12-2525	S 0940 A	P18-1036	S 7010 A	P55-0061	S 0201 N	P55-0905	S 5097 PE	P77-1559	S 7045 A
P12-2695	S 0060 A	P18-1038	S 7313 A	P55-0069	S 7411 N	P55-0913	S 4157 NR	P77-1561	S 2450 A
P12-2696	S 0940 A	P18-1039	S 5450 A	P55-0105	S 4510 NR	P55-0945	S 3292 R	P77-1573	S 0050 A
P12-2697	S 8950 A	P18-1040	S 7315 A	P55-0117	S 0300 O	P55-0952	S 5904 PO	P77-1575	S 8570 A
P12-2836	S 7945 A	P18-1041	S 4270 A	P55-0120	S 2161 N	P55-1005	S 5156 PE	P77-1576	S 5250 A
P12-2991	S 2850 A	P18-1044	S 6270 A	P55-0132	S 3301 PO	P55-1060	S 0530 PO	P77-1582	S 9570 A
P12-3007	S 7342 A	P18-1045	S 0060 A	P55-0183	S 1080 PO	P55-1102	S 9030 R	P77-1583	S 3570 A
P12-3065	S 6650 A	P18-1046	S 6550 A	P55-0184	S 3180 PO	P55-1603	S 9710 R	P77-1595	S 7185 A
P12-3568	S 0060 A	P18-1050	S 0840 A	P55-0220	S 5613 PO	P55-1604	S 0230 R	P77-2504	S 2570 A
P12-3827	S 0150 A	P18-1052	S 2950 A	P55-0226	S 3003 DR	P55-1605	S 0710 NR	P77-2519	S 4770 A
P12-4032	S 2370 A	P18-1054	S 8950 A	P55-0230	S 8137 RH	P55-1670	S 3409 R	P77-2523	S 7368 A
P12-4069	S 8940 A	P18-1056	S 7359 A	P55-0286	S 5900 PO	P55-1838	S 4157 NR	P77-2534	S 5650 A
P12-4156	S 0840 A	P18-1059	S 0850 A	P55-0287	S 5903 PO	P55-1843	S 4461 NR	P77-2536	S 7221 A
P12-4157	S 2950 A	P18-1063	S 7170 A	P55-0299	S 0420 R	P55-1855	S 4138 NR	P77-2580	S 7356 A
P12-4158	S 2950 A	P18-1064	S 2370 A	P55-0300	S 0300 O	P55-1856	S 4143 NR	P77-2581	S 7217 A
P12-4159	S 8950 A	P18-1068	S 7026 A	P55-0309	S 3081 PO	P55-2096	S 9006 AR	P77-2585	S 7372 A
P12-4177	S 0060 A	P18-1087	S 5270 A	P55-0310	S 8790 PO	P55-2440	S 7600 NR	P77-5339	S 7218 A
P12-4525	S 2570 A	P18-1088	S 0950 A	P55-0314	S 2510 O	P55-2819	S 7600 R	P77-5367	S 7165 A
P12-4526	S 4370 A	P18-1089	S 4940 A	P55-0315	S 5124 PE	P55-3004		P77-5368	S 1940 A
P12-6047	S 7143 A	P18-1090	S 2570 A	P55-0317	S 8600 R	(RENAULT VI, SCANIA, VOLVO)	S 4323 NR	P77-5369	S 7129 A
P12-6056	S 7144 A	P18-1091	S 7143 A	P55-0318	S 2329 R	P55-3004		P77-5370	S 1450 A
P12-6098	S 0060 A	P18-1092	S 7017 A	P55-0341	S 3275 R	(ALTRE/OTHER APPL.)	S 5400 NR	P77-5371	S 1307 A
P12-6310	S 2950 A	P18-1102	S 8350 A	P55-0342	S 5003 DR	P55-3191	S 0900 R	P77-5372	S 3940 A
P12-6334	S 2370 A	P18-1115	S 7039 A	P55-0343	S 3003 DR	P55-3201	S 4470 NR	P77-5792	S 4940 A
P12-7128	S 8950 A	P18-1118	S 7033 A	P55-0346	S 0610 NR	P55-3411	S 0700 R	P77-5803	S 7342 A
P12-7532	S 2570 A	P18-1120	S 7008 A	P55-0347	S 4311 N	P55-3771	S 8600 R	P77-5804	S 7343 A
P12-8149	S 0850 A	P18-1137	S 0450 A	P55-0349	S 2162 N	P55-3825	S 7260 PO	P77-5843	S 7168 A
P12-8408	S 7308 A	P18-2000	S 6940 A	P55-0361	S 7510 O	P55-4004	S 0900 R	P77-5896	S 7186 A
P12-9396	S 1005 A	P18-2002	S 7945 A	P55-0362	S 5802 R	P55-4017	S 5800 R	P77-5918	S 7214 A
P13-0502	S 7017 A	P18-2007	S 8840 A	P55-0372	S 5020 NR	P55-4403	S 9400 R	P77-5945	S 6870 A
P13-0765	S 0150 A	P18-2031	S 9990 A	P55-0425	S 4120 R	P55-4407	S 0420 R	P77-6251	S 7A22 A
P13-0767	S 7143 A	P18-2033	S 7011 A	P55-0440	S 5400 NR	P55-4408	S 1380 R	P77-6252	S 7431 A
P13-0768	S 2370 A	P18-2034	S 0150 A	P55-0451	S 5005 PE	P55-4620	S 6710 NR	P77-6260	S 7183 A
P13-0771	S 5650 A	P18-2035	S 0940 A	P55-0452	S 3010 R	P55-4744		P77-6386	S 7998 A
P13-0772	S 7144 A	P18-2036	S 7010 A	P55-0453	S 5006 PE	(IVECO)	S 8410 AR	P77-6694	S 1940 A
P13-0959	S 7607 A	P18-2038	S 7313 A	P55-0473	S 9600 NR	P55-4770	S 2030 R	P77-6695	S 3940 A
P13-1322	S 2950 A	P18-2039	S 5450 A	P55-0481	S 2161 N	P55-4925	S 2530 PO	P77-6696	S 7129 A
P13-1329	S 2370 A	P18-2040	S 7315 A	P55-0484	S 1910 PO	P55-5625	S 9490 PO	P77-6697	S 1450 A
P13-1333	S 4270 A	P18-2041	S 4270 A	P55-0489	S 2162 N	P55-6245		P77-6993	S 2950 A
P13-1343	S 7945 A	P18-2044	S 6270 A	P55-0490	S 4402 R	(CARTA PIEGH./PLEATED PAPER)	S 7112 NC	P77-7152	S 0070 A
P13-1344	S 2850 A	P18-2045	S 0060 A	P55-0491	S 4323 NR	P55-6245		P77-7154	S 7161 A
P13-1351	S 8940 A	P18-2046	S 6550 A	P55-0494	S 4337 NR	(CARTA ARROTOL./ROLLED PAPER)	S 7111 NC	P77-7279	S 9870 A
P13-1352	S 2840 A	P18-2050	S 0840 A	P55-0495	S 0310 NR	P55-6287	S 8111 NC	P77-7358	S 7281 A
P13-1401	S 2950 A	P18-2052	S 2950 A	P55-0496	S 4471 NR	P55-7111	S 7111 NC	P77-7409	S 7423 A
P13-1404	S 9990 A	P18-2054	S 8950 A	P55-0498	S 4378 NR	P55-7440	S 0810 NR	P77-7414	S 7408 A
P13-1406	S 2950 A	P18-2056	S 7359 A	P55-0515	S 4341 NR	P55-8250	S 5800 R	P77-7524	S 7165 A
P13-2343	S 1005 A	P18-2059	S 0850 A	P55-0519	S 4402 R	P55-8425	S 8260 PO	P77-7525	S 7432 A
P13-2601	S 6550 A	P18-2063	S 7170 A	P55-0520	S 0620 R	P55-8615	S 3497 R	P77-7526	S 7288 A
P13-2604	S 0150 A	P18-2064	S 2370 A	P55-0529	S 9320 NR	P55-9418	S 7600 R	P77-7551	S 1307 A
P13-2605	S 8940 A	P18-2068	S 7026 A	P55-0563	S 5095 PE	P55-9419	S 0510 NR	P77-7579	S 1970 A
P13-2976	S 8950 A	P18-2090	S 2570 A	P55-0564		P55-9624	S 8110 NR	P77-7592	S 7A17 A
P13-2977	S 0840 A	P18-2091	S 7143 A	(MERCEDSES 611 180 00 09)	S 5013 PE	P56-6130	S 0VGT A	P77-7767	S 7277 A
P13-2978	S 2950 A	P18-2092	S 7017 A	P55-0588	S 8500 NR	P60-5522	S 7F19 A	P77-7868	S 7421 A
P13-2979	S 0060 A	P18-4013	S 7945 A	P55-0627	S 6004 NE	P60-6720	S 7F18 A	P77-7869	S 7422 A
P13-2980	S 0940 A	P18-4031	S 9990 A	P55-0628	S 6008 NE	P61-2826	S 3080 A	P77-7871	S 7564 A
P13-3525	S 0060 A	P18-4033	S 7011 A	P55-0629	S 5044 PE	P61-4541	S 3340 A	P77-7875	S 5655 A
P13-3535	S 0060 A	P18-4034	S 0150 A	P55-0630	S 5045 PE	P64-1931	S 7F27 A	P77-7948	S 7428 A
P13-4546	S 0840 A	P18-4035	S 0940 A	P55-0631	S 6009 NE	P75-3338	S 3289 C	P77-8081	S 7544 A
P13-4743	S 8840 A	P18-4036	S 7010 A	P55-0632	S 6017 NE	P76-2756	S 2234 Z	P77-8326	S 7409 A
P13-6256	S 2370 A	P18-4039	S 5450 A	P55-0639	S 3288 R	P76-3995	S 4395 NR	P77-8335	S 7286 A
P13-6523	S 0060 A	P18-4041	S 4270 A	P55-0653	S 6010 NE	P76-6162	S 5820 R	P77-8336	S 7358 A
P13-8418	S 2950 A	P18-4044	S 6270 A	P55-0661	S 5234 PE	P77-0027	S 0070 A	P77-8403	S 7160 A
P14-0110	S 0450 A	P18-4045	S 0060 A	P55-0663	S 5902 PO	P77-0035	S 2070 A	P77-8436	S 7178 A
P14-0122	S 0550 A	P18-4046	S 6550 A	P55-0665	S 0999 NR	P77-0117	S 6450 A	P77-8441	S 7187 A



**CROSS REFERENCES > CORRISPONDENZE >
CORRESPONDANCES > VERGLEICHNUMMERN > CRUCE DE REFERENCIAS**

P77-8453	S 7405 A	P78-7247	S 7390 A	SMP77-1507	S 0550 A	5576200	S 3301 PO	0746725	S 4940 A
P77-8462	S 7550 A	P78-7449	S 3283 C	SMP77-1508	S 2650 A	5577124	S 3301 PO	0746779	S 7107 A
P77-8485	S 7213 A	P78-7450	S 3078 C	SMP77-1509	S 7028 A	6945658	S 7312 A	0746839	S 1940 A
P77-8605	S 7337 A	P78-7610	S 7642 A	SMP77-1510	S 6370 A	6945659	S 7313 A	0746911	S 0550 A
P77-8613	S 1670 A	P78-8716	S 7644 A	SMP77-1516	S 0270 A	9016647		0746916	S 6550 A
P77-8674	S 7A13 A	P78-8881	S 3062 C	SMP77-1519	S 4770 A	(INTERNA/INNER) +	S 7314 A	0746920	S 6710 NR
P77-8779	S 7285 A	P78-9377	S 7A11 A	SMP77-1528	S 8450 A	9016647		0746928	S 1050 A
P77-8924	S 7608 A	P782936	S 7E35 A	SMP77-1534	S 5650 A	(ESTERNA/OUTER) +	S 7315 A	0746931	S 7670 A
P77-8972	S 7516 A	P80-1064	S 2450 A	SMP77-1543	S 8950 A	9027704	S 9990 A	0747075	S 7017 A
P77-8994	S 7506 A	P80-1843	S 2370 A	SMP77-1547	S 2950 A	9027859	S 9990 A	0747092	S 4370 A
P78-0006	S 7361 A	P80-3913	S 7945 A	SMP77-1551	S 6450 A	9028234	S 7011 A	0747093	S 2570 A
P78-0036	S 7507 A	P80-3915	S 6550 A	SMP77-1558	S 1050 A	9028636	S 7011 A	0794007	S 6940 A
P78-0249	S 7614 A	P82-8889	S 7356 A	SMP77-1561	S 2450 A	9028638	S 9990 A	0796293	S 0201 N
P78-0321	S 7549 A	P83-6144	S 7617 A	SMP77-1573	S 0050 A	9028908	S 9990 A	11542957	S 1270 R
P78-0519	S 7161 A	P90-0725	S 7479 A	SMP77-1575	S 8570 A	9029981	S 9990 A	1170781	S 0450 A
P78-0621	S 7284 A	P90-3552	S 7266 A	X77-0733	S 4401 U	9030353	S 7011 A	1190514	S 8790 PO
P78-0622	S 7357 A	P95-0620	S 3048 C	X77-0734	S 4402 U	9030537	S 7011 A	1470102	S 5270 A
P78-0623	S 7404 A	P95-0910	S 7627 A	X77-0914	S 6147 NE	9030538	S 9990 A	1470265	S 8950 A
P78-0624	S 7406 A	P95-1102	S 7A03 A	XLP18-2000	S 6940 A	9030854	S 7010 A	1470275	S 0060 A
P78-0731	S 7575 A	P95-1411	S 7F14 A	XLP18-2002	S 7945 A	9030894	S 0940 A	1470319	S 8600 R
P78-0815	S 7548 A	P95-1413	S 7A66 A	XLP18-2007	S 8840 A	9030895	S 6940 A	1470344	S 0530 PO
P78-0834	S 7279 A	P95-1417	S 7393 A	XLP18-2031	S 9990 A	9034222	S 7945 A	1470394	S 5400 NR
P78-0848	S 7280 A	P95-1419	S 7F30 A	XLP18-2033	S 7011 A	9034223	S 7024 A	1470483	S 5802 R
P78-0910	S 9870 A	P95-3210	S 7C13 A	XLP18-2034	S 0150 A	9034529	S 4270 A	1470629	S 2450 A
P78-0911	S 7409 A	P95-3211	S 7B36 A	XLP18-2035	S 0940 A	9035429	S 4270 A	1470630	S 3940 A
P78-1185	S 7405 A	P95-3212	S 7C13 A	XLP18-2036	S 7010 A	9035866	S 5450 A	1470631	S 0950 A
P78-1199	S 7641 A	P95-3213	S 7B36 A	XLP18-2039	S 5450 A	9035988	S 5450 A	1470634	S 1940 A
P78-1203	S 0768 A	P95-3215	S 7D41 A	XLP18-2041	S 4270 A	9035992	S 5450 A	1470637	S 0450 A
P78-1228	S 7A44 A	P95-3329	S 5181 PE	XLP18-2044	S 6270 A	9035993	S 3450 A	1470645	S 9030 R
P78-1349	S 3373 A	P95-3571	S 7259 A	XLP18-2045	S 0060 A	9038349	S 7314 A	1470654	S 9030 R
P78-1350	S 7469 A	P95-4411	S 7650 A	XLP18-2046	S 6550 A	9038350	S 7315 A	1470661	S 2850 A
P78-1465	S 7383 A	P95-4555	S 6064 NE	XLP18-2050	S 0840 A	9038407	S 6270 A	1470695	S 0450 A
P78-1466	S 7259 A	P95-4556	S 6059 NE	XLP18-2052	S 2950 A	9038408	S 8270 A	1470696	S 1050 A
P78-1525	S 7371 A	P95-4588	S 5087 OC	XLP18-2054	S 8950 A	9038895	S 7011 A	1470702	S 2650 A
P78-1530	S 7638 A	P95-4593	S 5394 GC	XLP18-2056	S 7359 A	9038896	S 6940 A	1470703	S 7129 A
P78-1640	S 7421 A	P95-4604	S 6039 NE	XLP18-2059	S 0850 A	9038898	S 0940 A	1470717	S 1450 A
P78-1682	S 3053 C	P95-4605	S 5664 PO	XLP18-2063	S 7170 A	9038899	S 4270 A	1470718	S 0450 A
P78-1740	S 7970 A	P95-4658	S 5111 PE	XLP18-2064	S 2370 A	9038900	S 5450 A	1470721	S 1307 A
P78-1741	S 7615 A	P95-4827	S 4349 CA	XLP18-2068	S 7026 A	9038901	S 7945 A	1470730	S 0650 A
P78-2106	S 7558 A	P95-4867	S 6072 NE	XLP18-2090	S 2570 A	9038902	S 7010 A	1470819	S 3241 R
P78-2109	S 7559 A	P95-4868	S 7B11 A	XLP18-2091	S 7143 A	9038903	S 9990 A	1470823	S 7839 A
P78-2137	S 2764 A	P95-4895	S 4146 NR	XLP18-2092	S 7017 A	9038908	S 9990 A	1470827	S 6710 NR
P78-2328	S 7A15 A	P95-4925	S 4472 NR	XLP18-4013	S 7945 A	9038909	S 0060 A	1470841	S 2530 PO
P78-2396	S 7345 A	P95-4933	S 7A86 A	XLP18-4031	S 9990 A	9049488	S 3450 A	1477102	S 5270 A
P78-2596	S 8502 A	P95-4970	S 4120 NR	XLP18-4033	S 7011 A	9049490	S 7024 A	2165039	S 4940 A
P78-2811	S 3089 C	P95-5823	S 3454 C	XLP18-4034	S 0150 A	9053258	S 7308 A	4134196	S 0060 A
P78-2857	S 7347 A	P95-6059	S 5156 PE	XLP18-4035	S 0940 A	9059512	S 7315 A	4134217	S 8600 R
P78-2880	S 7626 A	P95-6094	S 5236 PE	XLP18-4036	S 7010 A	9059562	S 7315 A	4134236	S 0530 PO
P78-2881	S 7625 A	P95-7182	S 7C16 A	XLP18-4039	S 5450 A	9059575	S 2570 A	4134287	S 5802 R
P78-2936	S 7619 A	P95-7411	S 7F28 A	XLP18-4041	S 4270 A	9176410	S 9990 A	4134352	S 2370 A
P78-2937	S 7616 A	P956170	S 4405 U	XLP18-4044	S 6270 A	9176972	S 9990 A	4134366	S 2450 A
P78-2998	S 7651 A	PPP10-2745	S 6650 A	XLP18-4045	S 0060 A	9191704	S 7011 A	4134367	S 3940 A
P78-3117	S 7695 A	PPP11-4931	S 3450 A	XLP18-4046	S 6550 A	9206065	S 7010 A	4134368	S 0950 A
P78-3197	S 3030 A	PPP11-9371	S 8270 A	XLP77-2504	S 2570 A	920624	S 7011 A	4134370	S 1940 A
P78-3753	S 7344 A	PPP11-9375	S 4370 A	XLP77-2519	S 4770 A	9218797	S 7010 A	4134377	S 9030 R
P78-3871	S 7F15 A	PPP13-0772	S 7144 A	XLP77-2523	S 7368 A	9223197	S 0060 A	4134389	S 0150 A
P78-4456	S 7637 A	PPP77-5370	S 1450 A	XLP77-2534	S 5650 A	9247127	S 5450 A	4134403	S 0450 A
P78-4457	(SCANIA)	R00-0171	S 7B80 A	XLP77-2536	S 7221 A	9249091	S 5450 A	4134406	S 2650 A
P78-4457	S 7A50 A	R00-0172	S 7B81 A	XLP77-2581	S 7217 A	9377816	S 2840 A	4134407	S 7129 A
P78-4462	(MERCEDES BENZ)	SMP18-1000	S 6940 A			9387554	S 9990 A	4134415	S 1450 A
P78-4462	S 7A12 A	SMP18-1002	S 7945 A	DRESSER	SOFIMA	9393784	S 8950 A	4134419	S 1307 A
P78-4473	S 7482 A	SMP18-1007	S 8840 A			9394161	S 6550 A	4134427	S 0650 A
P78-4479	S 3072 C	SMP18-1031	S 9990 A	1239943H1	S 3409 R	9395884	S 7011 A	4134473	S 3241 R
P78-4525	S 3023 C	SMP18-1033	S 7011 A	680587C2	S 7945 A	9395885	S 7010 A	4134474	S 7839 A
P78-4578	S 7573 A	SMP18-1034	S 0150 A			9395886	S 9990 A	4134475	S 6710 NR
P78-4578	S 7A14 A	SMP18-1035	S 0940 A	EUCLID	SOFIMA	E622511	S 7010 A	4134772	S 5400 NR
P78-4971	S 3054 C	SMP18-1036	S 7010 A			E632878	S 7010 A	4134784	S 8600 R
P78-5001	S 7F17 A	SMP18-1039	S 5450 A	4001155	S 8270 A	E632943	S 9990 A	4192169	S 8950 A
P78-5002	S 7F16 A	SMP18-1041	S 4270 A	4001156	S 6270 A	EG82665	S 4270 A	4194770	S 3301 PO
P78-5307	S 3055 C	SMP18-1044	S 6270 A	4003986	S 4270 A			470226	S 0201 N
P78-5352	S 7600 A	SMP18-1045	S 0060 A	4012356	S 5450 A		FAUN / FRISCH	4788715	S 3301 PO
P78-5353	S 7A16 A	SMP18-1046	S 6550 A	4012357	S 3450 A		SOFIMA	4790226	S 0201 N
P78-5365	S 3139 C	SMP18-1050	S 0840 A	4012358	S 8270 A	0746222	S 8950 A	4795772	S 5400 NR
P78-5373	S 6011 NE	SMP18-1052	S 2950 A	4012359	S 6270 A	0746232	S 0940 A	4795837	S 8600 R
P78-5518	S 7A25 A	SMP18-1054	S 8950 A	4012361	S 4270 A	0746233	S 0060 A	4796439	S 2530 PO
P78-5519	S 7A26 A	SMP18-1059	S 0850 A	4015860	S 7010 A	0746237	S 0940 A	7391047	S 3301 PO
P78-5522	S 7643 A	SMP18-1063	S 7170 A	4015903	S 9990 A	0746293	S 0201 N	9746444	S 2650 A
P78-5530	S 7645 A	SMP18-1064	S 2370 A	4015908	S 9990 A	0746369	S 2450 A		
P78-5542	S 7639 A	SMP18-1068	S 7026 A	4022650	S 7314 A	0746383	S 0950 A		
P78-5770	S 6146 NE	SMP18-1087	S 5270 A	4022651	S 7315 A	0746385	S 0550 A		
P78-6092	S 4177 CA	SMP18-1088	S 0950 A	4031215	S 7312 A	0746389	S 1050 A	AD785	S 7259 A
P78-6335	S 3165 C	SMP18-1089	S 4940 A	4031216	S 7313 A	0746395	S 5450 A	AD785/1	S 7344 A
P78-6421	S 7573 A	SMP18-1090	S 2570 A	4058189	S 4370 A	0746444	S 2650 A	AD785/2	S 7393 A
P78-6443	S 7B45 A	SMP18-1091	S 7143 A	4082222	S 7313 A	0746546	S 4270 A	AD785/3	S 7F14 A
P78-6611	S 3066 C	SMP18-1092	S 7017 A	4371021	S 3301 PO	0746547	S 8270 A	AD785/4	S 7A66 A
P78-6829	S 7546 A	SMP18-1118	S 7033 A	5197828	S 0060 A	0746554	S 2850 A	AD785/7	S 7F30 A
P78-6830	S 7544 A	SMP18-1137	S 0450 A	5573014	S 3301 PO	0746555	S 0850 A	AK360	S 7091 A
P78-6892	S 7B10 A	SMP77-1504	S 2570 A	5573102	S 3301 PO	0746712	S 3940 A	AK360/1	S 7092 A

**CROSS REFERENCES > CORRISPONDENZE >
CORRESPONDANCES > VERGLEICHNUMMERN > CRUCE DE REFERENCIAS**

AK380/3	S 7F21 A	AM447/4	S 7A15 A	K1139	S 3092 C	OP533	S 1270 R	PP840/8	S 4149 NR
AK380/4	S 7F22 A	AM447/7	S 7F15 A	K1142	S 3054 C	OP542	S 7330 R	PP841	S 9600 NR
AK790	S 0VGT A	AM447/8	S 7A16 A	K1144	S 3055 C	OP543	S 3280 R	PP841/1	S 4416 NR
AM 446/5	S 7F16 A	AM448	S 7186 A	K1153	S 3221 C	OP552		PP841/2	S 9600 NR
AM 462/2	S 7F27 A	AM449	S 0050 A	K1156	S 3023 C	(PERKINS)	S 1380 R	PP841/5	S 4006 NR
AM401/1	S 1050 A	AM454/1	S 7679 A	K1171	S 3078 C	OP560	S 7500 R	PP841/6	S 2320 NR
AM401/2	S 7945 A	AM455	S 7187 A	K1185	S 3139 C	OP562	S 1600 R	PP841/7	S 4107 NR
AM401/3	S 7431 A	AM455/1	S 5650 A	K1186	S 3217 C	OP563	S 3241 R	PP841/9	S 4112 NR
AM401W	S 7024 A	AM455/2	S 7625 A	K1253	S 3436 C	OP567/2	S 5800 R	PP845	S 4323 NR
AM402	S 0450 A	AM455/3	S 7626 A	K1253A	S 4345 CA	OP567/3	S 1600 R	PP845/1	S 8501 NR
AM402/1	S 7170 A	AM455/4	S 7637 A	K1256	S 3161 C	OP568	S 3257 R	PP845/2	S 5400 NR
AM402/1W	S 7670 A	AM455/5	S 7627 A	K1256A	S 4348 CA	OP569	S 8310 R	PP848	S 9960 NC
AM402W	S 1450 A	AM455/6	S 7600 A	K1288	S 3137 C	OP574	S 1563 R	PP857	S 1410 NR
AM404	S 6550 A	AM455W	S 7482 A	K1288A	S 4161 CA	OP574/1	S 0420 R	PP857/1	S 4444 NR
AM404/1	S 7372 A	AM456	S 7361 A	K1294	S 3289 C	OP576	S 2329 R	PP861	S 8110 NR
AM404/1W	S 7342 A	AM457	S 7544 A	K1344	S 3448 C	OP577	S 5800 R	PP861/1	S 4337 NR
AM404W	S 2840 A	AM458	S 7168 A	K1358	S 3459 C	OP584		PP861/2	S 8110 NR
AM405	S 2650 A	AM458/1	S 7563 A	K1358A	S 4349 CA	(SCANIA)	S 4402 R	PP861/3	S 6710 NR
AM405/1	S 7987 A	AM458/1W	S 7390 A	K1364	S 3437 C	OP584	S 0900 R	PP861/6	S 2220 NR
AM405W	S 7129 A	AM459	S 7343 A	K1393	S 3455 C	OP584/1	S 8600 R	PP879	S 0710 NR
AM406	S 7940 A	AM460	S 2670 A	K1394	S 3460 C	OP584/2	S 3698 R	PP879/1	S 0999 NR
AM406/1	S 4940 A	AM461	S 7028 A	K1395A	S 4350 CA	OP588/1	S 3102 R	PP879/2	S 4329 NR
AM408	S 2070 A	AM462	S 7992 A	OC600	S 0122 O	OP592	S 8600 R	PP879/3	S 1H2O NR
AM408/1	S 7161 A	AM463	S 7813 A	OC601	S 2510 O	OP592/1	S 5003 DR	PP879/4	S 4395 NR
AM408/1W	S 7160 A	AM464	S 7428 A	OC602	S 7510 O	OP592/2	S 3497 R	PP954	S 4408 NR
AM408/2	S 7578 A	AM465	S 7469 A	OC603	S 0300 O	OP592/3	S 0230 R	PP963	S 0310 NR
AM408/3	S 7337 A	AM465/1	S 7280 A	OC604	S 4000 O	OP592/4	S 9710 R	PP963/1	S 4341 NR
AM408/4	S 7A34 A	AM465/2	S 7279 A	OE610A	S 5095 PE	OP592/6	S 3288 R	PP964	S 5020 NR
AM409	S 4270 A	AM465/3	S 7383 A	OE640/1	S 5011 PE	OP592/8	S 5820 R	PP964/1	S 9320 NR
AM409/1	S 7183 A	AM465/4	S 7639 A	OE640/5	S 5013 PE	OP592/9	S 0920 R	PP964/2	S 4120 NR
AM410	S 4770 A	AM465/5	S 7F13 A	OE646	S 5005 PE	OP594	S 3003 DR	PP967/1	S 4142 NR
AM413	S 0650 A	AM466	S 8450 A	OE646/1	S 5016 PE	OP626	S 3292 R	PP971	S 0712 NR
AM414	S 0950 A	AM467	S 0270 A	OE646/2	S 5046 PE	OP626/1	S 3275 R	PP971/2	S 4408 NR
AM414W	S 1940 A	AM471	S 7357 A	OE646/3	S 5235 PE	OP626/2	S 3010 R	PP971/5	S 5394 GC
AM416	S 8570 A	AM471/1	S 7284 A	OE651	S 5006 PE	OP626/3	S 3408 R	PS820	S 1013 B
AM416/1	S 7286 A	AM471/2	S 7404 A	OE651/1	S 5007 PE	OP626/4	S 5802 R	PS877	S 1028 B
AM416/2	S 7358 A	AM471/3	S 7B10 A	OE651/2	S 5036 PE	OP626/6	S 0620 R	PS878/1	S 1071 B
AM416/3	S 7970 A	AM471W	S 7406 A	OE651/3	S 5062 PE	OP628		PS897	S 1028 B
AM416/4	S 7214 A	AM472	S 7A12 A	OE651/5	S 5236 PE	(ALTRE/OTHER APPL.)	S 1600 R	PW809	S 0201 N
AM416/5	S 7615 A	AM475/2	S 9380 A	OE651/6	S 5156 PE	OP631		PW809T	S 0201 N
AM416/6	S 7C13 A	AM476	S 7387 A	OE651/8	S 5237 PE	(VOLVO)	S 4120 R	PW813	S 0101 N
AM416/7	S 7B36 A	AM476/1	S 7608 A	OE669/1	S 5026 PE	OP636/3	S 3577 R	PW814	S 2161 N
AM416/7W	S 7D41 A	AM476/2	S 7575 A	OE676	S 5045 PE	OP642/1	S 0130 R	PW823	S 2162 N
AM416W	S 7288 A	AM476/3	S 7695 A	OE676/2	S 5081 PE	OP647	S 7600 R	SE770/2-2X	S 7B11 A
AM418	S 5250 A	AP068	S 3030 A	OE677/4	S 5159 PE	OP647/1	S 1380 R	UE730/2	S 4402 U
AM419/1	S 0840 A	AP069	S 3059 A	OE678	S 5044 PE	OP657	S 7600 R		
AM420	S 2450 A	AP085/1	S 6303 A	OE678/1	S 5181 PE	OR745	S 5900 PO		
AM420W	S 3940 A	AP137/2	S 3541 A	OE681/1	S 5238 PE	OR745/1	S 5903 PO		
AM423	S 3570 A	AP137/8	S 5812 A	OE686	S 5097 PE	OR745/3	S 5904 PO		
AM424	S 9570 A	AP157	S 3080 A	OE693/1	S 5102 PE	PE 983/2-2X	S 6147 NE		
AM424/1	S 7213 A	AP157/1	S 3082 A	OM501	S 1910 PO	PE878/3	S 6072 NE		
AM425	S 6370 A	AP157/6	S 3340 A	OM505	S 0530 PO	PE878/4	S 6044 NE		
AM426	S 8840 A	AP191	S 3373 A	OM507	S 4000 O	PE935	S 6001 NE		
AM428	S 0150 A	AR200/4	S 7516 A	OM509	S 9080 PO	PE935/1	S 6017 NE		
AM429	S 1070 A	AR200/5	S 7506 A	OM512	S 3081 PO	PE975	S 6009 NE		
AM430	S 2950 A	AR200/5W	S 7507 A	OM512/4	S 2234 Z	PE975/1	S 6146 NE		
AM430/1	S 8950 A	AR204	S 2810 A	OM513	S 5124 PE	PE975/2	S 6024 NE		
AM431	S 2570 A	AR214	S 0660 A	OM513/1-2X	S 5549 PO	PE977	S 6004 NE		
AM438	S 0070 A	AR224	S 2460 A	OM513/2	S 3631 PO	PE977/1	S 6011 NE		
AM440	S 7185 A	AR225	S 3330 A	OM514	S 7261 PO	PE977/2	S 6016 NE		
AM441	S 7138 A	AR257	S 9240 A	OM514/1	S 7260 PO	PE983	S 6008 NE		
AM442	S 7277 A	AR263	S 1506 A	OM514/2	S 8260 PO	PE983/1	S 6010 NE		
AM442/1	S 7285 A	AR263/1	S 5060 A	OM514/3	S 5536 PO	PE996	S 6039 NE		
AM442/2	S 7548 A	AR264	S 1540 A	OM514/4	S 9490 PO	PK937	S 6062 NE		
AM442/2W	S 7549 A	AR285	S 7356 A	OM515	S 6380 PO	PK937/1	S 6064 NE		
AM442/4	S 7345 A	AR298	S 7998 A	OM515/1		PK937/2	S 6063 NE		
AM442/5	S 7347 A	AR350/3	S 7641 A	(ALTRE/OTHER APPL.)	S 4380 PO	PK937/3	S 6059 NE		
AM442/5W	S 7484 A	AR350/3W	S 0768 A	OM516/1	S 6490 PO	PK937/8	S 6088 NE		
AM442/6	S 6870 A	AR350/5	S 7421 A	OM516/2	S 5381 PO	PK937/9	S 6089 NE		
AM442/8	S 7278 A	AR350/5W	S 7422 A	OM529	S 2530 PO	PM807	S 7411 N		
AM442/9	S 7A03 A	AR350/6	S 7558 A	OM590	S 0280 PO	PM808	S 1411 N		
AM442/9W	S 7A04 A	CW750	S 9006 AR	OM611	S 8790 PO	PM808T	S 1411 N		
AM446	S 1970 A	CW752	S 8410 AR	OM611/1	S 5613 PO	PM810	S 6311 N		
AM446/1	S 7651 A	K1029	S 3089 C	OP520	S 1600 R	PM810T	S 6311 N		
AM446/10	S 7644 A	K1035	S 3023 C	OP520/1	S 6100 R	PM813/1	S 7411 N		
AM446/2	S 8502 A	K1041	S 3053 C	OP520/1T		PM815	S 9091 N		
AM446/3	S 7619 A	K1042	S 3072 C	(RUS)	S 6100 R	PM819	S 7111 NC		
AM446/3W	S 7616 A	K1042A	S 4225 CA	OP520T		PM819/1	S 7112 NC		
AM446/4	S 7573 A	K1042A	S 3072 C	(RUS)	S 1600 R	PM844	S 8111 NC		
AM446/6	S 7F17 A	K1049	S 3048 C	OP525	S 5601 R	PP 971/1	S 4711 NR		
AM446/8	S 7A23 A	K1084	S 3051 A	OP525/2	S 3425 R	PP837	S 8500 NR		
AM446/9	S 7A11 A	K1088	S 3059 C	OP525/5	S 8310 R	PP837/1	S 4378 NR		
AM446W	S 7405 A	K1091	S 3062 C	OP525T		PP837/2	S 4473 NR		
AM447	S 7409 A	K1092	S 3056 C	(RUS)	S 5601 R	PP839	S 7600 NR		
AM447/1	S 9870 A	K1094	S 3066 C	OP526	S 2030 R	PP839/1	S 4391 NR		
AM447/1W	S 7408 A	K1114	S 3439 C	OP526/6	S 5603 R	PP840	S 2610 NR		
AM447/2	S 7371 A	K1133	S 3165 C	OP526T		PP840/1	S 4150 NR		
AM447/3	S 7A17 A	K1133A	S 4177 CA	(RUS)	S 2030 R	PP840/6	S 2320 NR		
								FLEETGUARD	SOFIMA
								3967874	S 4401 U
								3986767	S 4402 U
								AD27746	S 7F14 A
								AD27749	S 7FC3 A
								AF1001	S 7C13 A
								AF1601M	S 7839 A
								AF1604	S 7308 A
								AF1608M	S 2070 A
								AF1614	S 7299 A
								AF1643	S 7143 A
								AF1644	S 7144 A
								AF1658K	S 6650 A
								AF1733K	S 0850 A
								AF1733KM	S 0850 A
								AF1735K	S 7170 A
								AF1736	S 7004 A
								AF1758M	S 7607 A
								AF1798	S 7987 A
								AF1799	S 7974 A
								AF1801	S 7550 A
								AF1802	S 1050 A
								AF1803	S 7276 A
								AF1804	S 7028 A
								AF1809	S 0050 A
								AF1812	S 9570 A
								AF1829	S 7998 A
								AF1840	S 3940 A
								AF1841	S 7129 A
								AF1842	S 1940 A
								AF1843	S 1450 A
								AF1881	S 7614 A
								AF1882	S 7A22 A
								AF1929	S 2570 A
								AF1945	S 7139 A
								AF1953	S 5060 A
								AF1978	S 7808 A
								AF1989	S 7091 A
								AF25022	S 7213 A
								AF25043M	S 2650 A
								AF25044M	S 2450 A



**CROSS REFERENCES > CORRISPONDENZE >
CORRESPONDANCES > VERGLEICHNUMMERN > CRUCE DE REFERENCIAS**

AF25045M	S 8570 A	AF26165	S 7639 A	AF4103	S 2850 A	AF55886	S 3460 C	FF5198	S 9960 NC
AF25062	S 7361 A	AF26172	S 7695 A	AF413	S 9990 A	AF800	S 7040 A	FF5228	S 1411 N
AF25064	S 2450 A	AF26174	S 3436 C	AF4135	S 4940 A	AF803	S 7039 A	FF5271	S 4378 NR
AF25065	S 2650 A	AF26199	S 7627 A	AF4149	S 0050 A	AF804M	S 4370 A	FF5272	S 5020 NR
AF25066	S 8570 A	AF26202	S 7637 A	AF4150	S 7670 A	AF807K	S 2950 A	FF5284	S 4329 NR
AF25084	S 7572 A	AF26204	S 7563 A	AF415K	S 0940 A	AF820M	S 2840 A	FF5297	S 0310 NR
AF25154	S 7C16 A	AF26212	S 7F19 A	AF415KM	S 0940 A	AF822M	S 8270 A	FF5298	S 4337 NR
AF25222	S 7431 A	AF26213	S 3023 C	AF418	S 0150 A	AF830	S 5650 A	FF5307	S 1410 NR
AF25225	S 7432 A	AF26214	S 7641 A	AF418M	S 0150 A	AF851	S 5450 A	FF5312	S 7600 NR
AF25235	S 7544 A	AF26215	S 0768 A	AF421	S 4270 A	AF851M	S 5450 A	FF5373	S 9600 NR
AF25237	S 7428 A	AF26241	S 7600 A	AF421M	S 4270 A	AF853	S 8840 A	FF5380	S 6017 NE
AF25238	S 7285 A	AF26242	S 7A12 A	AF424	S 6550 A	AF853M	S 8840 A	FF5405	S 6001 NE
AF25239	S 7278 A	AF26244	S 7643 A	AF4245	S 7B36 A	AF857	S 7312 A	FF5424	S 4341 NR
AF25262	S 7A35 A	AF26245	S 7390 A	AF424M	S 6550 A	AF863M	S 4770 A	FF5425	S 4471 NR
AF25263	S 7A36 A	AF26246	S 7573 A	AF427M	S 6270 A	AF873M	S 7008 A	FF5430	S 1028 B
AF25264	S 1970 A	AF26261	S 7F16 A	AF4320	S 7F27 A	AF874	S 7041 A	FF5463	S 6010 NE
AF25294	S 7548 A	AF26262	S 7F17 A	AF434KM	S 2370 A	AF874M	S 7041 A	FF5470	S 0712 NR
AF25305	S 3089 C	AF26272	S 7645 A	AF435KM	S 0840 A	AF875M	S 7033 A	FF5481	S 6004 NE
AF25306	S 3080 A	AF26279	S 7562 A	AF437K	S 2950 A	AF879	S 7313 A	FF5485	S 2220 NR
AF25313	S 7358 A	AF26296	S 7544 A	AF437KM	S 2950 A	AF879M	S 7313 A	FF5507	S 9320 NR
AF25314	S 7286 A	AF26325	S 7546 A	AF4503	S 1050 A	AF880	S 7314 A	FF5510	S 6009 NE
AF25317	S 7576 A	AF26327	S 7B01 A	AF4522	S 7165 A	AF883	S 3450 A	FF5625	S 4006 NR
AF25319	S 3082 A	AF26353	S 7A23 A	AF4523	S 1307 A	AF883M	S 3450 A	FF5626	S 4341 NR
AF25326	S 7218 A	AF26375	S 3340 A	AF4525	S 7107 A	AF899	S 7315 A	FF5629	S 6011 NE
AF25333	S 7357 A	AF26393	S 7516 A	AF4550	S 7161 A	AF899M	S 7315 A	FF5683	S 6008 NE
AF25335	S 7217 A	AF26395	S 7506 A	AF4552	S 7160 A	AF919	S 7945 A	FF5684	S 6010 NE
AF25352	S 7356 A	AF26396	S 7507 A	AF4558	S 7549 A	AF928M	S 7359 A	FF5695	S 6024 NE
AF25382	S 7284 A	AF26401	S 7558 A	AF4559	S 7578 A	AF954M	S 1005 A	FF5709	S 6710 NR
AF25426	S 7409 A	AF26402	S 7559 A	AF4560	S 7337 A	AF968	S 0070 A	FF5769	S 6039 NE
AF25427	S 7279 A	AF26403	S 7A14 A	AF4575	S 5250 A	AF969	S 7281 A	FF5790	S 4480 NR
AF25428	S 7280 A	AF26415	S 7B10 A	AF4583M	S 7368 A	AF970	S 0550 A	FF5802	S 2320 NR
AF25437	S 9870 A	AF26457	S 7679 A	AF4608	S 3051 A	AF971	S 5270 A	FF5834	S 6034 NE
AF25439	S 7404 A	AF26463	S 3217 C	AF4630	S 8570 A	AF977	S 3570 A	FF5847	S 6148 NE
AF25454	S 7421 A	AF26472M	S 7F18 A	AF4631	S 0050 A	AF978	S 6370 A	FF5857	S 6043 NE
AF25468	S 7422 A	AF26475	S 9380 A	AF4638	S 6870 A	AF981	S 1070 A	FF5858	S 6044 NE
AF25476	S 7469 A	AF26476	S 7A29 A	AF4641M	S 2070 A	AF989	S 9990 A	FF5863	S 6150 NE
AF25478	S 7A17 A	AF26670	S 4347 CA	AF4643	S 7017 A	AS2474	S 7A86 A	FF73100	S 6088 NE
AF25479	S 7A13 A	AF26671	S 3165 C	AF4644	S 7338 A	AS2495	S 7B11 A	FF73100	S 6089 NE
AF25496	S 8502 A	AF26677	S 7A11 A	AF4645	S 7638 A	CS41000	S 5900 PO	FS1000	S 4478 NR
AF25522	S 7608 A	AF26678	S 7649 A	AF4691	S 7940 A	CS41001	S 5902 PO	FS1242	S 4470 NR
AF25523	S 7408 A	AF27689	S 7B45 A	AF471	S 7024 A	CS41003	S 5903 PO	FS1254	S 0999 NR
AF25557	S 7356 A	AF27692	S 3289 C	AF4713	S 1670 A	CS41004	S 5900 PO	FS1276	S 8500 NR
AF25602	S 7617 A	AF27708	S 7A25 A	AF471M	S 7024 A	CS41005	S 5903 PO	FS19551	S 4138 NR
AF25614	S 7970 A	AF27711	S 7A26 A	AF472	S 7945 A	FF105	S 4510 NR	FS19591	S 4159 NR
AF25615	S 7405 A	AF27816	S 3373 A	AF4720	S 0070 A	FF144	S 6481 N	FS19599	S 4378 NR
AF25619	S 7564 A	AF27817	S 7259 A	AF4725	S 7214 A	FF145	S 8381 NC	FS19605	S 6062 NE
AF25620	S 7565 A	AF27819	S 7091 A	AF4727	S 7288 A	FF146	S 7411 N	FS19689	S 4089 NR
AF25623	S 7A59 A	AF27853	S 7393 A	AF472M	S 7945 A	FF147	S 1411 N	FS19704	S 4461 NR
AF25626	S 7575 A	AF27857	S 7A50 A	AF4737	S 7186 A	FF167	S 7112 NC	FS19735	S 4461 NR
AF25627	S 7615 A	AF27878	S 7650 A	AF4746	S 7A34 A	FF167A	S 7111 NC	FS19737	S 4479 NR
AF25630	S 3053 C	AF27940	S 7B36 A	AF4747	S 7221 A	FF185	S 0810 NR	FS19769	S 4142 NR
AF25631	S 7347 A	AF27970	S 7A03 A	AF4775	S 4270 A	FF214	S 8501 NR	FS19781	S 1H20 NR
AF25632	S 7345 A	AF27974	S 7644 A	AF4841	S 7343 A	FF214-N1	S 8501 NR	FF214-N1	S 4475 NR
AF25634	S 7406 A	AF27995	S 7D41 A	AF4842	S 7185 A	FF214A	S 8501 NR	FS19821	S 1999 NR
AF25653	S 7383 A	AF289	S 7023 A	AF4857KM	S 2370 A	FF226	S 0510 NR	FS19895	S 4158 NR
AF25695	S 3072 C	AF289M	S 7023 A	AF4858KM	S 7479 A	FF230	S 6311 N	FS19907	S 4021 NR
AF25704	S 7A15 A	AF303	S 7002 A	AF4867	S 7342 A	FF231	S 6710 NR	FS19914	S 4121 NR
AF25721	S 7516 A	AF303M	S 7002 A	AF486K	S 2370 A	FF254	S 4120 NR	FS19918	S 4157 NR
AF25723	S 7506 A	AF336M	S 8350 A	AF4895	S 7091 A	FF271	S 6072 NE	FS19920	S 4146 NR
AF25724	S 7507 A	AF350K	S 0060 A	AF4898	S 7474 A	FF4033	S 0201 N	FS19932	S 4143 NR
AF25731	S 3373 A	AF350KM	S 0060 A	AF4906	S 1506 A	FF4052	S 8111 NC	FS19948	S 1071 B
AF25733	S 3056 C	AF351K	S 6940 A	AF4907	S 1540 A	FF4052A	S 8111 NC	FS19950	S 4472 NR
AF25756	S 7423 A	AF351KM	S 6940 A	AF490M	S 8940 A	FF4070	S 8110 NR	FS19966	S 4157 NR
AF25769	S 7558 A	AF352	S 7026 A	AF4910	S 9240 A	FF4080	S 6911 N	FS20082	S 4477 NR
AF25797	S 3541 A	AF352M	S 7026 A	AF4915	S 3030 A	FF4141	S 0101 N	HF28806	S 8137 RH
AF25812	S 7B80 A	AF353K	S 0940 A	AF4916	S 3059 A	FF5017	S 0810 NR	HF28917	S 5613 PO
AF25813	S 7B81 A	AF353KM	S 0940 A	AF4920	S 7168 A	FF5018	S 5400 NR	HF35489	S 5664 PO
AF25829	S 3066 C	AF354	S 7011 A	AF4927	S 7372 A	FF5039	S 0710 NR	HF35493	S 5663 PO
AF25840	S 3062 C	AF354M	S 7011 A	AF4942	S 7277 A	FF5043	S 0610 NR	HF6096	S 1600 R
AF25872	S 7F15 A	AF361	S 7010 A	AF4966	S 7092 A	FF5048	S 3010 N	HF6118	S 3301 PO
AF25875	S 7625 A	AF361M	S 7010 A	AF4968	S 7187 A	FF5050	S 9091 N	HF6161	S 8790 PO
AF25876	S 7626 A	AF362	S 9990 A	AF4970	S 7222 A	FF5053	S 2161 N	HF6162	S 3081 PO
AF25894	S 7619 A	AF362M	S 9990 A	AF4972	S 7183 A	FF5054	S 2162 N	HF6182	S 5569 PO
AF25895	S 0VGT A	AF4018	S 2460 A	AF4984	S 7A24 A	FF5060	S 8500 NR	HF6449	S 6449 PO
AF25896	S 7616 A	AF4020	S 7808 A	AF4992	S 7138 A	FF5064	S 4311 N	HF7831	S 6449 PO
AF25898	S 2764 A	AF4027	S 4450 A	AF55702	S 4225 CA	FF5065	S 5911 N	HF7999	S 2234 Z
AF25899	S 7651 A	AF4039	S 6450 A	AF55709	S 3448 C	FF5074	S 4323 NR	LF16015	S 0620 R
AF25956	S 3059 C	AF4040	S 2450 A	AF55712	S 4260 CA	FF5094	S 0710 NR	LF16042	S 5045 PE
AF25969	S 7A44 A	AF4057	S 0270 A	AF55713	S 3161 C	FF5100	S 0101 N	LF16046	S 5062 PE
AF25972	S 3055 C	AF4058	S 0950 A	AF55714	S 4346 CA	FF5107	S 9960 NC	LF16176	S 5011 PE
AF25975	S 7573 A	AF4059K	S 0850 A	AF55717	S 3283 C	FF5112	S 2610 NR	LF16232	S 5234 PE
AF25976	S 7A16 A	AF4060	S 0450 A	AF55719	S 4177 CA	FF5135	S 8500 NR	LF16233	S 5081 PE
AF26139	S 3092 C	AF4061	S 7045 A	AF55721	S 3081 C	FF5135A	S 8500 NR	LF16327	S 8600 R
AF26144	S 3054 C	AF4067	S 0650 A	AF55722	S 3221 C	FF5139	S 8500 NR	LF16351	S 5097 PE
AF26145	S 3139 C	AF4069	S 2650 A	AF55748	S 3443 C	(MAN)	S 4378 NR	LF17056	S 5046 PE
AF26146	S 3078 C	AF4084	S 8450 A	AF55759	S 4349 CA	FF5153	S 9600 NR	LF17472	S 0920 R
AF26162	S 7484 A	AF409K	S 8950 A	AF55765	S 3459 C	FF5156	S 8501 NR	LF17474	S 5156 PE
AF26163M	S 7F18 A	AF409KM	S 8950 A	AF55785	S 3279 C	FF5167	S 4323 NR	LF17486	S 5181 PE

**CROSS REFERENCES > CORRISPONDENZE >
CORRESPONDANCES > VERGLEICHNUMMERN > CRUCE DE REFERENCIAS**

LF17487	S 5044 PE	LF3893	S 0580 PO	1495705	S 0280 PO	5000861	S 7600 R	5025101	S 1410 NR
LF17497	S 5820 R	LF3895	S 5044 PE	1498018	S 6100 R	5000862	S 5600 R	5026836	S 8111 NC
LF17502	S 4120 R	LF3914	S 5036 PE	1498028		5001123	S 3102 R	508E-6731	S 6380 PO
LF17503	S 4402 R	LF3934	S 3497 R	(O/OR)	S 5603 R	5001124	S 0700 R	528E-6731	S 7380 PO
LF17505	S 0900 R	LF3959	S 3497 R	1498028	S 5601 R	5001248	S 1270 R	528E-6731-A	S 7380 PO
LF17511	S 5156 PE	LF3997	S 5013 PE	1498427	S 0660 A	5001753	S 0122 O	59A-18660-A1	S 4000 O
LF17513	S 4402 R	LF3998	S 5381 PO	1501433	S 6380 PO	5002230	S 1270 R	59A-6714-A	S 4000 O
LF17522	S 5147 PE	LF3999	S 5132 PE	1502255	S 8501 NR	5002451	S 6180 PO	59LK-6714-A	S 5600 R
LF17527	S 5240 PE	LF4000	S 4080 PO	1503833	S 2460 A	5002468	S 0660 A	5EH-18662-A	S 4000 O
LF17529	S 5235 PE	LF4001	S 7380 PO	1515160	S 1270 R	5002704	S 2510 O	6061629	S 5600 R
LF17534	S 5239 PE	LF4003	S 5446 PO	1523494	S 3102 R	5003460	S 2030 R	6063340	S 6100 R
LF17546	S 5111 PE	LF4006	S 0900 R	1537614	S 0810 NR	5003461	S 2030 R	6106841	S 8600 R
LF17547	S 5102 PE	LF4008	S 5236 PE	1538624	S 6481 N	5003559	S 1270 R	6119196	S 3280 R
LF17548	S 5237 PE	LF4015	S 1600 R	1538625	S 6481 N	5003559		6124136	S 6710 NR
LF3311		LF4016	S 5600 R	1538884	S 4380 PO	(VOLVO)	S 3257 R	6135130	S 8500 NR
(ALTRE/OTHER APPL.)	S 1600 R	LF4017	S 5800 R	1555451	S 1270 R	5003560	S 1270 R	6143136	S 3330 A
LF3313	S 5600 R	LF4053	S 7260 PO	1555451		5003560		6149716	S 7111 NC
LF3314	S 3102 R	LF4054	S 8600 R	(VOLVO)	S 3257 R	(VOLVO)	S 3257 R	6149717	S 7112 NC
LF3320	S 8260 PO	LF4055	S 0420 R	1556297	S 1270 R	5003561	S 1270 R	6153085	S 7330 R
LF3321	S 0900 R	LF4056	S 7600 R	1564767		5003561		6161789	S 7111 NC
LF3327	S 7261 PO	LF4072	S 0530 PO	(VOLVO)	S 3257 R	(VOLVO)	S 3257 R	6164913	S 9960 NC
LF3331	S 5800 R	LF4081	S 0580 PO	1564767	S 1270 R	5003915	S 1270 R	6184942	S 3280 R
LF3346	S 0230 R	LF4104	S 3106 R	1565204	S 0420 R	5003915		6202100	S 9960 NC
LF3350	S 9490 PO	LF4105	S 2530 PO	1565486		(VOLVO)	S 3257 R	6203126	S 3280 R
LF3355	S 5124 PE	LF4112	S 9030 R	(VOLVO)	S 3257 R	5003931	S 1270 R	692M-6714-AA	S 1270 R
LF3357	S 0300 O	LF4154	S 5802 R	1565486	S 1270 R	5003931		6L-7440	S 0810 NR
LF3358	S 4000 O	LF509N		1568409	S 4380 PO	(VOLVO)	S 3257 R	70HM-6714-AA	S 1270 R
LF3364	S 0122 O	(ALCUNE/SOME APPL.)	S 3301 PO	1568410	S 6380 PO	5003932	S 1270 R	70HM-6714-BB	S 1270 R
LF3372	S 8020 R	LF509N		1582092	S 3409 R	5003932		70HP-6714-AB	S 1270 R
LF3373	S 0120 R	(ALCUNE/SOME APPL.)	S 3300 PO	1582261	S 7111 NC	(VOLVO)	S 3257 R	712E-9601-A	S 2460 A
LF3376	S 2329 R	LF510	S 4000 O	1583371	S 8111 NC	5004747	S 2030 R	712E-9601-B	S 2460 A
LF3379	S 0900 R	LF551A	S 5600 R	1584502	S 7004 A	5004777	S 4000 O	712F-9601-BA	S 2460 A
LF3391	S 0300 O	LF558	S 1910 PO	1612184	S 7330 R	5004784	S 0101 N	715F-6731-BA1A	S 4380 PO
LF3395	S 5536 PO	LF566	S 0280 PO	1614735	S 5600 R	5005831	S 2810 A	715F-9150-ABA	S 8501 NR
LF3397	S 2510 O	LF580	S 5700 R	1635103	S 7111 NC	5006573	S 0660 A	715HF-6731-AA	S 6380 PO
LF3400		LF594	S 1080 PO	1641158	S 6100 R	5006580	S 5700 R	71HM-6714-BA	S 1270 R
(ALTRE/OTHER APPL.)	S 1600 R	LF595	S 3081 PO	1641187	S 3280 R	5007123	S 0122 O	7235770	S 7111 NC
LF3400		LF596	S 3180 PO	1700425	S 8950 A	5007124	S 2030 R	74HM-6714-AA	S 1270 R
(VOLVO)	S 3257 R	LF598	S 4380 PO	1715757	S 7380 PO	5007366	S 2030 R	74HM-6714-BA	S 1270 R
LF3402	S 3241 R	LF599	S 6380 PO	1715762	S 6481 N	5007385	S 8310 R	74HM-6714-BB	
LF3404	S 3280 R	LF633	S 6180 PO	1718968	S 3180 PO	5008677	S 1600 R	(VOLVO)	S 3257 R
LF3410	S 4120 R	LF667	S 0900 R	1771007	S 4380 PO	5008874	S 2610 NR	74HM-6714-BB	S 1270 R
LF3413	S 8600 R	LF670	S 3409 R	1771008	S 4380 PO	5008879	S 1013 B	74HM-6714-CB	
LF3449	S 3241 R	LF673	S 3106 R	1794446	S 5600 R	5008885	S 9091 N	(VOLVO)	S 3257 R
LF3451		LF682	S 0700 R	1829195	S 5600 R	5009064	S 2810 A	74HM-6714-CB	S 1270 R
(O/OR)	S 5603 R	LF689	S 1270 R	1P-2299	S 0810 NR	5010462	S 8500 NR	753F-6731-AA1A	S 6380 PO
LF3451	S 5601 R	LF697	S 0420 R	200E-9176	S 8111 NC	5010518	S 7111 NC	753F-6731-BA1A	S 4380 PO
LF3466	S 5600 R	LF699	S 0420 R	213E-9601-A	S 2460 A	5010664	S 8600 R	755F-6714-AAA	S 6380 PO
LF3476	S 0900 R	LF700	S 1380 R	2700E-6731-A	S 6380 PO	5010666	S 7600 R	75PF-6714-AA	S 0420 R
LF3477	S 0900 R	LF701	S 9400 R	2701E-6731-A	S 6380 PO	5010961	S 2510 O	775F-9150-AA	S 7111 NC
LF3480	S 3003 DR	LF740	S 1910 PO	2701E-9150-A	S 7112 NC	5010962	S 8310 R	77HB-9601-AA	S 7004 A
LF3481	S 3003 DR	LF756		2701E-9150-B	S 7111 NC	5011332	S 6940 A	78TM-6714-BA	S 6100 R
LF3482	S 5003 DR	(DAF, MWM)	S 6490 PO	2701E-9155-B	S 7112 NC	5011417	S 0900 R	7HA-6714-A2	S 4000 O
LF3484	S 1220 R	LF764	S 1600 R	2701E-9167-B	S 7111 NC	5011426	S 7261 PO	7HA-6731-A	S 4000 O
LF3487	S 5600 R	LF785	S 2030 R	2701E-9176-A	S 7111 NC	5011502	S 0900 R	7HA-6744-A	S 4000 O
LF3489	S 0700 R	LF787	S 0420 R	2701E-9K600	S 8950 A	5011561	S 6940 A	825F-9150-A1A	S 7111 NC
LF3493	S 3275 R	LF791	S 4080 PO	2703E-6731-A	S 4380 PO	5011788	S 0130 R	825F-9150-A1B	S 7111 NC
LF3506	S 3292 R	MK12059		2704E-9150	S 7111 NC	5011991	S 0130 R	83EM-6714-BA	S 7330 R
LF3565	S 3698 R	(N.2 FILTRI/FILTERS)	S 5549 PO	2710E-9601-A	S 2460 A	5012035	S 6100 R	844F-6714-A1A	S 3280 R
LF3568	S 2030 R	MK13301	S 6147 NE	2715E-6731-A	S 4380 PO	5012045	S 9091 N	844F-6714-A1B	S 3280 R
LF3570	S 1220 R	UF101	S 4405 U	2720E-4601-A	S 5600 R	5012553	S 9080 PO	844F-6714-AA	S 3280 R
LF3572	S 3260 R	WF2069	S 8410 AR	2720E-6714	S 1270 R	5012554	S 8310 R	86HF-9601-AA	S 3330 A
LF3573	S 5124 PE	WF2096	S 9006 AR	2720E-6714-A	S 1270 R	5012582	S 8500 NR	87HX-9601-AA	S 3330 A
LF3575	S 9710 R	WF2142	S 9007 AR	2720E-6714-AA	S 1270 R	5013135	S 0660 A	8CM-6731-A	S 4000 O
LF3581	S 3292 R			2724E-6714-A	S 1270 R	5013146	S 6100 R	8RT-6714-A	S 4000 O
LF3583	S 3003 DR	FORD	SOFIMA	2724E-6714-AA	S 1270 R	5013148	S 3102 R	900X-6714	S 3003 DR
LF3584	S 7510 O			2724E-6714-B	S 1270 R	5014055	S 3102 R	914F-6714-AA	S 3280 R
LF3594	S 5003 DR	1022920	S 7600 NR	2724E-6714-C	S 1270 R	5014056	S 5700 R	927A-6731	S 3180 PO
LF3595	S 2003 DR	1059924	S 3280 R	2724E-6731-C	S 1270 R	5014353	S 2610 NR	93FF-9150-AA	S 7111 NC
LF3598	S 7260 PO	1100696	S 5011 PE	272E-6714-A	S 5600 R	5014354	S 9091 N	957E-6731-A	S 3180 PO
LF3606	S 3408 R	1112652	S 3102 R	2M5Q-6714-AB	S 3280 R	5014391	S 0122 O	9H-4729	S 7380 PO
LF3607	S 5549 PO	1112654	S 1410 NR	2M5Q-6714-AC	S 3280 R	5014771	S 0660 A	A690X-6731-CA	S 1270 R
LF3625	S 8600 R	1136568	S 3280 R	3707442	S 5600 R	5016966	S 7510 O	A700X-6714-HA	S 1270 R
LF3647	S 5630 R	11425472	S 1270 R	3917626	S 8111 NC	5017033	S 1506 A	A700X-6714-SA	
LF3654	S 4120 R	11436936	S 1270 R	3947506	S 1270 R	5017831	S 9600 NR	(O/OR)	S 5603 R
LF3655	S 3280 R	11464467	S 1270 R	3H-219	S 6940 A	5019420	S 2510 O	A700X-6714-SA	S 5601 R
LF3659	S 3102 R	11464497	S 1270 R	4M5Q-6714-BA	S 3280 R	5019424	S 0420 R	A700X-6744-DA	S 4380 PO
LF3675	S 4402 R	11464498	S 1270 R	5000187	S 1600 R	5020031	S 3330 A	A710X-6714-CA	S 1270 R
LF3730	S 4402 R	1148703	S 3280 R	5000187		5020307	S 9960 NC	A710X-6714-EA	S 1270 R
LF3737	S 3010 R	1207066	S 3280 R	(VOLVO)	S 3257 R	5020403	S 8500 NR	A720X-6714-RA	S 1600 R
LF3754	S 5005 PE	1213439	S 5600 R	5000513	S 5600 R	5022747	S 9240 A	A720X-6714-RA	
LF3758	S 3257 R	1231233	S 3280 R	5000531	S 3180 PO	5022884	S 9240 A	(VOLVO)	S 3257 R
LF3770	S 8310 R	1322152	S 3280 R	5000679	S 4000 O	5022955	S 3280 R	A730X-6714-E3A	S 5800 R
LF3775	S 4000 O	1419455	S 0060 A	5000836	S 1080 PO	5023925	S 7380 PO	A730X-6731-T3A	S 3180 PO
LF3827	S 5007 PE	1423477	S 7112 NC	5000848	S 2530 PO	5024424	S 6100 R	A770X-6714-AAA	S 1270 R
LF3829	S 5006 PE	1475507	S 6180 PO	5000856	S 5800 R	5025089	S 3003 DR	A770X-6714-AAA	
LF3854	S 3577 R	1485888	S 2460 A	5000857	S 5800 R	5025091	S 3003 DR	(VOLVO)	S 3257 R
LF3867	S 5016 PE	1495704	S 4080 PO	5000858	S 5800 R	5025096	S 7600 NR	A770X-6714-KA	S 1270 R



**CROSS REFERENCES > CORRISPONDENZE >
CORRESPONDANCES > VERGLEICHNUMMERN > CRUCE DE REFERENCIAS**

A770X-6714-KA (VOLVO)	S 3257 R	DONN-9176-B	S 7112 NC	D14E135H	S 9080 PO	E133.24	S 6490 PO	E251.14	
A770X-6714-LA	S 1270 R	DONN-9N074-B	S 7111 NC	D16E170HN	S 7510 O	E133L	S 5250 A	(ALTRE/OTHER APPL.)	S 7261 PO
A770X-6714-LA (VOLVO)	S 3257 R	DORY-9601-C	S 2460 A	D23E197.24	S 5549 PO	E134HD06	S 5099 PE	E251.14	
A770X-6714-MA	S 1270 R	E110-29	S 6181 N	D28E160H01	S 5007 PE	E134HD31	S 5131 PE	(MAN)	S 7260 PO
A770X-6714-MA (VOLVO)	S 3257 R	E1ADDN-9155-A	S 6181 N	D28E161H	S 5005 PE	E135HD14	S 9080 PO	E251H	
A770X-6714-RA	S 1270 R	E1ADDN-99162-A	S 6181 N	D31E134.24	S 5381 PO	E13HD47	S 5016 PE	(ALTRE/OTHER APPL.)	S 7261 PO
A770X-6714-RA (VOLVO)	S 3257 R	E1ADKN-18631-C	S 6380 PO	D31E197.24	S 3631 PO	E140.33	S 0280 PO	E251H	
A770X-6714-RA (VOLVO)	S 1270 R	E1ADKN-99162-B	S 6181 N	E0530K01	S 6063 NE	E140H	S 0280 PO	(MAN)	S 7260 PO
A770X-6714-RA (VOLVO)	S 1270 R	E1DDN-99162-B	S 6181 N	E0530K02	S 6064 NE	E149L	S 7550 A	E251HD11	S 7261 PO
A770X-6714-RA (VOLVO)	S 3257 R	E37-CL9	S 6181 N	E10.18	S 3081 PO	E150L	S 7839 A	E251L	S 7428 A
A770X-6714-UA	S 1270 R	E4FZ-6731-AB	S 7500 R	E10.18H	S 3081 PO	E1516L	S 6303 A	E257L	S 7168 A
A770X-6714-UA (VOLVO)	S 1270 R	E4NN-6714-AA	S 1270 R	E100.34	S 6380 PO	E1545L	S 7A09 A	E264L	S 5650 A
A770X-6714-UA (VOLVO)	S 3257 R	E8NN-6714-AA	S 1270 R	E1006L	S 7642 A	E1547L	S 8350 A	E270L	S 7544 A
B7A-6714-A	S 5600 R	E99-29	S 6181 N	E1007L	S 7644 A	E154HD48	S 5011 PE	E272L	S 7213 A
B7A-6731-A	S 5600 R	E9AE-6714-B	S 5600 R	E1007LS	S 7646 A	E1572L	S 7F27 A	E273L	S 7185 A
B7A-6731-B	S 5600 R	EAA-6715-A	S 4000 O	E1008L	S 2764 A	E1573L	S 7F29 A	E275L	S 6370 A
B8A-6731-A	S 5600 R	ECG-6714-A	S 5600 R	E1008L01	S 7B10 A	E1573LS	S 7F28 A	E276L	S 3570 A
B9AE-6714-A2	S 5600 R	ECZ-6714-C	S 5600 R	E100H	S 6380 PO	E160H01D28	S 5007 PE	E279L	S 5270 A
B9AE-6714-A6	S 5600 R	EDC-6714-A	S 5600 R	E100UD160	S 4402 U	E161H01D28	S 5036 PE	E280L	S 1070 A
B9AE-6714-B	S 5600 R	EDG-6714-A	S 5600 R	E1013L	S 7B36 A	E161HD28	S 5005 PE	E281L	S 0550 A
B9LE-6714-A	S 5600 R	EDG-6714-C	S 5600 R	E1013LS	S 7D41 A	E164L	S 7813 A	E281L01	S 7186 A
C1AZ-6731-A	S 5600 R	EDPN-9N074-AA	S 7112 NC	E1016L	S 7A50 A	E170HND16	S 7510 O	E282L	S 7028 A
C2TA-6708-A	S 6380 PO	EOIA-18694	S 4000 O	E101UD178	S 4401 U	E172HD35	S 5095 PE	E283L	S 0050 A
C2TA-9150-A	S 6181 N	EOTA-67310	S 4000 O	E1021L	S 7645 A	E174.14		E284L	S 9570 A
C2TA-9150-B	S 6181 N	EPN-6731-A	S 1080 PO	E1024L01	S 7A03 A	(ALTRE/OTHER APPL.)	S 8260 PO	E285L	S 7940 A
C2TZ-6708-A	S 6380 PO	EPN-6731-B	S 3180 PO	E1024LS	S 7A04 A	E174H		E286L	S 7987 A
C2TZ-6731-A	S 6380 PO	EPN-99162-A	S 6181 N	E1028L	S 7F13 A	(ALTRE/OTHER APPL.)	S 8260 PO	E288L	S 8450 A
C2TZ-9155-B	S 6181 N	EPN-99162-B	S 6181 N	E1030K	S 6062 NE	E174HD11	S 8260 PO	E289L	S 6450 A
C2TZ-9365-A	S 6181 N	GC46-6744-AC	S 3572 R	E1030K01	S 6059 NE	E175HD129	S 5062 PE	E290L	S 7358 A
C3AE-6714-A	S 5600 R	GC46-9176-AB	S 4348 NR	E1033L	S 7C13 A	E175HD68	S 5062 PE	E291LI	S 3445 C
C3AE-6714-B	S 5600 R	GPW-18632	S 4000 O	E103KPO1D197-2	S 6147 NE	E1800L	S 7516 A	E2916LC	S 4161 CA
C3TA-9176-A	S 7111 NC	JIJ6-6744-AA	S 3572 R	E103KPD197	S 6147 NE	E181HD252	S 5236 PE	E2916LI	S 3137 C
C3TZ-9365-A	S 7111 NC	MHK-6714-A	S 5600 R	E103UD295	S 4405 U	E182.30	S 5536 PO	E291L	S 0070 A
C4AE-6714-A	S 5600 R	OBA-6731-A	S 4000 O	E1059L	S 7F21 A	E183H	S 5536 PO	E2927LI	S 3217 C
C4AZ-6731-A	S 5600 R	OCM-6714-A	S 4000 O	E1060L01	S 7F22 A	E1900L	S 7506 A	E2941LI	S 3279 C
C5NE-9176-A	S 7111 NC	OCM-6714-A1	S 4000 O	E10H01	S 3081 PO	E1900LS	S 7507 A	E2950LI	S 3451 C
C5NE-9176-CQTXL	S 7111 NC	OCM-6714-A2	S 4000 O	E10H02	S 3081 PO	E1905LI	S 3051 A	E2953LI	S 3161 C
C6JZ-9600-B	S 8950 A	OEL-6714-A	S 4000 O	E10KFR	S 0201 N	E1908LC	S 4346 CA	E2960LI	S 3289 C
C6TZ-6714-A	S 1270 R	OHA-6714-A	S 4000 O	E10KFR4D10	S 2162 N	E1908LI	S 3078 C	E297L	S 7280 A
C6TZ-9600-A	S 2950 A	R1A	S 5600 R	E10KFRD10	S 2162 N	E1923LI	S 3447 C	E2986LC	S 4349 CA
C7NN-6174-B	S 5600 R	R1D	S 4000 O	E10KP	S 1411 N	E1945LI	S 3438 C	E2986LI	S 3459 C
C7NN-6N605-A	S 4000 O	T221771	S 3572 R	E10KPD10	S 1411 N	E1947LI	S 3023 C	E2KP	S 6311 N
C7NN-9176-A	S 7111 NC	T222644	S 4348 NR	E110.14	S 8790 PO	E195.30	S 0530 PO	E306L	S 7608 A
C7NN-9176-C	S 7111 NC	XM21-6744-AA	S 5011 PE	E110M	S 0122 O	E1958LI	S 3448 C	E307L	S 8502 A
C7TZ-6731-A	S 6380 PO	XM3J-6731-FA	S 5600 R	E110MD02	S 0122 O	E195H	S 0530 PO	E311H01D273	S 5111 PE
C7TZ-6731-B	S 4380 PO	XS4Q-6714-AA	S 3280 R	E111H	S 8790 PO	E196.57	S 2530 PO	E312L	S 7279 A
C7TZ-9365-A	S 7111 NC	XS4Q-6714-AB	S 3280 R	E112L	S 0650 A	E196.57/2	S 2530 PO	E313L	S 9870 A
C7TZ-9365-B	S 6181 N	XW4E-6714-EA	S 7500 R	E113L	S 4940 A	E196HN	S 2510 O	E314L	S 7469 A
C7TZ-9365-C	S 7111 NC	YL4J-9155-BA	S 1410 NR	E113LS	S 7165 A	E196HND03	S 2510 O	E315L	S 3373 A
C7TZ-9365-PC	S 7111 NC			E114.205	S 3180 PO	E1970LI	S 3452 C	E315L01	S 3373 A
C8AF-9614-A	S 5600 R	HAULAMATIC	SOFIMA	E114H	S 3180 PO	E197HD06	S 5124 PE	E316L	S 7285 A
C8TZ-9601-C	S 2370 A	900009	S 4380 PO	E114L	S 0950 A	E197HD31	S 5132 PE	E317L	S 7278 A
C9TZ-9601-B	S 6940 A	900013	S 7111 NC	E114LS	S 1940 A	E198H	S 2530 PO	E320L	S 7575 A
C9TZ-9635-A	S 7112 NC	900019	S 8950 A	E1150L	S 7C16 A	E198H02	S 2530 PO	E34HD213	S 5045 PE
CAPN-9162-A	S 4211 N	900020	S 0150 A	E115L	S 2450 A	E198HD09	S 2530 PO	E361HD312	S 5239 PE
CAPN-99126-A	S 4211 N	900045		E115LS	S 3940 A	E1994LI	S 3283 C	E361L	S 7383 A
CAPN-99162-A	S 4211 N	(N.2 FILTRI/FILTERS)	S 0420 R	E1162L	S 3B55 A	E199L	S 3030 A	E361L01	S 7383 A
CC11AZ-6731-A	S 5600 R	949072	S 6180 PO	E116L	S 2650 A	E20.14	S 0300 O	E366L	S 7371 A
CC1A-2671-A	S 5600 R	HEATHFIELD	SOFIMA	E116L01	S 0270 A	E200.335	S 0580 PO	E390L	S 7387 A
CJLE-9176-A	S 7111 NC	14791201	S 6550 A	E116LS	S 7129 A	E200M	S 0300 O	E391LI	S 3072 C
CJNE-9176-A	S 7112 NC	14791202	S 2840 A	E117.34	S 4380 PO	E200MD05	S 0300 O	E3937LI	S 3454 C
COAE-6714-A	S 5600 R	1480C4	S 3301 PO	E117L	S 0450 A	E209L	S 3059 A	E3943LI	S 3460 C
COAE-6731-A	S 5600 R	PC53029	S 5446 PO	E117LS	S 1450 A	E20N	S 0300 O	E39H	S 2234 Z
COAE-6731-AP	S 5600 R			E118.33	S 4080 PO	E210L	S 7998 A	E39HD119	S 2234 Z
COLE-6714-A	S 5600 R			E118L	S 1050 A	E213HD300	S 5102 PE	E39HD120	S 2234 Z
CONN-9155-B	S 4211 N			E118L01	S 4270 A	E213L	S 7431 A	E39HD131	S 2234 Z
D1NN-6714-C	S 5600 R			E118L02	S 1670 A	E214L	S 7187 A	E416HD86	S 5097 PE
D1PJ-9601-DA	S 2460 A			E118LS	S 1307 A	E214LS	S 7482 A	E416KPD36	S 6039 NE
D1RY-6731-A	S 1270 R			E118LS02	S 7474 A	E218L	S 8570 A	E41H	S 5613 PO
D2NN-6714-A	S 5600 R	0014776301	S 1013 B	E119H	S 4380 PO	E218LS	S 7288 A	E420L	S 7345 A
D2NN-6714-C	S 0420 R	AS12M	S 7B11 A	E119L	S 7361 A	E219L	S 7183 A	E420LS	S 7576 A
D3HZ-6731-B	S 0420 R	AS376M	S 7266 A	E119L74	S 7562 A	E21HD361	S 5044 PE	E422HD86	S 5046 PE
D5ZZ-6731-A	S 1270 R	D02E110M	S 0122 O	E11HD204	S 5159 PE	E222L	S 7277 A	E422KP04D322	S 6150 NE
D8NN-6714-GA	S 5600 R	D03E196HN	S 2510 O	E11HD57	S 5013 PE	E222LS	S 7572 A	E422KPD98	S 6011 NE
D8NN-6714-LA	S 0420 R	D04E120M	S 4000 O	E11S03D65	S 6088 NE	E230.36H	S 3301 PO	E423HD147	S 5147 PE
D8NN-9176-AA	S 8111 NC	D05E120M	S 4000 O	E11S04D65	S 6089 NE	E235.41/1	S 1910 PO	E423KPD206	S 6072 NE
D9AE-6714-AA	S 5600 R	D05E200M	S 0300 O	E12.14	S 4000 O	E235.41C	S 1910 PO	E424L	S 7970 A
D9AZ-6731-A	S 5600 R	D06E196.24	S 5124 PE	E120M	S 4000 O	E235H01	S 1910 PO	E426L	S 7651 A
D9NN-6714-EA	S 5600 R	D06E197.24	S 5124 PE	E120MD04	S 4000 O	E235H03	S 1910 PO	E428L01	S 7E35 A
D9NN-6744-CA	S 0700 R	D09E196.57	S 2530 PO	E120MD05	S 4000 O	E237L	S 1970 A	E428L01	S 7619 A
DITS-9600-AA	S 0060 A	D10E10KFR	S 0201 N	E123H01D194	S 5181 PE	E237LS	S 7405 A	E428LS	S 7616 A
DOHZ-9601-G	S 6550 A	D10E10KFR2	S 2162 N	E1248L	S 7679 A	E240L	S 3080 A	E433L	S 7563 A
DOHZ-9601-H	S 7945 A	D10E10KFR4	S 2162 N	E125KPD302	S 6044 NE	E240L01	S 3082 A	E433LS	S 7390 A
DOJJ-9600-B	S 8950 A	D10E10KP	S 1411 N	E127L	S 2070 A	E243.14	S 9490 PO	E434L	S 7356 A
DONN-6714-B	S 5600 R	D11E174.14	S 8260 PO	E127L01	S 7161 A	E243H	S 9490 PO	E438KPD267	S 6034 NE
		D11E251.14	S 7261 PO	E127LS	S 7160 A	E243HD13	S 9490 PO	E43HD213	S 5234 PE
		D12ESKFR2	S 2161 N	E128KPD302	S 6043 NE	E244L	S 1506 A	E43HD97	S 5234 PE
		D13E243.14	S 9490 PO	E129L	S 6550 A	E245L	S 1540 A	E442KPD319	S 6148 NE

**CROSS REFERENCES > CORRISPONDENZE >
CORRESPONDANCES > VERGLEICHNUMMERN > CRUCE DE REFERENCIAS**

E451L	S 7286 A	E721L	S 0940 A	H12W08	S 5820 R	H31WK01	S 2610 NR	SA16283	S 7576 A
E452L	S 7357 A	E743L	S 7637 A	H14/2W	S 2030 R	H322WK	S 5394 GC	SA16296	S 7444 A
E452L01	S 7643 A	E75.25K	S 4211 N	H140WK	S 2320 NR	H322WK01	S 5394 GC	SA16321	S 7347 A
E452LS	S 7406 A	E75/1K	S 7111 NC	H140WK01	S 2320 NR	H328WK	S 4146 NR	SA16358	S 7641 A
E454L	S 7284 A	E750L	S 6650 A	H140WK02	S 4077 NR	H330WK	S 4112 NR	SA16365	S 0768 A
E454LS	S 7404 A	E75K	S 8381 NC	H14W03	S 1380 R	H338W	S 3102 R	SA16421	S 7484 A
E479L	S 7409 A	E75KD42	S 7111 NC	H14W04	S 7500 R	H34WF	S 9007 AR	SA16432	S 7A16 A
E483L	S 7A15 A	E76/1K	S 8111 NC	H152WK	S 4395 NR	H35WK	S 9600 NR	SA16441	S 7F19 A
E491L	S 7573 A	E761L	S 7372 A	H160WK	S 1H20 NR	H35WK01	S 9600 NR	SA16457	S 7617 A
E4926LJ	S 3315 C	E761LS	S 7342 A	H16W01	S 7500 R	H35WK02D87	S 9600 NR	SA16468	S 7F18 A
E492L	S 3541 A	E765L	S 7650 A	H17W01	S 3241 R	H398WK	S 4035 NR	SA16516	S 7A26 A
E4948LJ	S 3456 C	E767L	S 7F18 A	H17W02	S 5600 R	H40W	S 5700 R	SA16517	S 7A25 A
E4951LC	S 4351 CA	E767LS	S 7F19 A	H17W03	S 3241 R	H411WK	S 4150 NR	SA16571	S 7B45 A
E496L	S 7347 A	E76KD42	S 8111 NC	H17W04	S 7600 R	H413WK	S 4149 NR	SA16599	S 7B10 A
E496L01	S 7347 A	E76KPD111	S 4311 N	H17W05		H414WKD421		SA16612	S 7650 A
E496LS	S 7484 A	E77.34/1	S 7380 PO	(O/OR)	S 5603 R	(AIFO, CLAAS, NEW HOLLAND)	S 4480 NR	SA16697	S 7B36 A
E497L	S 7639 A	E794L	S 7B45 A	H17W05	S 5601 R	H566WK D556	S 4470 NR	SA16713	S 7C13 A
E4981LC	S 4314 CA	E807L	S 7A13 A	H17W06	S 9400 R	H60WK01	S 5400 NR	SA16747	S 7D41 A
E498L	S 7F15 A	E809L	S 7214 A	H17W11	S 3280 R	H60WK06	S 4323 NR	SA16862	S 7B39 A
E498L01	S 7F15 A	E810L	S 7641 A	H17W15	S 5603 R	H60WK07	S 4323 NR	SA17073	S 7432 A
E500HD129	S 5006 PE	E811L	S 7B01 A	H17W18	S 5601 R	H60WK08	S 4323 NR	SA17199	S 7409 A
E500KPD2D36	S 6001 NE	E821L	S 3340 A	H17W29	S 0920 R	H60WK09	S 4329 NR	SA17201	S 3373 A
E510H07D129	S 5156 PE	E824HD264	S 5237 PE	H17W30	S 5603 R	H700WK	S 4461 NR	SA17216	S 7482 A
E52KPD36	S 6017 NE	E82KPD36	S 6024 NE	H17WK02	S 6710 NR	H701WK		SA17221	S 7A15 A
E540L	S 7615 A	E82KPD73	S 6024 NE	H17WK03	S 4337 NR	(ALTRE/OTHER APPL.)	S 4121 NR	SA17224	S 7A14 A
E540LS	S 7422 A	E830HD253	S 5240 PE	H17WK04	S 0310 NR	H7025WK30	S 4461 NR	SA17228	S 7558 A
E541L	S 7573 A	E830HD366	S 5240 PE	H17WK05	S 4341 NR	H7062WK30	S 4158 NR	SA17237	S 7559 A
E541L01	S 7573 A	E831HD275	S 5235 PE	H17WK08	S 1410 NR	H7090WK10	S 4138 NR	SA17256	S 7E35 A
E541L02	S 7573 A	E83HD143	S 6449 PO	H17WK11	S 4341 NR	H7090WK30	S 4143 NR	SA17283	S 7616 A
E542L	S 7A16 A	E843L	S 5812 A	H18W01	S 8600 R	H7091WK10	S 4472 NR	SA17287	S 2764 A
E562L	S 7548 A	E844L	S 7423 A	H18W02	S 3106 R	H70WDK07	S 1378 NR	SA17306	S 7390 A
E563L	S 2950 A	E84K	S 6481 N	H18W07	S 8600 R	H70WDK14	S 4378 NR	SA17308	S 7A21 A
E565L	S 0840 A	E865H D363	S 5663 PO	H18W14	S 8137 RH	H70WDK15	S 4473 NR	SA17309	S 7646 A
E566L	S 7091 A	E879L	S 9380 A	H18WDK02	S 0712 NR	H70WK	S 8501 NR	SA17320	S 7F16 A
E567L	S 0850 A	E87L01	S 2810 A	H18WDK04	S 4396 NR	H70WK02		SA17326	S 7694 A
E567LS	S 2850 A	E88K	S 6181 N	H18WK01	S 8110 NR	(ALTRE/OTHER APPL.)	S 8500 NR	SA17336	S 7A29 A
E568L	S 8950 A	E89.32	S 6180 PO	H18WK03	S 5020 NR	H70WK05	S 7600 NR	SA17347	S 7643 A
E56KPD72	S 6004 NE	E89HD213	S 5081 PE	H18WK04	S 8110 NR	H70WK06	S 4378 NR	SA17353	S 7649 A
E570L	S 0150 A	E8KFR	S 0201 N	H18WK05	S 2220 NR	H70WK07	S 4378 NR	SA17362	S 7A09 A
E570LS	S 8940 A	E906LJ	S 3053 C	H191WK	S 2220 NR	H70WK08	S 4391 NR	SA17418	S 7406 A
E574L	S 7170 A	E912LC	S 4281 CA	H19W01	S 5802 R	H70WK09	S 0999 NR	SA17421	S 7404 A
E574LS	S 7670 A	E912LJ	S 3059 C	H19W02	S 5800 R	H70WK10	S 4329 NR	SA17431	S 7A03 A
E57KPD73	S 6008 NE	E924L	S 3446 C	H19W04	S 0420 R	H70WK11	S 4416 NR	SA17518	S 7F13 A
E580L	S 7337 A	E927LJ	S 3441 C	H19W05	S 5800 R	H70WK12	S 7600 NR	SA17525	S 7C16 A
E580LS	S 7A34 A	E928LJ	S 3442 C	H19W06		H70WK18	S 4416 NR	SA17549	S 3B55 A
E585L	S 7033 A	E929LJ	S 3081 C	(ALTRE/OTHER APPL.)	S 1563 R	H710WK	S 4142 NR	SA17569	S 7372 A
E595L	S 7626 A	E931LC	S 4225 CA	H19W06		H7120WK10	S 4159 NR	SA17604	S 7F31 A
E599L	S 7092 A	E931LJ	S 3072 C	(VOLVO)	S 1560 R	T200W	S 7393 A	SA17860	S 7428 A
E5KFR	S 0101 N	E932LJ	S 3056 C	H19W07	S 5800 R	T250W	S 7259 A	SA4035	S 3541 A
E5KFR2D12	S 2161 N	E933LJ	S 3054 C	H19W08	S 3497 R	T260W	S 7F14 A	SA4089	S 9380 A
E5KFRD12	S 0101 N	E933LJ01	S 3437 C	H19W10	S 0620 R	T280W	S 7A66 A	SA5133	S 7639 A
E5KP	S 7411 N	E934LJ	S 3023 C	H19WK01	S 0810 NR	T290W	S 7F23 A	SA7061	S 7B11 A
E5KPD12	S 7411 N	E938LJ	S 3055 C	H19WK02	S 0710 NR	T300W	S 7344 A	SA7102	S 6303 A
E602L	S 0VGT A	E944LJ	S 3062 C	H200W	S 9030 R	T360W	S 7F30 A	SAO7079	S 7266 A
E603L	S 7A12 A	E945LJ	S 3092 C	H200W03	S 4402 R	Z10D64	S 5900 PO	SC50001	S 3053 C
E604L	S 7023 A	E947LC	S 4260 CA	H200W04	S 4402 R	Z12D64	S 5902 PO	SC5158CA	S 4314 CA
E609L		E947LJ	S 3089 C	H200W10	S 0900 R	Z13D94	S 5903 PO	SC60042CA	S 4260 CA
(RENAULT)	S 9240 A	E949LJ	S 3048 C	H200W20	S 4402 R	Z16D183	S 5904 PO	SC7035	S 3161 C
E626L		E954LC	S 4177 CA	H200W40	S 4402 R	Z830FD253	S 5905 PO	SC7042	S 3315 C
(MERCEDES BENZ A0040944604)	S 7F31 A	E954LJ	S 3165 C	H200WDK	S 9320 NR			SH52710	S 2234 Z
E626L		E954LJ01	S 3165 C	H200WDK01	S 4120 NR	HIFI FILTER	SOFIMA	SH52711	S 2234 Z
(MERCEDES BENZ A0040941804)	S 7695 A	E956LJ	S 3066 C	H200W01	S 4120 R	KN70346	S 6147 NE	SH56191	S 8137 RH
E631L	S 7558 A	E956LJ01	S 3066 C	H201WDK	S 1395 NR	OV6081	S 7A86 A	SH62128	S 5663 PO
E631L01	S 7558 A	E966LJ	S 3439 C	H205W01	S 8310 R	SA11112	S 7107 A	SN1242	S 4470 NR
E631LS	S 7559 A	E969LC	S 4347 CA	H208W01	S 9610 R	SA111708	S 7607 A	SN70131	S 4475 NR
E633L	S 7625 A	E969LJ	S 3139 C	H208W02	S 8020 R	SA111831	S 7614 A	SN70186	S 6004 NE
E655L	S 7343 A	E980LC	S 4345 CA	H20W02		SA11832	S 7614 A	SN70201	S 9320 NR
E661L	S 7F17 A	E980LJ	S 3436 C	(ALTRE/OTHER APPL.)	S 0130 R	SA11939	S 7A22 A	SN70296	S 6039 NE
E666L	S 7A17 A	E982LJ	S 3221 C	H210W01	S 3292 R	SA11939	S 7091 A	SN70313	S 4401 U
E66KPD36	S 6009 NE	E999LJ	S 3443 C	H210W02	S 9710 R	SA14009K	S 0850 A	SN70335	S 4077 NR
E671L	S 7A23 A	EAS304MD152-2	S 7B11 A	H210WN	S 3003 DR	SA14508	S 7549 A	SN70388	S 4150 NR
E681L	S 7600 A	H100WL	S 7A86 A	H215WK	S 1999 NR	SA14509	S 7578 A	SN70396	S 4149 NR
E68KP01D73	S 6010 NE	H100WU	S 7A86 A	H216WK	S 4006 NR	SA14588	S 6870 A	SN80038	S 1071 B
E68KPD73	S 6010 NE	H103WK	S 1013 B	H218W	S 3698 R	SA14595	S 7638 A	SN80045	S 6072 NE
E696L	S 2370 A	H10W01	S 1270 R	H220WN	S 5003 DR	SA14696	S 7A34 A	SN80050	S 6043 NE
E696LS	S 4370 A	H10W02	S 2329 R	H230W	S 3288 R	SA14835	S 7548 A	SN80055	S 6034 NE
E699L	S 6870 A	H10W06		H240W	S 3409 R	SA14848	S 7474 A	SN80057	S 6044 NE
E69HD81	S 5026 PE	(VOLVO)	S 3257 R	H240WK	S 4444 NR	SA16007	S 7342 A	SN80072	S 6080 NE
E69L	S 7808 A	H10W10	S 3280 R	H250W	S 3408 R	SA16043	S 7431 A	SN906230	S 4157 NR
E702L	S 7A59 A	H10W11	S 1600 R	H278WK	S 4107 NR	SA16111	S 7286 A	SN909110	S 4472 NR
E706L	S 7F16 A	H10W12	S 3425 R	H28WF	S 9006 AR	SA16121	S 7422 A	SN99107	S 4471 NR
E70H	S 5664 PO	H10W15	S 1600 R	H296WK	S 4089 NR	SA16122	S 7405 A	SN99140	S 5394 GC
E70KPD98	S 6146 NE	H10W17	S 1600 R	H300W01	S 3275 R	SA16125	S 7423 A	SO040	S 8600 R
E70L2	S 7107 A	H10W22	S 3257 R	H300W02	S 3010 R	SA16126	S 7608 A	SO10038	S 0620 R
E713L	S 7627 A	H120WK	S 9960 NC	H302WK	S 4475 NR	SA16127	S 7408 A	SO11103	S 5181 PE
E714L	S 7A14 A	H121WK	S 4408 NR	H311W	S 5087 OC	SA16128	S 7A17 A	SO11139	S 5905 PO
E719L	S 7A11 A	H12W01	S 6100 R	H311WK	S 1071 B	SA16206	S 9870 A	SO3565	S 3698 R
E719LS	S 7649 A	H12W05	S 3257 R	H31WK	S 2610 NR	SA16240	S 7615 A	SO6001	S 3257 R



CROSS REFERENCES > CORRISPONDENZE > CORRESPONDANCES > VERGLEICHNUMMERN > CRUCE DE REFERENCIAS

SO6097	S 5026 PE	1901687	S 7111 NC	21645902	S 5270 A	42559501	S 3081 PO	5801313604	S 7600 A
SO7148	S 5549 PO	1901688	S 4211 N	2165039	S 4940 A	42561177	S 4406 U	5801317097	S 6303 A
SO7151	S 5046 PE	1901689	S 7200 N	2165044	S 0950 A	42561571	S 4401 U	5801354114	S 6034 NE
SO7184	S 5097 PE	1901776	S 8410 AR	2165049	S 2450 A	42561605	S 4402 U	5801400571	S 7C16 A
SO7191	S 3592 R	1901779	S 0450 A	2165054	S 2650 A	42562233	S 4401 U	5801415504	S 5102 PE
SO7255	S 5235 PE	1901780	S 4270 A	2165059	S 0450 A	42563320	S 2234 Z	5801439820	S 6043 NE
SO7260	S 5236 PE	1901796		2168629	S 0270 A	42568992	S 5664 PO	5801512159	S 1H20 NR
SO7270	S 5239 PE	(N.2 FILTRI/FILTERS) +	S 0120 R	2240348	S 0550 A	4365352	S 5060 A	5801516883	S 6044 NE
SO8036	S 5087 OC	1901796		2241329	S 3940 A	4371579	S 5060 A	5801551648	S 7A23 A
SO8043	S 5111 PE	(N.1 FILTRO/FILTER) +	S 8020 R	2243946	S 7129 A	4389435	S 1506 A	5801592275	S 5087 OC
SO8045	S 5102 PE	1901855	S 8760 A	2394637	S 1450 A	4589769	S 0940 A	5801592277	S 5111 PE
SO9030	S 5900 PO	1901902	S 6550 A	2415950	S 1940 A	4671001	S 0710 NR	5801613590	S 7A11 A
SO9058	S 5904 PO	1901903	S 0150 A	2966261	S 3081 PO	4681776	S 8410 AR	5801613592	S 7A23 A
TB1387	S 7F24 A	1901919	S 8600 R	2991585	S 4396 NR	4694322	S 0710 NR	5801619418	S 3315 C
TB1393	S 7F14 A	1901925	S 0450 A	2991785	S 7563 A	4700487	S 0710 NR	5801620130	S 4474 NR
WE2096	S 9006 AR	1901929	S 7111 NC	2991793	S 7562 A	4712132	S 8310 R	5801667204	S 4405 U
		1901934	S 3300 PO	2992056	S 8790 PO	4719150	S 8310 R	5801686484	S 7689 A
		1902040	S 5650 A	2992241	S 2220 NR	4734562	S 8410 AR	5801729418	S 4480 NR
		1902047	S 3003 DR	2992242	S 0620 R	4741272	S 8020 R	5801962827	S 0VGT A
		1902048	S 2650 A	2992261	S 7259 A	4741273	S 0120 R	5802050393	S 6080 NE
0042547823	S 7694 A	1902076	S 3003 DR	2992300	S 1H20 NR	4741274	S 8020 R	5802310802	S 4405 U
42547823	S 7694 A	1902077	S 2450 A	2992374	S 7563 A	4741275	S 0120 R	58086593	S 4405 U
5000686589	S 4323 NR	1902093	S 3260 R	2992388	S 7627 A	4742848	S 0710 NR	60147280	S 8790 PO
5001018011	S 7357 A	1902096	S 4311 N	2992447	S 7B11 A	4764693	S 5401 NR	61142392	S 5401 NR
5001019687	S 0712 NR	1902101	S 4940 A	2992544	S 3288 R	4776902	S 2450 A	61142397	S 5401 NR
5001021129	S 0900 R	1902102	S 5003 DR	2992662	S 1999 NR	4777082	S 8310 R	61584009	S 7600 R
5001021176	S 3698 R	1902106	S 6911 N	2992677	S 7356 A	4780269	S 7200 N	61584801	S 7142 A
5001859430	S 4394 NR	1902127	S 0950 A	2994048	S 4395 NR	4788503	S 0710 NR	61589105	S 0710 NR
5006002224	S 4470 NR	1902128	S 0270 A	2994057	S 3003 DR	4788504	S 4311 N	61653726	S 7968 A
5006143641	S 8137 RH	1902130	S 1940 A	2994101	S 7259 A	4788592	S 8570 A	61671160	S 8600 R
5006307754	S 7649 A	1902131	S 3940 A	2994102	S 1H20 NR	4790521	S 0710 NR	7110301	S 5401 NR
503131282	S 7A11 A	1902132	S 1450 A	2994103	S 3288 R	4790523	S 7200 N	7980507	S 4370 A
503131284	S 7649 A	1902133	S 6710 NR	2994583	S 4346 CA	4964322	S 0710 NR	7980508	S 2570 A
504113074	S 4323 NR	1902134	S 5400 NR	2994769	S 4348 CA	4964323	S 4311 N	8014390	S 0850 A
5801115135	S 6449 PO	1902135	S 7600 R	2995655	S 0920 R	4980649	S 0450 A	8025818	S 7945 A
		1902136	S 5802 R	2995656	S 3260 R	500020002	S 7A11 A	8032064	S 7356 A
		1902137	S 3081 PO	2995711	S 1395 NR	500023843	S 3457 C	8107486	S 0999 NR
		1902138	S 8500 NR	2995811	S 5820 R	500038748	S 1H20 NR	8107716	S 0999 NR
01902138	S 8500 NR	1902197	(N.3 FILTRI/FILTERS)	2995964	S 3078 C	500054655	S 5087 OC	8122408	S 8570 A
042561177	S 4406 U	1902457	S 8020 R	2995965	S 3023 C	500054702	S 6034 NE	8123564	S 7259 A
08011014	S 8950 A	1902465	S 1506 A	2995966	S 3055 C	500055340	S 6072 NE	8123679	S 5401 NR
08014390	S 0850 A	1902486	S 2650 A	2996126	S 7600 A	500055621	S 7626 A	8190455	S 2570 A
08014410	S 2370 A	1902486	S 1540 A	2996127	S 7544 A	500055972	S 4402 U	8190946	S 7170 A
08014420	S 2950 A	1903628	S 3003 DR	2996154	S 7546 A	500086009	S 6034 NE	8190948	S 7259 A
08014430	S 8950 A	1903629	S 5003 DR	2996155	S 7563 A	500086267	S 3161 C	8322386	S 1506 A
08015449	S 2850 A	1903630		2996156	S 7562 A	500086309	S 3315 C	8322987	S 4270 A
08015450	S 4370 A	(N.2 FILTRI/FILTERS)	S 2003 DR	2996157	S 7390 A	500086381	S 4472 NR	8322988	S 6550 A
08016966	S 2840 A	1903669	S 7356 A	2996416	S 5087 OC	5001018011	S 7357 A	8322989	S 0450 A
08016967	S 6550 A	1903715	S 5003 DR	2997093	S 7390 A	5001021174	S 5903 PO	8323032	S 2650 A
08025818	S 7945 A	1903785	S 3003 DR	2997117	S 7B11 A	500314688	S 3023 C	8323285	S 2650 A
08032064	S 7356 A	1904581	S 4940 A	2997305	S 5003 DR	500315480	S 4395 NR	8323287	S 2650 A
08041782	S 6550 A	1905620	S 1307 A	2997376	S 4068 NR	500315481	S 4396 NR	8323288	S 2650 A
08092347	S 0950 A	1905704		3799020	S 3055 C	500315484	S 6645 N	8323321	S 5650 A
08092439	S 2450 A	(N.2 FILTRI/FILTERS)	S 2003 DR	3802821	S 3161 C	500318246	S 1028 B	8323458	S 1540 A
08092441	S 2650 A	1905710	S 7168 A	41214149	S 7390 A	500322701	S 3003 DR	8501601	S 0012 O
08092445	S 0450 A	1905983	S 7183 A	41270082	S 7600 A	500354176	S 1999 NR	8535467	S 0201 N
1160024	S 7600 R	1907460	S 4396 NR	41272124	S 7600 A	500387947	S 3055 C	8535468	S 1411 N
1160025	S 8600 R	1907539	S 0999 NR	41272211	S 7563 A	5006254879	S 7A09 A	8813556	S 3300 PO
1160033	S 0101 N	1907553	S 7187 A	41272212	S 7562 A	50313477	S 3444 C	8825228	S 7200 N
1160034	S 0201 N	1907566	S 9710 R	4137638	S 5060 A	503138477	S 3283 C	8827122	S 0610 NR
1160217	S 7411 N	1907567	S 9610 R	42074972	S 5401 NR	503139140	S 4471 NR	8827662	S 7200 N
1160243	S 5400 NR	1907570	S 0230 R	42078290	S 2450 A	504000160	S 7626 A	8830319	S 0610 NR
1161934	S 5802 R	1907571		42471161	S 7625 A	504018807	S 1H20 NR	9004824	S 0510 NR
1164620	S 6710 NR	(N.2 FILTRI/FILTERS)	S 2003 DR	42471166	S 7626 A	504024890	S 3078 C	93162385	S 3055 C
1168402	S 6311 N	1907578		42480759	S 7129 A	504033399	S 0620 R	93192965	S 7259 A
1168407	S 0201 N	(N.3 FILTRI/FILTERS)	S 8020 R	42481020	S 1450 A	504064398	S 1999 NR	97210996	S 8500 NR
1168444	S 4380 PO	1907579		42491185	S 2234 Z	504071913	S 1H20 NR	9912650	S 8790 PO
1168446	S 0530 PO	(N.1 FILTRO/FILTER) +	S 8020 R	42491619	S 5650 A	504073234	S 8500 NR	9914553	S 3081 PO
1173430	S 8600 R	1907579		42522604	S 0201 N	504074043	S 0620 R	9915545	S 0060 A
1173481	S 7600 R	(N.2 FILTRI/FILTERS) +	S 0120 R	42522674	S 8501 NR	504075145	S 7689 A	9917881	S 0940 A
1173482	S 5802 R	1907580	S 3003 DR	42522696	S 1411 N	504082382	S 3288 R	9927604	S 0850 A
1173765	S 9030 R	1907581	S 5003 DR	42522761	S 7411 N	504082383	S 4396 NR	9927846	S 4940 A
1174420	S 9030 R	1907582	S 3003 DR	42535049	S 2234 Z	504082384	S 4395 NR	9930450	S 1411 N
1174482	S 8501 NR	1907583	S 3003 DR	42536332	S 7627 A	504086268	S 4472 NR	9930451	S 0201 N
1267900	S 8790 PO	1907584	S 5003 DR	42537127	S 0900 R	504112123	S 1395 NR	9932594	S 7170 A
1289048	S 0201 N	1907612	S 7259 A	42537392	S 7637 A	504118385	S 0620 R	9933276	S 6550 A
1289052	S 6311 N	1907640	S 4329 NR	42538923	S 0712 NR	504120410	S 5087 OC	99445200	S 3288 R
1289054	S 1411 N	1907818	S 8020 R	42541643	S 6449 PO	504122676	S 1999 NR	99452236	S 0999 NR
1366330	S 3300 PO	1907819	S 0120 R	42544766	S 5663 PO	504128471	S 4348 NR	99478393	S 7356 A
1384034	S 1506 A	1908082	S 3081 PO	42547823	S 7694 A	504153481	S 7266 A	9981555	S 7670 A
1901599	S 0580 PO	1908112	S 1540 A	42549295	S 4472 NR	504170771	S 6072 NE	9983763	S 2650 A
1901600	S 6911 N	1908312	S 5401 NR	42553256	S 7625 A	504192850	S 5087 OC	9983764	S 0450 A
1901601	S 5060 A	1908492	S 3081 PO	42553257	S 7626 A	504209107	S 7266 A	9985779	S 4940 A
1901602	S 0700 R	1908547	S 0999 NR	42553258	S 7627 A	504213799	S 5087 OC	9985780	S 7023 A
1901605	S 0710 NR	1908556	S 4394 NR	42553413	S 7A21 A	504213801	S 5087 OC	9987150	S 2450 A
1901606	S 8310 R	1909103	S 0710 NR	42553548	S 4401 U	504272431	S 4068 NR	9988728	S 2670 A
1901607	S 0610 NR	2133943	S 8501 NR	42555073	S 4402 U	504292579	S 4480 NR		
1901608	S 3300 PO	2164590	S 5270 A	42555920	S 1071 B	550228	S 6645 N		

**CROSS REFERENCES > CORRISPONDENZE >
CORRESPONDANCES > VERGLEICHNUMMERN > CRUCE DE REFERENCIAS**

KAEHLBLE	SOFIMA								
		831-906-90-84	S 2450 A	KC430D	S 4159 NR	KX72D1		LX1734	S 7A12 A
		831-908-51-02	S 2650 A	KC491D	S 4157 NR	(MERCEDES BENZ)	S 6089 NE	LX1789	S 7F16 A
		831-909-51-16	S 1050 A	KC522D	S 4035 NR	KX72D1		LX1798	S 7F17 A
06502115	S 1411 N	831-909-91-17	S 0550 A	KC543	S 4089 NR	(MAN)	S 6088 NE	LX18	S 0850 A
06538215	S 0201 N	831-914-31-88	S 7213 A	KC553D	S 4470 NR	KX72D2		LX1807	S 7627 A
24000389	S 6550 A	831-914-31-880	S 7213 A	KC6	S 5400 NR	(MERCEDES BENZ)	S 6089 NE	LX1845	S 3340 A
24000504	S 0450 A	831-914-71-87	S 7608 A	KC63/1D	S 9600 NR	KX72D2		LX1886	S 3541 A
24000505	S 1450 A	831-914-71-870	S 7608 A	KC67	S 1410 NR	(MAN)	S 6088 NE	LX1894	S 7637 A
34000091	S 2370 A	831-914-91-90	S 7431 A	KC68	S 8501 NR	KX73/1D	S 6004 NE	LX192	S 7107 A
34000191	S 7129 A	831-914-91-900	S 7431 A	KC7	S 8110 NR	KX73/2D	S 6016 NE	LX1946	S 7A23 A
34000283	S 7002 A	831-917-52-020	S 7573 A	KC75	S 5020 NR	KX80D	S 6001 NE	LX1956	S 7573 A
34000291	S 0940 A	832-199-83-950	S 5663 PO	KC8	S 6710 NR	LA1162	S 3454 C	LX20	S 0060 A
34000314	S 0060 A	832-199-84-510	S 5663 PO	KC80		LA148	S 3089 C	LX200	S 0650 A
34000320	S 0150 A	832-199-97-290	S 5663 PO	(ALTRE/OTHER APPL.)	S 8500 NR	LA152	S 3023 C	LX2020	S 7506 A
34000330	S 2840 A	983-614-10-98	S 5400 NR	KC90	S 9960 NC	LA154	S 3165 C	LX2021	S 7B10 A
34000460	S 2650 A			KC94	S 0310 NR	LA170	S 3078 C	LX2068	S 7643 A
34000489	S 2450 A			KL100/1	S 4416 NR	LA198	S 3055 C	LX2080	S 5812 A
34000490	S 3940 A			KL100/2	S 4416 NR	LA279	S 3048 C	LX2081	S 7645 A
38215	S 0201 N	019.1105040-10	S 6064 NE	KL101	S 9960 NC	LA307	S 3137 C	LX2082	S 7600 A
38327	S 0101 N	028.1012005	S 0620 R	KL147/2D	S 4391 NR	LA351	S 3441 C	LX21	S 0940 A
40001317	S 2530 PO	6W.23.288.01	S 3288 R	KL147D	S 4391 NR	LA355	S 3081 C	LX2109	S 7A11 A
40001350	S 8600 R	6W.24.059.00	S 4059 NR	KL180	S 7600 NR	LA357	S 3443 C	LX227	S 2650 A
40001351	S 6710 NR	6W.24.064.00	S 4064 NR	KL195	S 4006 NR	LA358	S 3436 C	LX229	S 5270 A
40001359	S 7261 PO	728.1109560	S 7408 A	KL228/2D	S 4107 NR	LA372	S 3446 C	LX231	S 0270 A
40001416	S 9490 PO	728.1109560-10	S 7408 A	KL228/3D	S 4107 NR	LA42/1	S 3072 C	LX236	S 0950 A
40002049	S 2162 N	PL420	S 4142 NR	KL233/2	S 5427 GC	LA43	S 3221 C	LX239	S 7998 A
40002432	S 0101 N			KL313	S 2320 NR	LA432	S 3066 C	LX240	S 7987 A
40600169	S 1411 N			KL33	S 1013 B	LA439	S 3161 C	LX241	S 0550 A
40600226	S 0530 PO			KL33OF	S 1013 B	LA492	S 3444 C	LX242	S 7550 A
40600493	S 7600 R	1109100C9F0	S 7B80 A	KL440/03	S 5394 GC	LA50/1	S 3062 C	LX243	S 7839 A
40600494	S 0300 O	1109100C9F0		KL440/27	S 5394 GC	LA502	S 3289 C	LX26	S 5450 A
406850486	S 0530 PO	(INTERNA/VINFER) +	S 7B81 A	KL440/3	S 5394 GC	LA532	S 3283 C	LX263	S 6370 A
40685486	S 0530 PO	211200010	S 4138 NR	KL440/35	S 5394 GC	LA55/1	S 3092 C	LX2635	S 7679 A
40700147	S 7411 N			KL440/43	S 5394 GC	LA56	S 3023 C	LX264	S 2810 A
40700148	S 1411 N			KL490/1D	S 4112 NR	LA625	S 3279 C	LX265	S 2450 A
40700306	S 0201 N			KL707	S 1071 B	LA67	S 3053 C	LX265/1	
40700313	S 5400 NR			KL723D	S 4077 NR	LA71	S 3139 C	(BR)	S 2450 A
40700433	S 0300 O	AL12	S 7259 A	KL75	S 7600 NR	LA83	S 3059 C	LX268	S 3570 A
6678200	S 0150 A	AL14	S 7344 A	KL912	S 4149 NR	LA85	S 3054 C	LX269	S 1070 A
73153	S 7411 N	AL22	S 7A66 A	KL914	S 4150 NR	LA910	S 3448 C	LX27	S 2370 A
75174	S 8790 PO	AL25	S 7F14 A	KX1	S 0201 N	LA99	S 3051 A	LX271	S 0450 A
7633141101	S 8790 PO	AL26	S 7F23 A	KX12	S 6645 N	LAK148	S 4260 CA	LX273	S 1050 A
8600850177	S 7600 R	HX108	S 5664 PO	KX13	S 9091 N	LAK154	S 4177 CA	LX274	S 7028 A
874080789	S 4370 A	HX131D	S 5663 PO	KX13D	S 9091 N	LAK307	S 4161 CA	LX275	S 4940 A
874080790	S 2370 A	HX15	S 3081 PO	KX16	S 6911 N	LAK43	S 4225 CA	LX28	S 0150 A
8874000594	S 0060 A	HX40	S 2234 Z	KX17	S 5911 N	LAK71	S 4347 CA	LX2810	S 3B55 A
8874001543	S 7143 A	HX5	S 8790 PO	KX18	S 4311 N	LAK816	S 4314 CA	LX2814	S 7337 A
8874001546	S 4370 A	HX77	S 5238 PE	KX181D	S 6009 NE	LAK83	S 4281 CA	LX2839	S 7B36 A
8874001547	S 2570 A	HX80	S 5613 PO	KX182/1D	S 6008 NE	LAK863	S 4349 CA	LX29	S 6550 A
8874001554	S 7144 A	KC102	S 4378 NR	KX182D	S 6010 NE	LAP11	S 3452 C	LX299	S 7431 A
8874080789	S 4370 A	KC102/1	S 1378 NR	KX191/1D	S 6011 NE	LAP13	S 3217 C	LX3009	S 7A14 A
8874080790	S 2370 A	KC103	S 4408 NR	KX20	S 8381 NC	LAP27	S 3460 C	LX3030	S 7A50 A
		KC117	S 4337 NR	KX21	S 6481 N	LC3	S 0VGT A	LX3054	S 7575 A
		KC14	S 0510 NR	KX210D	S 4311 N	LC4	S 7A86 A	LX31	S 8840 A
		KC15	S 0810 NR	KX21D	S 6481 N	LX1024	S 7619 A	LX3137	S 7608 A
589-452-07-00	S 0201 N	KC161	S 4408 NR	KX23	S 7111 NC	LX1025	S 7371 A	LX3141	S 7A03 A
589-452-08-00	S 1411 N	KC17	S 8501 NR	KX230D	S 6039 NE	LX1072	S 7625 A	LX3143	S 9380 A
598-452-07-00	S 0201 N	KC18	S 8500 NR	KX23D	S 7111 NC	LX1142	S 7356 A	LX3155	S 7644 A
598-452-08-00	S 1411 N	KC182	S 1H20 NR	KX24	S 8111 NC	LX1242	S 7A17 A	LX3290	S 7423 A
598-452-10-00	S 0530 PO	KC183	S 4471 NR	KX24D	S 8111 NC	LX1243	S 7409 A	LX33	S 7170 A
711-922-604	S 8600 R	KC184	S 4341 NR	KX25	S 6181 N	LX1245	S 7091 A	LX334	S 3030 A
711-922-853	S 7600 R	KC186	S 0999 NR	KX26	S 0201 N	LX1255	S 7562 A	LX335	S 3059 A
763-314-11-01	S 1411 N	KC187	S 4396 NR	KX261D	S 6146 NE	LX1276	S 7626 A	LX345	S 7187 A
801-151-161	S 0201 N	KC188	S 2220 NR	KX262D	S 6024 NE	LX1278	S 7A16 A	LX3480	S 7F13 A
801-151-163	S 1411 N	KC189	S 4444 NR	KX27D	S 2162 N	LX1279	S 7A15 A	LX3480KIT	S 7383 A
822-500-00-30	S 3081 PO	KC197	S 0712 NR	KX29	S 3010 N	LX1280	S 7278 A	LX3555	S 7F21 A
822-500-70-22	S 8790 PO	KC200	S 4121 NR	KX332	S 6062 NE	LX1281	S 7345 A	LX3556	S 7F22 A
830-010-05-40	S 7600 R	KC214	S 1999 NR	KX336	S 6063 NE	LX13	S 6650 A	LX3582	S 7C13 A
831-115-01-92	S 7575 A	KC22	S 2610 NR	KX34	S 6311 N	LX14	S 0840 A	LX3599	S 7558 A
831-115-01-920	S 7575 A	KC24	S 4323 NR	KX340D	S 6072 NE	LX141	S 7974 A	LX3603	S 6303 A
831-199-91-36	S 7261 PO	KC249D	S 4143 NR	KX35	S 7411 N	LX147		LX3889	S 7F25 A
831-199-91-37	S 8260 PO	KC251	S 9320 NR	KX36	S 1411 N	(RENAULT)	S 9240 A	LX4076	S 7C16 A
831-205-30-01	S 9030 R	KC28	S 0810 NR	KX36D	S 1411 N	LX156	S 5060 A	LX436	S 1670 A
831-208-80-070	S 5036 PE	KC296D	S 4142 NR	KX394	S 6059 NE	LX1579	S 2370 A	LX441	S 7185 A
831-208-80-150	S 6017 NE	KC297	S 4473 NR	KX395	S 6064 NE	LX158	S 0660 A	LX450	S 0050 A
831-400-00-48	S 8600 R	KC300	S 4120 NR	KX399D	S 6034 NE	LX1580	S 7479 A	LX451	S 7186 A
831-508-51-02	S 2650 A	KC32	S 8500 NR	KX403D	S 6148 NE	LX1587	S 7347 A	LX47	S 4450 A
831-900-00-48	S 8600 R	KC362D	S 4461 NR	KX42		LX16	S 2950 A	LX478/1	S 1506 A
831-900-00-49	S 5400 NR	KC371D	S 4461 NR	(FIAT, FIAT ALLIS, IVECO)	S 4211 N	LX1600	S 7F18 A	LX506	S 7279 A
831-900-01-03	S 0101 N	KC373	S 4394 NR	KX43	S 0101 N	LX162	S 7808 A	LX507	S 7280 A
831-900-01-04	S 7411 N	KC374D	S 4472 NR	KX439KIT	S 6147 NE	LX1627	S 7573 A	LX511/1	S 3080 A
831-900-01-10	S 8260 PO	KC375D	S 4479 NR	KX44	S 0201 N	LX1629	S 7695 A	LX513/1	S 3082 A
831-900-90-84	S 2450 A	KC378D	S 4138 NR	KX44D	S 0201 N	LX1630	S 7F15 A	LX516	S 3330 A
831-903-91-04	S 0940 A	KC38		KX49D	S 2161 N	LX166	S 2460 A	LX530	S 8450 A
831-903-91-09	S 0940 A	(ALTRE/OTHER APPL.)	S 8500 NR	KX65D	S 2162 N	LX1671	S 7221 A	LX531	S 8570 A
831-904-20-17	S 0060 A	KC384D	S 4158 NR	KX67/1D	S 6017 NE	LX1673	S 7516 A	LX560/1	S 8502 A
831-905-00-42	S 7839 A	KC4	S 0710 NR	KX67/2D	S 6017 NE	LX1699	S 7277 A	LX562	S 7183 A
831-905-10-43	S 5270 A	KC43	S 8500 NR	KX68D	S 2161 N	LX17	S 8950 A	LX584	S 5650 A

K



**CROSS REFERENCES > CORRISPONDENZE >
CORRESPONDANCES > VERGLEICHNUMMERN > CRUCE DE REFERENCIAS**

300509	S 6180 PO	ABU8538	S 0530 PO	5502896	S 5400 NR	7381816	S 4470 NR	51.05504-0074	S 5536 PO
300861	S 6180 PO	ABU8539	S 0300 O	5507372	S 2530 PO	7382048	S 4378 NR	51.05504-0076	S 5536 PO
301760-01	S 0280 PO	ABU8541	S 6380 PO	5507423	S 2530 PO	7382153	S 6063 NE	51.05504-0077	S 5536 PO
307963-05	S 3180 PO	ABU8544	S 6380 PO	5507547	S 8600 R	7401179	S 7017 A	51.05504-0087	S 7260 PO
31685	S 4080 PO	ABU8545	S 3301 PO	5507616	S 4000 O	7401316	S 7170 A	51.05504-0088	S 5536 PO
32599	S 4380 PO	ABU8547	S 4380 PO	5507621	S 0300 O	7401993	S 2570 A	51.05504-0090	S 7260 PO
3551658	S 6550 A	ABU8549	S 2530 PO	5507741	S 0650 A	7402000	S 4510 NR	51.05504-0094	S 5132 PE
37H1581	S 7111 NC	ABU8550	S 5401 NR	5507989	S 0850 A	7402022	S 4510 NR	51.05504-0096	S 5005 PE
37H1881	S 7111 NC	ABU8552	S 0710 NR	5507991	S 6550 A	7402027	S 4370 A	51.05504-0097	S 5099 PE
37H2924	S 0150 A	ABU8553	S 8110 NR	5507992	S 6550 A	7402242	S 7144 A	51.05504-0098	S 5016 PE
37H3739	S 0850 A	ABU8554	S 6481 N	5507995	S 7308 A	7402243	S 7143 A	51.05504-0104	S 7260 PO
37H576	S 7111 NC	ABU8555	S 8111 NC	5508423	S 2530 PO	7402855	S 1411 N	51.05504-0105	S 5095 PE
37H6214	S 7111 NC	ABU8556	S 0101 N	5508916	S 7945 A	7411394	S 7343 A	51.05504-0107	S 5046 PE
37H7937	S 8111 NC	ABU8557	S 7411 N	5508917	S 7024 A	7414298	S 7423 A	51.05504-0108	S 5046 PE
3H1140	S 5446 PO	ABU8558	S 7111 NC	550899314	S 7222 A	7414300	S 7408 A	51.05504-0110	S 5147 PE
3H1283	S 0280 PO	ABU8563	S 0201 N	550899414	S 7221 A	7611451	S 7516 A	51.05504-0115	S 5235 PE
3H1287	S 0280 PO	ABU8564	S 1411 N	5531837-08	S 6059 NE	7615043	S 7368 A	51.05504-0118	S 5239 PE
3H1288	S 0280 PO	ABU8784	S 0900 R	5600615	S 6270 A	7619404	S 7356 A	51.05504-0122	S 5046 PE
3H2689	S 5446 PO	ABU8911	S 4380 PO	5601056	S 9030 R	7621451	S 7516 A	51.05504-0126	S 5235 PE
3H2907	S 4080 PO	ABU8912	S 0280 PO	5601514	S 6710 NR	7623375	S 6064 NE	51.12501-7260	S 4142 NR
3H2909	S 4080 PO	ACU2889	S 7299 A	5601963	S 7129 A	8145894	S 8501 NR	51.12501-7283	S 4142 NR
3H4340	S 0280 PO	ADU9779	S 8500 NR	5601964	S 2650 A			51.12501-7288	S 4142 NR
41007448	S 0150 A	AEU2147	S 8500 NR	5602073	S 7261 PO			51.12503-0004	S 4378 NR
41008819	S 6550 A	AHM2007	S 0420 R	5602112	S 7411 N			51.12503-0005	S 4378 NR
41017301	S 2840 A	AJC5122	S 1080 PO	5604682	S 4270 A			51.12503-0009	S 4378 NR
41513	S 4080 PO	AJK5122	S 1080 PO	5614398	S 4478 NR			51.12503-0010	S 4378 NR
48G171	S 0280 PO	AMK426	S 0280 PO	571352308	S 7259 A			51.12503-0012	S 5400 NR
48H171	S 0280 PO	AMK462	S 0280 PO	571558408	S 6017 NE			51.12503-0016	S 4378 NR
506577	S 0280 PO	AMN2007	S 0420 R	571571308	S 6089 NE			51.12503-0018	S 4378 NR
5141403	S 7111 NC	BLM107020	S 1270 R	5717440-08	S 7506 A			51.12503-0028	S 4378 NR
516886	S 6180 PO	C120270-2	S 8950 A	571755608	S 7573 A			51.12503-0029	S 4378 NR
516920	S 7111 NC	C2111218-1	S 0150 A	6425549	S 2370 A			51.12503-0030	S 4378 NR
517711	S 7111 NC	CRF504679	S 8950 A	6425550	S 4370 A			51.12503-0031	S 4378 NR
535003	S 0280 PO	CRF508027	S 0150 A	6425723	S 0150 A			51.12503-0037	S 6004 NE
541403	S 4380 PO	CRF512748	S 6550 A	6425724	S 8940 A			51.12503-0039	S 4378 NR
554329	S 9400 R	CU154709	S 0810 NR	6426988	S 3301 PO			51.12503-0040	S 4378 NR
55900433	S 0280 PO	EG684	S 6180 PO	7000524	S 0850 A			51.12503-0042	S 6004 NE
55901262	S 6181 N	NTC1435	S 7138 A	7000712	S 8501 NR			51.12503-0045	S 1378 NR
59436	S 0280 PO	NTC6660	S 2950 A	7000738	S 7839 A			51.12503-0046	S 1378 NR
600391	S 8381 NC	RTC3479	S 7139 A	7001087	S 9030 R			51.12503-0047	S 6088 NE
601980	S 7111 NC	VBU1559	S 6449 PO	7001222	S 0201 N			51.12503-0048	S 6016 NE
601984	S 7111 NC	ZZL2255	S 5446 PO	7001224	S 0300 O			51.12503-0050	S 6088 NE
602424	S 0280 PO			7001261	S 5400 NR			51.12503-0052	S 4142 NR
60427	S 0280 PO			7002304	S 0101 N			51.12503-0053	S 9320 NR
69047	S 4080 PO			7002305	S 7411 N			51.12503-0056	S 6004 NE
719535	S 9990 A			7002402	S 7165 A			51.12503-0059	S 4473 NR
735724	S 0150 A			7002403	S 4940 A			51.12503-0060	S 4473 NR
78-747	S 7111 NC			7002639	S 2850 A			51.12503-0061	S 6011 NE
78-784	S 8381 NC			7002914	S 8260 PO			51.12503-0062	S 6088 NE
78-811	S 5446 PO			7002915	S 7261 PO			51.12503-0063	S 6011 NE
78-981	S 7111 NC			7005286	S 2370 A			51.12503-0066	S 4143 NR
7H1135	S 6180 PO			7005287	S 4370 A			51.12503-0071	S 9320 NR
7H1297	S 0280 PO			7005331	S 8270 A			51.12503-0083	S 6088 NE
7H16	S 0280 PO			7005424	S 0850 A			51.12503-0084	S 6088 NE
7H1835	S 8381 NC			7005658	S 7600 R			51.12503-0086	S 6150 NE
7H1841	S 6181 N			7008775	S 8501 NR			51.12503-0099	S 4473 NR
7H1927	S 0280 PO			7009285	S 0150 A			51.12503-0112	S 6150 NE
833544	S 7111 NC			7009286	S 8940 A			64.08301-0003	S 0450 A
8G2000	S 0280 PO			7010578	S 2840 A			76.33141.101	S 8790 PO
8G2300	S 4080 PO			7026329	S 7507 A			78.58330-1040	S 0530 PO
8G4000	S 0280 PO			7026330	S 7506 A			81.00000-0246	S 1411 N
8G683	S 4080 PO			7211178	S 8950 A			81.05501-6007	S 5802 R
8G684	S 6180 PO			7211197	S 2950 A			81.05504-0006	S 0530 PO
8G706	S 6180 PO			7211208	S 5099 PE			81.05504-0007	S 8790 PO
92518	S 1080 PO			7211230	S 8501 NR			81.05504-0025	S 2530 PO
95218	S 1080 PO			7360149	S 7170 A			81.05504-0026	S 0530 PO
9673	S 4080 PO			7360150	S 7670 A			81.05504-0027	S 2530 PO
AAK267	S 5446 PO			7360230	S 2850 A			81.05504-0032	S 0530 PO
AAK372	S 6181 N			7360733	S 3940 A			81.05504-0033	S 7028 A
AAK526	S 8381 NC			7360753	S 2450 A			81.05504-0037	S 6290 PO
ABU4557	S 7945 A			7360972	S 2570 A			81.05504-0039	S 7260 PO
ABU6137	S 0150 A			7360973	S 4370 A			81.05504-0041	S 7260 PO
ABU6138	S 6550 A			7361346	S 1940 A			81.05504-0044	S 5536 PO
ABU6151	S 8940 A			7361347	S 0950 A			81.05504-0045	S 5536 PO
ABU7466	S 7945 A			7361354	S 3450 A			81.05504-0046	S 5536 PO
ABU8053	S 5446 PO			7361355	S 5450 A			81.05504-0047	S 5536 PO
ABU8507	S 0060 A			7362686	S 6550 A			81.05504-0050	S 5536 PO
ABU8508	S 0940 A			7362687	S 2840 A			81.05504-0051	S 8790 PO
ABU8510	S 9990 A			7363362	S 2370 A			81.05504-6001	S 8790 PO
ABU8514	S 7945 A			7364115	S 7945 A			81.05504-0012	S 4000 O
ABU8522	S 2650 A			7364116	S 7024 A			81.05504-0029	S 0300 O
ABU8524	S 0450 A			7364870	S 7308 A			81.08205-0005	S 0450 A
ABU8525	S 2450 A			7367182	S 1450 A			81.08301-6074	S 5270 A
ABU8527	S 5270 A			7367183	S 0450 A			81.08304-0023	S 7987 A
ABU8534	S 5800 R			7368216	S 7361 A			81.08304-0024	S 7987 A
ABU8535	S 5800 R			7370955	S 7421 A			81.08304-0028	S 7839 A
ABU8536	S 1600 R			737095503	S 7421 A			81.08304-0029	S 7987 A
ABU8537	S 8600 R			7370956	S 7422 A			81.08304-0032	S 0550 A



CROSS REFERENCES > CORRISPONDENZE > CORRESPONDANCES > VERGLEICHNUMMERN > CRUCE DE REFERENCIAS

81.08304-0036	S 2650 A	81.12503-0035	S 5400 NR	6750452154	S 6449 PO	C2443	S 0660 A	C30703	S 8570 A
81.08304-0038	S 1050 A	81.12503-0036	S 7411 N	6750452194	S 6449 PO	C2443/1	S 0660 A	C30703/1	S 8570 A
81.08304-0039	S 7028 A	81.12503-0037	S 0101 N	6750454660	S 5663 PO	C24508	S 7187 A	C30810/3	S 7558 A
81.08304-0040	S 0450 A	81.12503-0038	S 7111 NC	BF700X	S 2161 N	C24508/1	S 7187 A	C30850/2	S 1050 A
81.08304-0041	S 0450 A	81.12503-0040	S 7411 N	BF707	S 0101 N	C24516	S 0940 A	C30850/7	S 7546 A
81.08304-0043	S 1050 A	81.12503-0041	S 7411 N	BF811	S 0201 N	C24650	S 0550 A	C30880/2	S 0050 A
81.08304-0044	S 1050 A	81.12503-0042	S 1411 N	BF900X	S 2162 N	C24650/1	S 0450 A	C30883/1	S 7033 A
81.08304-0045	S 2650 A	81.12503-0043	S 0101 N	BFU700X	S 2161 N	C24650/3	S 7186 A	C31014	S 7B36 A
81.08304-0046	S 7129 A	81.12503-0044	S 0201 N	BFU707	S 0101 N	C24700/1	S 7028 A	C31016	S 7B36 A
81.08304-0048	S 0450 A	81.12503-0046	S 0201 N	BFU811	S 0201 N	C24719	S 0150 A	C31017	S 7C13 A
81.08304-0049	S 2450 A	81.12503-0048	S 1411 N	BFU900X	S 2162 N	C24745	S 7627 A	C31018	S 7C13 A
81.08304-0050	S 2840 A	81.12503-0050	S 0101 N	C1112	S 7107 A	C24745/2	S 7F16 A	C311027	S 7004 A
81.08304-0051	S 6550 A	81.12503-0051	S 7411 N	C1140	S 7A14 A	C24745/3	S 7627 A	C311093	S 0070 A
81.08304-0053	S 0950 A	81.12503-0052	S 1411 N	C1188	S 0840 A	C24820	S 7A09 A	C311093/1	S 0070 A
81.08304-0054	S 0950 A	81.12503-0053	S 0201 N	C12100	S 4370 A	C24870	S 2570 A	C311093/2	S 0070 A
81.08304-0055	S 2450 A	81.12503-0054	S 1411 N	C1281	S 8940 A	C25003	S 7B10 A	C311170	S 4270 A
81.08304-0057	S 0450 A	81.12503-0062	S 0201 N	C13109		C25024	S 7F26 A	C311226	S 7945 A
81.08304-0060	S 0450 A	81.12503-0063	S 1411 N	(RENAULT)	S 9240 A	C2552/1	S 2460 A	C311238	S 7214 A
81.08304-0061	S 7361 A	81.12503-0066	S 0201 N	C13114/3	S 0650 A	C25660	S 7625 A	C311254	S 7970 A
81.08304-0062	S 0150 A	81.12503-0075	S 4378 NR	C13114/4	S 0650 A	C25660/1	S 7625 A	C311255	S 7387 A
81.08304-0063	S 8940 A	81.12503-0080	S 6063 NE	C14159/1	S 7138 A	C25660/2	S 7625 A	C311256	S 7343 A
81.08304-0064	S 2650 A	81.12503-0085	S 6059 NE	C14179	S 2950 A	C25730/1	S 8502 A	C311256/2	S 7343 A
81.08304-0065	S 1450 A	81.12503-0086	S 6062 NE	C14179/2	S 7138 A	C25754	S 2764 A	C311310	S 7368 A
81.08304-0069	S 7432 A	81.32118-0026	S 5613 PO	C14179X	S 2950 A	C2582	S 3330 A	C311345/1	S 7347 A
81.08304-0072	S 7431 A	81.33118-0003	S 3241 R	C1450	S 7808 A	C25860	S 7428 A	C311410	S 7643 A
81.08304-0073	S 7432 A	81.33118-0016	S 6449 PO	C15165/3	S 4940 A	C25860/3	S 7626 A	C311414	S 7608 A
81.08304-0074	S 7187 A	81.33118-6003	S 6449 PO	C15165/7	S 7679 A	C25860/6	S 7626 A	C311495	S 7615 A
81.08304-0076	S 7187 A	81.33118-6004	S 5663 PO	C15248	S 7940 A	C25860/8	S 7F25 A	C311900	S 7A13 A
81.08304-0079	S 7482 A	81.33215-0002	S 2234 Z	C15260	S 4940 A	C25950/1	S 7A15 A	C31980	S 7575 A
81.08304-0083	S 1970 A	81.33215-0011	S 0900 R	C16167	S 7549 A	C25978	S 7651 A	C32004	S 7C16 A
81.08304-0084	S 7405 A	81.33901-6045	S 6449 PO	C16190	S 8950 A	C25990	S 7A29 A	C321420/1	S 7600 A
81.08304-0085	S 3940 A	81.33901-6046	S 5663 PO	C16190X	S 8950 A	C26025	S 7650 A	C321420/2	S 7600 A
81.08304-0086	S 8570 A	81.47301-6005	S 3081 PO	C16200	S 7144 A	C261005	S 7B01 A	C321447	S 7357 A
81.08304-0087	S 8502 A	81.47307-0001	S 8790 PO	C16302	S 0850 A	C261100	S 7A11 A	C321500	S 7285 A
81.08304-0091	S 1050 A	81.47307-0009	S 5664 PO	C16335	S 0850 A	C261215	S 7578 A	C321700	S 7421 A
81.08304-0093	S 7651 A	81.52102-0008	S 7259 A	C16400	S 7516 A	C261220	S 7548 A	C321700/2	S 7421 A
81.08304-0094	S 1970 A	81.52102-0009	S 7259 A	C1642	S 5060 A	C26315/1	S 7002 A	C321752	S 7284 A
81.08304-0095	S 7482 A	81.52102-0010	S 7259 A	C17124	S 7342 A	C26315/4	S 6450 A	C321752/1	S 7645 A
81.08304-0097	S 1970 A	81.52102-0016	S 7F24 A	C17129	S 1506 A	C26980	S 7A23 A	C321900/2	S 7564 A
81.08304-0098	S 7408 A	81.52108-6001	S 7259 A	C17149	S 2840 A	C27023	S 7E35 A	C32199	S 3541 A
81.08304-0100	S 7573 A	81.52108-6025	S 7A66 A	C17170	S 7405 A	C27038	S 7F27 A	C32338	S 3080 A
81.08304-0102	S 7A23 A	81.52155-0040	S 7A66 A	C17192	S 1540 A	C27038/1	S 7F29 A	C32338/1	S 3082 A
81.08304-0104	S 7637 A	81.52155-0042	S 7A66 A	C17225	S 7550 A	C271170	S 7573 A	C32640/1	S 7023 A
81.08401-0036	S 7F28 A	81.54131-0001	S 7107 A	C17225/2	S 0950 A	C271170/4	S 7573 A	C33013	S 7B39 A
81.08401-6082	S 7361 A	81.61910-0011	S 3053 C	C17225/3	S 0950 A	C271170/6	S 7573 A	C331015	S 7185 A
81.08405-0008	S 7129 A	81.61910-0018	S 3165 C	C17337/2	S 7356 A	C271250/1	S 7619 A	C331305	S 9570 A
81.08405-0011	S 1307 A	81.61910-0019	S 4177 CA	C18149/1	S 9380 A	C271318	S 7143 A	C331460/1	S 7A03 A
81.08405-0013	S 1307 A	81.61910-0029	S 3165 C	C18202	S 7404 A	C271320/2	S 7637 A	C331465	S 7563 A
81.08405-0015	S 8502 A	81.61910-0030	S 4177 CA	C18292	S 7160 A	C271320/3	S 7A12 A	C331465/1	S 7563 A
81.08405-0016	S 7619 A	81.61910-0032	S 3165 C	C18398	S 5650 A	C271340	S 7A50 A	C331476	S 7168 A
81.08405-0017	S 7616 A	81.61910-0033	S 4177 CA	C18436	S 7170 A	C271390	S 7161 A	C331600/2	S 7544 A
81.08405-0018	S 7B01 A	81.77910-0011	S 3439 C	C19006	S 7F31 A	C271397	S 8840 A	C331605	S 4770 A
81.08405-0020	S 7619 A	81.77910-0012	S 3439 C	C19105	S 7474 A	C271406	S 2070 A	C331630	S 7F18 A
81.08405-0021	S 7619 A	81.77910-0016	S 3081 C	C19157	S 7024 A	C271520	S 2070 A	C331630/2	S 7F18 A
81.08405-0022	S 7F16 A	81.77910-0020	S 3283 C	C19377	S 7974 A	C271581	S 7277 A	C331840	S 7213 A
81.08405-0023	S 7F17 A	81.77910-0027	S 3439 C	C19416	S 7695 A	C27585	S 7998 A	C33920/3	S 7361 A
81.08405-0027	S 7649 A	81.77910.0021	S 3444 C	C19620	S 6870 A	C27585/3	S 7998 A	C33920/5	S 7562 A
81.08405-0028	S 7646 A	81.77972-0155	S 3439 C	C20118	S 7A34 A	C27998/3	S 7A16 A	C33920/6	S 7361 A
81.08405-0029	S 7A11 A	82.12503-0038	S 7111 NC	C20325	S 7839 A	C28003	S 7B45 A	C33921	S 7562 A
81.08405-0030	S 7644 A	82.52102-0013	S 7259 A	C20325/2	S 2450 A	C28028	S 7B45 A	C33922	S 3570 A
81.08405-0031	S 7F25 A	83.08405-0000	S 7431 A	C20356	S 5250 A	C281275	S 7644 A	C341500/1	S 7345 A
81.08405-0032	S 3B55 A	83.08405-0001	S 7A23 A	C20500	S 7506 A	C281580	S 7641 A	C34430	S 8450 A
81.08405-0033	S 7E35 A	83.77910-0027	S 3439 C	C20550	S 7017 A	C28715	S 6370 A	C351592	S 7337 A
81.08405-0036	S 7F28 A	83.77972-0608	S 3447 C	C21138/1	S 7813 A	C28848	S 8350 A	C361142	S 5450 A
81.08405-0037	S 7F27 A	83.77972-0656	S 3279 C	C21295	S 7281 A	C29010	S 7F13 A	C361820	S 7278 A
81.08405-0038	S 7F29 A	84.77910-0002	S 3440 C	C21317	S 0060 A	C29010KIT	S 7383 A	C36840	S 9990 A
81.08504-0024	S 7987 A	85.12501-0002	S 6063 NE	C21338	S 1070 A	C291032/1	S 7383 A	C36840/1	S 9990 A
81.08504-0026	S 0530 PO	85.12501-0003	S 6064 NE	C21431	S 2370 A	C291055	S 7372 A	C36840/3	S 9990 A
81.12501-0004	S 6064 NE	85.12501-0005	S 6064 NE	C21461	S 7638 A	C291219/1	S 7469 A	C371930	S 7A35 A
81.12501-0021	S 6062 NE	85.61950-0025	S 3048 C	C21790	S 7A17 A	C291290	S 7409 A	C40002	S 6303 A
81.12501-0030	S 6062 NE	86.05500-6005	S 0420 R	C22224	S 4450 A	C291366	S 7371 A	C4019	S 5812 A
81.12501-6096	S 4035 NR	86.08304-4001	S 7987 A	C22337	S 7479 A	C291366/1	S 7A59 A	C41001KIT	S 7639 A
81.12501-6101	S 4035 NR	86.12000-6009	S 7111 NC	C22478	S 7F15 A	C291410	S 9870 A	C411776	S 7639 A
81.12503-0001	S 7411 N	86.77903-0378	S 0420 R	C22478/1	S 7F15 A	C291420	S 7423 A	C421404	S 7280 A
81.12503-0011	S 0201 N	88.05501-6002	S 3241 R	C22526/1	S 7694 A	C29577	S 6940 A	C421729	S 7279 A
81.12503-0013	S 0101 N	88.77910-0002	S 3440 C	C23440	S 5270 A	C29939	S 6550 A	C4312/1	S 3340 A
81.12503-0014	S 6311 N	88.77910-0003	S 3448 C	C23440/1	S 2650 A	C301184	S 7A22 A	C453265X	S 7315 A
81.12503-0015	S 7411 N	90.80115-5191	S 7028 A	C23440/2	S 0270 A	C301185	S 7A24 A	C60230	S 3030 A
81.12503-0016	S 7411 N	90.80115-5196	S 7987 A	C23440/3	S 2650 A	C30122	S 2810 A	C60345	S 3059 A
81.12503-0018	S 1411 N	90.80119-5131	S 1910 PO	C23500	S 7987 A	C301240	S 7286 A	C62001	S 3B55 A
81.12503-0019	S 0101 N	90.80720-0756	S 8790 PO	C23502	S 7614 A	C301240/1	S 7A25 A	C641500	S 3373 A
81.12503-0020	S 7411 N	A5.00004-1045	S 3241 R	C2351	S 0760 A	C301353	S 1970 A	C641500/1	S 3373 A
81.12503-0021	S 1411 N	A5.00024-1676	S 9091 N	C23513/1	S 7F17 A	C301359	S 7642 A	C77/7	S 0VGT A
81.12503-0022	S 1411 N	N1.01103-3282	S 3446 C	C2360	S 8760 A	C301500	S 7358 A	C811	S 7A86 A
81.12503-0023	S 0101 N			C23690	S 7276 A	C301500/1	S 7A26 A	C9004	S 7091 A
81.12503-0024	S 0201 N			C24355	S 7992 A	C301530	S 7A21 A	C911X2	S 7B11 A
81.12503-0028	S 0101 N			C2437	S 0660 A	C301537	S 1670 A	C913/1	S 7091 A
81.12503-0033	S 7028 A	6240152274	S 2234 Z	C24393	S 7183 A	C30630	S 7431 A	C934	S 6650 A

**CROSS REFERENCES > CORRISPONDENZE >
CORRESPONDANCES > VERGLEICHNUMMERN > CRUCE DE REFERENCIAS**

CF934X	S 6650 A	CU91001	S 3456 C	HU1270X	S 5045 PE	PU941X	S 6008 NE	W932/81	S 3102 R
CF1000	S 3940 A	CUK2184	S 4260 CA	HU1291/1Z	S 5235 PE	PU966/1X	S 6024 NE	W933/1	S 3102 R
CF1122	S 7670 A	CUK2534	S 4347 CA	HU1291Z	S 5235 PE	PU966/2X	S 6146 NE	W936/6	
CF1200	S 7129 A	CUK26018	S 4351 CA	HU1297X	S 5234 PE	PU966X	S 6146 NE	(BR)	S 5600 R
CF1300	S 1450 A	CUK26021	S 4314 CA	HU13125X	S 5046 PE	PU999/1X	S 6001 NE	W938	S 0420 R
CF1320	S 7482 A	CUK2952	S 4348 CA	HU1381X	S 5016 PE	PU999/2X	S 6009 NE	W940	S 3241 R
CF1500/1	S 7572 A	CUK31001	S 4350 CA	HU1390X	S 5097 PE	PU999X	S 6001 NE	W940 (10)	
CF1510/1	S 7484 A	CUK32001	S 4349 CA	HU7010Z	S 5159 PE	TB1364X	S 7393 A	(N.10 FILTRI/FILTERS)	S 3241 R
CF15116/2	S 7408 A	CUK33001	S 4352 CA	HU718/1K	S 5013 PE	TB1374/3X	S 7344 A	W940/1	S 5600 R
CF1570	S 0768 A	CUK3569	S 4161 CA	HU721Y	S 5238 PE	TB1374/4X	S 7F24 A	W940/13	S 5603 R
CF1600	S 1307 A	CUK3823	S 4225 CA	HU726/2X	S 5011 PE	TB1374X	S 7259 A	W940/15N	S 3241 R
CF16002	S 7F28 A	CUK3858	S 4281 CA	HU825X	S 5026 PE	TB1394/1X	S 7A66 A	W940/18	S 7600 R
CF1610	S 7288 A	CUK4469	S 4345 CA	HU9003Z	S 5236 PE	TB1394/3X	S 7F30 A	W940/19	S 0510 NR
CF1620	S 7432 A	CUK4594	S 4346 CA	HU931/5X	S 5007 PE	TB1394/5X	S 7F23 A	W940/23	S 3102 R
CF1640	S 7616 A	CUK4795	S 4177 CA	HU931/6X	S 5007 PE	TB1394/6X	S 7F14 A	W940/24	
CF1650	S 7649 A	H1018/2N	S 7380 PO	HU932/4N	S 5131 PE	U1005	S 4406 U	(ALTRE/OTHER APPL.)	S 9400 R
CF17007	S 7D41 A	H1029/1N	S 6380 PO	HU932/4X	S 5099 PE	U5001KIT	S 4405 U	W940/25	
CF17007/1		H1038X	S 4380 PO	HU945/2X	S 5036 PE	U620/2Y KIT	S 4401 U	(O/OR)	S 5603 R
(BR)	S 7D41 A	H1050/2	S 5536 PO	HU945/3X	S 5036 PE	U620/3YKIT	S 4403 U	W940/25	S 5601 R
CF1720	S 7A44 A	H1051	S 5446 PO	HU947/1N	S 5132 PE	U630X KIT	S 4402 U	W940/25 (10)	
CF1800	S 7406 A	H1053/2N	S 5446 PO	HU947/1X	S 5124 PE	W10004	S 3497 R	(O/OR) (N.10 FILTRI/FILTERS)	S 5603 R
CF18190	S 7422 A	H1060	S 0530 PO	HU947/1Z-2	S 5133 PE	W11102	S 9030 R	W940/25 (10)	
CF18190/2	S 7422 A	H1060N	S 0530 PO	HU947/2X	S 5005 PE	W11102/11	S 0900 R	(N.10 FILTRI/FILTERS)	S 5601 R
CF18202	S 7404 A	H1072/11X	S 1910 PO	HU951X	S 5095 PE	W11102/14	S 4402 R	W940/27	S 9400 R
CF18211	S 7565 A	H1076	S 9490 PO	P275X	S 3180 PO	W11102/15	S 9030 R	W940/29	S 7600 R
CF1830	S 7646 A	H1076X	S 9490 PO	P55-0653	S 6010 NE	W11102/20	S 4402 R	W940/44	S 5601 R
CF1940	S 7A04 A	H1081	S 1910 PO	P707	S 7411 N	W11102/27	S 4402 R	W940/5	S 7600 R
CF2000/1	S 7576 A	H12105N	S 3300 PO	P707X	S 7411 N	W11102/34	S 4402 R	W940/5 (10)	
CF2100/1	S 7390 A	H12105X	S 3301 PO	P715	S 6311 N	W11102/35	S 0900 R	(N.10 FILTRI/FILTERS)	S 7600 R
CF22269	S 3450 A	H12107	S 2530 PO	P722	S 6645 N	W11102/36	S 0900 R	W940/66	S 5603 R
CF23398	S 7A36 A	H12107/1	S 2530 PO	P78	S 9091 N	W11102/37	S 4402 R	W940/69	S 0920 R
CF3300	S 7F19 A	H12109	S 7260 PO	P78X	S 9091 N	W11102/4	S 0900 R	W940/81	S 5600 R
CF500	S 7507 A	H12110/2	S 7260 PO	P810F	S 6481 N	W1126	S 5700 R	W950	S 5802 R
CF700	S 7165 A	H12110/2X	S 7261 PO	P810X	S 6481 N	W1130		W950/1	S 5800 R
CF800	S 1940 A	H12110/3	S 7260 PO	P811	S 1411 N	(ALCUNI IMPIEGHI/SOME APPL.)	S 8310 R	W950/13	S 5800 R
CF810	S 7559 A	H12125	S 7260 PO	P811X	S 1411 N	W1130/1	S 8310 R	W950/14	S 5800 R
CF922	S 2850 A	H1275X	S 8260 PO	P824X	S 6181 N	W1130/2	S 8310 R	W950/16	
CP49001	S 7F20 A	H1282X	S 2530 PO	P825T	S 4211 N	W1130/3	S 8310 R	(BR)	S 3497 R
CP50001	S 7F21 A	H13104	S 5569 PO	P916/6X	S 7111 NC	W1140	S 9610 R	W950/17	S 5800 R
CP50002	S 7F22 A	H2X947/1Z		P917		W1140/1	S 0700 R	W950/18	S 3497 R
CU1722	S 3066 C	(N.2 FILTRI/FILTERS)	S 5549 PO	(BR, RAJ)PIEGHI/PLEATED PAPER)	S 7112 NC	W1140/5	S 8020 R	W950/26	S 0620 R
CU2184	S 3089 C	H601	S 3081 PO	P917	S 7111 NC	W1160	S 3292 R	W950/39	S 0620 R
CU22017	S 3460 C	H601/4	S 3081 PO	P917/2X	S 7112 NC	W1160/2	S 3698 R	W950/4	S 1563 R
CU22029	S 3315 C	H614N	S 9080 PO	P917X	S 7111 NC	W1168	S 1220 R	W950/4	
CU2218	S 3448 C	H623	S 5664 PO	P919/7	S 8790 PO	W1168/1	S 1220 R	(VOLVO)	S 1560 R
CU2303	S 3217 C	H710/1N	S 2234 Z	P923/1	S 8381 NC	W1168/4	S 0120 R	W950/5	S 0420 R
CU2304	S 3452 C	H710/1X	S 2234 Z	P923/1X	S 8381 NC	W1170/13	S 3592 R	W950/7	S 0420 R
CU2534	S 3139 C	H710/1Z	S 2234 Z	P939X	S 3010 N	W1170/15	S 0230 R	W962	S 8600 R
CU27004	S 3455 C	H712	S 1080 PO	P945	S 8111 NC	W1170/7	S 3288 R	W962/1	S 8137 RH
CU2785	S 3051 A	H804/99	S 0280 PO	P945X	S 8111 NC	W1184	S 3409 R	W962/11	S 3106 R
CU2951	S 3023 C	H804T	S 0280 PO	P947	S 6911 N	W1228	S 3577 R	W962/2	S 8600 R
CU2952	S 3161 C	H813/1N	S 6180 PO	P982X	S 4311 N	W1294	S 3409 R	W962/28	S 8600 R
CU2956	S 3023 C	H813/1X	S 6180 PO	PF1050/1N	S 7510 O	W13004	S 5087 OC	W962/47	S 8600 R
CU31001	S 3454 C	H813/98	S 6180 PO	PF1050/1X	S 7510 O	W13120/2	S 3408 R	W962/6	S 8600 R
CU3132	S 3062 C	H816/99	S 4080 PO	PF1055/1	S 2510 O	W13145/3	S 3275 R	W962/8	S 8600 R
CU32001	S 3459 C	H816X	S 4080 PO	PF1055/1X	S 2510 O	W13145/6	S 3010 R	WA923/2	S 9007 AR
CU32002	S 3453 C	H820/3X	S 3180 PO	PF1155	S 4000 O	W719/12	S 7500 R	WA940/6	S 8410 AR
CU3415	S 3442 C	H827/1N	S 1080 PO	PF1155K	S 4000 O	W719/5	S 2030 R	WA940/9	S 9006 AR
CU3478	S 3056 C	H827/99	S 1080 PO	PF1155N	S 4000 O	W719/5 (10)		WD962	S 8605 HP
CU3569	S 3137 C	H835X	S 5663 PO	PF1190	S 0300 O	(N.10 FILTRI/FILTERS)	S 2030 R	WDK11102/23	S 9320 NR
CU37001	S 3289 C	H929/3	S 5613 PO	PF1190X	S 0300 O	W723/3	S 1380 R	WDK11102/24	S 4120 NR
CU37230	S 3048 C	H932/1T	S 6490 PO	PF925X	S 0122 O	W8006	S 5600 R	WDK11102/25	
CU3855	S 3221 C	H932/2	S 6490 PO	PF926N	S 0012 O	W815	S 0130 R	(BR)	S 9320 NR
CU3858	S 3059 C	H932/2T	S 6490 PO	PL270/7X	S 4021 NR	W815/5	S 0130 R	WDK11102/28	S 9320 NR
CU3869	S 3072 C	H932/4N	S 5381 PO	PL420	S 4142 NR	W818/2	S 7500 R	WDK11102/8	S 9320 NR
CU3944	S 3446 C	H939	S 6290 PO	PL420X	S 4142 NR	W840	S 5630 R	WDK719	S 1378 NR
CU3959	S 3279 C	H941/2X	S 6449 PO	PU10003-2X	S 6147 NE	W9009	S 0920 R	WDK724	S 4378 NR
CU40110	S 3053 C	H942	S 5124 PE	PU10013Z	S 6044 NE	W9050	S 3280 R	WDK724/1	S 4473 NR
CU4036	S 3440 C	H942X	S 5124 PE	PU10020X	S 6043 NE	W914/2	S 6100 R	WDK725	S 4378 NR
CU4150	S 3445 C	H943/2T	S 0580 PO	PU10022Z	S 6150 NE	W914/2 (10)		WDK940/5	S 4337 NR
CU4228	S 3092 C	H947/1N	S 3631 PO	PU1046/1X	S 6017 NE	(N.10 FILTRI/FILTERS)	S 6100 R	WDK962/16	S 4396 NR
CU4408	S 3438 C	H947/1X	S 5124 PE	PU1046X	S 6017 NE	W914/28	S 5820 R	WK10006Z	S 4157 NR
CU4466	S 3055 C	H947/1Z	S 5549 PO	PU1058X	S 6039 NE	W916/1	S 1270 R	WK1040/1X	S 4158 NR
CU4469	S 3436 C	HU1072X	S 5044 PE	PU1059X	S 6011 NE	W917	S 3257 R	WK1060/3X	S 4143 NR
CU45120	S 3439 C	HU1077/1Z	S 5181 PE	PU50Z	S 6088 NE	W920/12	S 1600 R	WK1060/5X	S 4138 NR
CU4594	S 3078 C	HU1077/2X	S 5181 PE	PU51Z	S 6089 NE	W920/21		WK1070X	S 4472 NR
CU4627	S 3081 C	HU11002X	S 5111 PE	PU7004Z	S 6034 NE	(ALTRE/OTHER APPL.)	S 1600 R	WK1080/6X	S 4479 NR
CU4662	S 3283 C	HU11003Y	S 5240 PE	PU7017Z	S 6080 NE	W920/21 (10)		WK1080/7X	S 4121 NR
CU4795	S 3165 C	HU11003Z	S 5240 PE	PU834/1X	S 6148 NE	(N.10 FILTRI/FILTERS)	S 1600 R	WK11001X	S 4146 NR
CU4926	S 3447 C	HU12001Z	S 5156 PE	PU834/2X	S 6148 NE	W920/31		WK11003Z	S 4476 NR
CU50001	S 3457 C	HU12003X	S 5239 PE	PU850X	S 6016 NE	(BR)	S 1600 R	WK11014	S 0710 NR
CU50102	S 3451 C	HU12006Z	S 5237 PE	PU855X	S 6004 NE	W920/48	S 1600 R	WK11019Z	S 4477 NR
CU5067	S 3444 C	HU12008X	S 5102 PE	PU88	S 6064 NE	W920/6		WK11023Z	S 4474 NR
CU5096	S 3443 C	HU12013Z	S 5169 PE	PU89	S 6063 NE	(CHRYSLER, JEEP)	S 1600 R	WK11029Z	S 4035 NR
CU52004	S 3458 C	HU12103X	S 5081 PE	PU9002/1Z	S 6072 NE	W920/7	S 2329 R	WK1150/2	S 4154 NR
CU5346	S 3441 C	HU12110X	S 5062 PE	PU910	S 6059 NE	W920/8	S 3425 R	WK1168	S 0710 NR
CU5809	S 3437 C	HU12122X	S 5147 PE	PU911	S 6062 NE	W920/80	S 1600 R	WK1175X	S 4159 NR
CU5877	S 3054 C	HU12140X	S 5006 PE	PU941/1X	S 6010 NE	W930/11	S 7330 R	WK31/5	S 1013 B



**CROSS REFERENCES > CORRISPONDENZE >
CORRESPONDANCES > VERGLEICHNUMMERN > CRUCE DE REFERENCIAS**

WK31/5 (10) (N.10 FILTRI/FILTERS)	S 1013 B	MECAFILTER	SOFIMA	ELG5507	S 0510 NR	ELH4321	S 3102 R	FA1566	S 7343 A
WK31/8	S 1013 B			ELG5509	S 7411 N	ELH4334	S 3425 R	FA1567	S 7342 A
WK4002	S 1028 B	EHC8500	S 5900 PO	ELG5510	S 0101 N	ELH4375	S 0920 R	FA1569	S 7372 A
WK716	S 2610 NR	EHC8501	S 5903 PO	ELG5511	S 1411 N	ELH4385	S 1600 R	FA2081	S 3080 A
WK723	S 4323 NR	EHC8502	S 5902 PO	ELG5512	S 4311 N	ELH4409	S 5820 R	FA2100	S 3541 A
WK723 (10) (N.10 FILTRI/FILTERS)	S 4323 NR	EHC8503	S 5904 PO	ELG5515	S 6911 N	ELH4700	S 0230 R	FA2219	S 3082 A
WK723/1	S 4323 NR	EHY8201	S 2234 Z	ELG5517	S 6710 NR	ELH4702	S 5124 PE	FA3105	S 7368 A
WK723/6	S 4323 NR	EKR7077	S 4281 CA	ELG5518	S 6001 NE	ELH4703	S 8260 PO	FA3126	S 2950 A
WK724	S 4329 NR	EKR7228	S 4161 CA	ELG5519	S 0999 NR	ELH4704	S 7600 R	FA3130	S 7428 A
WK724/3	S 4394 NR	EKR7517	S 4225 CA	ELG5521	S 0310 NR	ELH4705	S 5800 R	FA3152	S 1970 A
WK727	S 4323 NR	EKR7522	S 4177 CA	ELG5522	S 0610 NR	ELH4706	S 3300 PO	FA3159	S 7578 A
WK731		EL1929	S 7142 A	ELG5523	S 5020 NR	ELH4707	S 0900 R	FA3171	S 7284 A
(ALTRE/OTHER APPL.)	S 5400 NR	EL3030	S 0660 A	ELG5524	S 4329 NR	ELH4708	S 6290 PO	FA3174	S 7549 A
WK736	S 8500 NR	EL3044	S 2460 A	ELG5525	S 0201 N	ELH4711		FA3177	S 7479 A
WK8014	S 4475 NR	EL3047	S 8950 A	ELG5527	S 4471 NR	(ALTRE/OTHER APPL.)	S 4380 PO	FA3184	S 7431 A
WK817/3X	S 9600 NR	EL3049	S 0150 A	ELG5528	S 4378 NR	ELH4714		FA3187	S 7434 A
WK820	S 2320 NR	EL3050	S 0060 A	ELG5530	S 6017 NE	(ALTRE/OTHER APPL.)	S 7261 PO	FA3188	S 9870 A
WK820/1	S 2320 NR	EL3051	S 0940 A	ELG5531	S 4395 NR	ELH4714		FA3190	S 7409 A
WK820/16	S 4150 NR	EL3052	S 2950 A	ELG5533	S 4396 NR	(MAN)	S 7260 PO	FA3191	S 7576 A
WK820/18	S 4149 NR	EL3053	S 0840 A	ELG5534	S 4408 NR	ELH4715	S 0120 R	FA3195	S 7548 A
WK820/2X	S 4077 NR	EL3054	S 6550 A	ELG5537	S 2220 NR	ELH4716	S 0700 R	FA3197	S 7474 A
WK820/8	S 4149 NR	EL3077	S 4940 A	ELG5542	S 0712 NR	ELH4717	S 8600 R	FA3204	S 7279 A
WK842	S 8501 NR	EL3078	S 0650 A	ELG5545	S 6062 NE	ELH4718	S 8020 R	FA3205	S 7482 A
WK842/13	S 4416 NR	EL3080	S 7974 A	ELG5547	S 4120 NR	ELH4719	S 7500 R	FA3206	S 7432 A
WK842/17	S 4416 NR	EL3083	S 2450 A	ELG5551	S 6011 NE	ELH4720	S 8790 PO	FA3209	S 7280 A
WK842/2	S 8500 NR	EL3084	S 0450 A	ELG5557	S 6024 NE	ELH4721	S 0530 PO	FA3210	S 7469 A
WK842/2 (10) (N.10 FILTRI/FILTERS)	S 8500 NR	EL3086	S 2650 A	ELG5558	S 6039 NE	ELH4723	S 0300 O	FA3211	S 3373 A
WK842/20	S 4006 NR	EL3087	S 0950 A	ELG5569	S 4142 NR	ELH4724	S 6380 PO	FA3217	S 7345 A
WK842/23X	S 4107 NR	EL3088	S 5270 A	ELG5580	S 4138 NR	ELH4725	S 9490 PO	FA3220	S 7356 A
WK842/4	S 7600 NR	EL3089	S 0550 A	ELH4044	S 6100 R	ELH4727	S 1910 PO	FA3273	S 7404 A
WK842/5	S 4378 NR	EL3090	S 4450 A	ELH4070	S 1270 R	ELH4730	S 5536 PO	FA3289	S 7A15 A
WK842/7 (BR)	S 8500 NR	EL3152	S 9240 A	ELH4081	S 6100 R	ELH4731	S 3260 R	FA3290	S 7383 A
WK845/9	S 4408 NR	EL3251	S 2460 A	ELH4092		ELH4732	S 9300 R	FA3299	S 7405 A
WK851	S 7600 NR	EL3331	S 2810 A	(ALTRE/OTHER APPL.)	S 1600 R	ELH4733	S 1220 R	FA3304	S 7625 A
WK853/3	S 4391 NR	EL3441	S 0650 A	ELH4093		ELH4734	S 9710 R	FA3305	S 7406 A
WK853/3X	S 4391 NR	EL3478	S 3330 A	(ALTRE/OTHER APPL.)	S 1270 R	ELH4735	S 5003 DR	FA3320	S 7450 A
WK853/4	S 5427 GC	EL3488	S 1506 A	ELH4095	S 2030 R	ELH4736	S 5006 PE	FA3340	S 0VGT A
WK853/8	S 4408 NR	EL3673	S 1540 A	ELH4100	S 3102 R	ELH4737	S 5132 PE	FA3341	S 7575 A
WK854	S 4408 NR	EL3674	S 5060 A	ELH4104	S 0130 R	ELH4738	S 5133 PE	FA3342	S 7563 A
WK854/2	S 1H20 NR	EL3674	S 5060 A	ELH4116		ELH4739	S 5005 PE	FA3343	S 7390 A
WK880	S 9960 NC	EL3827	S 2950 A	(FORD)	S 7330 R	ELH4740	S 4000 O	FA3344	S 7A17 A
WK9010	S 4089 NR	EL3900	S 7138 A	ELH4122	S 5630 R	ELH4741		FA3349	S 7651 A
WK9014Z	S 4112 NR	EL9271	S 7679 A	ELH4125	S 5700 R	ELH4742	S 4120 R	FA3350	S 7516 A
WK9043	S 5394 GC	ELCA5004	S 6181 N	ELH4126		ELH4742	S 3292 R	FA3356	S 7643 A
WK9056	S 4480 NR	ELCA5005	S 8381 NC	(NISSAN)	S 3102 R	ELH4744	S 5016 PE	FA3357	S 7615 A
WK930/4 (AIFO, IVECO)	S 0610 NR	ELCA5006	S 6481 N	ELH4126		ELH4745	S 3497 R	FA3358	S 7562 A
WK939/14X	S 1071 B	ELD8100	S 7259 A	(O/OR) (VAG, VOLVO)	S 5603 R	ELH4746	S 3275 R	FA3360	S 7637 A
WK939/15	S 5394 GC	ELD8102	S 7F14 A	ELH4126		ELH4748	S 0280 PO	FA3361	S 7639 A
WK940/12	S 0310 NR	ELG5204 (MAN)	S 4378 NR	ELH4126	S 5600 R	ELH4749	S 4400 R	FA3362	S 7600 A
WK940/15	S 4471 NR	ELG5204 (ALTRE/OTHER APPL.)	S 8500 NR	(VAG, VOLVO)	S 5601 R	ELH4750	S 0900 R	FA3367	S 3373 A
WK940/19	S 6710 NR	ELG5205	S 8111 NC	ELH4135	S 1600 R	ELH4751	S 5007 PE	FA3376	S 7627 A
WK940/2	S 4341 NR	ELG5205B	S 8111 NC	ELH4142		ELH4753	S 3698 R	FA3388	S 2764 A
WK940/20	S 0712 NR	ELG5206	S 2610 NR	(VAG)	S 7500 R	ELH4755	S 5036 PE	FA3389	S 9380 A
WK940/22	S 4444 NR	ELG5208	S 9091 N	ELH4150	S 2510 O	ELH4756	S 3010 R	FA3401	S 7484 A
WK940/26 (BR)	S 4461 NR	ELG5209	S 7111 NC	ELH4151	S 7510 O	ELH4757	S 3288 R	FA3403	S 7422 A
WK940/33X	S 4461 NR	ELG5210	S 7600 NR	ELH4152	S 3003 DR	ELH4758	S 0620 R	FA3406	S 7A13 A
WK940/36X	S 4470 NR	ELG5211	S 8500 NR	ELH4157	S 3003 DR	ELH4759	S 5046 PE	FA3425	S 7558 A
WK940/42	S 4341 NR	ELG5212	S 1013 B	ELH4161	S 3280 R	ELH4761	S 5045 PE	FA3439	S 7A36 A
WK940/5	S 6710 NR	ELG5216	S 1410 NR	ELH4162		ELH4769	S 5081 PE	FA3440	S 7A35 A
WK940/6X	S 1410 NR	ELG5217	S 9600 NR	(VAG)	S 1563 R	ELH4771	S 5062 PE	FA3454	S 0650 A
WK950/13 (BR)	S 0810 NR	ELG5219	S 1410 NR	ELH4162		ELH4787	S 5181 PE	FA3463	S 7B10 A
WK950/19	S 1999 NR	ELG5223	S 9960 NC	(ALTRE/OTHER APPL.)	S 1560 R	ELP3745	S 3030 A	FA3472	S 7A59 A
WK950/21	S 2220 NR	ELG5234	S 4391 NR	ELH4162		ELP9157	S 5812 A	FA3473	S 7B45 A
WK950/3	S 0810 NR	ELG5252	S 4416 NR	(PERKINS)	S 0420 R	ELP9165	S 3340 A	FA3474	S 7A16 A
WK950/6	S 0999 NR	ELG5253	S 4408 NR	ELH4171	S 3257 R	ELP9441	S 6303 A	FA3475	S 7A03 A
WK962/4	S 8110 NR	ELG5283	S 5427 GC	ELH4175	S 9080 PO	ELR7019	S 3023 C	FA3478	S 7565 A
WK962/7	S 5020 NR	ELG5296	S 2320 NR	ELH4185		ELR7041	S 3051 A	FA3479	S 7564 A
WK965X	S 4478 NR	ELG5307	S 1H20 NR	(DAF, IVECO, KHD)	S 5802 R	ELR7077	S 3059 C	FA3491	S 7617 A
WP11102/1-2 (N.2 FILTRI/FILTERS)	S 2003 DR	ELG5320	S 4444 NR	ELH4185		ELR7228	S 3137 C	FA3494	S 4940 A
WP11102/3	S 4120 R	ELG5342	S 4107 NR	(ALTRE/OTHER APPL.)	S 5800 R	ELR7500	S 3072 C	FA3498	S 7A44 A
WP1144	S 3003 DR	ELG5356	S 5394 GC	ELH4193	S 9400 R	ELR7501	S 3089 C	FA3505	S 7A04 A
WP1169	S 5003 DR	ELG5375	S 1071 B	ELH4198	S 0122 O	ELR7503	S 3054 C	FA3511	S 7608 A
WP1170	S 3260 R	ELG5392	S 6072 NE	ELH4199	S 3081 PO	ELR7504	S 3062 C	FA3512	S 7408 A
ZR9007	S 5905 PO	ELG5415	S 4077 NR	ELH4206	S 5095 PE	ELR7505	S 3078 C	FA3522	S 7573 A
ZR9007Z	S 5905 PO	ELG5433	S 4150 NR	ELH4216	S 5011 PE	ELR7508	S 3448 C	FA3526	S 7A23 A
ZR902X	S 5900 PO	ELG5451	S 4006 NR	ELH4244	S 1600 R	ELR7513	S 3139 C	FA3549	S 7A09 A
ZR903X	S 5902 PO	ELG5454	S 6034 NE	ELH4253	S 2510 O	ELR7516	S 3048 C	FA3556	S 7A11 A
ZR904X	S 5903 PO	ELG5480	S 4149 NR	ELH4267	S 0130 R	ELR7518	S 3066 C	FA3572	S 7A50 A
ZR905Z	S 5904 PO	ELG5500	S 2161 N	ELH4267	S 5600 R	ELR7521	S 3139 C	FA3574	S 7F16 A
		ELG5501	S 2162 N	ELH4269	S 3102 R	ELR7523	S 3161 C	FA3575	S 7A26 A
		ELG5502	S 8110 NR	ELH4277	S 5601 R	ELR7526	S 3217 C	FA3576	S 7A25 A
		ELG5503	S 0710 NR	ELH4285	S 5013 PE	ELR7535	S 3289 C	FA3583	S 7359 A
		ELG5505	S 3010 N	ELH4286	S 0130 R	ELU8602	S 4401 U	FA3593	S 7A21 A
		ELG5506 (ALTRE/OTHER APPL.)	S 4323 NR	ELH4290	S 6180 PO	FA1123	S 7638 A	FA3601	S 7B80 A
		(IVECO, KHD)	S 5400 NR	ELH4304	S 1600 R	FA1429	S 7A24 A	FA3602	S 7B81 A
				ELH4310	S 9400 R	FA1443	S 7A22 A	FA3617	S 7649 A
				ELH4312	S 5026 PE	FA1519	S 2650 A	FA3623	S 7A14 A

**CROSS REFERENCES > CORRISPONDENZE >
CORRESPONDANCES > VERGLEICHNUMMERN > CRUCE DE REFERENCIAS**

FA3627	S 7694 A	0004662804	S 3081 PO	0014776601	S 1013 B	1021800109	S 9080 PO	6110920201	S 4416 NR
FA3628	S 7695 A	0004662904	S 5664 PO	0014777901	S 1013 B	1021801110	S 9080 PO	6110920601	S 4416 NR
FA3636	S 7C16 A	0004700192	S 0101 N	0018351547	S 3443 C	1021840325	S 9080 PO	6111800009	S 5013 PE
FA3698	S 0950 A	0004700922	S 7411 N	0018352747	S 3440 C	1021840425	S 9080 PO	61200190033	S 3940 A
		0004770103	S 4121 NR	0018354447	S 4378 NR	3141800009	S 4000 O	6120920001	S 4006 NR
	MENARINI	0004770815	S 7411 N	0018354947	S 3447 C	3141800109	S 5099 PE	6171800009	S 2510 O
	SOFIMA	0004771015	S 7411 N	0018355547	S 3447 C	3444777215	S 0101 N	6171840025	S 2510 O
0188144	S 6940 A	0004771302	S 4121 NR	0018357047	S 3283 C	3521800009	S 0300 O	6171840125	S 2510 O
0252947	S 7221 A	0004771515	S 1411 N	0018357147	S 3444 C	3521800109	S 5124 PE	6274660004	S 8790 PO
0252958	S 7222 A	0004771602	S 4472 NR	0018359147	S 3451 C	3521800209	S 2530 PO	6278350447	S 3081 C
0254326	S 7187 A	0004771702	S 4479 NR	0018359247	S 3279 C	3524700092	S 2161 N	6288350347	S 3456 C
0254386	S 7423 A	0004773115	S 0201 N	0020940004	S 2450 A	3551800009	S 9490 PO	6420901652	S 4077 NR
0254389	S 7408 A	0004773215	S 0201 N	0020942404	S 9570 A	3551800109	S 9490 PO	6420902252	S 4112 NR
0255796	S 7421 A	0004773515	S 1411 N	0020943204	S 3940 A	3554700092	S 0201 N	6420902352	S 4112 NR
178624	S 2840 A	0004773815	S 0101 N	0020943304	S 7165 A	3554700192	S 1411 N	6420920101	S 4107 NR
178625	S 6550 A	0004774015	S 1411 N	0020943404	S 4940 A	3568303118	S 3441 C	6420920201	S 4077 NR
188144	S 6940 A	0004774215	S 0101 N	0020946004	S 0950 A	3568304218	S 3442 C	6420920501	S 4107 NR
252947	S 7221 A	0004774315	S 6311 N	0020946104	S 1940 A	3621800110	S 8260 PO	6420920701	S 4107 NR
252958	S 7222 A	0004774515	S 1411 N	0020947004	S 7940 A	3641800009	S 5099 PE	6460900852	S 4107 NR
254326	S 7187 A	0004774715	S 7411 N	0020947304	S 5250 A	3641800109	S 5099 PE	6460920001	S 2320 NR
254386	S 7423 A	0004775315	S 7411 N	0020949204	S 3030 A	3641800309	S 5099 PE	6460920201	S 4107 NR
254389	S 7408 A	0004775415	S 0101 N	0020949304	S 3059 A	3661800009	S 5124 PE	6460920301	S 2320 NR
255796	S 7421 A	0004775715	S 0101 N	0021844001	S 5600 R	3661800310	S 5124 PE	6460920501	S 2320 NR
5000080	S 2370 A	0004776415	S 7411 N	0021847725	S 7261 PO	3661800609	S 5381 PO	6460920601	S 4107 NR
5001341	S 0150 A	0004776815	S 0101 N	0028351347	S 3283 C	3661800709	S 5132 PE	6460920701	S 4107 NR
		0004776915	S 7411 N	0028351447	S 3444 C	3661800909	S 5131 PE	6510900852	S 4150 NR
	MERCEDES BENZ	0005280006	S 7387 A	0028351847	S 3283 C	3661801009	S 5132 PE	6510901552	S 4149 NR
	SOFIMA	0008301118	S 3072 C	0028352547	S 3444 C	3661801309	S 5132 PE	6510902952	S 4149 NR
73524700092	S 2161 N	0008301218	S 3221 C	0030000604	S 7170 A	3661840125	S 5124 PE	6510903152	S 4150 NR
75411800209	S 5006 PE	0008301318	S 4225 CA	0030941504	S 1670 A	(ALCUNI IMPIEGHI/SOME APPL.)	S 5124 PE	6511800009	S 5159 PE
0000322405	S 7411 N	0008303318	S 3059 C	0030941604	S 7474 A	3661840125	S 5132 PE	6511800109	S 5159 PE
0000900751	S 6089 NE	0008303418	S 4225 CA	0030941707	S 7573 A	(ALCUNI IMPIEGHI/SOME APPL.)	S 5132 PE	6680900152	S 4416 NR
0000901151	S 2161 N	0008307318	S 3458 C	0030944204	S 7185 A	3661840125	S 5549 PO	6680902101	S 4416 NR
0000901251	S 6017 NE	0008307518	S 3448 C	0030944504	S 7129 A	(ALCUNI IMPIEGHI/SOME APPL.)	S 5549 PO	6680920201	S 4416 NR
0000901451	S 2162 N	0008308018	S 3457 C	0030945004	S 7546 A	3661840225	S 5099 PE	8690940003	S 7361 A
0000901551	S 6017 NE	0008308118	S 3457 C	0030946004	S 7187 A	(ALCUNI IMPIEGHI/SOME APPL.)	S 5099 PE	8690940020	S 1050 A
0000902051	S 6089 NE	0008309518	S 3459 C	0030947004	S 7213 A	3661840225	S 5381 PO	9018300018	S 3059 C
0000902651	S 3340 A	0008309618	S 3453 C	0030947504	S 3080 A	(ALCUNI IMPIEGHI/SOME APPL.)	S 5381 PO	9018300418	S 4281 CA
0000903751	S 3340 A	0008309718	S 4349 CA	0030948204	S 3080 A	3754770002	S 4143 NR	9018300518	S 3059 C
0000921505	S 0101 N	0008356947	S 3056 C	0030948304	S 3082 A	3760947104	S 2370 A	9041800009	S 5007 PE
0000921905	S 0101 N	0010000207	S 0201 N	0030949004	S 3373 A	4011800009	S 8260 PO	9060900051	S 6017 NE
0000922305	S 7411 N	0010920401	S 2610 NR	0030949104	S 7279 A	4011840025	S 8260 PO	9060920105	S 6017 NE
0000922705	S 2161 N	0010920501	S 2610 NR	0030949204	S 7280 A	4021800009	S 7261 PO	9060920205	S 6017 NE
0000924105	S 6089 NE	0010922201	S 9600 NR	0030949504	S 7383 A	4031840025	S 7261 PO	9060920305	S 6017 NE
0000928301	S 6710 NR	0010922301	S 9600 NR	0030949604	S 7383 A	4050940004	S 8502 A	9060920505	S 6017 NE
0000929001	S 2610 NR	0010922302	S 9600 NR	0040000604	S 0150 A	4220900051	S 2162 N	9068300218	S 3137 C
0000929501	S 2610 NR	0010922401	S 9600 NR	0040940204	S 7469 A	4220920005	S 2162 N	9068300318	S 4161 CA
0000940004	S 8790 PO	0010922501	S 2610 NR	0040940404	S 7516 A	4221800210	S 7261 PO	9361800009	S 5236 PE
0000944904	S 7813 A	0010923201	S 2610 NR	0040940904	S 2650 A	4411800009	S 5133 PE	9408350047	S 3436 C
0000945204	S 7813 A	0010928401	S 9600 NR	0040941104	S 3373 A	4411800109	S 5133 PE	9408350147	S 4345 CA
0001800109	S 4000 O	0010929001	S 9600 NR	0040941707	S 7573 A	4411800209	(N.2 FILTER/FILTERS)	9408350247	S 3438 C
0001800209	S 0122 O	0010940405	S 2810 A	0040941804	S 7695 A	4411800309	S 5549 PO	9608300018	S 3459 C
0001801609	S 5007 PE	0010941004	S 5270 A	0040942204	S 7608 A	4570900051	S 5133 PE	9608300118	S 4349 CA
0001801709	S 5036 PE	0010944204	S 2450 A	0040942304	S 7506 A	4760940004	S 6001 NE	9608300218	S 3453 C
0001802109	S 5062 PE	0010944504	S 0650 A	0040942404	S 7639 A	5410900051	S 7A12 A	9738350147	S 3054 C
0001802909	S 5062 PE	0010944604	S 0950 A	0040942504	S 7639 A	5410900151	S 6001 NE	9738350247	S 3437 C
0001842145	S 2530 PO	0010944704	S 2650 A	0040942604	S 3080 A	5410900205	S 6001 NE	A0000900751	S 6089 NE
0001842225	S 3081 PO	0010945204	S 2450 A	0040943304	S 7280 A	5410920305	S 6001 NE	A0000901151	S 2161 N
0001842325	S 3081 PO	0010946504	S 1070 A	0040943504	S 7A12 A	5410920405	S 6001 NE	A0000901451	S 2162 N
0001843825	S 7261 PO	0010947304	S 7998 A	0040943804	S 7423 A	5410920505	S 6001 NE	A0000901551	S 6017 NE
0001844025	S 2530 PO	0010947904	S 0450 A	0040943904	S 7646 A	5410920605	S 6001 NE	A00009015510010	S 6017 NE
0001844125	S 2530 PO	0010948004	S 0550 A	0040944104	S 3059 A	5410920805	S 6001 NE	A0000902051	S 6089 NE
0001844901	S 3081 PO	0010948204	S 4940 A	0040944604	S 7F31 A	5410920905	S 6001 NE	A0000902651	S 3340 A
0001845825	S 4000 O	0010948304	S 3570 A	0040945004	S 7546 A	5411800009	S 5006 PE	A0000903751	S 3340 A
0001846725	S 0300 O	0010949304	S 6370 A	0040946804	S 7F21 A	5411800083	S 5900 PO	A0000922705	S 2161 N
0001847825	S 4000 O	0010949404	S 1070 A	0040946904	S 7F22 A	5411800209	S 5006 PE	A0000924105	S 6089 NE
0001848525	S 0122 O	0010949504	S 2810 A	0040947204	S 7F20 A	5411840225	S 5006 PE	A0000928301	S 6710 NR
0002701098	S 2234 Z	0010949604	S 7550 A	0040947404	S 7F13 A	5411840325	S 5006 PE	A0000945204	S 7813 A
0002701198	S 5663 PO	0011840225	S 8260 PO	0040949004	S 7F20 A	6010900352	S 9600 NR	A0001800209	S 0122 O
0002701698	S 5663 PO	0011840425	S 8260 PO	0080000207	S 1411 N	6010901452	S 9600 NR	A0001801609	S 5007 PE
0002702398	S 5663 PO	0011840525	S 8260 PO	0080943102	S 0650 A	6010901552	S 9600 NR	A0001801709	S 5036 PE
0004291097	S 7259 A	0011842225	S 3081 PO	0090000207	S 7411 N	6010901652	S 9600 NR	A0001802109	S 5062 PE
0004292497	S 7F24 A	0011843825	S 7261 PO	0090940502	S 7002 A	6010920001	S 9600 NR	A0001802409	(KNECHT-MAHLE OX34D)
0004293695	S 7259 A	0011844125	S 5099 PE	0120948502	S 7998 A	6010920101	S 9600 NR	A0001802409	S 9080 PO
0004293795	S 7259 A	0011844225	S 5124 PE	0120948702	S 0450 A	6011800009	S 7510 O	A0001802409067	(KNECHT-MAHLE OX34D)
0004293995	S 7F24 A	0011844325	S 5124 PE	0130941502	S 6370 A	6011800109	S 7510 O	A0001802909	S 9080 PO
0004294895	S 7F24 A	0011844425	S 5099 PE	0130941702	S 2650 A	6011800210	S 7510 O	A0001802909	S 5062 PE
0004295495	S 7F24 A	0011844925	S 2530 PO	0130941802	S 2450 A	6011800610	S 2510 O	A0002701198	S 5663 PO
000429549528	S 7F24 A	0011845125	S 5099 PE	0140000207	S 2530 PO	6011840025	S 7510 O	A0002701698	S 5663 PO
0004295695	S 7A66 A	0011845225	S 5124 PE	0180000207	S 0300 O	6011840125	S 7510 O	A0002702398	S 5663 PO
0004295795	S 7A66 A	0011845425	S 5099 PE	0210000207	S 0101 N	6020900552	S 9600 NR	A0004293795	S 7259 A
0004300669	S 7259 A	0011845525	S 5124 PE	0230000207	S 2450 A	6020920101	S 9600 NR	A0004293995	S 7F24 A
0004300969	S 7259 A	0011845625	S 9490 PO	0340000207	S 8260 PO	6020920101	S 9600 NR	A0004294895	S 7F24 A
0004604283	S 5664 PO	0011846725	S 2530 PO	0360000207	S 7261 PO	6061800009	S 5095 PE	A0004295495	S 7F24 A
0004660004	S 8790 PO	0011849325							

**CROSS REFERENCES > CORRISPONDENZE >
CORRESPONDANCES > VERGLEICHNUMMERN > CRUCE DE REFERENCIAS**

A0004604283	S 5664 PO	A0040946804	S 7F21 A	A9360921105	S 6148 NE	M323	S 4323 NR	R284	S 7284 A
A0004660004	S 8790 PO	A0040946904	S 7F22 A	A9361800009	S 5236 PE	M329	S 4329 NR	R285	S 7285 A
A0004660604	S 3081 PO	A0040947204	S 7F20 A	A9408350047	S 3436 C	M335	S 0310 NR	R286	S 7286 A
A0004662804	S 3081 PO	A0040947404	S 7F13 A	A9408350147	S 4345 CA	M336	S 5020 NR	R288	S 7288 A
A0004662904	S 5664 PO	A0040949004	S 7F20 A	A9408350247	S 3438 C	M337	S 4337 NR	R344	S 7344 A
A0004770103	S 4121 NR	A1021840425	S 9080 PO	A9608300018	S 3459 C	M342	S 4120 NR	R345	S 7345 A
A0004771302	S 4121 NR	A3521800209	S 2530 PO	A9608300118	S 4349 CA	M351	S 8500 NR	R358	S 7358 A
A0004771602	S 4472 NR	A3568303118	S 3441 C	A9608300218	S 3453 C	M351A	S 8501 NR	R361A	S 7562 A
A0004771702	S 4479 NR	A3568304218	S 3442 C	A9738350147	S 3054 C	M355	S 8501 NR	R390	S 7390 A
A0004773815	S 0101 N	A3641800009	S 5099 PE	A9738350247	S 3437 C	M355A	S 8500 NR	R423	S 0940 A
A0008301118	S 3072 C	A3641800109	S 5099 PE	AA0040942604	S 3080 A	M358A	S 5401 NR	R440	S 7637 A
A0008301218	S 3221 C	A3641800309	S 5099 PE	B67582412	S 3437 C	M360	S 7111 NC	R442	S 7649 A
A0008303318	S 3059 C	A3661800709	S 5132 PE	B67582414	S 4345 CA	M360A	S 7112 NC	R443	S 7616 A
A0008303418	S 4225 CA	A3661800809	S 5124 PE	B67582415	S 3438 C	M361	S 8111 NC	R453	S 7549 A
A0008307318	S 3458 C	A3661800909	S 5131 PE			M362	S 8381 NC	R457	S 7406 A
A0008307518	S 3448 C	A3661801009	S 5132 PE			M363A	S 0610 NR	R469	S 7469 A
A0008308018	S 3457 C	A3661801309	S 5132 PE			M365A	S 7600 NR	R488	S 7614 A
A0008308118	S 3457 C	A3754770002	S 4143 NR			M369	S 3010 N	R513	S 7A59 A
A0008309518	S 3459 C	A4011800009	S 8260 PO	C059	S 4311 N	M371	S 9960 NC	R517	S 7280 A
A0008309618	S 3453 C	A4021800009	S 7261 PO	E013	S 1013 B	M375	S 1410 NR	R527	S 7213 A
A0008309718	S 4349 CA	A4050940004	S 8502 A	F001	S 6001 NE	M391	S 4391 NR	R529	S 7564 A
A0008356947	S 3056 C	A4411800009	S 5133 PE	F011	S 6011 NE	M408	S 4408 NR	R532	S 7617 A
A000901251	S 6017 NE	A4411800109	S 5133 PE	F602	S 6181 N	M416	S 4416 NR	R534	S 7565 A
A0009891311	S 7A14 A	A4411800209		F604	S 1411 N	M500	S 0999 NR	R535	S 7A44 A
A0010923201	S 2610 NR	(N.2 FILTRI/FILTERS)	S 5549 PO	F605	S 6911 N	M601	S 2320 NR	R537	S 7548 A
A0010928401	S 9600 NR	A4411800309	S 5133 PE	F606	S 4211 N	MM327	S 0810 NR	R544	S 7A03 A
A0010941004	S 5270 A	A4571840125	S 5062 PE	F609	S 7411 N	O001	S 8410 AR	R545	S 7A04 A
A0010944704	S 2650 A	A4701800009	S 5237 PE	F618	S 6311 N	P051	S 3051 A	R565	S 7408 A
A0010947304	S 7998 A	A4701800109	S 5237 PE	F623	S 7200 N	P080	S 3080 A	R582	S 7A23 A
A0010947904	S 0450 A	A4721800109	S 5156 PE	F645	S 6645 N	P080A	S 3082 A	R585	S 7484 A
A0010948204	S 4940 A	A4721800309	S 5156 PE	F652	S 9091 N	P415	S 3541 A	R627	S 7627 A
A0010948304	S 3570 A	A4721800409	S 5156 PE	HB120	S 3023 C	P806	S 0450 A	R647	S 7A17 A
A0010949304	S 6370 A	A4721800609	S 5156 PE	HB144	S 3059 C	P843A	S 2810 A	R660	S 7A13 A
A0010949504	S 2810 A	A4731800009	S 5156 PE	HB147	S 3053 C	P917A	S 3330 A	R665	S 7A35 A
A0014777901	S 1013 B	A4731800309	S 5156 PE	HB150	S 3072 C	PM800	S 3080 A	R666	S 7A36 A
A0018351547	S 3443 C	A4760940004	S 7A12 A	HB237	S 3217 C	R007	S 1050 A	R692	S 7578 A
A0018352747	S 3440 C	A5410900051	S 6001 NE	HB258	S 3448 C	R008	S 7008 A	R697	S 7608 A
A0018354447	S 4378 NR	A5410900151	S 6001 NE	HB262	S 3443 C	R011	S 7011 A	R706	S 0760 A
A0018354947	S 3447 C	A5410920305	S 6001 NE	L005	S 5005 PE	R014	S 7670 A	R714	S 7B10 A
A0018355447	S 3081 C	A5410920405	S 6001 NE	L006	S 5006 PE	R015	S 8270 A	R718	S 8760 A
A0018355547	S 3447 C	A5410920505	S 6001 NE	L011	S 5011 PE	R017	S 7017 A	R719	S 0660 A
A0018357047	S 3283 C	A5410920605	S 6001 NE	L011A	S 5011 PE	R022	S 6270 A	R727	S 7A25 A
A0018357147	S 3444 C	A5410920805	S 6001 NE	L013	S 5013 PE	R023	S 7023 A	R730	S 5060 A
A0018359147	S 3451 C	A5410920905	S 6001 NE	L081	S 5081 PE	R024	S 7024 A	R734	S 7642 A
A0018359247	S 3279 C	A5411800009	S 5006 PE	L097	S 5097 PE	R028	S 7028 A	R752	S 2460 A
A0020940004	S 2450 A	A5411800083	S 5900 PO	L103	S 5016 PE	R033	S 7033 A	R789	S 9990 A
A0020943204	S 3940 A	A5411800209	S 5006 PE	L111	S 5026 PE	R054	S 3940 A	R793	S 0150 A
A0020943304	S 7165 A	A5411840225	S 5006 PE	L135	S 5062 PE	R055	S 1940 A	R794	S 8940 A
A0020943404	S 4940 A	A5411840325	S 5006 PE	L146	S 5181 PE	R067	S 7940 A	R802	S 2450 A
A0020946104	S 1940 A	A6010900352	S 9600 NR	L401	S 0580 PO	R081A	S 1540 A	R804	S 0950 A
A0020947004	S 7940 A	A6010901452	S 9600 NR	L402A	S 3180 PO	R084	S 9240 A	R805	S 2650 A
A0020947304	S 5250 A	A6011800109	S 7510 O	L406A	S 3081 PO	R084A	S 9240 A	R806	S 0450 A
A0028351347	S 3283 C	A6011840125	S 7510 O	L407A	S 1080 PO	R092	S 8570 A	R813A	S 7813 A
A0028351447	S 3444 C	A6061800009	S 5095 PE	L408	S 0280 PO	R1014	S 7359 A	R820	S 8350 A
A0028351847	S 3283 C	A6061840225	S 5095 PE	L409A	S 4080 PO	R1018	S 7A50 A	R828	S 4940 A
A0028352547	S 3444 C	A6110900852	S 4416 NR	L413	S 6180 PO	R1031	S 7B36 A	R838	S 0550 A
A0030941104	S 7945 A	A6110920201	S 4416 NR	L421	S 6380 PO	R1041	S 7F16 A	R839	S 7839 A
A0030941204	S 7024 A	A6110920601	S 4416 NR	L422	S 2530 PO	R1060	S 7B80 A	R857	S 3570 A
A0030941504	S 1670 A	A6111800009	S 5013 PE	L423		R1061	S 7B81 A	R862	S 4450 A
A0030941604	S 7474 A	A6120920001	S 4006 NR	(MAN)	S 7260 PO	R107	S 7107 A	R863	S 6450 A
A0030944204	S 7185 A	A612092000164	S 4006 NR	L423		R1077	S 7A14 A	R875	S 0270 A
A0030944504	S 7129 A	A6274660004	S 8790 PO	(MERCEDES BENZ)	S 7261 PO	R1080	S 7694 A	R877	S 5270 A
A0030947004	S 7213 A	A6288350347	S 3456 C	L431	S 1910 PO	R1082	S 7626 A	R878	S 8950 A
A0030947504	S 3080 A	A6420920101	S 4107 NR	L439	S 6290 PO	R1102	S 7C16 A	R879	S 7170 A
A0030948204	S 3080 A	A6420920201	S 4077 NR	L443	S 7380 PO	R1143	S 7D41 A	R881	S 0650 A
A0030949104	S 7279 A	A6420920401	S 4112 NR	L446	S 5446 PO	R129	S 7129 A	R885	S 7A16 A
A0030949204	S 7280 A	A6420920501	S 4107 NR	L447	S 3300 PO	R130	S 1307 A	R888	S 1506 A
A0030949604	S 7383 A	A6460900852	S 4107 NR	L447A	S 3301 PO	R138	S 7138 A	R888A	S 1506 A
A0040940204	S 7469 A	A6460920301	S 2320 NR	L451	S 6490 PO	R143	S 7143 A	R889	S 7550 A
A0040940404	S 7516 A	A6460920501	S 2320 NR	L455	S 4380 PO	R144	S 7144 A	R892	S 2570 A
A0040940904	S 2650 A	A6460920701	S 4107 NR	L499	S 2510 O	R148	S 5650 A	R893	S 6550 A
A0040941104	S 3373 A	A6510900852	S 4150 NR	L505	S 8260 PO	R158	S 0050 A	R894	S 2840 A
A0040941707	S 7573 A	A6510901552	S 4149 NR	L528	S 7510 O	R160	S 7160 A	R902	S 0060 A
A0040941804	S 7695 A	A6510902952	S 4149 NR	L530	S 9080 PO	R161	S 7161 A	R919	S 2370 A
A0040942204	S 7608 A	A6510903152	S 4150 NR	L536	S 5536 PO	R165	S 7165 A	R920	S 2950 A
A0040942304	S 7506 A	A6511800009	S 5159 PE	L545	S 9490 PO	R168	S 7168 A	R920A	S 2950 A
A0040942404	S 7639 A	A6511800109	S 5159 PE	L546	S 5124 PE	R183	S 7183 A	R923	S 2370 A
A0040942504	S 7639 A	A6511800309	S 5159 PE	L549	S 5549 PO	R185	S 7185 A	R924	S 0840 A
A0040943304	S 7280 A	A6680900152	S 4416 NR	L583	S 5095 PE	R187	S 7187 A	R926	S 4270 A
A0040943504	S 7A12 A	A6680920101	S 4416 NR	LM520	S 0530 PO	R189	S 1670 A	R932	S 0850 A
A0040943704	S 7A21 A	A9018300418	S 4281 CA	M306	S 0510 NR	R209	S 6940 A	R933	S 7368 A
A0040943804	S 7423 A	A9041800009	S 5007 PE	M307	S 5400 NR	R214	S 7214 A	R935	S 0940 A
A0040943904	S 7646 A	A9061800009	S 5036 PE	M308	S 0710 NR	R215	S 5250 A	R942	S 7A21 A
A0040944104	S 3059 A	A9061800209	S 5036 PE	M309	S 8110 NR	R221	S 7221 A	R944	S 8840 A
A0040944604	S 7F31 A	A9068300218	S 3137 C	M313	S 0810 NR	R222	S 7222 A	R945	S 7945 A
A0040945704	S 7694 A	A9068300318	S 4161 CA	M314	S 6710 NR	R276	S 7276 A	R949	S 2850 A
A0040946604	S 3373 A	A9360900351	S 6148 NE	M319A	S 2610 NR	R277	S 7277 A	R950	S 0070 A
A0040946704	S 3059 A	A9360903855	S 6148 NE	M321	S 9600 NR	R279	S 7279 A	R966	S 2070 A

**CROSS REFERENCES > CORRISPONDENZE >
CORRESPONDANCES > VERGLEICHNUMMERN > CRUCE DE REFERENCIAS**

L434	S 4000 O			5001846638	S 5802 R	7420998806	S 6039 NE	A5318	S 2650 A
L443	S 9490 PO	RACOR	SOFIMA	5001846639	S 8600 R	7420998809	S 5097 PE	A5407	S 6550 A
L459	S 2510 O			5001846641	S 4402 R	7421243188	S 7A03 A	A5408	S 2840 A
L503	S 1910 PO	PFA5628	S 3078 C	5001846643	S 3408 R	7421267793	S 7F23 A	A5412	S 6650 A
L509	S 5159 PE	PFA5629	S 4346 CA	5001846644	S 3275 R	7421333098	S 4402 U	A5425	S 4270 A
L540	S 9080 PO	R120T	S 4159 NR	5001846647	S 4120 R	7421337443	S 7B39 A	A54490	S 7368 A
L561	S 5124 PE	R160DIVEC01	S 4474 NR	5001847123	S 3541 A	7421337557	S 7B39 A	A5501	S 7033 A
L563	S 2530 PO	R160G	S 4474 NR	5001850947	S 4394 NR	7421380403	S 4158 NR	A5519	S 8350 A
L564	S 8260 PO	R260P	S 4461 NR	5001852912	S 6088 NE	7421380472	S 4157 NR	A5521	S 7008 A
L565		R270PL		5001853256	S 5900 PO	7421380483	S 4146 NR	A5523	S 7170 A
(MERCEDDES BENZ)	S 7261 PO	(MAN)	S 4035 NR	5001853860	S 0712 NR	7421380500	S 4479 NR	A5526	S 7040 A
L565		R420PL	S 4142 NR	5001855259	S 5663 PO	7421519716	S 5664 PO	A5529	S 7041 A
(MAN)	S 7260 PO	R60P-D-MAX	S 4158 NR	5001858000	S 5900 PO	7421561278	S 4402 R	A5543	S 8350 A
L566	S 7510 O	R60RDRCR01	S 4157 NR	5001858001	S 5903 PO	7421561284	S 4120 R	A5593	S 7A35 A
L567	S 9080 PO	R90DAF	S 4143 NR	5001858099	S 3288 R	7421574991	S 4405 U	A5594	S 7A36 A
L769	S 2530 PO	R90DIVEC01	S 4472 NR	5001859295	S 0999 NR	7421602383	S 7F23 A	A5610	S 7024 A
L779	S 5124 PE	R90HDDIVEC01	S 4068 NR	5001860111	S 4408 NR	7421700201	S 0900 R	A5618	S 7945 A
L781	S 5536 PO	R90P	S 4143 NR	5001864855	S 6062 NE	7421764968	S 4477 NR	A5628	S 8950 A
L809	S 5446 PO	R90RDRCR01	S 4146 NR	5001864856	S 6059 NE	7421764981	S 4477 NR	A5640	S 2370 A
L973	S 5159 PE	R90T	S 4138 NR	5001865404	S 7F23 A	7421990552	S 5238 PE	A5641	S 4370 A
LS149		R90T-D-MAX	S 4472 NR	5001865723	S 7643 A	7422051238	S 5238 PE	A5707	S 6940 A
(TOYOTA)	S 1600 R			5001865724	S 7B10 A	7423044513	S 4120 NR	A5708	S 0900 A
LS149		RENAULT TRUCKS	SOFIMA	5001865725	S 7645 A	7424990730	S 3161 C	A5714	S 7359 A
(VOLVO)	S 3257 R			5001869771	S 1600 R	7424990731	S 4348 CA	A5719	S 7026 A
LS186		0000208835	S 0510 NR	5001869788	S 5394 GC	7424992237	S 7F15 A	A57250	S 7B80 A
(VAG, VOLVO)	S 5601 R	0000208895	S 0510 NR	5001869822	S 9380 A	7424993464	S 7637 A	A5803M	S 7617 A
LS186		0000314914	S 5600 R	5006002224	S 4470 NR	7424993589	S 3217 C	A6008	S 8940 A
(VAG, VOLVO)	S 1560 R	0003005121	S 8381 NC	5010064371	S 7343 A	7424993600	S 3452 C	A6009	S 4370 A
LS186		0003005828	S 3010 N	5010064372	S 7342 A	7424993603	S 3438 C	A6101	S 2370 A
(MAN, MWM, PORSCHE)	S 3241 R	0003036404	S 0510 NR	5010066387	S 7024 A	7424993604	S 3436 C	A6113	S 6550 A
LS186		0003563001	S 0940 A	5010094145	S 7342 A	7424993605	S 4347 CA	A6201	S 4940 A
(TOYOTA)	S 5600 R	0003563570	S 4940 A	5010094146	S 7372 A	7424993606	S 4345 CA	A6207	S 2450 A
LS186		0003563591	S 5600 R	5010094154	S 7343 A	7424993607	S 4346 CA	A6210	S 7129 A
(O/OR) (VAG, VOLVO)	S 5603 R	0003563595	S 2650 A	5010197265	S 8137 RH	7424993610	S 6088 NE	A6211	S 0950 A
LS194		0003564001	S 0940 A	5010197266	S 8137 RH	7424993612	S 6089 NE	A6212	S 1940 A
(ALFA ROMEO, LADA)	S 1600 R	0003564042	S 2950 A	5010230841	S 7357 A	7424993613	S 6064 NE	A6218	S 7813 A
LS235	S 3003 DR	0003564049	S 6940 A	5010240400	S 3698 R	7424993614	S 6063 NE	A6224	S 1307 A
LS236	S 5003 DR	0003564110	S 8840 A	5010295195	S 3698 R	7424993621	S 4143 NR	A6302	S 3940 A
LS278	S 5601 R	0003564115	S 8940 A	5010305203	S 7343 A	7424993622	S 4472 NR	A6303	S 0450 A
LS280A	S 0130 R	0003564117	S 0150 A	5010315990	S 2764 A	7424993623	S 4479 NR	A6504	S 1005 A
LS286	S 3425 R	0003564118	S 6550 A	5010317300	S 3541 A	7424993629	S 4478 NR	A6702	S 9990 A
LS328	S 5603 R	0003564119	S 2840 A	5010317658	S 5812 A	7424993633	S 7F16 A	A6806	S 0550 A
LS386	S 5820 R	0003564124	S 0940 A	5010359706	S 4471 NR	7424993635	S 7B01 A	A6807	S 7998 A
LS389	S 0920 R	0003564135	S 4770 A	5010382032	S 1028 B	7424993648	S 5181 PE	A6808	S 0650 A
LS412		0003564137	S 7945 A	5010412350	S 0712 NR	7424993655	S 5904 PO	A68560	S 7A21 A
(RENAULT VI, STEYR)	S 3241 R	0004036404	S 0510 NR	5010423885	S 7575 A	7425986969	S 8137 RH	A7117	S 7565 A
LS453A		0004205626	S 3010 N	5010437143	S 5903 PO	7482348995	S 3454 C	A7118	S 7564 A
(PERKINS)	S 9400 R	0008503375	S 4000 O	5010450824	S 0712 NR	7482351184	S 4350 CA	A71250	S 7576 A
LS454		0008517223	S 4000 O	5010477855	S 0712 NR	7482379897	S 3455 C	A71400	S 7A03 A
(PERKINS)	S 1380 R	0941718016	S 0510 NR	5010505337	S 0712 NR	7482499570	S 4350 CA	A7203	S 8840 A
LS454		0944700033	S 4380 PO	5010550600	S 0900 R	7485116634	S 9320 NR	A7204	S 7010 A
(ALTRE/OTHER APPL.)	S 7500 R	0944700122	S 4000 O	5021107418	S 5613 PO	7485119973	S 9380 A	A7612	S 7144 A
LS468	S 0130 R	0944700162	S 4000 O	5021107643	S 3053 C	7485132676	S 5394 GC	A7613	S 7143 A
LS468A	S 0130 R	5000133555	S 0900 R	5021149053	S 7405 A	7485134458	S 3217 C	A7805	S 0850 A
LS479D	S 8600 R	5000240934	S 3010 N	5021149060	S 8502 A	7485135854	S 7F23 A	A7908	S 0150 A
LS482	S 7330 R	5000243098	S 7260 PO	5021149062	S 7970 A	7485138439	S 4405 U	A7912	S 5450 A
LS494	S 5600 R	5000289323	S 8605 HP	5021185104	S 4281 CA	7485145388	S 1411 GC	A7913	S 7670 A
LS506	S 6100 R	5000295422	S 7F24 A	5021185552	S 7695 A	81125030019	S 0101 N	A7915	S 3450 A
LS507	S 1600 R	5000560078	S 7614 A	5021185583	S 4260 CA			A7922	S 1050 A
LS520B	S 5630 R	5000670735	S 5900 PO	5021185611	S 5664 PO	SAKURA	SOFIMA	A7926	S 2070 A
LS520C	S 5630 R	5000670737	S 5900 PO	5021185681	S 5234 PE			A7934	S 8570 A
LS553B	S 5601 R	5000745966	S 7A22 A	5021188059	S 6004 NE	A1010	S 0060 A	A7964	S 2850 A
LS553D	S 5603 R	5000751674	S 7372 A	5021188309	S 7B11 A	A1024	S 2370 A	A8004	S 8950 A
LS581	S 7600 R	5000787564	S 7A22 A	5021188409	S 3442 C	A1313	S 4270 A	A8005	S 8950 A
LS582	S 5600 R	5000802170	S 7614 A	5021192681	S 4470 NR	A2202	S 0660 A	A8103	S 7559 A
LS583		5000807196	S 7A22 A	5021192696	S 7F17 A	A2205	S 0840 A	A83090	S 7A44 A
(DAF, IVECO, KHD)	S 5802 R	5000807212	S 2234 Z	7420430751	S 4120 R	A2210	S 0150 A	A8580	S 7422 A
LS583		5000807213	S 2234 Z	7420514654	S 4461 NR	A22350	S 7626 A	A9204	S 6270 A
(ALTRE/OTHER APPL.)	S 5800 R	5000809894	S 7638 A	7420541379	S 4120 R	A22360	S 7390 A	A9206	S 8270 A
LS702	S 2030 R	5000812484	S 4120 R	7420541381	S 9320 NR	A22370	S 7563 A	A9226	S 2570 A
LS712	S 8600 R	5000814695	S 7A24 A	7420541383	S 4461 NR	A2406	S 7549 A	AS1014	S 2950 A
LS712C	S 8600 R	5000814696	S 7A24 A	7420580233	S 5664 PO	A2408	S 7578 A	C5501	S 0900 R
LS717	S 3102 R	5000814943	S 7A22 A	7420591256	S 4158 NR	A2533	S 7357 A	C8041	S 3280 R
LS738	S 3003 DR	5000953712	S 7368 A	7420745605	S 4146 NR	A25340	S 7406 A	C8504	S 3592 R
LS753	S 5600 R	5001010063	S 3217 C	7420754418	S 4479 NR	A2536	S 7645 A	CA68010	S 3053 C
LS778	S 0900 R	5001020327	S 7343 A	7420779040	S 5238 PE	A25370	S 7404 A	CA83020	S 3289 C
LS782	S 1220 R	5001021501	S 7627 A	7420796772	S 6039 NE	A26020	S 7A14 A	CAC2404	S 4260 CA
LS783	S 9030 R	5001831431	S 2234 Z	7420796782	S 5097 PE	A2621	S 3080 A	EF10050	S 6034 NE
LS785A	S 3280 R	5001833354	S 3217 C	7420851191	S 4158 NR	A2622	S 3373 A	EO10050	S 5156 PE
LS841	S 0900 R	5001843522	S 7344 A	7420875666	S 4120 NR	A49480	S 7573 A	EO2626	S 5007 PE
LS842	S 4120 R	5001846015	S 4475 NR	7420877950	S 4402 U	A5101	S 7091 A	EO83020	S 5181 PE
LS844	S 3275 R	5001846099	S 4394 NR	7420877953	S 4402 U	A5301	S 2650 A	FC1803	S 1410 NR
LS845	S 3409 R	5001846545	S 5900 PO	7420877958	S 4406 U	A53030	S 7639 A	H7102	S 2234 Z
LS880	S 0130 R	5001846546	S 5900 PO	7420972291	S 4120 NR	A5309	S 7165 A	HC6802	S 8605 HP
LS880A	S 0130 R	5001846630	S 8260 PO	7420976001	S 9320 NR	A5311	S 1450 A	SAC57010	S 7A86 A
LS900	S 1270 R	5001846631	S 7261 PO	7420998346	S 4157 NR	A5312	S 6370 A	SFC24020	S 4146 NR
LS939	S 7600 R	5001846636	S 5800 R	7420998349	S 4146 NR	A5315	S 3570 A	SFC24030	S 4157 NR
LS950	S 0420 R	5001846637	S 7600 R	7420998634	S 4461 NR	A5315-1	S 3570 A	SFC5304-10	S 4068 NR

**CROSS REFERENCES > CORRISPONDENZE >
CORRESPONDANCES > VERGLEICHNUMMERN > CRUCE DE REFERENCIAS**

SFC7109-30	S 4158 NR	2037556	S 5181 PE	SK3600/3	S 4323 NR	SL81264	S 7484 A	ST1393	S 7F23 A
SFC7912-10	S 4138 NR	2057893	S 5044 PE	SK3615	S 4329 NR	SL81267/1	S 7A16 A	SW1611	S 9006 AR
SFC7912-30	S 4143 NR	2059778	S 4402 R	SK3761	S 1013 B	SL81343	S 7F18 A		
SFC7939-30	S 4142 NR	2077885	S 4402 R	SK3762	S 1028 B	SL81344	S 7F19 A	SISU	SOFIMA
WC7101	S 9006 AR	2081360	S 7F30 A	SK3820	S 8500 NR	SL81348	S 7B45 A	1273 400211	S 4478 NR
		210970	S 4323 NR	SK3820/1	S 8501 NR	SL81359	S 7646 A	1273 400212	S 4478 NR
SCANIA	SOFIMA	211589	S 0550 A	SK3827	S 4311 N	SL81361	S 7649 A	1273 400213	S 4478 NR
		211811	S 0550 A	SK3828	S 0710 NR	SL81394	S 7A21 A	1293400192	S 1005 A
1117285	S 4402 R	217517	S 0450 A	SK3943/1	S 6059 NE	SL81426	S 7A29 A		
11436936	S 2329 R	218989	S 2450 A	SK3943HNBR	S 6062 NE	SL81444	S 7A09 A	SOFIMA HYDRAULICS	SOFIMA
1326180	S 3452 C	219517	S 0450 A	SK3953	S 2162 N	SL8155	S 7221 A	20.304	S 2234 Z
1329876	S 5613 PO	2283473	S 3457 C	SK3960	S 7112 NC	SL8156	S 7222 A	CCA152CD1	S 8605 HP
1335678	S 7358 A	2283474	S 3457 C	SK3970	S 8111 NC	SL81622	S 7A03 A	STX8ACD	S 5569 PO
1335679	S 7286 A	2307617	S 7F30 A	SK3980	S 7111 NC	SL81626	S 7B36 A		
1335680	S 7A44 A	2343432	S 7F26 A	SK3985	S 6710 NR	SL81640	S 7C13 A		
1335681	S 7D41 A	235586	S 2650 A	SK48550	S 6043 NE	SL81647	S 7694 A		
1341638	S 0310 NR	2484686	S 7F30 A	SK48637	S 6044 NE	SL81654	S 7650 A	SOGEFIPRO	SOFIMA
1347726	S 4402 R	2562323	S 7F30 A	SK48669	S 4149 NR	SL8167	S 7A34 A	FA0455	S 9091 N
1357109	S 6449 PO	261185	S 0050 A	SK48795	S 6080 NE	SL81756	S 7C16 A	FA0586ECO	S 5095 PE
1372444	S 0310 NR	275588	S 1050 A	SK5210	S 0999 NR	SL81785	S 7617 A	FA2401D	S 1080 PO
1375997	S 7259 A	30781990	S 0050 A	SKL2422	S 3023 C	SL81909	S 7D41 A	FA3404/2	S 7411 N
1377099	S 7642 A	309439	S 0101 N	SKL2503	S 3089 C	SL8287	S 7361 A	FA3430	S 6380 PO
1379952	S 3066 C	309443	S 0550 A	SKL2503-AK	S 4260 CA	SL8299	S 7638 A	FA3434	S 7380 PO
1381235	S 5613 PO	326065	S 4323 NR	SKL46022	S 3054 C	SL83015	S 7B39 A	FA3448	S 4380 PO
1384549	S 7344 A	342988	S 9007 AR	SKL46023	S 3081 C	SL8344	S 7356 A	FA4154	S 4211 N
1387548	S 7615 A	343144	S 8501 NR	SKL46061	S 3092 C	SL8348	S 7343 A	FA4156	S 6911 N
1387549	S 7970 A	364624	S 4323 NR	SKL46105	S 3139 C	SL8349	S 7342 A	FA4161/2	S 1411 N
1393640	S 4143 NR	365727	S 7186 A	SKL46107	S 3078 C	SL8350	S 7372 A	FA4225	S 1910 PO
1411894	S 4341 NR	365729	S 0050 A	SKL47117	S 3161 C	SL8352	S 7288 A	FA4252	S 0580 PO
1420197	S 3066 C	370750	S 7186 A	SKL47158	S 3315 C	SL8390	S 7506 A	FA4287	S 3300 PO
1421021	S 7358 A	370754	S 0050 A	SKV404	S 1028 B	SL8391	S 7507 A	FA4287A	S 3301 PO
1421022	S 7286 A	378396	S 9007 AR	SL1695	S 7107 A	SL8440	S 7428 A	FA4417	S 6481 N
1429059	S 6008 NE	385773	S 8570 A	SL4942	S 7277 A	SL8453	S 0450 A	FA4511	S 6490 PO
1439036	S 5044 PE	395776	S 7214 A	SL4946	S 7285 A	SL8454	S 1450 A	FA4584	S 8790 PO
1446432	S 6008 NE	395813	S 7288 A	SL4947	S 7278 A	SL8495	S 2450 A	FA4820	S 2530 PO
1455253	S 7344 A	397813	S 7288 A	SL4951	S 7576 A	SL8556	S 8950 A	FA4830	S 7260 PO
1459762	S 6010 NE	457431326	S 4323 NR	SL5652	S 7423 A	SL8574	S 7276 A	FA4901A	S 7261 PO
1485592	S 7A50 A	482749	S 3053 C	SL5653	S 7408 A	SL8586	S 0850 A	FA5314	S 6645 N
150354	S 7111 NC	5347	S 7259 A	SL5654	S 7432 A	SL8602	S 1050 A	FA5377ECO	S 5005 PE
1510905	S 7A11 A	6750258236	S 2329 R	SL5668/1	S 7A25 A	SL8603	S 1307 A	FA5393	S 5613 PO
1510942	S 7649 A	965729	S 0050 A	SL5669/1	S 7A26 A	SL8662	S 7337 A	FA5501	S 9080 PO
1526086	S 7615 A			SL5700	S 7469 A	SL8852	S 2840 A	FA5554ECO	S 6017 NE
1526087	S 7970 A	SEPAR FILTER	SOFIMA	SL5883	S 9870 A	SL8896	S 7129 A	FA5556ECO	(MERCEDES BENZ A3661800909)
152875	S 1411 N			SL5888	S 7279 A	SL8901	S 7607 A	FA5556ECO	(MERCEDES BENZ A3641800309)
153468	S 3081 PO	00530/50	S 6063 NE	SL5890	S 7280 A	SL8950	S 0060 A	FA5556ECO	S 5131 PE
1545482	S 4401 U	00530/50H	S 6064 NE	SL5895	S 7482 A	SL8969	S 7008 A	FA5556ECO	
168185	S 8790 PO	01030	S 6062 NE	SL5929	S 7608 A	SO1205	S 1080 PO	FA5559ECO	S 5099 PE
1728667	S 7A25 A	01030HV	S 6059 NE	SL60142	S 9380 A	SO1257	S 6490 PO	FA5559ECO	S 5006 PE
1728817	S 7A26 A	0530/50	S 6063 NE	SL6177	S 0070 A	SO4095/1	S 5007 PE	FA5560ECO	S 5124 PE
1730757	S 7642 A	1030	S 6062 NE	SL6178	S 7338 A	SO4137	S 7380 PO	FA5561ECO	S 5132 PE
173171	S 2329 R	1030HV	S 6059 NE	SL6202	S 7575 A	SO4185	S 8260 PO	FA5563ECO-2	S 5133 PE
1736248	S 6147 NE			SL6208	S 0650 A	SO4336	S 5011 PE	FA5594ECO	S 5016 PE
1736250	S 6147 NE			SL6212	S 4940 A	SO4580/1	S 5016 PE	FA5595ECO	S 5036 PE
1736251	S 6147 NE			SL6214	S 0950 A	SO4730	S 5044 PE	FA5634ECO	S 6008 NE
1742032	S 5181 PE	61600	S 7549 A	SL6215	S 1940 A	SO4731	S 5026 PE	FA5635ECO	S 5044 PE
1742037	S 5181 PE	DX8082	S 7338 A	SL6216	S 3940 A	SO4742	S 5045 PE	FA5639ECO	S 5238 PE
1763776	S 4341 NR	DXF1610	S 7288 A	SL6217	S 2650 A	SO4755	S 5046 PE	FA5644ECO	S 5007 PE
1770813	S 3289 C	HY10168	S 2234 Z	SL6218/1	S 7643 A	SO4912	S 5097 PE	FA5647ECO	S 6001 NE
1774598	S 7F30 A	HY10168/2	S 2234 Z	SL6222	S 2950 A	SO4974	S 5181 PE	FA5671ECO	S 6004 NE
1780730	S 4479 NR	HY10168/3	S 2234 Z	SL6249	S 7A17 A	SO4999	S 5087 OC	FA5733ECO	S 6009 NE
1791445		HY9105	S 6449 PO	SL6250	S 0840 A	SO4999/1	S 5111 PE	FA5734ECO	S 5045 PE
(N.6 FILTRI/FILTERS)	S 3081 C	PA76116	S 3541 A	SL6260	S 7281 A	SO5242	S 5005 PE	FA5804ECO	S 5062 PE
1794863	S 6147 NE	PA7680	S 3373 A	SL6331	S 6870 A	SO5242/1	S 5036 PE	FA5809	S 6146 NE
1795459	S 4401 U	SAB540SET	S 4401 U	SL6341	S 0940 A	SO97020	S 5236 PE	FA5818ECO	S 5046 PE
1801774	S 7615 A	SBL88014SET	S 7B11 A	SL6421	S 6650 A	SO97022	S 5102 PE	FA5819ECO	S 6011 NE
1801775	S 7970 A	SK3031	S 4158 NR	SL8046	S 7406 A	SO97035	S 5239 PE	FA5820ECO	S 6010 NE
181646	S 4323 NR	SK3055	S 5394 GC	SL8048	S 7284 A	SOE520	S 7A86 A	FA5825ECO	S 5081 PE
1852188	S 4401 U	SK3063	S 6072 NE	SL8048/1	S 7645 A	SP4008	S 3257 R	FA5834	S 2234 Z
1865227	S 6147 NE	SK3134	S 2320 NR	SL8050	S 7404 A	SP4162	S 2030 R	FA5838	S 5234 PE
1869987	S 7615 A	SK3152	S 6039 NE	SL8063	S 7431 A	SP4300	S 8600 R	FA5997ECO	S 5097 PE
1869988	S 7970 A	SK3226	S 4416 NR	SL81030	S 7409 A	SP4320	S 7600 R	FA5998ECO	S 5181 PE
1869991	S 7D41 A	SK3226/2	S 4006 NR	SL81062	S 7405 A	SP4320/1	S 7600 R	FA5999ECO	S 6039 NE
1869992	S 7C13 A	SK3243-H-HNBR	S 6064 NE	SL81073	S 7558 A	SP4330	S 3241 R	FA6124ECO	S 6059 NE
1869993	S 7B36 A	SK3290	S 6008 NE	SL81077	S 7615 A	SP4350	S 9030 R	FA6126ECO	S 6062 NE
1869994	S 7C13 A	SK3290/1	S 6010 NE	SL81078	S 7345 A	SP4366	S 9610 R	FA6131ECO	S 6064 NE
1869995	S 7B36 A	SK3293	S 6009 NE	SL81082	S 7A14 A	SP4384	S 0420 R	FA6132ECO	S 6063 NE
1872151	S 7642 A	SK3297	S 2220 NR	SL81089	S 7444 A	SP4400	S 9400 R	FA6133ECO	S 5235 PE
1873014	S 5044 PE	SK3325	S 4444 NR	SL81130	S 7347 A	SP4410	S 0900 R	FA6145ECO	S 5111 PE
1873016	S 6010 NE	SK3358	S 6011 NE	SL81131	S 7559 A	SP4432	S 3003 DR	FA6572ECO	S 5026 PE
1873018	S 6008 NE	SK3425	S 4138 NR	SL81190	S 2764 A	SP4433	S 5003 DR	FA7416	S 6181 N
1907422	S 4401 U	SK3440	S 6001 NE	SL81190/1	S 7B10 A	SP4496	S 5900 PO	FA7424	S 3180 PO
1913500	S 3289 C	SK3457	S 4475 NR	SL81191	S 7626 A	SP4530	S 4120 R	FA7558ECO	S 5013 PE
1913503	S 3066 C	SK3462	S 4378 NR	SL81199	S 7625 A	SP4811	S 0620 R	FA8401A	S 3081 PO
1920628	S 6147 NE	SK3462/1	S 4378 NR	SL81205	S 7616 A	SP4920	S 3592 R	FA9400	S 0280 PO
2003505	S 6147 NE	SK3600		SL81224	S 7A15 A	ST1374	S 7259 A	FA9595ECO	S 6072 NE
2022275	S 5181 PE	(KHD)	S 5400 NR	SL81257	S 7F15 A	ST1388	S 7344 A	FB1150A	S 0122 O
2022753	S 6147 NE	SK3600		SL81258	S 7641 A	ST1390	S 7933 A	FB1277/A	S 0300 O
2022754	S 6147 NE	(ALTRE/OTHER APPL.)	S 4323 NR	SL81259	S 0768 A	ST1390/2	S 7F14 A	FB4125	S 0012 O



**CROSS REFERENCES > CORRISPONDENZE >
CORRESPONDANCES > VERGLEICHNUMMERN > CRUCE DE REFERENCIAS**

FB6152	S 7510 O	FLI6955	S 7337 A	FP6061	S 4479 NR	FT6560	S 4120 NR	4070730	S 3241 R
FB7151A	S 2510 O	FLI6960	S 7D41 A	FP6062	S 4461 NR	FT6561	S 4157 NR	407080074	S 8501 NR
FB8127	S 4000 O	FLI6961	S 7B36 A	FP6063	S 4470 NR	FT7465	S 8600 R	407080131	S 0101 N
FC1495B	S 2162 N	FLI6962	S 7C13 A	FP6310	S 4475 NR	FT7477	S 5800 R	407080132	S 7411 N
FC7102B	S 2161 N	FLI6963	S 7694 A	FP9477	S 8111 NC	FT8478	S 7112 NC	40708132391	S 7411 N
FD1513	S 4311 N	FLI6975	S 7C16 A	FPA158	S 9960 NC	FT8501A	S 3003 DR	4070874	S 8501 NR
FE1261	S 5911 N	FLI7641	S 0950 A	FT0479	S 3241 R	FT9466	S 0700 R	409070036	S 3241 R
FL0664	S 9240 A	FLI7871	S 7A09 A	FT0479B	S 5603 R	FTA053	S 3280 R	4090736	S 3241 R
FL1677	S 3330 A	FLI8645	S 0650 A	FT0484	S 2610 NR	PA0733	S 3541 A	41105190703	S 4940 A
FL2678	S 7138 A	FLI9003	S 7548 A	FT0535	S 0130 R	PA0782	S 6303 A	41185190007	S 7165 A
FL4666	S 2460 A	FLI9004	S 7549 A	FT1508	S 8501 NR	PA7267	S 3059 A	41185190010	S 4940 A
FL5657	S 2810 A	FLI9011	S 7280 A	FT2451	S 1270 R	PA7407	S 3373 A	480A470060	S 3081 PO
FL5668	S 1540 A	FLI9012	S 7405 A	FT2480		PA7412	S 5812 A	480A470748	S 3081 PO
FL6042	S 7808 A	FLI9013	S 7406 A	(KHD)	S 5400 NR	PA9722	S 3080 A	5011070580	S 3081 PO
FL6190	S 8760 A	FLI9017	S 7409 A	FT2480		PC8029	S 3089 C	540208001B01	S 1411 N
FL6897	S 7092 A	FLI9020	S 7371 A	(ALTRE/OTHER APPL.)	S 4323 NR	PC8037	S 3072 C	540208001B02	S 0201 N
FL6918	S 7091 A	FLI9021	S 7A15 A	FT3440	S 5600 R	PC8039	S 3053 C	5402080B01	S 1411 N
FL6996	S 0VGT A	FLI9022	S 7279 A	FT3465	S 7600 R	PC8105	S 3165 C	5402080B02	S 0201 N
FL7913	S 9380 A	FLI9023	S 7516 A	FT3486	S 9400 R	PC8106	S 3048 C	559001000356	S 2530 PO
FL8665	S 1506 A	FLI9025	S 7383 A	FT3488		PC8114	S 3055 C	6090783	S 0530 PO
FL9107	S 7B11 A	FLI9027	S 7615 A	(SCANIA)	S 2329 R	PC8116	S 3221 C	60960728	S 2530 PO
FL9131	S 7A86 A	FLI9028	S 7970 A	FT4498	S 5800 R	PC8118	S 3025 C	609F070060	S 2530 PO
FL9625	S 5060 A	FLI9038	S 7625 A	FT4584	S 0920 R	PC8119	S 3092 C	609F0760	S 2530 PO
FLI0649	S 8950 A	FLI9039	S 7626 A	FT4669T	S 9610 R	PC8120	S 3062 C	61000070005	S 8600 R
FLI2903	S 7679 A	FLI9041	S 7347 A	FT4670T	S 9710 R	PC8121	S 3066 C	61000070013	S 2530 PO
FLI4669	S 7940 A	FLI9042	S 7278 A	FT4713	S 0710 NR	PC8138	S 3078 C	61000070050	S 2530 PO
FLI6416	S 2450 A	FLI9043	S 7345 A	FT4737	S 0810 NR	PC8140	S 3436 C	6100705	S 8600 R
FLI6418	S 2850 A	FLI9045	S 7506 A	FT4813	S 0700 R	PC8169	S 3139 C	61100190020	S 1940 A
FLI6421	S 6650 A	FLI9046	S 7469 A	FT4859		PC8179	S 3217 C	61100190028	S 0950 A
FLI6423	S 2370 A	FLI9051	S 7619 A	(IVECO)	S 8410 AR	PC8270	S 3448 C	61200190002	S 7839 A
FLI6424	S 4370 A	FLI9057	S 7627 A	FT4878	S 0900 R	PC8272	S 3081 C	61200190027	S 0950 A
FLI6426	S 0060 A	FLI9059	S 7616 A	FT4879	S 9030 R	PC8273-6		61200190033	S 3940 A
FLI6427	S 0840 A	FLI9065	S 8502 A	FT4961	S 8110 NR	(N.6 FILTRI/FILTERS)	S 3081 C	61200190037	S 2450 A
FLI6435	S 0850 A	FLI9067	S 7637 A	FT4964	S 8020 R	PC8277	S 3451 C	61200190038	S 7839 A
FLI6446	S 0150 A	FLI9070	S 7482 A	FT4965	S 0120 R	PC8286	S 3446 C	61200190701	S 7839 A
FLI6467	S 0450 A	FLI9076	S 7F15 A	FT5074	S 3260 R	PC8289	S 3289 C	614040111	S 0300 O
FLI6471A	S 7186 A	FLI9091	S 7A16 A	FT5121	S 5003 DR	PC8316	S 3442 C	614070111	S 0300 O
FLI6491	S 2650 A	FLI9094	S 7404 A	FT5211	S 2003 DR	PC8371	S 3283 C	614070263	S 0300 O
FLI6495	S 7170 A	FLI9096	S 7576 A	FT5218	S 5802 R	PC8377	S 3279 C	61407105	S 0300 O
FLI6496	S 6550 A	FLI9097	S 7F16 A	FT5220	S 3292 R	PC9819	S 3137 C	614080739	S 1411 N
FLI6510	S 0940 A	FLI9098	S 7573 A	FT5237	S 0230 R	PCK8048	S 4225 CA	614080740	S 0201 N
FLI6513	S 7024 A	FLI9099	S 7A12 A	FT5240	S 4329 NR	PCK8177	S 4347 CA	614090739	S 1411 N
FLI6514	S 7945 A	FLI9100	S 7600 A	FT5268	S 1028 B	PCK8184	S 4177 CA	61500080043	S 8501 NR
FLI6515	S 8940 A	FLI9101	S 7563 A	FT5275	S 0999 NR	PCK8399	S 4346 CA	7101070332	S 7600 R
FLI6516	S 2840 A	FLI9105	S 7639 A	FT5315	S 7259 A	U100	S 4401 U	71201190021	S 0650 A
FLI6579	S 2070 A	FLI9106	S 7390 A	FT5317	S 5020 NR	U102	S 4402 U	7121071142	S 3241 R
FLI6587A	S 0050 A	FLI9108	S 7B45 A	FT5353	S 4378 NR			7121190021	S 0650 A
FLI6599	S 4270 A	FLI9109	S 7285 A	FT5356	S 4337 NR	SOLARIS BUS	SOFIMA	7161085060	S 7600 NR
FLI6613	S 2570 A	FLI9112	S 7284 A	FT5382	S 3409 R	0000-007-636	S 3458 C	79000190701	S 0950 A
FLI6619	S 1050 A	FLI9130	S 7B01 A	FT5390	S 3497 R	0112142450	S 4142 NR	79200361087	S 7259 A
FLI6624	S 0070 A	FLI9298	S 7650 A	FT5480	S 0420 R	0112142463	S 4142 NR	79200361090	S 7259 A
FLI6689	S 5650 A	FLI9301	S 7642 A	FT5505A	S 9600 NR	0120-302-811	S 4405 U	99000190033	S 1050 A
FLI6692	S 7356 A	FLI9302	S 7695 A	FT5527	S 4396 NR	0120302573	S 5905 PO	99000190075	S 2650 A
FLI6700	S 6870 A	FLI9303	S 2764 A	FT5574	S 3408 R	0120310085	S 5902 PO	99000190137	S 0450 A
FLI6701	S 7578 A	FLI9304	S 7A23 A	FT5579	S 3010 R	0120322535	S 4401 U	99000190702	S 2450 A
FLI6713	S 6940 A	FLI9305	S 7641 A	FT5583	S 2329 R	0170386000	S 5902 PO	99000190702	S 2650 A
FLI6765	S 8570 A	FLI9306	S 7643 A	FT5596	S 4120 R	0170386001	S 5902 PO	99012190030	S 1450 A
FLI6788	S 1450 A	FLI9307	S 7575 A	FT5598	S 4341 NR	0170445000	S 5902 PE	99012190037	S 0450 A
FLI6789	S 7129 A	FLI9308	S 7F18 A	FT5599	S 4395 NR	0190142210	S 5234 PE	99012190137	S 0450 A
FLI6799	S 7165 A	FLI9309	S 7484 A	FT5610	S 0712 NR	0499-000-469	S 4143 NR	99012190196	S 7129 A
FLI6800	S 1940 A	FLI9310	S 7649 A	FT5611	S 4471 NR	1804170086	S 7F25 A	99012190701	S 2650 A
FLI6801	S 3940 A	FLI9311	S 7A44 A	FT5612	S 2220 NR		S 3440 C	99012190705	S 0450 A
FLI6802	S 1307 A	FLI9316	S 7564 A	FT5613	S 0620 R			99014190033	S 1050 A
FLI6812	S 7974 A	FLI9317	S 7432 A	FT5651	S 7344 A	STANADYNE	SOFIMA	99112190030	S 1450 A
FLI6813	S 7168 A	FLI9318	S 7565 A	FT5655	S 9006 AR	28306	S 7111 NC	99112190705	S 0450 A
FLI6818	S 7183 A	FLI9321	S 7387 A	FT5657	S 3288 R	28307	S 8111 NC	99114190025	S 1307 A
FLI6825	S 7221 A	FLI9323	S 7F17 A	FT5658	S 9320 NR	28308	S 8500 NR		
FLI6828	S 7A34 A	FLI9324	S 7A25 A	FT5715	S 4402 R	31648	S 4475 NR	TALBOT	SOFIMA
FLI6838	S 7187 A	FLI9325	S 7A11 A	FT5801	S 5903 PO			1228022	S 5600 R
FLI6854	S 7343 A	FLI9326	S 7A03 A	FT5803	S 4473 NR	STEYR	SOFIMA	4000151830	S 1220 R
FLI6865	S 7288 A	FLI9328	S 0768 A	FT5805	S 5902 PO	162000081001	S 8111 NC	5031031	S 4380 PO
FLI6869	S 7544 A	FLI9329	S 7A14 A	FT5806	S 5903 PO	1855503	S 0101 N	5037896	S 6481 N
FLI6871	S 7213 A	FLI9330SY	S 7646 A	FT5810	S 7393 A	1855504	S 7411 N	5039456	S 7111 NC
FLI6872	S 7361 A	FLI9645	S 4940 A	FT5813	S 4461 NR	2090736	S 3241 R	5039546	S 3180 PO
FLI6895	S 1970 A	FLI9648	S 2950 A	FT5814	S 5904 PO	2177745/1	S 6710 NR	5040646	S 3180 PO
FLI6898	S 7479 A	FP1566	S 4444 NR	FT5821	S 1378 NR	2177745/1	S 4471 NR	5041315	S 1600 R
FLI6916		FP2612	S 4150 NR	FT6020	S 4510 NR	2177745/1	S 6710 NR	5042621	S 5600 R
(DAF)	S 9870 A	FP5493A		FT6039	S 4121 NR	2177745/1	S 4471 NR	5053014	S 5446 PO
FLI6916		(ALTRE/OTHER APPL.)	S 8500 NR	FT6040	S 4068 NR	2178582/1	S 6710 NR	5057957	S 1600 R
FLI6919	S 7423 A	FP5493A		FT6046	S 7A66 A	21785821	S 3241 R	5221272	S 5600 R
FLI6923	S 7214 A	(MAN)	S 4378 NR	FT6048	S 7F23 A	31100190020	S 3241 R	5221313	S 5600 R
FLI6925	S 7A17 A	FP5514	S 1410 NR	FT6049	S 7F14 A	31100190701	S 0650 A	5221372	S 5600 R
FLI6925	S 7357 A	FP5542	S 4408 NR	FT6050	S 7F24 A	380955163	S 0650 A	5221313	S 5600 R
FLI6930	S 7185 A	FP5771	S 1999 NR	FT6052	S 8137 RH	380955164	S 0101 N	6160448	S 5600 R
FLI6931	S 7358 A	FP5782	S 4142 NR	FT6477		406070049	S 7411 N	7050132	S 4080 PO
FLI6932	S 7286 A	FP5831	S 4138 NR	(SCANIA)	S 2329 R	4060718	S 4380 PO	7100092	S 4080 PO
FLI6933	S 7428 A	FP5836	S 4143 NR	FT6482	S 1270 R	4060757	S 3241 R	75061409	S 5600 R
FLI6944	S 7372 A	FP6060	S 4158 NR	FT6516	S 1013 B			75061411	S 5600 R

**CROSS REFERENCES > CORRISPONDENZE >
CORRESPONDANCES > VERGLEICHNUMMERN > CRUCE DE REFERENCIAS**

75065049	S 5600 R	23.152.02	S 5802 R	24.369.00	S 3010 N	25.536.00	S 5536 PO	27.160.00	S 7160 A
75065398	S 0300 O	23.156.00	S 0420 R	24.371.00	S 9960 NC	25.538.01	S 5381 PO	27.161.00	S 7161 A
75065702	S 0420 R	23.156.02	S 1560 R	24.375.00	S 1410 NR	25.545.00	S 9490 PO	27.165.00	S 7165 A
75221405	S 1600 R	23.156.03	S 1563 R	24.378.00	S 4378 NR	25.546.01	S 3631 PO	27.168.00	S 7168 A
75221481	S 1600 R	23.164.00	S 5601 R	24.378.01	S 1378 NR	25.549.00	S 5549 PO	27.183.00	S 7183 A
9401906028	S 9091 N	23.164.03	S 5603 R	24.391.00	S 4391 NR	25.569.00	S 5569 PO	27.185.00	S 7185 A
9456000220	S 0130 R	23.167.00	S 8310 R	24.394.00	S 4394 NR	25.595.00	S 6449 PO	27.186.00	S 7186 A
990937	S 5600 R	23.178.00	S 8020 R	24.395.00	S 4395 NR	25.613.00	S 5613 PO	27.187.00	S 7187 A
CA15136000	S 7111 NC	23.179.00	S 0120 R	24.395.01	S 1395 NR	25.663.00	S 5663 PO	27.188.00	S 7092 A
E5778M	S 5600 R	23.189.00	S 7330 R	24.396.00	S 4396 NR	25.664.00	S 5664 PO	27.189.00	S 1670 A
K10767	S 0280 PO	23.191.00	S 0130 R	24.408.00	S 4408 NR	25.900.00	S 5900 PO	27.208.00	S 6870 A
K22100	S 8381 NC	23.198.00	S 5630 R	24.416.00	S 4416 NR	25.902.00	S 5902 PO	27.209.00	S 6940 A
K23853	S 8381 NC	23.241.00	S 3241 R	24.436.00	S 2320 NR	25.903.00	S 5903 PO	27.213.00	S 7213 A
K23863	S 8381 NC	23.256.00	S 3102 R	24.444.00	S 4444 NR	25.904.00	S 5904 PO	27.214.00	S 7214 A
K24477	S 0280 PO	23.257.00	S 3257 R	24.461.00	S 4461 NR	25.905.00	S 5905 PO	27.215.00	S 5250 A
K30052	S 6380 PO	23.269.00	S 3260 R	24.470.00	S 4470 NR	26.001.00	S 6001 NE	27.217.00	S 7217 A
ZE67267000	S 8790 PO	23.275.00	S 3275 R	24.471.00	S 4471 NR	26.004.00	S 6004 NE	27.218.00	S 7218 A
		23.276.00	S 1220 R	24.472.00	S 4472 NR	26.008.00	S 6008 NE	27.221.00	S 7221 A
		23.280.00	S 3280 R	24.473.00	S 4473 NR	26.009.00	S 6009 NE	27.222.00	S 7222 A
		23.288.00	S 3288 R	24.474.00	S 4474 NR	26.010.00	S 6010 NE	27.259.00	S 7259 A
		23.290.00	S 2329 R	24.475.00	S 4475 NR	26.011.00	S 6011 NE	27.266.04	S 7266 A
		23.292.00	S 3292 R	24.476.00	S 4476 NR	26.016.00	S 6016 NE	27.276.00	S 7276 A
		23.302.00	S 2003 DR	24.477.00	S 4477 NR	26.017.00	S 6017 NE	27.277.00	S 7277 A
		23.303.00	S 3003 DR	24.478.00	S 4478 NR	26.024.00	S 6024 NE	27.278.00	S 7278 A
		23.305.00	S 5003 DR	24.479.00	S 4479 NR	26.034.00	S 6034 NE	27.279.00	S 7279 A
		23.408.00	S 3408 R	24.480.00	S 4480 NR	26.039.00	S 6039 NE	27.280.00	S 7280 A
		23.409.00	S 3409 R	24.999.00	S 0999 NR	26.043.00	S 6043 NE	27.281.00	S 7281 A
		23.425.00	S 3425 R	24.999.01	S 1999 NR	26.044.00	S 6044 NE	27.284.00	S 7284 A
		23.446.00	S 4120 R	24.H2O.01	S 1H2O NR	26.059.00	S 6059 NE	27.285.00	S 7285 A
		23.450.00	S 3010 R	25.005.00	S 5005 PE	26.062.00	S 6062 NE	27.286.00	S 7286 A
		23.469.00	S 0620 R	25.006.00	S 5006 PE	26.063.00	S 6063 NE	27.288.00	S 7288 A
		23.489.00	S 5820 R	25.007.00	S 5007 PE	26.064.00	S 6064 NE	27.299.00	S 7299 A
		23.497.00	S 3497 R	25.011.00	S 5011 PE	26.072.00	S 6072 NE	27.308.00	S 7308 A
		23.546.00	S 0920 R	25.013.00	S 5013 PE	26.080.00	S 6080 NE	27.312.00	S 7312 A
		23.572.00	S 3572 R	25.016.00	S 5016 PE	26.088.00	S 6088 NE	27.313.00	S 7313 A
		23.577.00	S 3577 R	25.026.00	S 5026 PE	26.089.00	S 6089 NE	27.314.00	S 7314 A
		23.592.00	S 3592 R	25.036.00	S 5036 PE	26.146.00	S 6146 NE	27.315.00	S 7315 A
		23.698.00	S 3698 R	25.044.00	S 5044 PE	26.147.00	S 6147 NE	27.337.00	S 7337 A
		24.006.00	S 4006 NR	25.045.00	S 5045 PE	26.148.00	S 6148 NE	27.338.00	S 7338 A
		24.010.00	S 0310 NR	25.046.00	S 5046 PE	26.150.00	S 6150 NE	27.342.00	S 7342 A
		24.021.00	S 4021 NR	25.062.00	S 5062 PE	26.601.00	S 6481 N	27.343.00	S 7343 A
		24.031.00	S 0712 NR	25.081.00	S 5081 PE	26.602.00	S 6181 N	27.344.00	S 7344 A
		24.035.01	S 4035 NR	25.095.00	S 5095 PE	26.604.00	S 6111 N	27.345.00	S 7345 A
		24.059.00	S 4059 NR	25.097.00	S 5097 PE	26.605.00	S 6911 N	27.347.00	S 7347 A
		24.064.00	S 4064 NR	25.099.00	S 5099 PE	26.606.00	S 4211 N	27.356.00	S 7356 A
		24.068.00	S 4068 NR	25.102.00	S 5102 PE	26.609.00	S 7411 N	27.357.00	S 7357 A
		24.077.00	S 4077 NR	25.111.00	S 5111 PE	26.618.00	S 6311 N	27.358.00	S 7358 A
		24.089.00	S 4089 NR	25.124.00	S 5124 PE	26.623.00	S 7200 N	27.359.00	S 7359 A
		24.107.00	S 4107 NR	25.131.00	S 5131 PE	26.645.00	S 6645 N	27.360.00	S 9870 A
		24.112.00	S 4112 NR	25.132.00	S 5132 PE	26.652.00	S 9091 N	27.361.00	S 7361 A
		24.120.00	S 4120 NR	25.133.00	S 5133 PE	27.002.00	S 7002 A	27.368.00	S 7368 A
		24.121.00	S 4121 NR	25.147.00	S 5147 PE	27.004.00	S 7004 A	27.371.00	S 7371 A
		24.138.00	S 4138 NR	25.156.00	S 5156 PE	27.005.00	S 1005 A	27.372.00	S 7372 A
		24.142.00	S 4142 NR	25.159.00	S 5159 PE	27.007.00	S 1050 A	27.383.00	S 7383 A
		24.143.00	S 4143 NR	25.169.00	S 5169 PE	27.008.00	S 7008 A	27.387.00	S 7387 A
		24.146.00	S 4146 NR	25.181.00	S 5181 PE	27.010.00	S 7010 A	27.388.00	S 7970 A
		24.149.00	S 4149 NR	25.234.00	S 5234 PE	27.011.00	S 7011 A	27.390.00	S 7390 A
		24.150.00	S 4150 NR	25.235.00	S 5235 PE	27.014.00	S 7670 A	27.393.00	S 7393 A
		24.154.00	S 4154 NR	25.236.00	S 5236 PE	27.015.00	S 8270 A	27.395.00	S 8502 A
		24.157.00	S 4157 NR	25.237.00	S 5237 PE	27.017.00	S 7017 A	27.396.00	S 1970 A
		24.158.00	S 4158 NR	25.238.00	S 5238 PE	27.022.00	S 6270 A	27.404.00	S 7404 A
		24.159.00	S 4159 NR	25.239.00	S 5239 PE	27.023.00	S 7023 A	27.405.00	S 7405 A
		24.306.00	S 0510 NR	25.240.00	S 5240 PE	27.024.00	S 7024 A	27.406.00	S 7406 A
		24.307.00	S 5400 NR	25.401.00	S 0580 PO	27.026.00	S 7026 A	27.408.00	S 7408 A
		24.308.00	S 0710 NR	25.402.01	S 3180 PO	27.028.00	S 7028 A	27.409.00	S 7409 A
		24.309.00	S 8110 NR	25.406.01	S 3081 PO	27.033.00	S 7033 A	27.421.00	S 7421 A
		24.310.00	S 4510 NR	25.407.01	S 1080 PO	27.039.00	S 7039 A	27.422.00	S 7422 A
		24.313.00	S 0810 NR	25.408.00	S 0280 PO	27.040.00	S 7040 A	27.423.00	S 7423 A
		24.314.00	S 6710 NR	25.409.01	S 4080 PO	27.041.00	S 7041 A	27.428.00	S 7428 A
		24.319.01	S 2610 NR	25.413.00	S 6180 PO	27.045.00	S 7045 A	27.431.00	S 7431 A
		24.321.00	S 9600 NR	25.421.00	S 6380 PO	27.052.00	S 8450 A	27.432.00	S 7432 A
		24.323.00	S 4323 NR	25.422.00	S 2530 PO	27.054.00	S 3940 A	27.469.00	S 7469 A
		24.329.00	S 4329 NR	25.423.00	S 7260 PO	27.055.00	S 1940 A	27.474.00	S 7474 A
		24.336.00	S 5020 NR	25.423.01	S 7261 PO	27.067.00	S 7940 A	27.479.00	S 7479 A
		24.337.00	S 4337 NR	25.427.00	S 8790 PO	27.081.00	S 1540 A	27.482.00	S 7482 A
		24.341.00	S 4341 NR	25.431.00	S 1910 PO	27.084.00	S 9240 A	27.484.00	S 7484 A
		24.342.00	S 9320 NR	25.439.00	S 6290 PO	27.091.00	S 7091 A	27.506.00	S 7506 A
		24.348.00	S 4348 NR	25.443.00	S 7380 PO	27.092.00	S 8570 A	27.507.00	S 7507 A
		24.349.00	S 2220 NR	25.446.00	S 5446 PO	27.129.00	S 7129 A	27.516.00	S 7516 A
		24.351.00	S 8500 NR	25.447.00	S 3300 PO	27.130.00	S 1307 A	27.544.00	S 7544 A
		24.351.01	S 8501 NR	25.447.01	S 3301 PO	27.138.00	S 7138 A	27.546.00	S 7546 A
		24.358.00	S 5401 NR	25.449.00	S 0530 PO	27.139.00	S 7139 A	27.548.00	S 7548 A
		24.360.00	S 7111 NC	25.451.00	S 6490 PO	27.141.00	S 2670 A	27.549.00	S 7549 A
		24.360.01	S 7112 NC	25.455.00	S 4380 PO	27.142.00	S 7142 A	27.558.00	S 7558 A
		24.361.00	S 8111 NC	25.499.00	S 2510 O	27.143.00	S 7143 A	27.559.00	S 7559 A
		24.362.00	S 8381 NC	25.505.00	S 8260 PO	27.144.00	S 7144 A	27.562.00	S 7562 A
		24.363.01	S 0610 NR	25.528.00	S 7510 O	27.148.00	S 5650 A	27.563.00	S 7563 A
		24.365.01	S 7600 NR	25.530.00	S 9080 PO	27.158.00	S 0050 A	27.564.00	S 7564 A



**CROSS REFERENCES > CORRISPONDENZE >
CORRESPONDANCES > VERGLEICHNUMMERN > CRUCE DE REFERENCIAS**

27.565.00	S 7565 A	27.991.00	S 5450 A	53.053.00	S 3053 C	CH-12238	S 7028 A	11033781	S 7129 A
27.572.00	S 7572 A	27.992.00	S 7992 A	53.054.00	S 3054 C	CH-12239	S 7992 A	11033785	S 1307 A
27.573.00	S 7573 A	27.994.00	S 4370 A	53.055.00	S 3055 C	CH-12242	S 2650 A	11033785-4	S 1307 A
27.575.00	S 7575 A	27.996.00	S 3450 A	53.056.00	S 3056 C	CH-12244	S 7170 A	11033951	S 7308 A
27.576.00	S 7576 A	27.998.00	S 7998 A	53.059.00	S 3059 C	CH-12245	S 6550 A	11033951-2	S 7308 A
27.578.00	S 7578 A	27.A03.00	S 7A03 A	53.062.00	S 3062 C	CH-12246	S 6370 A	11033996	S 7421 A
27.600.00	S 7600 A	27.A04.00	S 7A04 A	53.066.00	S 3066 C	CH-12247	S 3570 A	11033996-7	S 7421 A
27.607.00	S 7607 A	27.A09.00	S 7A09 A	53.072.00	S 3072 C	CH-12248	S 0270 A	11033997	S 7422 A
27.608.00	S 7608 A	27.A11.00	S 7A11 A	53.078.00	S 3078 C	CH-12250	S 8450 A	11033997-5	S 7422 A
27.614.00	S 7614 A	27.A12.00	S 7A12 A	53.081.00	S 3081 C	CH-12253	S 7945 A	11033998	S 7564 A
27.615.00	S 7615 A	27.A13.00	S 7A13 A	53.089.00	S 3089 C	CH-12260	S 7010 A	11033998-3	S 7564 A
27.616.00	S 7616 A	27.A14.00	S 7A14 A	53.092.00	S 3092 C	CH-12261	S 9990 A	11033999	S 7565 A
27.617.00	S 7617 A	27.A15.00	S 7A15 A	53.137.00	S 3137 C	CH-12262	S 7011 A	110339991	S 7565 A
27.619.00	S 7619 A	27.A16.00	S 7A16 A	53.139.00	S 3139 C	CH-12264	S 0050 A	11110022	S 7423 A
27.625.00	S 7625 A	27.A17.00	S 7A17 A	53.161.00	S 3161 C	CH-12265	S 7670 A	11110022-8	S 7423 A
27.626.00	S 7626 A	27.A21.00	S 7A21 A	53.165.00	S 3165 C	CH-12266	S 5450 A	11110023	S 7408 A
27.627.00	S 7627 A	27.A22.00	S 7A22 A	53.217.00	S 3217 C	CH-12267	S 3450 A	11110149	S 3940 A
27.637.00	S 7637 A	27.A23.00	S 7A23 A	53.221.00	S 3221 C	CH-12268	S 8840 A	11110151	S 1450 A
27.638.00	S 7638 A	27.A24.00	S 7A24 A	53.279.00	S 3279 C	CH-12269	S 6270 A	11110348	S 4138 NR
27.639.00	S 7639 A	27.A25.00	S 7A25 A	53.283.00	S 3283 C	CH-12270	S 8270 A	11172907	S 7091 A
27.640.00	S 2764 A	27.A26.00	S 7A26 A	53.289.00	S 3289 C	CH-12273	S 4270 A	1131838	S 7276 A
27.641.00	S 7641 A	27.A29.00	S 7A29 A	53.315.00	S 3315 C	CH-12276	S 2799 A	1131838-3	S 7276 A
27.642.00	S 7642 A	27.A34.00	S 7A34 A	53.436.00	S 3436 C	CH-12277	S 7968 A	11705110	S 7516 A
27.643.00	S 7643 A	27.A35.00	S 7A35 A	53.437.00	S 3437 C	CH-12278	S 1050 A	11708551	S 5036 PE
27.644.00	S 7644 A	27.A36.00	S 7A36 A	53.438.00	S 3438 C	CH-12282	S 4770 A	11883618	S 7356 A
27.645.00	S 7645 A	27.A44.00	S 7A44 A	53.439.00	S 3439 C	CH-12283	S 0070 A	1193281	S 2234 Z
27.646.00	S 7646 A	27.A50.00	S 7A50 A	53.440.00	S 3440 C	CH-12286	S 7017 A	1193281-1	S 2234 Z
27.649.00	S 7649 A	27.A59.00	S 7A59 A	53.441.00	S 3441 C	CH-12302	S 7338 A	11996228	S 4120 R
27.650.00	S 7650 A	27.A66.00	S 7A66 A	53.442.00	S 3442 C	CH-12385	S 2450 A	11996228-0	S 4120 R
27.651.00	S 7651 A	27.A86.00	S 7A86 A	53.443.00	S 3443 C	CH-12386	S 0950 A	1257201	S 8500 NR
27.676.00	S 9380 A	27.B01.00	S 7B01 A	53.444.00	S 3444 C	CH-12387	S 8570 A	1257201-2	S 8500 NR
27.679.00	S 7679 A	27.B10.00	S 7B10 A	53.445.00	S 3445 C	CH-12660	S 6450 A	1257492	S 5601 R
27.680.00	S 0768 A	27.B11.00	S 7B11 A	53.446.00	S 3446 C	CH-12752	S 7299 A	1257492	
27.689.00	S 7689 A	27.B36.00	S 7B36 A	53.447.00	S 3447 C	CH-12809	S 7940 A	(O/OR)	S 5603 R
27.694.00	S 7694 A	27.B39.00	S 7B39 A	53.448.00	S 3448 C	CH-12825	S 7183 A	1257492-7	S 5601 R
27.695.00	S 7695 A	27.B45.00	S 7B45 A	53.451.00	S 3451 C	CH-12826	S 7281 A	1257492-7	
27.706.00	S 0760 A	27.B80.00	S 7B80 A	53.452.00	S 3452 C	CH-12857	S 7139 A	(O/OR)	S 5603 R
27.718.00	S 8760 A	27.B81.00	S 7B81 A	53.453.00	S 3453 C	CH-12953	S 7107 A	1266286	S 3257 R
27.719.00	S 0660 A	27.C13.00	S 7C13 A	53.454.00	S 3454 C	CH-12980	S 7550 A	1266286-2	S 3257 R
27.730.00	S 5060 A	27.C16.00	S 7C16 A	53.455.00	S 3455 C	CH-13763	S 7168 A	1266388	S 3257 R
27.752.00	S 2460 A	27.D41.00	S 7D41 A	53.456.00	S 3456 C	CH-14104	S 5650 A	1318162	S 1560 R
27.789.00	S 9990 A	27.E35.00	S 7E35 A	53.457.00	S 3457 C	CH-14107	S 7187 A	1328126	S 5601 R
27.793.00	S 0150 A	27.F13.00	S 7F13 A	53.458.00	S 3458 C	CH-14888	S 7423 A	1328126	
27.794.00	S 8940 A	27.F14.00	S 7F14 A	53.459.00	S 3459 C	CH-15673	S 7217 A	(O/OR)	S 5603 R
27.802.00	S 2450 A	27.F15.00	S 7F15 A	53.460.00	S 3460 C	CH-16294	S 7421 A	1328162	S 1560 R
27.804.00	S 0950 A	27.F16.00	S 7F16 A	54.161.00	S 4161 CA	CH-16922	S 7615 A	1328162-1	S 1560 R
27.805.00	S 2650 A	27.F17.00	S 7F17 A	54.177.00	S 4177 CA	CH04-11675	S 6650 A	14213939	S 5400 NR
27.806.00	S 0450 A	27.F18.00	S 7F18 A	54.225.00	S 4225 CA	CH05-11106	S 0840 A	1542743	S 0070 A
27.808.00	S 7808 A	27.F19.00	S 7F19 A	54.260.00	S 4260 CA	CH06-11038	S 2950 A	1542743-8	S 0070 A
27.813.00	S 7813 A	27.F20.00	S 7F20 A	54.281.00	S 4281 CA	CH08-11003	S 8950 A	1544298	S 7338 A
27.820.00	S 8350 A	27.F21.00	S 7F21 A	54.314.00	S 4314 CA	CH08-11288	S 0850 A	1544298-1	S 7338 A
27.828.00	S 4940 A	27.F22.00	S 7F22 A	54.345.00	S 4345 CA	CH08-14410	S 7356 A	1544428	S 2070 A
27.838.00	S 0550 A	27.F23.00	S 7F23 A	54.346.00	S 4346 CA	CH10-11308	S 2370 A	1544428-4	S 2070 A
27.839.00	S 7839 A	27.F24.00	S 7F24 A	54.347.00	S 4347 CA	CH10-12224	S 0060 A	1544449	S 7337 A
27.857.00	S 3570 A	27.F25.00	S 7F25 A	54.348.00	S 4348 CA	CH12-11389	S 0150 A	1544449-0	S 7337 A
27.862.00	S 4450 A	27.F26.00	S 7F26 A	54.349.00	S 4349 CA	CH12-12251	S 0940 A	1584575	S 3051 A
27.863.00	S 6450 A	27.F27.00	S 7F27 A	54.350.00	S 4350 CA	CH16-12253	S 7945 A	1584575-3	S 3051 A
27.875.00	S 0270 A	27.F28.00	S 7F28 A	54.351.00	S 4351 CA	PF-15390	S 6062 NE	1586882	S 7091 A
27.877.00	S 5270 A	27.F29.00	S 7F29 A	54.352.00	S 4352 CA	PF-15672	S 3541 A	1586882-1	S 7091 A
27.878.00	S 8950 A	27.F30.00	S 7F30 A	55.394.00	S 5394 GC	SC-12252	S 7024 A	1660375	S 2070 A
27.879.00	S 7170 A	27.F31.00	S 7F31 A	55.411.01	S 1411 GC	SC-12254	S 2840 A	1660375-4	S 2070 A
27.881.00	S 0650 A	27.VGT.00	S 0VGT A	55.427.00	S 5427 GC	SC-15681	S 7218 A	1660375-5	S 2070 A
27.888.00	S 1506 A	29.001.00	S 8410 AR	65.087.00	S 5087 OC	SC-16290	S 7408 A	1660376	S 7161 A
27.889.00	S 7550 A	29.006.00	S 9006 AR	80.137.00	S 8137 RH	SC-16301	S 7422 A	1660376-3	S 7161 A
27.892.00	S 2570 A	29.007.00	S 9007 AR	86.005.00	S 8605 HP	SC10-11317	S 4370 A	1660377	S 7160 A
27.893.00	S 6550 A	30.040.00	S 3030 A			SC12-11391	S 8940 A	1660377-1	S 7160 A
27.894.00	S 2840 A	30.051.00	S 3051 A			ST-13527	S 7129 A	1660600	S 7578 A
27.902.00	S 0060 A	30.059.00	S 3059 A			ST-13528	S 1307 A	1660600-6	S 7578 A
27.920.00	S 2950 A	30.080.00	S 3080 A			ST-13529	S 1450 A	1660601	S 7549 A
27.923.00	S 2370 A	30.082.00	S 3082 A	10582248	S 7564 A	ST-13530	S 1940 A	1660601-4	S 7549 A
27.924.00	S 0840 A	30.340.00	S 3340 A	10591354	S 7A13 A	ST-13531	S 3940 A	1660619	S 0070 A
27.926.00	S 4270 A	30.373.00	S 3373 A	11064358	S 7564 A	ST08-11316	S 2850 A	1660619-6	S 0070 A
27.932.00	S 0850 A	30.394.00	S 5812 A	1147590	S 0768 A			1660619-6	S 7160 A
27.933.00	S 6650 A	30.541.00	S 3541 A	1514146	S 7A13 A			1660808	S 7A34 A
27.935.00	S 0940 A	30.630.00	S 6303 A	920920110	S 7421 A			1660903	S 7A34 A
27.944.00	S 8840 A	30.843.01	S 2810 A					1660903-4	S 7A34 A
27.945.00	S 7945 A	30.917.01	S 3330 A					1660903-5	S 7A34 A
27.949.00	S 2850 A	30.B55.00	S 3B55 A					1661808	S 7160 A
27.950.00	S 0070 A	31.013.00	S 1013 B	CH-11211	S 2070 A	1080918	S 7277 A	1661808-4	S 7160 A
27.966.00	S 2070 A	31.028.00	S 1028 B	CH-12206	S 7808 A	1080918-4	S 7277 A	1661964	S 9006 AR
27.968.00	S 7968 A	31.071.00	S 1071 B	CH-12210	S 8350 A	1080920	S 7572 A	1661964-5	S 9006 AR
27.974.00	S 7974 A	44.001.00	S 4401 U	CH-12213	S 4450 A	1080920-4	S 7572 A	1661964-7	S 9006 AR
27.977.00	S 4770 A	44.002.00	S 4402 U	CH-12230	S 0650 A	1082111	S 7091 A	1665563	S 7548 A
27.979.00	S 1450 A	44.003.00	S 4403 U	CH-12231	S 4940 A	1082111-4	S 7091 A	1665563-1	S 7548 A
27.987.00	S 7987 A	44.005.00	S 4405 U	CH-12232	S 7839 A	1082368	S 7092 A	1665563-1	S 7548 A
27.988.00	S 6370 A	44.006.00	S 4406 U	CH-12233	S 4940 A	1082368-0	S 7092 A	1665563-1	S 7548 A
27.989.00	S 1070 A	53.023.00	S 3023 C	CH-12234	S 7839 A	11007388	S 3051 A	1665886	S 7285 A
27.990.00	S 9570 A	53.048.00	S 3048 C	CH-12235	S 7987 A	11007388-9	S 3051 A	1665886-6	S 7285 A
				CH-12236	S 0450 A	11033128	S 1670 A	1665898	S 7285 A
				CH-12237	S 1070 A	11033128-7	S 1670 A	1665898-1	S 7285 A
					S 0550 A	11033777	S 1940 A	1665908	S 7278 A

**CROSS REFERENCES > CORRISPONDENZE >
CORRESPONDANCES > VERGLEICHNUMMERN > CRUCE DE REFERENCIAS**



1665908-8	S 7278 A	21758906	S 3089 C	420799-9	S 5020 NR	6640289	S 0450 A	9125224	S 8310 R
1665937	S 7576 A	21764966	S 4477 NR	423135	S 5800 R	6642047	S 3940 A	9125224-7	S 8310 R
1665937-7	S 7576 A	21764968	S 4477 NR	423135-3	S 5800 R	6643218	S 6311 N	9180596	S 8310 R
1674100	S 7576 A	21834199	S 7347 A	430143	S 5600 R	6644839	S 0950 A		
1699830	S 9006 AR	21834205	S 7A03 A	430143-8	S 5600 R	6644840	S 1940 A		
1699830-4	S 9006 AR	21834210	S 7345 A	434061	S 8501 NR	6644988	S 3940 A		
20386080	S 4461 NR	21879886	S 4120 NR	4504651	S 5600 R	6644990	S 2650 A		
20405160	S 4120 NR	22301111	S 3457 C	466176	S 0300 O	6644990-1	S 2650 A	11110683	S 4121 NR
20409908	S 4260 CA	22361133	S 3283 C	466634	S 0900 R	6645119-6	S 0150 A	11172907	S 7091 A
20411815	S 7F18 A	22739958	S 3283 C	466634-3	S 0900 R	6645833	S 3940 A	11711074	S 6710 NR
20411816	S 7F19 A	22740074	S 3457 C	466987	S 4323 NR	6648845-3	S 7111 NC	20593537	S 4121 NR
20430751	S 9320 NR	22937189	S 7F23 A	466987-5	S 4323 NR	664990	S 2650 A	21377909	S 7A23 A
20430751-0	S 9320 NR	22988765	S 4120 NR	469954	S 5800 R	6776714	S 6870 A	21377913	S 7A09 A
20450423	S 4138 NR	233239	S 1411 N	469954-2	S 5800 R	6792554	S 6870 A	21492771	S 4323 NR
20480593	S 4461 NR	233628	S 7111 NC	471392	S 4120 R	6792554-5	S 6870 A	21707132	S 4120 R
20489245	S 3089 C	23381562	S 4405 U	471392-1	S 4120 R	6888780	S 7091 A	21707133	S 4402 R
20514654	S 4461 NR	233897	S 1411 N	475081	S 6550 A	6888780-1	S 7091 A	3825133	S 4323 NR
20532237	S 9006 AR	233897-8	S 1411 N	475082	S 2840 A	7-405464	S 4000 O	3831236	S 8600 R
20541383	S 4461 NR	233898	S 7411 N	475190	S 0150 A	7-423135	S 5800 R	3841905	S 7558 A
20544738	S 7A50 A	233898-6	S 7411 N	475230	S 8450 A	7025282	S 0101 N	4720309	S 8605 HP
20557234	S 7A66 A	233988	S 7411 N	475230-9	S 8450 A	702582	S 0101 N	477556	S 4120 R
20580233	S 5664 PO	23515118	S 3454 C	475338	S 4450 A	70326723	S 3445 C	4787923	S 8605 HP
20713630	S 4401 U	23515118	S 4350 CA	475338-0	S 4450 A	70684733	S 0150 A	4787923-4	S 8605 HP
20713636	S 4401 U	23515329	S 3454 C	475339	S 6450 A	7078472	S 8381 NC	8003919	S 8605 HP
20732726	S 7643 A	23515329	S 4350 CA	475339-8	S 6450 A	7083912	S 4000 O	8159975	S 4143 NR
20732728	S 7406 A	236628	S 7111 NC	475386	S 0070 A	7233239	S 6311 N	8159975-5	S 4143 NR
20732730	S 7B10 A	236628-4	S 7111 NC	475386-9	S 0070 A	7233574	S 7411 N		
20732733	S 7645 A	241672	S 4323 NR	475388	S 0070 A	7233897	S 1411 N		
20732734	S 7404 A	241672-5	S 4323 NR	475618	S 8450 A	7233898	S 6311 N		
20745605	S 4146 NR	243004	S 4323 NR	475755	S 2070 A	7236628	S 7111 NC	4035540	S 3450 A
20746873	S 3445 C	243004-9	S 4323 NR	476769	S 4450 A	7238513	S 1411 N	4035541	S 5450 A
20754416	S 7F23 A	243009	S 4323 NR	476769-5	S 4450 A	7243004	S 4323 NR	475599	S 7011 A
20754418	S 4479 NR	243464	S 8501 NR	4771477	S 3051 A	7243004-4	S 4323 NR	475602	S 7002 A
20779040	S 5238 PE	243464-5	S 8501 NR	4771477-9	S 3051 A	7243004-9	S 4323 NR	728339	S 7011 A
20782330	S 4476 NR	243619	S 0201 N	477556	S 4120 R	731094	S 5600 R	728340	S 7011 A
20788794	S 4146 NR	243619-4	S 0201 N	477556-5	S 4120 R	73194	S 5600 R	CK-8849-1	S 9111 A
20796775	S 6039 NE	25527	S 0201 N	4780961	S 2450 A	7362224	S 2450 A	DL-6941	S 9990 A
20796785	S 5097 PE	267518-9	S 3301 PO	4785610	S 0950 A	7362224-3	S 2450 A	DL-7758	S 6940 A
20815011	S 9320 NR	3090288	S 7259 A	4785611	S 1940 A	7405434	S 4000 O	JG-3137	S 9990 A
20851191	S 4158 NR	3091200	S 7259 A	4785612	S 0950 A	7423135	S 5800 R	KC-4510	S 4105 NR
20853583	S 4158 NR	3092855	S 6449 PO	4785746	S 7129 A	74406	S 8940 A	KC-5042	S 5600 R
20876498	S 4402 U	3095859	S 5663 PO	4785748	S 0450 A	7475191-8	S 1411 N	PB-0502	S 1910 PO
20876502	S 4402 U	3162322	S 7345 A	4785749	S 1450 A	76648	S 8940 A	PB-5038	S 3301 PO
20877958	S 4406 U	3162323	S 7576 A	4785784	S 0450 A	76649	S 0201 N	RD-1118	S 9990 A
20879806	S 4157 NR	3210209	S 8111 NC	4785922-8	S 7945 A	78288	S 1411 N	RK-1030-1	S 7023 A
20879812	S 4146 NR	3210209-7	S 8111 NC	4785974	S 5800 R	783192	S 4000 O	RK-1030-2	S 7023 A
20882320	S 7F18 A	323139	S 8790 PO	4785974-9	S 5800 R	78472	S 8381 NC	RK-1092	S 6940 A
20972293	S 4120 NR	323139-6	S 8790 PO	478736	S 4402 R	78472-8	S 8381 NC	RK-1116-1	S 9990 A
20972915	S 7A66 A	3345280	S 7111 NC	478736-2	S 4402 R	78492	S 8381 NC	SP-6292	S 3301 PO
20976003	S 9320 NR	3345280-6	S 7111 NC	4789521	S 7024 A	7897321	S 6100 R	SP-6298	S 3301 PO
20998346	S 4461 NR	347138	S 7281 A	4804651	S 5600 R	79250015	S 3409 R	SV-6848	S 9990 A
20998367	S 4461 NR	347138-0	S 7281 A	480504	S 6481 N	795097	S 5600 R	TH-7307	S 9990 A
20998805	S 6039 NE	3473910	S 7111 NC	482009-8	S 7380 PO	795097-5	S 5600 R	TH-7308	S 9990 A
20998807	S 5097 PE	3473910-2	S 7111 NC	482051	S 1080 PO	795660-0	S 9610 R	TH-9177	S 7023 A
21005832	S 4476 NR	347436	S 4450 A	482051-0	S 1080 PO	80607039	S 7516 A	TL-6209	S 3301 PO
210161	S 8111 NC	347437	S 6450 A	484074	S 9400 R	807180	S 3257 R	TR-7297	S 6940 A
21041296	S 7484 A	349619	S 3081 PO	484074-0	S 9400 R	807200755	S 8790 PO	VG-6078	S 9990 A
21041297	S 7576 A	349619-7	S 3081 PO	4881174	S 5450 A	8143691	S 8790 PO	VH-3179	S 7010 A
21088101	S 4472 NR	3517857	S 3257 R	4881175-6	S 3450 A	8143691-7	S 3089 C	VJ-0075	S 7315 A
21115483	S 7A03 A	3517857-3	S 3257 R	48811756	S 3450 A	8144430	S 3089 C	VJ-0560	S 0150 A
21115501	S 7A04 A	3547862	S 8500 NR	4881323	S 7091 A	8144430-9	S 3089 C	VJ-0561	S 8940 A
21130158	S 3445 C	355994	S 4450 A	4881323-2	S 7091 A	814774	S 3089 C	VJ-1881	S 6550 A
21145173	S 4120 NR	3581078	S 7112 NC	500858	S 5270 A	8149064	S 7002 A	VJ-1882	S 0150 A
21170573	S 4120 R	3581078-7	S 7112 NC	6210359	S 5569 PO	8149961	S 7347 A	VJ-1883	S 7024 A
21192875	S 9006 AR	360224	S 8450 A	6210359-3	S 5569 PO	815127	S 7345 A	VJ-1884	S 2840 A
21243188	S 7A03 A	362264	S 8450 A	6211489	S 8600 R	8152009	S 7023 A	VJ-1885	S 8940 A
21267818	S 7F23 A	36844	S 3497 R	6211489-7	S 8600 R	8152009-0	S 7091 A	VJ-2437	S 3450 A
21333097	S 4402 U	36845	S 5400 NR	6211585	S 7111 NC	8152010	S 7091 A	VJ-3024	S 7010 A
21337443	S 7B39 A	3825133	S 4323 NR	6603379	S 0580 PO	8152010-8	S 7092 A	VJ-3255	S 7026 A
21337557	S 7B39 A	3825133-6	S 4323 NR	6603379-0	S 0580 PO	8159975	S 7092 A	VJ-3261	S 7011 A
21377915	S 7A29 A	383123-6	S 8600 R	6603399	S 0580 PO	8159975-5	S 4143 NR	VJ-3262	S 0940 A
21380403	S 4158 NR	3831236	S 8600 R	6604946	S 6311 N	817695	S 4143 NR	VJ-5139	S 5450 A
21380408	S 4158 NR	3945966	S 4143 NR	6604948	S 1411 N	8193841	S 7411 N	VJ-5175	S 7315 A
21380475	S 4157 NR	3976603-5	S 0420 R	6605860	S 7411 N	8193841-7	S 5020 NR	VJ-5176	S 7314 A
21380479	S 4157 NR	3976603-6	S 0420 R	6607485	S 0280 PO	82348995	S 5020 NR	VJ-8180	S 7945 A
21380483	S 4146 NR	39766035	S 0420 R	6607576	S 1411 N	82351184	S 3454 C	VN-4933	S 6940 A
21380488	S 4146 NR	3976655	S 8500 NR	6612069	S 3180 PO	8349409	S 4350 CA	VP-0357	S 0150 A
21380490	S 4476 NR	3976655-5	S 8500 NR	6612504	S 4450 A	838593	S 8501 NR	VS-0048	S 7945 A
21380500	S 4479 NR	3979928	S 7484 A	6612598	S 0420 R	838593-2	S 8501 NR	VS-1352	S 3450 A
21496419	S 4405 U	3989632	S 4138 NR	6612598-0	S 0420 R	83912	S 8501 NR	VS-1353	S 5450 A
21516229	S 4405 U	405434	S 4000 O	6613665	S 7111 NC	85107862	S 4000 O	VS-1764	S 7024 A
21519716	S 5664 PO	4078472	S 8381 NC	6613665-6	S 7111 NC	860874	S 3445 C	VS-1956	S 2370 A
21602385	S 7F23 A	41415	S 6380 PO	6617506	S 3301 PO	860874-7	S 8501 NR	VS-1968	S 0150 A
21602385-LH	S 7F23 A	415415	S 6380 PO	6617506-8	S 3301 PO	861475	S 8501 NR	VS-2185	S 7312 A
21707132	S 4120 R	418432	S 3257 R	6621205	S 8950 A	861475-2	S 1600 R	VS-2186	S 7313 A
21707133	S 4402 R	418432-1	S 3257 R	6621505	S 8950 A	870065	S 1600 R	VS-2198	S 7026 A
21707134	S 0900 R	418719	S 3257 R	6631320	S 7002 A	870085	S 6311 N	VS-2275	S 2950 A
21716424	S 7F18 A	420799	S 5020 NR	6635975	S 5569 PO	897321	S 6311 N	VS-2317	S 8270 A
							S 6100 R	VS-2318	S 6270 A

VOLVO PENTA SOFIMA

WABCO SOFIMA



V





OIL FILTER > FILTRI OLIO > FILTRE à HUILE > ÖLFILTER > FILTROS DE ACEITE												
SOFIMA			A	B	C	D	E	F	G	H	BAR	R
S 0012 O	O_001	731	98.0	14.0	14.0	-	-	-	-	111.0	-	-
S 0120 R	O_006	731	108.0	92.0	102.5	110.0	-	-	M 30 X 2	180.0	2.5	1
S 0122 O	O_001	731	98.0	14.0	14.0	-	-	-	-	111.0	-	-
S 0130 R	O_005	731	86.7	61.5	71.5	89.6	-	-	M 20 X 1.5	91.0	0.7	1
S 0230 R	O_006	731	108.0	62.0	72.0	110.0	-	-	1-12 UNF	230.0	2.5	1
S 0280 PO	O_001	731	69.5	33.6	33.6	-	-	-	-	142.0	-	-
S 0300 O	O_001	731	110.0	14.0	14.0	-	-	-	-	202.0	-	-
S 0420 R	O_006	731	96.0	62.0	72.0	97.0	-	-	3/4-16 UNF	174.0	0.7	1
S 0530 PO	O_001	731	99.0	31.0	31.0	-	-	-	-	195.0	-	-
S 0580 PO	O_001	731	95.0	32.5	32.5	-	-	-	-	192.0	-	-
S 0620 R	O_006	731	96.0	62.0	72.0	97.5	-	-	M 27 X 2	174.5	-	-
S 0700 R	O_006	731	108.3	61.5	71.5	110.0	-	-	3/4-16 UNF	141.0	1.2	1
S 0900 R	O_006	731	108.3	92.0	101.8	110.2	-	-	1 1/8-16 UN	261.0	-	-
S 0920 R	O_006	731	96.0	62.0	72.0	97.0	-	-	M 22 X 1.5	143.0	2.5	1
S 1080 PO	O_001	731	69.0	33.5	33.5	-	-	-	-	155.0	-	-
S 1220 R	O_006	731	108.0	92.0	102.5	110.0	-	-	1 1/8-16 UN	178.5	2.5	1
S 1270 R	O_006	731	96.0	62.0	72.0	97.0	-	-	3/4-16 UNF	96.5	1.2	1
S 1380 R	O_006	731	76.0	62.5	72.0	78.3	-	-	3/4-16 UNF	145.0	0.7	1
S 1560 R			96.5	61.5	71.5	98.3	-	-	3/4-16 UNF	175.0	2.5	1
S 1563 R	O_006	731	93.0	62.0	72.0	95.0	-	CH. 27	3/4-16 UNF	192.0	2.5	1
S 1600 R	O_006	731	96.0	62.0	72.0	97.0	-	-	3/4-16 UNF	96.5	1.2	1
S 1910 PO	O_001	731	99.0	42.0	42.0	-	-	-	-	235.0	-	-
S 2003 DR	O_006	731	108.0	53.0	59.0	110.0	-	-	M 30 X 2	262.0	2.5	1
S 2030 R	O_006	731	76.0	61.0	71.0	78.0	-	-	3/4-16 UNF	123.0	2.5	1
S 2234 Z	O_002	731	69.0	34.5	-	-	-	-	-	105.0	-	-
S 2329 R	O_005	731	96.5	61.5	71.5	98.3	-	-	3/4-16 UNF	97.0	1.6	1
S 2510 O	O_001	731	89.0	11.5	24.5	92.0	-	-	-	195.0	-	-
S 2530 PO	O_001	731	114.5	57.0	57.0	-	-	-	-	195.0	-	-
S 3003 DR	O_006	731	108.3	61.5	71.5	110.0	-	-	3/4-16 UNF	141.0	2.5	1
S 3010 R	O_006	731	136.0	101.0	111.0	140.0	-	-	M 42 X 2	308.0	2.5	-
S 3081 PO	O_001	731	58.5	18.0	18.0	-	-	-	-	101.0	-	-
S 3102 R	O_006	731	93.0	62.0	72.0	97.0	-	-	3/4-16 UNF	128.0	-	1
S 3106 R	O_006	731	91.0	62.0	72.0	93.0	-	-	1-12 UNF	211.5	1.2	1
S 3180 PO	O_001	731	69.0	21.0	21.0	-	-	-	-	115.0	-	-
S 3241 R	O_006	731	96.0	62.0	72.0	97.0	-	-	3/4-16 UNF	140.0	2.5	1
S 3257 R	O_005	731	91.0	61.5	71.5	93.3	-	-	3/4-16 UNF	81.0	1.2	1
S 3260 R	O_006	731	108.0	92.0	102.5	110.0	-	-	M 22 X 1.5	232.0	-	-
S 3275 R	O_006	731	136.0	100.0	111.0	140.0	-	-	1 1/2-16 UN	308.0	2.5	-
S 3280 R	O_005	731	93.0	77.0	88.5	95.5	-	-	M 22 X 1.5	98.5	1	1
S 3288 R	O_006	731	108.0	92.0	103.0	110.0	-	-	M 30 X 2	232.0	-	-
S 3292 R	O_006	731	108.0	92.0	102.5	110.0	-	-	M 30 X 2	180.0	2.5	-
S 3300 PO	O_001	731	114.0	36.0	36.0	-	-	-	-	233.5	-	-
S 3301 PO	O_001	731	114.0	36.0	36.0	-	-	-	-	233.5	-	-
S 3408 R	O_006	731	136.0	100.0	111.0	137.0	-	-	1 1/2-16 UN	248.0	2.5	-
S 3409 R	O_006	731	118.5	98.0	110.0	120.0	-	-	1 1/2-12 UNF	251.0	-	-
S 3425 R	O_005	731	93.0	62.5	71.5	94.5	-	-	3/4-16 UNF	111.5	2.5	1
S 3497 R	O_006	731	93.0	62.0	71.0	96.0	-	-	1-16 UN	170.0	-	-
S 3572 R	O_006	731	108.0	92.0	101.0	110.0	-	-	M 32 X 2	232.0	-	-
S 3577 R	O_006	731	120.0	98.0	114.0	122.0	-	-	1 1/2-12 UNF	120.0	1.0	-
S 3592 R	O_005	731	108.0	96.0	103.0	111.0	-	CH. 30	M 30 X 2	240.0	2.5	2
S 3698 R	O_005	731	108.0	93.0	104.0	-	-	-	1 1/8-16 UN	178.0	-	-
S 4000 O	O_001	731	110.0	14.0	14.0	-	-	-	-	125.0	-	-
S 4080 PO	O_001	731	69.0	33.5	33.5	-	-	-	-	109.0	-	-
S 4120 R	O_006	731	108.0	92.0	100.0	108.0	-	-	1 3/8-16 UN	260.5	-	-
S 4380 PO	O_001	731	95.0	33.5	33.5	-	-	-	-	116.0	-	-
S 4402 R	O_006	731	108.0	92.0	102.5	110.0	-	-	1 1/8-16 UN	262.0	-	-
S 5003 DR	O_006	731	108.0	53.0	59.0	110.0	-	-	M 30 X 2	212.0	2.5	1
S 5005 PE	O_003	731	83.0	28.5	39.0	83.5	-	-	-	214.0	-	-
S 5006 PE	O_003	731	113.0	45.0	56.0	117.0	-	-	-	312.5	-	-
S 5007 PE	O_003	731	83.0	9.3	39.0	-	-	-	-	151.7	-	-
S 5011 PE	O_003	731	65.0	20.0	20.0	-	-	-	-	154.0	-	-
S 5013 PE	O_003	731	63.5	29.0	29.0	-	-	-	-	116.0	-	-
S 5016 PE	O_003	731	120.5	49.0	49.0	-	-	-	-	145.5	-	-
S 5026 PE	O_003	731	73.0	30.5	30.5	-	-	-	-	104.0	-	-
S 5036 PE	O_003	731	83.0	28.0	39.0	83.0	-	-	-	210.0	-	-



**SIZES > DIMENSIONARIO >
DIMENSIONS > ABMESSUNGEN > DIMENSIONES**

OIL FILTER > FILTRI OLIO > FILTRE à HUILE > ÖLFILTER > FILTROS DE ACEITE												
SOFIMA			A	B	C	D	E	F	G	H	BAR	R
S 5044 PE	O_003	731	99.5	44.5	-	102.0	-	-	-	253.0	-	-
S 5045 PE	O_003	731	110.0	51.0	51.0	-	-	-	-	149.5	-	-
S 5046 PE	O_003	731	121.0	14.5	53.0	-	-	-	-	205.0	-	-
S 5062 PE	O_003	731	121.0	-	57.0	121.0	-	-	-	262.5	-	-
S 5081 PE	O_003	731	112.7	55.8	55.8	-	-	-	-	220.0	-	-
S 5087 OC	O_007	731	137.0	52.0	-	-	-	-	S 126 X 4	348.0	-	-
S 5095 PE	O_003	731	83.0	35.0	35.0	-	-	-	-	170.0	-	-
S 5097 PE	O_003	731	121.0	14.5	53.0	-	-	-	-	205.0	-	-
S 5099 PE	O_003	731	84.0	23.5	23.5	-	-	-	-	133.0	-	-
S 5102 PE	O_004	731	122.6	39.4	-	-	-	-	-	235.0	-	-
S 5111 PE	O_004	731	104.0	52.0	-	112.0	-	-	-	321.0	-	-
S 5124 PE	O_003	731	85.0	23.5	23.5	-	-	-	-	198.0	-	-
S 5131 PE	O_003	731	84.0	23.5	23.5	-	-	-	-	135.0	-	-
S 5132 PE	O_003	731	84.0	23.5	23.5	-	-	-	-	199.0	-	-
S 5133 PE	O_003	731	84.0	23.5	23.5	-	-	-	-	199.0	-	-
S 5147 PE	O_003	731	121.0	57.0	53.0	-	-	-	-	200.0	-	-
S 5156 PE	O_003	731	120.5	58.5	45.5	-	-	-	-	264.5	-	-
S 5159 PE	O_003	731	66.0	31.5	31.5	-	-	-	-	115.0	-	-
S 5169 PE	O_004	731	122.5	39.5	-	-	-	-	-	237.0	-	-
S 5181 PE	O_003	731	91.0	41.5	41.5	-	-	-	-	282.0	-	-
S 5234 PE	O_003	731	113.0	68.0	38.0	-	-	-	-	220.0	-	-
S 5235 PE	O_003	731	120.0	53.0	46.0	120.0	-	-	-	194.0	-	-
S 5236 PE	O_003	731	89.0	45.0	41.0	89.0	-	-	-	210.0	-	-
S 5237 PE	O_003	731	114.0	48.0	50.0	114.0	-	-	-	300.0	-	-
S 5239 PE	O_003	731	120.0	53.0	-	120.0	-	-	-	234.0	-	-
S 5240 PE	O_003	731	109.0	45.0	36.0	109.0	-	-	-	272.0	-	-
S 5446 PO	O_001	731	94.0	49.0	49.0	-	-	-	-	178.0	-	-
S 5536 PO	O_001	731	100.0	30.0	30.0	-	-	-	-	182.0	-	-
S 5569 PO	O_001	731	126.0	92.0	10.0	-	-	-	-	290.0	-	-
S 5600 R	O_006	731	96.5	61.5	71.5	98.3	-	-	3/4-16 UNF	141.0	1.2	1
S 5601 R	O_006	731	91.0	62.0	72.0	93.0	-	-	3/4-16 UNF	142.0	2.5	1
S 5603 R	O_005	731	93.0	62.0	72.0	95.0	-	CH. 27	3/4-16 UNF	159.0	2.5	1
S 5613 PO	O_001	731	84.0	20.0	-	-	-	-	-	107.0	-	-
S 5630 R	O_006	731	86.7	61.5	71.5	89.6	-	-	M 20 X 1.5	141.0	1.2	1
S 5663 PO	O_002	731	83.0	37.0	-	-	-	-	-	163.0	2	-
S 5700 R	O_006	731	108.3	61.5	71.5	110.0	-	-	3/4-16 UNF	97.0	1.2	1
S 5800 R	O_006	731	96.0	62.0	72.0	97.0	-	-	1-12 UNF	174.0	1.2	1
S 5802 R	O_006	731	96.0	62.0	72.0	97.0	-	-	1-12 UNF	174.0	2.5	1
S 5820 R	O_005	731	94.0	62.0	72.0	95.0	-	-	M 22 X 1.5	71.0	2.5	1
S 5900 PO	O_006	731	97.0	16.0	14.0	-	-	-	-	119.0	-	-
S 5902 PO	O_006	731	97.0	14.0	14.0	-	-	-	-	122.0	-	-
S 5903 PO	O_006	731	92.0	-	-	-	-	10	12.5	122.0	-	-
S 5904 PO			-	-	-	104.0	-	6	11	145.0	-	-
S 5905 PO			-	-	-	100.0	-	10	-	140.0	-	-
S 6100 R	O_005	731	86.7	61.5	71.5	89.6	-	-	3/4-16 UNF	73.0	0.7	1
S 6180 PO	O_001	731	69.0	33.5	33.5	-	-	-	-	85.0	-	-
S 6290 PO	O_001	731	84.0	26.0	26.0	-	-	-	-	154.0	-	-
S 6380 PO	O_001	731	94.0	33.0	33.0	-	-	-	-	99.0	-	-
S 6449 PO	O_001	731	82.0	-	30.0	-	-	-	-	152.0	2.0	-
S 6490 PO	O_001	731	82.0	27.0	27.0	-	-	-	-	135.0	-	-
S 7260 PO	O_001	731	120.0	13.8	57.0	-	-	-	-	248.0	-	-
S 7261 PO	O_001	731	120.0	13.8	57.0	-	-	-	-	248.0	-	-
S 7330 R	O_006	731	96.0	62.0	72.0	97.0	-	-	M 20 X 1.5	116.0	1.2	1
S 7380 PO	O_001	731	95.0	32.5	32.5	-	-	-	-	74.0	-	-
S 7500 R	O_006	731	76.0	63.5	71.5	77.5	-	-	3/4-16 UNF	120.0	1.0	1
S 7510 O	O_001	731	89.0	11.5	24.5	92.0	-	-	-	168.0	-	-
S 7600 R	O_006	731	96.0	62.0	72.0	97.0	-	-	1-12 UNF	140.0	2.5	1
S 8020 R	O_006	731	108.3	92.0	101.8	110.2	-	-	M 30 X 2	141.0	2.5	1
S 8137 RH	O_005	731	93.0	62.0	71.0	-	-	-	1-12 UNF	217.0	2.5	-
S 8260 PO	O_001	731	120.0	13.8	57.0	-	-	-	-	171.0	-	-
S 8310 R	O_006	731	108.3	61.5	71.5	110.0	-	-	3/4-16 UNF	113.0	2.2	1
S 8600 R	O_006	731	91.0	61.5	71.5	93.5	-	-	1-12 UNF	210.0	2.5	1
S 8790 PO	O_001	731	79.0	13.5	13.5	-	-	-	-	114.5	-	-
S 9030 R	O_006	731	108.3	92.0	101.8	110.2	-	-	1 1/8-16 UN	261.0	2.5	1
S 9080 PO	O_001	731	59.0	9.5	19.5	-	-	-	-	105.5	-	-

OIL FILTER > FILTRI OLIO > FILTRE à HUILE > ÖLFILTER > FILTROS DE ACEITE												
SOFIMA			A	B	C	D	E	F	G	H	BAR	R
S 9400 R	O_006	731	96.5	61.5	71.5	98.3	-	-	3/4-16 UNF	143.0	0.7	1
S 9490 PO	O_001	731	100.0	40.0	13.8	-	-	-	-	243.0	-	-
S 9610 R	O_006	731	108.3	61.5	71.5	110.0	-	-	3/4-16 UNF	141.0	1.2	1
S 9710 R	O_006	731	108.3	61.5	71.5	110.0	-	-	3/4-16 UNF	178.0	1.2	1
FUEL FILTER > FILTRI CARBURANTE > CARBURANT > KRAFTSTOFF > FILTROS DE COMBUSTIBLE												
S 0101 N	F_016	732	65.0	13.0	13.0	-	-	-	-	115.0	-	-
S 0201 N	F_016	732	83.0	13.5	13.5	-	-	-	-	143.0	-	-
S 0310 NR	F_005	732	93.0	62.0	71.0	-	-	-	M 24 X 1.5	144.0	-	-
S 0510 NR	F_005	732	96.0	62.0	72.0	97.0	-	-	3/4-16 UNF	140.0	-	-
S 0610 NR	F_005	732	108.0	62.0	72.0	110.0	-	-	3/4-16 UNF	113.0	-	-
S 0710 NR	F_005	732	108.3	62.0	72.0	110.0	-	-	3/4-16 UNF	178.0	-	-
S 0712 NR	F_005	732	93.0	62.0	71.0	95.0	-	-	M 18 X 1.5	146.5	-	-
S 0810 NR	F_005	732	96.0	62.0	72.0	97.0	-	-	1-14 UNS	174.0	-	-
S 0999 NR	F_005	732	96.0	62.0	72.0	97.0	-	-	M 14 X 1.5	193.5	-	-
S 1013 B	F_008	732	-	-	30.0	37.0	-	8.0	8.0	105.0	-	-
S 1028 B	F_008	732	-	-	43.0	51.0	-	8.0	8.0	108.0	-	-
S 1071 B	F_003	732	-	-	-	100.0	-	9.5	7.9	233.0	-	-
S 1378 NR	F_005	732	76.0	62.0	71.0	79.5	-	-	M 16 X 1.5	133.0	-	-
S 1395 NR	F_005	732	108.0	62.0	72.0	109.5	-	-	M 16 X 1.5	170.0	-	-
S 1410 NR	F_005	732	89.0	65.0	73.0	98.5	-	M 36 X 1.5	3/4-16 UNF	137.5	-	-
S 1411 GC	F_013	732	86.0	-	-	108.0	-	10.0	10.0	234.0	-	-
S 1411 N	F_002	732	82.0	13.8	13.8	-	-	-	-	142.0	-	-
S 1999 NR	F_005	732	96.0	62.0	72.0	97.0	-	-	M 16 X 1.5	193.5	-	-
S 1H20 NR	F_005	732	85.0	62.5	70.0	87.5	-	-	M 16 X 1.5	186.0	-	-
S 2161 N	F_016	732	65.0	13.0	13.0	-	-	-	-	114.5	-	-
S 2162 N	F_016	732	84.5	13.4	13.4	-	-	-	-	142.5	-	-
S 2163 N	F_012	732	88.0	44.0	44.0	-	-	-	-	175.0	-	-
S 2220 NR	F_005	732	96.0	62.0	72.0	97.0	-	-	M 20 X 1.5	192.5	-	-
S 2320 NR	F_003	732	86.0	-	-	92.0	-	10.0	8.0	119.0	-	-
S 2610 NR	F_005	732	81.0	61.0	71.0	-	-	-	M 14 X 1.5	92.0	-	-
S 3010 N	F_005	732	84.0	23.2	21.0	87.5	-	-	-	103.0	-	-
S 4006 NR	F_003	732	86.5	-	-	-	-	10.0	-	100.0	-	-
S 4021 NR	F_005	732	110.0	-	-	-	-	S 80 X 3	1-14 UNS	152.0	-	-
S 4035 NR	F_005	732	110.0	-	-	-	-	S 80 X 3	1-14 UNS	152.0	-	-
S 4059 NR	F_005	732	91.5	62.0	72.0	93.0	-	-	M 16 X 1.5	214.0	-	-
S 4064 NR	F_005	732	83.0	62.5	70.5	85.0	-	-	M 16 X 1.5	155.0	-	-
S 4068 NR	F_005	732	109.0	-	-	-	-	3 3/4-10 UNS	1-14 UNS	159.0	-	-
S 4077 NR	F_003	732	86.5	-	-	92.0	-	10.0	8.0	125.0	-	-
S 4089 NR	F_005	732	96.0	62.5	72.0	98.0	-	M 14 X 2	M 20 X 1.5	184.0	-	-
S 4107 NR	F_003	732	86.5	-	-	92.0	-	10.0	8.0	126.0	-	-
S 4112 NR	F_003	732	87.0	-	-	91.5	-	10.0	8.0	135.0	-	-
S 4120 NR	F_005	732	108.0	93.0	103.0	112.0	-	-	M 32 X 1.5	264.0	-	-
S 4121 NR	F_005	732	108.0	-	-	-	-	3 3/4-10 UNS	1-14 UNS	219.0	-	-
S 4138 NR	F_005	732	108.0	-	-	109.0	-	3 3/4-10 UNS	1-14 UNS	157.0	-	-
S 4142 NR	F_005	732	108.0	-	-	-	-	S 80 X 3	1-14 UNS	232.0	-	-
S 4143 NR	F_005	732	108.0	-	-	109.0	-	3 3/4-10 UNS	1-14 UNS	157.0	-	-
S 4146 NR	F_005	732	110.0	-	-	-	-	3 1/8-10 UNS	1-14 UNS	160.0	-	-
S 4149 NR	F_013	732	87.0	-	-	-	-	10.0	8.0	100.0	-	-
S 4150 NR	F_013	732	87.0	-	-	-	-	10.0	8.0	100.0	-	-
S 4154 NR	F_005	732	108.0	93.0	103.0	112.0	-	CH. 30	1-14 UNS	183.5	-	-
S 4157 NR	F_005	732	108.0	-	-	-	-	3 1/8-10 UN	1-14 UNS	130.0	-	-
S 4158 NR	F_005	732	108.0	-	-	-	-	3 3/4-10 UNS	1-14 UNS	130.0	-	-
S 4159 NR	F_005	732	109.0	-	-	-	-	3 3/4-10 UNS	1-14 UNS	219.0	-	-
S 4211 N	F_002	732	77.5	27.0	27.0	-	-	-	-	96.0	-	-
S 4311 N	F_012	732	92.0	14.0	26.0	-	-	-	-	185.5	-	-
S 4323 NR	F_005	732	76.0	62.0	72.0	79.3	-	-	M 16 X 1.5	123.0	-	-
S 4329 NR	F_005	732	76.0	61.0	71.0	78.0	-	-	M 16 X 1.5	149.0	-	-
S 4337 NR	F_005	732	93.0	62.0	71.0	-	-	-	M 16 X 1.5	144.0	-	-
S 4341 NR	F_005	732	93.0	62.0	71.0	-	-	-	M 24 X 1.5	142.0	-	-
S 4348 NR	F_005	732	108.0	91.0	101.0	110.0	-	-	M 28 X 2	232.0	-	-
S 4378 NR	F_005	732	76.0	62.0	71.0	79.5	-	-	M 16 X 1.5	148.0	-	-
S 4391 NR	F_003	732	80.0	-	-	-	-	8.1	8.1	176.5	-	-
S 4394 NR	F_005	732	84.5	62.5	70.0	87.5	-	-	M 16 X 1.5	157.0	-	-
S 4395 NR	F_005	732	108.0	62.0	72.0	109.5	-	-	M 16 X 1.5	170.0	-	-
S 4396 NR	F_005	732	93.0	62.0	71.0	-	-	-	M 16 X 1.5	212.0	-	-

FUEL FILTER > FILTRI CARBURANTE > CARBURANT > KRAFTSTOFF > FILTROS DE COMBUSTIBLE

SOFIMA		#	A	B	C	D	E	F	G	H	BAR	R
S 4408 NR	F_005	732	80.5	61.5	70.0	-	-	-	M 16 X 1.5	183.5	-	-
S 4416 NR	F_003	732	86.5	-	-	-	-	10.0	-	110.0	-	-
S 4444 NR	F_005	732	76.0	62.0	71.0	94.0	-	-	3/4-16 UNF	152.0	-	-
S 4461 NR	F_005	732	96.0	-	-	-	-	S 80 X 2.5	1-14 UNS	142.0	-	-
S 4470 NR	F_005	732	93.0	-	-	-	-	-	1-14 UNS	174.0	-	-
S 4471 NR	F_005	732	93.0	62.0	71.0	-	-	-	M 16X1.5	144.0	-	-
S 4472 NR	F_005	732	107.0	-	-	-	-	-	1-14 UNS	158.0	-	-
S 4473 NR	F_005	732	76.0	62.0	71.0	79.0	-	-	M 16 X 1.5	153.0	-	-
S 4474 NR	F_005	732	108.0	-	-	-	-	3 3/4-10 UNS	1-14 UNS	216.0	-	-
S 4475 NR	F_005	732	83.0	69.0	-	-	-	-	-	173.0	-	-
S 4476 NR	F_005	732	108.0	-	-	-	-	-	1-14 UNS	194.0	-	-
S 4477 NR	F_005	732	108.0	-	-	-	-	-	1-14 UNS-2B	128.0	-	-
S 4478 NR	F_005	732	93.0	62.0	71.0	-	-	-	1-14 UNS	245.0	-	-
S 4479 NR	F_005	732	107.0	-	-	-	-	3 3/4-10 UNS	1-14 UNS	217.0	-	-
S 4480 NR	F_005	732	93.0	63.0	72.0	-	-	-	M 20 X 1.5	190.0	-	-
S 5020 NR	F_005	732	91.0	62.0	72.0	-	-	-	M 18 X 1.5	210.0	-	-
S 5394 GC	F_013	732	93.0	-	-	98.0	-	10.0	10.0	138.0	-	-
S 5400 NR	F_005	732	76.0	62.5	72.0	79.3	-	-	M 16 X 1.5	123.0	-	-
S 5401 NR	F_005	732	80.0	62.5	70.0	85.0	-	-	M 16 X 1.5	125.0	-	-
S 5427 GC	F_013	732	80.0	-	-	89.0	-	8.1	8.1	176.5	-	-
S 5911 N	F_012	732	88.0	44.0	44.0	-	-	-	-	174.0	-	-
S 6001 NE	F_001	732	106.0	14.0	46.0	-	-	-	-	203.5	-	-
S 6004 NE	F_001	732	75.7	11.3	26.4	77.7	-	-	-	229.8	-	-
S 6008 NE	F_001	732	84.0	37.0	-	-	-	-	-	182.0	-	-
S 6009 NE	F_001	732	89.5	46.0	13.5	-	-	-	-	204.7	-	-
S 6010 NE	F_001	732	84.0	37.0	-	-	-	-	-	182.8	-	-
S 6011 NE	F_001	732	89.0	12.5	45.0	-	-	-	-	172.0	-	-
S 6016 NE	F_001	732	75.7	12.0	-	77.7	-	-	-	229.8	-	-
S 6017 NE	F_001	732	92.5	27.5	44.7	-	-	-	-	101.0	-	-
S 6024 NE	F_001	732	106.0	20.0	46.0	-	-	-	-	250.0	-	-
S 6034 NE	F_001	732	67.5	11.3	-	-	-	-	-	163.5	-	-
S 6039 NE	F_001	732	94.5	-	47.0	-	-	-	-	163.0	-	-
S 6043 NE	F_001	732	109.0	27.5	-	102.0	-	-	-	162.0	-	-
S 6044 NE	F_001	732	109.0	27.5	-	102.0	-	-	-	202.0	-	-
S 6059 NE	F_014	732	89.0	89.0	-	-	-	-	-	54.0	-	-
S 6062 NE	F_014	732	89.0	89.0	-	-	-	-	-	54.5	-	-
S 6063 NE	F_014	732	76.0	76.0	-	-	-	-	-	54.0	-	-
S 6064 NE	F_014	732	76.0	76.0	-	-	-	-	-	54.0	-	-
S 6072 NE	F_001	732	81.0	35.5	15.0	-	-	-	-	152.0	-	-
S 6080 NE	F_001	732	67.5	11.3	-	-	-	-	-	199.0	-	-
S 6088 NE	F_015	732	47.0	-	-	50.0	-	-	-	41.0	-	-
S 6089 NE	F_015	732	47.0	-	-	50.0	-	-	-	41.0	-	-
S 6146 NE	F_001	732	90.0	17.5	46.0	-	-	-	-	250.0	-	-
S 6147 NE	F_001	732	85.0	95.0	37.0	44.0	209.0	-	-	227.0	-	-
S 6148 NE	F_001	732	75.0	32.0	30.0	-	-	-	-	160.0	-	-
S 6150 NE	F_001	732	95.0	14.0	46.0	-	-	-	-	224.0	-	-
S 6181 N	F_002	732	69.0	33.5	33.5	-	-	-	-	88.5	-	-
S 6311 N	F_002	732	65.0	14.0	14.0	-	-	-	-	65.0	-	-
S 6481 N	F_002	732	71.0	21.0	21.0	-	-	-	-	84.0	-	-
S 6645 N	F_002	732	65.0	21.0	-	-	-	-	-	111.0	-	-
S 6710 NR	F_005	732	96.0	62.0	72.0	97.0	-	-	M 16 X 1.5	145.5	-	-
S 6911 N	F_002	732	82.0	-	27.5	-	-	-	-	185.0	-	-
S 7111 NC	F_005	732	84.0	19.2	17.0	88.0	-	-	-	71.5	-	-
S 7112 NC	F_005	732	84.0	19.0	36.5	88.0	-	-	-	71.0	-	-
S 7200 N	F_002	732	95.0	26.0	26.0	-	-	-	-	116.0	-	-
S 7411 N	F_002	732	62.0	13.2	14.5	-	-	-	-	113.0	-	-
S 7600 NR	F_003	732	80.0	-	-	-	-	8.0	8.0	152.5	-	-
S 8110 NR	F_005	732	91.0	62.0	72.0	93.0	-	-	M 16 X 1.5	212.0	-	-
S 8111 NC	F_005	732	84.0	19.2	17.0	88.0	-	-	-	112.5	-	-
S 8381 NC	F_002	732	84.0	19.0	19.0	-	-	-	-	72.0	-	-
S 8500 NR	F_005	732	81.0	62.5	70.0	85.0	-	-	M 16 X 1.5	152.0	-	-
S 8501 NR	F_005	732	81.0	62.5	70.0	85.0	-	-	M 16 X 1.5	152.0	-	-
S 9091 N	F_002	732	62.0	14.0	14.0	-	-	-	-	50.0	-	-
S 9320 NR	F_005	732	108.0	93.0	104.0	112.6	-	-	M 32 X 1.5	262.5	-	-
S 9600 NR	F_005	732	86.7	62.0	72.0	89.6	-	-	M 16 X 1.5	102.0	-	-

**SIZES > DIMENSIONARIO >
DIMENSIONS > ABMESSUNGEN > DIMENSIONES**

FUEL FILTER > FILTRI CARBURANTE > CARBURANT > KRAFTSTOFF > FILTROS DE COMBUSTIBLE



SOFIMA		#	A	B	C	D	E	F	G	H	BAR	R
S 9960 NC	F_005	732	84.5	80.5	89.0	-	-	-	15.5	161.0	-	-
AIR FILTER > FILTRI ARIA > AIR > LUFT > FILTROS DE AIRE												
S 0050 A	A_001	733	302.0	11.0	191.0	378.0	-	-	-	474.0	-	-
S 0060 A	A_002	733	202.0	91.0	13.5	-	254.0	-	-	266.0	-	-
S 0070 A	A_002	733	310.0	202.0	11.0	-	-	-	-	366.0	-	-
S 0150 A	A_002	733	234.0	123.0	17.0	-	-	-	-	341.0	-	-
S 0270 A	A_002	733	226.0	118.0	11.0	-	-	-	-	295.0	-	-
S 0450 A	A_002	733	242.0	132.0	10.5	-	-	-	-	494.0	-	-
S 0550 A	A_002	733	242.0	11.0	132.0	307.0	-	-	-	497.0	-	-
S 0650 A	A_002	733	126.0	65.0	9.0	-	-	-	-	294.0	-	-
S 0660 A	A_017	733	232.0	182.0	182.0	-	-	-	-	62.0	-	-
S 0760 A	A_017	733	230.0	190.0	190.0	-	-	-	-	81.0	-	-
S 0768 A	A_002	733	148.0	110.0	-	142.0	-	-	-	561.0	-	-
S 0840 A	A_002	733	103.0	63.0	17.0	-	128.0	-	-	262.0	-	-
S 0850 A	A_002	733	155.0	88.0	18.0	-	196.0	-	-	392.0	-	-
S 0940 A	A_002	733	234.5	122.5	17.0	-	296.0	-	-	254.0	-	-
S 0950 A	A_002	733	166.0	86.0	9.0	-	-	-	-	351.0	-	-
S 0VGT A	A_012	733	76.0	61.0	71.0	78.0	-	-	M 16 x 1.5	61.5	-	-
S 1005 A	A_002	733	190.0	-	98.0	264.0	-	-	-	735.0	-	-
S 1050 A	A_002	733	302.0	191.0	10.5	-	-	-	-	470.0	-	-
S 1070 A	A_002	733	210.0	11.0	103.5	251.0	-	-	-	221.0	-	-
S 1307 A	A_015	733	159.0	138.0	17.0	152.0	-	-	-	470.0	-	-
S 1450 A	A_015	733	136.0	116.0	17.0	128.0	-	-	-	475.0	-	-
S 1506 A	A_002	733	160.0	99.0	99.0	-	-	-	-	183.0	-	-
S 1540 A	A_002	733	160.0	99.0	99.0	-	-	-	-	234.0	-	-
S 1670 A	A_002	733	302.0	191.0	10.5	-	-	-	-	470.0	-	-
S 1940 A	A_015	733	90.0	70.0	17.0	82.0	-	-	-	345.0	-	-
S 1970 A	A_002	733	303.0	167.0	-	-	-	-	-	484.0	-	-
S 2070 A	A_002	733	270.0	159.0	11.0	-	-	-	-	580.0	-	-
S 2370 A	A_002	733	202.0	135.0	17.0	-	254.0	-	-	421.0	-	-
S 2450 A	A_002	733	197.0	103.0	9.0	-	-	-	-	376.0	-	-
S 2460 A	A_001	733	244.0	180.0	180.0	-	-	-	-	57.0	-	-
S 2570 A	A_002	733	234.0	123.0	18.0	-	-	-	-	417.0	-	-
S 2650 A	A_002	733	226.0	118.0	10.5	-	-	-	-	383.0	-	-
S 2670 A	A_002	733	226.0	117.0	-	-	-	-	-	363.0	-	-
S 2764 A	A_002	733	245.0	126.0	-	-	-	-	-	373.0	-	-
S 2810 A	A_017	733	295.0	210.0	210.0	-	-	-	-	86.0	-	-
S 2840 A	A_002	733	162.0	134.0	17.0	195.0	-	-	-	407.0	-	-
S 2850 A	A_002	733	85.0	75.0	17.0	106.0	-	-	-	357.0	-	-
S 2950 A	A_002	733	133.0	70.0	18.0	-	160.0	-	-	289.0	-	-
S 3030 A	A_003	733	597.0	170.0	-	55.0	-	-	-	49.0	-	-
S 3059 A	A_003	733	597.0	171.0	-	-	-	-	-	79.0	-	-
S 3080 A	A_003	733	317.0	277.0	-	-	-	-	-	70.0	-	-
S 3082 A	A_003	733	317.0	277.0	-	-	-	-	-	80.0	-	-
S 3330 A	A_017	733	244.0	186.0	-	-	-	-	-	95.0	-	-
S 3340 A	A_003	733	355.0	265.0	-	-	-	-	-	58.0	-	-
S 3373 A	A_005	733	626.0	563.0	-	-	-	-	-	78.0	-	-
S 3450 A	A_002	733	219.0	178.0	23.0	-	-	-	-	435.0	-	-
S 3541 A	A_003	733	315.0	261.0	-	-	-	-	-	60.0	-	-
S 3570 A	A_002	733	327.0	11.0	167.0	390.0	-	-	-	256.0	-	-
S 3940 A	A_015	733	108.0	88.0	17.0	99.0	-	-	-	374.0	-	-
S 3B55 A			409.0	626.0	-	-	-	-	-	133.0	-	-
S 4270 A	A_002	733	307.0	196.0	23.0	-	-	-	-	417.0	-	-
S 4370 A	A_002	733	116.0	88.0	17.0	148.0	-	-	-	398.0	-	-
S 4450 A	A_002	733	216.0	154.0	10.0	-	-	-	-	265.0	-	-
S 4770 A	A_002	733	324.0	212.0	40.0	-	-	-	-	531.0	-	-
S 4940 A	A_002	733	150.0	71.0	8.5	-	-	-	-	333.0	-	-
S 5060 A	A_002	733	160.0	114.0	-	-	-	-	-	127.0	-	-
S 5250 A	A_002	733	197.0	103.0	9.0	-	-	-	-	255.0	-	-
S 5270 A	A_002	733	226.0	11.0	117.0	276.0	-	-	-	381.0	-	-
S 5450 A	A_002	733	350.0	240.0	23.0	-	-	-	-	471.0	-	-
S 5650 A	A_002	733	174.0	88.0	17.0	-	-	-	-	365.0	-	-
S 5812 A	A_003	733	392.0	282.0	-	-	-	-	-	47.0	-	-
S 6270 A	A_002	733	264.0	153.0	23.0	-	-	-	-	373.0	-	-
S 6303 A	A_003	733	399.5	318.0	-	-	-	-	-	75.0	-	-



**SIZES > DIMENSIONARIO >
DIMENSIONS > ABMESSUNGEN > DIMENSIONES**

AIR FILTER > FILTRI ARIA > AIR > LUFT > FILTROS DE AIRE

SOFIMA		#	A	B	C	D	E	F	G	H	BAR	R
S 6370 A	A_002	733	276.0	11.0	133.0	338.0	-	-	-	255.0	-	-
S 6450 A	A_002	733	255.0	191.0	-	-	-	-	-	266.0	-	-
S 6550 A	A_002	733	281.0	171.0	17.0	-	-	-	-	417.0	-	-
S 6650 A	A_002	733	82.0	43.0	11.0	-	109.0	-	-	188.0	-	-
S 6870 A	A_002	733	187.0	14.0	116.0	207.0	-	-	-	587.0	-	-
S 6940 A	A_002	733	280.0	169.0	17.0	-	350.0	-	-	315.0	-	-
S 7002 A	A_002	733	266.0	198.0	139.5	-	-	-	-	269.5	-	-
S 7004 A	A_002	733	307.0	196.0	-	384.0	-	-	-	520.0	-	-
S 7008 A	A_002	733	317.0	231.0	-	-	-	-	-	405.0	-	-
S 7010 A	A_002	733	351.0	240.0	17.0	-	-	-	-	416.0	-	-
S 7011 A	A_002	733	264.0	153.0	17.0	-	-	-	-	238.0	-	-
S 7017 A	A_002	733	195.0	109.0	17.0	-	-	-	-	417.0	-	-
S 7023 A	A_002	733	324.0	213.0	156.0	-	-	-	-	292.0	-	-
S 7024 A	A_002	733	185.0	155.0	17.0	211.0	-	-	-	449.5	-	-
S 7026 A	A_002	733	174.0	108.0	-	-	-	-	-	229.0	-	-
S 7028 A	A_002	733	242.0	132.0	-	-	-	-	-	496.0	-	-
S 7033 A	A_002	733	291.0	207.0	-	-	-	-	-	344.0	-	-
S 7039 A	A_002	733	352.0	240.0	24.0	415.0	-	-	-	412.0	-	-
S 7040 A	A_002	733	220.0	-	178.0	305.0	-	-	-	388.0	-	-
S 7041 A	A_002	733	220.0	-	270.0	290.0	-	-	-	382.0	-	-
S 7045 A	A_002	733	138.0	72.0	-	164.0	-	-	-	301.5	-	-
S 7091 A	A_012	733	84.0	25.0	-	88.0	-	-	-	92.5	-	-
S 7092 A	A_012	733	84.0	25.0	-	88.0	-	-	-	132.0	-	-
S 7129 A	A_015	733	120.0	97.5	17.0	111.0	-	-	-	381.0	-	-
S 7138 A	A_002	733	138.0	74.0	17.0	-	-	-	-	290.0	-	-
S 7139 A	A_002	733	164.0	17.0	111.0	196.0	-	-	-	370.0	-	-
S 7142 A	A_002	733	227.0	128.0	-	-	-	-	-	304.0	-	-
S 7143 A	A_002	733	266.0	155.0	23.0	-	-	-	-	510.0	-	-
S 7144 A	A_002	733	151.0	123.0	17.0	-	-	-	-	470.0	-	-
S 7160 A	A_002	733	175.0	137.0	10.0	-	-	-	-	545.0	-	-
S 7161 A	A_002	733	270.0	178.0	10.0	-	-	-	-	580.0	-	-
S 7165 A	A_015	733	80.0	66.2	17.0	68.0	-	-	-	327.0	-	-
S 7168 A	A_002	733	324.0	212.0	10.0	-	-	-	-	475.0	-	-
S 7170 A	A_002	733	174.0	107.0	17.0	222.0	-	-	-	419.0	-	-
S 7183 A	A_002	733	243.0	132.0	10.5	-	-	-	-	299.0	-	-
S 7185 A	A_002	733	327.0	161.0	10.5	-	-	-	-	255.0	-	-
S 7186 A	A_002	733	242.0	10.5	132.0	307.5	-	-	-	503.0	-	-
S 7187 A	A_002	733	243.0	132.0	10.5	-	-	-	-	378.0	-	-
S 7213 A	A_002	733	327.0	190.5	10.5	-	-	-	-	475.5	-	-
S 7214 A	A_002	733	306.0	195.0	17.0	-	-	-	-	433.0	-	-
S 7217 A	A_002	733	307.0	195.0	23.0	-	-	-	-	622.0	-	-
S 7218 A	A_002	733	185.0	157.0	17.0	214.0	-	-	-	596.0	-	-
S 7221 A	A_002	733	306.0	195.0	17.0	-	-	-	-	518.0	-	-
S 7222 A	A_002	733	184.0	154.0	17.0	217.0	-	-	-	488.0	-	-
S 7259 A	A_012	733	136.0	100.0	111.0	140.0	-	-	M 39 X 1.5	165.6	-	-
S 7266 A	A_005	733	262.0	139.0	-	-	-	-	-	25.0	-	-
S 7276 A	A_002	733	226.0	11.0	117.0	276.0	-	-	-	393.0	-	-
S 7277 A	A_002	733	270.0	159.0	-	300.0	-	-	-	597.0	-	-
S 7278 A	A_002	733	356.0	-	207.0	376.0	-	-	-	417.0	-	-
S 7279 A	A_002	733	420.0	254.0	10.5	-	-	-	-	316.0	-	-
S 7280 A	A_002	733	420.0	254.0	10.5	-	-	-	-	261.0	-	-
S 7281 A	A_002	733	213.0	8.5	105.0	235.0	-	-	-	294.0	-	-
S 7284 A	A_002	733	310.0	180.0	-	-	-	-	-	556.0	-	-
S 7285 A	A_002	733	332.0	-	202.0	352.0	-	-	-	418.0	-	-
S 7286 A	A_002	733	303.0	167.0	-	-	-	-	-	446.0	-	-
S 7288 A	A_015	733	158.0	138.0	17.0	151.0	-	-	-	375.0	-	-
S 7299 A	A_002	733	234.0	17.0	17.0	-	-	-	-	289.0	-	-
S 7308 A	A_002	733	260.0	229.0	23.0	-	-	-	-	572.0	-	-
S 7312 A	A_002	733	276.0	207.0	23.0	-	-	-	-	562.0	-	-
S 7313 A	A_002	733	448.0	280.0	23.0	-	-	-	-	601.0	-	-
S 7314 A	A_002	733	302.0	260.0	23.0	-	-	-	-	573.0	-	-
S 7315 A	A_002	733	448.0	310.0	23.0	-	-	-	-	601.0	-	-
S 7337 A	A_002	733	350.0	210.0	11.0	-	-	-	-	368.0	-	-
S 7338 A	A_002	733	200.0	166.0	11.0	-	-	-	-	320.0	-	-
S 7342 A	A_002	733	162.0	134.0	17.0	193.0	-	-	-	374.0	-	-



AIR FILTER > FILTRI ARIA > AIR > LUFT > FILTROS DE AIRE												
SOFIMA			A	B	C	D	E	F	G	H	BAR	R
S 7343 A	A_002	733	307.0	196.0	17.0	-	-	-	-	396.0	-	-
S 7344 A	A_012	733	136.0	100.0	111.0	140.0	-	-	1 1/4 BSP	182.0	-	-
S 7345 A	A_002	733	332.0	202.0	-	-	-	-	-	410.0	-	-
S 7347 A	A_002	733	303.0	150.0	-	-	-	-	-	410.0	-	-
S 7356 A	A_002	733	164.5	91.0	-	-	-	-	-	353.5	-	-
S 7357 A	A_001	733	313.0	178.0	-	-	-	-	-	465.0	-	-
S 7358 A	A_001	733	303.7	168.6	-	-	-	-	-	527.3	-	-
S 7359 A	A_002	733	307.0	196.0	17.0	-	-	-	-	398.0	-	-
S 7361 A	A_002	733	327.0	216.0	10.5	-	-	-	-	619.0	-	-
S 7368 A	A_002	733	307.0	196.0	17.0	-	-	-	-	424.0	-	-
S 7371 A	A_002	733	279.0	149.0	-	-	-	-	-	507.0	-	-
S 7372 A	A_002	733	281.0	171.0	17.0	-	-	-	-	389.0	-	-
S 7383 A	A_002	733	281.5	127.0	-	346.0	-	-	-	353.0	-	-
S 7387 A	A_002	733	307.0	178.0	-	-	-	-	-	443.0	-	-
S 7390 A	A_015	733	211.0	194.0	17.0	200.0	-	-	-	461.0	-	-
S 7393 A	A_012	733	136.0	100.0	111.0	140.0	-	-	M 41 X 1.5	133.6	-	-
S 7404 A	A_002	733	178.0	147.0	-	172.0	-	-	-	534.0	-	-
S 7405 A	A_002	733	170.0	128.0	-	166.0	-	-	-	450.0	-	-
S 7406 A	A_002	733	178.0	145.0	-	172.0	-	-	-	440.0	-	-
S 7408 A	A_002	733	148.0	110.0	-	142.0	-	-	-	500.0	-	-
S 7409 A	A_002	733	279.0	149.0	-	-	-	-	-	478.0	-	-
S 7421 A	A_001	733	310.0	180.0	-	308.0	-	-	-	524.0	-	-
S 7422 A	A_001	733	178.0	145.0	-	172.0	-	-	-	495.0	-	-
S 7423 A	A_002	733	279.0	149.0	-	279.0	-	-	-	519.0	-	-
S 7428 A	A_002	733	245.0	128.0	-	-	-	-	M 8 X 1.25	416.0	-	-
S 7431 A	A_002	733	302.0	191.0	10.5	-	-	-	-	341.0	-	-
S 7432 A	A_015	733	159.0	144.0	17.0	152.0	-	-	-	333.0	-	-
S 7469 A	A_002	733	281.0	-	128.0	347.0	-	-	-	415.0	-	-
S 7474 A	A_002	733	180.0	151.0	16.0	188.0	-	-	-	452.0	-	-
S 7479 A	A_002	733	200.0	134.0	17.0	-	254.0	-	-	331.0	-	-
S 7482 A	A_015	733	141.0	125.0	17.0	128.0	-	-	-	359.0	-	-
S 7484 A	A_015	733	168.0	-	-	144.0	-	-	-	440.0	-	-
S 7506 A	A_002	733	193.0	116.0	-	-	-	-	-	398.0	-	-
S 7507 A	A_015	733	104.0	90.0	-	-	-	-	-	380.0	-	-
S 7516 A	A_002	733	157.0	95.0	-	-	-	-	-	373.0	-	-
S 7544 A	A_002	733	327.0	215.7	10.5	-	-	-	-	514.0	-	-
S 7546 A	A_002	733	302.0	190.5	10.5	-	-	-	-	475.0	-	-
S 7548 A	A_002	733	258.0	161.0	-	-	-	-	-	548.0	-	-
S 7549 A	A_002	733	153.0	124.0	14.0	161.0	-	-	-	517.0	-	-
S 7550 A	A_002	733	164.0	9.0	86.0	200.0	-	-	-	352.0	-	-
S 7558 A	A_001	733	299.0	202.0	-	-	-	-	-	594.0	-	-
S 7559 A	A_015	733	194.0	172.0	-	-	-	-	-	575.0	-	-
S 7562 A	A_002	733	327.0	215.7	10.5	-	-	-	-	620.0	-	-
S 7563 A	A_002	733	327.0	215.7	10.5	-	-	-	-	482.0	-	-
S 7564 A	A_001	733	310.0	177.0	-	-	-	-	-	582.0	-	-
S 7565 A	A_001	733	178.0	145.0	-	172.0	-	-	-	566.0	-	-
S 7572 A	A_015	733	172.0	137.0	10.0	147.0	-	-	-	578.0	-	-
S 7573 A	A_001	733	265.0	170.0	-	-	-	-	-	478.0	-	-
S 7575 A	A_002	733	301.0	170.0	-	-	-	-	-	332.0	-	-
S 7576 A	A_015	733	202.0	168.0	-	-	-	-	-	447.0	-	-
S 7578 A	A_002	733	258.0	161.0	10.0	-	-	-	-	544.0	-	-
S 7600 A	A_001	733	312.5	216.5	-	-	-	-	-	461.0	-	-
S 7607 A	A_002	733	146.0	-	135.0	220.0	-	-	-	407.0	-	-
S 7608 A	A_002	733	301.0	170.0	-	-	-	-	-	470.0	-	-
S 7614 A	A_002	733	221.0	12.0	121.0	300.0	-	-	-	371.0	-	-
S 7615 A	A_002	733	310.0	180.0	-	-	-	-	-	524.0	-	-
S 7616 A	A_015	733	137.0	-	-	155.5	-	-	-	456.5	-	-
S 7617 A	A_002	733	279.0	149.0	-	-	-	-	-	378.0	-	-
S 7619 A	A_001	733	267.0	170.0	-	-	-	-	-	510.0	-	-
S 7625 A	A_001	733	246.0	150.0	-	-	-	-	-	334.0	-	-
S 7626 A	A_001	733	247.0	150.0	-	-	-	-	-	415.0	-	-
S 7627 A	A_001	733	232.0	150.0	-	-	-	-	-	415.0	-	-
S 7637 A	A_001	733	266.0	170.0	-	-	-	-	-	531.0	-	-
S 7638 A	A_002	733	236.0	-	104.0	257.0	-	-	-	297.0	-	-
S 7639 A	A_002	733	406.0	219.0	-	517.0	-	-	-	332.0	-	-



AIR FILTER > FILTRI ARIA > AIR > LUFT > FILTROS DE AIRE

SOFIMA		#	A	B	C	D	E	F	G	H	BAR	R
S 7641 A	A_002	733	279.0	149.0	-	-	-	-	-	583.0	-	-
S 7642 A	A_002	733	303.0	184.0	-	321.0	-	-	-	443.5	-	-
S 7643 A	A_002	733	310.0	180.0	-	-	-	-	-	462.0	-	-
S 7644 A	A_001	733	281.0	199.0	-	-	-	-	-	564.0	-	-
S 7645 A	A_002	733	310.0	180.0	-	-	-	-	-	556.0	-	-
S 7646 A	A_015	733	167.0	-	-	180.0	-	-	-	538.0	-	-
S 7649 A	A_015	733	136.0	-	-	156.0	-	-	-	509.0	-	-
S 7650 A	A_001	733	247.0	160.0	-	-	-	-	-	389.0	-	-
S 7651 A	A_001	733	245.0	120.0	-	-	-	-	-	501.0	-	-
S 7670 A	A_015	733	119.5	92.0	19.0	104.0	-	-	-	383.0	-	-
S 7679 A	A_002	733	148.0	73.0	-	-	-	-	-	334.0	-	-
S 7689 A	A_013	733	91.7	36.5	43.5	-	-	-	-	30.0	-	-
S 7694 A	A_002	733	210.0	131.0	-	-	-	-	-	360.0	-	-
S 7695 A	A_002	733	185.0	112.0	-	-	-	-	-	356.0	-	-
S 7808 A	A_002	733	139.0	81.0	81.0	-	-	-	-	120.0	-	-
S 7813 A	A_002	733	211.0	146.0	146.0	-	-	-	-	165.0	-	-
S 7839 A	A_002	733	197.0	9.0	103.0	247.0	-	-	-	377.0	-	-
S 7940 A	A_002	733	150.0	71.0	10.5	-	-	-	-	308.0	-	-
S 7945 A	A_002	733	307.0	196.0	17.0	-	-	-	-	469.0	-	-
S 7968 A	A_002	733	264.5	161.0	-	-	-	-	-	417.0	-	-
S 7970 A	A_002	733	307.0	178.0	-	-	-	-	-	460.0	-	-
S 7974 A	A_002	733	181.5	106.0	8.5	234.0	-	-	-	335.0	-	-
S 7987 A	A_002	733	226.0	116.5	-	-	-	-	-	384.0	-	-
S 7992 A	A_002	733	242.0	132.0	-	-	-	-	-	228.0	-	-
S 7998 A	A_002	733	265.0	13.0	133.0	332.0	-	-	-	229.0	-	-
S 7A03 A	A_001	733	331.0	212.0	-	-	-	-	-	414.0	-	-
S 7A04 A	A_015	733	182.0	-	-	194.0	-	-	-	386.5	-	-
S 7A09 A	A_001	733	231.0	152.0	-	-	-	-	-	426.0	-	-
S 7A11 A	A_001	733	250.0	170.0	-	-	-	-	-	534.0	-	-
S 7A12 A	A_001	733	265.0	170.0	-	-	-	-	-	531.0	-	-
S 7A13 A	A_002	733	310.0	177.0	-	310.0	-	-	-	584.0	-	-
S 7A14 A	A_002	733	100.0	68.0	68.0	-	-	-	-	79.0	-	-
S 7A15 A	A_001	733	245.0	125.0	-	-	-	-	-	442.0	-	-
S 7A16 A	A_001	733	265.0	170.0	-	-	-	-	-	418.0	-	-
S 7A17 A	A_002	733	205.0	108.0	-	205.0	-	-	-	529.0	-	-
S 7A21 A	A_001	733	297.0	200.0	-	-	-	-	-	563.0	-	-
S 7A22 A	A_002	733	298.0	12.0	132.5	374.0	-	-	-	417.0	-	-
S 7A23 A	A_001	733	250.0	170.0	-	-	-	-	-	481.0	-	-
S 7A24 A	A_002	733	298.0	12.0	190.0	374.0	-	-	-	417.0	-	-
S 7A25 A	A_002	733	301.0	170.0	-	301.0	-	-	-	447.0	-	-
S 7A26 A	A_002	733	301.0	170.0	-	-	-	-	-	527.0	-	-
S 7A29 A	A_001	733	245.0	150.0	-	-	-	-	-	465.0	-	-
S 7A34 A	A_002	733	200.0	166.0	10.0	200.0	-	-	-	322.0	-	-
S 7A35 A	A_002	733	356.0	230.0	-	-	-	-	-	462.0	-	-
S 7A36 A	A_002	733	229.0	170.0	-	-	-	-	-	447.0	-	-
S 7A44 A	A_002	733	165.0	134.0	-	162.0	-	-	-	502.0	-	-
S 7A50 A	A_001	733	265.0	170.0	-	-	-	-	-	531.0	-	-
S 7A59 A	A_002	733	279.0	149.0	-	-	-	-	-	507.0	-	-
S 7A66 A	A_012	733	135.0	99.0	111.0	139.0	-	-	M 39 X 1.5	165.0	-	-
S 7A86 A	A_012	733	76.0	62.0	70.0	77.0	-	-	M 16 X 1.5	122.0	-	-
S 7B01 A	A_002	733	255.0	129.5	-	-	-	-	-	458.0	-	-
S 7B10 A	A_001	733	245.0	126.0	-	-	-	-	-	373.0	-	-
S 7B11 A	A_016	733	83.5	-	-	53.5	-	-	-	74.0	-	-
S 7B36 A	A_001	733	303.0	169.0	-	-	-	-	-	454.0	-	-
S 7B39 A	A_001	733	323.0	194.0	-	307.0	-	-	-	422.0	-	-
S 7B45 A	A_001	733	261.0	-	149.0	-	-	-	-	507.0	-	-
S 7B80 A	A_002	733	324.0	23.0	212.0	342.0	-	-	-	507.0	-	-
S 7B81 A	A_002	733	210.0	181.0	23.0	210.0	-	-	-	458.0	-	-
S 7C13 A	A_001	733	303.0	169.0	-	-	-	-	-	535.0	-	-
S 7C16 A	A_001	733	318.0	197.0	-	-	-	-	-	401.0	-	-
S 7D41 A	A_002	733	165.0	134.0	-	162.0	-	-	-	396.0	-	-
S 7E35 A	A_001	733	267.0	170.0	-	-	-	-	-	510.0	-	-
S 7F13 A	A_001	733	274.0	127.0	-	-	-	-	-	347.0	-	-
S 7F14 A	A_012	733	136.0	100.0	111.0	140.0	-	-	M 41 X 1.5	165.0	-	-
S 7F15 A	A_001	733	214.0	124.0	-	-	-	-	-	339.0	-	-

**SIZES > DIMENSIONARIO >
DIMENSIONS > ABMESSUNGEN > DIMENSIONES**

AIR FILTER > FILTRI ARIA > AIR > LUFT > FILTROS DE AIRE												
SOFIMA			A	B	C	D	E	F	G	H	BAR	R
S 7F16 A	A_001	733	232.0	150.0	-	-	-	-	-	415.0	-	-
S 7F17 A	A_001	733	227.0	131.0	-	-	-	-	-	305.0	-	-
S 7F18 A	A_001	733	329.0	233.0	-	-	-	-	-	496.0	-	-
S 7F19 A	A_015	733	217.0	-	-	214.0	-	-	-	471.0	-	-
S 7F20 A			485.0	-	-	156.0	-	-	-	210.0	-	-
S 7F21 A			491.0	209.0	-	-	-	-	-	263.0	-	-
S 7F22 A			491.0	209.0	-	-	-	-	-	198.0	-	-
S 7F23 A	A_012	733	136.0	100.0	111.0	-	-	-	M 39X1.5	165.0	-	-
S 7F24 A	A_012	733	136.0	100.0	111.0	-	-	-	M 42X1.5	177.0	-	-
S 7F25 A	A_001	733	248.0	150.0	-	-	-	-	-	415.0	-	-
S 7F26 A	A_001	733	246.0	165.0	-	-	-	-	-	512.0	-	-
S 7F27 A	A_001	733	267.0	170.0	-	-	-	-	-	499.0	-	-
S 7F28 A	A_015	733	137.0	-	-	146.0	-	-	-	476.0	-	-
S 7F29 A	A_001	733	267.0	170.0	-	-	-	-	-	499.0	-	-
S 7F30 A	A_012	733	136.0	100.0	111.0	-	-	-	G 1 1/4	178.0	-	-
S 7F31 A	A_001	733	186.0	106.0	-	-	-	-	-	358.0	-	-
S 8270 A	A_002	733	152.0	122.0	22.0	-	-	-	-	313.0	-	-
S 8350 A	A_002	733	281.0	171.0	-	-	-	-	-	419.0	-	-
S 8450 A	A_002	733	333.0	206.5	-	333.0	-	-	-	225.0	-	-
S 8502 A	A_002	733	249.0	119.0	-	-	-	-	-	381.0	-	-
S 8570 A	A_002	733	302.0	191.0	10.5	-	-	-	-	366.0	-	-
S 8760 A	A_002	733	230.0	190.0	190.0	-	-	-	-	102.0	-	-
S 8840 A	A_002	733	264.0	153.0	42.0	-	-	-	-	576.0	-	-
S 8940 A	A_002	733	116.0	88.0	17.0	148.0	-	-	-	331.0	-	-
S 8950 A	A_002	733	155.0	88.0	18.0	-	196.0	-	-	315.0	-	-
S 9240 A	A_002	733	127.0	86.0	86.0	-	-	-	-	310.0	-	-
S 9380 A	A_001	733	175.0	97.0	-	-	-	-	-	183.0	-	-
S 9570 A	A_002	733	327.0	167.0	11.0	388.0	-	-	-	356.0	-	-
S 9870 A	A_002	733	279.0	147.0	-	-	-	-	-	524.0	-	-
S 9990 A	A_002	733	350.0	240.0	14.0	-	-	-	-	366.0	-	-
CABIN AIR FILTER > FILTRI ARIA ABITACOLO > D' HABITACLE > INNENRAUMFILTER > FILTROS DE HABITACULO												
S 3023 C	C_003	734	290.0	160.0	-	-	-	-	-	30.0	-	-
S 3048 C	C_003	734	365.0	157.0	-	-	-	-	-	40.0	-	-
S 3051 A	C_003	734	269.0	188.0	-	-	-	-	-	44.0	-	-
S 3053 C	C_003	734	400.0	180.0	-	-	-	-	-	40.0	-	-
S 3054 C	C_003	734	579.0	163.0	-	-	-	-	-	38.0	-	-
S 3055 C	C_004	734	440.0	100.0	-	-	-	-	-	37.0	-	-
S 3056 C	C_003	734	337.0	178.0	-	-	-	-	-	26.0	-	-
S 3059 C	C_004	734	377.0	165.0	-	-	-	-	-	27.5	-	-
S 3062 C	C_003	734	323.0	235.0	-	-	-	-	-	20.0	-	-
S 3066 C	C_004	734	223.0	165.0	-	-	-	-	-	68.0	-	-
S 3072 C	C_003	734	379.0	135.0	-	-	-	-	-	40.0	-	-
S 3078 C	C_003	734	449.0	205.5	-	-	-	-	-	26.0	-	-
S 3081 C	C_003	734	454.0	151.0	-	-	-	-	-	12.0	-	-
S 3089 C	C_003	734	210.0	210.0	-	-	-	-	-	47.0	-	-
S 3092 C	C_003	734	425.0	167.0	-	-	-	-	-	25.0	-	-
S 3137 C	C_003	734	365.0	246.0	-	-	-	-	-	35.0	-	-
S 3139 C	C_004	734	262.0	166.0	-	-	-	-	-	40.0	-	-
S 3161 C	C_003	734	293.0	192.0	-	-	-	-	-	30.0	-	-
S 3165 C	C_003	734	462.0	179.0	-	-	-	-	-	70.0	-	-
S 3217 C	C_006	734	230.0	105.0	-	-	-	-	-	20.0	-	-
S 3221 C	C_003	734	390.0	140.0	-	-	-	-	-	40.0	-	-
S 3279 C	C_003	734	391.0	146.0	-	-	-	-	-	35.0	-	-
S 3283 C	C_003	734	455.0	153.0	-	-	-	-	-	30.0	-	-
S 3289 C	C_004	734	375.0	135.0	-	-	-	-	-	20.0	-	-
S 3315 C	C_003	734	215.0	215.0	-	-	-	-	-	30.0	-	-
S 3436 C	C_004	734	450.0	193.0	-	-	-	-	-	56.0	-	-
S 3437 C	C_004	734	583.0	170.0	-	-	-	-	-	47.0	-	-
S 3438 C	C_004	734	451.0	193.0	-	-	-	-	-	56.0	-	-
S 3439 C	C_003	734	460.0	237.0	-	-	-	-	-	30.0	-	-
S 3440 C	C_003	734	460.0	237.0	-	-	-	-	-	30.0	-	-
S 3441 C	C_003	734	528.0	222.0	-	-	-	-	-	46.0	-	-
S 3442 C	C_003	734	341.0	137.0	-	-	-	-	-	36.0	-	-
S 3443 C	C_003	734	494.0	226.0	-	-	-	-	-	44.0	-	-
S 3444 C	C_003	734	492.0	153.0	-	-	-	-	-	30.0	-	-



**SIZES > DIMENSIONARIO >
DIMENSIONS > ABMESSUNGEN > DIMENSIONES**

CABIN AIR FILTER > FILTRI ARIA ABITACOLO > D' HABITACLE > INNENRAUMFILTER > FILTROS DE HABITACULO

SOFIMA		#	A	B	C	D	E	F	G	H	BAR	R
S 3445 C	C_003	734	422.0	194.0	-	-	-	-	-	30.0	-	-
S 3446 C	C_003	734	390.0	150.0	-	-	-	-	-	20.0	-	-
S 3447 C	C_003	734	492.0	151.0	-	-	-	-	-	13.0	-	-
S 3448 C	C_003	734	220.0	149.0	-	-	-	-	-	20.0	-	-
S 3451 C	C_003	734	500.0	230.0	-	-	-	-	-	50.0	-	-
S 3452 C	C_006	734	229.0	160.0	-	-	-	-	-	10.0	-	-
S 3453 C	C_004	734	312.0	226.0	-	-	-	-	-	37.0	-	-
S 3454 C	C_003	734	302.0	203.0	-	-	-	-	-	32.0	-	-
S 3455 C	C_003	734	275.0	195.0	-	-	-	-	-	22.0	-	-
S 3456 C	C_003	734	905.0	211.0	-	-	-	-	-	21.0	-	-
S 3457 C	C_003	734	497.0	173.0	-	-	-	-	-	30.0	-	-
S 3458 C	C_003	734	519.0	143.0	-	-	-	-	-	35.0	-	-
S 3459 C	C_004	734	312.0	226.0	-	-	-	-	-	37.0	-	-
S 3460 C	C_006	734	211.0	92.0	-	-	-	-	-	15.0	-	-
S 4161 CA	C_001	734	365.0	246.0	-	-	-	-	-	35.0	-	-
S 4177 CA	C_001	734	462.0	179.0	-	-	-	-	-	70.0	-	-
S 4225 CA	C_001	734	378.0	131.0	-	-	-	-	-	40.0	-	-
S 4260 CA	C_001	734	211.0	211.0	-	-	-	-	-	49.5	-	-
S 4281 CA	C_001	734	378.0	165.0	-	-	-	-	-	25.0	-	-
S 4314 CA	C_001	734	256.0	222.0	-	-	-	-	-	30.0	-	-
S 4345 CA	C_002	734	451.0	193.0	-	-	-	-	-	56.0	-	-
S 4346 CA	C_001	734	449.0	206.0	-	-	-	-	-	25.0	-	-
S 4347 CA	C_002	734	261.0	162.0	-	-	-	-	-	45.0	-	-
S 4348 CA	C_001	734	291.0	192.0	-	-	-	-	-	30.0	-	-
S 4349 CA	C_002	734	312.0	226.0	-	-	-	-	-	37.0	-	-
S 4350 CA	C_001	734	302.0	203.0	-	-	-	-	-	32.0	-	-
S 4351 CA	C_002	734	261.0	168.0	-	-	-	-	-	54.0	-	-
S 4352 CA	C_002	734	341.0	244.0	-	-	-	-	-	42.0	-	-

WATER FILTER > FILTRI ACQUA > FILTRE A EAU > WASSERFILTER > FILTROS DE AGUA

S 8410 AR	W_001	734	91.0	62.0	72.0	93.0	-	-	11/16-16 UN	141.5	-	-
S 9006 AR	W_001	734	91.0	62.0	70.0	93.5	-	-	M 16 X 1.5	142.0	-	-
S 9007 AR	W_001	734	93.5	62.0	72.0	97.0	-	-	11/16-16 UN	104.0	-	-

OTHER FILTERS > FILTRI DI SERVIZIO > FILTRES SPECIAUX > SONSTIGEN FILTER > FILTROS ESPECIALES

S 4401 U	S_001	735	67.0	-	25.0	69.0	-	-	-	75.0	-	-
S 4402 U	S_001	735	66.0	-	23.0	66.0	-	-	-	99.0	-	-
S 4403 U	S_001	735	67.0	-	33.0	70.0	-	-	-	76.0	-	-
S 4405 U	S_001	735	45.0	21.0	24.0	48.0	-	-	-	93.0	-	-
S 4406 U			4.0	7.0	-	-	-	-	-	30.0	-	-
S 5238 PE	O_003	731	64.0	31.0	31.0	-	-	-	-	150.0	-	-
S 5664 PO	O_001	731	60.0	18.0	18.0	-	-	-	-	150.0	-	-
S 8605 HP	S_002	735	93.0	63.0	71.0	95.5	-	-	1-12 UNF	215.0	2.5	-



O_001



O_002



O_003



O_004



O_005

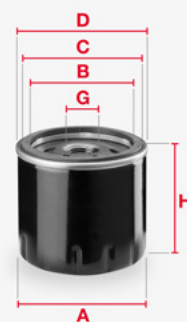

O_006



O_007





F_001



F_002



F_003



F_005



F_008



F_012



F_013

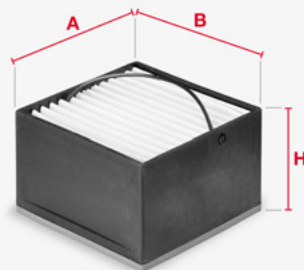

F_014



F_015



F_016

AIR FILTER > FILTRI ARIA > AIR > LUFT > FILTROS DE AIRE



A_001



A_002

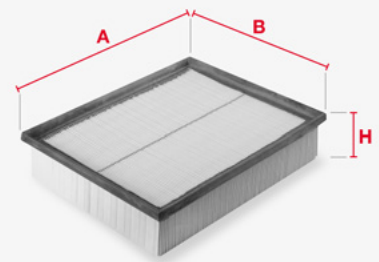

A_003

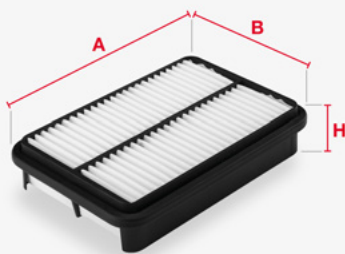

A_005



A_012

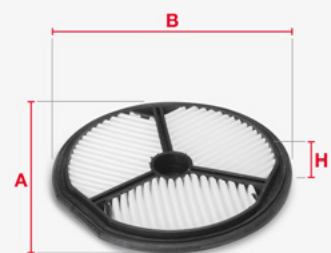

A_013



A_015

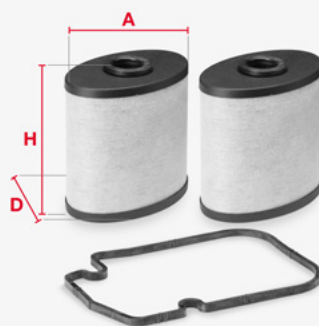

A_016

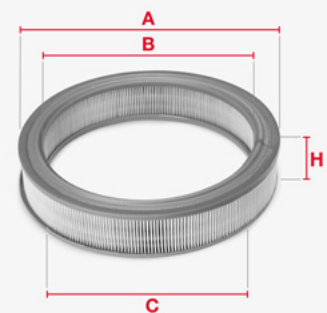

A_017



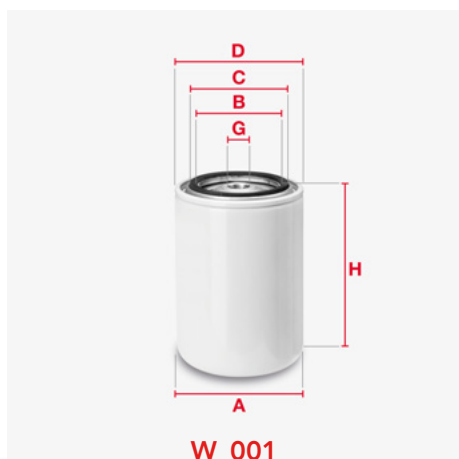
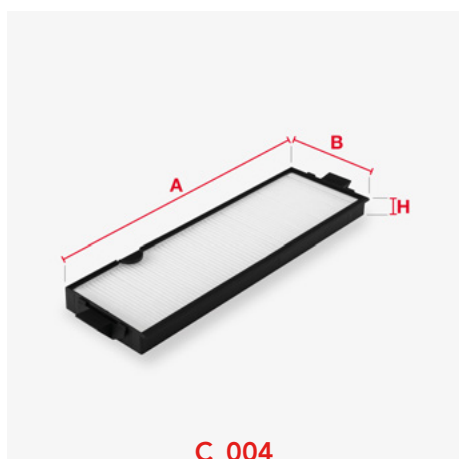
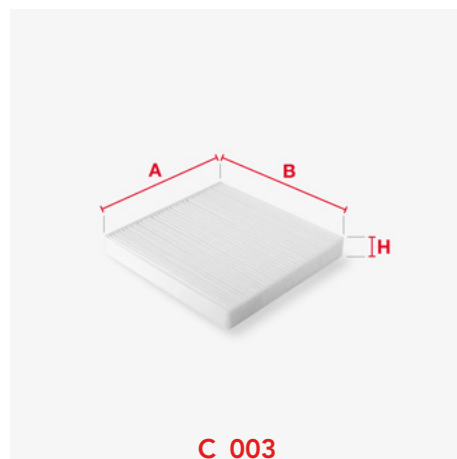
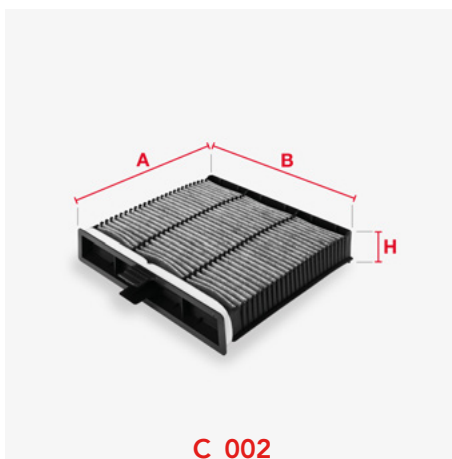
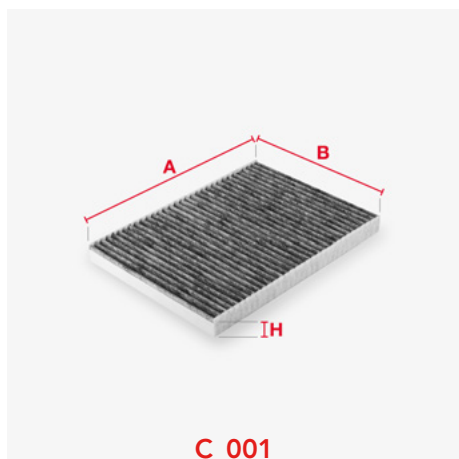







KW HP



ASTRA

dump trucks/autocarri ribaltabili

60 Serie

BM 60-36	Aifo-Iveco 8210.42R	01/89 > 12/95	S 5003 DR	S 0710 NR	S 7217 A	
inner / interno	Aifo-Iveco 8210.42R	01/89 > 12/95			S 7218 A	
prefilter / prefiltrato	Aifo-Iveco 8210.42R	01/89 > 12/95		S 0999 NR		
BM 64-26	Aifo-Iveco 8210SiA	01/89 > 12/95	S 5003 DR	S 0710 NR	S 7221 A	
inner / interno	Aifo-Iveco 8210SiA	01/89 > 12/95			S 7222 A	
prefilter / prefiltrato	Aifo-Iveco 8210SiA	01/89 > 12/95		S 0999 NR		
BM 64-30	Aifo-Iveco 8210SiA	01/89 > 12/95	S 5003 DR	S 0710 NR	S 7221 A	
inner / interno	Aifo-Iveco 8210SiA	01/89 > 12/95			S 7222 A	
prefilter / prefiltrato	Aifo-Iveco 8210SiA	01/89 > 12/95		S 0999 NR		
BM 64-36	Aifo-Iveco 8210.42R	01/89 > 12/95	S 5003 DR	S 0710 NR	S 7217 A	
inner / interno	Aifo-Iveco 8210.42R	01/89 > 12/95			S 7218 A	
prefilter / prefiltrato	Aifo-Iveco 8210.42R	01/89 > 12/95		S 0999 NR		
BM 64-42	Aifo-Iveco 8281Si10	01/89 > 12/95		S 0710 NR		
	Aifo-Iveco 8281Si10	01/89 > 12/95		S 4311 N		
1st passage (felt spare part) / 1.passaggio (ricambio in feltro)	Aifo-Iveco 8281Si10	01/89 > 12/95		S 2163 N		
2nd passage / 2.passaggio	Aifo-Iveco 8281Si10	01/89 > 12/95		S 0710 NR		
by-pass	Aifo-Iveco 8281Si10	01/89 > 12/95	S 3260 R			
water filter / filtro acqua	Aifo-Iveco 8281Si10	01/89 > 12/95				S 8410 AR
3 filters / N.3 filtri	Aifo-Iveco 8281Si10	01/89 > 12/95	S 8020 R			
prefilter / prefiltrato	Aifo-Iveco 8281Si10	01/89 > 12/95		S 0999 NR		
BM 66-30	Aifo-Iveco 8210SiA	01/89 > 12/95	S 5003 DR	S 0710 NR	S 7221 A	
inner / interno	Aifo-Iveco 8210SiA	01/89 > 12/95			S 7222 A	
prefilter / prefiltrato	Aifo-Iveco 8210SiA	01/89 > 12/95		S 0999 NR		
BM 66-36	Aifo-Iveco 8210.42R	01/89 > 12/95	S 5003 DR	S 0710 NR	S 7217 A	
inner / interno	Aifo-Iveco 8210.42R	01/89 > 12/95			S 7218 A	
prefilter / prefiltrato	Aifo-Iveco 8210.42R	01/89 > 12/95		S 0999 NR		

ATD Serie

ATD 25C	Iveco Cursor10 F3A 235 319	03/05 >		S 4395 NR		
VGT filter / filtro VGT	Iveco Cursor10 F3A 235 319	03/05 >				S 0VGT A
2 filters / N.2 filtri	Iveco Cursor10 F3A 235 319	03/05 >	S 3288 R			
prefilter / prefiltrato	Iveco Cursor10 F3A 235 319	03/05 >		S 1999 NR		
ATD 30C	Iveco Cursor10 F3A 260 353	03/05 >		S 4395 NR	S 7564 A	
VGT filter / filtro VGT	Iveco Cursor10 F3A 260 353	03/05 >				S 0VGT A
inner / interno	Iveco Cursor10 F3A 260 353	03/05 >			S 7565 A	
2 filters / N.2 filtri	Iveco Cursor10 F3A 260 353	03/05 >	S 3288 R			
prefilter / prefiltrato	Iveco Cursor10 F3A 260 353	03/05 >		S 1999 NR		
ATD 35C	Iveco Cursor13 F3B 302 410	03/05 >		S 4395 NR		
VGT filter / filtro VGT	Iveco Cursor13 F3B 302 410	03/05 >				S 0VGT A
2 filters / N.2 filtri	Iveco Cursor13 F3B 302 410	03/05 >	S 3288 R			
prefilter / prefiltrato	Iveco Cursor13 F3B 302 410	03/05 >		S 1999 NR		
ATD 40C	Iveco Cursor13 F3B 335 455	03/05 >		S 4395 NR		
VGT filter / filtro VGT	Iveco Cursor13 F3B 335 455	03/05 >				S 0VGT A
2 filters / N.2 filtri	Iveco Cursor13 F3B 335 455	03/05 >	S 3288 R			
prefilter / prefiltrato	Iveco Cursor13 F3B 335 455	03/05 >		S 1999 NR		

BE Serie

BE 106-60		01/70 >			S 6550 A	
BE 84-30		01/70 >			S 2370 A	
BE 84-40 (B73/50)	Aifo-Iveco 8210	01/70 >	S 0230 R	S 0710 NR	S 0150 A	

BM Serie

19	Mercedes Benz		S 0300 O	S 2162 N		
some / alcuni	Mercedes Benz		S 0300 O	S 2162 N	S 2370 A	
19 E	Aifo-Iveco 8210		S 0230 R	S 0710 NR	S 6270 A	
inner / interno	Aifo-Iveco 8210				S 8270 A	
2	Detroit Diesel 4-71 N		S 3301 PO			
2 SA	Detroit Diesel 4-71		S 3301 PO			
20	KHD			S 5400 NR		
some / alcuni	KHD			S 5400 NR	S 2370 A	
some / alcuni	KHD			S 5400 NR	S 0150 A	
20	Mercedes Benz OM 355			S 2162 N	S 6270 A	
some / alcuni	Mercedes Benz OM 355		S 0300 O	S 2162 N	S 6270 A	
some / alcuni	Mercedes Benz OM 355				S 2370 A	
some / alcuni	Mercedes Benz OM 355				S 4370 A	
inner / interno	Mercedes Benz OM 355				S 8270 A	
20 F	Aifo-Iveco 8210, 8211		S 0230 R		S 6270 A	
1st passage / 1.passaggio	Aifo-Iveco 8210, 8211			S 4311 N		
1st passage (felt spare part) / 1.passaggio (ricambio in feltro)	Aifo-Iveco 8210, 8211			S 2163 N		

A





KW HP



...ASTRA - dump trucks/autocarri ribaltabili

2nd passage / 2.passaggio inner / interno	Aifo-Iveco 8210, 8211 Aifo-Iveco 8210, 8211			S 0710 NR	S 8270 A	
20 M some / alcuni	Aifo-Iveco 8210 Aifo-Iveco 8210		S 0230 R	S 0710 NR	S 6550 A	
20 MR some / alcuni	Aifo-Iveco 8210 Aifo-Iveco 8210		S 0230 R	S 0710 NR	S 6550 A	
201 201 F 201 M	Aifo-Iveco 8360 Aifo-Iveco 8360 Aifo-Iveco 8360		S 0230 R S 0230 R S 0230 R	S 0710 NR S 0710 NR S 0710 NR		
21 some / alcuni some / alcuni	KHD KHD KHD			S 5400 NR S 5400 NR S 5400 NR	S 2370 A S 0150 A	
21 E inner / interno	Aifo-Iveco 8210 Aifo-Iveco 8210		S 0230 R	S 0710 NR	S 6270 A S 8270 A	
21 F 21 FE	Aifo-Iveco Aifo-Iveco 8210, 8211		S 0230 R S 0230 R	S 0710 NR	S 6550 A S 6270 A	
1st passage / 1.passaggio 1st passage (felt spare part) / 1.passaggio (ricambio in feltro) 2nd passage / 2.passaggio inner / interno	Aifo-Iveco 8210, 8211 Aifo-Iveco 8210, 8211 Aifo-Iveco 8210, 8211 Aifo-Iveco 8210, 8211			S 4311 N S 2163 N S 0710 NR	S 8270 A S 2370 A	
21 M 21 ME some / alcuni some / alcuni some / alcuni inner / interno	Mercedes Benz OM 355 Mercedes Benz OM 355 Mercedes Benz OM 355 Mercedes Benz OM 355 Mercedes Benz OM 355		S 0300 O	S 2162 N S 2162 N	S 6270 A S 6270 A S 2370 A S 4370 A S 8270 A	
22 22 22 22			S 3301 PO S 3301 PO S 3301 PO		S 2370 A	
some / alcuni some / alcuni some / alcuni inner / interno	Detroit Diesel 4-71 Detroit Diesel 4-71 N Mercedes Benz OM 355 Mercedes Benz OM 355 Mercedes Benz OM 355 Mercedes Benz OM 355		S 0300 O	S 2162 N S 2162 N	S 6270 A S 6270 A S 4370 A S 2370 A S 8270 A	
22 M some / alcuni some / alcuni some / alcuni inner / interno	Mercedes Benz OM 355 Mercedes Benz OM 355 Mercedes Benz OM 355 Mercedes Benz OM 355		S 0300 O	S 2162 N S 2162 N	S 6270 A S 6270 A S 2370 A S 4370 A S 8270 A	
25 F 25 F 1st passage / 1.passaggio 1st passage (felt spare part) / 1.passaggio (ricambio in feltro) 2nd passage / 2.passaggio water filter / filtro acqua	Aifo-Iveco Aifo-Iveco 8280 Aifo-Iveco 8280 Aifo-Iveco 8280 Aifo-Iveco 8280		S 0230 R S 0230 R	S 0710 NR	S 6550 A	
25 F/M some / alcuni	Mercedes Benz OM 403 Mercedes Benz OM 403		S 7261 PO S 7261 PO	S 2162 N S 2161 N		S 8410 AR
25 M 1st passage / 1.passaggio 1st passage (felt spare part) / 1.passaggio (ricambio in feltro) 2nd passage / 2.passaggio water filter / filtro acqua	Aifo-Iveco 8280 Aifo-Iveco 8280 Aifo-Iveco 8280 Aifo-Iveco 8280		S 0230 R	S 4311 N S 2163 N S 0710 NR		S 8410 AR
25 M some / alcuni	Mercedes Benz OM 403 Mercedes Benz OM 403		S 7261 PO S 7261 PO	S 2162 N S 2161 N		
303 F/M 303 T/M water filter / filtro acqua	Mercedes Benz OM 403 Aifo-Iveco 8280 Aifo-Iveco 8280		S 7261 PO S 0230 R	S 2162 N		S 8410 AR
304 F/M some / alcuni inner / interno or / oppure	Aifo-Iveco 8210.02 Aifo-Iveco 8210.02 Aifo-Iveco 8210.02 Aifo-Iveco 8210.02		S 0230 R	S 0710 NR S 5401 NR	S 7143 A S 7144 A	
304 F/M inner / interno	Mercedes Benz OM 422 Mercedes Benz OM 422		S 7261 PO	S 2162 N	S 7143 A S 7144 A	
305 F/M some / alcuni water filter / filtro acqua or / oppure	Aifo-Iveco 8280.02 Aifo-Iveco 8280.02 Aifo-Iveco 8280.02 Aifo-Iveco 8280.02		S 0230 R	S 0710 NR S 5401 NR S 5400 NR		S 8410 AR

**KW HP****...ASTRA - dump trucks/autocarri ribaltabili**

305 M inner / interno	Mercedes Benz OM 423 Mercedes Benz OM 423		S 7261 PO	S 2162 N	S 7945 A S 2840 A	
318-39 prefilter / prefiltra	Aifo-Iveco 8281 Si	01/82 > 12/89		S 0999 NR		
35 inner / interno	Detroit Diesel 12V-71 Detroit Diesel 12V-71		S 3301 PO		S 5450 A S 3450 A	
40 inner / interno					S 5450 A S 3450 A	
503 water filter / filtro acqua	Aifo-Iveco 8280 Aifo-Iveco 8280		S 0230 R	S 0710 NR		S 8410 AR
503	Detroit Diesel 8V-92		S 3301 PO			
HD7						
42-38 dryer filter / filtro essiccatore inner / interno 2 filters / N.2 filtri prefilter / prefiltra	Aifo-Iveco 8210.42KTCA Aifo-Iveco 8210.42KTCA Aifo-Iveco 8210.42KTCA Aifo-Iveco 8210.42KTCA Aifo-Iveco 8210.42KTCA	272 370 272 370 272 370 272 370 272 370	01/96 > 01/96 > 01/96 > 01/96 > 01/96 >		S 5664 A S 7565 A S 4329 NR S 0999 NR	S 7259 A
42-38T dryer filter / filtro essiccatore inner / interno 2 filters / N.2 filtri prefilter / prefiltra	Aifo-Iveco 8210.42KTCA Aifo-Iveco 8210.42KTCA Aifo-Iveco 8210.42KTCA Aifo-Iveco 8210.42KTCA	272 370 272 370 272 370 272 370	01/96 > 01/96 > 01/96 > 01/96 >	S 5003 DR	S 5664 A S 7565 A S 4329 NR S 0999 NR	S 7259 A
42-42 dryer filter / filtro essiccatore inner / interno 2 filters / N.2 filtri prefilter / prefiltra	Aifo-Iveco 8210.42KTCA Aifo-Iveco 8210.42KTCA Aifo-Iveco 8210.42KTCA Aifo-Iveco 8210.42KTCA	309 420 309 420 309 420 309 420	01/96 > 01/96 > 01/96 > 01/96 >	S 5003 DR	S 5664 A S 7565 A S 4329 NR S 0999 NR	S 7259 A
42-42T dryer filter / filtro essiccatore inner / interno 2 filters / N.2 filtri prefilter / prefiltra	Aifo-Iveco 8210.42KTCA Aifo-Iveco 8210.42KTCA Aifo-Iveco 8210.42KTCA Aifo-Iveco 8210.42KTCA	309 420 309 420 309 420 309 420	01/96 > 01/96 > 01/96 > 01/96 >	S 5003 DR	S 5664 A S 7565 A S 4329 NR S 0999 NR	S 7259 A
44-34 dryer filter / filtro essiccatore inner / interno 2 filters / N.2 filtri prefilter / prefiltra	Aifo-Iveco 8460.41KTCA Aifo-Iveco 8460.41KTCA Aifo-Iveco 8460.41KTCA Aifo-Iveco 8460.41KTCA	254 345 254 345 254 345 254 345	01/96 > 01/96 > 01/96 > 01/96 >	S 5003 DR	S 5664 A S 7565 A S 4329 NR S 0999 NR	S 7259 A
44-38 dryer filter / filtro essiccatore inner / interno 2 filters / N.2 filtri prefilter / prefiltra	Aifo-Iveco 8210.42KTCA Aifo-Iveco 8210.42KTCA Aifo-Iveco 8210.42KTCA Aifo-Iveco 8210.42KTCA	272 370 272 370 272 370 272 370	01/96 > 01/96 > 01/96 > 01/96 >	S 5003 DR	S 5664 A S 7565 A S 4329 NR S 0999 NR	S 7259 A
44-42 dryer filter / filtro essiccatore inner / interno 2 filters / N.2 filtri prefilter / prefiltra	Aifo-Iveco 8210.42KTCA Aifo-Iveco 8210.42KTCA Aifo-Iveco 8210.42KTCA Aifo-Iveco 8210.42KTCA	309 420 309 420 309 420 309 420	01/96 > 01/96 > 01/96 > 01/96 >	S 5003 DR	S 5664 A S 7565 A S 4329 NR S 0999 NR	S 7259 A
64-34 dryer filter / filtro essiccatore inner / interno 2 filters / N.2 filtri prefilter / prefiltra	Aifo-Iveco 8460.41KTCA Aifo-Iveco 8460.41KTCA Aifo-Iveco 8460.41KTCA Aifo-Iveco 8460.41KTCA	254 345 254 345 254 345 254 345	01/96 > 01/96 > 01/96 > 01/96 >	S 5003 DR	S 5664 A S 7565 A S 4329 NR S 0999 NR	S 7259 A
64-38 dryer filter / filtro essiccatore inner / interno 2 filters / N.2 filtri prefilter / prefiltra	Aifo-Iveco 8210.42KTCA Aifo-Iveco 8210.42KTCA Aifo-Iveco 8210.42KTCA Aifo-Iveco 8210.42KTCA	272 370 272 370 272 370 272 370	01/96 > 01/96 > 01/96 > 01/96 >	S 5003 DR	S 5664 A S 7565 A S 4329 NR S 0999 NR	S 7259 A
64-38T dryer filter / filtro essiccatore inner / interno 2 filters / N.2 filtri prefilter / prefiltra	Aifo-Iveco 8210.42KTCA Aifo-Iveco 8210.42KTCA Aifo-Iveco 8210.42KTCA Aifo-Iveco 8210.42KTCA	272 370 272 370 272 370 272 370	01/96 > 01/96 > 01/96 > 01/96 >	S 5003 DR	S 5664 A S 7565 A S 4329 NR S 0999 NR	S 7259 A
64-42 dryer filter / filtro essiccatore inner / interno 2 filters / N.2 filtri prefilter / prefiltra	Aifo-Iveco 8210.42KTCA Aifo-Iveco 8210.42KTCA Aifo-Iveco 8210.42KTCA Aifo-Iveco 8210.42KTCA	309 420 309 420 309 420 309 420	01/96 > 01/96 > 01/96 > 01/96 >	S 5003 DR	S 5664 A S 7565 A S 4329 NR S 0999 NR	S 7259 A

A

**KW HP****...ASTRA - dump trucks/autocarri ribaltabili**

prefilter / prefiltra	Aifo-Iveco 8280.42STCA	378	514	01/96	>		S 0999 NR		
84-38	Aifo-Iveco 8210.42KTCA	272	370	01/96	>			S 7564 A	
dryer filter / filtro essiccatore	Aifo-Iveco 8210.42KTCA	272	370	01/96	>				S 7259 A
inner / interno	Aifo-Iveco 8210.42KTCA	272	370	01/96	>			S 7565 A	
2 filters / N.2 filtri	Aifo-Iveco 8210.42KTCA	272	370	01/96	>	S 5003 DR	S 4329 NR		
prefilter / prefiltra	Aifo-Iveco 8210.42KTCA	272	370	01/96	>		S 0999 NR		
84-42	Aifo-Iveco 8210.42KTCA	309	420	01/96	>			S 7564 A	
dryer filter / filtro essiccatore	Aifo-Iveco 8210.42KTCA	309	420	01/96	>				S 7259 A
inner / interno	Aifo-Iveco 8210.42KTCA	309	420	01/96	>			S 7565 A	
2 filters / N.2 filtri	Aifo-Iveco 8210.42KTCA	309	420	01/96	>	S 5003 DR	S 4329 NR		
prefilter / prefiltra	Aifo-Iveco 8210.42KTCA	309	420	01/96	>		S 0999 NR		
84-45	Aifo-Iveco 8280.42BTCA	324	440	01/96	>			S 7564 A	
dryer filter / filtro essiccatore	Aifo-Iveco 8280.42BTCA	324	440	01/96	>				S 7259 A
inner / interno	Aifo-Iveco 8280.42BTCA	324	440	01/96	>			S 7565 A	
2 filters / N.2 filtri	Aifo-Iveco 8280.42BTCA	324	440	01/96	>	S 2003 DR	S 4329 NR		
prefilter / prefiltra	Aifo-Iveco 8280.42BTCA	324	440	01/96	>		S 0999 NR		
84-47									
dryer filter / filtro essiccatore	Aifo-Iveco 8210.42M	346	470	01/96	>				S 7259 A
2 filters / N.2 filtri	Aifo-Iveco 8210.42M	346	470	01/96	>	S 5003 DR	S 4329 NR		
prefilter / prefiltra	Aifo-Iveco 8210.42M	346	470	01/96	>		S 0999 NR		
84-52									
dryer filter / filtro essiccatore	Aifo-Iveco 8280.42STCA	378	514	01/96	>				S 7259 A
2 filters / N.2 filtri	Aifo-Iveco 8280.42STCA	378	514	01/96	>	S 2003 DR	S 4329 NR		
prefilter / prefiltra	Aifo-Iveco 8280.42STCA	378	514	01/96	>		S 0999 NR		
86-42	Aifo-Iveco 8210.42KTCA	309	420	01/96	>			S 7564 A	
dryer filter / filtro essiccatore	Aifo-Iveco 8210.42KTCA	309	420	01/96	>				S 7259 A
inner / interno	Aifo-Iveco 8210.42KTCA	309	420	01/96	>			S 7565 A	
2 filters / N.2 filtri	Aifo-Iveco 8210.42KTCA	309	420	01/96	>	S 5003 DR	S 4329 NR		
prefilter / prefiltra	Aifo-Iveco 8210.42KTCA	309	420	01/96	>		S 0999 NR		
86-45	Aifo-Iveco 8280.42BTCA	309	420	01/96	>			S 7564 A	
dryer filter / filtro essiccatore	Aifo-Iveco 8280.42BTCA	309	420	01/96	>				S 7259 A
inner / interno	Aifo-Iveco 8280.42BTCA	309	420	01/96	>			S 7565 A	
2 filters / N.2 filtri	Aifo-Iveco 8280.42BTCA	309	420	01/96	>	S 2003 DR	S 4329 NR		
prefilter / prefiltra	Aifo-Iveco 8280.42BTCA	309	420	01/96	>		S 0999 NR		
86-52									
dryer filter / filtro essiccatore	Aifo-Iveco 8280.42STCA	378	514	01/96	>				S 7259 A
2 filters / N.2 filtri	Aifo-Iveco 8280.42STCA	378	514	01/96	>	S 2003 DR	S 4329 NR		
prefilter / prefiltra	Aifo-Iveco 8280.42STCA	378	514	01/96	>		S 0999 NR		
HD7/c									
42.36	Iveco F3BE0681JB	265	360	01/00	>		S 4395 NR		
VGT filter / filtro VGT	Iveco F3BE0681JB	265	360	01/00	>				S 0VGT A
2 filters / N.2 filtri	Iveco F3BE0681JB	265	360	01/00	>	S 3288 R			
prefilter / prefiltra	Iveco F3BE0681JB	265	360	01/00	> 01/04		S 0999 NR		
prefilter / prefiltra	Iveco F3BE0681JB	265	360	02/04	>		S 1999 NR		
42.36T	Iveco F3BE0681JB	265	360	01/00	>		S 4395 NR		
VGT filter / filtro VGT	Iveco F3BE0681JB	265	360	01/00	>				S 0VGT A
2 filters / N.2 filtri	Iveco F3BE0681JB	265	360	01/00	>	S 3288 R			
prefilter / prefiltra	Iveco F3BE0681JB	265	360	01/00	> 01/04		S 0999 NR		
prefilter / prefiltra	Iveco F3BE0681JB	265	360	02/04	>		S 1999 NR		
42.40	Iveco F3BE0681HB	294	400	01/00	>		S 4395 NR		
VGT filter / filtro VGT	Iveco F3BE0681HB	294	400	01/00	>				S 0VGT A
2 filters / N.2 filtri	Iveco F3BE0681HB	294	400	01/00	>	S 3288 R			
prefilter / prefiltra	Iveco F3BE0681HB	294	400	01/00	> 01/04		S 0999 NR		
prefilter / prefiltra	Iveco F3BE0681HB	294	400	02/04	>		S 1999 NR		
42.40T	Iveco F3BE0681HB	294	400	01/00	>		S 4395 NR		
VGT filter / filtro VGT	Iveco F3BE0681HB	294	400	01/00	>				S 0VGT A
2 filters / N.2 filtri	Iveco F3BE0681HB	294	400	01/00	>	S 3288 R			
prefilter / prefiltra	Iveco F3BE0681HB	294	400	01/00	> 01/04		S 0999 NR		
prefilter / prefiltra	Iveco F3BE0681HB	294	400	02/04	>		S 1999 NR		
42.45	Iveco F3BE0681DB	330	450	01/00	>		S 4395 NR		
VGT filter / filtro VGT	Iveco F3BE0681DB	330	450	01/00	>				S 0VGT A
2 filters / N.2 filtri	Iveco F3BE0681DB	330	450	01/00	>	S 3288 R			
prefilter / prefiltra	Iveco F3BE0681DB	330	450	01/00	> 01/04		S 0999 NR		
prefilter / prefiltra	Iveco F3BE0681DB	330	450	02/04	>		S 1999 NR		
42.45T	Iveco F3BE0681DB	330	450	01/00	>		S 4395 NR		
VGT filter / filtro VGT	Iveco F3BE0681DB	330	450	01/00	>				S 0VGT A
2 filters / N.2 filtri	Iveco F3BE0681DB	330	450	01/00	>	S 3288 R			



**KW HP****...ASTRA - dump trucks/autocarri ribaltabili****A**

prefilter / prefiltrato	Iveco F3BE0681DB	330	450	01/00 >	01/04		S 0999 NR		
prefilter / prefiltrato	Iveco F3BE0681DB	330	450	02/04 >			S 1999 NR		
44.36	Iveco F3BE0681JB	265	360	01/00 >			S 4395 NR		
VGT filter / filtro VGT	Iveco F3BE0681JB	265	360	01/00 >					S 0VGT A
2 filters / N.2 filtri	Iveco F3BE0681JB	265	360	01/00 >		S 3288 R			
prefilter / prefiltrato	Iveco F3BE0681JB	265	360	01/00 >	01/04		S 0999 NR		
prefilter / prefiltrato	Iveco F3BE0681JB	265	360	02/04 >			S 1999 NR		
44.36T	Iveco F3BE0681JB	265	360	01/00 >			S 4395 NR		
VGT filter / filtro VGT	Iveco F3BE0681JB	265	360	01/00 >					S 0VGT A
2 filters / N.2 filtri	Iveco F3BE0681JB	265	360	01/00 >		S 3288 R			
prefilter / prefiltrato	Iveco F3BE0681JB	265	360	01/00 >	01/04		S 0999 NR		
prefilter / prefiltrato	Iveco F3BE0681JB	265	360	02/04 >			S 1999 NR		
44.40	Iveco F3BE0681HB	294	400	01/00 >			S 4395 NR		
VGT filter / filtro VGT	Iveco F3BE0681HB	294	400	01/00 >					S 0VGT A
2 filters / N.2 filtri	Iveco F3BE0681HB	294	400	01/00 >		S 3288 R			
prefilter / prefiltrato	Iveco F3BE0681HB	294	400	01/00 >	01/04		S 0999 NR		
prefilter / prefiltrato	Iveco F3BE0681HB	294	400	02/04 >			S 1999 NR		
44.40T	Iveco F3BE0681HB	294	400	01/00 >			S 4395 NR		
VGT filter / filtro VGT	Iveco F3BE0681HB	294	400	01/00 >					S 0VGT A
2 filters / N.2 filtri	Iveco F3BE0681HB	294	400	01/00 >		S 3288 R			
prefilter / prefiltrato	Iveco F3BE0681HB	294	400	01/00 >	01/04		S 0999 NR		
prefilter / prefiltrato	Iveco F3BE0681HB	294	400	02/04 >			S 1999 NR		
44.45	Iveco F3BE0681DB	330	450	01/00 >			S 4395 NR		
VGT filter / filtro VGT	Iveco F3BE0681DB	330	450	01/00 >					S 0VGT A
2 filters / N.2 filtri	Iveco F3BE0681DB	330	450	01/00 >		S 3288 R			
prefilter / prefiltrato	Iveco F3BE0681DB	330	450	01/00 >	01/04		S 0999 NR		
prefilter / prefiltrato	Iveco F3BE0681DB	330	450	02/04 >			S 1999 NR		
44.45T	Iveco F3BE0681DB	330	450	01/00 >			S 4395 NR		
VGT filter / filtro VGT	Iveco F3BE0681DB	330	450	01/00 >					S 0VGT A
2 filters / N.2 filtri	Iveco F3BE0681DB	330	450	01/00 >		S 3288 R			
prefilter / prefiltrato	Iveco F3BE0681DB	330	450	01/00 >	01/04		S 0999 NR		
prefilter / prefiltrato	Iveco F3BE0681DB	330	450	02/04 >			S 1999 NR		
86.40	Iveco F3BE0681HB	294	400	01/00 >			S 4395 NR		
VGT filter / filtro VGT	Iveco F3BE0681HB	294	400	01/00 >					S 0VGT A
2 filters / N.2 filtri	Iveco F3BE0681HB	294	400	01/00 >		S 3288 R			
prefilter / prefiltrato	Iveco F3BE0681HB	294	400	01/00 >	01/04		S 0999 NR		
prefilter / prefiltrato	Iveco F3BE0681HB	294	400	02/04 >			S 1999 NR		
86.45	Iveco F3BE0681DB	330	450	01/00 >			S 4395 NR		
VGT filter / filtro VGT	Iveco F3BE0681DB	330	450	01/00 >					S 0VGT A
2 filters / N.2 filtri	Iveco F3BE0681DB	330	450	01/00 >		S 3288 R			
prefilter / prefiltrato	Iveco F3BE0681DB	330	450	01/00 >	01/04		S 0999 NR		
prefilter / prefiltrato	Iveco F3BE0681DB	330	450	02/04 >			S 1999 NR		
86.50	Iveco F3BE0681FB	367	500	01/00 >			S 4395 NR		
VGT filter / filtro VGT	Iveco F3BE0681FB	367	500	01/00 >					S 0VGT A
2 filters / N.2 filtri	Iveco F3BE0681FB	367	500	01/00 >		S 3288 R			
prefilter / prefiltrato	Iveco F3BE0681FB	367	500	01/00 >	01/04		S 0999 NR		
prefilter / prefiltrato	Iveco F3BE0681FB	367	500	02/04 >			S 1999 NR		
88.45	Iveco F3BE0681DB	330	450	01/00 >			S 4395 NR		
VGT filter / filtro VGT	Iveco F3BE0681DB	330	450	01/00 >					S 0VGT A
2 filters / N.2 filtri	Iveco F3BE0681DB	330	450	01/00 >		S 3288 R			
prefilter / prefiltrato	Iveco F3BE0681DB	330	450	01/00 >	01/04		S 0999 NR		
prefilter / prefiltrato	Iveco F3BE0681DB	330	450	02/04 >			S 1999 NR		
88.50	Iveco F3BE0681FB	367	500	01/00 >			S 4395 NR		
VGT filter / filtro VGT	Iveco F3BE0681FB	367	500	01/00 >					S 0VGT A
2 filters / N.2 filtri	Iveco F3BE0681FB	367	500	01/00 >		S 3288 R			
prefilter / prefiltrato	Iveco F3BE0681FB	367	500	01/00 >	01/04		S 0999 NR		
prefilter / prefiltrato	Iveco F3BE0681FB	367	500	02/04 >			S 1999 NR		
HD8									
42.33	Iveco F2BE3681B	243	330	06/07 >		S 3288 R	S 4396 NR	S 7564 A	
dryer filter / filtro essiccatore	Iveco F2BE3681B	243	330	06/07 >					S 7259 A
VGT filter / filtro VGT	Iveco F2BE3681B	243	330	06/07 >					S 0VGT A
inner / interno	Iveco F2BE3681B	243	330	06/07 >				S 7565 A	
prefilter / prefiltrato	Iveco F2BE3681B	243	330	06/07 >			S 1999 NR		
prefilter SEPAR SWK2000/10/K / prefiltrato SEPAR SWK2000/10/K	Iveco F2BE3681B	243	330	06/07 >			S 6062 NE		
power steering / servosterzo	Iveco F2BE3681B	243	330	06/07 >					S 3081 PO
42.36	Iveco F3BE0681JB	265	360	01/05 >			S 4395 NR		
VGT filter / filtro VGT	Iveco F3BE0681JB	265	360	01/05 >					S 0VGT A

**KW HP****...ASTRA - dump trucks/autocarri ribaltabili**

2 filters / N.2 filtri	Iveco F3BE0681JB	265	360	01/05	>	S 3288 R			
prefilter / prefiltrato	Iveco F3BE0681JB	265	360	01/05	>		S 1999 NR		
42.36T	Iveco F3BE0681JB	265	360	01/05	>		S 4395 NR		
VGT filter / filtro VGT	Iveco F3BE0681JB	265	360	01/05	>				S 0VGT A
2 filters / N.2 filtri	Iveco F3BE0681JB	265	360	01/05	>	S 3288 R			
prefilter / prefiltrato	Iveco F3BE0681JB	265	360	01/05	>		S 1999 NR		
42.40	Iveco F3BE0681HB	294	400	01/05	>		S 4395 NR		
VGT filter / filtro VGT	Iveco F3BE0681HB	294	400	01/05	>				S 0VGT A
2 filters / N.2 filtri	Iveco F3BE0681HB	294	400	01/05	>	S 3288 R			
prefilter / prefiltrato	Iveco F3BE0681HB	294	400	01/05	>		S 1999 NR		
42.40T	Iveco F3BE0681HB	294	400	01/05	>		S 4395 NR		
VGT filter / filtro VGT	Iveco F3BE0681HB	294	400	01/05	>				S 0VGT A
2 filters / N.2 filtri	Iveco F3BE0681HB	294	400	01/05	>	S 3288 R			
prefilter / prefiltrato	Iveco F3BE0681HB	294	400	01/05	>		S 1999 NR		
42.41 Euro5	Iveco F3BE3681D	302	410	03/07	>		S 1395 NR	S 7564 A	
with filter AdBlue/SCR Denoxtronic 1 / con filtro AdBlue/SCR Denoxtronic 1	Iveco F3BE3681D	302	410	03/07	>				S 4401 U
with filter AdBlue/SCR Denoxtronic 2 / con filtro AdBlue/SCR Denoxtronic 2	Iveco F3BE3681D	302	410	03/07	>				S 4402 U
dryer filter / filtro essiccatore	Iveco F3BE3681D	302	410	03/07	>				S 7259 A
VGT filter / filtro VGT	Iveco F3BE3681D	302	410	03/07	>				S 0VGT A
inner / interno	Iveco F3BE3681D	302	410	03/07	>			S 7565 A	
2 filters / N.2 filtri	Iveco F3BE3681D	302	410	03/07	>	S 3288 R			
prefilter / prefiltrato	Iveco F3BE3681D	302	410	03/07	>		S 1999 NR		
prefilter SEPAR SWK2000/10/K / prefiltrato SEPAR SWK2000/10/K	Iveco F3BE3681D	302	410	03/07	>		S 6062 NE		
power steering / servosterzo	Iveco F3BE3681D	302	410	03/07	>				S 3081 PO
42.44 Euro5	Iveco F3BE3681G	324	440	03/07	>		S 1395 NR	S 7564 A	
with filter AdBlue/SCR Denoxtronic 1 / con filtro AdBlue/SCR Denoxtronic 1	Iveco F3BE3681G	324	440	03/07	>				S 4401 U
with filter AdBlue/SCR Denoxtronic 2 / con filtro AdBlue/SCR Denoxtronic 2	Iveco F3BE3681G	324	440	03/07	>				S 4402 U
dryer filter / filtro essiccatore	Iveco F3BE3681G	324	440	03/07	>				S 7259 A
VGT filter / filtro VGT	Iveco F3BE3681G	324	440	03/07	>				S 0VGT A
inner / interno	Iveco F3BE3681G	324	440	03/07	>			S 7565 A	
2 filters / N.2 filtri	Iveco F3BE3681G	324	440	03/07	>	S 3288 R			
prefilter / prefiltrato	Iveco F3BE3681G	324	440	03/07	>		S 1999 NR		
prefilter SEPAR SWK2000/10/K / prefiltrato SEPAR SWK2000/10/K	Iveco F3BE3681G	324	440	03/07	>		S 6062 NE		
power steering / servosterzo	Iveco F3BE3681G	324	440	03/07	>				S 3081 PO
42.45	Iveco F3BE0681DB	330	450	01/05	>		S 4395 NR		
VGT filter / filtro VGT	Iveco F3BE0681DB	330	450	01/05	>				S 0VGT A
2 filters / N.2 filtri	Iveco F3BE0681DB	330	450	01/05	>	S 3288 R			
prefilter / prefiltrato	Iveco F3BE0681DB	330	450	01/05	>		S 1999 NR		
42.45T	Iveco F3BE0681DB	330	450	01/05	>		S 4395 NR		
VGT filter / filtro VGT	Iveco F3BE0681DB	330	450	01/05	>				S 0VGT A
2 filters / N.2 filtri	Iveco F3BE0681DB	330	450	01/05	>	S 3288 R			
prefilter / prefiltrato	Iveco F3BE0681DB	330	450	01/05	>		S 1999 NR		
42.48 Euro5	Iveco F3BE3681F	353	480	03/07	>		S 1395 NR	S 7564 A	
with filter AdBlue/SCR Denoxtronic 1 / con filtro AdBlue/SCR Denoxtronic 1	Iveco F3BE3681F	353	480	03/07	>				S 4401 U
with filter AdBlue/SCR Denoxtronic 2 / con filtro AdBlue/SCR Denoxtronic 2	Iveco F3BE3681F	353	480	03/07	>				S 4402 U
dryer filter / filtro essiccatore	Iveco F3BE3681F	353	480	03/07	>				S 7259 A
VGT filter / filtro VGT	Iveco F3BE3681F	353	480	03/07	>				S 0VGT A
inner / interno	Iveco F3BE3681F	353	480	03/07	>			S 7565 A	
2 filters / N.2 filtri	Iveco F3BE3681F	353	480	03/07	>	S 3288 R			
prefilter / prefiltrato	Iveco F3BE3681F	353	480	03/07	>		S 1999 NR		
prefilter SEPAR SWK2000/10/K / prefiltrato SEPAR SWK2000/10/K	Iveco F3BE3681F	353	480	03/07	>		S 6062 NE		
power steering / servosterzo	Iveco F3BE3681F	353	480	03/07	>				S 3081 PO
42.50	Iveco F3BE0681KB	367	500	01/05	>		S 4395 NR		
VGT filter / filtro VGT	Iveco F3BE0681KB	367	500	01/05	>				S 0VGT A
2 filters / N.2 filtri	Iveco F3BE0681KB	367	500	01/05	>	S 3288 R			
prefilter / prefiltrato	Iveco F3BE0681KB	367	500	01/05	>		S 1999 NR		
42.50T	Iveco F3BE0681KB	367	500	01/05	>		S 4395 NR		
VGT filter / filtro VGT	Iveco F3BE0681KB	367	500	01/05	>				S 0VGT A
2 filters / N.2 filtri	Iveco F3BE0681KB	367	500	01/05	>	S 3288 R			
prefilter / prefiltrato	Iveco F3BE0681KB	367	500	01/05	>		S 1999 NR		
44.36	Iveco F3BE0681JB	265	360	01/05	>		S 4395 NR		
VGT filter / filtro VGT	Iveco F3BE0681JB	265	360	01/05	>				S 0VGT A
2 filters / N.2 filtri	Iveco F3BE0681JB	265	360	01/05	>	S 3288 R			
prefilter / prefiltrato	Iveco F3BE0681JB	265	360	01/05	>		S 1999 NR		
44.36T	Iveco F3BE0681JB	265	360	01/05	>		S 4395 NR		
VGT filter / filtro VGT	Iveco F3BE0681JB	265	360	01/05	>				S 0VGT A
2 filters / N.2 filtri	Iveco F3BE0681JB	265	360	01/05	>	S 3288 R			



**KW HP****...ASTRA - dump trucks/autocarri ribaltabili**

2 filters / N.2 filtri	Iveco F3BE0681HB	294	400	01/05	>	S 3288 R			
prefilter / prefiltra	Iveco F3BE0681HB	294	400	01/05	>		S 1999 NR		
66.40T	Iveco F3BE0681HB	294	400	01/05	>		S 4395 NR		
VGT filter / filtro VGT	Iveco F3BE0681HB	294	400	01/05	>				S 0VGT A
2 filters / N.2 filtri	Iveco F3BE0681HB	294	400	01/05	>	S 3288 R			
prefilter / prefiltra	Iveco F3BE0681HB	294	400	01/05	>		S 1999 NR		
66.45	Iveco F3BE0681DB	330	450	01/05	>		S 4395 NR		
VGT filter / filtro VGT	Iveco F3BE0681DB	330	450	01/05	>				S 0VGT A
2 filters / N.2 filtri	Iveco F3BE0681DB	330	450	01/05	>	S 3288 R			
prefilter / prefiltra	Iveco F3BE0681DB	330	450	01/05	>		S 1999 NR		
66.45T	Iveco F3BE0681DB	330	450	01/05	>		S 4395 NR		
VGT filter / filtro VGT	Iveco F3BE0681DB	330	450	01/05	>				S 0VGT A
2 filters / N.2 filtri	Iveco F3BE0681DB	330	450	01/05	>	S 3288 R			
prefilter / prefiltra	Iveco F3BE0681DB	330	450	01/05	>		S 1999 NR		
66.50	Iveco F3BE0681KB	367	500	01/05	>		S 4395 NR		
VGT filter / filtro VGT	Iveco F3BE0681KB	367	500	01/05	>				S 0VGT A
2 filters / N.2 filtri	Iveco F3BE0681KB	367	500	01/05	>	S 3288 R			
prefilter / prefiltra	Iveco F3BE0681KB	367	500	01/05	>		S 1999 NR		
66.50T	Iveco F3BE0681KB	367	500	01/05	>		S 4395 NR		
VGT filter / filtro VGT	Iveco F3BE0681KB	367	500	01/05	>				S 0VGT A
2 filters / N.2 filtri	Iveco F3BE0681KB	367	500	01/05	>	S 3288 R			
prefilter / prefiltra	Iveco F3BE0681KB	367	500	01/05	>		S 1999 NR		
84.36	Iveco F3BE0681JB	265	360	01/05	>		S 4395 NR		
VGT filter / filtro VGT	Iveco F3BE0681JB	265	360	01/05	>				S 0VGT A
2 filters / N.2 filtri	Iveco F3BE0681JB	265	360	01/05	>	S 3288 R			
prefilter / prefiltra	Iveco F3BE0681JB	265	360	01/05	>		S 1999 NR		
84.40	Iveco F3BE0681HB	294	400	01/05	>		S 4395 NR		
VGT filter / filtro VGT	Iveco F3BE0681HB	294	400	01/05	>				S 0VGT A
2 filters / N.2 filtri	Iveco F3BE0681HB	294	400	01/05	>	S 3288 R			
prefilter / prefiltra	Iveco F3BE0681HB	294	400	01/05	>		S 1999 NR		
84.41 Euro5	Iveco F3BE3681D	302	410	03/07	>		S 1395 NR	S 7564 A	
with filter AdBlue/SCR Denoxtronic 1 / con filtro AdBlue/SCR Denoxtronic 1	Iveco F3BE3681D	302	410	03/07	>				S 4401 U
with filter AdBlue/SCR Denoxtronic 2 / con filtro AdBlue/SCR Denoxtronic 2	Iveco F3BE3681D	302	410	03/07	>				S 4402 U
dryer filter / filtro essiccatore	Iveco F3BE3681D	302	410	03/07	>				S 7259 A
VGT filter / filtro VGT	Iveco F3BE3681D	302	410	03/07	>				S 0VGT A
inner / interno	Iveco F3BE3681D	302	410	03/07	>			S 7565 A	
2 filters / N.2 filtri	Iveco F3BE3681D	302	410	03/07	>	S 3288 R			
prefilter / prefiltra	Iveco F3BE3681D	302	410	03/07	>		S 1999 NR		
prefilter SEPAR SWK2000/10/K / prefiltra SEPAR SWK2000/10/K	Iveco F3BE3681D	302	410	03/07	>		S 6062 NE		
power steering / servosterzo	Iveco F3BE3681D	302	410	03/07	>				S 3081 PO
84.44 Euro5	Iveco F3BE3681G	324	440	03/07	>		S 1395 NR	S 7564 A	
with filter AdBlue/SCR Denoxtronic 1 / con filtro AdBlue/SCR Denoxtronic 1	Iveco F3BE3681G	324	440	03/07	>				S 4401 U
with filter AdBlue/SCR Denoxtronic 2 / con filtro AdBlue/SCR Denoxtronic 2	Iveco F3BE3681G	324	440	03/07	>				S 4402 U
dryer filter / filtro essiccatore	Iveco F3BE3681G	324	440	03/07	>				S 7259 A
VGT filter / filtro VGT	Iveco F3BE3681G	324	440	03/07	>				S 0VGT A
inner / interno	Iveco F3BE3681G	324	440	03/07	>			S 7565 A	
2 filters / N.2 filtri	Iveco F3BE3681G	324	440	03/07	>	S 3288 R			
prefilter / prefiltra	Iveco F3BE3681G	324	440	03/07	>		S 1999 NR		
prefilter SEPAR SWK2000/10/K / prefiltra SEPAR SWK2000/10/K	Iveco F3BE3681G	324	440	03/07	>		S 6062 NE		
power steering / servosterzo	Iveco F3BE3681G	324	440	03/07	>				S 3081 PO
84.45	Iveco F3BE0681DB	330	450	01/05	>		S 4395 NR		
VGT filter / filtro VGT	Iveco F3BE0681DB	330	450	01/05	>				S 0VGT A
2 filters / N.2 filtri	Iveco F3BE0681DB	330	450	01/05	>	S 3288 R			
prefilter / prefiltra	Iveco F3BE0681DB	330	450	01/05	>		S 1999 NR		
84.48 Euro5	Iveco F3BE3681F	353	480	03/07	>		S 1395 NR	S 7564 A	
with filter AdBlue/SCR Denoxtronic 1 / con filtro AdBlue/SCR Denoxtronic 1	Iveco F3BE3681F	353	480	03/07	>				S 4401 U
with filter AdBlue/SCR Denoxtronic 2 / con filtro AdBlue/SCR Denoxtronic 2	Iveco F3BE3681F	353	480	03/07	>				S 4402 U
dryer filter / filtro essiccatore	Iveco F3BE3681F	353	480	03/07	>				S 7259 A
VGT filter / filtro VGT	Iveco F3BE3681F	353	480	03/07	>				S 0VGT A
inner / interno	Iveco F3BE3681F	353	480	03/07	>			S 7565 A	
2 filters / N.2 filtri	Iveco F3BE3681F	353	480	03/07	>	S 3288 R			
prefilter / prefiltra	Iveco F3BE3681F	353	480	03/07	>		S 1999 NR		
prefilter SEPAR SWK2000/10/K / prefiltra SEPAR SWK2000/10/K	Iveco F3BE3681F	353	480	03/07	>		S 6062 NE		
power steering / servosterzo	Iveco F3BE3681F	353	480	03/07	>				S 3081 PO
84.50	Iveco F3BE0681KB	367	500	01/05	>		S 4395 NR		
VGT filter / filtro VGT	Iveco F3BE0681KB	367	500	01/05	>				S 0VGT A
2 filters / N.2 filtri	Iveco F3BE0681KB	367	500	01/05	>	S 3288 R			

A

**KW HP****...ASTRA - dump trucks/autocarri ribaltabili**

prefilter / prefiltrato	Iveco F3BE0681KB	367	500	01/05	>		S 1999 NR		
84.52 Euro5	Iveco F3BE3681E	382	520	03/07	>		S 1395 NR	S 7564 A	
with filter AdBlue/SCR Denoxtronic 1 / con filtro AdBlue/SCR Denoxtronic 1	Iveco F3BE3681E	382	520	03/07	>				S 4401 U
with filter AdBlue/SCR Denoxtronic 2 / con filtro AdBlue/SCR Denoxtronic 2	Iveco F3BE3681E	382	520	03/07	>				S 4402 U
dryer filter / filtro essiccatore	Iveco F3BE3681E	382	520	03/07	>				S 7259 A
VGT filter / filtro VGT	Iveco F3BE3681E	382	520	03/07	>				S 0VGT A
inner / interno	Iveco F3BE3681E	382	520	03/07	>			S 7565 A	
2 filters / N.2 filtri	Iveco F3BE3681E	382	520	03/07	>	S 3288 R			
prefilter / prefiltrato	Iveco F3BE3681E	382	520	03/07	>		S 1999 NR		
prefilter SEPAR SWK2000/10/K / prefiltrato SEPAR SWK2000/10/K	Iveco F3BE3681E	382	520	03/07	>		S 6062 NE		
power steering / servosterzo	Iveco F3BE3681E	382	520	03/07	>				S 3081 PO
84.54	Iveco F3BE0681AB	397	540	01/05	>		S 4395 NR		
VGT filter / filtro VGT	Iveco F3BE0681AB	397	540	01/05	>				S 0VGT A
2 filters / N.2 filtri	Iveco F3BE0681AB	397	540	01/05	>	S 3288 R			
prefilter / prefiltrato	Iveco F3BE0681AB	397	540	01/05	>		S 1999 NR		
84.56 Euro5	Iveco F3BE3681A	412	560	03/07	>		S 1395 NR	S 7564 A	
with filter AdBlue/SCR Denoxtronic 1 / con filtro AdBlue/SCR Denoxtronic 1	Iveco F3BE3681A	412	560	03/07	>				S 4401 U
with filter AdBlue/SCR Denoxtronic 2 / con filtro AdBlue/SCR Denoxtronic 2	Iveco F3BE3681A	412	560	03/07	>				S 4402 U
dryer filter / filtro essiccatore	Iveco F3BE3681A	412	560	03/07	>				S 7259 A
VGT filter / filtro VGT	Iveco F3BE3681A	412	560	03/07	>				S 0VGT A
inner / interno	Iveco F3BE3681A	412	560	03/07	>			S 7565 A	
2 filters / N.2 filtri	Iveco F3BE3681A	412	560	03/07	>	S 3288 R			
prefilter / prefiltrato	Iveco F3BE3681A	412	560	03/07	>		S 1999 NR		
prefilter SEPAR SWK2000/10/K / prefiltrato SEPAR SWK2000/10/K	Iveco F3BE3681A	412	560	03/07	>		S 6062 NE		
power steering / servosterzo	Iveco F3BE3681A	412	560	03/07	>				S 3081 PO
86.40	Iveco F3BE0681HB	294	400	01/05	>		S 4395 NR		
VGT filter / filtro VGT	Iveco F3BE0681HB	294	400	01/05	>				S 0VGT A
2 filters / N.2 filtri	Iveco F3BE0681HB	294	400	01/05	>	S 3288 R			
prefilter / prefiltrato	Iveco F3BE0681HB	294	400	01/05	>		S 1999 NR		
86.45	Iveco F3BE0681DB	330	450	01/05	>		S 4395 NR		
VGT filter / filtro VGT	Iveco F3BE0681DB	330	450	01/05	>				S 0VGT A
2 filters / N.2 filtri	Iveco F3BE0681DB	330	450	01/05	>	S 3288 R			
prefilter / prefiltrato	Iveco F3BE0681DB	330	450	01/05	>		S 1999 NR		
86.50	Iveco F3BE0681KB	367	500	01/05	>		S 4395 NR		
VGT filter / filtro VGT	Iveco F3BE0681KB	367	500	01/05	>				S 0VGT A
2 filters / N.2 filtri	Iveco F3BE0681KB	367	500	01/05	>	S 3288 R			
prefilter / prefiltrato	Iveco F3BE0681KB	367	500	01/05	>		S 1999 NR		
86.54	Iveco F3BE0681AB	397	540	01/05	>		S 4395 NR		
VGT filter / filtro VGT	Iveco F3BE0681AB	397	540	01/05	>				S 0VGT A
2 filters / N.2 filtri	Iveco F3BE0681AB	397	540	01/05	>	S 3288 R			
prefilter / prefiltrato	Iveco F3BE0681AB	397	540	01/05	>		S 1999 NR		
88.45	Iveco F3BE0681DB	330	450	01/05	>		S 4395 NR		
VGT filter / filtro VGT	Iveco F3BE0681DB	330	450	01/05	>				S 0VGT A
2 filters / N.2 filtri	Iveco F3BE0681DB	330	450	01/05	>	S 3288 R			
prefilter / prefiltrato	Iveco F3BE0681DB	330	450	01/05	>		S 1999 NR		
88.50	Iveco F3BE0681KB	367	500	01/05	>		S 4395 NR		
VGT filter / filtro VGT	Iveco F3BE0681KB	367	500	01/05	>				S 0VGT A
2 filters / N.2 filtri	Iveco F3BE0681KB	367	500	01/05	>	S 3288 R			
prefilter / prefiltrato	Iveco F3BE0681KB	367	500	01/05	>		S 1999 NR		
88.54	Iveco F3BE0681AB	397	540	01/05	>		S 4395 NR		
VGT filter / filtro VGT	Iveco F3BE0681AB	397	540	01/05	>				S 0VGT A
2 filters / N.2 filtri	Iveco F3BE0681AB	397	540	01/05	>	S 3288 R			
prefilter / prefiltrato	Iveco F3BE0681AB	397	540	01/05	>		S 1999 NR		
HD9									
64.41	F3BE3681D Cursor13	302	411	01/12	>		S 1395 NR	S 7564 A	
with filter AdBlue/SCR Denoxtronic 1 / con filtro AdBlue/SCR Denoxtronic 1	F3BE3681D Cursor13	302	411	01/12	>				S 4401 U
with filter AdBlue/SCR Denoxtronic 2 / con filtro AdBlue/SCR Denoxtronic 2	F3BE3681D Cursor13	302	411	01/12	>				S 4402 U
dryer filter / filtro essiccatore	F3BE3681D Cursor13	302	411	01/12	>				S 7259 A
VGT filter / filtro VGT	F3BE3681D Cursor13	302	411	01/12	>				S 0VGT A
inner / interno	F3BE3681D Cursor13	302	411	01/12	>			S 7565 A	
2 filters / N.2 filtri	F3BE3681D Cursor13	302	411	01/12	>	S 3288 R			
prefilter / prefiltrato	F3BE3681D Cursor13	302	411	01/12	>		S 1999 NR		
prefilter SEPAR SWK2000/10/K / prefiltrato SEPAR SWK2000/10/K	F3BE3681D Cursor13	302	411	01/12	>		S 6062 NE		
power steering / servosterzo	F3BE3681D Cursor13	302	411	01/12	>				S 3081 PO
64.44	F3BE3681G Cursor13	324	440	01/12	>		S 1395 NR	S 7564 A	
with filter AdBlue/SCR Denoxtronic 1 / con filtro AdBlue/SCR Denoxtronic 1	F3BE3681G Cursor13	324	440	01/12	>				S 4401 U
with filter AdBlue/SCR Denoxtronic 2 / con filtro AdBlue/SCR Denoxtronic 2	F3BE3681G Cursor13	324	440	01/12	>				S 4402 U

**KW HP****...ASTRA - dump trucks/autocarri ribaltabili**

dryer filter / filtro essiccatore	F3BE3681G Cursor13	324	440	01/12	>			S 7259 A
VGT filter / filtro VGT	F3BE3681G Cursor13	324	440	01/12	>			S 0VGT A
inner / interno	F3BE3681G Cursor13	324	440	01/12	>			
2 filters / N.2 filtri	F3BE3681G Cursor13	324	440	01/12	>	S 3288 R		S 7565 A
prefilter / prefiltra	F3BE3681G Cursor13	324	440	01/12	>		S 1999 NR	
prefilter SEPAR SWK2000/10/K / prefiltra SEPAR SWK2000/10/K	F3BE3681G Cursor13	324	440	01/12	>		S 6062 NE	
power steering / servosterzo	F3BE3681G Cursor13	324	440	01/12	>			S 3081 PO
64.48	F3BE3681F Cursor13	353	480	01/12	>		S 1395 NR	S 7564 A
with filter AdBlue/SCR Denoxtronic 1 / con filtro AdBlue/SCR Denoxtronic 1	F3BE3681F Cursor13	353	480	01/12	>			S 4401 U
with filter AdBlue/SCR Denoxtronic 2 / con filtro AdBlue/SCR Denoxtronic 2	F3BE3681F Cursor13	353	480	01/12	>			S 4402 U
dryer filter / filtro essiccatore	F3BE3681F Cursor13	353	480	01/12	>			S 7259 A
VGT filter / filtro VGT	F3BE3681F Cursor13	353	480	01/12	>			S 0VGT A
inner / interno	F3BE3681F Cursor13	353	480	01/12	>			S 7565 A
2 filters / N.2 filtri	F3BE3681F Cursor13	353	480	01/12	>	S 3288 R		
prefilter / prefiltra	F3BE3681F Cursor13	353	480	01/12	>		S 1999 NR	
prefilter SEPAR SWK2000/10/K / prefiltra SEPAR SWK2000/10/K	F3BE3681F Cursor13	353	480	01/12	>		S 6062 NE	
power steering / servosterzo	F3BE3681F Cursor13	353	480	01/12	>			S 3081 PO
64.50 E6	F3HFE611B Cursor13 E6	368	500	09/14	>		S 6044 NE	S 7564 A
to engine No. 24950 / a motore N. 24950	F3HFE611B Cursor13 E6	368	500	09/14	>	S 5102 PE		
some dryer filter / alcuni filtro essiccatore	F3HFE611B Cursor13 E6	368	500	09/14	>			S 7A66 A
with air-conditioner / con climatizzatore	F3HFE611B Cursor13 E6	368	500	09/14	>			S 3078 C
with activated carbon air-conditioner / con climatizzatore, ai carboni attivi	F3HFE611B Cursor13 E6	368	500	09/14	>			S 4346 CA
with filter Urea/Adblue SCR Denoxtronic 2.2 / con filtro Urea/Adblue SCR Denoxtronic 2.2	F3HFE611B Cursor13 E6	368	500	09/14	>			S 4405 U
from engine No. 24951 / da motore N. 24951	F3HFE611B Cursor13 E6	368	500			S 5169 PE		
dryer filter / filtro essiccatore	F3HFE611B Cursor13 E6	368	500	09/14	>			S 7259 A
inner / interno	F3HFE611B Cursor13 E6	368	500	09/14	>			S 7565 A
prefilter RACOR / prefiltra RACOR	F3HFE611B Cursor13 E6	368	500	09/14	>		S 4474 NR	
prefilter SEPAR SWK2000/10/K / prefiltra SEPAR SWK2000/10/K	F3HFE611B Cursor13 E6	368	500	09/14	>		S 6062 NE	
power steering / servosterzo	F3HFE611B Cursor13 E6	368	500	09/14	>			S 3081 PO
64.52	F3BE3681E Cursor13	382	520	01/12	>		S 1395 NR	S 7564 A
with filter AdBlue/SCR Denoxtronic 1 / con filtro AdBlue/SCR Denoxtronic 1	F3BE3681E Cursor13	382	520	01/12	>			S 4401 U
with filter AdBlue/SCR Denoxtronic 2 / con filtro AdBlue/SCR Denoxtronic 2	F3BE3681E Cursor13	382	520	01/12	>			S 4402 U
dryer filter / filtro essiccatore	F3BE3681E Cursor13	382	520	01/12	>			S 7259 A
VGT filter / filtro VGT	F3BE3681E Cursor13	382	520	01/12	>			S 0VGT A
inner / interno	F3BE3681E Cursor13	382	520	01/12	>			S 7565 A
2 filters / N.2 filtri	F3BE3681E Cursor13	382	520	01/12	>	S 3288 R		
prefilter / prefiltra	F3BE3681E Cursor13	382	520	01/12	>		S 1999 NR	
prefilter SEPAR SWK2000/10/K / prefiltra SEPAR SWK2000/10/K	F3BE3681E Cursor13	382	520	01/12	>		S 6062 NE	
power steering / servosterzo	F3BE3681E Cursor13	382	520	01/12	>			S 3081 PO
64.56	F3BE3681A Cursor13	412	560	01/12	>		S 1395 NR	S 7564 A
with filter AdBlue/SCR Denoxtronic 1 / con filtro AdBlue/SCR Denoxtronic 1	F3BE3681A Cursor13	412	560	01/12	>			S 4401 U
with filter AdBlue/SCR Denoxtronic 2 / con filtro AdBlue/SCR Denoxtronic 2	F3BE3681A Cursor13	412	560	01/12	>			S 4402 U
dryer filter / filtro essiccatore	F3BE3681A Cursor13	412	560	01/12	>			S 7259 A
VGT filter / filtro VGT	F3BE3681A Cursor13	412	560	01/12	>			S 0VGT A
inner / interno	F3BE3681A Cursor13	412	560	01/12	>			S 7565 A
2 filters / N.2 filtri	F3BE3681A Cursor13	412	560	01/12	>	S 3288 R		
prefilter / prefiltra	F3BE3681A Cursor13	412	560	01/12	>		S 1999 NR	
prefilter SEPAR SWK2000/10/K / prefiltra SEPAR SWK2000/10/K	F3BE3681A Cursor13	412	560	01/12	>		S 6062 NE	
power steering / servosterzo	F3BE3681A Cursor13	412	560	01/12	>			S 3081 PO
66.41	F3BE3681D Cursor13	302	411	01/12	>		S 1395 NR	S 7564 A
with filter AdBlue/SCR Denoxtronic 1 / con filtro AdBlue/SCR Denoxtronic 1	F3BE3681D Cursor13	302	411	01/12	>			S 4401 U
with filter AdBlue/SCR Denoxtronic 2 / con filtro AdBlue/SCR Denoxtronic 2	F3BE3681D Cursor13	302	411	01/12	>			S 4402 U
dryer filter / filtro essiccatore	F3BE3681D Cursor13	302	411	01/12	>			S 7259 A
VGT filter / filtro VGT	F3BE3681D Cursor13	302	411	01/12	>			S 0VGT A
inner / interno	F3BE3681D Cursor13	302	411	01/12	>			S 7565 A
2 filters / N.2 filtri	F3BE3681D Cursor13	302	411	01/12	>	S 3288 R		
prefilter / prefiltra	F3BE3681D Cursor13	302	411	01/12	>		S 1999 NR	
prefilter SEPAR SWK2000/10/K / prefiltra SEPAR SWK2000/10/K	F3BE3681D Cursor13	302	411	01/12	>		S 6062 NE	
power steering / servosterzo	F3BE3681D Cursor13	302	411	01/12	>			S 3081 PO
66.44	F3BE3681G Cursor13	324	440	01/12	>		S 1395 NR	S 7564 A
with filter AdBlue/SCR Denoxtronic 1 / con filtro AdBlue/SCR Denoxtronic 1	F3BE3681G Cursor13	324	440	01/12	>			S 4401 U
with filter AdBlue/SCR Denoxtronic 2 / con filtro AdBlue/SCR Denoxtronic 2	F3BE3681G Cursor13	324	440	01/12	>			S 4402 U
dryer filter / filtro essiccatore	F3BE3681G Cursor13	324	440	01/12	>			S 7259 A
VGT filter / filtro VGT	F3BE3681G Cursor13	324	440	01/12	>			S 0VGT A
inner / interno	F3BE3681G Cursor13	324	440	01/12	>			S 7565 A
2 filters / N.2 filtri	F3BE3681G Cursor13	324	440	01/12	>	S 3288 R		
prefilter / prefiltra	F3BE3681G Cursor13	324	440	01/12	>		S 1999 NR	



**KW HP****...ASTRA - dump trucks/autocarri ribaltabili**

prefilter SEPAR SWK2000/10/K / prefilto SEPAR SWK2000/10/K	F3BE3681G Cursor13	324	440	01/12	>		S 6062 NE		S 3081 PO
power steering / servosterzo	F3BE3681G Cursor13	324	440	01/12	>				
66.48	F3BE3681F Cursor13	353	480	01/12	>		S 1395 NR	S 7564 A	
with filter AdBlue/SCR Denoxtronic 1 / con filtro AdBlue/SCR Denoxtronic 1	F3BE3681F Cursor13	353	480	01/12	>				S 4401 U
with filter AdBlue/SCR Denoxtronic 2 / con filtro AdBlue/SCR Denoxtronic 2	F3BE3681F Cursor13	353	480	01/12	>				S 4402 U
dryer filter / filtro essiccatore	F3BE3681F Cursor13	353	480	01/12	>				S 7259 A
VGT filter / filtro VGT	F3BE3681F Cursor13	353	480	01/12	>				S 0VGT A
inner / interno	F3BE3681F Cursor13	353	480	01/12	>			S 7565 A	
2 filters / N.2 filtri	F3BE3681F Cursor13	353	480	01/12	>	S 3288 R			
prefilter / prefilto	F3BE3681F Cursor13	353	480	01/12	>		S 1999 NR		
prefilter SEPAR SWK2000/10/K / prefilto SEPAR SWK2000/10/K	F3BE3681F Cursor13	353	480	01/12	>		S 6062 NE		
power steering / servosterzo	F3BE3681F Cursor13	353	480	01/12	>				S 3081 PO
66.52	F3BE3681E Cursor13	382	520	01/12	>		S 1395 NR	S 7564 A	
with filter AdBlue/SCR Denoxtronic 1 / con filtro AdBlue/SCR Denoxtronic 1	F3BE3681E Cursor13	382	520	01/12	>				S 4401 U
with filter AdBlue/SCR Denoxtronic 2 / con filtro AdBlue/SCR Denoxtronic 2	F3BE3681E Cursor13	382	520	01/12	>				S 4402 U
dryer filter / filtro essiccatore	F3BE3681E Cursor13	382	520	01/12	>				S 7259 A
VGT filter / filtro VGT	F3BE3681E Cursor13	382	520	01/12	>				S 0VGT A
inner / interno	F3BE3681E Cursor13	382	520	01/12	>			S 7565 A	
2 filters / N.2 filtri	F3BE3681E Cursor13	382	520	01/12	>	S 3288 R			
prefilter / prefilto	F3BE3681E Cursor13	382	520	01/12	>		S 1999 NR		
prefilter SEPAR SWK2000/10/K / prefilto SEPAR SWK2000/10/K	F3BE3681E Cursor13	382	520	01/12	>		S 6062 NE		
power steering / servosterzo	F3BE3681E Cursor13	382	520	01/12	>				S 3081 PO
66.56	F3BE3681A Cursor13	412	560	01/12	>		S 1395 NR	S 7564 A	
with filter AdBlue/SCR Denoxtronic 1 / con filtro AdBlue/SCR Denoxtronic 1	F3BE3681A Cursor13	412	560	01/12	>				S 4401 U
with filter AdBlue/SCR Denoxtronic 2 / con filtro AdBlue/SCR Denoxtronic 2	F3BE3681A Cursor13	412	560	01/12	>				S 4402 U
dryer filter / filtro essiccatore	F3BE3681A Cursor13	412	560	01/12	>				S 7259 A
VGT filter / filtro VGT	F3BE3681A Cursor13	412	560	01/12	>				S 0VGT A
inner / interno	F3BE3681A Cursor13	412	560	01/12	>			S 7565 A	
2 filters / N.2 filtri	F3BE3681A Cursor13	412	560	01/12	>	S 3288 R			
prefilter / prefilto	F3BE3681A Cursor13	412	560	01/12	>		S 1999 NR		
prefilter SEPAR SWK2000/10/K / prefilto SEPAR SWK2000/10/K	F3BE3681A Cursor13	412	560	01/12	>		S 6062 NE		
power steering / servosterzo	F3BE3681A Cursor13	412	560	01/12	>				S 3081 PO
84.41	F3BE3681D Cursor13	302	411	01/12	>		S 1395 NR	S 7564 A	
with filter AdBlue/SCR Denoxtronic 1 / con filtro AdBlue/SCR Denoxtronic 1	F3BE3681D Cursor13	302	411	01/12	>				S 4401 U
with filter AdBlue/SCR Denoxtronic 2 / con filtro AdBlue/SCR Denoxtronic 2	F3BE3681D Cursor13	302	411	01/12	>				S 4402 U
dryer filter / filtro essiccatore	F3BE3681D Cursor13	302	411	01/12	>				S 7259 A
VGT filter / filtro VGT	F3BE3681D Cursor13	302	411	01/12	>				S 0VGT A
inner / interno	F3BE3681D Cursor13	302	411	01/12	>			S 7565 A	
2 filters / N.2 filtri	F3BE3681D Cursor13	302	411	01/12	>	S 3288 R			
prefilter / prefilto	F3BE3681D Cursor13	302	411	01/12	>		S 1999 NR		
prefilter SEPAR SWK2000/10/K / prefilto SEPAR SWK2000/10/K	F3BE3681D Cursor13	302	411	01/12	>		S 6062 NE		
power steering / servosterzo	F3BE3681D Cursor13	302	411	01/12	>				S 3081 PO
84.44	F3BE3681G Cursor13	324	440	01/12	>		S 1395 NR	S 7564 A	
with filter AdBlue/SCR Denoxtronic 1 / con filtro AdBlue/SCR Denoxtronic 1	F3BE3681G Cursor13	324	440	01/12	>				S 4401 U
with filter AdBlue/SCR Denoxtronic 2 / con filtro AdBlue/SCR Denoxtronic 2	F3BE3681G Cursor13	324	440	01/12	>				S 4402 U
dryer filter / filtro essiccatore	F3BE3681G Cursor13	324	440	01/12	>				S 7259 A
VGT filter / filtro VGT	F3BE3681G Cursor13	324	440	01/12	>				S 0VGT A
inner / interno	F3BE3681G Cursor13	324	440	01/12	>			S 7565 A	
2 filters / N.2 filtri	F3BE3681G Cursor13	324	440	01/12	>	S 3288 R			
prefilter / prefilto	F3BE3681G Cursor13	324	440	01/12	>		S 1999 NR		
prefilter SEPAR SWK2000/10/K / prefilto SEPAR SWK2000/10/K	F3BE3681G Cursor13	324	440	01/12	>		S 6062 NE		
power steering / servosterzo	F3BE3681G Cursor13	324	440	01/12	>				S 3081 PO
84.48	F3BE3681F Cursor13	353	480	01/12	>		S 1395 NR	S 7564 A	
with filter AdBlue/SCR Denoxtronic 1 / con filtro AdBlue/SCR Denoxtronic 1	F3BE3681F Cursor13	353	480	01/12	>				S 4401 U
with filter AdBlue/SCR Denoxtronic 2 / con filtro AdBlue/SCR Denoxtronic 2	F3BE3681F Cursor13	353	480	01/12	>				S 4402 U
dryer filter / filtro essiccatore	F3BE3681F Cursor13	353	480	01/12	>				S 7259 A
VGT filter / filtro VGT	F3BE3681F Cursor13	353	480	01/12	>				S 0VGT A
inner / interno	F3BE3681F Cursor13	353	480	01/12	>			S 7565 A	
2 filters / N.2 filtri	F3BE3681F Cursor13	353	480	01/12	>	S 3288 R			
prefilter / prefilto	F3BE3681F Cursor13	353	480	01/12	>		S 1999 NR		
prefilter SEPAR SWK2000/10/K / prefilto SEPAR SWK2000/10/K	F3BE3681F Cursor13	353	480	01/12	>		S 6062 NE		
power steering / servosterzo	F3BE3681F Cursor13	353	480	01/12	>				S 3081 PO
84.52	F3BE3681E Cursor13	382	520	01/12	>		S 1395 NR	S 7564 A	
with filter AdBlue/SCR Denoxtronic 1 / con filtro AdBlue/SCR Denoxtronic 1	F3BE3681E Cursor13	382	520	01/12	>				S 4401 U
with filter AdBlue/SCR Denoxtronic 2 / con filtro AdBlue/SCR Denoxtronic 2	F3BE3681E Cursor13	382	520	01/12	>				S 4402 U
dryer filter / filtro essiccatore	F3BE3681E Cursor13	382	520	01/12	>				S 7259 A
VGT filter / filtro VGT	F3BE3681E Cursor13	382	520	01/12	>				S 0VGT A

**KW HP****...ASTRA - dump trucks/autocarri ribaltabili**

inner / interno	F3BE3681E Cursor13	382	520	01/12	>			S 7565 A	
2 filters / N.2 filtri	F3BE3681E Cursor13	382	520	01/12	>	S 3288 R			
prefilter / prefiltra	F3BE3681E Cursor13	382	520	01/12	>		S 1999 NR		
prefilter SEPAR SWK2000/10/K / prefiltra SEPAR SWK2000/10/K	F3BE3681E Cursor13	382	520	01/12	>		S 6062 NE		
power steering / servosterzo	F3BE3681E Cursor13	382	520	01/12	>				S 3081 PO
84.56	F3BE3681A Cursor13	412	560	01/12	>		S 1395 NR	S 7564 A	
with filter AdBlue/SCR Denoxtronic 1 / con filtro AdBlue/SCR Denoxtronic 1	F3BE3681A Cursor13	412	560	01/12	>				S 4401 U
with filter AdBlue/SCR Denoxtronic 2 / con filtro AdBlue/SCR Denoxtronic 2	F3BE3681A Cursor13	412	560	01/12	>				S 4402 U
dryer filter / filtro essiccatore	F3BE3681A Cursor13	412	560	01/12	>				S 7259 A
VGT filter / filtro VGT	F3BE3681A Cursor13	412	560	01/12	>				S 0VGT A
inner / interno	F3BE3681A Cursor13	412	560	01/12	>			S 7565 A	
2 filters / N.2 filtri	F3BE3681A Cursor13	412	560	01/12	>	S 3288 R			
prefilter / prefiltra	F3BE3681A Cursor13	412	560	01/12	>		S 1999 NR		
prefilter SEPAR SWK2000/10/K / prefiltra SEPAR SWK2000/10/K	F3BE3681A Cursor13	412	560	01/12	>		S 6062 NE		
power steering / servosterzo	F3BE3681A Cursor13	412	560	01/12	>				S 3081 PO
84.56 E6	F3HFE611A Cursor13 E6	412	560	09/14	>		S 6044 NE	S 7564 A	
to engine No. 24950 / a motore N. 24950	F3HFE611A Cursor13 E6	412	560	09/14	>	S 5102 PE			
some dryer filter / alcuni filtro essiccatore	F3HFE611A Cursor13 E6	412	560	09/14	>				S 7A66 A
with air-conditioner / con climatizzatore	F3HFE611A Cursor13 E6	412	560	09/14	>				S 3078 C
with activated carbon air-conditioner / con climatizzatore, ai carboni attivi	F3HFE611A Cursor13 E6	412	560	09/14	>				S 4346 CA
with filter Urea/Adblue SCR Denoxtronic 2.2 / con filtro Urea/Adblue SCR Denoxtronic 2.2	F3HFE611A Cursor13 E6	412	560	09/14	>				S 4405 U
from engine No. 24951 / da motore N. 24951	F3HFE611A Cursor13 E6	412	560			S 5169 PE			
dryer filter / filtro essiccatore	F3HFE611A Cursor13 E6	412	560	09/14	>				S 7259 A
inner / interno	F3HFE611A Cursor13 E6	412	560	09/14	>			S 7565 A	
prefilter RACOR / prefiltra RACOR	F3HFE611A Cursor13 E6	412	560	09/14	>		S 4474 NR		
prefilter SEPAR SWK2000/10/K / prefiltra SEPAR SWK2000/10/K	F3HFE611A Cursor13 E6	412	560	09/14	>		S 6062 NE		
power steering / servosterzo	F3HFE611A Cursor13 E6	412	560	09/14	>				S 3081 PO
86.44	F3BE3681G Cursor13	324	440	01/12	>		S 1395 NR	S 7564 A	
with filter AdBlue/SCR Denoxtronic 1 / con filtro AdBlue/SCR Denoxtronic 1	F3BE3681G Cursor13	324	440	01/12	>				S 4401 U
with filter AdBlue/SCR Denoxtronic 2 / con filtro AdBlue/SCR Denoxtronic 2	F3BE3681G Cursor13	324	440	01/12	>				S 4402 U
dryer filter / filtro essiccatore	F3BE3681G Cursor13	324	440	01/12	>				S 7259 A
VGT filter / filtro VGT	F3BE3681G Cursor13	324	440	01/12	>				S 0VGT A
inner / interno	F3BE3681G Cursor13	324	440	01/12	>			S 7565 A	
2 filters / N.2 filtri	F3BE3681G Cursor13	324	440	01/12	>	S 3288 R			
prefilter / prefiltra	F3BE3681G Cursor13	324	440	01/12	>		S 1999 NR		
prefilter SEPAR SWK2000/10/K / prefiltra SEPAR SWK2000/10/K	F3BE3681G Cursor13	324	440	01/12	>		S 6062 NE		
power steering / servosterzo	F3BE3681G Cursor13	324	440	01/12	>				S 3081 PO
86.48	F3BE3681F Cursor13	353	480	01/12	>		S 1395 NR	S 7564 A	
with filter AdBlue/SCR Denoxtronic 1 / con filtro AdBlue/SCR Denoxtronic 1	F3BE3681F Cursor13	353	480	01/12	>				S 4401 U
with filter AdBlue/SCR Denoxtronic 2 / con filtro AdBlue/SCR Denoxtronic 2	F3BE3681F Cursor13	353	480	01/12	>				S 4402 U
dryer filter / filtro essiccatore	F3BE3681F Cursor13	353	480	01/12	>				S 7259 A
VGT filter / filtro VGT	F3BE3681F Cursor13	353	480	01/12	>				S 0VGT A
inner / interno	F3BE3681F Cursor13	353	480	01/12	>			S 7565 A	
2 filters / N.2 filtri	F3BE3681F Cursor13	353	480	01/12	>	S 3288 R			
prefilter / prefiltra	F3BE3681F Cursor13	353	480	01/12	>		S 1999 NR		
prefilter SEPAR SWK2000/10/K / prefiltra SEPAR SWK2000/10/K	F3BE3681F Cursor13	353	480	01/12	>		S 6062 NE		
power steering / servosterzo	F3BE3681F Cursor13	353	480	01/12	>				S 3081 PO
86.52	F3BE3681E Cursor13	382	520	01/12	>		S 1395 NR	S 7564 A	
with filter AdBlue/SCR Denoxtronic 1 / con filtro AdBlue/SCR Denoxtronic 1	F3BE3681E Cursor13	382	520	01/12	>				S 4401 U
with filter AdBlue/SCR Denoxtronic 2 / con filtro AdBlue/SCR Denoxtronic 2	F3BE3681E Cursor13	382	520	01/12	>				S 4402 U
dryer filter / filtro essiccatore	F3BE3681E Cursor13	382	520	01/12	>				S 7259 A
VGT filter / filtro VGT	F3BE3681E Cursor13	382	520	01/12	>				S 0VGT A
inner / interno	F3BE3681E Cursor13	382	520	01/12	>			S 7565 A	
2 filters / N.2 filtri	F3BE3681E Cursor13	382	520	01/12	>	S 3288 R			
prefilter / prefiltra	F3BE3681E Cursor13	382	520	01/12	>		S 1999 NR		
prefilter SEPAR SWK2000/10/K / prefiltra SEPAR SWK2000/10/K	F3BE3681E Cursor13	382	520	01/12	>		S 6062 NE		
power steering / servosterzo	F3BE3681E Cursor13	382	520	01/12	>				S 3081 PO
86.56	F3BE3681A Cursor13	412	560	01/12	>		S 1395 NR	S 7564 A	
with filter AdBlue/SCR Denoxtronic 1 / con filtro AdBlue/SCR Denoxtronic 1	F3BE3681A Cursor13	412	560	01/12	>				S 4401 U
with filter AdBlue/SCR Denoxtronic 2 / con filtro AdBlue/SCR Denoxtronic 2	F3BE3681A Cursor13	412	560	01/12	>				S 4402 U
dryer filter / filtro essiccatore	F3BE3681A Cursor13	412	560	01/12	>				S 7259 A
VGT filter / filtro VGT	F3BE3681A Cursor13	412	560	01/12	>				S 0VGT A
inner / interno	F3BE3681A Cursor13	412	560	01/12	>			S 7565 A	
2 filters / N.2 filtri	F3BE3681A Cursor13	412	560	01/12	>	S 3288 R			
prefilter / prefiltra	F3BE3681A Cursor13	412	560	01/12	>		S 1999 NR		
prefilter SEPAR SWK2000/10/K / prefiltra SEPAR SWK2000/10/K	F3BE3681A Cursor13	412	560	01/12	>		S 6062 NE		
power steering / servosterzo	F3BE3681A Cursor13	412	560	01/12	>				S 3081 PO





KW HP



...ASTRA - dump trucks/autocarri ribaltabili

88.48	F3BE3681F Cursor13	353	480	01/12	>		S 1395 NR	S 7564 A	
with filter AdBlue/SCR Denoxtronic 1 / con filtro AdBlue/SCR Denoxtronic 1	F3BE3681F Cursor13	353	480	01/12	>				S 4401 U
with filter AdBlue/SCR Denoxtronic 2 / con filtro AdBlue/SCR Denoxtronic 2	F3BE3681F Cursor13	353	480	01/12	>				S 4402 U
dryer filter / filtro essiccatore	F3BE3681F Cursor13	353	480	01/12	>				S 7259 A
VGT filter / filtro VGT	F3BE3681F Cursor13	353	480	01/12	>				S 0VGT A
inner / interno	F3BE3681F Cursor13	353	480	01/12	>			S 7565 A	
2 filters / N.2 filtri	F3BE3681F Cursor13	353	480	01/12	>	S 3288 R			
prefilter / prefiltra	F3BE3681F Cursor13	353	480	01/12	>		S 1999 NR		
prefilter SEPAR SWK2000/10/K / prefiltra SEPAR SWK2000/10/K	F3BE3681F Cursor13	353	480	01/12	>		S 6062 NE		
power steering / servosterzo	F3BE3681F Cursor13	353	480	01/12	>				S 3081 PO
88.52	F3BE3681E Cursor13	382	520	01/12	>		S 1395 NR	S 7564 A	
with filter AdBlue/SCR Denoxtronic 1 / con filtro AdBlue/SCR Denoxtronic 1	F3BE3681E Cursor13	382	520	01/12	>				S 4401 U
with filter AdBlue/SCR Denoxtronic 2 / con filtro AdBlue/SCR Denoxtronic 2	F3BE3681E Cursor13	382	520	01/12	>				S 4402 U
dryer filter / filtro essiccatore	F3BE3681E Cursor13	382	520	01/12	>				S 7259 A
VGT filter / filtro VGT	F3BE3681E Cursor13	382	520	01/12	>				S 0VGT A
inner / interno	F3BE3681E Cursor13	382	520	01/12	>			S 7565 A	
2 filters / N.2 filtri	F3BE3681E Cursor13	382	520	01/12	>	S 3288 R			
prefilter / prefiltra	F3BE3681E Cursor13	382	520	01/12	>		S 1999 NR		
prefilter SEPAR SWK2000/10/K / prefiltra SEPAR SWK2000/10/K	F3BE3681E Cursor13	382	520	01/12	>		S 6062 NE		
power steering / servosterzo	F3BE3681E Cursor13	382	520	01/12	>				S 3081 PO
88.56	F3BE3681A Cursor13	412	560	01/12	>		S 1395 NR	S 7564 A	
with filter AdBlue/SCR Denoxtronic 1 / con filtro AdBlue/SCR Denoxtronic 1	F3BE3681A Cursor13	412	560	01/12	>				S 4401 U
with filter AdBlue/SCR Denoxtronic 2 / con filtro AdBlue/SCR Denoxtronic 2	F3BE3681A Cursor13	412	560	01/12	>				S 4402 U
dryer filter / filtro essiccatore	F3BE3681A Cursor13	412	560	01/12	>				S 7259 A
VGT filter / filtro VGT	F3BE3681A Cursor13	412	560	01/12	>				S 0VGT A
inner / interno	F3BE3681A Cursor13	412	560	01/12	>			S 7565 A	
2 filters / N.2 filtri	F3BE3681A Cursor13	412	560	01/12	>	S 3288 R			
prefilter / prefiltra	F3BE3681A Cursor13	412	560	01/12	>		S 1999 NR		
prefilter SEPAR SWK2000/10/K / prefiltra SEPAR SWK2000/10/K	F3BE3681A Cursor13	412	560	01/12	>		S 6062 NE		
power steering / servosterzo	F3BE3681A Cursor13	412	560	01/12	>				S 3081 PO

RD Serie

RD 28C	Iveco Cursor10 F3A	260	353	03/05	>		S 4395 NR		
VGT filter / filtro VGT	Iveco Cursor10 F3A	260	353	03/05	>				S 0VGT A
2 filters / N.2 filtri	Iveco Cursor10 F3A	260	353	03/05	>	S 3288 R			
prefilter / prefiltra	Iveco Cursor10 F3A	260	353	03/05	>		S 1999 NR		
RD 32C	Iveco Cursor10 F3A	280	381	03/05	>		S 4395 NR		
VGT filter / filtro VGT	Iveco Cursor10 F3A	280	381	03/05	>				S 0VGT A
2 filters / N.2 filtri	Iveco Cursor10 F3A	280	381	03/05	>	S 3288 R			
prefilter / prefiltra	Iveco Cursor10 F3A	280	381	03/05	>		S 1999 NR		
RD 40 C	Iveco Cursor13 F3B	368	500	03/05	>		S 4395 NR		
VGT filter / filtro VGT	Iveco Cursor13 F3B	368	500	03/05	>				S 0VGT A
2 filters / N.2 filtri	Iveco Cursor13 F3B	368	500	03/05	>	S 3288 R			
prefilter / prefiltra	Iveco Cursor13 F3B	368	500	03/05	>		S 1999 NR		

ASTRA

military vehicles/veicoli militari

40 Serie

SMH 44.31 4x4	Aifo-Iveco Cursor			01/03	>	12/09	S 3288 R	S 4396 NR		
dryer filter / filtro essiccatore	Aifo-Iveco Cursor			01/03	>	12/09				S 7259 A
VGT filter / filtro VGT	Aifo-Iveco Cursor			01/03	>	12/09				S 0VGT A
prefilter / prefiltra	Aifo-Iveco Cursor			01/03	>	12/09		S 0999 NR		
SMH 44.31 4x4 AAT	Aifo-Iveco Cursor			01/03	>	12/09	S 3288 R	S 4396 NR		
dryer filter / filtro essiccatore	Aifo-Iveco Cursor			01/03	>	12/09				S 7259 A
VGT filter / filtro VGT	Aifo-Iveco Cursor			01/03	>	12/09				S 0VGT A
prefilter / prefiltra	Aifo-Iveco Cursor			01/03	>	12/09		S 0999 NR		
SMH 44.31 4x4 ACTL	Aifo-Iveco Cursor			01/03	>	12/09	S 3288 R	S 4396 NR		
dryer filter / filtro essiccatore	Aifo-Iveco Cursor			01/03	>	12/09				S 7259 A
VGT filter / filtro VGT	Aifo-Iveco Cursor			01/03	>	12/09				S 0VGT A
prefilter / prefiltra	Aifo-Iveco Cursor			01/03	>	12/09		S 0999 NR		
SV 44.30 4x4 Avio	Aifo-Iveco						S 5003 DR	S 4329 NR	S 6550 A	
water filter / filtro acqua	Aifo-Iveco									S 8410 AR
dryer filter / filtro essiccatore	Aifo-Iveco									S 7259 A
inner / interno	Aifo-Iveco								S 2840 A	
prefilter / prefiltra	Aifo-Iveco							S 0999 NR		
SV 44.30 4x4 MGB	Aifo-Iveco						S 5003 DR	S 4329 NR	S 6550 A	
water filter / filtro acqua	Aifo-Iveco									S 8410 AR
dryer filter / filtro essiccatore	Aifo-Iveco									S 7259 A
inner / interno	Aifo-Iveco								S 2840 A	



kW HP



...ASTRA - military vehicles/veicoli militari

prefilter / prefiltrro	Aifo-Iveco			S 0999 NR		
60 Serie						
HD6 66.45 6x6						
to frame No. 425262 / a telaio N. 425262	Aifo-Iveco		S 2003 DR	S 4329 NR	S 7222 A	
dryer filter / filtro essiccatore	Aifo-Iveco					S 7259 A
inner to frame No. 425262 / interno a telaio N. 425262	Aifo-Iveco				S 7221 A	
prefilter / prefiltrro	Aifo-Iveco			S 0999 NR		
HD6 66.45 6x6 PFM	Aifo-Iveco		S 2003 DR	S 4329 NR	S 7222 A	
dryer filter / filtro essiccatore	Aifo-Iveco					S 7259 A
inner / interno	Aifo-Iveco				S 7221 A	
prefilter / prefiltrro	Aifo-Iveco			S 0999 NR		
SM 66.40 6x6	Aifo-Iveco Cursor			S 4395 NR		
dryer filter / filtro essiccatore	Aifo-Iveco Cursor					S 7259 A
VGT filter / filtro VGT	Aifo-Iveco Cursor					S 0VGT A
2 filters / N.2 filtri	Aifo-Iveco Cursor		S 3288 R			
prefilter / prefiltrro	Aifo-Iveco Cursor			S 0999 NR		
SM 66.40 6x6 APS	Aifo-Iveco Cursor			S 4395 NR		
dryer filter / filtro essiccatore	Aifo-Iveco Cursor					S 7259 A
VGT filter / filtro VGT	Aifo-Iveco Cursor					S 0VGT A
2 filters / N.2 filtri	Aifo-Iveco Cursor		S 3288 R			
prefilter / prefiltrro	Aifo-Iveco Cursor			S 0999 NR		
SM 66.40 6x6 Avio	Aifo-Iveco Cursor			S 4395 NR		
dryer filter / filtro essiccatore	Aifo-Iveco Cursor					S 7259 A
VGT filter / filtro VGT	Aifo-Iveco Cursor					S 0VGT A
2 filters / N.2 filtri	Aifo-Iveco Cursor		S 3288 R			
prefilter / prefiltrro	Aifo-Iveco Cursor			S 0999 NR		
SMH 66.45 6x6	Aifo-Iveco Cursor			S 4395 NR		
dryer filter / filtro essiccatore	Aifo-Iveco Cursor					S 7259 A
VGT filter / filtro VGT	Aifo-Iveco Cursor					S 0VGT A
2 filters / N.2 filtri	Aifo-Iveco Cursor		S 3288 R			
prefilter / prefiltrro	Aifo-Iveco Cursor			S 0999 NR		
80 Serie						
SM 88.45 IM 8x8 APS	Aifo-Iveco Cursor			S 4395 NR		
dryer filter / filtro essiccatore	Aifo-Iveco Cursor					S 7259 A
VGT filter / filtro VGT	Aifo-Iveco Cursor					S 0VGT A
2 filters / N.2 filtri	Aifo-Iveco Cursor		S 3288 R			
prefilter / prefiltrro	Aifo-Iveco Cursor			S 0999 NR		
SM 88.50 T 8x8	Aifo-Iveco		S 5003 DR	S 4329 NR	S 7218 A	
dryer filter / filtro essiccatore	Aifo-Iveco					S 7259 A
inner / interno	Aifo-Iveco				S 7217 A	
prefilter / prefiltrro	Aifo-Iveco			S 0999 NR		
BM Serie						
BM 201 4x4 MGB	Aifo-Iveco		S 0230 R	S 0710 NR	S 2370 A	
water filter / filtro acqua	Aifo-Iveco					S 8410 AR
BM 309 6x6 PFM	Aifo-Iveco		S 0230 R	S 0710 NR	S 7222 A	
water filter / filtro acqua	Aifo-Iveco					S 8410 AR
dryer filter / filtro essiccatore	Aifo-Iveco					S 7259 A
inner / interno	Aifo-Iveco				S 7221 A	
ATKINSON						
trucks/autocarri						
Borderer						
Borderer						
some / alcuni	Cummins NH 220			S 4510 NR	S 0150 A	
some / alcuni	Cummins NH 220			S 4510 NR	S 6550 A	
some / alcuni	Cummins NH 220			S 4510 NR	S 9990 A	
Borderer						
some / alcuni	Cummins NHC250, NHK220/230			S 4510 NR	S 6550 A	
some / alcuni	Cummins NHC250, NHK220/230			S 4510 NR	S 9990 A	
some / alcuni	Cummins NHC250, NHK220/230			S 4510 NR	S 0150 A	
Borderer						
some / alcuni	Cummins NHK 205			S 4510 NR	S 0150 A	
some / alcuni	Cummins NHK 205			S 4510 NR	S 6550 A	
Borderer						
some / alcuni	Cummins NTK 270			S 4510 NR	S 0150 A	
some / alcuni	Cummins NTK 270			S 4510 NR	S 9990 A	
some / alcuni	Cummins NTK 270			S 4510 NR	S 6550 A	
some / alcuni	Cummins NTK 270			S 4510 NR	S 7011 A	





kW HP



...ATKINSON - trucks/autocarri

Borderer						
some / alcuni	Gardner 6LX, 6LXB				S 0150 A	
some / alcuni	Gardner 6LX, 6LXB				S 0940 A	
Borderer						
some / alcuni	Gardner 8LXB				S 6550 A	
Borderer						
some / alcuni	Rolls Royce Eagle 220 MKIII			S 7111 NC	S 8950 A	
some / alcuni	Rolls Royce Eagle 220 MKIII			S 7111 NC	S 0150 A	
Borderer						
some / alcuni	Rolls Royce Eagle 280 MKIII			S 7111 NC	S 6550 A	
some / alcuni	Rolls Royce Eagle 280 MKIII			S 7111 NC	S 8950 A	
some / alcuni	Rolls Royce Eagle 280 MKIII			S 7111 NC	S 0150 A	
Defender						
Defender						
some / alcuni	Cummins NH 220			S 4510 NR	S 0150 A	
some / alcuni	Cummins NH 220			S 4510 NR	S 6550 A	
some / alcuni	Cummins NH 220			S 4510 NR	S 9990 A	
Defender						
some / alcuni	Cummins NHC250, NHK220/230			S 4510 NR	S 0150 A	
some / alcuni	Cummins NHC250, NHK220/230			S 4510 NR	S 9990 A	
some / alcuni	Cummins NHC250, NHK220/230			S 4510 NR	S 6550 A	
Defender						
some / alcuni	Cummins NHK 205			S 4510 NR	S 0150 A	
Defender						
some / alcuni	Cummins NTK 270			S 4510 NR	S 7011 A	
some / alcuni	Cummins NTK 270			S 4510 NR	S 6550 A	
some / alcuni	Cummins NTK 270			S 4510 NR	S 0150 A	
some / alcuni	Cummins NTK 270			S 4510 NR	S 9990 A	
Defender						
some / alcuni	Gardner 6LX, 6LXB				S 0150 A	
some / alcuni	Gardner 6LX, 6LXB				S 0940 A	
Leader						
Leader						
some / alcuni	Cummins NH 220			S 4510 NR	S 6550 A	
some / alcuni	Cummins NH 220			S 4510 NR	S 9990 A	
some / alcuni	Cummins NH 220			S 4510 NR	S 0150 A	
Leader						
some / alcuni	Cummins NHC250, NHK220/230			S 4510 NR	S 0150 A	
some / alcuni	Cummins NHC250, NHK220/230			S 4510 NR	S 9990 A	
some / alcuni	Cummins NHC250, NHK220/230			S 4510 NR	S 6550 A	
Leader						
some / alcuni	Cummins NHK 205			S 4510 NR	S 0150 A	
some / alcuni	Cummins NHK 205			S 4510 NR	S 6550 A	
Leader						
some / alcuni	Cummins NTK 270			S 4510 NR	S 0150 A	
some / alcuni	Cummins NTK 270			S 4510 NR	S 7011 A	
some / alcuni	Cummins NTK 270			S 4510 NR	S 6550 A	
some / alcuni	Cummins NTK 270			S 4510 NR	S 9990 A	
Leader						
some / alcuni	Gardner 6LX, 6LXB				S 0940 A	
some / alcuni	Gardner 6LX, 6LXB				S 0150 A	
Leader						
some / alcuni	Gardner 8LXB				S 6550 A	
Leader						
some / alcuni	Rolls Royce Eagle 220 MKIII			S 7111 NC	S 0150 A	
some / alcuni	Rolls Royce Eagle 220 MKIII			S 7111 NC	S 8950 A	
Leader						
some / alcuni	Rolls Royce Eagle 280 MKIII			S 7111 NC	S 0150 A	
some / alcuni	Rolls Royce Eagle 280 MKIII			S 7111 NC	S 6550 A	
some / alcuni	Rolls Royce Eagle 280 MKIII			S 7111 NC	S 8950 A	
Omega MKI						
Omega MKI						
some / alcuni					S 0660 A	
some / alcuni					S 7808 A	
Omega MKII						
Omega MKII						
some / alcuni					S 0660 A	



kW HP



...ATKINSON - trucks/autocarri

some / alcuni					S 7808 A	
Omega MKIII						
Omega MKIII					S 7808 A	
some / alcuni					S 0660 A	
some / alcuni						
Searcher						
Searcher						
some / alcuni	Cummins NH 220			S 4510 NR	S 0150 A	
some / alcuni	Cummins NH 220			S 4510 NR	S 9990 A	
some / alcuni	Cummins NH 220			S 4510 NR	S 6550 A	
Searcher						
some / alcuni	Cummins NHC250, NHK220/230			S 4510 NR	S 6550 A	
some / alcuni	Cummins NHC250, NHK220/230			S 4510 NR	S 9990 A	
some / alcuni	Cummins NHC250, NHK220/230			S 4510 NR	S 0150 A	
Searcher						
some / alcuni	Cummins NHK 205			S 4510 NR	S 0150 A	
Searcher						
some / alcuni	Cummins NTK 270			S 4510 NR	S 9990 A	
some / alcuni	Cummins NTK 270			S 4510 NR	S 0150 A	
some / alcuni	Cummins NTK 270			S 4510 NR	S 7011 A	
some / alcuni	Cummins NTK 270			S 4510 NR	S 6550 A	
Searcher						
some / alcuni	Gardner 6LX, 6LXB				S 0150 A	
some / alcuni	Gardner 6LX, 6LXB				S 0940 A	
Venturer						
Venturer						
some / alcuni	Cummins NH 220			S 4510 NR	S 0150 A	
some / alcuni	Cummins NH 220			S 4510 NR	S 9990 A	
some / alcuni	Cummins NH 220			S 4510 NR	S 6550 A	
Venturer						
some / alcuni	Cummins NHC250, NHK220/230			S 4510 NR	S 9990 A	
some / alcuni	Cummins NHC250, NHK220/230			S 4510 NR	S 6550 A	
some / alcuni	Cummins NHC250, NHK220/230			S 4510 NR	S 0150 A	
Venturer						
some / alcuni	Cummins NHK 205			S 4510 NR	S 0150 A	
Venturer						
some / alcuni	Cummins NTK 270			S 4510 NR	S 7011 A	
some / alcuni	Cummins NTK 270			S 4510 NR	S 0150 A	
some / alcuni	Cummins NTK 270			S 4510 NR	S 9990 A	
some / alcuni	Cummins NTK 270			S 4510 NR	S 6550 A	
Venturer						
some / alcuni	Gardner 8LXB				S 6550 A	
Weightmaster						
Weightmaster	Perkins 6.354			S 4380 PO	S 7111 NC	
or / oppure	Perkins 6.354			S 4380 PO	S 7112 NC	
AUWAERTER buses/autobus						
Fernreise-Doppeldecker						
Fernreise-Doppeldecker	Henschel 6R1315			S 8600 R	S 5400 NR	
Fernreise-Doppeldecker	Henschel D523-23			S 8600 R	S 5400 NR	
N Serie						
212	Mercedes Benz			S 8260 PO		S 0450 A
NB Serie						
16 L	Buessing U 11 D				S 0201 N	
2nd passage / 2.passaggio	Buessing U 11 D				S 1411 N	
power steering / servosterzo	Buessing U 11 D					S 8790 PO
16 L	Buessing U 7			S 0530 PO	S 0201 N	
2nd passage / 2.passaggio	Buessing U 7				S 1411 N	
power steering / servosterzo	Buessing U 7					S 8790 PO
Neoplan Jetliner						
N 208	MAN D 0226 MCH/MKH				S 0201 N	
2nd passage / 2.passaggio	MAN D 0226 MCH/MKH				S 1411 N	
N 208	Mercedes Benz OM352A			S 2530 PO	S 2161 N	
N 208	Mercedes Benz OM366A			S 8260 PO	S 2161 N	
NH Serie						
10	Henschel 6R1013				S 0201 N	
2nd passage / 2.passaggio	Henschel 6R1013				S 1411 N	

A





KW HP



...AUWAERTER - buses/autobus

power steering / servosterzo	Henschel 6R1013				S 8790 PO
10 L	Henschel 6R1112		S 8600 R	S 5400 NR	
power steering / servosterzo	Henschel 6R1112				S 8790 PO
12	Henschel 100/150 CV		S 0530 PO	S 0201 N	
2nd passage / 2.passaggio	Henschel 100/150 CV			S 1411 N	
power steering / servosterzo	Henschel 100/150 CV				S 8790 PO
12	Henschel 6R1013			S 0201 N	
2nd passage / 2.passaggio	Henschel 6R1013			S 1411 N	
power steering / servosterzo	Henschel 6R1013				S 8790 PO
12	Henschel 6R1112		S 8600 R	S 5400 NR	
power steering / servosterzo	Henschel 6R1112				S 8790 PO
13	Henschel 6R1112		S 8600 R	S 5400 NR	
power steering / servosterzo	Henschel 6R1112				S 8790 PO
15 V	Henschel 6R1112		S 8600 R	S 5400 NR	
power steering / servosterzo	Henschel 6R1112				S 8790 PO
16	Henschel 100/150 CV		S 0530 PO	S 0201 N	
2nd passage / 2.passaggio	Henschel 100/150 CV			S 1411 N	
power steering / servosterzo	Henschel 100/150 CV				S 8790 PO
16	Henschel 6R1215, 6R1315		S 8600 R	S 5400 NR	
power steering / servosterzo	Henschel 6R1215, 6R1315				S 8790 PO
22	Henschel 6R1215, 6R1315		S 8600 R	S 5400 NR	
power steering / servosterzo	Henschel 6R1215, 6R1315				S 8790 PO
6	Henschel 100/150 CV		S 0530 PO	S 0201 N	
2nd passage / 2.passaggio	Henschel 100/150 CV			S 1411 N	
power steering / servosterzo	Henschel 100/150 CV				S 8790 PO
8	Henschel 100/150 CV		S 0530 PO	S 0201 N	
2nd passage / 2.passaggio	Henschel 100/150 CV			S 1411 N	
power steering / servosterzo	Henschel 100/150 CV				S 8790 PO
8	Henschel 6R1013			S 0201 N	
2nd passage / 2.passaggio	Henschel 6R1013			S 1411 N	
power steering / servosterzo	Henschel 6R1013				S 8790 PO
9	Henschel 100/150 CV		S 0530 PO	S 0201 N	
2nd passage / 2.passaggio	Henschel 100/150 CV			S 1411 N	
power steering / servosterzo	Henschel 100/150 CV				S 8790 PO
9	Henschel 6R1013			S 0201 N	
2nd passage / 2.passaggio	Henschel 6R1013			S 1411 N	
power steering / servosterzo	Henschel 6R1013				S 8790 PO

AVELING BARFORD

dump trucks/autocarri ribaltabili

AB 690

AB 690	Leyland ABV 691			S 7111 NC	
---------------	-----------------	--	--	-----------	--

Centaur Serie

25	Cummins NT855C310		S 3409 R	S 4510 NR	S 9990 A
28	Cummins NT855C310		S 3409 R	S 4510 NR	S 9990 A
35	Caterpillar 1693			S 0810 NR	S 7010 A
drive / trasmissione	Caterpillar 1693				S 3301 PO
35	Detroit Diesel 12V-71		S 3301 PO		S 7010 A
40	Caterpillar 1693			S 0810 NR	S 7010 A
drive / trasmissione	Caterpillar 1693				S 3301 PO
40	Detroit Diesel 12V-71		S 3301 PO		S 7010 A
50	Caterpillar 1693			S 0810 NR	S 7010 A
drive / trasmissione	Caterpillar 1693				S 3301 PO
50	Detroit Diesel 12V-71		S 3301 PO		S 7010 A
50	Detroit Diesel 16V-71		S 3301 PO		S 7010 A
hydraulic / idraulico	Detroit Diesel 16V-71				S 3301 PO

LD Serie

55	A.E.C. AV690		S 5446 PO	S 8381 NC	
some / alcuni	A.E.C. AV690		S 5446 PO	S 7111 NC	
55	A.E.C. AV691		S 5446 PO	S 8381 NC	
some / alcuni	A.E.C. AV691		S 5446 PO	S 7111 NC	

RD Serie

017	Leyland UE 680			S 7111 NC	
some / alcuni	Leyland UE 680			S 8381 NC	S 0940 A
some / alcuni	Leyland UE 680			S 8381 NC	S 7011 A
025	Cummins NT855C		S 3409 R		S 9990 A
filter without drain / filtro senza spurgo	Cummins NT855C			S 4510 NR	
025	Detroit Diesel		S 3301 PO		S 9990 A



KW HP



...AVELING BARFORD - dump trucks/autocarri ribaltabili

drive / trasmissione	Detroit Diesel				S 3301 PO
030	Cummins NT855C		S 3409 R	S 9990 A	
filter without drain / filtro senza spurgo	Cummins NT855C			S 4510 NR	
030	Detroit Diesel		S 3301 PO	S 9990 A	
drive / trasmissione	Detroit Diesel				S 3301 PO
035					
spin-on / avvitabile	Caterpillar 1693			S 0810 NR	
cartridge / immersione	Caterpillar 1693			S 7010 A	
drive / trasmissione	Caterpillar 1693			S 7010 A	
035	Caterpillar 3406B, 3406DITA			S 7010 A	S 3301 PO
drive / trasmissione	Caterpillar 3406B, 3406DITA				S 3301 PO
035	Caterpillar 3408DITA			S 7010 A	
drive / trasmissione	Caterpillar 3408DITA				S 3301 PO
035					
cartridge / immersione	Detroit Diesel 12V-71N		S 3301 PO	S 7010 A	
drive / trasmissione	Detroit Diesel 12V-71N				S 3301 PO
040					
spin-on / avvitabile	Caterpillar 1693			S 0810 NR	
cartridge / immersione	Caterpillar 1693			S 7010 A	
drive / trasmissione	Caterpillar 1693			S 7010 A	
040	Caterpillar 3406B, 3406DITA			S 7010 A	S 3301 PO
drive / trasmissione	Caterpillar 3406B, 3406DITA				S 3301 PO
040	Caterpillar 3408DITA			S 7010 A	
drive / trasmissione	Caterpillar 3408DITA				S 3301 PO
040					
cartridge / immersione	Detroit Diesel 12V-71N		S 3301 PO	S 7010 A	
drive / trasmissione	Detroit Diesel 12V-71N				S 3301 PO
05					
spin-on (3/4" 16 UNF) / avvitabile (3/4" 16 UNF)	Ford 2712E		S 5600 R	S 7111 NC	
spin-on (3/4" 16 UNF) / avvitabile (3/4" 16 UNF)	Ford 2712E		S 5600 R	S 7112 NC	
spin-on (M22 x 1.5) / avvitabile (M22 x 1.5)	Ford 2712E			S 7112 NC	
spin-on (M22 x 1.5) / avvitabile (M22 x 1.5)	Ford 2712E			S 7111 NC	
cartridge / immersione	Ford 2712E		S 6380 PO	S 7112 NC	
cartridge / immersione	Ford 2712E		S 6380 PO	S 7111 NC	
05					
spin-on (3/4" 16 UNF) / avvitabile (3/4" 16 UNF)	Ford 2713E		S 5600 R	S 7112 NC	
spin-on (3/4" 16 UNF) / avvitabile (3/4" 16 UNF)	Ford 2713E		S 5600 R	S 7111 NC	
spin-on (M22 x 1.5) / avvitabile (M22 x 1.5)	Ford 2713E			S 7112 NC	
spin-on (M22 x 1.5) / avvitabile (M22 x 1.5)	Ford 2713E			S 7111 NC	
cartridge / immersione	Ford 2713E		S 4380 PO	S 7112 NC	
cartridge / immersione	Ford 2713E		S 4380 PO	S 6481 N	
cartridge / immersione	Ford 2713E		S 4380 PO	S 7111 NC	
05					
spin-on / avvitabile	Perkins 4.236		S 0420 R	S 7111 NC	
spin-on / avvitabile	Perkins 4.236		S 9400 R	S 7112 NC	
spin-on / avvitabile	Perkins 4.236		S 9400 R	S 7111 NC	
cartridge / immersione	Perkins 4.236		S 3180 PO	S 6481 N	
cartridge / immersione	Perkins 4.236		S 3180 PO	S 7111 NC	
cartridge / immersione	Perkins 4.236		S 4380 PO	S 7112 NC	
050					
cartridge / immersione	Detroit Diesel 16V-71		S 3301 PO	S 7010 A	
drive / trasmissione	Detroit Diesel 16V-71				S 3301 PO
07					
spin-on (3/4" 16 UNF) / avvitabile (3/4" 16 UNF)	Ford 2712E		S 5600 R	S 7112 NC	
spin-on (3/4" 16 UNF) / avvitabile (3/4" 16 UNF)	Ford 2712E		S 5600 R	S 7111 NC	
spin-on (M22 x 1.5) / avvitabile (M22 x 1.5)	Ford 2712E			S 7112 NC	
spin-on (M22 x 1.5) / avvitabile (M22 x 1.5)	Ford 2712E			S 7111 NC	
cartridge / immersione	Ford 2712E		S 6380 PO	S 7111 NC	
cartridge / immersione	Ford 2712E		S 6380 PO	S 7112 NC	
07					
spin-on (3/4" 16 UNF) / avvitabile (3/4" 16 UNF)	Ford 2713E		S 5600 R	S 7111 NC	
spin-on (3/4" 16 UNF) / avvitabile (3/4" 16 UNF)	Ford 2713E		S 5600 R	S 7112 NC	
spin-on (M22 x 1.5) / avvitabile (M22 x 1.5)	Ford 2713E			S 7111 NC	
spin-on (M22 x 1.5) / avvitabile (M22 x 1.5)	Ford 2713E			S 7112 NC	
cartridge / immersione	Ford 2713E		S 4380 PO	S 6481 N	
cartridge / immersione	Ford 2713E		S 4380 PO	S 7112 NC	
cartridge / immersione	Ford 2713E		S 4380 PO	S 7111 NC	

A





KW HP



...AVELING BARFORD - dump trucks/autocarri ribaltabili

07	spin-on / avvitabile	Perkins 4.236		S 0420 R	S 7111 NC		
	spin-on / avvitabile	Perkins 4.236		S 9400 R	S 7112 NC		
	spin-on / avvitabile	Perkins 4.236		S 9400 R	S 7111 NC		
	cartridge / immersione	Perkins 4.236		S 3180 PO	S 6481 N		
	cartridge / immersione	Perkins 4.236		S 4380 PO	S 7112 NC		
	cartridge / immersione	Perkins 4.236		S 3180 PO	S 7111 NC		
135		Detroit Diesel 8V-92T		S 3301 PO			
150		Cummins KTA1150C (KTA19C)		S 3409 R			
	filter without drain / filtro senza spurgo	Cummins KTA1150C (KTA19C)			S 4510 NR		
150	cartridge / immersione	Detroit Diesel 16V-71		S 3301 PO			
17		Leyland UE 680			S 7111 NC	S 0940 A	
	some / alcuni	Leyland UE 680			S 8381 NC	S 7011 A	
33		Caterpillar 3406B, 3406DITA				S 7010 A	
	drive / trasmissione	Caterpillar 3406B, 3406DITA					S 3301 PO
33		Caterpillar 3408DITA				S 7010 A	
	drive / trasmissione	Caterpillar 3408DITA					S 3301 PO
35		Caterpillar 3406B, 3406DITA				S 7010 A	
	drive / trasmissione	Caterpillar 3406B, 3406DITA					S 3301 PO
35		Caterpillar 3408DITA				S 7010 A	
	drive / trasmissione	Caterpillar 3408DITA					S 3301 PO
40		Caterpillar 3406B, 3406DITA				S 7010 A	
	drive / trasmissione	Caterpillar 3406B, 3406DITA					S 3301 PO
40		Caterpillar 3408DITA				S 7010 A	
	drive / trasmissione	Caterpillar 3408DITA					S 3301 PO
40		Detroit Diesel 12V-71N		S 3301 PO		S 7010 A	
	drive / trasmissione	Detroit Diesel 12V-71N					S 3301 PO
50		Cummins KTA1150C (KTA19C)		S 3409 R			
	filter without drain / filtro senza spurgo	Cummins KTA1150C (KTA19C)			S 4510 NR		
55		Cummins KTA1150C (KTA19C)		S 3409 R			
	filter without drain / filtro senza spurgo	Cummins KTA1150C (KTA19C)			S 4510 NR		
RXD Serie							
125		Cummins LT10		S 3409 R			
	filter without drain / filtro senza spurgo	Cummins LT10			S 4510 NR		
25		Cummins LT10		S 3409 R			
	filter without drain / filtro senza spurgo	Cummins LT10			S 4510 NR		
25 (6x4)		Caterpillar 3208			S 0810 NR		
SA							
SA		Dorman 4BK2			S 6181 N		
SD Serie							
011 Beaver		Lister ST1				S 7808 A	
011 Beaver		Petter PH1		S 6180 PO			
	some / alcuni	Petter PH1		S 6180 PO		S 7808 A	
020 Bison		Lister ST2				S 7808 A	
020 Bison		Petter PH2		S 0280 PO			
	some / alcuni	Petter PH2		S 0280 PO		S 7808 A	
06		Lister LT1				S 7808 A	
09 Bantam		Lister ST1				S 7808 A	
Shuttle							
Shuttle		Dorman 4AJ		S 1080 PO			
SL Serie							
SL		Detroit Diesel 4-71	01/51 >	S 3301 PO		S 7023 A	
SL		Leyland UE 600			S 8381 NC	S 0940 A	
	some / alcuni	Leyland UE 600			S 7111 NC	S 7011 A	
SL		Leyland UE 680			S 8381 NC	S 0940 A	
	some / alcuni	Leyland UE 680			S 7111 NC	S 7011 A	
SL 340		Leyland UE 600			S 8381 NC	S 0940 A	
	some / alcuni	Leyland UE 600			S 7111 NC	S 7011 A	
SL 340		Leyland UE 680			S 8381 NC	S 0940 A	
	some / alcuni	Leyland UE 680			S 7111 NC	S 7011 A	
SN Serie							
SN		Detroit Diesel 12V-71		S 3301 PO		S 7010 A	
	some / alcuni				S 8381 NC	S 7010 A	
SN		Rolls Royce C8TFL					
	some / alcuni						
SN 35							



kW HP



...AVELING BARFORD - dump trucks/autocarri ribaltabili

some / alcuni	Detroit Diesel 12V-71		S 3301 PO		S 7010 A	
SR Serie						
SR Minecar	Dorman 4LB		S 5446 PO	S 6181 N		
SR Minecar	Leyland UE 400			S 7111 NC	S 9990 A	
some / alcuni	Leyland UE 400			S 7111 NC	S 7026 A	
SR Minecar	Rolls Royce C4NFR			S 8381 NC	S 7011 A	
ST						
ST	Leyland				S 7026 A	
SXD Serie						
020	Petter PH2		S 0280 PO			
some / alcuni	Petter PH2		S 0280 PO		S 7808 A	
035 Boxer						
spin-on / avvitabile	Perkins D3.152		S 1380 R	S 7112 NC		
spin-on / avvitabile	Perkins D3.152		S 1380 R	S 7111 NC		
cartridge / immersione	Perkins D3.152		S 3180 PO	S 6481 N		
cartridge / immersione	Perkins D3.152		S 3180 PO	S 7112 NC		
cartridge / immersione	Perkins D3.152		S 3180 PO	S 7111 NC		
SY Serie						
SY	Ford 2701E		S 6380 PO	S 7112 NC	S 8950 A	
cartridge / immersione	Ford 2701E		S 6380 PO	S 6481 N	S 8950 A	
or DELPHI / oppure DELPHI	Ford 2701E		S 6380 PO	S 7111 NC	S 8950 A	
SY	Ford 2711E		S 6380 PO	S 7112 NC	S 8950 A	
cartridge / immersione	Ford 2711E		S 6380 PO	S 6481 N	S 8950 A	
or / oppure	Ford 2711E		S 6380 PO	S 7111 NC	S 8950 A	
SY	Perkins 4.236		S 9400 R	S 7111 NC	S 8950 A	
spin-on / avvitabile	Perkins 4.236		S 0420 R	S 7112 NC	S 8950 A	
spin-on / avvitabile	Perkins 4.236		S 3180 PO	S 7111 NC	S 8950 A	
cartridge / immersione	Perkins 4.236		S 1080 PO	S 7112 NC	S 8950 A	
cartridge / immersione	Perkins 4.236		S 4380 PO	S 6481 N	S 8950 A	
SY 6	Ford 2701E		S 6380 PO	S 7112 NC	S 8950 A	
cartridge / immersione	Ford 2701E		S 6380 PO	S 6481 N	S 8950 A	
or DELPHI / oppure DELPHI	Ford 2701E		S 6380 PO	S 7111 NC	S 8950 A	
SY 6	Ford 2711E		S 6380 PO	S 7112 NC	S 8950 A	
cartridge / immersione	Ford 2711E		S 6380 PO	S 6481 N	S 8950 A	
or / oppure	Ford 2711E		S 6380 PO	S 7111 NC	S 8950 A	
SY 6	Perkins 4.236		S 0420 R	S 7112 NC	S 8950 A	
spin-on / avvitabile	Perkins 4.236		S 9400 R	S 7111 NC	S 8950 A	
spin-on / avvitabile	Perkins 4.236		S 3180 PO	S 7111 NC	S 8950 A	
cartridge / immersione	Perkins 4.236		S 1080 PO	S 7112 NC	S 8950 A	
cartridge / immersione	Perkins 4.236		S 4380 PO	S 6481 N	S 8950 A	
SY 7	Ford 2701E		S 6380 PO	S 7112 NC	S 8950 A	
cartridge / immersione	Ford 2701E		S 6380 PO	S 6481 N	S 8950 A	
or DELPHI / oppure DELPHI	Ford 2701E		S 6380 PO	S 7111 NC	S 8950 A	
SY 7	Ford 2711E		S 6380 PO	S 7112 NC	S 8950 A	
cartridge / immersione	Ford 2711E		S 6380 PO	S 6481 N	S 8950 A	
or / oppure	Ford 2711E		S 6380 PO	S 7111 NC	S 8950 A	
SY 7	Perkins 4.236		S 9400 R	S 7111 NC	S 8950 A	
spin-on / avvitabile	Perkins 4.236		S 0420 R	S 7112 NC	S 8950 A	
spin-on / avvitabile	Perkins 4.236		S 3180 PO	S 7111 NC	S 8950 A	
cartridge / immersione	Perkins 4.236		S 4380 PO	S 6481 N	S 8950 A	
cartridge / immersione	Perkins 4.236		S 1080 PO	S 7112 NC	S 8950 A	
AVIA						
1000 Serie						
1000	Perkins 4.128	09/76 > 12/80	S 9710 R	S 9091 N		
1st passage / 1.passaggio	Perkins 4.128	09/76 > 12/80		S 6645 N		
2nd passage / 2.passaggio	Perkins 4.128	09/76 > 12/80		S 7111 NC		
1250	Perkins 4.128	09/76 > 10/84	S 9710 R	S 6645 N		
2nd passage / 2.passaggio	Perkins 4.128	09/76 > 10/84		S 7111 NC		
2nd passage / 2.passaggio	Perkins 4.128	09/76 > 10/84		S 9091 N		
1500	Perkins 4.192	01/72 > 10/84		S 9091 N		
2nd passage / 2.passaggio						

A





KW HP



...AVIA - trucks/autocarri

A

2nd passage / 2.passaggio	Perkins 4.192	01/72 > 10/84		S 7111 NC		
spin-on / avvitabile	Perkins 4.192	01/72 > 10/84	S 9400 R	S 6645 N		
cartridge / immersione	Perkins 4.192	01/72 > 10/84	S 3180 PO	S 6645 N		
1600	Perkins 4.165		S 0420 R	S 7111 NC	S 0650 A	
2000 Serie						
2000	Perkins 4.165		S 0420 R	S 7111 NC	S 0650 A	
2000 F	Perkins 4.165		S 0420 R	S 7111 NC	S 0650 A	
2001	Perkins 4.165		S 0420 R	S 7111 NC	S 0650 A	
2001 RS	Perkins 4.165		S 0420 R	S 7111 NC	S 0650 A	
2001F	Perkins 4.165		S 0420 R	S 7111 NC	S 0650 A	
2002	Perkins 4.165		S 0420 R	S 7111 NC	S 0650 A	
2002 F	Perkins 4.165		S 0420 R	S 7111 NC	S 0650 A	
2002 RS	Perkins 4.165		S 0420 R	S 7111 NC	S 0650 A	
2003	Perkins 4.165		S 0420 R	S 7111 NC	S 0650 A	
2003 RS	Perkins 4.165		S 0420 R	S 7111 NC	S 0650 A	
2500						
2nd passage / 2.passaggio	Perkins 4.192	01/72 > 10/84		S 9091 N		
2nd passage / 2.passaggio	Perkins 4.192	01/72 > 10/84		S 7111 NC		
spin-on / avvitabile	Perkins 4.192	01/72 > 10/84	S 9400 R	S 6645 N		
cartridge / immersione	Perkins 4.192	01/72 > 10/84	S 3180 PO	S 6645 N		
2500						
2nd passage / 2.passaggio	Perkins 4.203	01/72 > 10/84		S 7111 NC		
2nd passage / 2.passaggio	Perkins 4.203	01/72 > 10/84		S 9091 N		
spin-on / avvitabile	Perkins 4.203	01/72 > 10/84	S 9400 R	S 6645 N		
cartridge / immersione	Perkins 4.203	01/72 > 10/84	S 3180 PO	S 6645 N		
2500 B						
2nd passage / 2.passaggio	Perkins 4.203			S 7111 NC		
2nd passage / 2.passaggio	Perkins 4.203			S 9091 N		
spin-on / avvitabile	Perkins 4.203		S 9400 R	S 6645 N		
cartridge / immersione	Perkins 4.203		S 3180 PO	S 6645 N		
2500 R						
2nd passage / 2.passaggio	Perkins 4.203			S 9091 N		
2nd passage / 2.passaggio	Perkins 4.203			S 7111 NC		
spin-on / avvitabile	Perkins 4.203		S 9400 R	S 6645 N		
cartridge / immersione	Perkins 4.203		S 3180 PO	S 6645 N		
2500 R Super						
2nd passage / 2.passaggio	Perkins 4.203			S 7111 NC		
2nd passage / 2.passaggio	Perkins 4.203			S 9091 N		
spin-on / avvitabile	Perkins 4.203		S 9400 R	S 6645 N		
cartridge / immersione	Perkins 4.203		S 3180 PO	S 6645 N		
2500 R Super B						
2nd passage / 2.passaggio	Perkins 4.203			S 9091 N		
2nd passage / 2.passaggio	Perkins 4.203			S 7111 NC		
spin-on / avvitabile	Perkins 4.203		S 9400 R	S 6645 N		
cartridge / immersione	Perkins 4.203		S 3180 PO	S 6645 N		
2500 Super						
2nd passage / 2.passaggio	Perkins 4.203			S 9091 N		
2nd passage / 2.passaggio	Perkins 4.203			S 7111 NC		
spin-on / avvitabile	Perkins 4.203		S 9400 R	S 6645 N		
cartridge / immersione	Perkins 4.203		S 3180 PO	S 6645 N		
3000 Serie						
3500						
2nd passage / 2.passaggio	Perkins 4.192	01/72 > 10/84		S 7111 NC		
2nd passage / 2.passaggio	Perkins 4.192	01/72 > 10/84		S 9091 N		
spin-on / avvitabile	Perkins 4.192	01/72 > 10/84	S 9400 R	S 6645 N		
cartridge / immersione	Perkins 4.192	01/72 > 10/84	S 3180 PO	S 6645 N		
3500 LE						
2nd passage / 2.passaggio	Perkins 4.203			S 7111 NC		
2nd passage / 2.passaggio	Perkins 4.203			S 9091 N		
spin-on / avvitabile	Perkins 4.203		S 9400 R	S 6645 N		
cartridge / immersione	Perkins 4.203		S 3180 PO	S 6645 N		
3500 LE Super						
2nd passage / 2.passaggio	Perkins 4.203			S 9091 N		
2nd passage / 2.passaggio	Perkins 4.203			S 7111 NC		
spin-on / avvitabile	Perkins 4.203		S 9400 R	S 6645 N		
cartridge / immersione	Perkins 4.203		S 3180 PO	S 6645 N		
3500 LE Super B						



kW HP



...AVIA - trucks/autocarri

2nd passage / 2.passaggio	Perkins 4.203			S 7111 NC		
2nd passage / 2.passaggio	Perkins 4.203			S 9091 N		
spin-on / avvitabile	Perkins 4.203		S 9400 R	S 6645 N		
cartridge / immersione	Perkins 4.203		S 3180 PO	S 6645 N		
3500L	Perkins 4.236			S 9091 N		
some / alcuni	Perkins 4.236			S 7111 NC		
3500L-R	Perkins 4.236			S 9091 N		
some / alcuni	Perkins 4.236			S 7111 NC		
3500LE	Perkins 4.236			S 9091 N		
some / alcuni	Perkins 4.236			S 7111 NC		
3500LE-R	Perkins 4.236			S 9091 N		
some / alcuni	Perkins 4.236			S 7111 NC		
3500N	Perkins 4.236			S 9091 N		
some / alcuni	Perkins 4.236			S 7111 NC		
3500SL	Perkins 4.236			S 9091 N		
some / alcuni	Perkins 4.236			S 7111 NC		
3500SL-R	Perkins 4.236			S 9091 N		
some / alcuni	Perkins 4.236			S 7111 NC		
3600	Perkins 4.236			S 7111 NC	S 0650 A	
3600 F	Perkins 4.236			S 7111 NC	S 0650 A	
3601	Perkins 4.236			S 7111 NC	S 0650 A	
3602	Perkins 4.236			S 7111 NC	S 0650 A	
3602F	Perkins 4.236			S 7111 NC	S 0650 A	
3603	Perkins 4.236			S 7111 NC	S 0650 A	
4000 Serie						
4000						
2nd passage / 2.passaggio	Perkins 4.203			S 7111 NC		
2nd passage / 2.passaggio	Perkins 4.203			S 9091 N		
spin-on / avvitabile	Perkins 4.203		S 9400 R	S 6645 N		
cartridge / immersione	Perkins 4.203		S 3180 PO	S 6645 N		
4000L	Perkins 4.236			S 9091 N		
some / alcuni	Perkins 4.236			S 7111 NC		
4000L-R	Perkins 4.236			S 9091 N		
some / alcuni	Perkins 4.236			S 7111 NC		
4000N	Perkins 4.236			S 9091 N		
some / alcuni	Perkins 4.236			S 7111 NC		
4000N-R	Perkins 4.236			S 9091 N		
some / alcuni	Perkins 4.236			S 7111 NC		
4000SL	Perkins 4.236			S 9091 N		
some / alcuni	Perkins 4.236			S 7111 NC		
4000SL-R	Perkins 4.236			S 9091 N		
some / alcuni	Perkins 4.236			S 7111 NC		
5000 Serie						
5000L	Perkins 4.236			S 9091 N		
some / alcuni	Perkins 4.236			S 7111 NC		
5000L-R	Perkins 4.236			S 9091 N		
some / alcuni	Perkins 4.236			S 7111 NC		
5000N	Perkins 4.236			S 9091 N		
some / alcuni	Perkins 4.236			S 7111 NC		
5000N-R	Perkins 4.236			S 9091 N		
some / alcuni	Perkins 4.236			S 7111 NC		
5000SL	Perkins 4.236			S 9091 N		
some / alcuni	Perkins 4.236			S 7111 NC		
5000SL-R	Perkins 4.236			S 9091 N		
some / alcuni	Perkins 4.236			S 7111 NC		
5600	Perkins 4.236			S 7111 NC	S 0650 A	
5600 F	Perkins 4.236			S 7111 NC	S 0650 A	
5601	Perkins 4.236			S 7111 NC	S 0650 A	
5601F	Perkins 4.236			S 7111 NC	S 0650 A	
5602	Perkins 4.236			S 7111 NC	S 0650 A	
5602F	Perkins 4.236			S 7111 NC	S 0650 A	
5603	Perkins 4.236			S 7111 NC	S 0650 A	
6000 Serie						
6500	Perkins 6.305			S 6645 N		
2nd passage / 2.passaggio	Perkins 6.305			S 7111 NC		
2nd passage / 2.passaggio	Perkins 6.305			S 9091 N		
70 Serie						

A





kW HP



...AVIA - trucks/autocarri

A

70 TT	Perkins 4.236				S 7111 NC			
70 TT	Perkins 4.99, 4.108				S 9710 R	S 6645 N		
2nd passage / 2.passaggio	Perkins 4.99, 4.108					S 9091 N		
2nd passage / 2.passaggio	Perkins 4.99, 4.108					S 7111 NC		
7000 Serie								
7000 C	Perkins 6.305					S 6645 N		
2nd passage / 2.passaggio	Perkins 6.305					S 9091 N		
2nd passage / 2.passaggio	Perkins 6.305					S 7111 NC		
7000 L	Perkins 6.305					S 6645 N		
2nd passage / 2.passaggio	Perkins 6.305					S 7111 NC		
2nd passage / 2.passaggio	Perkins 6.305					S 9091 N		
7000 N	Perkins 6.305					S 6645 N		
2nd passage / 2.passaggio	Perkins 6.305					S 9091 N		
2nd passage / 2.passaggio	Perkins 6.305					S 7111 NC		
A Line								
A21 Turbo				11/93 > 06/97	S 7330 R	S 8500 NR	S 0950 A	
A31 Turbo				11/93 > 06/97	S 7330 R	S 8500 NR	S 0950 A	
A60	D421.76.00/01	76	104	09/96 >	S 7330 R	S 8500 NR	S 2450 A	
dryer filter / filtro essiccatore	D421.76.00/01	76	104	09/96 >				S 7259 A
A60	D421.85.00	85	116	09/96 >	S 7330 R	S 8500 NR	S 2450 A	
dryer filter / filtro essiccatore	D421.85.00	85	116	09/96 >				S 7259 A
A75	D421.75.00/01	76	104	09/96 >	S 7330 R	S 8500 NR	S 2450 A	
dryer filter / filtro essiccatore	D421.75.00/01	76	104	09/96 >				S 7259 A
A75	D421.85.00	85	116	09/96 >	S 7330 R	S 8500 NR	S 2450 A	
dryer filter / filtro essiccatore	D421.85.00	85	116	09/96 >				S 7259 A
A80	D421.85	85	116	09/96 >	S 7330 R	S 8500 NR	S 2450 A	
dryer filter / filtro essiccatore	D421.85	85	116	09/96 >				S 7259 A
D Line								
D100	Cummins ISBe 150.30	110	150	04/02 >	S 0620 R	S 2220 NR	S 7506 A	
dryer filter / filtro essiccatore	Cummins ISBe 150.30	110	150	04/02 >				S 7259 A
dryer filter WABCO, right-hand thread / filtro essiccatore WABCO, filetto destro	Cummins ISBe 150.30	110	150	04/02 >				S 7A66 A
D100	Cummins ISBe 170.30	125	170	03/05 >	S 0620 R	S 2220 NR	S 7506 A	
dryer filter / filtro essiccatore	Cummins ISBe 170.30	125	170	03/05 >				S 7259 A
dryer filter WABCO, right-hand thread / filtro essiccatore WABCO, filetto destro	Cummins ISBe 170.30	125	170	03/05 >				S 7A66 A
D100	Cummins ISBe4	152	207	09/09 >	S 0620 R	S 2220 NR	S 7506 A	
with filter SCR-System / con filtro SCR-System	Cummins ISBe4	152	207	09/09 >				S 7A86 A
with filter Urea/Adblue / con filtro Urea/Adblue	Cummins ISBe4	152	207	09/09 >				S 4401 U
dryer filter / filtro essiccatore	Cummins ISBe4	152	207	09/09 >				S 7259 A
dryer filter WABCO, right-hand thread / filtro essiccatore WABCO, filetto destro	Cummins ISBe4	152	207	09/09 >				S 7A66 A
D100	D421.85	85	116	06/00 >		S 8500 NR	S 7506 A	
dryer filter / filtro essiccatore	D421.85	85	116	06/00 >				S 7259 A
dryer filter WABCO, right-hand thread / filtro essiccatore WABCO, filetto destro	D421.85	85	116	06/00 >				S 7A66 A
inner / interno	D421.85	85	116	06/00 >			S 7507 A	
D100	D422.100	100	136	06/01 >		S 8500 NR	S 7506 A	
dryer filter / filtro essiccatore	D422.100	100	136	06/01 >				S 7259 A
dryer filter WABCO, right-hand thread / filtro essiccatore WABCO, filetto destro	D422.100	100	136	06/01 >				S 7A66 A
inner / interno	D422.100	100	136	06/01 >			S 7507 A	
D100 Euro4	Cummins ISBe4	117	160	06/07 >	S 0620 R	S 2220 NR	S 7506 A	
with filter SCR-System / con filtro SCR-System	Cummins ISBe4	117	160	06/07 >				S 7A86 A
with filter Urea/Adblue / con filtro Urea/Adblue	Cummins ISBe4	117	160	06/07 >				S 4401 U
dryer filter / filtro essiccatore	Cummins ISBe4	117	160	06/07 >				S 7259 A
dryer filter WABCO, right-hand thread / filtro essiccatore WABCO, filetto destro	Cummins ISBe4	117	160	06/07 >				S 7A66 A
D100 Euro4	Cummins ISBe4	136	185	06/07 >	S 0620 R	S 2220 NR	S 7506 A	
with filter SCR-System / con filtro SCR-System	Cummins ISBe4	136	185	06/07 >				S 7A86 A
with filter Urea/Adblue / con filtro Urea/Adblue	Cummins ISBe4	136	185	06/07 >				S 4401 U
dryer filter / filtro essiccatore	Cummins ISBe4	136	185	06/07 >				S 7259 A
dryer filter WABCO, right-hand thread / filtro essiccatore WABCO, filetto destro	Cummins ISBe4	136	185	06/07 >				S 7A66 A
D110	Cummins ISBe 150.30	110	150	04/02 >	S 0620 R	S 2220 NR	S 7506 A	
dryer filter / filtro essiccatore	Cummins ISBe 150.30	110	150	04/02 >				S 7259 A
dryer filter WABCO, right-hand thread / filtro essiccatore WABCO, filetto destro	Cummins ISBe 150.30	110	150	04/02 >				S 7A66 A
D110	Cummins ISBe 170.30	125	170	03/05 >	S 0620 R	S 2220 NR	S 7506 A	
dryer filter / filtro essiccatore	Cummins ISBe 170.30	125	170	03/05 >				S 7259 A
dryer filter WABCO, right-hand thread / filtro essiccatore WABCO, filetto destro	Cummins ISBe 170.30	125	170	03/05 >				S 7A66 A
D110	Cummins ISBe4	118	160	06/08 >	S 0620 R	S 2220 NR	S 7506 A	
with filter SCR-System / con filtro SCR-System	Cummins ISBe4	118	160	06/08 >				S 7A86 A
with filter Urea/Adblue / con filtro Urea/Adblue	Cummins ISBe4	118	160	06/08 >				S 4401 U
dryer filter / filtro essiccatore	Cummins ISBe4	118	160	06/08 >				S 7259 A

**KW HP**

...AVIA - trucks/autocarri

dryer filter WABCO, right-hand thread / filtro essiccatore WABCO, filetto destro	Cummins ISBe4	118	160	06/08	>				S 7A66 A
D110	Cummins ISBe4	136	185	06/08	>	S 0620 R	S 2220 NR	S 7506 A	
with filter SCR-System / con filtro SCR-System	Cummins ISBe4	136	185	06/08	>				S 7A86 A
with filter Urea/Adblue / con filtro Urea/Adblue	Cummins ISBe4	136	185	06/08	>				S 4401 U
dryer filter / filtro essiccatore	Cummins ISBe4	136	185	06/08	>				S 7259 A
dryer filter WABCO, right-hand thread / filtro essiccatore WABCO, filetto destro	Cummins ISBe4	136	185	06/08	>				S 7A66 A
D110	Cummins ISBe4	152	207	09/09	>	S 0620 R	S 2220 NR	S 7506 A	
with filter SCR-System / con filtro SCR-System	Cummins ISBe4	152	207	09/09	>				S 7A86 A
with filter Urea/Adblue / con filtro Urea/Adblue	Cummins ISBe4	152	207	09/09	>				S 4401 U
dryer filter / filtro essiccatore	Cummins ISBe4	152	207	09/09	>				S 7259 A
dryer filter WABCO, right-hand thread / filtro essiccatore WABCO, filetto destro	Cummins ISBe4	152	207	09/09	>				S 7A66 A
D120	Cummins ISBe 150.30	110	150	04/02	>	S 0620 R	S 2220 NR	S 7506 A	
dryer filter / filtro essiccatore	Cummins ISBe 150.30	110	150	04/02	>				S 7259 A
dryer filter WABCO, right-hand thread / filtro essiccatore WABCO, filetto destro	Cummins ISBe 150.30	110	150	04/02	>				S 7A66 A
D120	Cummins ISBe 170.30	125	170	03/05	>	S 0620 R	S 2220 NR	S 7506 A	
dryer filter / filtro essiccatore	Cummins ISBe 170.30	125	170	03/05	>				S 7259 A
dryer filter WABCO, right-hand thread / filtro essiccatore WABCO, filetto destro	Cummins ISBe 170.30	125	170	03/05	>				S 7A66 A
D120	Cummins ISBe4	152	207	09/09	>	S 0620 R	S 2220 NR	S 7506 A	
with filter SCR-System / con filtro SCR-System	Cummins ISBe4	152	207	09/09	>				S 7A86 A
with filter Urea/Adblue / con filtro Urea/Adblue	Cummins ISBe4	152	207	09/09	>				S 4401 U
dryer filter / filtro essiccatore	Cummins ISBe4	152	207	09/09	>				S 7259 A
dryer filter WABCO, right-hand thread / filtro essiccatore WABCO, filetto destro	Cummins ISBe4	152	207	09/09	>				S 7A66 A
D120 Euro4	Cummins ISBe4	117	160	06/07	>	S 0620 R	S 2220 NR		
with filter SCR-System / con filtro SCR-System	Cummins ISBe4	117	160	06/07	>				S 7A86 A
with filter Urea/Adblue / con filtro Urea/Adblue	Cummins ISBe4	117	160	06/07	>				S 4401 U
dryer filter / filtro essiccatore	Cummins ISBe4	117	160	06/07	>				S 7259 A
dryer filter WABCO, right-hand thread / filtro essiccatore WABCO, filetto destro	Cummins ISBe4	117	160	06/07	>				S 7A66 A
assembly MANN+HUMMEL / montaggio MANN+HUMMEL	Cummins ISBe4	117	160	06/07	> 08/12			S 7506 A	
D120 Euro4	Cummins ISBe4	136	185	06/07	>	S 0620 R	S 2220 NR	S 7506 A	
with filter SCR-System / con filtro SCR-System	Cummins ISBe4	136	185	06/07	>				S 7A86 A
with filter Urea/Adblue / con filtro Urea/Adblue	Cummins ISBe4	136	185	06/07	>				S 4401 U
dryer filter / filtro essiccatore	Cummins ISBe4	136	185	06/07	>				S 7259 A
dryer filter WABCO, right-hand thread / filtro essiccatore WABCO, filetto destro	Cummins ISBe4	136	185	06/07	>				S 7A66 A
D60	Cummins ISBe 150.30	110	150	04/02	>	S 0620 R	S 2220 NR	S 7506 A	
dryer filter / filtro essiccatore	Cummins ISBe 150.30	110	150	04/02	>				S 7259 A
dryer filter WABCO, right-hand thread / filtro essiccatore WABCO, filetto destro	Cummins ISBe 150.30	110	150	04/02	>				S 7A66 A
D60	D421.85	85	116	06/00	>		S 8500 NR	S 7506 A	
dryer filter / filtro essiccatore	D421.85	85	116	06/00	>				S 7259 A
dryer filter WABCO, right-hand thread / filtro essiccatore WABCO, filetto destro	D421.85	85	116	06/00	>				S 7A66 A
inner / interno	D421.85	85	116	06/00	>			S 7507 A	
D60	D422.100	100	136	06/01	>		S 8500 NR	S 7506 A	
dryer filter / filtro essiccatore	D422.100	100	136	06/01	>				S 7259 A
dryer filter WABCO, right-hand thread / filtro essiccatore WABCO, filetto destro	D422.100	100	136	06/01	>				S 7A66 A
inner / interno	D422.100	100	136	06/01	>			S 7507 A	
D65	D421.85	85	116	06/00	>		S 8500 NR	S 7506 A	
dryer filter / filtro essiccatore	D421.85	85	116	06/00	>				S 7259 A
dryer filter WABCO, right-hand thread / filtro essiccatore WABCO, filetto destro	D421.85	85	116	06/00	>				S 7A66 A
inner / interno	D421.85	85	116	06/00	>			S 7507 A	
D65	D422.100	100	136	06/01	>		S 8500 NR	S 7506 A	
dryer filter / filtro essiccatore	D422.100	100	136	06/01	>				S 7259 A
dryer filter WABCO, right-hand thread / filtro essiccatore WABCO, filetto destro	D422.100	100	136	06/01	>				S 7A66 A
inner / interno	D422.100	100	136	06/01	>			S 7507 A	
D70	D421.85	85	116	06/00	>		S 8500 NR	S 7506 A	
dryer filter / filtro essiccatore	D421.85	85	116	06/00	>				S 7259 A
dryer filter WABCO, right-hand thread / filtro essiccatore WABCO, filetto destro	D421.85	85	116	06/00	>				S 7A66 A
inner / interno	D421.85	85	116	06/00	>			S 7507 A	
D70	D422.100	100	136	06/01	>		S 8500 NR	S 7506 A	
dryer filter / filtro essiccatore	D422.100	100	136	06/01	>				S 7259 A
dryer filter WABCO, right-hand thread / filtro essiccatore WABCO, filetto destro	D422.100	100	136	06/01	>				S 7A66 A
inner / interno	D422.100	100	136	06/01	>			S 7507 A	
D75	Cummins ISBe 150.30	110	150	04/02	>	S 0620 R	S 2220 NR	S 7506 A	
dryer filter / filtro essiccatore	Cummins ISBe 150.30	110	150	04/02	>				S 7259 A
dryer filter WABCO, right-hand thread / filtro essiccatore WABCO, filetto destro	Cummins ISBe 150.30	110	150	04/02	>				S 7A66 A
D75	Cummins ISBe 170.30	125	170	03/05	>	S 0620 R	S 2220 NR	S 7506 A	
dryer filter / filtro essiccatore	Cummins ISBe 170.30	125	170	03/05	>				S 7259 A
dryer filter WABCO, right-hand thread / filtro essiccatore WABCO, filetto destro	Cummins ISBe 170.30	125	170	03/05	>				S 7A66 A
D75	D421.85	85	116	06/00	>		S 8500 NR	S 7506 A	





KW HP



...AVIA - trucks/autocarri



dryer filter / filtro essiccatore	D421.85	85	116	06/00	>				S 7259 A
dryer filter WABCO, right-hand thread / filtro essiccatore WABCO, filetto destro	D421.85	85	116	06/00	>				S 7A66 A
inner / interno	D421.85	85	116	06/00	>			S 7507 A	
D75	D422.100	100	136	06/01	>		S 8500 NR	S 7506 A	
dryer filter / filtro essiccatore	D422.100	100	136	06/01	>				S 7259 A
dryer filter WABCO, right-hand thread / filtro essiccatore WABCO, filetto destro	D422.100	100	136	06/01	>				S 7A66 A
inner / interno	D422.100	100	136	06/01	>			S 7507 A	
D75.160	Cummins ISB4.5E5160	117	160	09/12	>	S 0620 R	S 2220 NR		
with filter SCR-System / con filtro SCR-System	Cummins ISB4.5E5160	117	160	09/12	>				S 7A86 A
with filter Urea/Adblue / con filtro Urea/Adblue	Cummins ISB4.5E5160	117	160	09/12	>				S 4401 U
dryer filter / filtro essiccatore	Cummins ISB4.5E5160	117	160	09/12	>				S 7259 A
dryer filter WABCO, right-hand thread / filtro essiccatore WABCO, filetto destro	Cummins ISB4.5E5160	117	160	09/12	>				S 7A66 A
D80	Cummins ISBe4	118	160	06/08	>	S 0620 R	S 2220 NR	S 7506 A	
with filter SCR-System / con filtro SCR-System	Cummins ISBe4	118	160	06/08	>				S 7A86 A
with filter Urea/Adblue / con filtro Urea/Adblue	Cummins ISBe4	118	160	06/08	>				S 4401 U
dryer filter / filtro essiccatore	Cummins ISBe4	118	160	06/08	>				S 7259 A
dryer filter WABCO, right-hand thread / filtro essiccatore WABCO, filetto destro	Cummins ISBe4	118	160	06/08	>				S 7A66 A
D80	Cummins ISBe4	136	185	06/08	>	S 0620 R	S 2220 NR	S 7506 A	
with filter SCR-System / con filtro SCR-System	Cummins ISBe4	136	185	06/08	>				S 7A86 A
with filter Urea/Adblue / con filtro Urea/Adblue	Cummins ISBe4	136	185	06/08	>				S 4401 U
dryer filter / filtro essiccatore	Cummins ISBe4	136	185	06/08	>				S 7259 A
dryer filter WABCO, right-hand thread / filtro essiccatore WABCO, filetto destro	Cummins ISBe4	136	185	06/08	>				S 7A66 A
D80	Cummins ISBe4	152	207	09/09	>	S 0620 R	S 2220 NR	S 7506 A	
with filter SCR-System / con filtro SCR-System	Cummins ISBe4	152	207	09/09	>				S 7A86 A
with filter Urea/Adblue / con filtro Urea/Adblue	Cummins ISBe4	152	207	09/09	>				S 4401 U
dryer filter / filtro essiccatore	Cummins ISBe4	152	207	09/09	>				S 7259 A
dryer filter WABCO, right-hand thread / filtro essiccatore WABCO, filetto destro	Cummins ISBe4	152	207	09/09	>				S 7A66 A
D90	Cummins ISBe 150.30	110	150	04/02	>	S 0620 R	S 2220 NR	S 7506 A	
dryer filter / filtro essiccatore	Cummins ISBe 150.30	110	150	04/02	>				S 7259 A
dryer filter WABCO, right-hand thread / filtro essiccatore WABCO, filetto destro	Cummins ISBe 150.30	110	150	04/02	>				S 7A66 A
D90	Cummins ISBe 170.30	125	170	03/05	>	S 0620 R	S 2220 NR	S 7506 A	
dryer filter / filtro essiccatore	Cummins ISBe 170.30	125	170	03/05	>				S 7259 A
dryer filter WABCO, right-hand thread / filtro essiccatore WABCO, filetto destro	Cummins ISBe 170.30	125	170	03/05	>				S 7A66 A
D90	D421.85	85	116	06/00	>		S 8500 NR	S 7506 A	
dryer filter / filtro essiccatore	D421.85	85	116	06/00	>				S 7259 A
dryer filter WABCO, right-hand thread / filtro essiccatore WABCO, filetto destro	D421.85	85	116	06/00	>				S 7A66 A
inner / interno	D421.85	85	116	06/00	>			S 7507 A	
D90	D422.100	100	136	06/01	>		S 8500 NR	S 7506 A	
dryer filter / filtro essiccatore	D422.100	100	136	06/01	>				S 7259 A
dryer filter WABCO, right-hand thread / filtro essiccatore WABCO, filetto destro	D422.100	100	136	06/01	>				S 7A66 A
inner / interno	D422.100	100	136	06/01	>			S 7507 A	

AVIA

buses/autobus

20 Serie

20									
2nd passage / 2.passaggio	Perkins 4.203			01/63	> 12/80			S 7111 NC	
2nd passage / 2.passaggio	Perkins 4.203			01/63	> 12/80			S 9091 N	
spin-on / avvitabile	Perkins 4.203			01/63	> 12/80	S 9400 R		S 6645 N	
cartridge / immersione	Perkins 4.203			01/63	> 12/80	S 3180 PO		S 6645 N	

26									
2nd passage / 2.passaggio	Perkins 4.203			01/63	> 12/80			S 7111 NC	
2nd passage / 2.passaggio	Perkins 4.203			01/63	> 12/80			S 9091 N	
spin-on / avvitabile	Perkins 4.203			01/63	> 12/80	S 9400 R		S 6645 N	
cartridge / immersione	Perkins 4.203			01/63	> 12/80	S 3180 PO		S 6645 N	

2000 Serie

2500									
2nd passage / 2.passaggio	Perkins 4.203			01/63	> 12/80			S 7111 NC	
2nd passage / 2.passaggio	Perkins 4.203			01/63	> 12/80			S 9091 N	
spin-on / avvitabile	Perkins 4.203			01/63	> 12/80	S 9400 R		S 6645 N	
cartridge / immersione	Perkins 4.203			01/63	> 12/80	S 3180 PO		S 6645 N	

4000 Serie

4006									
2nd passage / 2.passaggio	Perkins 6.305			01/68	> 12/80			S 7111 NC	
2nd passage / 2.passaggio	Perkins 6.305			01/68	> 12/80			S 9091 N	
spin-on / avvitabile	Perkins 6.305			01/68	> 12/80	S 9400 R		S 6645 N	
4006 C									
2nd passage / 2.passaggio	Perkins 6.305			01/68	> 12/80			S 7111 NC	



KW HP



...AVIA - buses/autobus

2nd passage / 2.passaggio spin-on / avvitabile	Perkins 6.305 Perkins 6.305	01/68 > 12/80 01/68 > 12/80		S 9400 R	S 9091 N S 6645 N			
8000 Serie								
8000 spin-on / avvitabile cartridge / immersione	Perkins 6.354, 6.354.3 Perkins 6.354, 6.354.3 Perkins 6.354, 6.354.3	01/75 > 12/80 01/75 > 12/80 01/75 > 12/80		S 9710 R S 4380 PO	S 7111 NC			
8000 MT spin-on / avvitabile cartridge / immersione	Perkins 6.354, 6.354.3 Perkins 6.354, 6.354.3 Perkins 6.354, 6.354.3	01/75 > 12/80 01/75 > 12/80 01/75 > 12/80		S 9710 R S 4380 PO	S 7111 NC			
AWD trucks/autocarri								
M Serie								
M 1120 4 x 4 Turbo	Bedford 330 cu. in.			S 4380 PO	S 6481 N			
M 1120 4 x 4 Turbo	Bedford 500 cu. in.				S 8111 NC			
MT 12-18 or / oppure	Perkins Phaser 6.180 Ti 134 180 Perkins Phaser 6.180 Ti 134 180	03/88 > 03/88 >		S 9400 R S 9400 R	S 7111 NC S 7112 NC			
MTM 40-30 8 x 8	Caterpillar 3306 B 224 300	03/88 >		S 0900 R	S 0810 NR			
TL Serie								
10-14 or / oppure	Perkins Phaser 6.145 T 107 143 Perkins Phaser 6.145 T 107 143	08/89 > 08/89 >		S 9400 R S 9400 R	S 7111 NC S 7112 NC			
12-16 or / oppure	Perkins Phaser 6.160 T 119 160 Perkins Phaser 6.160 T 119 160	01/88 > 01/88 >		S 9400 R S 9400 R	S 7111 NC S 7112 NC			
13-16 or / oppure	Perkins Phaser 6.160 T 119 160 Perkins Phaser 6.160 T 119 160	09/88 > 09/88 >		S 9400 R S 9400 R	S 7111 NC S 7112 NC			
17-18 or / oppure	Perkins Phaser 6.180 Ti 134 180 Perkins Phaser 6.180 Ti 134 180	03/89 > 03/89 >		S 9400 R S 9400 R	S 7111 NC S 7112 NC			
18-16 or / oppure	Perkins Phaser 6.160 T 119 160 Perkins Phaser 6.160 T 119 160	01/88 > 01/88 >		S 9400 R S 9400 R	S 7111 NC S 7112 NC			
18-18 or / oppure	Perkins Phaser 6.180 Ti Perkins Phaser 6.180 Ti			S 9400 R S 9400 R	S 7111 NC S 7112 NC			
20-16 or / oppure	Perkins Phaser 6.160 T Perkins Phaser 6.160 T			S 9400 R S 9400 R	S 7111 NC S 7112 NC			
20-18 or / oppure	Perkins Phaser 6.180 Ti Perkins Phaser 6.180 Ti			S 9400 R S 9400 R	S 7111 NC S 7112 NC			
21-16 or / oppure	Perkins Phaser 6.160 T 119 160 Perkins Phaser 6.160 T 119 160	01/88 > 01/88 >		S 9400 R S 9400 R	S 7111 NC S 7112 NC			
21-16 or / oppure	Perkins Phaser 6.180 Ti Perkins Phaser 6.180 Ti			S 9400 R S 9400 R	S 7111 NC S 7112 NC			
21-18 or / oppure	Perkins Phaser 6.160 T Perkins Phaser 6.160 T			S 9400 R S 9400 R	S 7111 NC S 7112 NC			
21-18 or / oppure	Perkins Phaser 6.180 Ti Perkins Phaser 6.180 Ti			S 9400 R S 9400 R	S 7111 NC S 7112 NC			
7-14 or / oppure	Perkins Phaser 6.145 T 107 143 Perkins Phaser 6.145 T 107 143	01/88 > 01/88 >		S 9400 R S 9400 R	S 7111 NC S 7112 NC			
8-14 or / oppure	Perkins Phaser 6.145 T 107 143 Perkins Phaser 6.145 T 107 143	08/88 > 08/88 >		S 9400 R S 9400 R	S 7111 NC S 7112 NC			
9-14 or / oppure	Perkins Phaser 6.145 T 107 143 Perkins Phaser 6.145 T 107 143	01/88 > 01/88 >		S 9400 R S 9400 R	S 7111 NC S 7112 NC			
AYATS buses/autobus								
Atlas 2								
12.250 inner / interno prefilter / prefiltrato power steering / servosterzo	MAN D2676LOH Euro4 353 480 MAN D2676LOH Euro4 353 480 MAN D2676LOH Euro4 353 480 MAN D2676LOH Euro4 353 480	09/06 > 09/06 > 09/06 > 09/06 >		S 5046 PE	S 6011 NE S 6088 NE	S 7644 A S 7646 A	S 3081 PO	
Bravo								
A34 2 filters / N.2 filtri prefilter SEPAR 2000 / prefiltrato SEPAR 2000 power steering / servosterzo	MAN D2866LUH20 228 310 MAN D2866LUH20 228 310 MAN D2866LUH20 228 310 MAN D2866LUH20 228 310	09/01 > 09/01 > 09/01 > 09/01 >		S 7260 PO	S 4378 NR S 6063 NE	S 7651 A	S 3081 PO	
A34 2 filters / N.2 filtri prefilter SEPAR 2000 / prefiltrato SEPAR 2000 power steering / servosterzo	MAN D2866LUH25 265 360 MAN D2866LUH25 265 360 MAN D2866LUH25 265 360 MAN D2866LUH25 265 360	09/01 > 09/01 > 09/01 > 09/01 >		S 7260 PO	S 4378 NR S 6063 NE	S 7651 A	S 3081 PO	

A





kW HP



BEDFORD

trucks/autocarri

EJM3

EJM3	330 cu.in. Diesel	01/74 >	S 4380 PO	S 7111 NC		
------	-------------------	---------	-----------	-----------	--	--

EJN3

EJN3	330 cu.in. Diesel	01/74 >	S 4380 PO	S 7111 NC		
------	-------------------	---------	-----------	-----------	--	--

J1

J1	200 cu.in., 220 cu.in.	01/58 > 12/62	S 4380 PO	S 8381 NC		
	200 cu.in., 220 cu.in.	01/63 >	S 4380 PO	S 7111 NC		
with pump SIMMS / con pompa SIMMS	200 cu.in., 220 cu.in.	01/63 >	S 4380 PO	S 6481 N		

J1

J1	some / alcuni	214 cu.in.	01/63 >	S 4380 PO	S 6481 N	
----	---------------	------------	---------	-----------	----------	--

J2

J2	200 cu.in., 220 cu.in.	01/58 > 12/62	S 4380 PO	S 8381 NC		
	200 cu.in., 220 cu.in.	01/63 >	S 4380 PO	S 7111 NC		
with pump SIMMS / con pompa SIMMS	200 cu.in., 220 cu.in.	01/63 >	S 4380 PO	S 6481 N		

J2

J2	some / alcuni	214 cu.in.	01/63 >	S 4380 PO	S 6481 N	
----	---------------	------------	---------	-----------	----------	--

J3

J3	200 cu.in., 220 cu.in.	01/58 > 12/62	S 4380 PO	S 8381 NC		
	200 cu.in., 220 cu.in.	01/63 >	S 4380 PO	S 7111 NC		
with pump SIMMS / con pompa SIMMS	200 cu.in., 220 cu.in.	01/63 >	S 4380 PO	S 6481 N		

J3

J3	some / alcuni	214 cu.in.	01/63 >	S 4380 PO	S 6481 N	
----	---------------	------------	---------	-----------	----------	--

J4

J4	some / alcuni	214 cu.in.	01/63 >	S 4380 PO	S 6481 N	
----	---------------	------------	---------	-----------	----------	--

J4

J4	300 cu.in.	01/57 >	S 4380 PO			
----	------------	---------	-----------	--	--	--

J4

J4	300, 330 cu.in.	01/57 > 12/62	S 4380 PO	S 8381 NC		
	300, 330 cu.in.	01/63 >	S 4380 PO	S 7111 NC		
with pump SIMMS / con pompa SIMMS	300, 330 cu.in.	01/63 >	S 4380 PO	S 6481 N		

J5

J5	some / alcuni	214 cu.in.	01/63 >	S 4380 PO	S 6481 N	
----	---------------	------------	---------	-----------	----------	--

J5

J5	300 cu.in.	01/57 >	S 4380 PO			
----	------------	---------	-----------	--	--	--

J5

J5	300, 330 cu.in.	01/57 > 12/62	S 4380 PO	S 8381 NC		
	300, 330 cu.in.	01/63 >	S 4380 PO	S 7111 NC		
with pump SIMMS / con pompa SIMMS	300, 330 cu.in.	01/63 >	S 4380 PO	S 6481 N		

J6

J6	300 cu.in.	01/57 >	S 4380 PO			
----	------------	---------	-----------	--	--	--

J6

J6	300, 330 cu.in.	01/57 > 12/62	S 4380 PO	S 8381 NC		
	300, 330 cu.in.	01/63 >	S 4380 PO	S 7111 NC		
with pump SIMMS / con pompa SIMMS	300, 330 cu.in.	01/63 >	S 4380 PO	S 6481 N		

KA

KA	200 cu.in., 220 cu.in.	01/58 > 12/62	S 4380 PO	S 8381 NC		
	200 cu.in., 220 cu.in.	01/63 >	S 4380 PO	S 7111 NC		
with pump SIMMS / con pompa SIMMS	200 cu.in., 220 cu.in.	01/63 >	S 4380 PO	S 6481 N		

KB

KB	200 cu.in., 220 cu.in.	01/58 > 12/62	S 4380 PO	S 8381 NC		
	200 cu.in., 220 cu.in.	01/63 >	S 4380 PO	S 7111 NC		
with pump SIMMS / con pompa SIMMS	200 cu.in., 220 cu.in.	01/63 >	S 4380 PO	S 6481 N		

KB

KB	some / alcuni	214 cu.in.	01/63 >	S 4380 PO	S 6481 N	
----	---------------	------------	---------	-----------	----------	--

KC

KC	200 cu.in., 220 cu.in.	01/58 > 12/62	S 4380 PO	S 8381 NC		
	200 cu.in., 220 cu.in.	01/63 >	S 4380 PO	S 7111 NC		
with pump SIMMS / con pompa SIMMS	200 cu.in., 220 cu.in.	01/63 >	S 4380 PO	S 6481 N		

KC

KC	some / alcuni	214 cu.in.	01/63 >	S 4380 PO	S 6481 N	
----	---------------	------------	---------	-----------	----------	--

KCP

KCP	some / alcuni	214 cu.in.	01/63 >	S 4380 PO	S 6481 N	
-----	---------------	------------	---------	-----------	----------	--

KD

KD	200 cu.in., 220 cu.in.	01/58 > 12/62	S 4380 PO	S 8381 NC		
	200 cu.in., 220 cu.in.	01/63 >	S 4380 PO	S 7111 NC		
with pump SIMMS / con pompa SIMMS	200 cu.in., 220 cu.in.	01/63 >	S 4380 PO	S 6481 N		

KD

KD	some / alcuni	214 cu.in.	01/63 >	S 4380 PO	S 6481 N	
----	---------------	------------	---------	-----------	----------	--

KD

KD	300 cu.in.	01/57 >	S 4380 PO			
----	------------	---------	-----------	--	--	--



kW HP



...BEDFORD - trucks/autocarri

KD	300, 330 cu.in.	01/57 > 12/62	S 4380 PO	S 8381 NC		
with pump SIMMS / con pompa SIMMS	300, 330 cu.in.	01/63 >	S 4380 PO	S 7111 NC		
	300, 330 cu.in.	01/63 >	S 4380 PO	S 6481 N		
KDS						
KDS	300, 330 cu.in.	01/57 > 12/62	S 4380 PO	S 8381 NC		
	300, 330 cu.in.	01/63 >	S 4380 PO	S 7111 NC		
with pump SIMMS / con pompa SIMMS	300, 330 cu.in.	01/63 >	S 4380 PO	S 6481 N		
KE						
KE	200 cu.in., 220 cu.in.	01/58 > 12/62	S 4380 PO	S 8381 NC		
	200 cu.in., 220 cu.in.	01/63 >	S 4380 PO	S 7111 NC		
with pump SIMMS / con pompa SIMMS	200 cu.in., 220 cu.in.	01/63 >	S 4380 PO	S 6481 N		
KE	some / alcuni	214 cu.in.	01/63 >	S 4380 PO	S 6481 N	
KE	300, 330 cu.in.	01/57 > 12/62	S 4380 PO	S 8381 NC		
	300, 330 cu.in.	01/63 >	S 4380 PO	S 7111 NC		
with pump SIMMS / con pompa SIMMS	300, 330 cu.in.	01/63 >	S 4380 PO	S 6481 N		
KF						
KF	200 cu.in., 220 cu.in.	01/58 > 12/62	S 4380 PO	S 8381 NC		
	200 cu.in., 220 cu.in.	01/63 >	S 4380 PO	S 7111 NC		
with pump SIMMS / con pompa SIMMS	200 cu.in., 220 cu.in.	01/63 >	S 4380 PO	S 6481 N		
KF	300 cu.in.	01/57 >	S 4380 PO			
KF	300, 330 cu.in.	01/57 > 12/62	S 4380 PO	S 8381 NC		
	300, 330 cu.in.	01/63 >	S 4380 PO	S 7111 NC		
with pump SIMMS / con pompa SIMMS	300, 330 cu.in.	01/63 >	S 4380 PO	S 6481 N		
KFA13						
KFA13	Leyland 370 Diesel	01/59 >	S 4380 PO	S 8381 NC		
some / alcuni	Leyland 370 Diesel	01/59 >	S 4380 PO	S 7111 NC		
KG						
KG	300 cu.in.	01/57 >	S 4380 PO			
KG	300, 330 cu.in.	01/57 > 12/62	S 4380 PO	S 8381 NC		
	300, 330 cu.in.	01/63 >	S 4380 PO	S 7111 NC		
with pump SIMMS / con pompa SIMMS	300, 330 cu.in.	01/63 >	S 4380 PO	S 6481 N		
KG	381 cu.in.	01/67 >	S 4380 PO	S 7111 NC		
with pump SIMMS / con pompa SIMMS	381 cu.in.	01/67 >	S 4380 PO	S 6481 N		
KG	466 cu.in.	01/67 >	S 4380 PO	S 7111 NC		
with pump SIMMS / con pompa SIMMS	466 cu.in.	01/67 >	S 4380 PO	S 6481 N		
KG	60170		S 4380 PO			
KG	Leyland 370 Diesel	01/59 >	S 4380 PO	S 8381 NC		
KGA13						
KGA13	Leyland 370 Diesel	01/59 >	S 4380 PO	S 8381 NC		
some / alcuni	Leyland 370 Diesel	01/59 >	S 4380 PO	S 7111 NC		
KGA60						
KGA60	381 cu.in.	01/67 >	S 4380 PO	S 7111 NC		
with pump SIMMS / con pompa SIMMS	381 cu.in.	01/67 >	S 4380 PO	S 6481 N		
KGT						
KGT	300, 330 cu.in.	01/57 > 12/62	S 4380 PO	S 8381 NC		
	300, 330 cu.in.	01/63 >	S 4380 PO	S 7111 NC		
with pump SIMMS / con pompa SIMMS	300, 330 cu.in.	01/63 >	S 4380 PO	S 6481 N		
KH						
KH	466 cu.in.	01/67 >	S 4380 PO	S 7111 NC		
with pump SIMMS / con pompa SIMMS	466 cu.in.	01/67 >	S 4380 PO	S 6481 N		
KH	60170		S 4380 PO			
KH	Leyland 400 Diesel	01/59 >	S 4380 PO	S 8381 NC		
some / alcuni	Leyland 400 Diesel	01/59 >	S 4380 PO	S 7111 NC		
KHA14						
KHA14	Leyland 400 Diesel	01/59 >	S 4380 PO	S 8381 NC		
some / alcuni	Leyland 400 Diesel	01/59 >	S 4380 PO	S 7111 NC		
KM						
KM	381 cu.in.	01/67 >	S 4380 PO	S 7111 NC		
with pump SIMMS / con pompa SIMMS	381 cu.in.	01/67 >	S 4380 PO	S 6481 N		
KM	466 cu.in.	01/67 >	S 4380 PO	S 7111 NC		
with pump SIMMS / con pompa SIMMS	466 cu.in.	01/67 >	S 4380 PO	S 6481 N		
KM	60170		S 4380 PO			
KM Tipper						
KM Tipper			S 4380 PO	S 7111 NC		
some / alcuni						
MFR1						

B





kW HP



...BEDFORD - trucks/autocarri

B

MFR1	300 cu.in.	01/57 >	S 4380 PO			
MFR2						
MFR2	300 cu.in.	01/57 >	S 4380 PO			
MJ Serie						
MJ Serie						
to engine No. LW106169 / a motore N. LW106169	220 cu.in. Turbo		S 4380 PO	S 7111 NC		
from engine No. LW106170 / da motore N. LW106170	220 cu.in. Turbo			S 7111 NC		
from engine No. LW106170 / da motore N. LW106170	220 cu.in. Turbo	> 06/85		S 7111 NC	S 7139 A	
MJ Serie	330 cu.in. Diesel		S 4380 PO	S 7111 NC		
some / alcuni	330 cu.in. Diesel		S 4380 PO	S 6481 N		
MJ Serie						
to engine No. LW106169 / a motore N. LW106169	330 cu.in. Turbo		S 4380 PO	S 8111 NC		
from engine No. LW106170 / da motore N. LW106170	330 cu.in. Turbo			S 8111 NC		
MJ Serie						
to engine No. 7407759 / a motore N. 7407759	500 cu.in.			S 8111 NC		
from engine No. 7407760 / da motore N. 7407760	500 cu.in.		S 4380 PO	S 8111 NC		
1 filter / N.1 filtro	500 cu.in.			S 8111 NC		
MJ Serie						
to engine No. 7407759 / a motore N. 7407759	500 cu.in. Lo Blo			S 8111 NC	S 2370 A	
from engine No. 7407760 / da motore N. 7407760	500 cu.in. Lo Blo		S 4380 PO	S 8111 NC	S 2370 A	
1 filter / N.1 filtro	500 cu.in. Lo Blo			S 8111 NC	S 2370 A	
RL						
RL	300 cu.in.	01/57 > 12/62	S 4380 PO	S 8381 NC		
	300 cu.in.	01/63 >	S 4380 PO	S 7111 NC		
with pump SIMMS / con pompa SIMMS	300 cu.in.	01/63 >	S 4380 PO	S 6481 N		
RL	300 cu.in. Diesel	01/57 > 12/62	S 4380 PO	S 8381 NC		
	300 cu.in. Diesel	01/63 >	S 4380 PO	S 7111 NC		
with pump SIMMS / con pompa SIMMS	300 cu.in. Diesel	01/63 >	S 4380 PO	S 6481 N		
RS						
RS	300 cu.in.	01/57 > 12/62	S 4380 PO	S 8381 NC		
	300 cu.in.	01/63 >	S 4380 PO	S 7111 NC		
with pump SIMMS / con pompa SIMMS	300 cu.in.	01/63 >	S 4380 PO	S 6481 N		
RS	300 cu.in. Diesel	01/57 > 12/62	S 4380 PO	S 8381 NC		
	300 cu.in. Diesel	01/63 >	S 4380 PO	S 7111 NC		
with pump SIMMS / con pompa SIMMS	300 cu.in. Diesel	01/63 >	S 4380 PO	S 6481 N		
SB5						
SB5	300 cu.in.	01/57 > 12/62	S 4380 PO	S 8381 NC		
	300 cu.in.	01/63 >	S 4380 PO	S 7111 NC		
with pump SIMMS / con pompa SIMMS	300 cu.in.	01/63 >	S 4380 PO	S 6481 N		
TK Serie						
TK Serie	214 cu.in.		S 4380 PO			
TK Serie						
to engine No. LW106169 / a motore N. LW106169	220 cu.in. Turbo		S 4380 PO	S 7111 NC		
from engine No. LW106170 / da motore N. LW106170	220 cu.in. Turbo			S 7111 NC		
from engine No. LW106170 / da motore N. LW106170	220 cu.in. Turbo	> 06/85		S 7111 NC	S 7139 A	
TK Serie	220 cu.in., 330 cu.in.	01/75 >	S 4380 PO	S 7111 NC		
TK Serie	300 cu.in.		S 4380 PO			
TK Serie						
to engine No. LW106169 / a motore N. LW106169	330 cu.in. Turbo		S 4380 PO	S 8111 NC	S 2370 A	
from engine No. LW106170 / da motore N. LW106170	330 cu.in. Turbo			S 8111 NC	S 2370 A	
TK Serie	361 cu.in.		S 4380 PO	S 7111 NC		
TK Serie						
to engine No. 7407759 / a motore N. 7407759	500 cu.in.			S 8111 NC		
from engine No. 7407760 / da motore N. 7407760	500 cu.in.		S 4380 PO	S 8111 NC		
1 filter / N.1 filtro	500 cu.in.			S 8111 NC		
TK Serie						
to engine No. 7407759 / a motore N. 7407759	500 cu.in. Lo Blo			S 8111 NC	S 2370 A	
from engine No. 7407760 / da motore N. 7407760	500 cu.in. Lo Blo		S 4380 PO	S 8111 NC	S 2370 A	
1 filter / N.1 filtro	500 cu.in. Lo Blo			S 8111 NC	S 2370 A	
TK Serie	500 cu.in. Turbo			S 8111 NC		
TL Serie						
TL 1000	214 cu.in., 300 cu.in.	01/80 >	S 4380 PO	S 6181 N		
some / alcuni	214 cu.in., 300 cu.in.	01/80 >	S 4380 PO	S 6481 N		
TL 1000	330 cu.in. Turbo	01/81 > 12/83		S 7111 NC		
TL 1000	500 cu.in. Turbo			S 8111 NC		
some / alcuni	500 cu.in. Turbo			S 8111 NC	S 7139 A	
TL 1020	330 cu.in. Turbo	01/81 > 12/83		S 7111 NC		



kW HP



...BEDFORD - trucks/autocarri

TL 1020 some / alcuni	500 cu.in. Turbo 500 cu.in. Turbo			S 8111 NC S 8111 NC	S 7139 A	
TL 1250 some / alcuni	214 cu.in., 300 cu.in. 214 cu.in., 300 cu.in.	01/80 > 01/80 >	S 4380 PO S 4380 PO	S 6181 N S 6481 N		
TL 1260	330 cu.in. Turbo	01/81 > 12/83		S 7111 NC		
TL 1260 some / alcuni	500 cu.in. Turbo 500 cu.in. Turbo			S 8111 NC S 8111 NC	S 7139 A	
TL 1360	330 cu.in. Turbo	01/81 > 12/83		S 7111 NC		
TL 1470 some / alcuni	500 cu.in. Turbo 500 cu.in. Turbo			S 8111 NC S 8111 NC	S 7139 A	
TL 1630	330 cu.in. Turbo	01/81 > 12/83		S 7111 NC		
TL 1630 some / alcuni	500 cu.in. Turbo 500 cu.in. Turbo			S 8111 NC S 8111 NC	S 7139 A	
TL 1930 some / alcuni	500 cu.in. Turbo 500 cu.in. Turbo			S 8111 NC S 8111 NC	S 7139 A	
TL 2440 some / alcuni	500 cu.in. Turbo 500 cu.in. Turbo			S 8111 NC S 8111 NC	S 7139 A	
TL 570 some / alcuni	200 cu.in. Turbo 200 cu.in. Turbo	01/80 > 12/83 01/80 > 12/83	S 4380 PO S 4380 PO	S 7111 NC S 8111 NC	S 7139 A	
TL 570 some / alcuni	214 cu.in., 300 cu.in. 214 cu.in., 300 cu.in.	01/80 > 01/80 >	S 4380 PO S 4380 PO	S 6181 N S 6481 N		
TL 750 some / alcuni	200 cu.in. Turbo 200 cu.in. Turbo	01/80 > 12/83 01/80 > 12/83	S 4380 PO S 4380 PO	S 7111 NC S 8111 NC	S 7139 A	
TL 750 some / alcuni	214 cu.in., 300 cu.in. 214 cu.in., 300 cu.in.	01/80 > 01/80 >	S 4380 PO S 4380 PO	S 6181 N S 6481 N		
TL 750 some / alcuni	500 cu.in. Turbo 500 cu.in. Turbo			S 8111 NC S 8111 NC	S 7139 A	
TL 860 some / alcuni	214 cu.in., 300 cu.in. 214 cu.in., 300 cu.in.	01/80 > 01/80 >	S 4380 PO S 4380 PO	S 6181 N S 6481 N		
TL 860	330 cu.in. Turbo	01/81 > 12/83		S 7111 NC		
TL 860 some / alcuni	500 cu.in. Turbo 500 cu.in. Turbo			S 8111 NC S 8111 NC	S 7139 A	
TL Serie	214 cu.in.	01/80 >	S 4380 PO			
TL Serie to engine No. LW106169 / a motore N. LW106169 from engine No. LW106170 / da motore N. LW106170	220 cu.in. 220 cu.in.		S 4380 PO	S 7111 NC S 7111 NC		
TL Serie to engine No. LW106169 / a motore N. LW106169 some / alcuni from engine No. LW106170 / da motore N. LW106170	220 cu.in. Turbo 220 cu.in. Turbo 220 cu.in. Turbo		S 4380 PO 09/83 > 06/85	S 7111 NC S 8111 NC S 7111 NC	S 7139 A S 2370 A S 7139 A	
TL Serie to engine No. LW106169 / a motore N. LW106169 from engine No. LW106170 / da motore N. LW106170	330 cu.in. 330 cu.in.		S 4380 PO	S 7111 NC S 7111 NC		
TL Serie to engine No. LW106169 / a motore N. LW106169 some / alcuni from engine No. LW106170 / da motore N. LW106170	330 cu.in. Turbo 330 cu.in. Turbo 330 cu.in. Turbo		S 4380 PO	S 8111 NC S 7111 NC S 8111 NC	S 2370 A S 2370 A S 2370 A	
TL Serie to engine No. 7407759 / a motore N. 7407759 from engine No. 7407760 / da motore N. 7407760	500 cu.in. 500 cu.in.		S 4380 PO	S 8111 NC S 8111 NC		
TL Serie to engine No. 7407759 / a motore N. 7407759 from engine No. 7407760 / da motore N. 7407760	500 cu.in. Lo Blo 500 cu.in. Lo Blo		S 4380 PO	S 8111 NC S 8111 NC		
TL Serie some / alcuni	500 cu.in. Turbo 500 cu.in. Turbo			S 8111 NC S 8111 NC	S 7139 A	
TM Serie						
TM 1500	500 cu.in.	01/75 > 12/83		S 8111 NC		
TM 1500	500 cu.in. Turbo	01/75 > 12/83		S 8111 NC		
TM 1700	500 cu.in.	01/75 > 12/83		S 8111 NC		
TM 1700	500 cu.in. Turbo	01/75 > 12/83		S 8111 NC		
TM 1700 some / alcuni	Detroit Diesel 6V-71 Detroit Diesel 6V-71				S 6550 A S 7945 A	
TM 1700 cartridge / immersione	Detroit Diesel 6V-71	01/75 > 12/83	S 3301 PO		S 6550 A	
TM 1900 some / alcuni	Detroit Diesel 6V-71 Detroit Diesel 6V-71				S 6550 A S 7945 A	
TM 1900 cartridge / immersione	Detroit Diesel 6V-71	01/75 > 12/83	S 3301 PO		S 6550 A	
TM 1900						

B



**KW HP****...BEDFORD - trucks/autocarri****B**

outer / esterno	Detroit Diesel 6V-92TA				S 7945 A
cartridge / immersione	Detroit Diesel 6V-92TA	01/82 >	S 3301 PO		
inner / interno	Detroit Diesel 6V-92TA				S 7024 A
TM 1900					
cartridge / immersione	Detroit Diesel 6V-92TTA	01/82 >	S 3301 PO		
TM 1900	Detroit Diesel 8V-71				S 7945 A
some / alcuni	Detroit Diesel 8V-71				S 6550 A
some / alcuni	Detroit Diesel 8V-71				S 7024 A
some / alcuni	Detroit Diesel 8V-71				S 7945 A
with cone-shaped filter (TM 4200, TM 4400) / con filtro conico (TM 4200, TM 4400)	Detroit Diesel 8V-71				S 1005 A
cartridge / immersione	Detroit Diesel 8V-71	01/75 > 12/83	S 3301 PO		
TM 1930	500 cu.in.	01/75 > 12/83		S 8111 NC	
TM 1930	500 cu.in. Turbo	01/75 > 12/83		S 8111 NC	
TM 2000	500 cu.in.	01/75 > 12/83		S 8111 NC	
TM 2000	500 cu.in. Turbo	01/75 > 12/83		S 8111 NC	
TM 2250	500 cu.in.	01/75 > 12/83		S 8111 NC	
TM 2250	500 cu.in. Turbo	01/75 > 12/83		S 8111 NC	
TM 2250	Detroit Diesel 6V-71				S 6550 A
some / alcuni	Detroit Diesel 6V-71				S 7945 A
cartridge / immersione	Detroit Diesel 6V-71	01/75 > 12/83	S 3301 PO		S 6550 A
TM 2250	Detroit Diesel 8V-71				S 7945 A
some / alcuni	Detroit Diesel 8V-71				S 7024 A
some / alcuni	Detroit Diesel 8V-71				S 6550 A
some / alcuni	Detroit Diesel 8V-71				S 7945 A
with cone-shaped filter (TM 4200, TM 4400) / con filtro conico (TM 4200, TM 4400)	Detroit Diesel 8V-71				S 1005 A
cartridge / immersione	Detroit Diesel 8V-71	01/75 > 12/83	S 3301 PO		
TM 2300	500 cu.in.	01/75 > 12/83		S 8111 NC	
TM 2300	500 cu.in. Turbo	01/75 > 12/83		S 8111 NC	
TM 2500	500 cu.in.	01/75 > 12/83		S 8111 NC	
TM 2500	500 cu.in. Turbo	01/75 > 12/83		S 8111 NC	
TM 2600	500 cu.in.	01/75 > 12/83		S 8111 NC	
TM 2600	500 cu.in. Turbo	01/75 > 12/83		S 8111 NC	
TM 2600	Cummins E250, E255			S 0810 NR	
TM 2600	Cummins E290, NTE370			S 0810 NR	
TM 2600	Detroit Diesel 6V-71				S 6550 A
some / alcuni	Detroit Diesel 6V-71				S 7945 A
cartridge / immersione	Detroit Diesel 6V-71	01/75 > 12/83	S 3301 PO		S 6550 A
TM 2600					
outer / esterno	Detroit Diesel 6V-92TA				S 7945 A
cartridge / immersione	Detroit Diesel 6V-92TA	01/82 >	S 3301 PO		
inner / interno	Detroit Diesel 6V-92TA				S 7024 A
TM 2600					
cartridge / immersione	Detroit Diesel 6V-92TTA	01/82 >	S 3301 PO		
TM 2600	Detroit Diesel 8V-71				S 7945 A
some / alcuni	Detroit Diesel 8V-71				S 6550 A
some / alcuni	Detroit Diesel 8V-71				S 7945 A
some / alcuni	Detroit Diesel 8V-71				S 7024 A
with cone-shaped filter (TM 4200, TM 4400) / con filtro conico (TM 4200, TM 4400)	Detroit Diesel 8V-71				S 1005 A
cartridge / immersione	Detroit Diesel 8V-71	01/75 > 12/83	S 3301 PO		
TM 3000	Detroit Diesel 6V-71				S 6550 A
some / alcuni	Detroit Diesel 6V-71				S 7945 A
cartridge / immersione	Detroit Diesel 6V-71	01/75 > 12/83	S 3301 PO		
TM 3250	500 cu.in.	01/75 > 12/83		S 8111 NC	
TM 3250	500 cu.in. Turbo	01/75 > 12/83		S 8111 NC	
TM 3250	Detroit Diesel 6V-71				S 6550 A
some / alcuni	Detroit Diesel 6V-71				S 7945 A
cartridge / immersione	Detroit Diesel 6V-71	01/75 > 12/83	S 3301 PO		S 7945 A
TM 3650	Detroit Diesel 6V-71				S 6550 A
some / alcuni	Detroit Diesel 6V-71				S 7945 A
cartridge / immersione	Detroit Diesel 6V-71	01/75 > 12/83	S 3301 PO		
TM 3650					
outer / esterno	Detroit Diesel 6V-92TA				S 7945 A
cartridge / immersione	Detroit Diesel 6V-92TA	01/82 >	S 3301 PO		
inner / interno	Detroit Diesel 6V-92TA				S 7024 A
TM 3650					
cartridge / immersione	Detroit Diesel 6V-92TTA	01/82 >	S 3301 PO		
TM 3800	Cummins E250, E255			S 0810 NR	



kW HP



...BEDFORD - trucks/autocarri

TM 3800	Cummins E290, NTE370			S 0810 NR		
TM 3800	Cummins LT10-250			S 0810 NR		
TM 3800						
outer / esterno	Detroit Diesel 6V-92TA				S 7945 A	
cartridge / immersione	Detroit Diesel 6V-92TA	01/82 >	S 3301 PO			
inner / interno	Detroit Diesel 6V-92TA				S 7024 A	
TM 3800						
cartridge / immersione	Detroit Diesel 6V-92TTA	01/82 >	S 3301 PO			
TM 3800						
some / alcuni	Detroit Diesel 8V-71				S 7945 A	
with cone-shaped filter (TM 4200, TM 4400) / con filtro conico (TM 4200, TM 4400)	Detroit Diesel 8V-71				S 6550 A	
outer / esterno	Detroit Diesel 8V-71				S 1005 A	
cartridge / immersione	Detroit Diesel 8V-71	01/75 > 12/83	S 3301 PO		S 7945 A	
inner / interno	Detroit Diesel 8V-71				S 7024 A	
TM 4200						
outer / esterno	Detroit Diesel 6V-92TA				S 7945 A	
cartridge / immersione	Detroit Diesel 6V-92TA	01/82 >	S 3301 PO			
inner / interno	Detroit Diesel 6V-92TA				S 7024 A	
TM 4200						
cartridge / immersione	Detroit Diesel 6V-92TTA	01/82 >	S 3301 PO			
TM 4200						
some / alcuni	Detroit Diesel 8V-71				S 7945 A	
with cone-shaped filter (TM 4200, TM 4400) / con filtro conico (TM 4200, TM 4400)	Detroit Diesel 8V-71				S 6550 A	
outer / esterno	Detroit Diesel 8V-71				S 1005 A	
cartridge / immersione	Detroit Diesel 8V-71	01/75 > 12/83	S 3301 PO		S 7945 A	
inner / interno	Detroit Diesel 8V-71				S 7024 A	
TM 4400						
TM 4400	Cummins E250, E265			S 0810 NR		
TM 4400	Cummins E290, NTE370			S 0810 NR		
TM 4400						
outer / esterno	Detroit Diesel 6V-92TA				S 7945 A	
cartridge / immersione	Detroit Diesel 6V-92TA	01/82 >	S 3301 PO			
inner / interno	Detroit Diesel 6V-92TA				S 7024 A	
TM 4400						
cartridge / immersione	Detroit Diesel 6V-92TTA	01/82 >	S 3301 PO			
TM 4400						
some / alcuni	Detroit Diesel 8V-71				S 7945 A	
with cone-shaped filter (TM 4200, TM 4400) / con filtro conico (TM 4200, TM 4400)	Detroit Diesel 8V-71				S 6550 A	
outer / esterno	Detroit Diesel 8V-71				S 1005 A	
cartridge / immersione	Detroit Diesel 8V-71	01/75 > 12/83	S 3301 PO		S 7945 A	
inner / interno	Detroit Diesel 8V-71				S 7024 A	
TM 4400						
cartridge / immersione	Detroit Diesel 8V-92T	01/79 >	S 3301 PO			
TM Serie						
to engine No. 7707760 / a motore N. 7707760	500 cu.in. Full blo		S 4380 PO	S 8111 NC	S 6550 A	
1 filter / N.1 filtro	500 cu.in. Full blo			S 8111 NC	S 6550 A	
TM Serie						
to engine No. 7707760 / a motore N. 7707760	500 cu.in. Lo Blo		S 4380 PO	S 8111 NC	S 0150 A	
TM Serie						
	Cummins L10, L14			S 0810 NR		
TM Serie						
some / alcuni	Detroit Diesel 6V-71	01/83 >			S 6550 A	
cartridge / immersione	Detroit Diesel 6V-71		S 3301 PO		S 7945 A	
TM Serie						
cartridge / immersione	Detroit Diesel 6V-92		S 3301 PO			

BEDFORD

buses/autobus

BFB						
BFB	300 cu.in.	01/78 >	S 4380 PO			
BLP						
BLP	500 cu.in.	01/78 >		S 8111 NC		
BRP						
BRP	466 cu.in.	01/78 >	S 4380 PO	S 7111 NC		
JJL Midi						
JJL Midi	330 cu.in. Diesel		S 4380 PO	S 7111 NC		
PFK						
PFK	300 cu.in.	01/78 >	S 4380 PO			
PJK						
PJK	330 cu.in. Diesel	01/78 >	S 4380 PO	S 7111 NC		

B





kW HP



...BEDFORD - buses/autobus

B

SB							
SB	Leyland 370 Diesel		01/59 >	S 4380 PO	S 7111 NC		
SB8							
SB8	Leyland 370 Diesel		01/59 >	S 4380 PO	S 7111 NC		
VA Serie							
VA	to engine No. 164456 / a motore N. 164456	214 cu.in. Diesel		S 4380 PO	S 8381 NC		
VA		214 cu.in., 300 cu.in. Diesel		S 4380 PO	S 7111 NC		
VAL Serie							
VAL Coach			01/66 >	S 4380 PO	S 7111 NC		
VAM Serie							
VAM 14	Leyland 400 Diesel		01/59 >		S 8381 NC		
some / alcuni	Leyland 400 Diesel		01/59 >		S 7111 NC		
VAM 3	300 cu.in.		01/57 >	S 4380 PO			
VAM 5	330 cu.in. Diesel		01/57 > 12/62	S 4380 PO	S 8381 NC		
	330 cu.in. Diesel		01/63 >	S 4380 PO	S 7111 NC		
with pump SIMMS / con pompa SIMMS	330 cu.in. Diesel		01/63 >	S 4380 PO	S 6481 N		
VAS Serie							
VAS	330 cu.in. Diesel			S 4380 PO	S 7111 NC		
VAS 1	300 cu.in. Diesel		01/57 > 12/62	S 4380 PO	S 8381 NC		
	300 cu.in. Diesel		01/63 >	S 4380 PO	S 7111 NC		
with pump SIMMS / con pompa SIMMS	300 cu.in. Diesel		01/63 >	S 4380 PO	S 6481 N		
VAS 2	214 cu.in.		01/63 >	S 4380 PO			
Venturer							
Venturer	500 cu.in. Diesel				S 8111 NC		
YLQ Serie							
YLQ	500 cu.in. Diesel				S 8111 NC		
YMP Serie							
YMP	500 cu.in. Turbodiesel				S 8111 NC		
YMQ Serie							
YMQ	500 cu.in. Turbodiesel				S 8111 NC		
YMT Serie							
YMT	500 cu.in. Diesel				S 8111 NC		
YMT	500 cu.in. Turbodiesel				S 8111 NC		
YNT Serie							
YNT	500 cu.in. Turbodiesel				S 8111 NC		
YNV Serie							
YNV	500 cu.in. Turbodiesel				S 8111 NC		
YRQ Serie							
YRQ Coach				S 4380 PO	S 7111 NC		
YRT Serie							
YRT Coach				S 4380 PO	S 7111 NC		

BELL EQUIPMENT

articulated dump trucks/ribaltabili articolati

D Serie							
3806 D	Mercedes Benz OM501LA	290 395	07/01 >	S 5006 PE	S 6001 NE		
4206 D	Mercedes Benz OM501LA	315 430	07/01 >	S 5006 PE	S 6001 NE		
B 18 D	Mercedes Benz OM906LA	170 232	07/01 >	S 5036 PE	S 6017 NE		
with gearbox ZF 6HP592C / con cambio ZF 6HP592C	Mercedes Benz OM906LA	170 232	07/01 >				S 2234 Z
B 18 D 6x4	Mercedes Benz OM906LA	170 232	07/01 >	S 5036 PE	S 6017 NE		
with gearbox ZF 6HP592C / con cambio ZF 6HP592C	Mercedes Benz OM906LA	170 232	07/01 >				S 2234 Z
B 20 D 6x4	Mercedes Benz OM906LA	170 232	07/01 >	S 5036 PE	S 6017 NE		
with gearbox ZF 6HP592C / con cambio ZF 6HP592C	Mercedes Benz OM906LA	170 232	07/01 >				S 2234 Z
B 20 D 6x6	Mercedes Benz OM906LA	170 232	07/01 >	S 5036 PE	S 6017 NE		
with gearbox ZF 6HP592C / con cambio ZF 6HP592C	Mercedes Benz OM906LA	170 232	07/01 >				S 2234 Z
B 25 D	Mercedes Benz OM906LA	205 280	07/01 >	S 5036 PE	S 6017 NE		
with gearbox ZF 6HP592C / con cambio ZF 6HP592C	Mercedes Benz OM906LA	205 280	07/01 >				S 2234 Z
B 30 D	Mercedes Benz OM906LA	205 280	07/01 >	S 5036 PE	S 6017 NE		
with gearbox ZF 6HP592C / con cambio ZF 6HP592C	Mercedes Benz OM906LA	205 280	07/01 >				S 2234 Z
B 30 D	Mercedes Benz OM906LA/OM926LA	240 327	07/01 >	S 5036 PE	S 6017 NE		
with gearbox ZF 6HP592C / con cambio ZF 6HP592C	Mercedes Benz OM906LA/OM926LA	240 327	07/01 >				S 2234 Z
B 35 D	Mercedes Benz OM501LA	290 395	07/01 >	S 5006 PE	S 6001 NE		
B 40 D	Mercedes Benz OM501LA	315 430	07/01 >	S 5006 PE	S 6001 NE		
B 40 D 6x4	Mercedes Benz OM501LA	315 430	07/01 >	S 5006 PE	S 6001 NE		
B 50 D 6x6	Mercedes Benz OM502LA	390 532	07/01 >	S 5006 PE	S 6001 NE		



kW HP



BERKHOF (VDL)

buses/autobus

Ambassador

ALE 106	Cummins ISBe4-205	151	205	10/06	>		S 2220 NR		
with filter Urea/Adblue / con filtro Urea/Adblue	Cummins ISBe4-205	151	205	10/06	>				S 4401 U
power steering / servosterzo	Cummins ISBe4-205	151	205	10/06	>				S 3081 PO
ALE 106	Cummins ISBe4-225	165	225	10/06	>		S 2220 NR		
with filter Urea/Adblue / con filtro Urea/Adblue	Cummins ISBe4-225	165	225	10/06	>				S 4401 U
power steering / servosterzo	Cummins ISBe4-225	165	225	10/06	>				S 3081 PO
ALE 120	Cummins ISBe4-205	151	205	10/06	>		S 2220 NR		
with filter Urea/Adblue / con filtro Urea/Adblue	Cummins ISBe4-205	151	205	10/06	>				S 4401 U
power steering / servosterzo	Cummins ISBe4-205	151	205	10/06	>				S 3081 PO
ALE 120	Cummins ISBe4-225	165	225	10/06	>		S 2220 NR		
with filter Urea/Adblue / con filtro Urea/Adblue	Cummins ISBe4-225	165	225	10/06	>				S 4401 U
power steering / servosterzo	Cummins ISBe4-225	165	225	10/06	>				S 3081 PO

BMC

trucks/autocarri

Professional

518	Cummins B 160-10 Euro1	119	162	01/97	>				S 7259 A
dryer filter / filtro essiccatore									
518	Cummins ISBe 170-30 Euro3	125	170	01/01	>				S 7259 A
dryer filter / filtro essiccatore									
inner / interno	Cummins ISBe 170-30 Euro3	125	170	01/01	>			S 7408 A	
assembly DONALDSON FRG / montaggio DONALDSON FRG	Cummins ISBe 170-30 Euro3	125	170	01/01	>		S 2220 NR	S 7423 A	
522	Cummins B 215-20 Euro2	158	215	01/97	>				S 7259 A
dryer filter / filtro essiccatore									
624	Cummins B 235-20 Euro2	173	235	01/97	>				S 7259 A
dryer filter / filtro essiccatore									
625	Cummins ISBe 250-30 Euro3	183	249	01/01	>				S 7259 A
dryer filter / filtro essiccatore									
inner / interno	Cummins ISBe 250-30 Euro3	183	249	01/01	>			S 7408 A	
assembly DONALDSON FRG / montaggio DONALDSON FRG	Cummins ISBe 250-30 Euro3	183	249	01/01	>	S 0620 R	S 2220 NR	S 7423 A	
power steering / servosterzo	Cummins ISBe 250-30 Euro3	183	249	01/01	>				S 3081 PO
827	Cummins 6C8.3-260-10 Euro1	193	263	01/97	>				S 7259 A
dryer filter / filtro essiccatore									
832	Cummins 6C8.3-300-20 Euro2	221	300	01/97	>				S 7259 A
dryer filter / filtro essiccatore									
PRO 625	Cummins ISBe 250-30 Euro3	183	249	01/01	>				S 7259 A
dryer filter / filtro essiccatore									
inner / interno	Cummins ISBe 250-30 Euro3	183	249	01/01	>			S 7408 A	
assembly DONALDSON FRG / montaggio DONALDSON FRG	Cummins ISBe 250-30 Euro3	183	249	01/01	>		S 2220 NR	S 7423 A	
PRO 938	Cummins ISLe4 Euro4	279	380	09/06	>			S 7421 A	
with filter SCR System / con filtro SCR System	Cummins ISLe4 Euro4	279	380	09/06	>				S 7A86 A
with filter Urea/Adblue / con filtro Urea/Adblue	Cummins ISLe4 Euro4	279	380	09/06	>				S 4401 U
dryer filter / filtro essiccatore	Cummins ISLe4 Euro4	279	380	09/06	>				S 7259 A
inner / interno	Cummins ISLe4 Euro4	279	380	09/06	>			S 7422 A	
power steering / servosterzo	Cummins ISLe4 Euro4	279	380	09/06	>				S 3081 PO
PRO 940	Cummins ISLe400 Euro5	294	400	05/10	>			S 7421 A	
with filter SCR System / con filtro SCR System	Cummins ISLe400 Euro5	294	400	05/10	>				S 7A86 A
with filter Urea/Adblue / con filtro Urea/Adblue	Cummins ISLe400 Euro5	294	400	05/10	>				S 4401 U
dryer filter / filtro essiccatore	Cummins ISLe400 Euro5	294	400	05/10	>				S 7259 A
inner / interno	Cummins ISLe400 Euro5	294	400	05/10	>			S 7422 A	
power steering / servosterzo	Cummins ISLe400 Euro5	294	400	05/10	>				S 3081 PO

BMC

buses/autobus

1100 Serie

Falcon	Cummins ISBe 220-30 Euro3	162	220	01/01	>		S 2220 NR		
dryer filter / filtro essiccatore	Cummins ISBe 220-30 Euro3	162	220	01/01	>				S 7259 A
FE	Cummins ISBe 170-30 Euro3	125	170	01/01	>		S 2220 NR		
dryer filter / filtro essiccatore	Cummins ISBe 170-30 Euro3	125	170	01/01	>				S 7259 A

Belde

220 CB	Cummins C220-20	162	220	04/97	>				S 7259 A
dryer filter / filtro essiccatore									
220 SB	Cummins C220-20	162	220	04/97	>				S 7259 A
dryer filter / filtro essiccatore									
220 SLF	Cummins ISBe 220-30 Euro3	162	220	05/03	>		S 2220 NR		
dryer filter / filtro essiccatore	Cummins ISBe 220-30 Euro3	162	220	05/03	>				S 7259 A
260 CB	Cummins ISCE 260-30 Euro3	191	256	04/97	>				S 7259 A
dryer filter / filtro essiccatore									

B





...BMC - buses/autobus

B

260 SLF dryer filter / filtro essiccatore	Cummins ISCE 260-30 Euro3	191	256	04/97	>				S 7259 A
Condor									
220 SLF dryer filter / filtro essiccatore	Cummins ISBe 220-30 Euro3	162	220	01/01	>		S 2220 NR		S 7259 A
Hawk									
2100 with automatic gearbox ZF HP504C / con cambio automatico ZF HP504C with filter SCR System / con filtro SCR System with filter Urea/Adblue / con filtro Urea/Adblue dryer filter / filtro essiccatore dryer filter WABCO, right-hand thread / filtro essiccatore WABCO, filetto destro inner / interno power steering / servosterzo	Cummins ISBE5 Cummins ISBE5 Cummins ISBE5 Cummins ISBE5 Cummins ISBE5 Cummins ISBE5 Cummins ISBE5	210	285	01/10	>	S 0620 R	S 2220 NR	S 7423 A	S 2234 Z S 7A86 A S 4401 U S 7259 A S 7A66 A
900 LF dryer filter / filtro essiccatore	Cummins ISBe 150-30 Euro3 Cummins ISBe 150-30 Euro3	110	150	01/01	>		S 2220 NR		S 3081 PO S 7259 A
Probus									
215 SCB dryer filter / filtro essiccatore	Cummins ISBe 220-30 Euro3 Cummins ISBe 220-30 Euro3	162	220	01/01	>		S 2220 NR		S 7259 A
850 with filter Urea/Adblue / con filtro Urea/Adblue	Cummins ISBe 205 Cummins ISBe 205	151	205	11/06	>		S 2220 NR		S 4401 U
850 Club dryer filter / filtro essiccatore	Cummins ISBe 220-30 Euro3 Cummins ISBe 220-30 Euro3	162	220	01/01	>		S 2220 NR		S 7259 A
850 TBX dryer filter / filtro essiccatore	Cummins ISBe 220-30 Euro3 Cummins ISBe 220-30 Euro3	162	220	01/01	>		S 2220 NR		S 7259 A
BOVA (VDL BOVA) buses/autobus									
Futura									
FHD 10-200	DAF RS200L	200	272	01/97	> 12/00	S 3408 R	S 6710 NR	S 7428 A	
FHD 10-290	DAF DKV AT	212	288	01/82	> 12/96	S 8600 R	S 8110 NR		
FHD 10-300	DAF RS222L/WS222L	222	300	01/97	> 12/00	S 3408 R	S 6710 NR	S 7428 A	
FHD 10-300 dryer filter / filtro essiccatore	DAF WS222G DAF WS222G	222	300	01/82	> 12/96	S 3275 R	S 8110 NR		S 7259 A
FHD 10-340XE dryer filter / filtro essiccatore dryer filter WABCO, right-hand thread / filtro essiccatore WABCO, filetto destro inner / interno prefilter RACOR 490R / prefiltrato RACOR 490R rotor for oil centrifuge / rotore per filtro olio centrifugo power steering / servosterzo	DAF XE250C1 DAF XE250C1 DAF XE250C1 DAF XE250C1 DAF XE250C1 DAF XE250C1 DAF XE250C1	250	340	01/01	>	S 5234 PE S 5902 PO	S 6146 NE S 4143 NR	S 7641 A S 0768 A	S 7259 A S 7A66 A S 3081 PO
FHD 104-365 with filter SCR-System / con filtro SCR-System with filter Urea/Adblue / con filtro Urea/Adblue prefilter RACOR 490R / prefiltrato RACOR 490R power steering / servosterzo	DAF PR265S Euro4 DAF PR265S Euro4 DAF PR265S Euro4 DAF PR265S Euro4	265	360	09/06	>	S 5234 PE	S 6024 NE S 4143 NR		S 7A86 A S 4401 U S 3081 PO
FHD 12-290	DAF DKV AT	212	288	01/82	> 12/96	S 8600 R	S 8110 NR		
FHD 12-340XE dryer filter / filtro essiccatore dryer filter WABCO, right-hand thread / filtro essiccatore WABCO, filetto destro inner / interno prefilter RACOR 490R / prefiltrato RACOR 490R rotor for oil centrifuge / rotore per filtro olio centrifugo power steering / servosterzo	DAF XE250C1 DAF XE250C1 DAF XE250C1 DAF XE250C1 DAF XE250C1 DAF XE250C1	250	340	01/01	>	S 5234 PE S 5902 PO	S 6146 NE S 4143 NR	S 7641 A S 0768 A	S 7259 A S 7A66 A S 3081 PO
FHD 12-360 dryer filter / filtro essiccatore	DAF DKX ATI DAF DKX ATI	260	354	01/82	> 12/96	S 3275 R	S 8110 NR		S 7259 A
FHD 12-370 dryer filter / filtro essiccatore	DAF WS268G DAF WS268G	268	370	01/82	> 12/96	S 3275 R	S 8110 NR		S 7259 A
FHD 12-380XE dryer filter / filtro essiccatore dryer filter WABCO, right-hand thread / filtro essiccatore WABCO, filetto destro inner / interno prefilter RACOR 490R / prefiltrato RACOR 490R rotor for oil centrifuge / rotore per filtro olio centrifugo power steering / servosterzo	DAF XE280C1 DAF XE280C1 DAF XE280C1 DAF XE280C1 DAF XE280C1 DAF XE280C1	280	381	01/01	>	S 5234 PE S 5902 PO	S 6146 NE S 4143 NR	S 7641 A S 0768 A	S 7259 A S 7A66 A S 3081 PO
FHD 120-365 with filter SCR-System / con filtro SCR-System with filter Urea/Adblue / con filtro Urea/Adblue	DAF PR265S Euro4 DAF PR265S Euro4 DAF PR265S Euro4	265	360	09/06	>	S 5234 PE	S 6024 NE		S 7A86 A S 4401 U

**KW HP****...BOVA (VDL BOVA) - buses/autobus**

dryer filter / filtro essiccatore	DAF PR265S Euro4	265	360	09/06	>			S 4143 NR		S 7F14 A
prefilter RACOR 490R / prefiltrato RACOR 490R	DAF PR265S Euro4	265	360	09/06	>					
power steering / servosterzo	DAF PR265S Euro4	265	360	09/06	>					S 3081 PO
FHD 127-365	DAF PR265S Euro4	265	360	09/06	>		S 5234 PE	S 6024 NE		
with filter SCR-System / con filtro SCR-System	DAF PR265S Euro4	265	360	09/06	>					S 7A86 A
with filter Urea/Adblue / con filtro Urea/Adblue	DAF PR265S Euro4	265	360	09/06	>					S 4401 U
dryer filter / filtro essiccatore	DAF PR265S Euro4	265	360	09/06	>					S 7F14 A
prefilter RACOR 490R / prefiltrato RACOR 490R	DAF PR265S Euro4	265	360	09/06	>			S 4143 NR		
power steering / servosterzo	DAF PR265S Euro4	265	360	09/06	>					S 3081 PO
FHD 13-340XE	DAF XE250C1	250	340	01/01	>		S 5234 PE	S 6146 NE	S 7641 A	
dryer filter / filtro essiccatore	DAF XE250C1	250	340	01/01	>					S 7259 A
dryer filter WABCO, right-hand thread / filtro essiccatore WABCO, filetto destro	DAF XE250C1	250	340	01/01	>					S 7A66 A
inner / interno	DAF XE250C1	250	340	01/01	>				S 0768 A	
prefilter RACOR 490R / prefiltrato RACOR 490R	DAF XE250C1	250	340	01/01	>			S 4143 NR		
rotor for oil centrifuge / rotore per filtro olio centrifugo	DAF XE250C1	250	340	01/01	>		S 5902 PO			
power steering / servosterzo	DAF XE250C1	250	340	01/01	>					S 3081 PO
FHD 13-380XE	DAF XE280C1	280	381	01/01	>		S 5234 PE	S 6146 NE	S 7641 A	
dryer filter / filtro essiccatore	DAF XE280C1	280	381	01/01	>					S 7259 A
dryer filter WABCO, right-hand thread / filtro essiccatore WABCO, filetto destro	DAF XE280C1	280	381	01/01	>					S 7A66 A
inner / interno	DAF XE280C1	280	381	01/01	>				S 0768 A	
prefilter RACOR 490R / prefiltrato RACOR 490R	DAF XE280C1	280	381	01/01	>			S 4143 NR		
rotor for oil centrifuge / rotore per filtro olio centrifugo	DAF XE280C1	280	381	01/01	>		S 5902 PO			
power steering / servosterzo	DAF XE280C1	280	381	01/01	>					S 3081 PO
FHD 14-430XE	DAF XE315C	315	430	01/01	>		S 5234 PE	S 6146 NE	S 7641 A	
dryer filter / filtro essiccatore	DAF XE315C	315	430	01/01	>					S 7259 A
dryer filter WABCO, right-hand thread / filtro essiccatore WABCO, filetto destro	DAF XE315C	315	430	01/01	>					S 7A66 A
inner / interno	DAF XE315C	315	430	01/01	>				S 0768 A	
prefilter RACOR 490R / prefiltrato RACOR 490R	DAF XE315C	315	430	01/01	>			S 4143 NR		
rotor for oil centrifuge / rotore per filtro olio centrifugo	DAF XE315C	315	430	01/01	>		S 5902 PO			
power steering / servosterzo	DAF XE315C	315	430	01/01	>					S 3081 PO
FHD 15-430XE	DAF XE315C	315	430	01/01	>		S 5234 PE	S 6146 NE	S 7641 A	
dryer filter / filtro essiccatore	DAF XE315C	315	430	01/01	>					S 7259 A
dryer filter WABCO, right-hand thread / filtro essiccatore WABCO, filetto destro	DAF XE315C	315	430	01/01	>					S 7A66 A
inner / interno	DAF XE315C	315	430	01/01	>				S 0768 A	
prefilter RACOR 490R / prefiltrato RACOR 490R	DAF XE315C	315	430	01/01	>			S 4143 NR		
rotor for oil centrifuge / rotore per filtro olio centrifugo	DAF XE315C	315	430	01/01	>		S 5902 PO			
power steering / servosterzo	DAF XE315C	315	430	01/01	>					S 3081 PO
FHD 2-122	DAF MX300 Euro5/EEV	300	410	11/10	>		S 5081 PE	S 6024 NE		
with filter SCR-System / con filtro SCR-System	DAF MX300 Euro5/EEV	300	410	11/10	>					S 7A86 A
with filter Urea/Adblue / con filtro Urea/Adblue	DAF MX300 Euro5/EEV	300	410	11/10	>					S 4401 U
dryer filter / filtro essiccatore	DAF MX300 Euro5/EEV	300	410	11/10	>					S 7F14 A
prefilter RACOR 490R / prefiltrato RACOR 490R	DAF MX300 Euro5/EEV	300	410	11/10	>			S 4143 NR		
rotor for oil centrifuge / rotore per filtro olio centrifugo	DAF MX300 Euro5/EEV	300	410	11/10	>		S 5904 PO			
power steering / servosterzo	DAF MX300 Euro5/EEV	300	410	11/10	>					S 3081 PO
FHD 2-122	DAF PR265 S Euro5/EEV	265	361	11/10	>		S 5234 PE	S 6024 NE		
with filter SCR-System / con filtro SCR-System	DAF PR265 S Euro5/EEV	265	361	11/10	>					S 7A86 A
with filter Urea/Adblue / con filtro Urea/Adblue	DAF PR265 S Euro5/EEV	265	361	11/10	>					S 4401 U
dryer filter / filtro essiccatore	DAF PR265 S Euro5/EEV	265	361	11/10	>					S 7F14 A
prefilter RACOR 490R / prefiltrato RACOR 490R	DAF PR265 S Euro5/EEV	265	361	11/10	>			S 4143 NR		
power steering / servosterzo	DAF PR265 S Euro5/EEV	265	361	11/10	>					S 3081 PO
FHD 2-129	DAF MX300 Euro5/EEV	300	410	11/10	>		S 5081 PE	S 6024 NE		
with filter SCR-System / con filtro SCR-System	DAF MX300 Euro5/EEV	300	410	11/10	>					S 7A86 A
with filter Urea/Adblue / con filtro Urea/Adblue	DAF MX300 Euro5/EEV	300	410	11/10	>					S 4401 U
dryer filter / filtro essiccatore	DAF MX300 Euro5/EEV	300	410	11/10	>					S 7F14 A
prefilter RACOR 490R / prefiltrato RACOR 490R	DAF MX300 Euro5/EEV	300	410	11/10	>			S 4143 NR		
rotor for oil centrifuge / rotore per filtro olio centrifugo	DAF MX300 Euro5/EEV	300	410	11/10	>		S 5904 PO			
power steering / servosterzo	DAF MX300 Euro5/EEV	300	410	11/10	>					S 3081 PO
FHD 2-129	DAF PR 265 S Euro5/EEV	265	361	11/10	>		S 5234 PE	S 6024 NE		
with filter SCR-System / con filtro SCR-System	DAF PR 265 S Euro5/EEV	265	361	11/10	>					S 7A86 A
with filter Urea/Adblue / con filtro Urea/Adblue	DAF PR 265 S Euro5/EEV	265	361	11/10	>					S 4401 U
dryer filter / filtro essiccatore	DAF PR 265 S Euro5/EEV	265	361	11/10	>					S 7F14 A
prefilter RACOR 490R / prefiltrato RACOR 490R	DAF PR 265 S Euro5/EEV	265	361	11/10	>			S 4143 NR		
power steering / servosterzo	DAF PR 265 S Euro5/EEV	265	361	11/10	>					S 3081 PO
FHD 2-131	DAF MX300 Euro5/EEV	300	410	11/10	>		S 5081 PE	S 6024 NE		
with filter SCR-System / con filtro SCR-System	DAF MX300 Euro5/EEV	300	410	11/10	>					S 7A86 A
with filter Urea/Adblue / con filtro Urea/Adblue	DAF MX300 Euro5/EEV	300	410	11/10	>					S 4401 U
dryer filter / filtro essiccatore	DAF MX300 Euro5/EEV	300	410	11/10	>					S 7F14 A

B



...BOVA (VDL BOVA) - buses/autobus

B

prefilter RACOR 490R / prefiltro RACOR 490R	DAF MX300 Euro5/EEV	300	410	11/10	>		S 4143 NR		
rotor for oil centrifuge / rotore per filtro olio centrifugo	DAF MX300 Euro5/EEV	300	410	11/10	>	S 5904 PO			
power steering / servosterzo	DAF MX300 Euro5/EEV	300	410	11/10	>				S 3081 PO
FHD 2-131	DAF MX340 Euro5/EEV	338	460	11/10	>	S 5081 PE	S 6024 NE		
with filter SCR-System / con filtro SCR-System	DAF MX340 Euro5/EEV	338	460	11/10	>				S 7A86 A
with filter Urea/Adblue / con filtro Urea/Adblue	DAF MX340 Euro5/EEV	338	460	11/10	>				S 4401 U
dryer filter / filtro essiccatore	DAF MX340 Euro5/EEV	338	460	11/10	>				S 7F14 A
prefilter RACOR 490R / prefiltro RACOR 490R	DAF MX340 Euro5/EEV	338	460	11/10	>		S 4143 NR		
rotor for oil centrifuge / rotore per filtro olio centrifugo	DAF MX340 Euro5/EEV	338	460	11/10	>	S 5904 PO			
power steering / servosterzo	DAF MX340 Euro5/EEV	338	460	11/10	>				S 3081 PO
FHD 2-139	DAF MX300 Euro5/EEV	300	410	11/10	>	S 5081 PE	S 6024 NE		
with filter SCR-System / con filtro SCR-System	DAF MX300 Euro5/EEV	300	410	11/10	>				S 7A86 A
with filter Urea/Adblue / con filtro Urea/Adblue	DAF MX300 Euro5/EEV	300	410	11/10	>				S 4401 U
dryer filter / filtro essiccatore	DAF MX300 Euro5/EEV	300	410	11/10	>				S 7F14 A
prefilter RACOR 490R / prefiltro RACOR 490R	DAF MX300 Euro5/EEV	300	410	11/10	>		S 4143 NR		
rotor for oil centrifuge / rotore per filtro olio centrifugo	DAF MX300 Euro5/EEV	300	410	11/10	>	S 5904 PO			
power steering / servosterzo	DAF MX300 Euro5/EEV	300	410	11/10	>				S 3081 PO
FHD 2-139	DAF MX340 Euro5/EEV	338	460	11/10	>	S 5081 PE	S 6024 NE		
with filter SCR-System / con filtro SCR-System	DAF MX340 Euro5/EEV	338	460	11/10	>				S 7A86 A
with filter Urea/Adblue / con filtro Urea/Adblue	DAF MX340 Euro5/EEV	338	460	11/10	>				S 4401 U
dryer filter / filtro essiccatore	DAF MX340 Euro5/EEV	338	460	11/10	>				S 7F14 A
prefilter RACOR 490R / prefiltro RACOR 490R	DAF MX340 Euro5/EEV	338	460	11/10	>		S 4143 NR		
rotor for oil centrifuge / rotore per filtro olio centrifugo	DAF MX340 Euro5/EEV	338	460	11/10	>	S 5904 PO			
power steering / servosterzo	DAF MX340 Euro5/EEV	338	460	11/10	>				S 3081 PO
FHD 2-148	DAF MX300 Euro5/EEV	300	410	11/10	>	S 5081 PE	S 6024 NE		
with filter SCR-System / con filtro SCR-System	DAF MX300 Euro5/EEV	300	410	11/10	>				S 7A86 A
with filter Urea/Adblue / con filtro Urea/Adblue	DAF MX300 Euro5/EEV	300	410	11/10	>				S 4401 U
dryer filter / filtro essiccatore	DAF MX300 Euro5/EEV	300	410	11/10	>				S 7F14 A
prefilter RACOR 490R / prefiltro RACOR 490R	DAF MX300 Euro5/EEV	300	410	11/10	>		S 4143 NR		
rotor for oil centrifuge / rotore per filtro olio centrifugo	DAF MX300 Euro5/EEV	300	410	11/10	>	S 5904 PO			
power steering / servosterzo	DAF MX300 Euro5/EEV	300	410	11/10	>				S 3081 PO
FHD 2-148	DAF MX340 Euro5/EEV	338	460	11/10	>	S 5081 PE	S 6024 NE		
with filter SCR-System / con filtro SCR-System	DAF MX340 Euro5/EEV	338	460	11/10	>				S 7A86 A
with filter Urea/Adblue / con filtro Urea/Adblue	DAF MX340 Euro5/EEV	338	460	11/10	>				S 4401 U
dryer filter / filtro essiccatore	DAF MX340 Euro5/EEV	338	460	11/10	>				S 7F14 A
prefilter RACOR 490R / prefiltro RACOR 490R	DAF MX340 Euro5/EEV	338	460	11/10	>		S 4143 NR		
rotor for oil centrifuge / rotore per filtro olio centrifugo	DAF MX340 Euro5/EEV	338	460	11/10	>	S 5904 PO			
power steering / servosterzo	DAF MX340 Euro5/EEV	338	460	11/10	>				S 3081 PO
FHM 12-290	Mercedes Benz OM442	213	290	01/82	> 12/96	S 7261 PO	S 2162 N		
dryer filter / filtro essiccatore	Mercedes Benz OM442	213	290	01/82	> 12/96				S 7259 A
FHM 12-360	Mercedes Benz OM442A	260	354	01/82	> 12/96	S 7261 PO	S 2162 N		
dryer filter / filtro essiccatore	Mercedes Benz OM442A	260	354	01/82	> 12/96				S 7259 A
FLD 104-310	DAF PR228S Euro4	228	310	09/07	>	S 5234 PE	S 6024 NE		
with filter SCR-System / con filtro SCR-System	DAF PR228S Euro4	228	310	09/07	>				S 7A86 A
with filter Urea/Adblue / con filtro Urea/Adblue	DAF PR228S Euro4	228	310	09/07	>				S 4401 U
dryer filter / filtro essiccatore	DAF PR228S Euro4	228	310	09/07	>				S 7F14 A
prefilter RACOR 490R / prefiltro RACOR 490R	DAF PR228S Euro4	228	310	09/07	>		S 4143 NR		
power steering / servosterzo	DAF PR228S Euro4	228	310	09/07	>				S 3081 PO
FLD 104-365	DAF PR265S Euro4	265	360	09/07	>	S 5234 PE	S 6024 NE		
with filter SCR-System / con filtro SCR-System	DAF PR265S Euro4	265	360	09/07	>				S 7A86 A
with filter Urea/Adblue / con filtro Urea/Adblue	DAF PR265S Euro4	265	360	09/07	>				S 4401 U
dryer filter / filtro essiccatore	DAF PR265S Euro4	265	360	09/07	>				S 7F14 A
prefilter RACOR 490R / prefiltro RACOR 490R	DAF PR265S Euro4	265	360	09/07	>		S 4143 NR		
power steering / servosterzo	DAF PR265S Euro4	265	360	09/07	>				S 3081 PO
FLD 12-340XE	DAF XE250C1	250	340	01/01	>	S 5234 PE	S 6146 NE	S 7641 A	
dryer filter / filtro essiccatore	DAF XE250C1	250	340	01/01	>				S 7259 A
dryer filter WABCO, right-hand thread / filtro essiccatore WABCO, filetto destro	DAF XE250C1	250	340	01/01	>				S 7A66 A
inner / interno	DAF XE250C1	250	340	01/01	>			S 0768 A	
prefilter RACOR 490R / prefiltro RACOR 490R	DAF XE250C1	250	340	01/01	>		S 4143 NR		
rotor for oil centrifuge / rotore per filtro olio centrifugo	DAF XE250C1	250	340	01/01	>	S 5902 PO			
power steering / servosterzo	DAF XE250C1	250	340	01/01	>				S 3081 PO
FLD 120-310	DAF PR228S Euro4	228	310	09/07	>	S 5234 PE	S 6024 NE		
with filter SCR-System / con filtro SCR-System	DAF PR228S Euro4	228	310	09/07	>				S 7A86 A
with filter Urea/Adblue / con filtro Urea/Adblue	DAF PR228S Euro4	228	310	09/07	>				S 4401 U
dryer filter / filtro essiccatore	DAF PR228S Euro4	228	310	09/07	>				S 7F14 A
prefilter RACOR 490R / prefiltro RACOR 490R	DAF PR228S Euro4	228	310	09/07	>		S 4143 NR		
power steering / servosterzo	DAF PR228S Euro4	228	310	09/07	>				S 3081 PO

**KW HP****...BOVA (VDL BOVA) - buses/autobus**

FLD 120-365	DAF PR265S Euro4	265	360	09/07	>	S 5234 PE	S 6024 NE		S 7A86 A
with filter SCR-System / con filtro SCR-System	DAF PR265S Euro4	265	360	09/07	>				S 4401 U
with filter Urea/Adblue / con filtro Urea/Adblue	DAF PR265S Euro4	265	360	09/07	>				S 7F14 A
dryer filter / filtro essiccatore	DAF PR265S Euro4	265	360	09/07	>				
prefilter RACOR 490R / prefiltrato RACOR 490R	DAF PR265S Euro4	265	360	09/07	>		S 4143 NR		
prefilter RACOR 490R / prefiltrato RACOR 490R	DAF PR265S Euro4	265	360	09/07	>		S 4143 NR		
power steering / servosterzo	DAF PR265S Euro4	265	360	09/07	>				S 3081 PO
FLD 127-310	DAF PR228S Euro4	228	310	09/07	>	S 5234 PE	S 6024 NE		S 7A86 A
with filter SCR-System / con filtro SCR-System	DAF PR228S Euro4	228	310	09/07	>				S 4401 U
with filter Urea/Adblue / con filtro Urea/Adblue	DAF PR228S Euro4	228	310	09/07	>				S 7F14 A
dryer filter / filtro essiccatore	DAF PR228S Euro4	228	310	09/07	>				
prefilter RACOR 490R / prefiltrato RACOR 490R	DAF PR228S Euro4	228	310	09/07	>		S 4143 NR		
power steering / servosterzo	DAF PR228S Euro4	228	310	09/07	>				S 3081 PO
FLD 127-365	DAF PR265S Euro4	265	360	09/07	>	S 5234 PE	S 6024 NE		S 7A86 A
with filter SCR-System / con filtro SCR-System	DAF PR265S Euro4	265	360	09/07	>				S 4401 U
with filter Urea/Adblue / con filtro Urea/Adblue	DAF PR265S Euro4	265	360	09/07	>				S 7F14 A
dryer filter / filtro essiccatore	DAF PR265S Euro4	265	360	09/07	>				
prefilter RACOR 490R / prefiltrato RACOR 490R	DAF PR265S Euro4	265	360	09/07	>		S 4143 NR		
power steering / servosterzo	DAF PR265S Euro4	265	360	09/07	>				S 3081 PO
FLD 13-340XE	DAF XE250C1	250	340	01/01	>	S 5234 PE	S 6146 NE	S 7641 A	S 7259 A
dryer filter / filtro essiccatore	DAF XE250C1	250	340	01/01	>				S 7A66 A
dryer filter WABCO, right-hand thread / filtro essiccatore WABCO, filetto destro	DAF XE250C1	250	340	01/01	>			S 0768 A	
inner / interno	DAF XE250C1	250	340	01/01	>				
prefilter RACOR 490R / prefiltrato RACOR 490R	DAF XE250C1	250	340	01/01	>		S 4143 NR		
rotor for oil centrifuge / rotore per filtro olio centrifugo	DAF XE250C1	250	340	01/01	>	S 5902 PO			
power steering / servosterzo	DAF XE250C1	250	340	01/01	>				S 3081 PO
FLD 13-380XE	DAF XE280C1	280	381	01/01	>	S 5234 PE	S 6146 NE	S 7641 A	S 7259 A
dryer filter / filtro essiccatore	DAF XE280C1	280	381	01/01	>				S 7A66 A
dryer filter WABCO, right-hand thread / filtro essiccatore WABCO, filetto destro	DAF XE280C1	280	381	01/01	>			S 0768 A	
inner / interno	DAF XE280C1	280	381	01/01	>				
prefilter RACOR 490R / prefiltrato RACOR 490R	DAF XE280C1	280	381	01/01	>		S 4143 NR		
rotor for oil centrifuge / rotore per filtro olio centrifugo	DAF XE280C1	280	381	01/01	>	S 5902 PO			
power steering / servosterzo	DAF XE280C1	280	381	01/01	>				S 3081 PO
FLD 15-380XE	DAF XE280C1	280	381	01/01	>	S 5234 PE	S 6146 NE	S 7641 A	S 7259 A
dryer filter / filtro essiccatore	DAF XE280C1	280	381	01/01	>				S 7A66 A
dryer filter WABCO, right-hand thread / filtro essiccatore WABCO, filetto destro	DAF XE280C1	280	381	01/01	>			S 0768 A	
inner / interno	DAF XE280C1	280	381	01/01	>				
prefilter RACOR 490R / prefiltrato RACOR 490R	DAF XE280C1	280	381	01/01	>		S 4143 NR		
rotor for oil centrifuge / rotore per filtro olio centrifugo	DAF XE280C1	280	381	01/01	>	S 5902 PO			
power steering / servosterzo	DAF XE280C1	280	381	01/01	>				S 3081 PO
FVD 12-220	DAF NS156G	156	212	01/82	> 12/96		S 8500 NR		S 7259 A
dryer filter / filtro essiccatore	DAF NS156G	156	212	01/82	> 12/96				
FVD 12-270	DAF HS200G	200	272	01/82	> 12/96	S 8600 R	S 8110 NR		
Lexio									
LD 123-310 PE	DAF PE228C	228	310	09/05	>	S 5234 PE	S 6146 NE	S 7641 A	S 2234 Z
with automatic gearbox ZF HP594C/604C / con cambio automatico ZF HP594C/604C	DAF PE228C	228	310	09/05	>				
inner / interno	DAF PE228C	228	310	09/05	>			S 0768 A	
prefilter RACOR 490R / prefiltrato RACOR 490R	DAF PE228C	228	310	09/05	>		S 4143 NR		
rotor for oil centrifuge / rotore per filtro olio centrifugo	DAF PE228C	228	310	09/05	>	S 5902 PO			
power steering / servosterzo	DAF PE228C	228	310	09/05	>				S 3081 PO
LD 123-360 PE	DAF PE265C	265	360	09/05	>	S 5234 PE	S 6146 NE	S 7641 A	S 2234 Z
with automatic gearbox ZF HP594C/604C / con cambio automatico ZF HP594C/604C	DAF PE265C	265	360	09/05	>				
inner / interno	DAF PE265C	265	360	09/05	>			S 0768 A	
prefilter RACOR 490R / prefiltrato RACOR 490R	DAF PE265C	265	360	09/05	>		S 4143 NR		
rotor for oil centrifuge / rotore per filtro olio centrifugo	DAF PE265C	265	360	09/05	>	S 5902 PO			
power steering / servosterzo	DAF PE265C	265	360	09/05	>				S 3081 PO
LD 130-310 PE	DAF PE228C	228	310	09/05	>	S 5234 PE	S 6146 NE	S 7641 A	S 2234 Z
with automatic gearbox ZF HP594C/604C / con cambio automatico ZF HP594C/604C	DAF PE228C	228	310	09/05	>				
inner / interno	DAF PE228C	228	310	09/05	>			S 0768 A	
prefilter RACOR 490R / prefiltrato RACOR 490R	DAF PE228C	228	310	09/05	>		S 4143 NR		
rotor for oil centrifuge / rotore per filtro olio centrifugo	DAF PE228C	228	310	09/05	>	S 5902 PO			
power steering / servosterzo	DAF PE228C	228	310	09/05	>				S 3081 PO
LD 130-360 PE	DAF PE265C	265	360	09/05	>	S 5234 PE	S 6146 NE	S 7641 A	S 2234 Z
with automatic gearbox ZF HP594C/604C / con cambio automatico ZF HP594C/604C	DAF PE265C	265	360	09/05	>				
inner / interno	DAF PE265C	265	360	09/05	>			S 0768 A	
prefilter RACOR 490R / prefiltrato RACOR 490R	DAF PE265C	265	360	09/05	>		S 4143 NR		
rotor for oil centrifuge / rotore per filtro olio centrifugo	DAF PE265C	265	360	09/05	>	S 5902 PO			

B



...BOVA (VDL BOVA) - buses/autobus

B

power steering / servosterzo	DAF PE265C	265	360	09/05	>				S 3081 PO
LLD 123-310	DAF PR228S	228	310	07/07	>	S 5234 PE	S 6146 NE	S 7641 A	
with automatic gearbox ZF HP594C/604C / con cambio automatico ZF HP594C/604C	DAF PR228S	228	310	07/07	>				S 2234 Z
with filter SCR-System / con filtro SCR-System	DAF PR228S	228	310	07/07	>				S 7A86 A
with filter Urea/Adblue / con filtro Urea/Adblue	DAF PR228S	228	310	07/07	>				S 4401 U
inner / interno	DAF PR228S	228	310	07/07	>			S 0768 A	
prefilter RACOR 490R / prefiltro RACOR 490R	DAF PR228S	228	310	07/07	>		S 4143 NR		
rotor for oil centrifuge / rotore per filtro olio centrifugo	DAF PR228S	228	310	07/07	>	S 5902 PO			
power steering / servosterzo	DAF PR228S	228	310	07/07	>				S 3081 PO
LLD 123-365	DAF PR265S	265	361	12/06	>	S 5234 PE	S 6146 NE	S 7641 A	
with automatic gearbox ZF HP594C/604C / con cambio automatico ZF HP594C/604C	DAF PR265S	265	361	12/06	>				S 2234 Z
with filter SCR-System / con filtro SCR-System	DAF PR265S	265	361	12/06	>				S 7A86 A
with filter Urea/Adblue / con filtro Urea/Adblue	DAF PR265S	265	361	12/06	>				S 4401 U
inner / interno	DAF PR265S	265	361	12/06	>			S 0768 A	
prefilter RACOR 490R / prefiltro RACOR 490R	DAF PR265S	265	361	12/06	>		S 4143 NR		
rotor for oil centrifuge / rotore per filtro olio centrifugo	DAF PR265S	265	361	12/06	>	S 5902 PO			
power steering / servosterzo	DAF PR265S	265	361	12/06	>				S 3081 PO
LLD 130-310	DAF PR228S	228	310	07/07	>	S 5234 PE	S 6146 NE	S 7641 A	
with automatic gearbox ZF HP594C/604C / con cambio automatico ZF HP594C/604C	DAF PR228S	228	310	07/07	>				S 2234 Z
with filter SCR-System / con filtro SCR-System	DAF PR228S	228	310	07/07	>				S 7A86 A
with filter Urea/Adblue / con filtro Urea/Adblue	DAF PR228S	228	310	07/07	>				S 4401 U
inner / interno	DAF PR228S	228	310	07/07	>			S 0768 A	
prefilter RACOR 490R / prefiltro RACOR 490R	DAF PR228S	228	310	07/07	>		S 4143 NR		
rotor for oil centrifuge / rotore per filtro olio centrifugo	DAF PR228S	228	310	07/07	>	S 5902 PO			
power steering / servosterzo	DAF PR228S	228	310	07/07	>				S 3081 PO
LLD 130-365	DAF PR265S	265	361	12/06	>	S 5234 PE	S 6146 NE	S 7641 A	
with automatic gearbox ZF HP594C/604C / con cambio automatico ZF HP594C/604C	DAF PR265S	265	361	12/06	>				S 2234 Z
with filter SCR-System / con filtro SCR-System	DAF PR265S	265	361	12/06	>				S 7A86 A
with filter Urea/Adblue / con filtro Urea/Adblue	DAF PR265S	265	361	12/06	>				S 4401 U
inner / interno	DAF PR265S	265	361	12/06	>			S 0768 A	
prefilter RACOR 490R / prefiltro RACOR 490R	DAF PR265S	265	361	12/06	>		S 4143 NR		
rotor for oil centrifuge / rotore per filtro olio centrifugo	DAF PR265S	265	361	12/06	>	S 5902 PO			
power steering / servosterzo	DAF PR265S	265	361	12/06	>				S 3081 PO
Magiq									
HD 120-340XE	DAF XE250C1	250	340	09/01	>	S 5234 PE	S 6146 NE	S 7641 A	
dryer filter / filtro essiccatore	DAF XE250C1	250	340	09/01	>				S 7259 A
inner / interno	DAF XE250C1	250	340	09/01	>			S 0768 A	
prefilter RACOR 490R / prefiltro RACOR 490R	DAF XE250C1	250	340	09/01	>		S 4143 NR		
rotor for oil centrifuge / rotore per filtro olio centrifugo	DAF XE250C1	250	340	09/01	>	S 5902 PO			
power steering / servosterzo	DAF XE250C1	250	340	09/01	>				S 3081 PO
HD 120-380XE	DAF XE280C1	280	381	09/01	>	S 5234 PE	S 6146 NE	S 7641 A	
dryer filter / filtro essiccatore	DAF XE280C1	280	381	09/01	>				S 7259 A
inner / interno	DAF XE280C1	280	381	09/01	>			S 0768 A	
prefilter RACOR 490R / prefiltro RACOR 490R	DAF XE280C1	280	381	09/01	>		S 4143 NR		
rotor for oil centrifuge / rotore per filtro olio centrifugo	DAF XE280C1	280	381	09/01	>	S 5902 PO			
power steering / servosterzo	DAF XE280C1	280	381	09/01	>				S 3081 PO
HD 122-340XE	DAF XE250C1	250	340	09/01	>	S 5234 PE	S 6146 NE	S 7641 A	
dryer filter / filtro essiccatore	DAF XE250C1	250	340	09/01	>				S 7259 A
inner / interno	DAF XE250C1	250	340	09/01	>			S 0768 A	
prefilter RACOR 490R / prefiltro RACOR 490R	DAF XE250C1	250	340	09/01	>		S 4143 NR		
rotor for oil centrifuge / rotore per filtro olio centrifugo	DAF XE250C1	250	340	09/01	>	S 5902 PO			
power steering / servosterzo	DAF XE250C1	250	340	09/01	>				S 3081 PO
HD 122-380XE	DAF XE280C1	280	381	09/01	>	S 5234 PE	S 6146 NE	S 7641 A	
dryer filter / filtro essiccatore	DAF XE280C1	280	381	09/01	>				S 7259 A
inner / interno	DAF XE280C1	280	381	09/01	>			S 0768 A	
prefilter RACOR 490R / prefiltro RACOR 490R	DAF XE280C1	280	381	09/01	>		S 4143 NR		
rotor for oil centrifuge / rotore per filtro olio centrifugo	DAF XE280C1	280	381	09/01	>	S 5902 PO			
power steering / servosterzo	DAF XE280C1	280	381	09/01	>				S 3081 PO
HD 131-430XE	DAF XE315C	315	430	09/01	>	S 5234 PE	S 6146 NE	S 7641 A	
dryer filter / filtro essiccatore	DAF XE315C	315	430	09/01	>				S 7259 A
inner / interno	DAF XE315C	315	430	09/01	>			S 0768 A	
prefilter RACOR 490R / prefiltro RACOR 490R	DAF XE315C	315	430	09/01	>		S 4143 NR		
rotor for oil centrifuge / rotore per filtro olio centrifugo	DAF XE315C	315	430	09/01	>	S 5902 PO			
power steering / servosterzo	DAF XE315C	315	430	09/01	>				S 3081 PO
HD 139-430XE	DAF XE315C	315	430	09/01	>	S 5234 PE	S 6146 NE	S 7641 A	
dryer filter / filtro essiccatore	DAF XE315C	315	430	09/01	>				S 7259 A
inner / interno	DAF XE315C	315	430	09/01	>			S 0768 A	



...BOVA (VDL BOVA) - buses/autobus

prefilter RACOR 490R / prefiltro RACOR 490R	DAF XE315C	315	430	09/01	>		S 4143 NR		
rotor for oil centrifuge / rotore per filtro olio centrifugo	DAF XE315C	315	430	09/01	>	S 5902 PO			
power steering / servosterzo	DAF XE315C	315	430	09/01	>				S 3081 PO
MHD 122-410	DAF MX300S	300	410	09/06	>	S 5081 PE	S 6024 NE		
with filter SCR-System / con filtro SCR-System	DAF MX300S	300	410	09/06	>				S 7A86 A
with filter Urea/Adblue / con filtro Urea/Adblue	DAF MX300S	300	410	09/06	>				S 4401 U
prefilter RACOR 490R / prefiltro RACOR 490R	DAF MX300S	300	410	09/06	>		S 4143 NR		
rotor for oil centrifuge / rotore per filtro olio centrifugo	DAF MX300S	300	410	09/06	>	S 5904 PO			
power steering / servosterzo	DAF MX300S	300	410	09/06	>				S 3081 PO
MHD 131-460 Magnum	DAF MX340S	340	462	09/06	>	S 5081 PE	S 6024 NE		
with filter SCR-System / con filtro SCR-System	DAF MX340S	340	462	09/06	>				S 7A86 A
with filter Urea/Adblue / con filtro Urea/Adblue	DAF MX340S	340	462	09/06	>				S 4401 U
prefilter RACOR 490R / prefiltro RACOR 490R	DAF MX340S	340	462	09/06	>		S 4143 NR		
rotor for oil centrifuge / rotore per filtro olio centrifugo	DAF MX340S	340	462	09/06	>	S 5904 PO			
power steering / servosterzo	DAF MX340S	340	462	09/06	>				S 3081 PO
MHD 139-460 Magnum	DAF MX340S	340	462	09/06	>	S 5081 PE	S 6024 NE		
with filter SCR-System / con filtro SCR-System	DAF MX340S	340	462	09/06	>				S 7A86 A
with filter Urea/Adblue / con filtro Urea/Adblue	DAF MX340S	340	462	09/06	>				S 4401 U
prefilter RACOR 490R / prefiltro RACOR 490R	DAF MX340S	340	462	09/06	>		S 4143 NR		
rotor for oil centrifuge / rotore per filtro olio centrifugo	DAF MX340S	340	462	09/06	>	S 5904 PO			
power steering / servosterzo	DAF MX340S	340	462	09/06	>				S 3081 PO
MHD 148-460 Magnum	DAF MX340S	340	462	09/06	>	S 5081 PE	S 6024 NE		
with filter SCR-System / con filtro SCR-System	DAF MX340S	340	462	09/06	>				S 7A86 A
with filter Urea/Adblue / con filtro Urea/Adblue	DAF MX340S	340	462	09/06	>				S 4401 U
prefilter RACOR 490R / prefiltro RACOR 490R	DAF MX340S	340	462	09/06	>		S 4143 NR		
rotor for oil centrifuge / rotore per filtro olio centrifugo	DAF MX340S	340	462	09/06	>	S 5904 PO			
power steering / servosterzo	DAF MX340S	340	462	09/06	>				S 3081 PO
Synergy									
DD 130-430XE	DAF XE315C	315	430	10/05	>	S 5234 PE	S 6146 NE	S 7641 A	
inner / interno	DAF XE315C	315	430	10/05	>			S 0768 A	
prefilter RACOR 490R / prefiltro RACOR 490R	DAF XE315C	315	430	10/05	>		S 4143 NR		
rotor for oil centrifuge / rotore per filtro olio centrifugo	DAF XE315C	315	430	10/05	>	S 5902 PO			
power steering / servosterzo	DAF XE315C	315	430	10/05	>				S 3081 PO
DD 130-480XE	DAF XE355C	355	483	10/05	>	S 5234 PE	S 6146 NE	S 7641 A	
inner / interno	DAF XE355C	355	483	10/05	>			S 0768 A	
prefilter RACOR 490R / prefiltro RACOR 490R	DAF XE355C	355	483	10/05	>		S 4143 NR		
rotor for oil centrifuge / rotore per filtro olio centrifugo	DAF XE355C	355	483	10/05	>	S 5902 PO			
power steering / servosterzo	DAF XE355C	355	483	10/05	>				S 3081 PO
DD 138-430XE	DAF XE315C	315	430	10/05	>	S 5234 PE	S 6146 NE	S 7641 A	
inner / interno	DAF XE315C	315	430	10/05	>			S 0768 A	
prefilter RACOR 490R / prefiltro RACOR 490R	DAF XE315C	315	430	10/05	>		S 4143 NR		
rotor for oil centrifuge / rotore per filtro olio centrifugo	DAF XE315C	315	430	10/05	>	S 5902 PO			
power steering / servosterzo	DAF XE315C	315	430	10/05	>				S 3081 PO
DD 138-480XE	DAF XE355C	355	483	10/05	>	S 5234 PE	S 6146 NE	S 7641 A	
inner / interno	DAF XE355C	355	483	10/05	>			S 0768 A	
prefilter RACOR 490R / prefiltro RACOR 490R	DAF XE355C	355	483	10/05	>		S 4143 NR		
rotor for oil centrifuge / rotore per filtro olio centrifugo	DAF XE355C	355	483	10/05	>	S 5902 PO			
power steering / servosterzo	DAF XE355C	355	483	10/05	>				S 3081 PO
SSD 130-460	DAF MX340S	340	460	07/07	>	S 5081 PE	S 6024 NE		
with filter SCR-System / con filtro SCR-System	DAF MX340S	340	460	07/07	>				S 7A86 A
with filter Urea/Adblue / con filtro Urea/Adblue	DAF MX340S	340	460	07/07	>				S 4401 U
prefilter RACOR 490R / prefiltro RACOR 490R	DAF MX340S	340	460	07/07	>		S 4143 NR		
rotor for oil centrifuge / rotore per filtro olio centrifugo	DAF MX340S	340	460	07/07	>	S 5904 PO			
power steering / servosterzo	DAF MX340S	340	460	07/07	>				S 3081 PO
SSD 130-510	DAF MX375S	375	510	07/07	>	S 5081 PE	S 6024 NE		
with filter SCR-System / con filtro SCR-System	DAF MX375S	375	510	07/07	>				S 7A86 A
with filter Urea/Adblue / con filtro Urea/Adblue	DAF MX375S	375	510	07/07	>				S 4401 U
prefilter RACOR 490R / prefiltro RACOR 490R	DAF MX375S	375	510	07/07	>		S 4143 NR		
rotor for oil centrifuge / rotore per filtro olio centrifugo	DAF MX375S	375	510	07/07	>	S 5904 PO			
power steering / servosterzo	DAF MX375S	375	510	07/07	>				S 3081 PO
SSD 138-510	DAF MX375S	375	510	09/06	>	S 5081 PE	S 6024 NE		
with filter SCR-System / con filtro SCR-System	DAF MX375S	375	510	09/06	>				S 7A86 A
with filter Urea/Adblue / con filtro Urea/Adblue	DAF MX375S	375	510	09/06	>				S 4401 U
prefilter RACOR 490R / prefiltro RACOR 490R	DAF MX375S	375	510	09/06	>		S 4143 NR		
rotor for oil centrifuge / rotore per filtro olio centrifugo	DAF MX375S	375	510	09/06	>	S 5904 PO			
power steering / servosterzo	DAF MX375S	375	510	09/06	>				S 3081 PO
SSD 141-460	DAF MX340S	340	460	07/07	>	S 5081 PE	S 6024 NE		

B



kW HP



...BOVA (VDL BOVA) - buses/autobus

with filter SCR-System / con filtro SCR-System	DAF MX340S	340	460	07/07	>				S 7A86 A
with filter Urea/Adblue / con filtro Urea/Adblue	DAF MX340S	340	460	07/07	>				S 4401 U
prefilter RACOR 490R / prefiltrato RACOR 490R	DAF MX340S	340	460	07/07	>			S 4143 NR	
rotor for oil centrifuge / rotore per filtro olio centrifugo	DAF MX340S	340	460	07/07	>	S 5904 PO			
power steering / servosterzo	DAF MX340S	340	460	07/07	>				S 3081 PO
SSD 141-510	DAF MX375S	375	510	07/07	>	S 5081 PE	S 6024 NE		
with filter SCR-System / con filtro SCR-System	DAF MX375S	375	510	07/07	>				S 7A86 A
with filter Urea/Adblue / con filtro Urea/Adblue	DAF MX375S	375	510	07/07	>				S 4401 U
prefilter RACOR 490R / prefiltrato RACOR 490R	DAF MX375S	375	510	07/07	>			S 4143 NR	
rotor for oil centrifuge / rotore per filtro olio centrifugo	DAF MX375S	375	510	07/07	>	S 5904 PO			
power steering / servosterzo	DAF MX375S	375	510	07/07	>				S 3081 PO

BREDA-MENARINI

buses/autobus

Avancity Plus

L	KHD TCD1013L6 4V	213	290	10/08	>	S 5097 PE	S 6039 NE		
dryer filter / filtro essiccatore	KHD TCD1013L6 4V	213	290	10/08	>				S 7A66 A
power steering / servosterzo	KHD TCD1013L6 4V	213	290	10/08	>				S 3081 PO
L CNG/Metano	M906.900/903	205	279	10/08	>	S 5036 PE			
dryer filter / filtro essiccatore	M906.900/903	205	279	10/08	>				S 7A66 A
power steering / servosterzo	M906.900/903	205	279	10/08	>				S 3081 PO
N	KHD TCD1013L6 4V	213	290	10/08	>	S 5097 PE	S 6039 NE		
dryer filter / filtro essiccatore	KHD TCD1013L6 4V	213	290	10/08	>				S 7A66 A
power steering / servosterzo	KHD TCD1013L6 4V	213	290	10/08	>				S 3081 PO
N CNG/Metano	M906.900/903	205	279	10/08	>	S 5036 PE			
dryer filter / filtro essiccatore	M906.900/903	205	279	10/08	>				S 7A66 A
power steering / servosterzo	M906.900/903	205	279	10/08	>				S 3081 PO
S	MAN D2066LUH42/47	235	320	10/08	>	S 5046 PE	S 6011 NE		
dryer filter / filtro essiccatore	MAN D2066LUH42/47	235	320	10/08	>				S 7A66 A
power steering / servosterzo	MAN D2066LUH42/47	235	320	10/08	>				S 3081 PO
S CNG/Metano	MAN E2866LUH2	228	310	01/13	>	S 7260 PO			
dryer filter / filtro essiccatore	MAN E2866LUH2	228	310	01/13	>				S 7A66 A
power steering / servosterzo	MAN E2866LUH2	228	310	01/13	>				S 3081 PO

Vivacity

8 m	FPT 6.7	184	250	10/12	>	S 0620 R			
dryer filter / filtro essiccatore	FPT 6.7	184	250	10/12	>				S 7A66 A
9 m	FPT 6.7	184	250	10/12	>	S 0620 R			
dryer filter / filtro essiccatore	FPT 6.7	184	250	10/12	>				S 7A66 A
C	KHD TCD1013L4 4V	161	219	09/08	>	S 5097 PE	S 6039 NE		
dryer filter / filtro essiccatore	KHD TCD1013L4 4V	161	219	09/08	>				S 7A66 A
C CNG/Metano	M906.901	170	231	09/08	>	S 5036 PE			
dryer filter / filtro essiccatore	M906.901	170	231	09/08	>				S 7A66 A
M	KHD TCD1013L4 4V	161	219	09/08	>	S 5097 PE	S 6039 NE		
dryer filter / filtro essiccatore	KHD TCD1013L4 4V	161	219	09/08	>				S 7A66 A

BREMACH

trucks/autocarri

Brio

3.5	Sofim 8140.07					S 3003 DR	S 8500 NR	S 1540 A	
4.5	Sofim 8140.07					S 3003 DR	S 8500 NR	S 1540 A	

GR Serie

35	to engine No. 414402 / a motore N. 414402	Sofim 8140.61		>	04/83	S 8310 R	S 7111 NC	S 5060 A	
	from engine No. 414403 / da motore N. 414403	Sofim 8140.61		05/83	>	S 3003 DR	S 7111 NC	S 1506 A	
35 4x4	to engine No. 414402 / a motore N. 414402	Sofim 8140.61		>	04/83	S 8310 R	S 7111 NC	S 5060 A	
	from engine No. 414403 / da motore N. 414403	Sofim 8140.61		05/83	>	S 3003 DR	S 7111 NC	S 1506 A	
35 Compact		Sofim 8140.07				S 3003 DR	S 8500 NR	S 1540 A	
35 Trekking 4x4	to engine No. 414402 / a motore N. 414402	Sofim 8140.61		>	04/83	S 8310 R	S 7111 NC	S 5060 A	
	from engine No. 414403 / da motore N. 414403	Sofim 8140.61		05/83	>	S 3003 DR	S 7111 NC	S 1506 A	
35 Turbo		Aifo-Sofim (103 CV)				S 3003 DR	S 8500 NR	S 4940 A	
45 Compact		Sofim 8140.07				S 3003 DR	S 8500 NR	S 1540 A	
45 Turbo		Aifo-Sofim (103 CV)				S 3003 DR	S 8500 NR	S 4940 A	

T-REX

35 2.3 Turbodiesel 4x4	Iveco F1AE0481G	85	116	01/08	>	S 5820 R	S 1071 B	S 7356 A	
60 3.0 Turbodiesel 4x4	Iveco F1AE0481F	107	146	01/08	>	S 0920 R	S 1071 B	S 7356 A	
	prefilter / prefiltrato	Iveco F1AE0481F	107	146	01/08		S 1028 B		
60 3.0 Turbodiesel 4x4	Iveco F1AE0481H	130	176	01/08	>	S 0920 R	S 1071 B	S 7356 A	

**KW HP****...BREMACH - trucks/autocarri**

prefilter / prefiltrro	Iveco F1AE0481H	130	176	01/08	>		S 1028 B		
60 3.0 Turbodiesel 4x4 DPF	Iveco F1CE3481C	125	170	09/09	>	S 0920 R	S 1071 B	S 7356 A	
with complete filter IVECO 5801350522 / con filtro completo IVECO 5801350522	Iveco F1CE3481C	125	170	07/11	>		S 6034 NE		
prefilter / prefiltrro	Iveco F1CE3481C	125	170	09/09	>		S 1028 B		
60 3.0 Turbodiesel 4x4 DPF	Iveco F1CE3481F	107	146	09/09	>	S 0920 R	S 1071 B	S 7356 A	
with complete filter IVECO 5801350522 / con filtro completo IVECO 5801350522	Iveco F1CE3481F	107	146	07/11	>		S 6034 NE		
prefilter / prefiltrro	Iveco F1CE3481F	107	146	09/09	>		S 1028 B		

BUESSING**trucks/autocarri****12000 Serie**

12000 U	S13, U13, U15					S 0201 N			
2nd passage / 2.passaggio	S13, U13, U15					S 1411 N			

4000 Serie

4000	55, 57, 58, S10, S11, U5, U7, U10, U11					S 0201 N			
2nd passage / 2.passaggio	55, 57, 58, S10, S11, U5, U7, U10, U11					S 1411 N			
power steering / servosterzo	55, 57, 58, S10, S11, U5, U7, U10, U11								S 8790 PO
4000 U	55, 57, 58, S10, S11, U5, U7, U10, U11					S 0201 N			
2nd passage / 2.passaggio	55, 57, 58, S10, S11, U5, U7, U10, U11					S 1411 N			
power steering / servosterzo	55, 57, 58, S10, S11, U5, U7, U10, U11								S 8790 PO
4500	55, 57, 58, S10, S11, U5, U7, U10, U11					S 0201 N			
2nd passage / 2.passaggio	55, 57, 58, S10, S11, U5, U7, U10, U11					S 1411 N			
power steering / servosterzo	55, 57, 58, S10, S11, U5, U7, U10, U11								S 8790 PO
4500 U	55, 57, 58, S10, S11, U5, U7, U10, U11					S 0201 N			
2nd passage / 2.passaggio	55, 57, 58, S10, S11, U5, U7, U10, U11					S 1411 N			
power steering / servosterzo	55, 57, 58, S10, S11, U5, U7, U10, U11								S 8790 PO

5/10 TM

5/10 TM Burgloewe Universal	55, 57, 58, S10, S11, U5, U7, U10, U11					S 0201 N			
2nd passage / 2.passaggio	55, 57, 58, S10, S11, U5, U7, U10, U11					S 1411 N			
power steering / servosterzo	55, 57, 58, S10, S11, U5, U7, U10, U11								S 8790 PO

5000 Serie

5500	55, 57, 58, S10, S11, U5, U7, U10, U11					S 0201 N			
2nd passage / 2.passaggio	55, 57, 58, S10, S11, U5, U7, U10, U11					S 1411 N			
power steering / servosterzo	55, 57, 58, S10, S11, U5, U7, U10, U11								S 8790 PO
5500 A	55, 57, 58, S10, S11, U5, U7, U10, U11					S 0201 N			
2nd passage / 2.passaggio	55, 57, 58, S10, S11, U5, U7, U10, U11					S 1411 N			
power steering / servosterzo	55, 57, 58, S10, S11, U5, U7, U10, U11								S 8790 PO
5500 K	55, 57, 58, S10, S11, U5, U7, U10, U11					S 0201 N			
2nd passage / 2.passaggio	55, 57, 58, S10, S11, U5, U7, U10, U11					S 1411 N			
power steering / servosterzo	55, 57, 58, S10, S11, U5, U7, U10, U11								S 8790 PO
5500 S	55, 57, 58, S10, S11, U5, U7, U10, U11					S 0201 N			
2nd passage / 2.passaggio	55, 57, 58, S10, S11, U5, U7, U10, U11					S 1411 N			
power steering / servosterzo	55, 57, 58, S10, S11, U5, U7, U10, U11								S 8790 PO

6000 Serie

6000	55, 57, 58, S10, S11, U5, U7, U10, U11					S 0201 N			
2nd passage / 2.passaggio	55, 57, 58, S10, S11, U5, U7, U10, U11					S 1411 N			
power steering / servosterzo	55, 57, 58, S10, S11, U5, U7, U10, U11								S 8790 PO
6000 K	55, 57, 58, S10, S11, U5, U7, U10, U11					S 0201 N			
2nd passage / 2.passaggio	55, 57, 58, S10, S11, U5, U7, U10, U11					S 1411 N			
power steering / servosterzo	55, 57, 58, S10, S11, U5, U7, U10, U11								S 8790 PO
6000 S	55, 57, 58, S10, S11, U5, U7, U10, U11					S 0201 N			
2nd passage / 2.passaggio	55, 57, 58, S10, S11, U5, U7, U10, U11					S 1411 N			
power steering / servosterzo	55, 57, 58, S10, S11, U5, U7, U10, U11								S 8790 PO
6000 SA	55, 57, 58, S10, S11, U5, U7, U10, U11					S 0201 N			
2nd passage / 2.passaggio	55, 57, 58, S10, S11, U5, U7, U10, U11					S 1411 N			
power steering / servosterzo	55, 57, 58, S10, S11, U5, U7, U10, U11								S 8790 PO

7000 Serie

7500 K	55, 57, 58, S10, S11, U5, U7, U10, U11					S 0201 N			
2nd passage / 2.passaggio	55, 57, 58, S10, S11, U5, U7, U10, U11					S 1411 N			
power steering / servosterzo	55, 57, 58, S10, S11, U5, U7, U10, U11								S 8790 PO
7500 S	55, 57, 58, S10, S11, U5, U7, U10, U11					S 0201 N			
2nd passage / 2.passaggio	55, 57, 58, S10, S11, U5, U7, U10, U11					S 1411 N			
power steering / servosterzo	55, 57, 58, S10, S11, U5, U7, U10, U11								S 8790 PO
7500 U	55, 57, 58, S10, S11, U5, U7, U10, U11					S 0201 N			
2nd passage / 2.passaggio	55, 57, 58, S10, S11, U5, U7, U10, U11					S 1411 N			
power steering / servosterzo	55, 57, 58, S10, S11, U5, U7, U10, U11								S 8790 PO

8000 Serie

8000 S	S13, U13, U15					S 0201 N			
---------------	---------------	--	--	--	--	----------	--	--	--

B



KW HP



...BUESSING - trucks/autocarri

B

2nd passage / 2.passaggio	S13, U13, U15			S 1411 N		
8000 U	S13, U13, U15			S 0201 N		
2nd passage / 2.passaggio	S13, U13, U15			S 1411 N		
BS Serie						
09 LT	S5, S7, S8, S10, S11, U5, U7, U10, U11			S 0201 N		
2nd passage / 2.passaggio	S5, S7, S8, S10, S11, U5, U7, U10, U11			S 1411 N		
power steering / servosterzo	S5, S7, S8, S10, S11, U5, U7, U10, U11					S 8790 PO
09-110 Burgloewe	S5, S7, S8, S10, S11, U5, U7, U10, U11			S 0201 N		
2nd passage / 2.passaggio	S5, S7, S8, S10, S11, U5, U7, U10, U11			S 1411 N		
power steering / servosterzo	S5, S7, S8, S10, S11, U5, U7, U10, U11					S 8790 PO
11 FSA	S7, U7, S7D, U7D		S 0530 PO	S 0201 N		
2nd passage / 2.passaggio	S7, U7, S7D, U7D			S 1411 N		
power steering / servosterzo	S7, U7, S7D, U7D					S 8790 PO
11 K	S5, S7, S8, S10, S11, U5, U7, U10, U11			S 0201 N		
2nd passage / 2.passaggio	S5, S7, S8, S10, S11, U5, U7, U10, U11			S 1411 N		
power steering / servosterzo	S5, S7, S8, S10, S11, U5, U7, U10, U11					S 8790 PO
11 L	S5, S7, S8, S10, S11, U5, U7, U10, U11			S 0201 N		
2nd passage / 2.passaggio	S5, S7, S8, S10, S11, U5, U7, U10, U11			S 1411 N		
power steering / servosterzo	S5, S7, S8, S10, S11, U5, U7, U10, U11					S 8790 PO
11 L	S7, U7, S7D, U7D		S 0530 PO	S 0201 N		
2nd passage / 2.passaggio	S7, U7, S7D, U7D			S 1411 N		
power steering / servosterzo	S7, U7, S7D, U7D					S 8790 PO
11 LT	S5, S7, S8, S10, S11, U5, U7, U10, U11			S 0201 N		
2nd passage / 2.passaggio	S5, S7, S8, S10, S11, U5, U7, U10, U11			S 1411 N		
power steering / servosterzo	S5, S7, S8, S10, S11, U5, U7, U10, U11					S 8790 PO
11 S	S5, S7, S8, S10, S11, U5, U7, U10, U11			S 0201 N		
2nd passage / 2.passaggio	S5, S7, S8, S10, S11, U5, U7, U10, U11			S 1411 N		
power steering / servosterzo	S5, S7, S8, S10, S11, U5, U7, U10, U11					S 8790 PO
12 FSA	S7, U7, S7D, U7D		S 0530 PO	S 0201 N		
2nd passage / 2.passaggio	S7, U7, S7D, U7D			S 1411 N		
power steering / servosterzo	S7, U7, S7D, U7D					S 8790 PO
12 L	S7, U7, S7D, U7D		S 0530 PO	S 0201 N		
2nd passage / 2.passaggio	S7, U7, S7D, U7D			S 1411 N		
power steering / servosterzo	S7, U7, S7D, U7D					S 8790 PO
13 FSA	S7, U7, S7D, U7D		S 0530 PO	S 0201 N		
2nd passage / 2.passaggio	S7, U7, S7D, U7D			S 1411 N		
power steering / servosterzo	S7, U7, S7D, U7D					S 8790 PO
13 L	S7, U7, S7D, U7D		S 0530 PO	S 0201 N		
2nd passage / 2.passaggio	S7, U7, S7D, U7D			S 1411 N		
power steering / servosterzo	S7, U7, S7D, U7D					S 8790 PO
14 AK	S7, U7, S7D, U7D		S 0530 PO	S 0201 N		
2nd passage / 2.passaggio	S7, U7, S7D, U7D			S 1411 N		
power steering / servosterzo	S7, U7, S7D, U7D					S 8790 PO
14 AK	U11D, U12D			S 0201 N		
2nd passage / 2.passaggio	U11D, U12D			S 1411 N		
power steering / servosterzo	U11D, U12D					S 8790 PO
14 FSA	S7, U7, S7D, U7D		S 0530 PO	S 0201 N		
2nd passage / 2.passaggio	S7, U7, S7D, U7D			S 1411 N		
power steering / servosterzo	S7, U7, S7D, U7D					S 8790 PO
14 FSA	U11D, U12D			S 0201 N		
2nd passage / 2.passaggio	U11D, U12D			S 1411 N		
power steering / servosterzo	U11D, U12D					S 8790 PO
14 K	U11D, U12D			S 0201 N		
2nd passage / 2.passaggio	U11D, U12D			S 1411 N		
power steering / servosterzo	U11D, U12D					S 8790 PO
14 L	S7, U7, S7D, U7D		S 0530 PO	S 0201 N		
2nd passage / 2.passaggio	S7, U7, S7D, U7D			S 1411 N		
power steering / servosterzo	S7, U7, S7D, U7D					S 8790 PO
14 L	U11D, U12D			S 0201 N		
2nd passage / 2.passaggio	U11D, U12D			S 1411 N		
power steering / servosterzo	U11D, U12D					S 8790 PO
15 AK	S7, U7, S7D, U7D		S 0530 PO	S 0201 N		
2nd passage / 2.passaggio	S7, U7, S7D, U7D			S 1411 N		
power steering / servosterzo	S7, U7, S7D, U7D					S 8790 PO
15 AK	U11D, U12D			S 0201 N		
2nd passage / 2.passaggio	U11D, U12D			S 1411 N		
power steering / servosterzo	U11D, U12D					S 8790 PO



kW HP



...BUESSING - trucks/autocarri

15 FSA 2nd passage / 2.passaggio power steering / servosterzo	S7, U7, S7D, U7D S7, U7, S7D, U7D S7, U7, S7D, U7D		S 0530 PO	S 0201 N S 1411 N		S 8790 PO
15 L 2nd passage / 2.passaggio power steering / servosterzo	S7, U7, S7D, U7D S7, U7, S7D, U7D S7, U7, S7D, U7D		S 0530 PO	S 0201 N S 1411 N		S 8790 PO
15 L 2nd passage / 2.passaggio power steering / servosterzo	U11D, U12D U11D, U12D U11D, U12D			S 0201 N S 1411 N		S 8790 PO
16 2nd passage / 2.passaggio some / alcuni power steering / servosterzo	S12D S12D S12D S12D		S 1910 PO	S 0201 N S 1411 N S 0201 N		S 8790 PO
16 2nd passage / 2.passaggio power steering / servosterzo	U11D, U12D U11D, U12D U11D, U12D			S 0201 N S 1411 N		S 8790 PO
16 L 2nd passage / 2.passaggio some / alcuni compressor filter / filtro compressore power steering / servosterzo	S12DA S12DA S12DA S12DA S12DA		S 1910 PO	S 0201 N S 1411 N S 0201 N	S 7028 A S 7107 A	S 8790 PO
16 L 2nd passage / 2.passaggio power steering / servosterzo	U11D, U12D U11D, U12D U11D, U12D			S 0201 N S 1411 N		S 8790 PO
16 L 2nd passage / 2.passaggio some / alcuni compressor filter / filtro compressore power steering / servosterzo	U12DA U12DA U12DA U12DA U12DA		S 1910 PO	S 0201 N S 1411 N S 0201 N	S 7028 A S 7107 A	S 8790 PO
16 S 2nd passage / 2.passaggio some / alcuni power steering / servosterzo	S12D S12D S12D S12D		S 1910 PO	S 0201 N S 1411 N S 0201 N		S 8790 PO
16 S 2nd passage / 2.passaggio power steering / servosterzo	U11D, U12D U11D, U12D U11D, U12D			S 0201 N S 1411 N		S 8790 PO
16 SK 2nd passage / 2.passaggio some / alcuni power steering / servosterzo	S12D S12D S12D S12D		S 1910 PO	S 0201 N S 1411 N S 0201 N		S 8790 PO
16 SL 2nd passage / 2.passaggio some / alcuni power steering / servosterzo	S12D S12D S12D S12D		S 1910 PO	S 0201 N S 1411 N S 0201 N		S 8790 PO
16 UK 2nd passage / 2.passaggio some / alcuni power steering / servosterzo	S12D S12D S12D S12D		S 1910 PO	S 0201 N S 1411 N S 0201 N		S 8790 PO
16 UK 2nd passage / 2.passaggio power steering / servosterzo	U11D, U12D U11D, U12D U11D, U12D			S 0201 N S 1411 N		S 8790 PO
19 2nd passage / 2.passaggio some / alcuni power steering / servosterzo	S12D S12D S12D S12D		S 1910 PO	S 0201 N S 1411 N S 0201 N		S 8790 PO
19 L 2nd passage / 2.passaggio some / alcuni power steering / servosterzo	S12D S12D S12D S12D		S 1910 PO	S 0201 N S 1411 N S 0201 N		S 8790 PO
19 S 2nd passage / 2.passaggio some / alcuni power steering / servosterzo	S12D S12D S12D S12D		S 1910 PO	S 0201 N S 1411 N S 0201 N		S 8790 PO
20 2nd passage / 2.passaggio some / alcuni power steering / servosterzo	S12D S12D S12D S12D		S 1910 PO	S 0201 N S 1411 N S 0201 N		S 8790 PO





kW HP



...BUESSING - trucks/autocarri

B

20 S 2 2nd passage / 2.passaggio some / alcuni power steering / servosterzo	S12D S12D S12D S12D		S 1910 PO	S 0201 N S 1411 N S 0201 N		S 8790 PO
20 S 2 2nd passage / 2.passaggio some / alcuni compressor filter / filtro compressore power steering / servosterzo	S12DA S12DA S12DA S12DA S12DA		S 1910 PO	S 0201 N S 1411 N S 0201 N	S 7028 A S 7107 A	S 8790 PO
22 2nd passage / 2.passaggio some / alcuni power steering / servosterzo	S12D S12D S12D S12D		S 1910 PO	S 0201 N S 1411 N S 0201 N		S 8790 PO
22 L 2nd passage / 2.passaggio some / alcuni compressor filter / filtro compressore power steering / servosterzo	S12DA S12DA S12DA S12DA S12DA		S 1910 PO	S 0201 N S 1411 N S 0201 N	S 7028 A S 7107 A	S 8790 PO
22 L 2nd passage / 2.passaggio power steering / servosterzo	U11D, U12D U11D, U12D U11D, U12D			S 0201 N S 1411 N		S 8790 PO
22 L 2nd passage / 2.passaggio some / alcuni compressor filter / filtro compressore power steering / servosterzo	U12DA U12DA U12DA U12DA		S 1910 PO	S 0201 N S 1411 N S 0201 N	S 7028 A S 7107 A	S 8790 PO
Burgloewe Serie						
SAK 2nd passage / 2.passaggio power steering / servosterzo	S7, U7, S7D, U7D S7, U7, S7D, U7D S7, U7, S7D, U7D		S 0530 PO	S 0201 N S 1411 N		S 8790 PO
U 2nd passage / 2.passaggio power steering / servosterzo	S5, S7, S8, S10, S11, U5, U7, U10, U11 S5, S7, S8, S10, S11, U5, U7, U10, U11 S5, S7, S8, S10, S11, U5, U7, U10, U11			S 0201 N S 1411 N		S 8790 PO
UK 2nd passage / 2.passaggio power steering / servosterzo	S5, S7, S8, S10, S11, U5, U7, U10, U11 S5, S7, S8, S10, S11, U5, U7, U10, U11			S 0201 N S 1411 N		S 8790 PO
UM 2nd passage / 2.passaggio power steering / servosterzo	S5, S7, S8, S10, S11, U5, U7, U10, U11 S5, S7, S8, S10, S11, U5, U7, U10, U11			S 0201 N S 1411 N		S 8790 PO
US 2nd passage / 2.passaggio power steering / servosterzo	S5, S7, S8, S10, S11, U5, U7, U10, U11 S5, S7, S8, S10, S11, U5, U7, U10, U11			S 0201 N S 1411 N		S 8790 PO
Commodore Serie						
16-210 2nd passage / 2.passaggio power steering / servosterzo	U11D, U12D U11D, U12D U11D, U12D			S 0201 N S 1411 N		S 8790 PO
19-210 2nd passage / 2.passaggio power steering / servosterzo	U11D, U12D U11D, U12D U11D, U12D			S 0201 N S 1411 N		S 8790 PO
22-210 2nd passage / 2.passaggio power steering / servosterzo	U11D, U12D U11D, U12D U11D, U12D			S 0201 N S 1411 N		S 8790 PO
26-210 2nd passage / 2.passaggio power steering / servosterzo	U11D, U12D U11D, U12D U11D, U12D			S 0201 N S 1411 N		S 8790 PO
SAK 2nd passage / 2.passaggio power steering / servosterzo	S5, S7, S8, S10, S11, U5, U7, U10, U11 S5, S7, S8, S10, S11, U5, U7, U10, U11 S5, S7, S8, S10, S11, U5, U7, U10, U11			S 0201 N S 1411 N		S 8790 PO
SK 2nd passage / 2.passaggio power steering / servosterzo	S5, S7, S8, S10, S11, U5, U7, U10, U11 S5, S7, S8, S10, S11, U5, U7, U10, U11			S 0201 N S 1411 N		S 8790 PO
SS 2nd passage / 2.passaggio power steering / servosterzo	S5, S7, S8, S10, S11, U5, U7, U10, U11 S5, S7, S8, S10, S11, U5, U7, U10, U11			S 0201 N S 1411 N		S 8790 PO
U 2nd passage / 2.passaggio power steering / servosterzo	S5, S7, S8, S10, S11, U5, U7, U10, U11 S5, S7, S8, S10, S11, U5, U7, U10, U11			S 0201 N S 1411 N		S 8790 PO



KW HP



...BUESSING - trucks/autocarri

B

power steering / servosterzo	SS, S7, S8, S10, S11, U5, U7, U10, U11				S 8790 PO
55 M	SS, S7, S8, S10, S11, U5, U7, U10, U11			S 0201 N	
2nd passage / 2.passaggio	SS, S7, S8, S10, S11, U5, U7, U10, U11			S 1411 N	
power steering / servosterzo	SS, S7, S8, S10, S11, U5, U7, U10, U11				S 8790 PO
7	SS, S7, S8, S10, S11, U5, U7, U10, U11			S 0201 N	
2nd passage / 2.passaggio	SS, S7, S8, S10, S11, U5, U7, U10, U11			S 1411 N	
power steering / servosterzo	SS, S7, S8, S10, S11, U5, U7, U10, U11				S 8790 PO
7 S	SS, S7, S8, S10, S11, U5, U7, U10, U11			S 0201 N	
2nd passage / 2.passaggio	SS, S7, S8, S10, S11, U5, U7, U10, U11			S 1411 N	
power steering / servosterzo	SS, S7, S8, S10, S11, U5, U7, U10, U11				S 8790 PO
7/14 Supercargo	SS, S7, S8, S10, S11, U5, U7, U10, U11			S 0201 N	
2nd passage / 2.passaggio	SS, S7, S8, S10, S11, U5, U7, U10, U11			S 1411 N	
power steering / servosterzo	SS, S7, S8, S10, S11, U5, U7, U10, U11				S 8790 PO
75	SS, S7, S8, S10, S11, U5, U7, U10, U11			S 0201 N	
2nd passage / 2.passaggio	SS, S7, S8, S10, S11, U5, U7, U10, U11			S 1411 N	
power steering / servosterzo	SS, S7, S8, S10, S11, U5, U7, U10, U11				S 8790 PO
77	SS, S7, S8, S10, S11, U5, U7, U10, U11			S 0201 N	
2nd passage / 2.passaggio	SS, S7, S8, S10, S11, U5, U7, U10, U11			S 1411 N	
power steering / servosterzo	SS, S7, S8, S10, S11, U5, U7, U10, U11				S 8790 PO
77 Supercargo	SS, S7, S8, S10, S11, U5, U7, U10, U11			S 0201 N	
2nd passage / 2.passaggio	SS, S7, S8, S10, S11, U5, U7, U10, U11			S 1411 N	
power steering / servosterzo	SS, S7, S8, S10, S11, U5, U7, U10, U11				S 8790 PO
S Serie					
16	S12D			S 1910 PO	S 0201 N
2nd passage / 2.passaggio	S12D				S 1411 N
some / alcuni	S12D				S 0201 N
power steering / servosterzo	S12D				S 8790 PO
Supercargo Serie					
14-150	S7, U7, S7D, U7D			S 0530 PO	S 0201 N
2nd passage / 2.passaggio	S7, U7, S7D, U7D				S 1411 N
power steering / servosterzo	S7, U7, S7D, U7D				S 8790 PO
14-185	S7, U7, S7D, U7D			S 0530 PO	S 0201 N
2nd passage / 2.passaggio	S7, U7, S7D, U7D				S 1411 N
power steering / servosterzo	S7, U7, S7D, U7D				S 8790 PO
14-185	U11D, U12D				S 0201 N
2nd passage / 2.passaggio	U11D, U12D				S 1411 N
power steering / servosterzo	U11D, U12D				S 8790 PO
LU 7	S7, U7, S7D, U7D			S 0530 PO	S 0201 N
2nd passage / 2.passaggio	S7, U7, S7D, U7D				S 1411 N
power steering / servosterzo	S7, U7, S7D, U7D				S 8790 PO
LU 7/14	S7, U7, S7D, U7D			S 0530 PO	S 0201 N
2nd passage / 2.passaggio	S7, U7, S7D, U7D				S 1411 N
power steering / servosterzo	S7, U7, S7D, U7D				S 8790 PO
SAK	S7, U7, S7D, U7D			S 0530 PO	S 0201 N
2nd passage / 2.passaggio	S7, U7, S7D, U7D				S 1411 N
power steering / servosterzo	S7, U7, S7D, U7D				S 8790 PO
SK	S7, U7, S7D, U7D			S 0530 PO	S 0201 N
2nd passage / 2.passaggio	S7, U7, S7D, U7D				S 1411 N
power steering / servosterzo	S7, U7, S7D, U7D				S 8790 PO
SS	S7, U7, S7D, U7D			S 0530 PO	S 0201 N
2nd passage / 2.passaggio	S7, U7, S7D, U7D				S 1411 N
power steering / servosterzo	S7, U7, S7D, U7D				S 8790 PO
Supercargo	S7, U7, S7D, U7D			S 0530 PO	S 0201 N
2nd passage / 2.passaggio	S7, U7, S7D, U7D				S 1411 N
power steering / servosterzo	S7, U7, S7D, U7D				S 8790 PO
U	S7, U7, S7D, U7D			S 0530 PO	S 0201 N
2nd passage / 2.passaggio	S7, U7, S7D, U7D				S 1411 N
power steering / servosterzo	S7, U7, S7D, U7D				S 8790 PO
UK	S7, U7, S7D, U7D			S 0530 PO	S 0201 N
2nd passage / 2.passaggio	S7, U7, S7D, U7D				S 1411 N
power steering / servosterzo	S7, U7, S7D, U7D				S 8790 PO
US	S7, U7, S7D, U7D			S 0530 PO	S 0201 N
2nd passage / 2.passaggio	S7, U7, S7D, U7D				S 1411 N
power steering / servosterzo	S7, U7, S7D, U7D				S 8790 PO
US 150	S7, U7, S7D, U7D			S 0530 PO	S 0201 N
2nd passage / 2.passaggio	S7, U7, S7D, U7D				S 1411 N
power steering / servosterzo	S7, U7, S7D, U7D				S 8790 PO



kW HP

**BUESSING**

buses/autobus

4000 Serie

4000 TU	U5, U7, U9, U10, U11			S 0201 N		
2nd passage / 2.passaggio	U5, U7, U9, U10, U11			S 1411 N		
power steering / servosterzo	U5, U7, U9, U10, U11					S 8790 PO
4500 T	U5, U7, U9, U10, U11			S 0201 N		
2nd passage / 2.passaggio	U5, U7, U9, U10, U11			S 1411 N		
power steering / servosterzo	U5, U7, U9, U10, U11					S 8790 PO

5000 Serie

5000 T	U5, U7, U9, U10, U11			S 0201 N		
2nd passage / 2.passaggio	U5, U7, U9, U10, U11			S 1411 N		
power steering / servosterzo	U5, U7, U9, U10, U11					S 8790 PO
5000 TU	U5, U7, U9, U10, U11			S 0201 N		
2nd passage / 2.passaggio	U5, U7, U9, U10, U11			S 1411 N		
power steering / servosterzo	U5, U7, U9, U10, U11					S 8790 PO

6000 Serie

6000 T	U5, U7, U9, U10, U11			S 0201 N		
2nd passage / 2.passaggio	U5, U7, U9, U10, U11			S 1411 N		
power steering / servosterzo	U5, U7, U9, U10, U11					S 8790 PO
6000 TU	U5, U7, U9, U10, U11			S 0201 N		
2nd passage / 2.passaggio	U5, U7, U9, U10, U11			S 1411 N		
power steering / servosterzo	U5, U7, U9, U10, U11					S 8790 PO
6500 T	U5, U7, U9, U10, U11			S 0201 N		
2nd passage / 2.passaggio	U5, U7, U9, U10, U11			S 1411 N		
power steering / servosterzo	U5, U7, U9, U10, U11					S 8790 PO
6500 TU	U5, U7, U9, U10, U11			S 0201 N		
2nd passage / 2.passaggio	U5, U7, U9, U10, U11			S 1411 N		
power steering / servosterzo	U5, U7, U9, U10, U11					S 8790 PO

BS Serie

100 GT	U10D5, U11D			S 0201 N	S 7992 A	
2nd passage / 2.passaggio	U10D5, U11D			S 1411 N		
power steering / servosterzo	U10D5, U11D					S 8790 PO
100 GT	U7D		S 0530 PO	S 0201 N		
2nd passage / 2.passaggio	U7D			S 1411 N		
power steering / servosterzo	U7D					S 8790 PO
100 N	U10D5, U11D			S 0201 N	S 7992 A	
2nd passage / 2.passaggio	U10D5, U11D			S 1411 N		
power steering / servosterzo	U10D5, U11D					S 8790 PO
100 N	U7D		S 0530 PO	S 0201 N		
2nd passage / 2.passaggio	U7D			S 1411 N		
power steering / servosterzo	U7D					S 8790 PO
100 T	U10D5, U11D			S 0201 N	S 7992 A	
2nd passage / 2.passaggio	U10D5, U11D			S 1411 N		
power steering / servosterzo	U10D5, U11D					S 8790 PO
100 T	U7D		S 0530 PO	S 0201 N		
2nd passage / 2.passaggio	U7D			S 1411 N		
power steering / servosterzo	U7D					S 8790 PO
100 V	U7D		S 0530 PO	S 0201 N		
2nd passage / 2.passaggio	U7D			S 1411 N		
power steering / servosterzo	U7D					S 8790 PO
110 DD	U7D		S 0530 PO	S 0201 N		
2nd passage / 2.passaggio	U7D			S 1411 N		
power steering / servosterzo	U7D					S 8790 PO
110 GT	U10D5, U11D			S 0201 N	S 7992 A	
2nd passage / 2.passaggio	U10D5, U11D			S 1411 N		
power steering / servosterzo	U10D5, U11D					S 8790 PO
110 GT	U7D		S 0530 PO	S 0201 N		
2nd passage / 2.passaggio	U7D			S 1411 N		
power steering / servosterzo	U7D					S 8790 PO
110 N	U10D5, U11D			S 0201 N	S 7992 A	
2nd passage / 2.passaggio	U10D5, U11D			S 1411 N		
power steering / servosterzo	U10D5, U11D					S 8790 PO
110 T	U10D5, U11D			S 0201 N	S 7992 A	
2nd passage / 2.passaggio	U10D5, U11D			S 1411 N		
power steering / servosterzo	U10D5, U11D					S 8790 PO
110 V	U10D5, U11D			S 0201 N	S 7992 A	
2nd passage / 2.passaggio	U10D5, U11D			S 1411 N		
power steering / servosterzo	U10D5, U11D					S 8790 PO

B



kW HP



...BUESSING - buses/autobus

B

110 V (VOEV) Standardbus 2nd passage / 2.passaggio power steering / servosterzo	U10D5, U11D U10D5, U11D U10D5, U11D			S 0201 N S 1411 N	S 7992 A	S 8790 PO
110 V (VOEV) Standardbus 2nd passage / 2.passaggio power steering / servosterzo	U7D U7D U7D		S 0530 PO	S 0201 N S 1411 N	S 7992 A	S 8790 PO
113 V 2nd passage / 2.passaggio power steering / servosterzo	U7D U7D U7D		S 0530 PO	S 0201 N S 1411 N		S 8790 PO
120 GT 2nd passage / 2.passaggio power steering / servosterzo	U10D5, U11D U10D5, U11D U10D5, U11D			S 0201 N S 1411 N	S 7992 A	S 8790 PO
120 N 2nd passage / 2.passaggio power steering / servosterzo	U10D5, U11D U10D5, U11D U10D5, U11D			S 0201 N S 1411 N	S 7992 A	S 8790 PO
120 T 2nd passage / 2.passaggio power steering / servosterzo	U10D5, U11D U10D5, U11D U10D5, U11D			S 0201 N S 1411 N	S 7992 A	S 8790 PO
120 V 2nd passage / 2.passaggio power steering / servosterzo	U10D5, U11D U10D5, U11D U10D5, U11D			S 0201 N S 1411 N	S 7992 A	S 8790 PO
BSE Serie						
110 GT 2nd passage / 2.passaggio power steering / servosterzo	U7D U7D U7D		S 0530 PO	S 0201 N S 1411 N		S 8790 PO
110 N 2nd passage / 2.passaggio power steering / servosterzo	U7D U7D U7D		S 0530 PO	S 0201 N S 1411 N		S 8790 PO
110 T 2nd passage / 2.passaggio power steering / servosterzo	U7D U7D U7D		S 0530 PO	S 0201 N S 1411 N		S 8790 PO
120 GT 2nd passage / 2.passaggio power steering / servosterzo	U7D U7D U7D		S 0530 PO	S 0201 N S 1411 N		S 8790 PO
120 N 2nd passage / 2.passaggio power steering / servosterzo	U7D U7D U7D		S 0530 PO	S 0201 N S 1411 N		S 8790 PO
120 T 2nd passage / 2.passaggio power steering / servosterzo	U7D U7D U7D		S 0530 PO	S 0201 N S 1411 N		S 8790 PO
Konsul Serie						
11 2nd passage / 2.passaggio power steering / servosterzo	U7, U7D U7, U7D U7, U7D		S 0530 PO	S 0201 N S 1411 N		S 8790 PO
11 RU 5 H 2nd passage / 2.passaggio power steering / servosterzo	U5, U7, U9, U10, U11 U5, U7, U9, U10, U11 U5, U7, U9, U10, U11			S 0201 N S 1411 N		S 8790 PO
12 RU 5 H 2nd passage / 2.passaggio power steering / servosterzo	U5, U7, U9, U10, U11 U5, U7, U9, U10, U11 U5, U7, U9, U10, U11			S 0201 N S 1411 N		S 8790 PO
13 RU 5 H 2nd passage / 2.passaggio power steering / servosterzo	U5, U7, U9, U10, U11 U5, U7, U9, U10, U11 U5, U7, U9, U10, U11			S 0201 N S 1411 N		S 8790 PO
13 TU 5 H 2nd passage / 2.passaggio power steering / servosterzo	U5, U7, U9, U10, U11 U5, U7, U9, U10, U11 U5, U7, U9, U10, U11			S 0201 N S 1411 N		S 8790 PO
8 RU 5 2nd passage / 2.passaggio power steering / servosterzo	U5, U7, U9, U10, U11 U5, U7, U9, U10, U11 U5, U7, U9, U10, U11			S 0201 N S 1411 N		S 8790 PO
9 RU 5 2nd passage / 2.passaggio power steering / servosterzo	U5, U7, U9, U10, U11 U5, U7, U9, U10, U11 U5, U7, U9, U10, U11			S 0201 N S 1411 N		S 8790 PO
Praefekt Serie						
11 2nd passage / 2.passaggio power steering / servosterzo	U7, U7D U7, U7D U7, U7D		S 0530 PO	S 0201 N S 1411 N		S 8790 PO
12	U7, U7D		S 0530 PO	S 0201 N		



kW HP



...BUESSING - buses/autobus

2nd passage / 2.passaggio power steering / servosterzo	U7, U7D U7, U7D			S 1411 N		S 8790 PO
13 2nd passage / 2.passaggio power steering / servosterzo	U11D U11D			S 0201 N S 1411 N	S 7987 A	S 8790 PO
13 2nd passage / 2.passaggio power steering / servosterzo	U5, U7, U9, U10, U11 U5, U7, U9, U10, U11 U5, U7, U9, U10, U11			S 0201 N S 1411 N		S 8790 PO
13 2nd passage / 2.passaggio power steering / servosterzo	U7, U7D U7, U7D U7, U7D		S 0530 PO	S 0201 N S 1411 N		S 8790 PO
14 2nd passage / 2.passaggio power steering / servosterzo	U7, U7D U7, U7D U7, U7D		S 0530 PO	S 0201 N S 1411 N		S 8790 PO
15 2nd passage / 2.passaggio power steering / servosterzo	U11D U11D U11D			S 0201 N S 1411 N	S 7987 A	S 8790 PO
15 2nd passage / 2.passaggio power steering / servosterzo	U5, U7, U9, U10, U11 U5, U7, U9, U10, U11 U5, U7, U9, U10, U11			S 0201 N S 1411 N		S 8790 PO
15 2nd passage / 2.passaggio power steering / servosterzo	U7, U7D U7, U7D U7, U7D		S 0530 PO	S 0201 N S 1411 N		S 8790 PO
25 2nd passage / 2.passaggio power steering / servosterzo	U7, U7D U7, U7D U7, U7D		S 0530 PO	S 0201 N S 1411 N		S 8790 PO
26 2nd passage / 2.passaggio power steering / servosterzo	U7, U7D U7, U7D U7, U7D		S 0530 PO	S 0201 N S 1411 N		S 8790 PO
Praefekt 2nd passage / 2.passaggio power steering / servosterzo	posteriore / rear posteriore / rear posteriore / rear		S 1910 PO	S 0201 N S 1411 N		S 8790 PO
Praesident Serie						
13 RU 10 2nd passage / 2.passaggio power steering / servosterzo	U5, U7, U9, U10, U11 U5, U7, U9, U10, U11 U5, U7, U9, U10, U11			S 0201 N S 1411 N		S 8790 PO
14 2nd passage / 2.passaggio power steering / servosterzo	U11D U11D			S 0201 N S 1411 N	S 7987 A	S 8790 PO
14 2nd passage / 2.passaggio power steering / servosterzo	U5, U7, U9, U10, U11 U5, U7, U9, U10, U11 U5, U7, U9, U10, U11			S 0201 N S 1411 N		S 8790 PO
14 RU 10 2nd passage / 2.passaggio power steering / servosterzo	U5, U7, U9, U10, U11 U5, U7, U9, U10, U11 U5, U7, U9, U10, U11			S 0201 N S 1411 N		S 8790 PO
17 2nd passage / 2.passaggio power steering / servosterzo	U11D U11D U11D			S 0201 N S 1411 N	S 7987 A	S 8790 PO
17 2nd passage / 2.passaggio power steering / servosterzo	U5, U7, U9, U10, U11 U5, U7, U9, U10, U11 U5, U7, U9, U10, U11			S 0201 N S 1411 N		S 8790 PO
18 2nd passage / 2.passaggio power steering / servosterzo	U11D U11D U11D			S 0201 N S 1411 N	S 7987 A	S 8790 PO
18 2nd passage / 2.passaggio power steering / servosterzo	U5, U7, U9, U10, U11 U5, U7, U9, U10, U11 U5, U7, U9, U10, U11			S 0201 N S 1411 N		S 8790 PO
19 2nd passage / 2.passaggio power steering / servosterzo	U11D U11D U11D			S 0201 N S 1411 N	S 7987 A	S 8790 PO
19 2nd passage / 2.passaggio power steering / servosterzo	U5, U7, U9, U10, U11 U5, U7, U9, U10, U11 U5, U7, U9, U10, U11			S 0201 N S 1411 N		S 8790 PO
25 2nd passage / 2.passaggio power steering / servosterzo	U11D U11D U11D			S 0201 N S 1411 N	S 7987 A	S 8790 PO
26	U11D			S 0201 N	S 7987 A	S 8790 PO

B





kW HP



...BUESSING - buses/autobus

2nd passage / 2.passaggio power steering / servosterzo	U11D U11D			S 1411 N		S 8790 PO
26 2nd passage / 2.passaggio power steering / servosterzo	U5, U7, U9, U10, U11 U5, U7, U9, U10, U11			S 0201 N S 1411 N		S 8790 PO
Praesident 2nd passage / 2.passaggio power steering / servosterzo	posteriore / rear posteriore / rear posteriore / rear		S 1910 PO	S 0201 N S 1411 N		S 8790 PO
R Serie						
RU 11 2nd passage / 2.passaggio power steering / servosterzo	U5, U7, U9, U10, U11 U5, U7, U9, U10, U11 U5, U7, U9, U10, U11			S 0201 N S 1411 N		S 8790 PO
RU 11 R 2nd passage / 2.passaggio power steering / servosterzo	U5, U7, U9, U10, U11 U5, U7, U9, U10, U11 U5, U7, U9, U10, U11			S 0201 N S 1411 N		S 8790 PO
RU 13 2nd passage / 2.passaggio power steering / servosterzo	U5, U7, U9, U10, U11 U5, U7, U9, U10, U11 U5, U7, U9, U10, U11			S 0201 N S 1411 N		S 8790 PO
Senator Serie						
11 RU 7 H 2nd passage / 2.passaggio power steering / servosterzo	U5, U7, U9, U10, U11 U5, U7, U9, U10, U11 U5, U7, U9, U10, U11			S 0201 N S 1411 N		S 8790 PO
12 RU 7 H 2nd passage / 2.passaggio power steering / servosterzo	U5, U7, U9, U10, U11 U5, U7, U9, U10, U11 U5, U7, U9, U10, U11			S 0201 N S 1411 N		S 8790 PO
13 RU 7 H 2nd passage / 2.passaggio power steering / servosterzo	U5, U7, U9, U10, U11 U5, U7, U9, U10, U11 U5, U7, U9, U10, U11			S 0201 N S 1411 N		S 8790 PO
14 RU 7 H 2nd passage / 2.passaggio power steering / servosterzo	U5, U7, U9, U10, U11 U5, U7, U9, U10, U11 U5, U7, U9, U10, U11			S 0201 N S 1411 N		S 8790 PO
15 RU 7 H 2nd passage / 2.passaggio power steering / servosterzo	U5, U7, U9, U10, U11 U5, U7, U9, U10, U11 U5, U7, U9, U10, U11			S 0201 N S 1411 N		S 8790 PO
T Serie						
TU 10 2nd passage / 2.passaggio power steering / servosterzo	U5, U7, U9, U10, U11 U5, U7, U9, U10, U11 U5, U7, U9, U10, U11			S 0201 N S 1411 N		S 8790 PO
TU 11 2nd passage / 2.passaggio power steering / servosterzo	U5, U7, U9, U10, U11 U5, U7, U9, U10, U11 U5, U7, U9, U10, U11			S 0201 N S 1411 N		S 8790 PO
TU 5 S 2nd passage / 2.passaggio power steering / servosterzo	U5, U7, U9, U10, U11 U5, U7, U9, U10, U11 U5, U7, U9, U10, U11			S 0201 N S 1411 N		S 8790 PO
TU 55 2nd passage / 2.passaggio power steering / servosterzo	U5, U7, U9, U10, U11 U5, U7, U9, U10, U11 U5, U7, U9, U10, U11			S 0201 N S 1411 N		S 8790 PO
TU 7 2nd passage / 2.passaggio power steering / servosterzo	U5, U7, U9, U10, U11 U5, U7, U9, U10, U11 U5, U7, U9, U10, U11			S 0201 N S 1411 N		S 8790 PO
CACCIAMALI buses/autobus						
TCN						
105	Iveco 8360.46	01/98 >		S 5003 DR	S 4329 NR	
CARRIER refrigeration units/gruppi refrigeranti						
1000 Serie						
1003 2nd passage / 2.passaggio	Mercedes Benz OM636			S 0810 NR		
1003 2nd passage / 2.passaggio some / alcuni	Perkins 4.108 Perkins 4.108		S 0420 R	S 0810 NR		
200 Serie						
230 2nd passage / 2.passaggio some / alcuni	Perkins 4.99 Perkins 4.99		S 6380 PO	S 8381 NC		
230 B						



kW HP



...CARRIER - refrigeration units/gruppi refrigeranti

2nd passage / 2.passaggio some / alcuni	Perkins 4.99 Perkins 4.99		S 6380 PO	S 8381 NC		
231						
2nd passage / 2.passaggio some / alcuni	Perkins 4.99 Perkins 4.99		S 6380 PO	S 8381 NC		
234						
2nd passage / 2.passaggio some / alcuni	Perkins 4.99 Perkins 4.99		S 6380 PO	S 8381 NC		
250						
2nd passage / 2.passaggio some / alcuni	Perkins 4.99 Perkins 4.99		S 6380 PO	S 8381 NC		
250 C						
2nd passage / 2.passaggio some / alcuni	Perkins 4.99 Perkins 4.99		S 6380 PO	S 8381 NC		
250 CM						
2nd passage / 2.passaggio some / alcuni	Mercedes Benz OM636 Perkins 4.99		S 0300 O	S 8381 NC		
260						
2nd passage / 2.passaggio some / alcuni	Perkins 4.99 Perkins 4.99		S 6380 PO	S 8381 NC		
2000 Serie						
2005 A						
2nd passage / 2.passaggio some / alcuni	Mercedes Benz OM636 Mercedes Benz OM636		S 0300 O	S 0810 NR		
2005 A						
2nd passage / 2.passaggio some / alcuni	Perkins 4.108 Perkins 4.108		S 0420 R	S 0810 NR		
2005 A3						
2nd passage / 2.passaggio	Mercedes Benz OM636			S 0810 NR		
400 Serie						
400 C1						
2nd passage / 2.passaggio some / alcuni	Perkins 4.99 Perkins 4.99		S 6380 PO	S 8381 NC		
600 Serie						
640						
2nd passage / 2.passaggio some / alcuni	Perkins 4.99 Perkins 4.99		S 6380 PO	S 8381 NC		
650						
2nd passage / 2.passaggio some / alcuni	Perkins 4.99 Perkins 4.99		S 6380 PO	S 8381 NC		
6000 Serie						
6000 A						
2nd passage / 2.passaggio some / alcuni	Perkins 4.108 Perkins 4.108		S 0420 R	S 0810 NR		
6000 A2						
2nd passage / 2.passaggio some / alcuni	Perkins 4.108 Perkins 4.108		S 0420 R	S 0810 NR		
6000 A3						
2nd passage / 2.passaggio	Mercedes Benz OM636			S 0810 NR		
6004 A1						
2nd passage / 2.passaggio some / alcuni	Perkins 4.108 Perkins 4.108		S 0420 R	S 0810 NR		
6004 A2						
2nd passage / 2.passaggio some / alcuni	Perkins 4.108 Perkins 4.108		S 0420 R	S 0810 NR		
6007 A						
2nd passage / 2.passaggio	Mercedes Benz OM636 Mercedes Benz OM636		S 0300 O	S 0810 NR		
6007 A2						
2nd passage / 2.passaggio some / alcuni	Perkins 4.108 Perkins 4.108		S 0420 R	S 0810 NR		
6007 A3						
2nd passage / 2.passaggio	Mercedes Benz OM636			S 0810 NR		
Eagle						
Eagle						
2nd passage / 2.passaggio some / alcuni	Perkins 4.108 Perkins 4.108		S 0420 R	S 0810 NR		
Eagle Space Saver						
2nd passage / 2.passaggio some / alcuni	Perkins 4.108 Perkins 4.108		S 0420 R	S 0810 NR		
Eagle Plus						

C





kW HP



...CARRIER - refrigeration units/gruppi refrigeranti

Plus 2nd passage / 2.passaggio some / alcuni	Perkins 4.108 Perkins 4.108		S 0420 R	S 0810 NR		
Plus NDB 405 2nd passage / 2.passaggio some / alcuni	CT 4.114 CT 4.114		S 0420 R	S 0810 NR		
Plus NDS 405 2nd passage / 2.passaggio some / alcuni	CT 4.114 CT 4.114		S 0420 R	S 0810 NR		
Golden Eagle						
Golden Eagle 2nd passage / 2.passaggio	Mercedes Benz OM636 Mercedes Benz OM636		S 0300 O	S 0810 NR		
NDE 40 2nd passage / 2.passaggio some / alcuni	Perkins 4.108 Perkins 4.108		S 0420 R	S 0810 NR		
Mistral						
400	EA 400 NB			S 8111 NC		
610 U	Kubota ZB 600 C1			S 8111 NC		
650	Kubota ZB 600 C1			S 8111 NC		
800	Kubota D 950			S 8111 NC		
NDB Serie						
40 Eagle 2nd passage / 2.passaggio	Mercedes Benz OM636			S 0810 NR		
70 2nd passage / 2.passaggio some / alcuni	Perkins 4.108 Perkins 4.108		S 0420 R	S 0810 NR		
NDS Serie						
Falcon 2nd passage / 2.passaggio some / alcuni	Perkins 4.108 Perkins 4.108		S 0420 R	S 0810 NR		
Thunderbird						
500 2nd passage / 2.passaggio some / alcuni	Perkins 4.108 Perkins 4.108		S 0420 R	S 0810 NR		
NDF 425 2nd passage / 2.passaggio some / alcuni	CT 4.114 CT 4.114		S 0420 R	S 0810 NR	S 0840 A	
NDJ 425 2nd passage / 2.passaggio some / alcuni	CT 4.114 CT 4.114		S 0420 R	S 0810 NR	S 0840 A	
Thunderbird 2nd passage / 2.passaggio some / alcuni	Perkins 4.108 Perkins 4.108		S 0420 R	S 0810 NR		
UDE Serie						
Roadrunner 2nd passage / 2.passaggio some / alcuni	Perkins 4.108 Perkins 4.108		S 0420 R	S 0810 NR		
UDE 2nd passage / 2.passaggio	Mercedes Benz OM636			S 0810 NR		
UDG Serie						
UDG-AL 2nd passage / 2.passaggio	Mercedes Benz OM636			S 0810 NR		
UDG-BL 2nd passage / 2.passaggio	Mercedes Benz OM636			S 0810 NR		
CATERPILLAR						
off-highway trucks/autocarri fuoristrada						
760 Serie						
769 (N.1X1 -) spin-on / avvitabile inner / interno					S 7008 A S 7041 A	
769 (N.99F1 - 1229) spin-on / avvitabile cartridge / immersione				S 0810 NR	S 8350 A S 8350 A	
769 (N.99F1230) spin-on / avvitabile cartridge / immersione				S 0810 NR	S 8350 A S 8350 A	
769 (N.99F1231)						



kW HP



...CATERPILLAR - off-highway trucks/autocarri fuoristrada

spin-on / avvitabile cartridge / immersione 769 (N.99F1232 - 1237)				S 0810 NR	S 8350 A S 8350 A	
spin-on / avvitabile cartridge / immersione 769 (N.99F1238)				S 0810 NR	S 8350 A S 8350 A	
spin-on / avvitabile cartridge / immersione 769 (N.99F1239 -)				S 0810 NR	S 8350 A S 8350 A	
770 Serie						
773 (N.63G1 - 252) spin-on / avvitabile cartridge / immersione			S 1910 PO	S 0810 NR	S 8350 A S 8350 A	
773 (N.63G253 - 858) spin-on / avvitabile cartridge / immersione				S 0810 NR	S 8350 A S 8350 A	
773 (N.63G859 -) spin-on / avvitabile				S 0810 NR	S 8350 A	
773 (N.63W1 -) spin-on / avvitabile inner / interno					S 8350 A S 7041 A	
776 cartridge / immersione	D348		S 1910 PO			
776 B some outer / alcuni esterno some inner / alcuni interno	3508 3508				S 7A35 A S 7A36 A	
776 C (N.2TK1 -) inner / interno	3508 3508				S 7A35 A S 7A36 A	
777 (N.84A) cartridge / immersione			S 1910 PO		S 7033 A	
777 B inner / interno					S 3450 A	
777 C inner / interno					S 3450 A	
777 C (N.4XJ1 -) inner / interno	3508 3508				S 7A35 A S 7A36 A	
777 D (N.3PR1 -) inner / interno	3508B-EUI 3508B-EUI	699 953 699 953			S 7A35 A S 7A36 A	
779 cartridge / immersione inner / interno					S 7039 A S 7040 A	
780 Serie						
785 (N.8GB1 -) inner / interno					S 7308 A	
785 B (N.6HK00123 - 00126) inner / interno					S 7308 A	
785 B (N.6HK00129) inner / interno					S 7308 A	
785 B (N.6HK00216) inner / interno					S 7308 A	
789 (N.9ZC1 -) spin-on / avvitabile inner / interno					S 7315 A S 7314 A	
970 Serie						
977 (N.63G253 - 858) spin-on / avvitabile cartridge / immersione				S 0810 NR	S 8350 A S 8350 A	
CATERPILLAR articulated dump trucks/ribaltabili articolati						
D 22 Serie						
22 (N.9VA1 -) spin-on / avvitabile outer / esterno			S 0900 R	S 0810 NR	S 7033 A	
D 25 Serie						
25 (N.9VA1 -)						

C





kW HP



...CATERPILLAR - articulated dump trucks/ribaltabili articolati

spin-on / avvitabile outer / esterno		S 0900 R	S 0810 NR	S 7033 A	
25 B (N.9VA1 -)					
spin-on / avvitabile outer / esterno		S 0900 R	S 0810 NR	S 7033 A	
25 C (N.9YC1 -)					
spin-on / avvitabile		S 0900 R	S 0810 NR	S 7033 A	
D 250 Serie					
250 (N.9VA1 -)					
spin-on / avvitabile		S 0900 R	S 0810 NR	S 7033 A	
250 B (N.5WD1 -)					
spin-on / avvitabile		S 0900 R	S 0810 NR	S 7033 A	
D 275 Serie					
275 (N.9VA1 -)					
spin-on / avvitabile		S 0900 R	S 0810 NR	S 7033 A	
275 B (N.9VA1 -)					
spin-on / avvitabile		S 0900 R	S 0810 NR	S 7033 A	
D 30 Serie					
30 C (N.7ZC1 -)					
spin-on / avvitabile		S 0900 R	S 0810 NR	S 7033 A	
D 300 Serie					
300 (N.9VA1 -)					
spin-on / avvitabile		S 0900 R	S 0810 NR	S 7033 A	
D 330 Serie					
330 (N.9VA1 -)					
spin-on / avvitabile		S 0900 R	S 0810 NR	S 7033 A	
330 B (N.9VA1 -)					
spin-on / avvitabile		S 0900 R	S 0810 NR	S 7033 A	
D 35 Serie					
35 (N.9VA1 -)					
spin-on / avvitabile		S 0900 R	S 0810 NR	S 7033 A	
35 C (N.2GD1 -)					
spin-on / avvitabile		S 0900 R	S 0810 NR	S 7033 A	
35 C HP (N.3FD1 -)				S 7033 A	
D 350 Serie					
350 (N.9VA1 -)					
spin-on / avvitabile		S 0900 R	S 0810 NR	S 7033 A	
350 B (N.9VA1 -)					
spin-on / avvitabile		S 0900 R	S 0810 NR	S 7033 A	
350 C (N.8XC1 -)					
spin-on / avvitabile		S 0900 R	S 0810 NR	S 7033 A	
D 400 Serie					
400 (N.1MD1 -)				S 7033 A	
D 44 Serie					
44 (N.5VA1 -)				S 7008 A	
inner / interno				S 7041 A	
44 B (N.8SD1 -)				S 7008 A	
inner / interno				S 7041 A	
D 550 Serie					
550 (N.9VA1 -)				S 7008 A	
inner / interno				S 7041 A	
DAF					
trucks/autocarri					
10 Serie					
13	DA 575		S 6490 PO	S 8381 NC	
13	DD 575		S 6490 PO	S 8381 NC	
16	DA 575		S 6490 PO	S 8381 NC	
16	DD 575		S 6490 PO	S 8381 NC	
1000 Serie					
1100	DA 575		S 6490 PO	S 8381 NC	
1100	DD 575		S 6490 PO	S 8381 NC	
1300	DA 575		S 6490 PO	S 8381 NC	
1300	DD 575		S 6490 PO	S 8381 NC	
1600	DA 575		S 6490 PO	S 8381 NC	
1600	DD 575		S 6490 PO	S 8381 NC	
1800	DS 575			S 8381 NC	
spin-on / avvitabile	DS 575		S 8600 R		

**KW HP****...DAF - trucks/autocarri**

1900	DS 575				S 8600 R	S 8381 NC		
spin-on / avvitabile	DS 575							
400 Serie								
2.5 Diesel	Leyland					S 7111 NC		
2.5 Diesel	Peugeot				S 0130 R	S 7111 NC		
2.5 Turbodiesel	Peugeot				S 5630 R	S 8111 NC	S 7138 A	
45 Serie								
F45.120	CD85	85	116	05/91 > 12/00	S 3497 R			
dryer filter / filtro essiccatore	CD85	85	116	05/91 > 12/00				S 7259 A
power steering / servosterzo	CD85	85	116	05/91 > 12/00				S 3081 PO
F45.130	CN95	96	130	05/91 > 12/00	S 3497 R			
dryer filter / filtro essiccatore	CN95	96	130	05/91 > 12/00				S 7259 A
or / oppure	CN95	96	130	05/91 > 12/00			S 7479 A	
power steering / servosterzo	CN95	96	130	05/91 > 12/00				S 3081 PO
F45.150 T	CB107	108	147	05/91 > 12/00	S 3497 R			
	CB107	108	147	05/91 > 12/00			S 7479 A	
dryer filter / filtro essiccatore	CB107	108	147	05/91 > 12/00				S 7259 A
power steering / servosterzo	CB107	108	147	05/91 > 12/00				S 3081 PO
F45.160 T	CT119, CT119G	120	163	05/91 > 12/00	S 3497 R			
	CT119, CT119G	120	163	05/91 > 12/00			S 7479 A	
dryer filter / filtro essiccatore	CT119, CT119G	120	163	05/91 > 12/00				S 7259 A
power steering / servosterzo	CT119, CT119G	120	163	05/91 > 12/00				S 3081 PO
F45.180 T	CS134	134	182	11/95 > 12/00	S 3497 R			
	CS134	134	182	11/95 > 12/00			S 7479 A	
dryer filter / filtro essiccatore	CS134	134	182	11/95 > 12/00				S 7259 A
power steering / servosterzo	CS134	134	182	11/95 > 12/00				S 3081 PO
F45.210 T	CS156	158	215	11/95 > 12/00	S 3497 R			
	CS156	158	215	11/95 > 12/00			S 7479 A	
dryer filter / filtro essiccatore	CS156	158	215	11/95 > 12/00				S 7259 A
power steering / servosterzo	CS156	158	215	11/95 > 12/00				S 3081 PO
55 Serie								
F55.150 Ti	CS107M	107	146	11/95 > 12/00	S 3497 R			
dryer filter / filtro essiccatore	CS107M	107	146	11/95 > 12/00			S 7A17 A	
power steering / servosterzo	CS107M	107	146	11/95 > 12/00				S 7259 A
								S 3081 PO
F55.180 Ti	CS134	134	182	11/95 > 12/00	S 3497 R			
dryer filter / filtro essiccatore	CS134	134	182	11/95 > 12/00			S 7A17 A	
power steering / servosterzo	CS134	134	182	11/95 > 12/00				S 7259 A
								S 3081 PO
F55.210 Ti	CS156	156	215	11/95 > 12/00	S 3497 R			
power steering / servosterzo	CS156	156	215	11/95 > 12/00			S 7A17 A	
								S 3081 PO
F55.230 Ti	CS174	173	235	11/95 > 12/00	S 3497 R			
dryer filter / filtro essiccatore	CS174	173	235	11/95 > 12/00			S 7A17 A	
power steering / servosterzo	CS174	173	235	11/95 > 12/00				S 7259 A
								S 3081 PO
65 Serie								
F65.180 ATi	NS133L	133	180	03/93 > 05/98	S 8600 R	S 4337 NR	S 7428 A	
dryer filter / filtro essiccatore	NS133L	133	180	03/93 > 05/98				S 7259 A
power steering / servosterzo	NS133L	133	180	03/93 > 05/98				S 3081 PO
F65.210 ATi	NS156L	156	210	03/93 > 05/98	S 8600 R	S 4337 NR	S 7428 A	
dryer filter / filtro essiccatore	NS156L	156	210	03/93 > 05/98				S 7259 A
power steering / servosterzo	NS156L	156	210	03/93 > 05/98				S 3081 PO
F65.240 ATi	NS177M	177	240	05/96 > 05/98	S 8600 R	S 4337 NR	S 7428 A	
dryer filter / filtro essiccatore	NS177M	177	240	05/96 > 05/98				S 7259 A
power steering / servosterzo	NS177M	177	240	05/96 > 05/98				S 3081 PO
65CF Serie								
65CF.180	CEC136 Euro3	136	185	07/00 >	S 0620 R	S 2220 NR		
dryer filter / filtro essiccatore	CEC136 Euro3	136	185	07/00 >				S 3139 C
assembly MANN+HUMMEL / montaggio MANN+HUMMEL	CEC136 Euro3	136	185	07/00 >			S 7A16 A	S 7393 A
power steering / servosterzo	CEC136 Euro3	136	185	07/00 >				S 3081 PO
65CF.180	NS133M Euro2	132	180	03/98 > 12/00		S 4337 NR	S 7A15 A	
dryer filter / filtro essiccatore	NS133M Euro2	132	180	03/98 > 12/00				S 3092 C
power steering / servosterzo	NS133M Euro2	132	180	03/98 > 12/00				S 7259 A
								S 3081 PO
65CF.210	NS156M Euro2	154	210	03/98 > 12/00		S 4337 NR	S 7A15 A	
dryer filter / filtro essiccatore	NS156M Euro2	154	210	03/98 > 12/00				S 3092 C
power steering / servosterzo	NS156M Euro2	154	210	03/98 > 12/00				S 7259 A
								S 3081 PO
65CF.220	CEC162 Euro3	162	220	07/00 >	S 0620 R	S 2220 NR		
dryer filter / filtro essiccatore	CEC162 Euro3	162	220	07/00 >				S 3139 C
assembly MANN+HUMMEL / montaggio MANN+HUMMEL	CEC162 Euro3	162	220	07/00 >			S 7A16 A	S 7393 A
power steering / servosterzo	CEC162 Euro3	162	220	07/00 >				S 3081 PO





...DAF - trucks/autocarri

D

65CF.240	NS177M Euro2	176	240	03/98	>	12/00		S 4337 NR	S 7A15 A	S 3092 C
dryer filter / filtro essiccatore	NS177M Euro2	176	240	03/98	>	12/00				S 7259 A
power steering / servosterzo	NS177M Euro2	176	240	03/98	>	12/00				S 3081 PO
65CF.250	CEC184 Euro3	184	250	07/00	>		S 0620 R	S 2220 NR		S 3139 C
dryer filter / filtro essiccatore	CEC184 Euro3	184	250	07/00	>					S 7393 A
assembly MANN+HUMMEL / montaggio MANN+HUMMEL	CEC184 Euro3	184	250	07/00	>				S 7A16 A	
power steering / servosterzo	CEC184 Euro3	184	250	07/00	>					S 3081 PO
CF65.220	Paccar GR165	165	224	07/06	>		S 0620 R	S 2220 NR		S 3139 C
with activated carbons / ai carboni attivi	Paccar GR165	165	224	07/06	>					S 4347 CA
with filter MANN+HUMMEL / con filtro MANN+HUMMEL	Paccar GR165	165	224	07/06	>				S 7573 A	
with filter SCR-System / con filtro SCR-System	Paccar GR165	165	224	07/06	>					S 7A86 A
with filter Urea/Adblue / con filtro Urea/Adblue	Paccar GR165	165	224	07/06	>					S 4403 U
dryer filter / filtro essiccatore	Paccar GR165	165	224	07/06	>					S 7393 A
prefilter PARKER-RACOR / prefiltro PARKER-RACOR	Paccar GR165	165	224	07/06	>			S 4143 NR		
power steering / servosterzo	Paccar GR165	165	224	07/06	>					S 3081 PO
CF65.250	Paccar GR184	184	250	07/06	>		S 0620 R	S 2220 NR		S 3139 C
with filter SCR-System / con filtro SCR-System	Paccar GR184	184	250	07/06	>					S 7A86 A
with filter Urea/Adblue / con filtro Urea/Adblue	Paccar GR184	184	250	07/06	>					S 4403 U
power steering / servosterzo	Paccar GR184	184	250	07/06	>					S 3081 PO
CF65.290	Paccar GR210	210	286	07/06	>		S 0620 R	S 2220 NR		S 3139 C
with filter SCR-System / con filtro SCR-System	Paccar GR210	210	286	07/06	>					S 7A86 A
with filter Urea/Adblue / con filtro Urea/Adblue	Paccar GR210	210	286	07/06	>					S 4403 U
power steering / servosterzo	Paccar GR210	210	286	07/06	>					S 3081 PO
CF65.300	Paccar GR220	220	300	01/09	>		S 0620 R	S 2220 NR		S 3139 C
power steering / servosterzo	Paccar GR220	220	300	01/09	>					S 3081 PO
75 Serie										
FA75.240 ATi	RS180L	180	245	07/92	>	08/96	S 3408 R	S 8110 NR	S 7428 A	
	RS180L	180	245	09/96	>	05/98	S 3408 R	S 4337 NR	S 7428 A	
with automatic gearbox and hydraulic retarder ZF / con cambio automatico e rallentatore idraulico ZF	RS180L	180	245	07/92	>	05/98				S 2234 Z
dryer filter / filtro essiccatore	RS180L	180	245	07/92	>	05/98				S 7259 A
power steering / servosterzo	RS180L	180	245	07/92	>	05/98				S 3081 PO
FA75.270 ATi	RS200L	200	272	07/92	>	08/96	S 3408 R	S 8110 NR	S 7428 A	
	RS200L	200	272	09/96	>	05/98	S 3408 R	S 4337 NR	S 7428 A	
with automatic gearbox and hydraulic retarder ZF / con cambio automatico e rallentatore idraulico ZF	RS200L	200	272	07/92	>	05/98				S 2234 Z
dryer filter / filtro essiccatore	RS200L	200	272	07/92	>	05/98				S 7259 A
power steering / servosterzo	RS200L	200	272	07/92	>	05/98				S 3081 PO
FA75.300 ATi	RS222L	222	302	07/92	>	08/96	S 3408 R	S 8110 NR	S 7428 A	
	RS222L	222	302	09/96	>	05/98	S 3408 R	S 4337 NR	S 7428 A	
with automatic gearbox and hydraulic retarder ZF / con cambio automatico e rallentatore idraulico ZF	RS222L	222	302	07/92	>	05/98				S 2234 Z
dryer filter / filtro essiccatore	RS222L	222	302	07/92	>	05/98				S 7259 A
power steering / servosterzo	RS222L	222	302	07/92	>	05/98				S 3081 PO
FT75.240 ATi	RS180L	180	245	07/92	>	08/96	S 3408 R	S 8110 NR	S 7428 A	
	RS180L	180	245	09/96	>	05/98	S 3408 R	S 4337 NR	S 7428 A	
with automatic gearbox and hydraulic retarder ZF / con cambio automatico e rallentatore idraulico ZF	RS180L	180	245	07/92	>	05/98				S 2234 Z
dryer filter / filtro essiccatore	RS180L	180	245	07/92	>	05/98				S 7259 A
power steering / servosterzo	RS180L	180	245	07/92	>	05/98				S 3081 PO
FT75.270 ATi	RS200L	200	272	07/92	>	08/96	S 3408 R	S 8110 NR	S 7428 A	
	RS200L	200	272	09/96	>	05/98	S 3408 R	S 4337 NR	S 7428 A	
with automatic gearbox and hydraulic retarder ZF / con cambio automatico e rallentatore idraulico ZF	RS200L	200	272	07/92	>	05/98				S 2234 Z
dryer filter / filtro essiccatore	RS200L	200	272	07/92	>	05/98				S 7259 A
power steering / servosterzo	RS200L	200	272	07/92	>	05/98				S 3081 PO
FT75.300 ATi	RS222L	222	302	07/92	>	08/96	S 3408 R	S 8110 NR	S 7428 A	
	RS222L	222	302	09/96	>	05/98	S 3408 R	S 4337 NR	S 7428 A	
with automatic gearbox and hydraulic retarder ZF / con cambio automatico e rallentatore idraulico ZF	RS222L	222	302	07/92	>	05/98				S 2234 Z
dryer filter / filtro essiccatore	RS222L	222	302	07/92	>	05/98				S 7259 A
power steering / servosterzo	RS222L	222	302	07/92	>	05/98				S 3081 PO
75CF Serie										
75CF.250	PE183C Euro3	183	250	07/00	>	04/06	S 5045 PE	S 6009 NE		S 3092 C
	PE183C Euro3	183	250	05/06	>		S 5045 PE	S 6009 NE		S 3139 C
with activated carbons / ai carboni attivi	PE183C Euro3	183	250	05/06	>					S 4347 CA
with automatic gearbox and hydraulic retarder ZF / con cambio automatico e rallentatore idraulico ZF	PE183C Euro3	183	250	07/00	>					S 2234 Z
dryer filter / filtro essiccatore	PE183C Euro3	183	250	07/00	>					S 7393 A
LONG LIFE	PE183C Euro3	183	250	07/00	>		S 5234 PE	S 6146 NE		
assembly DONALDSON / montaggio DONALDSON	PE183C Euro3	183	250	07/00	>				S 7A59 A	
assembly MANN+HUMMEL / montaggio MANN+HUMMEL	PE183C Euro3	183	250	07/00	>				S 7A16 A	
prefilter MANN+HUMMEL Preline / prefiltro MANN+HUMMEL Preline	PE183C Euro3	183	250	07/00	>			S 4142 NR		
prefilter PARKER-RACOR / prefiltro PARKER-RACOR	PE183C Euro3	183	250	07/00	>			S 4143 NR		

**KW HP**

...DAF - trucks/autocarri

rotor for oil centrifuge / rotore per filtro olio centrifugo	PE183C Euro3	183	250	07/00	>	S 5902 PO			
power steering / servosterzo	PE183C Euro3	183	250	07/00	>				S 3081 PO
75CF.250	PF183M Euro2	183	250	03/98	> 12/00		S 4337 NR	S 7A15 A	S 3092 C
with automatic gearbox and hydraulic retarder ZF / con cambio automatico e rallentatore idraulico ZF	PF183M Euro2	183	250	03/98	> 12/00				S 2234 Z
dryer filter / filtro essiccatore	PF183M Euro2	183	250	03/98	> 12/00				S 7259 A
power steering / servosterzo	PF183M Euro2	183	250	03/98	> 12/00				S 3081 PO
75CF.290	PF212M Euro2	213	290	03/98	> 12/00		S 4337 NR	S 7A15 A	S 3092 C
with automatic gearbox and hydraulic retarder ZF / con cambio automatico e rallentatore idraulico ZF	PF212M Euro2	213	290	03/98	> 12/00				S 2234 Z
dryer filter / filtro essiccatore	PF212M Euro2	213	290	03/98	> 12/00				S 7259 A
power steering / servosterzo	PF212M Euro2	213	290	03/98	> 12/00				S 3081 PO
75CF.310	PE228C Euro3	228	310	07/00	>	S 5045 PE	S 6009 NE	S 7A16 A	S 3139 C
with automatic gearbox and hydraulic retarder ZF / con cambio automatico e rallentatore idraulico ZF	PE228C Euro3	228	310	07/00	>				S 2234 Z
dryer filter / filtro essiccatore	PE228C Euro3	228	310	07/00	>				S 7393 A
power steering / servosterzo	PE228C Euro3	228	310	07/00	>				S 3081 PO
75CF.320	PF235M Euro2	235	320	03/98	> 12/00		S 4337 NR	S 7A15 A	S 3092 C
with automatic gearbox and hydraulic retarder ZF / con cambio automatico e rallentatore idraulico ZF	PF235M Euro2	235	320	03/98	> 12/00				S 2234 Z
dryer filter / filtro essiccatore	PF235M Euro2	235	320	03/98	> 12/00				S 7259 A
power steering / servosterzo	PF235M Euro2	235	320	03/98	> 12/00				S 3081 PO
75CF.360	PE262C Euro3	265	360	07/00	>	S 5045 PE	S 6009 NE	S 7A16 A	S 3139 C
with automatic gearbox and hydraulic retarder ZF / con cambio automatico e rallentatore idraulico ZF	PE262C Euro3	265	360	07/00	>				S 2234 Z
dryer filter / filtro essiccatore	PE262C Euro3	265	360	07/00	>				S 7393 A
power steering / servosterzo	PE262C Euro3	265	360	07/00	>				S 3081 PO
CF75.250	Paccar PR183S Euro4/5	183	250	05/06	>	S 5045 PE	S 6024 NE		S 3139 C
with activated carbons / ai carboni attivi	Paccar PR183S Euro4/5	183	250	05/06	>				S 4347 CA
with automatic gearbox ZF Ecosplit + Intarder / con cambio automatico ZF Ecosplit + Intarder	Paccar PR183S Euro4/5	183	250	05/06	>				S 2234 Z
with filter SCR-System / con filtro SCR-System	Paccar PR183S Euro4/5	183	250	05/06	>				S 7A86 A
with filter Urea/Adblue / con filtro Urea/Adblue	Paccar PR183S Euro4/5	183	250	05/06	>				S 4403 U
dryer filter / filtro essiccatore	Paccar PR183S Euro4/5	183	250	05/06	>				S 7393 A
LONG LIFE	Paccar PR183S Euro4/5	183	250	05/06	>	S 5234 PE			
prefilter MANN+HUMMEL Preline / prefilto MANN+HUMMEL Preline	Paccar PR183S Euro4/5	183	250	05/06	>		S 4142 NR		
prefilter PARKER-RACOR / prefilto PARKER-RACOR	Paccar PR183S Euro4/5	183	250	05/06	>		S 4143 NR		
power steering / servosterzo	Paccar PR183S Euro4/5	183	250	05/06	>				S 3081 PO
CF75.310	Paccar PR228S Euro4/5	228	310	05/06	>	S 5045 PE	S 6024 NE		S 3139 C
with activated carbons / ai carboni attivi	Paccar PR228S Euro4/5	228	310	05/06	>				S 4347 CA
with automatic gearbox ZF Ecosplit + Intarder / con cambio automatico ZF Ecosplit + Intarder	Paccar PR228S Euro4/5	228	310	05/06	>				S 2234 Z
with filter SCR-System / con filtro SCR-System	Paccar PR228S Euro4/5	228	310	05/06	>				S 7A86 A
with filter Urea/Adblue / con filtro Urea/Adblue	Paccar PR228S Euro4/5	228	310	05/06	>				S 4403 U
dryer filter / filtro essiccatore	Paccar PR228S Euro4/5	228	310	05/06	>				S 7393 A
LONG LIFE	Paccar PR228S Euro4/5	228	310	05/06	>	S 5234 PE			
prefilter MANN+HUMMEL Preline / prefilto MANN+HUMMEL Preline	Paccar PR228S Euro4/5	228	310	05/06	>		S 4142 NR		
prefilter PARKER-RACOR / prefilto PARKER-RACOR	Paccar PR228S Euro4/5	228	310	05/06	>		S 4143 NR		
power steering / servosterzo	Paccar PR228S Euro4/5	228	310	05/06	>				S 3081 PO
CF75.360	Paccar PR265S Euro4/5	265	360	05/06	>	S 5045 PE	S 6024 NE		S 3139 C
with activated carbons / ai carboni attivi	Paccar PR265S Euro4/5	265	360	05/06	>				S 4347 CA
with automatic gearbox ZF Ecosplit + Intarder / con cambio automatico ZF Ecosplit + Intarder	Paccar PR265S Euro4/5	265	360	05/06	>				S 2234 Z
with filter SCR-System / con filtro SCR-System	Paccar PR265S Euro4/5	265	360	05/06	>				S 7A86 A
with filter Urea/Adblue / con filtro Urea/Adblue	Paccar PR265S Euro4/5	265	360	05/06	>				S 4403 U
dryer filter / filtro essiccatore	Paccar PR265S Euro4/5	265	360	05/06	>				S 7393 A
LONG LIFE	Paccar PR265S Euro4/5	265	360	05/06	>	S 5234 PE			
prefilter MANN+HUMMEL Preline / prefilto MANN+HUMMEL Preline	Paccar PR265S Euro4/5	265	360	05/06	>		S 4142 NR		
prefilter PARKER-RACOR / prefilto PARKER-RACOR	Paccar PR265S Euro4/5	265	360	05/06	>		S 4143 NR		
power steering / servosterzo	Paccar PR265S Euro4/5	265	360	05/06	>				S 3081 PO
85 Serie									
FA85.300 ATI	WS222L	222	302	07/92	> 08/96	S 3275 R	S 8110 NR	S 7428 A	
	WS222L	222	302	09/96	> 05/98	S 3408 R	S 4337 NR	S 7428 A	
dryer filter / filtro essiccatore	WS222L	222	302	07/92	> 05/98				S 7259 A
power steering / servosterzo	WS222L	222	302	07/92	> 05/98				S 3081 PO
FA85.330 ATI	WS242L	242	330	07/92	> 08/96	S 3275 R	S 8110 NR	S 7428 A	
	WS242L	242	330	09/96	> 05/98	S 3408 R	S 4337 NR	S 7428 A	
dryer filter / filtro essiccatore	WS242L	242	330	07/92	> 05/98				S 7259 A
power steering / servosterzo	WS242L	242	330	07/92	> 05/98				S 3081 PO
FA85.360 ATI	WS268L	268	365	07/92	> 08/96	S 3275 R	S 8110 NR	S 7428 A	
	WS268L	268	365	09/96	> 05/98	S 3408 R	S 4337 NR	S 7428 A	
dryer filter / filtro essiccatore	WS268L	268	365	07/92	> 05/98				S 7259 A
power steering / servosterzo	WS268L	268	365	07/92	> 05/98				S 3081 PO
FA85.400 ATI	WS295M	295	401	03/95	> 08/96	S 3275 R	S 8110 NR		
	WS295M	295	401	09/96	> 05/98	S 3408 R	S 4337 NR		



**kW HP****...DAF - trucks/autocarri****D**

dryer filter / filtro essiccatore	WS295M	295	401	03/95	>	05/98				S 7259 A
power steering / servosterzo	WS295M	295	401	03/95	>	05/98				S 3081 PO
FT85.330 ATI	WS222L	222	302	07/92	>	08/96	S 3275 R	S 8110 NR	S 7428 A	
	WS222L	222	302	09/96	>	05/98	S 3408 R	S 4337 NR	S 7428 A	
dryer filter / filtro essiccatore	WS222L	222	302	07/92	>	05/98				S 7259 A
power steering / servosterzo	WS222L	222	302	07/92	>	05/98				S 3081 PO
FT85.330 ATI	WS242L	242	330	07/92	>	08/96	S 3275 R	S 8110 NR	S 7428 A	
	WS242L	242	330	09/96	>	05/98	S 3408 R	S 4337 NR	S 7428 A	
dryer filter / filtro essiccatore	WS242L	242	330	07/92	>	05/98				S 7259 A
power steering / servosterzo	WS242L	242	330	07/92	>	05/98				S 3081 PO
FT85.360 ATI	WS268L	268	365	07/92	>	08/96	S 3275 R	S 8110 NR	S 7428 A	
	WS268L	268	365	09/96	>	05/98	S 3408 R	S 4337 NR	S 7428 A	
dryer filter / filtro essiccatore	WS268L	268	365	07/92	>	05/98				S 7259 A
power steering / servosterzo	WS268L	268	365	07/92	>	05/98				S 3081 PO
FT85.400 ATI	WS295M	295	401	03/95	>	08/96	S 3275 R	S 8110 NR		
	WS295M	295	401	09/96	>	05/98	S 3408 R	S 4337 NR		
dryer filter / filtro essiccatore	WS295M	295	401	07/92	>	05/98				S 7259 A
power steering / servosterzo	WS295M	295	401	03/95	>	05/98				S 3081 PO
85CF Serie										
85CF.340	XE250C Euro3	249	340	07/00	>		S 5045 PE	S 6009 NE		S 3139 C
with automatic gearbox and hydraulic retarder ZF / con cambio automatico e rallentatore idraulico ZF	XE250C Euro3	249	340	07/00	>					S 2234 Z
dryer filter / filtro essiccatore	XE250C Euro3	249	340	07/00	>					S 7393 A
LONG LIFE	XE250C Euro3	249	340	07/00	>		S 5234 PE	S 6146 NE		
power steering / servosterzo	XE250C Euro3	249	340	07/00	>					S 3081 PO
85CF.340	XF250M Euro2	249	340	03/98	>	12/00	S 3010 R	S 4337 NR	S 7428 A	S 3092 C
with automatic gearbox and hydraulic retarder ZF / con cambio automatico e rallentatore idraulico ZF	XF250M Euro2	249	340	03/98	>	12/00				S 2234 Z
dryer filter / filtro essiccatore	XF250M Euro2	249	340	03/98	>	12/00				S 7259 A
power steering / servosterzo	XF250M Euro2	249	340	03/98	>	12/00				S 3081 PO
85CF.380	XE280C Euro3	279	380	07/00	>		S 5045 PE	S 6009 NE		S 3139 C
with automatic gearbox and hydraulic retarder ZF / con cambio automatico e rallentatore idraulico ZF	XE280C Euro3	279	380	07/00	>					S 2234 Z
dryer filter / filtro essiccatore	XE280C Euro3	279	380	07/00	>					S 7393 A
LONG LIFE	XE280C Euro3	279	380	07/00	>		S 5234 PE	S 6146 NE		
power steering / servosterzo	XE280C Euro3	279	380	07/00	>					S 3081 PO
85CF.380	XF280M Euro2	279	380	03/98	>	12/00	S 3010 R	S 4337 NR	S 7428 A	S 3092 C
with automatic gearbox and hydraulic retarder ZF / con cambio automatico e rallentatore idraulico ZF	XF280M Euro2	279	380	03/98	>	12/00				S 2234 Z
dryer filter / filtro essiccatore	XF280M Euro2	279	380	03/98	>	12/00				S 7259 A
power steering / servosterzo	XF280M Euro2	279	380	03/98	>	12/00				S 3081 PO
85CF.430	XE315C Euro3	314	428	07/00	>		S 5045 PE	S 6009 NE		S 2234 Z
with automatic gearbox and hydraulic retarder ZF / con cambio automatico e rallentatore idraulico ZF	XE315C Euro3	314	428	07/00	>					S 7393 A
dryer filter / filtro essiccatore	XE315C Euro3	314	428	07/00	>					S 3081 PO
power steering / servosterzo	XE315C Euro3	314	428	07/00	>					S 3081 PO
85CF.430	XF315M Euro2	314	428	03/98	>	12/00	S 3010 R	S 4337 NR	S 7428 A	S 3092 C
with automatic gearbox and hydraulic retarder ZF / con cambio automatico e rallentatore idraulico ZF	XF315M Euro2	314	428	03/98	>	12/00				S 2234 Z
dryer filter / filtro essiccatore	XF315M Euro2	314	428	03/98	>	12/00				S 7259 A
power steering / servosterzo	XF315M Euro2	314	428	03/98	>	12/00				S 3081 PO
85CF.480	XE355C Euro3	355	480	07/00	>		S 5045 PE	S 6009 NE	S 7409 A	S 3139 C
with automatic gearbox and hydraulic retarder ZF / con cambio automatico e rallentatore idraulico ZF	XE355C Euro3	355	480	07/00	>					S 2234 Z
dryer filter / filtro essiccatore	XE355C Euro3	355	480	07/00	>					S 7393 A
LONG LIFE	XE355C Euro3	355	480	07/00	>		S 5234 PE	S 6146 NE		
power steering / servosterzo	XE355C Euro3	355	480	07/00	>					S 3081 PO
CF85.360	MX265S	265	360	09/06	>		S 5081 PE	S 6024 NE		S 3139 C
with filter SCR-System / con filtro SCR-System	MX265S	265	360	09/06	>					S 7A86 A
with filter Urea/Adblue / con filtro Urea/Adblue	MX265S	265	360	09/06	>					S 4403 U
power steering / servosterzo	MX265S	265	360	09/06	>					S 3081 PO
CF85.410	MX300S	300	410	05/06	>		S 5081 PE	S 6024 NE		S 3139 C
with filter SCR-System / con filtro SCR-System	MX300S	300	410	05/06	>					S 7A86 A
with filter Urea/Adblue / con filtro Urea/Adblue	MX300S	300	410	05/06	>					S 4403 U
power steering / servosterzo	MX300S	300	410	05/06	>					S 3081 PO
CF85.460	MX340S	340	462	05/06	>		S 5081 PE	S 6024 NE		S 3139 C
with filter SCR-System / con filtro SCR-System	MX340S	340	462	05/06	>					S 7A86 A
with filter Urea/Adblue / con filtro Urea/Adblue	MX340S	340	462	05/06	>					S 4403 U
power steering / servosterzo	MX340S	340	462	05/06	>					S 3081 PO
CF85.510	MX375S	375	510	05/06	>		S 5081 PE	S 6024 NE		S 3139 C
with filter SCR-System / con filtro SCR-System	MX375S	375	510	05/06	>					S 7A86 A
with filter Urea/Adblue / con filtro Urea/Adblue	MX375S	375	510	05/06	>					S 4403 U
power steering / servosterzo	MX375S	375	510	05/06	>					S 3081 PO

95 Serie

**KW HP****...DAF - trucks/autocarri**

F95.330 ATi	WS242	242	330	08/90 >	08/96	S 3275 R	S 8110 NR	S 8570 A	
	WS242	242	330	09/96 >	05/97	S 3275 R	S 4337 NR	S 8570 A	
dryer filter / filtro essiccatore	WS242	242	330	08/90 >	05/97				S 7259 A
power steering / servosterzo	WS242	242	330	08/90 >	05/97				S 3081 PO
F95.360 ATi	WS268	268	365	08/90 >	08/96	S 3275 R	S 8110 NR	S 8570 A	
	WS268	268	365	09/96 >	05/97	S 3275 R	S 4337 NR	S 8570 A	
dryer filter / filtro essiccatore	WS268	268	365	08/90 >	05/97				S 7259 A
power steering / servosterzo	WS268	268	365	08/90 >	05/97				S 3081 PO
F95.360 ATi	WS270	268	365	09/87 >	07/90	S 3275 R	S 8110 NR	S 8570 A	
	WS270	268	365	09/87 >	07/90				S 7259 A
dryer filter / filtro essiccatore	WS270	268	365	09/87 >	07/90				S 3081 PO
power steering / servosterzo	WS270	268	365	09/87 >	07/90				S 3081 PO
F95.400 ATi	WS295	295	401	08/90 >	08/96	S 3275 R	S 8110 NR	S 8570 A	
	WS295	295	401	09/96 >	05/97	S 3275 R	S 4337 NR	S 8570 A	
dryer filter / filtro essiccatore	WS295	295	401	08/90 >	05/97				S 7259 A
power steering / servosterzo	WS295	295	401	08/90 >	05/97				S 3081 PO
F95.430 ATi	WS315G	315	428	07/92 >	08/96	S 3275 R	S 8110 NR	S 8570 A	
	WS315G	315	428	09/96 >	05/97	S 3275 R	S 4337 NR	S 8570 A	
dryer filter / filtro essiccatore	WS315G	315	428	07/92 >	05/97				S 7259 A
power steering / servosterzo	WS315G	315	428	07/92 >	05/97				S 3081 PO
F95.500	Cummins N500E	373	507	05/94 >	05/97		S 4478 NR		
dryer filter / filtro essiccatore	Cummins N500E	373	507	05/94 >	05/97				S 7259 A
power steering / servosterzo	Cummins N500E	373	507	05/94 >	05/97				S 3081 PO
FA95.310 ATi	WS225	225	306	09/87 >	08/96	S 3275 R	S 8110 NR	S 8570 A	
	WS225	225	306	09/96 >	05/97	S 3275 R	S 4337 NR	S 8570 A	
dryer filter / filtro essiccatore	WS225	225	306	09/87 >	05/97				S 7259 A
power steering / servosterzo	WS225	225	306	09/87 >	05/97				S 3081 PO
FA95.350 ATi	WS259	259	352	09/87 >	08/96	S 3275 R	S 8110 NR	S 8570 A	
	WS259	259	352	09/96 >	05/97	S 3275 R	S 4337 NR	S 8570 A	
dryer filter / filtro essiccatore	WS259	259	352	09/87 >	05/97				S 7259 A
power steering / servosterzo	WS259	259	352	09/87 >	05/97				S 3081 PO
FA95.380 ATi	WS282L	282	383	09/87 >	08/96	S 3275 R	S 8110 NR	S 8570 A	
	WS282L	282	383	09/96 >	05/97	S 3275 R	S 4337 NR	S 8570 A	
dryer filter / filtro essiccatore	WS282L	282	383	09/87 >	05/97				S 7259 A
power steering / servosterzo	WS282L	282	383	09/87 >	05/97				S 3081 PO
FT95.310 ATi	WS225	225	306	09/87 >	08/96	S 3275 R	S 8110 NR	S 8570 A	
	WS225	225	306	09/96 >	05/97	S 3275 R	S 4337 NR	S 8570 A	
dryer filter / filtro essiccatore	WS225	225	306	09/87 >	05/97				S 7259 A
power steering / servosterzo	WS225	225	306	09/87 >	05/97				S 3081 PO
FT95.350 ATi	WS259	259	352	09/87 >	08/96	S 3275 R	S 8110 NR	S 8570 A	
	WS259	259	352	09/96 >	05/97	S 3275 R	S 4337 NR	S 8570 A	
dryer filter / filtro essiccatore	WS259	259	352	08/87 >	05/97				S 7259 A
power steering / servosterzo	WS259	259	352	09/87 >	05/97				S 3081 PO
FT95.380 ATi	WS282L	282	383	09/87 >	08/96	S 3275 R	S 8110 NR	S 8570 A	
	WS282L	282	383	09/96 >	05/97	S 3275 R	S 4337 NR	S 8570 A	
dryer filter / filtro essiccatore	WS282L	282	383	09/87 >	05/97				S 7259 A
power steering / servosterzo	WS282L	282	383	09/87 >	05/97				S 3081 PO
95XF Serie									
95XF.380	XE280C (Euro 3)	280	382	09/02 >		S 5045 PE	S 6009 NE	S 7371 A	S 3062 C
with automatic gearbox and hydraulic retarder ZF / con cambio automatico e rallentatore idraulico ZF	XE280C (Euro 3)	280	382	09/02 >					S 2234 Z
dryer filter / filtro essiccatore	XE280C (Euro 3)	280	382	09/02 >					S 7393 A
DONALDSON assembly flame retardant media / montaggio DONALDSON media filtrante ritardante di fiamma	XE280C (Euro 3)	280	382	09/02 >				S 7A59 A	
power steering / servosterzo	XE280C (Euro 3)	280	382	09/02 >					S 3081 PO
95XF.380	XF280M	280	382	03/97 >	10/02	S 3010 R	S 4337 NR	S 9870 A	S 3062 C
to frame No. OE490600 / a telaio N. OE490600	XF280M	280	382	09/99 >	10/02		S 6089 NE		
with manual pump prefilter / con pompa manuale prefiltrato	XF280M	280	382	03/97 >	10/02	S 3010 R	S 4337 NR	S 7371 A	S 3062 C
from frame No. OE490601 / da telaio N. OE490601	XF280M	280	382	03/97 >	10/02				S 7259 A
dryer filter / filtro essiccatore	XF280M	280	382	03/97 >	10/02				S 7A59 A
flame retardant media from frame No. OE490601 / media filtrante ritardante di fiamma da telaio N. OE490601	XF280M	280	382	03/97 >	10/02				S 3081 PO
power steering / servosterzo	XF280M	280	382	03/97 >	10/02				S 3081 PO
95XF.430	XE315C (Euro 3)	315	430	09/02 >		S 5045 PE	S 6009 NE	S 7371 A	S 3062 C
with automatic gearbox and hydraulic retarder ZF / con cambio automatico e rallentatore idraulico ZF	XE315C (Euro 3)	315	430	09/02 >					S 2234 Z
dryer filter / filtro essiccatore	XE315C (Euro 3)	315	430	09/02 >					S 7393 A
DONALDSON assembly flame retardant media / montaggio DONALDSON media filtrante ritardante di fiamma	XE315C (Euro 3)	315	430	09/02 >				S 7A59 A	
power steering / servosterzo	XE315C (Euro 3)	315	430	09/02 >					S 3081 PO
95XF.430	XF315M	315	430	03/97 >	10/02	S 3010 R	S 4337 NR	S 9870 A	S 3062 C
to frame No. OE490600 / a telaio N. OE490600	XF315M	315	430	09/99 >	10/02		S 6089 NE		
with manual pump prefilter / con pompa manuale prefiltrato	XF315M	315	430	09/99 >	10/02				

D



...DAF - trucks/autocarri

D



from frame No. OE490601 / da telaio N. OE490601	XF315M	315	430	03/97 >	10/02	S 3010 R	S 4337 NR	S 7371 A	S 3062 C
dryer filter / filtro essiccatore	XF315M	315	430	03/97 >	10/02				S 7259 A
flame retardant media from frame No. OE490601 / media filtrante ritardante di fiamma da telaio N. OE490601	XF315M	315	430	03/97 >	10/02			S 7A59 A	
power steering / servosterzo	XF315M	315	430	03/97 >	10/02				S 3081 PO
95XF.480	XE355C (Euro 3)	355	484	09/02 >		S 5045 PE	S 6009 NE	S 7371 A	S 3062 C
with automatic gearbox and hydraulic retarder ZF / con cambio automatico e rallentatore idraulico ZF	XE355C (Euro 3)	355	484	09/02 >					S 2234 Z
dryer filter / filtro essiccatore	XE355C (Euro 3)	355	484	09/02 >					S 7393 A
DONALDSON assembly flame retardant media / montaggio DONALDSON media filtrante ritardante di fiamma	XE355C (Euro 3)	355	484	09/02 >				S 7A59 A	
power steering / servosterzo	XE355C (Euro 3)	355	484	09/02 >					S 3081 PO
95XF.480									
to frame No. OE490600 / a telaio N. OE490600	XF355M	355	480	03/97 >	10/02	S 3010 R	S 4337 NR	S 9870 A	S 3062 C
with manual pump prefilter / con pompa manuale prefiltra	XF355M	355	480	09/99 >	10/02		S 6089 NE		
from frame No. OE490601 / da telaio N. OE490601	XF355M	355	480	03/97 >	10/02	S 3010 R	S 4337 NR	S 7371 A	S 3062 C
flame retardant media from frame No. OE490601 / media filtrante ritardante di fiamma da telaio N. OE490601	XF355M	355	480	03/97 >	10/02			S 7A59 A	
power steering / servosterzo	XF355M	355	480	03/97 >	10/02				S 3081 PO
95XF.530	Cummins VF390M	390	530	03/97 >	10/99	S 3010 R	S 4478 NR		S 3062 C
with automatic gearbox and hydraulic retarder ZF / con cambio automatico e rallentatore idraulico ZF	Cummins VF390M	390	530	03/97 >	10/99				S 2234 Z
dryer filter / filtro essiccatore	Cummins VF390M	390	530	03/97 >	10/99				S 7259 A
power steering / servosterzo	Cummins VF390M	390	530	03/97 >	10/99				S 3081 PO
95XF.530	XE390C (Euro 3)	390	532	09/02 >		S 3010 R		S 7371 A	S 3062 C
with automatic gearbox and hydraulic retarder ZF / con cambio automatico e rallentatore idraulico ZF	XE390C (Euro 3)	390	532	09/02 >					S 2234 Z
DONALDSON assembly flame retardant media / montaggio DONALDSON media filtrante ritardante di fiamma	XE390C (Euro 3)	390	532	09/02 >				S 7A59 A	
power steering / servosterzo	XE390C (Euro 3)	390	532	09/02 >					S 3081 PO
95XF.530	XF390C	390	530	09/99 >	12/02	S 3010 R		S 7371 A	S 3062 C
with automatic gearbox and hydraulic retarder ZF / con cambio automatico e rallentatore idraulico ZF	XF390C	390	530	09/99 >	12/02				S 2234 Z
with manual pump prefilter / con pompa manuale prefiltra	XF390C	390	530	09/99 >	12/02		S 6089 NE		
dryer filter / filtro essiccatore	XF390C	390	530	09/99 >	12/02				S 7259 A
DONALDSON assembly flame retardant media / montaggio DONALDSON media filtrante ritardante di fiamma	XF390C	390	530	09/99 >	12/02			S 7A59 A	
power steering / servosterzo	XF390C	390	530	09/99 >	12/02				S 3081 PO
A Serie									
AZ 1900	DD 575					S 6490 PO	S 8381 NC		
some / alcuni	DD 575			>	12/65	S 6490 PO	S 7111 NC		
some / alcuni	DD 575			01/66 >		S 6490 PO	S 6710 NR		
AZ 1900	DS 575						S 8381 NC		
some / alcuni	DS 575			>	12/65		S 7111 NC		
some / alcuni	DS 575			01/66 >		S 8600 R	S 6710 NR		
CF86									
CF86.290	MX11.210 Euro6	210	286	12/13 >	06/15	S 5240 PE		S 7573 A	S 3139 C
	MX11.210 Euro6	210	286	07/15 >		S 5240 PE		S 7573 A	S 4351 CA
with activated carbons / ai carboni attivi	MX11.210 Euro6	210	286	12/13 >	06/15				S 4347 CA
with activated carbons / ai carboni attivi	MX11.210 Euro6	210	286	07/15 >					S 4351 CA
with filter Urea/Adblue SCR Denoxtronic 2.2 / con filtro Urea/Adblue SCR Denoxtronic 2.2	MX11.210 Euro6	210	286	12/13 >					S 4405 U
dryer filter / filtro essiccatore	MX11.210 Euro6	210	286	12/13 >					S 7F14 A
prefilter Preline / prefiltra Preline	MX11.210 Euro6	210	286	12/13 >			S 4142 NR		
rotor for oil centrifuge / rotore per filtro olio centrifugo	MX11.210 Euro6	210	286	12/13 >		S 5905 PO			
power steering / servosterzo	MX11.210 Euro6	210	286	12/13 >					S 3081 PO
power steering ZF RAS-EC / servosterzo ZF RAS-EC	MX11.210 Euro6	210	286	12/13 >					S 5664 PO
CF86.330	MX11.240 Euro6	240	326	12/13 >	06/15	S 5240 PE		S 7573 A	S 3139 C
	MX11.240 Euro6	240	326	07/15 >		S 5240 PE		S 7573 A	S 4351 CA
with activated carbons / ai carboni attivi	MX11.240 Euro6	240	326	12/13 >	06/15				S 4347 CA
with activated carbons / ai carboni attivi	MX11.240 Euro6	240	326	07/15 >					S 4351 CA
with filter Urea/Adblue SCR Denoxtronic 2.2 / con filtro Urea/Adblue SCR Denoxtronic 2.2	MX11.240 Euro6	240	326	12/13 >					S 4405 U
dryer filter / filtro essiccatore	MX11.240 Euro6	240	326	12/13 >					S 7F14 A
prefilter Preline / prefiltra Preline	MX11.240 Euro6	240	326	12/13 >			S 4142 NR		
rotor for oil centrifuge / rotore per filtro olio centrifugo	MX11.240 Euro6	240	326	12/13 >		S 5905 PO			
power steering / servosterzo	MX11.240 Euro6	240	326	12/13 >					S 3081 PO
power steering ZF RAS-EC / servosterzo ZF RAS-EC	MX11.240 Euro6	240	326	12/13 >					S 5664 PO
CF86.370	MX11.271 Euro6	271	368	12/13 >					S 4351 CA
	MX11.271 Euro6	271	368	12/13 >	06/15	S 5240 PE		S 7573 A	S 3139 C
	MX11.271 Euro6	271	368	07/15 >		S 5240 PE		S 7573 A	
with activated carbons / ai carboni attivi	MX11.271 Euro6	271	368	12/13 >	06/15				S 4347 CA
with activated carbons / ai carboni attivi	MX11.271 Euro6	271	368	07/15 >					S 4351 CA
with filter Urea/Adblue SCR Denoxtronic 2.2 / con filtro Urea/Adblue SCR Denoxtronic 2.2	MX11.271 Euro6	271	368	12/13 >					S 4405 U
dryer filter / filtro essiccatore	MX11.271 Euro6	271	368	12/13 >					S 7F14 A
prefilter Preline / prefiltra Preline	MX11.271 Euro6	271	368	12/13 >			S 4142 NR		
rotor for oil centrifuge / rotore per filtro olio centrifugo	MX11.271 Euro6	271	368	12/13 >		S 5905 PO			
power steering / servosterzo	MX11.271 Euro6	271	368	12/13 >					S 3081 PO

**KW HP****...DAF - trucks/autocarri**

power steering ZF RAS-EC / servosterzo ZF RAS-EC	MX11.271 Euro6	271	368	12/13	>				S 5664 PO	
CF86.400	MX11.291 Euro6	291	396	12/13	>				S 4351 CA	
	MX11.291 Euro6	291	396	12/13	> 06/15	S 5240 PE		S 7573 A	S 3139 C	
	MX11.291 Euro6	291	396	07/15	>	S 5240 PE		S 7573 A		
with activated carbons / ai carboni attivi	MX11.291 Euro6	291	396	12/13	> 06/15				S 4347 CA	
with activated carbons / ai carboni attivi	MX11.291 Euro6	291	396	07/15	>				S 4351 CA	
with filter Urea/Adblue SCR Denoxtronic 2.2 / con filtro Urea/Adblue SCR Denoxtronic 2.2	MX11.291 Euro6	291	396	12/13	>				S 4405 U	
dryer filter / filtro essiccatore	MX11.291 Euro6	291	396	12/13	>				S 7F14 A	
prefilter Preline / prefiltro Preline	MX11.291 Euro6	291	396	12/13	>		S 4142 NR			
rotor for oil centrifuge / rotore per filtro olio centrifugo	MX11.291 Euro6	291	396	12/13	>	S 5905 PO				
power steering / servosterzo	MX11.291 Euro6	291	396	12/13	>				S 3081 PO	
power steering ZF RAS-EC / servosterzo ZF RAS-EC	MX11.291 Euro6	291	396	12/13	>				S 5664 PO	
CF86.410	MX13.303 Euro6	303	412	07/13	>				S 4351 CA	
	MX13.303 Euro6	303	412	07/13	> 06/15	S 5240 PE		S 7573 A	S 3139 C	
	MX13.303 Euro6	303	412	07/15	>	S 5240 PE		S 7573 A		
with activated carbons / ai carboni attivi	MX13.303 Euro6	303	412	07/13	> 06/15				S 4347 CA	
with activated carbons / ai carboni attivi	MX13.303 Euro6	303	412	07/15	>				S 4351 CA	
with filter Urea/Adblue SCR Denoxtronic 2.2 / con filtro Urea/Adblue SCR Denoxtronic 2.2	MX13.303 Euro6	303	412	12/13	>				S 4405 U	
dryer filter / filtro essiccatore	MX13.303 Euro6	303	412	07/13	>				S 7F14 A	
prefilter Preline / prefiltro Preline	MX13.303 Euro6	303	412	12/13	>		S 4142 NR			
rotor for oil centrifuge / rotore per filtro olio centrifugo	MX13.303 Euro6	303	412	07/13	>	S 5905 PO				
power steering / servosterzo	MX13.303 Euro6	303	412	07/13	>				S 3081 PO	
power steering ZF RAS-EC / servosterzo ZF RAS-EC	MX13.303 Euro6	303	412	07/13	>				S 5664 PO	
CF86.440	MX11.320 Euro6	320	435	12/13	>				S 4351 CA	
	MX11.320 Euro6	320	435	12/13	> 06/15	S 5240 PE		S 7573 A	S 3139 C	
	MX11.320 Euro6	320	435	07/15	>	S 5240 PE		S 7573 A		
with activated carbons / ai carboni attivi	MX11.320 Euro6	320	435	12/13	> 06/15				S 4347 CA	
with activated carbons / ai carboni attivi	MX11.320 Euro6	320	435	07/15	>				S 4351 CA	
with filter Urea/Adblue SCR Denoxtronic 2.2 / con filtro Urea/Adblue SCR Denoxtronic 2.2	MX11.320 Euro6	320	435	12/13	>				S 4405 U	
dryer filter / filtro essiccatore	MX11.320 Euro6	320	435	12/13	>				S 7F14 A	
prefilter Preline / prefiltro Preline	MX11.320 Euro6	320	435	12/13	>		S 4142 NR			
rotor for oil centrifuge / rotore per filtro olio centrifugo	MX11.320 Euro6	320	435	12/13	>	S 5905 PO				
power steering / servosterzo	MX11.320 Euro6	320	435	12/13	>				S 3081 PO	
power steering ZF RAS-EC / servosterzo ZF RAS-EC	MX11.320 Euro6	320	435	12/13	>				S 5664 PO	
CF86.460	MX13.340 Euro6	340	462	07/13	>				S 4351 CA	
	MX13.340 Euro6	340	462	07/13	> 06/15	S 5240 PE		S 7573 A	S 3139 C	
	MX13.340 Euro6	340	462	07/15	>	S 5240 PE		S 7573 A		
with activated carbons / ai carboni attivi	MX13.340 Euro6	340	462	07/13	> 06/15				S 4347 CA	
with activated carbons / ai carboni attivi	MX13.340 Euro6	340	462	07/15	>				S 4351 CA	
with filter Urea/Adblue SCR Denoxtronic 2.2 / con filtro Urea/Adblue SCR Denoxtronic 2.2	MX13.340 Euro6	340	462	12/13	>				S 4405 U	
dryer filter / filtro essiccatore	MX13.340 Euro6	340	462	07/13	>				S 7F14 A	
prefilter Preline / prefiltro Preline	MX13.340 Euro6	340	462	12/13	>		S 4142 NR			
rotor for oil centrifuge / rotore per filtro olio centrifugo	MX13.340 Euro6	340	462	07/13	>	S 5905 PO				
power steering / servosterzo	MX13.340 Euro6	340	462	07/13	>				S 3081 PO	
power steering ZF RAS-EC / servosterzo ZF RAS-EC	MX13.340 Euro6	340	462	07/13	>				S 5664 PO	
CF86.510	MX13.375 Euro6	375	510	07/13	>				S 4351 CA	
	MX13.375 Euro6	375	510	07/13	> 06/15	S 5240 PE		S 7573 A	S 3139 C	
	MX13.375 Euro6	375	510	07/15	>	S 5240 PE		S 7573 A		
with activated carbons / ai carboni attivi	MX13.375 Euro6	375	510	07/13	> 06/15				S 4347 CA	
with activated carbons / ai carboni attivi	MX13.375 Euro6	375	510	07/15	>				S 4351 CA	
with filter Urea/Adblue SCR Denoxtronic 2.2 / con filtro Urea/Adblue SCR Denoxtronic 2.2	MX13.375 Euro6	375	510	12/13	>				S 4405 U	
dryer filter / filtro essiccatore	MX13.375 Euro6	375	510	07/13	>				S 7F14 A	
prefilter Preline / prefiltro Preline	MX13.375 Euro6	375	510	12/13	>		S 4142 NR			
rotor for oil centrifuge / rotore per filtro olio centrifugo	MX13.375 Euro6	375	510	07/13	>	S 5905 PO				
power steering / servosterzo	MX13.375 Euro6	375	510	07/13	>				S 3081 PO	
power steering ZF RAS-EC / servosterzo ZF RAS-EC	MX13.375 Euro6	375	510	07/13	>				S 5664 PO	
F 1000 Serie										
F 1000	Cummins 6BT 5.9			12/86	>					S 3081 PO
F 1100 Serie										
F 1100 DD	DD 575	77	105	07/78	> 12/81	S 6490 PO	S 6710 NR			
power steering / servosterzo	DD 575	77	105	07/78	> 12/81					S 8790 PO
power steering / servosterzo	DD 575	77	105	07/78	> 12/81					S 3081 PO
F 1100 DNTD	DNTD 620	116	158	12/86	> 11/89	S 8600 R	S 8110 NR	S 0950 A		
power steering / servosterzo	DNTD 620	116	158	12/86	> 11/89					S 3081 PO
F 1200 Serie										
F 1200 BA										

D



kW HP



...DAF - trucks/autocarri

D



power steering / servosterzo	BA 475			02/72 > 06/74				S 3081 PO
power steering / servosterzo	BA 475			02/72 > 06/74				S 8790 PO
F 1200 DA								
power steering / servosterzo	DA 475			02/72 > 12/73				S 3081 PO
power steering / servosterzo	DA 475			10/72 > 12/73				S 8790 PO
F 1200 DD								
	DD 575			01/69 > 12/81	S 6490 PO			
power steering / servosterzo	DD 575			01/69 > 12/81				S 3081 PO
power steering / servosterzo	DD 575			01/69 > 12/81				S 8790 PO
F 1200 DF								
	DF 615				S 6490 PO	S 6710 NR		
FA 1200 DF								
	DF 615				S 6490 PO	S 6710 NR		
F 1300 Serie								
F 1300 DF								
	DF 615	63	85	07/78 > 10/88	S 6490 PO	S 6710 NR		
F 1300 DNT								
	DNT 620	133	180	12/86 > 02/90	S 8600 R	S 8110 NR	S 0950 A	
power steering / servosterzo	DNT 620	133	180	12/86 > 02/90				S 3081 PO
F 1300 DNTD								
	DNTD 620	116	158	12/86 > 02/89	S 8600 R	S 8110 NR	S 0950 A	
power steering / servosterzo	DNTD 620	116	158	12/86 > 02/89				S 3081 PO
F 1300 DT								
	DT 615	83	113	07/78 > 02/90	S 8600 R	S 8110 NR		
power steering / servosterzo	DT 615	83	113	07/78 > 02/90				S 3081 PO
FA 1300 DF								
	DF 615	63	85	07/78 > 10/88	S 6490 PO	S 6710 NR		
F 1400 Serie								
F 1400 BB								
power steering / servosterzo	BB 475			02/72 > 06/74				S 3081 PO
F 1400 DD								
	DD 575			02/72 > 12/81	S 6490 PO	S 8110 NR		
power steering / servosterzo	DD 575			02/72 > 12/81				S 8790 PO
power steering / servosterzo	DD 575			02/72 > 12/81				S 3081 PO
F 1400 DF								
	DF 615			01/70 > 11/81	S 6490 PO	S 6710 NR		
power steering / servosterzo	DF 615			01/70 > 11/81				S 8790 PO
power steering / servosterzo	DF 615			01/70 > 11/81				S 3081 PO
F 1400 DT								
	DT 615			05/72 > 12/80	S 6490 PO	S 8110 NR		
power steering / servosterzo	DT 615			05/72 > 12/80				S 8790 PO
power steering / servosterzo	DT 615			05/72 > 12/80				S 3081 PO
F 1500 Serie								
F 1500 DF								
	DF 615	85	113	07/78 > 08/91	S 6490 PO	S 6710 NR		
power steering / servosterzo	DF 615	85	113	07/78 > 08/91				S 8790 PO
power steering / servosterzo	DF 615	85	113	07/78 > 08/91				S 3081 PO
F 1500 DT								
	DT 615	85	113	07/78 > 08/91		S 6710 NR		
power steering / servosterzo	DT 615	85	113	07/78 > 08/91				S 8790 PO
power steering / servosterzo	DT 615	85	113	07/78 > 08/91				S 3081 PO
FA 1500 DT								
	DT 615	85	113	07/78 > 08/91		S 6710 NR		
power steering / servosterzo	DT 615	85	113	07/78 > 08/91				S 8790 PO
power steering / servosterzo	DT 615	85	113	07/78 > 08/91				S 3081 PO
F 1600 Serie								
F 1600 BB								
some / alcuni	BB 475			01/70 > 06/74		S 6710 NR		
power steering / servosterzo	BB 475			01/70 > 06/74				S 3081 PO
power steering / servosterzo	BB 475			01/70 > 06/74				S 8790 PO
F 1600 DF								
	DF 615			01/70 > 08/91	S 6490 PO	S 6710 NR		
power steering / servosterzo	DF 615			01/70 > 08/91				S 3081 PO
power steering / servosterzo	DF 615			01/70 > 08/91				S 8790 PO
F 1600 DT								
	DT 615			01/73 > 08/91	S 6490 PO	S 8110 NR		
power steering / servosterzo	DT 615			01/73 > 08/91				S 8790 PO
power steering / servosterzo	DT 615			01/73 > 08/91				S 3081 PO
F 1600 DTD								
	DTD 615			01/71 > 11/80	S 6490 PO	S 8110 NR		
power steering / servosterzo	DTD 615			01/71 > 11/80				S 3081 PO
power steering / servosterzo	DTD 615			01/71 > 11/80				S 8790 PO
FT 1600 DF								
	DF 615			01/70 > 08/91	S 6490 PO	S 6710 NR		
power steering / servosterzo	DF 615			01/70 > 08/91				S 8790 PO
power steering / servosterzo	DF 615			01/70 > 08/91				S 3081 PO
FT 1600 DTD								
	DTD 615			01/71 > 11/80	S 6490 PO	S 8110 NR		
power steering / servosterzo	DTD 615			01/71 > 11/80				S 8790 PO
power steering / servosterzo	DTD 615			01/71 > 11/80				S 3081 PO
F 1700 Serie								
F 1700 DH								
					S 5802 R	S 8110 NR	S 2450 A	
F 1700 DNS								
	DNS 620			01/88 > 02/95	S 8600 R	S 8110 NR	S 2450 A	
dryer filter / filtro essiccatore	DNS 620			01/88 > 02/95				S 7259 A
power steering / servosterzo	DNS 620			01/88 > 02/95				S 3081 PO
F 1700 DNT								
	DNT 620			12/86 > 02/95	S 8600 R	S 8110 NR	S 0950 A	



kW HP



...DAF - trucks/autocarri

dryer filter / filtro essiccatore	DNT 620			12/86 > 02/95				S 7259 A
power steering / servosterzo	DNT 620			12/86 > 02/95				S 3081 PO
F 1700 DNTD	DNTD 620	116 158		12/86 > 02/95	S 8600 R	S 8110 NR	S 0950 A	
dryer filter / filtro essiccatore	DNTD 620	116 158		12/86 > 02/95				S 7259 A
power steering / servosterzo	DNTD 620	116 158		12/86 > 02/95				S 3081 PO
F 1700 DT					S 5802 R	S 8110 NR	S 2450 A	
FA 1700 DNS	DNS 620			01/88 > 02/95	S 8600 R	S 8110 NR	S 2450 A	
power steering / servosterzo	DNS 620			01/88 > 02/95				S 3081 PO
FA 1700 DNT	DNT 620			12/86 > 02/95	S 8600 R	S 8110 NR	S 0950 A	
power steering / servosterzo	DNT 620			12/86 > 02/95				S 3081 PO
FA 1700 DNTD	DNTD 620	116 158		12/86 > 02/95	S 8600 R	S 8110 NR	S 0950 A	
dryer filter / filtro essiccatore	DNTD 620	116 158		12/86 > 02/95				S 7259 A
power steering / servosterzo	DNTD 620	116 158		12/86 > 02/95				S 3081 PO
F 1800 Serie								
F 1800 BB	BB 475			01/70 > 06/74	S 6490 PO	S 6710 NR		
spin-on / avvitabile	BB 475			01/70 > 06/74	S 8600 R	S 6710 NR		
power steering / servosterzo	BB 475			01/70 > 06/74				S 3081 PO
power steering / servosterzo	BB 475			01/70 > 06/74				S 8790 PO
F 1800 DF	DF 615				S 6490 PO	S 6710 NR		
F 1800 DT	DT 615			01/70 > 08/91		S 6710 NR		
spin-on / avvitabile	DT 615			01/70 > 08/91	S 8600 R	S 6710 NR		
power steering / servosterzo	DT 615			01/70 > 08/91				S 3081 PO
power steering / servosterzo	DT 615			01/70 > 08/91				S 8790 PO
F 1900 Serie								
FA 1900 DNS	DNS 620			12/86 > 09/93	S 8600 R	S 8110 NR	S 2450 A	
dryer filter / filtro essiccatore	DNS 620			12/86 > 09/93				S 7259 A
power steering / servosterzo	DNS 620			12/86 > 09/93				S 3081 PO
FA 1900 DNT	DNT 620			12/86 > 09/93	S 8600 R	S 8110 NR	S 0950 A	
dryer filter / filtro essiccatore	DNT 620			12/86 > 09/93				S 7259 A
power steering / servosterzo	DNT 620			12/86 > 09/93				S 3081 PO
F 2000 Serie								
F 2000 DH	DH 825	115 156		01/68 > 12/69		S 8110 NR	S 2650 A	
	DH 825	115 156		01/70 > 12/79		S 8110 NR	S 2650 A	
power steering / servosterzo	DH 825	115 156		01/68 > 12/69				S 8790 PO
power steering / servosterzo	DH 825	115 156		01/70 > 12/79				S 8790 PO
power steering / servosterzo	DH 825	115 156		01/70 > 12/79				S 3081 PO
F 2005 DH	DH 825			10/74 > 01/78		S 8110 NR	S 2650 A	
power steering / servosterzo	DH 825			10/74 > 01/78				S 8790 PO
power steering / servosterzo	DH 825			10/74 > 01/78				S 3081 PO
F 2005 DU	DU 825			01/73 > 11/80		S 8110 NR	S 2650 A	
power steering / servosterzo	DU 825			01/73 > 11/80				S 3081 PO
power steering / servosterzo	DU 825			01/73 > 11/80				S 8790 PO
F 2100 Serie								
F 2100 DH	DH 825			07/78 > 09/86		S 8110 NR	S 2650 A	
spin-on / avvitabile	DH 825			07/78 > 09/86	S 5802 R			
power steering / servosterzo	DH 825			07/78 > 09/86				S 3081 PO
F 2100 DHR	DHR 825			07/78 > 09/86	S 5802 R	S 8110 NR	S 2650 A	
some / alcuni	DHR 825			07/78 > 09/86	S 5802 R	S 8110 NR	S 0450 A	
power steering / servosterzo	DHR 825			07/78 > 09/86				S 3081 PO
F 2100 DHT	DHT 825			11/81 > 08/91	S 5802 R	S 8110 NR	S 2450 A	
some / alcuni	DHT 825			11/81 > 08/91	S 5802 R	S 8110 NR	S 2650 A	
outer / esterno	DHT 825			11/81 > 08/91			S 0450 A	
inner / interno	DHT 825			11/81 > 08/91			S 1450 A	
power steering / servosterzo	DHT 825			11/81 > 08/91				S 3081 PO
F 2100 DHTD	DHTD 825			07/81 > 08/91	S 5802 R	S 8110 NR	S 2450 A	
some / alcuni	DHTD 825			07/81 > 08/91	S 5802 R	S 8110 NR	S 2650 A	
outer / esterno	DHTD 825			07/81 > 08/91			S 0450 A	
inner / interno	DHTD 825			07/81 > 08/91			S 1450 A	
power steering / servosterzo	DHTD 825			07/81 > 08/91				S 3081 PO
F 2103 DH	DH 825			01/82 > 08/91	S 5802 R	S 8110 NR	S 2650 A	
power steering / servosterzo	DH 825			01/82 > 08/91				S 3081 PO
F 2103 DHR	DHR 825			01/82 > 08/91	S 5802 R	S 8110 NR	S 2650 A	
some / alcuni	DHR 825			01/82 > 08/91	S 5802 R	S 8110 NR	S 0450 A	
power steering / servosterzo	DHR 825			01/82 > 08/91				S 3081 PO
F 2105 DF	DF 615			07/78 > 08/91	S 6490 PO	S 8110 NR	S 2450 A	
power steering / servosterzo	DF 615			07/78 > 08/91				S 3081 PO
F 2105 DH	DH 825			07/78 > 08/91	S 5802 R	S 8110 NR	S 2650 A	

D





kW HP



...DAF - trucks/autocarri



power steering / servosterzo	DH 825			07/78 > 08/91				S 3081 PO
F 2105 DHR	DHR 825			07/78 > 08/91	S 5802 R	S 8110 NR	S 0450 A	
power steering / servosterzo	DHR 825			07/78 > 08/91				S 3081 PO
F 2105 DHT	DHT 825			01/87 > 08/91	S 5802 R	S 8110 NR	S 0450 A	
inner / interno	DHT 825			01/87 > 08/91			S 1450 A	
power steering / servosterzo	DHT 825			01/87 > 08/91				S 3081 PO
F 2105 DHTD	DHTD 825			07/81 > 08/91	S 5802 R	S 8110 NR	S 0450 A	
inner / interno	DHTD 825			07/81 > 08/91			S 1450 A	
power steering / servosterzo	DHTD 825			07/81 > 08/91				S 3081 PO
F 2200 Serie								
F 2200 DU	DU 825			01/71 > 11/80	S 5802 R	S 8110 NR	S 2650 A	
power steering / servosterzo	DU 825			01/71 > 11/80				S 8790 PO
power steering / servosterzo	DU 825			01/71 > 11/80				S 3081 PO
F 2205 DH	DH 825			01/73 > 12/79		S 6710 NR		
spin-on / avvvitabile	DH 825			01/73 > 12/79	S 5802 R	S 6710 NR		
power steering / servosterzo	DH 825			01/73 > 12/79				S 8790 PO
power steering / servosterzo	DH 825			01/73 > 12/79				S 3081 PO
F 2205 DU	DU 825			01/71 > 11/80	S 5802 R	S 8110 NR	S 2650 A	
power steering / servosterzo	DU 825			01/71 > 11/80				S 8790 PO
power steering / servosterzo	DU 825			01/71 > 11/80				S 3081 PO
F 2300 Serie								
F 2300 DH	DH 825			07/78 > 12/81		S 8110 NR		
outer / esterno	DH 825			07/78 > 12/81			S 0450 A	
inner / interno	DH 825			07/78 > 12/81			S 1450 A	
power steering / servosterzo	DH 825			07/78 > 12/81				S 3081 PO
F 2300 DHR	DHR 825			07/78 > 12/81	S 5802 R	S 8110 NR	S 0450 A	
inner / interno	DHR 825			07/78 > 12/81			S 1450 A	
power steering / servosterzo	DHR 825			07/78 > 12/81				S 3081 PO
F 2300 DHT	DHT 825			11/81 > 08/91	S 5802 R	S 8110 NR	S 0450 A	
inner / interno	DHT 825			11/81 > 08/91			S 1450 A	
power steering / servosterzo	DHT 825			11/81 > 08/91				S 3081 PO
F 2300 DHU	DHU 825			07/78 > 12/81	S 5802 R	S 8110 NR	S 2650 A	
some / alcuni	DHU 825			07/78 > 12/81	S 5802 R	S 8110 NR	S 0450 A	
outer / esterno	DHU 825			07/78 > 12/81			S 2450 A	
inner / interno	DHU 825			07/78 > 12/81			S 3940 A	
power steering / servosterzo	DHU 825			07/78 > 12/81				S 3081 PO
F 2300 HT	HT 168/HT 825	168	228	01/90 > 08/91	S 5802 R	S 8110 NR	S 0450 A	
some / alcuni	HT 168/HT 825	168	228	01/90 > 08/91	S 8600 R	S 8110 NR	S 0450 A	
inner / interno	HT 168/HT 825	168	228	01/90 > 08/91			S 1450 A	
power steering / servosterzo	HT 168/HT 825	168	228	01/90 > 08/91				S 3081 PO
F 2303 DHU	DHU 825			11/81 > 08/91	S 5802 R	S 8110 NR	S 2650 A	
some / alcuni	DHU 825			11/81 > 08/91	S 5802 R	S 8110 NR	S 0450 A	
outer / esterno	DHU 825			11/81 > 08/91			S 2450 A	
inner / interno	DHU 825			11/81 > 08/91			S 3940 A	
power steering / servosterzo	DHU 825			11/81 > 08/91				S 3081 PO
F 2305 DH	DH 825			07/78 > 12/81		S 8110 NR		
outer / esterno	DH 825			07/78 > 12/81			S 0450 A	
inner / interno	DH 825			07/78 > 12/81			S 1450 A	
power steering / servosterzo	DH 825			07/78 > 12/81				S 3081 PO
F 2305 DHR	DHR 825			07/78 > 08/91	S 5802 R	S 8110 NR	S 0450 A	
power steering / servosterzo	DHR 825			07/78 > 08/91				S 3081 PO
F 2305 DHT	DHT 825			07/78 > 09/86	S 5802 R	S 8110 NR	S 0450 A	
some / alcuni	DHT 825			07/78 > 09/86	S 8600 R	S 8110 NR	S 0450 A	
some / alcuni	DHT 825			07/78 > 09/86			S 2650 A	
inner / interno	DHT 825			07/78 > 09/86			S 1450 A	
power steering / servosterzo	DHT 825			07/78 > 09/86				S 3081 PO
F 2305 DHU	DHU 825			07/78 > 08/91	S 5802 R	S 8110 NR	S 2650 A	
some / alcuni	DHU 825			07/78 > 08/91	S 5802 R	S 8110 NR	S 0450 A	
power steering / servosterzo	DHU 825			07/78 > 08/91				S 3081 PO
FAG 2300 DHTD	DHTD 825	150	204	06/86 > 08/91	S 5802 R	S 8110 NR	S 0450 A	
dryer filter / filtro essiccatore	DHTD 825	150	204	06/86 > 08/91				S 7259 A
inner / interno	DHTD 825	150	204	06/86 > 08/91			S 1450 A	
power steering / servosterzo	DHTD 825	150	204	06/86 > 08/91				S 3081 PO
F 2500 Serie								
F 2500 DHS								
some / alcuni	DHS 825			02/82 > 08/91	S 5802 R	S 8110 NR	S 2650 A	
outer / esterno	DHS 825			02/82 > 08/91			S 0450 A	



KW HP



...DAF - trucks/autocarri

inner / interno	DHS 825	02/82 > 08/91			S 1450 A	
power steering / servosterzo	DHS 825	02/82 > 08/91				S 3081 PO
F 2505 DHS						
some / alcuni	DHS 825	02/82 > 08/91	S 5802 R	S 8110 NR	S 2650 A	
outer / esterno	DHS 825	02/82 > 08/91			S 0450 A	
inner / interno	DHS 825	02/82 > 08/91			S 1450 A	
power steering / servosterzo	DHS 825	02/82 > 08/91				S 3081 PO
F 2525 DHS						
some / alcuni	DHS 825	02/82 > 08/91	S 5802 R	S 8110 NR	S 2650 A	
outer / esterno	DHS 825	02/82 > 08/91			S 0450 A	
inner / interno	DHS 825	02/82 > 08/91			S 1450 A	
power steering / servosterzo	DHS 825	02/82 > 08/91				S 3081 PO
F 2535 DHS						
some / alcuni	DHS 825	02/82 > 08/91	S 5802 R	S 8110 NR	S 2650 A	
outer / esterno	DHS 825	02/82 > 08/91			S 0450 A	
inner / interno	DHS 825	02/82 > 08/91			S 1450 A	
power steering / servosterzo	DHS 825	02/82 > 08/91				S 3081 PO
F 2600 Serie						
F 2600 DK						
	DK 1160	01/70 > 12/76	S 0530 PO	S 6710 NR	S 2650 A	
some / alcuni	DK 1160	01/70 > 12/76	S 0530 PO	S 8110 NR	S 0450 A	
power steering / servosterzo	DK 1160	01/70 > 12/76				S 3081 PO
F 2600 DKA						
	DKA 1160	08/67 > 12/69	S 0530 PO	S 6710 NR	S 2650 A	
some / alcuni	DKA 1160	01/70 > 12/73	S 0530 PO	S 6710 NR	S 2650 A	
some / alcuni	DKA 1160	08/67 > 12/69	S 0530 PO	S 8110 NR	S 2650 A	
power steering / servosterzo	DKA 1160	01/70 > 12/73	S 0530 PO	S 8110 NR	S 0450 A	
power steering / servosterzo	DKA 1160	08/67 > 12/69				S 8790 PO
power steering / servosterzo	DKA 1160	01/70 > 12/73				S 3081 PO
F 2600 DKB						
	DKB 1160	02/72 > 12/73	S 1910 PO	S 8110 NR	S 0550 A	
some / alcuni	DKB 1160	02/72 > 12/73	S 1910 PO	S 8110 NR	S 0450 A	
some / alcuni	DKB 1160	02/72 > 12/73	S 1910 PO	S 8110 NR	S 2650 A	
power steering / servosterzo	DKB 1160	02/72 > 12/73				S 3081 PO
F 2605 DK						
	DK 1160	01/73 > 12/76	S 0530 PO	S 6710 NR	S 2650 A	
some / alcuni	DK 1160	01/73 > 12/76	S 0530 PO	S 8110 NR	S 0450 A	
power steering / servosterzo	DK 1160	01/73 > 12/76				S 3081 PO
F 2605 DKA						
	DKA 1160	08/67 > 12/69	S 0530 PO	S 6710 NR	S 2650 A	
some / alcuni	DKA 1160	01/70 > 12/73	S 0530 PO	S 6710 NR	S 2650 A	
some / alcuni	DKA 1160	08/67 > 12/69	S 0530 PO	S 8110 NR	S 2650 A	
power steering / servosterzo	DKA 1160	01/70 > 12/73	S 0530 PO	S 8110 NR	S 0450 A	
power steering / servosterzo	DKA 1160	08/67 > 12/69				S 8790 PO
power steering / servosterzo	DKA 1160	01/70 > 12/73				S 3081 PO
F 2605 DKB						
	DKB 1160	02/72 > 12/73	S 1910 PO	S 8110 NR	S 0550 A	
some / alcuni	DKB 1160	02/72 > 12/73	S 1910 PO	S 8110 NR	S 0450 A	
some / alcuni	DKB 1160	02/72 > 12/73	S 1910 PO	S 8110 NR	S 2650 A	
power steering / servosterzo	DKB 1160	02/72 > 12/73				S 3081 PO
F 2700 Serie						
F 2700 HS ATi						
	HS 200	01/90 >	S 8600 R	S 8110 NR	S 2450 A	
power steering / servosterzo	HS 200	01/90 >				S 3081 PO
F 2800 Serie						
F 2800 DKA						
	DKA 1160	01/74 > 11/80	S 8600 R	S 8110 NR	S 2450 A	
some / alcuni	DKA 1160	01/74 > 11/80	S 8600 R	S 8110 NR	S 0550 A	
power steering / servosterzo	DKA 1160	01/74 > 11/80				S 3081 PO
F 2800 DKS						
some / alcuni	DKS 1160	01/74 > 09/91	S 8600 R	S 8110 NR	S 0550 A	
outer / esterno	DKS 1160	01/74 > 09/91			S 2450 A	
inner / interno	DKS 1160	01/74 > 09/91			S 3940 A	
power steering / servosterzo	DKS 1160	01/74 > 09/91				S 3081 PO
F 2800 DKSE						
some / alcuni	DKS 1160 E	01/80 > 07/90	S 8600 R	S 8110 NR	S 0550 A	
outer / esterno	DKS 1160 E	01/80 > 07/90	S 8600 R	S 8110 NR	S 2450 A	
inner / interno	DKS 1160 E	01/80 > 07/90			S 3940 A	
power steering / servosterzo	DKS 1160 E	01/80 > 07/90				S 3081 PO
F 2800 DKT						
some / alcuni	DKT 1160	01/74 > 11/80	S 8600 R	S 8110 NR	S 0550 A	
outer / esterno	DKT 1160	01/74 > 11/80			S 2450 A	
inner / interno	DKT 1160	01/74 > 11/80			S 3940 A	
power steering / servosterzo	DKT 1160	01/74 > 11/80				S 3081 PO
F 2800 DKTD						

D





kW HP



...DAF - trucks/autocarri

D



some / alcuni	DKTD 1160		01/74 > 09/91	S 8600 R	S 8110 NR	S 0550 A	
outer / esterno	DKTD 1160		01/74 > 09/91			S 2450 A	
inner / interno	DKTD 1160		01/74 > 09/91			S 3940 A	
power steering / servosterzo	DKTD 1160		01/74 > 09/91				S 3081 PO
F 2800 DKV	DKV 1160		05/83 > 09/91	S 8600 R	S 8110 NR		
outer / esterno	DKV 1160		05/83 > 09/91			S 0450 A	
inner / interno	DKV 1160		05/83 > 09/91			S 1450 A	
power steering / servosterzo	DKV 1160		05/83 > 09/91				S 3081 PO
F 2800 DKXE ATI	DKX-E 1160 ATI		06/85 > 09/91	S 8600 R	S 8110 NR	S 0450 A	
power steering / servosterzo	DKX-E 1160 ATI		06/85 > 09/91				S 3081 PO
F 2803 DKS	DKS 1160		01/74 > 09/91	S 8600 R	S 8110 NR	S 0550 A	
outer / esterno	DKS 1160		01/74 > 09/91			S 2450 A	
inner / interno	DKS 1160		01/74 > 09/91			S 3940 A	
power steering / servosterzo	DKS 1160		01/74 > 09/91				S 3081 PO
F 2803 DKTD	DKTD 1160		01/74 > 09/91	S 8600 R	S 8110 NR	S 0550 A	
outer / esterno	DKTD 1160		01/74 > 09/91			S 2450 A	
inner / interno	DKTD 1160		01/74 > 09/91			S 3940 A	
power steering / servosterzo	DKTD 1160		01/74 > 09/91				S 3081 PO
F 2805 DKA	DKA 1160		01/74 > 11/80	S 8600 R	S 8110 NR	S 2450 A	
some / alcuni	DKA 1160		01/74 > 11/80	S 8600 R	S 8110 NR	S 0550 A	
power steering / servosterzo	DKA 1160		01/74 > 11/80				S 3081 PO
F 2805 DKS	DKS 1160		01/74 > 09/91	S 8600 R	S 8110 NR	S 0550 A	
outer / esterno	DKS 1160		01/74 > 09/91			S 2450 A	
inner / interno	DKS 1160		01/74 > 09/91			S 3940 A	
power steering / servosterzo	DKS 1160		01/74 > 09/91				S 3081 PO
F 2805 DKT	DKT 1160		01/74 > 11/80	S 8600 R	S 8110 NR	S 0550 A	
outer / esterno	DKT 1160		01/74 > 11/80			S 2450 A	
inner / interno	DKT 1160		01/74 > 11/80			S 3940 A	
power steering / servosterzo	DKT 1160		01/74 > 11/80				S 3081 PO
F 2805 DKTD	DKTD 1160		01/74 > 09/91	S 8600 R	S 8110 NR	S 0550 A	
outer / esterno	DKTD 1160		01/74 > 09/91			S 2450 A	
inner / interno	DKTD 1160		01/74 > 09/91			S 3940 A	
power steering / servosterzo	DKTD 1160		01/74 > 09/91				S 3081 PO
F 2815 DKS	DKS 1160		01/74 > 12/81	S 8600 R	S 8110 NR	S 0550 A	
outer / esterno	DKS 1160		01/74 > 12/81			S 2450 A	
inner / interno	DKS 1160		01/74 > 12/81			S 3940 A	
power steering / servosterzo	DKS 1160		01/74 > 12/81				S 3081 PO
F 2900 Serie							
F 2900 KV ATI	KV 212		01/90 > 10/93	S 3275 R	S 8110 NR	S 8570 A	
power steering / servosterzo	KV 212		01/90 > 10/93				S 3081 PO
F 3000 Serie							
F 3000	DKX (330 CV)			S 8600 R	S 8110 NR	S 0550 A	
outer / esterno	DKX (330 CV)					S 2450 A	
inner / interno	DKX (330 CV)					S 3940 A	
F 3200 Serie							
F 3200 KS ATI	KS 238	238 324	01/90 > 10/93	S 3275 R	S 8110 NR	S 8570 A	
dryer filter / filtro essiccatore	KS 238	238 324	01/90 > 10/93				S 7259 A
power steering / servosterzo	KS 238	238 324	01/90 > 10/93				S 3081 PO
F 3300 Serie							
F 3300 DKV	DKV 1160		05/83 > 09/91	S 8600 R	S 8110 NR	S 2450 A	
power steering / servosterzo	DKV 1160		05/83 > 09/91				S 3081 PO
F 3300 DKX	DKX 1160		06/81 > 09/91	S 8600 R	S 8110 NR	S 2450 A	
power steering / servosterzo	DKX 1160		06/81 > 09/91				S 3081 PO
F 3300 DKX ATI	DKX 1160 ATI		06/85 > 09/91	S 8600 R	S 8110 NR	S 2450 A	
power steering / servosterzo	DKX 1160 ATI		06/85 > 09/91				S 3081 PO
F 3305 DKX	DKX 1160		06/81 > 09/91	S 8600 R	S 8110 NR	S 2450 A	
power steering / servosterzo	DKX 1160		06/81 > 09/91				S 3081 PO
F 3325 DKX	DKX 1160		06/81 > 09/91	S 8600 R	S 8110 NR	S 2450 A	
power steering / servosterzo	DKX 1160		06/81 > 09/91				S 3081 PO
F 3325 DKX ATI	DKX 1160 ATI		06/85 > 09/91	S 8600 R	S 8110 NR	S 2450 A	

**kW HP**

...DAF - trucks/autocarri

power steering / servosterzo	DKX 1160 ATI			06/85 > 09/91				S 3081 PO
F 3600 Serie								
F 3600 DKZ ATI	DKZ 1160 ATI			06/85 > 09/91	S 8600 R	S 8110 NR	S 2450 A	
power steering / servosterzo	DKZ 1160 ATI			06/85 > 09/91				S 3081 PO
F 500 Serie								
F 500 DE	DE385	58	79	12/77 > 12/79		S 7111 NC		
F 600 Serie								
F 600								
power steering / servosterzo	Cummins 6B 5.9			12/86 >				S 3081 PO
F 700 Serie								
FA 700 DE	DE385	58	79	12/75 > 12/79		S 7111 NC		
F 800 Serie								
FA 800 CN								
power steering / servosterzo	Cummins 6BT 5.9			12/86 > 08/91				S 3081 PO
F 900 Serie								
FA 900	DD 575	77	105		S 6490 PO			
FA 900 DD	DD 575	77	105	01/75 > 12/81	S 6490 PO	S 6710 NR		
power steering / servosterzo	DD 575	77	105	01/75 > 12/81				S 3081 PO
power steering / servosterzo	DD 575	77	105	01/75 > 12/81				S 8790 PO
FA 900 DE	DE385	58	79	01/75 > 12/81	S 6490 PO	S 7111 NC		
FA 900 DF	DF 615	85	116	11/81 > 11/88	S 6490 PO	S 6710 NR		
power steering / servosterzo	DF 615	85	116	11/81 > 11/88				S 3081 PO
FA 900 DT	DT 615	111	151	11/81 > 11/88	S 6490 PO	S 6710 NR		
power steering / servosterzo	DT 615	111	151	11/81 > 11/88				S 3081 PO
LF Euro6 Serie								
LF 150	PX5 Euro6	112	152	09/16 >	S 0620 R			S 3460 C
with filter Urea/Adblue / con filtro Urea/Adblue	PX5 Euro6	112	152	09/16 >				S 4405 U
dryer filter / filtro essiccatore	PX5 Euro6	112	152	09/16 >				S 7393 A
power steering / servosterzo	PX5 Euro6	112	152	09/16 >				S 3081 PO
LF 180	PX5 Euro6	135	184	09/16 >	S 0620 R			S 3460 C
with filter Urea/Adblue / con filtro Urea/Adblue	PX5 Euro6	135	184	09/16 >				S 4405 U
dryer filter / filtro essiccatore	PX5 Euro6	135	184	09/16 >				S 7393 A
power steering / servosterzo	PX5 Euro6	135	184	09/16 >				S 3081 PO
LF 210	PX5 Euro6	157	213	09/16 >	S 0620 R			S 3460 C
with filter Urea/Adblue / con filtro Urea/Adblue	PX5 Euro6	157	213	09/16 >				S 4405 U
dryer filter / filtro essiccatore	PX5 Euro6	157	213	09/16 >				S 7393 A
power steering / servosterzo	PX5 Euro6	157	213	09/16 >				S 3081 PO
LF 220	PX7 Euro6	162	220	09/16 >	S 0620 R			S 3460 C
with filter Urea/Adblue / con filtro Urea/Adblue	PX7 Euro6	162	220	09/16 >				S 4405 U
dryer filter / filtro essiccatore	PX7 Euro6	162	220	09/16 >				S 7393 A
power steering / servosterzo	PX7 Euro6	162	220	09/16 >				S 3081 PO
LF 230	PX7 Euro6	172	234	09/16 >	S 0620 R			S 3460 C
with filter Urea/Adblue / con filtro Urea/Adblue	PX7 Euro6	172	234	09/16 >				S 4405 U
dryer filter / filtro essiccatore	PX7 Euro6	172	234	09/16 >				S 7393 A
power steering / servosterzo	PX7 Euro6	172	234	09/16 >				S 3081 PO
LF 250	PX7 Euro6	187	254	09/16 >	S 0620 R			S 3460 C
with filter Urea/Adblue / con filtro Urea/Adblue	PX7 Euro6	187	254	09/16 >				S 4405 U
dryer filter / filtro essiccatore	PX7 Euro6	187	254	09/16 >				S 7393 A
power steering / servosterzo	PX7 Euro6	187	254	09/16 >				S 3081 PO
LF 260	PX7 Euro6	194	264	09/16 >	S 0620 R			S 3460 C
with filter Urea/Adblue / con filtro Urea/Adblue	PX7 Euro6	194	264	09/16 >				S 4405 U
dryer filter / filtro essiccatore	PX7 Euro6	194	264	09/16 >				S 7393 A
power steering / servosterzo	PX7 Euro6	194	264	09/16 >				S 3081 PO
LF 280	PX7 Euro6	209	284	09/16 >	S 0620 R			S 3460 C
with filter Urea/Adblue / con filtro Urea/Adblue	PX7 Euro6	209	284	09/16 >				S 4405 U
dryer filter / filtro essiccatore	PX7 Euro6	209	284	09/16 >				S 7393 A
power steering / servosterzo	PX7 Euro6	209	284	09/16 >				S 3081 PO
LF 290	PX7 Euro6	217	295	09/16 >	S 0620 R			S 3460 C
with filter Urea/Adblue / con filtro Urea/Adblue	PX7 Euro6	217	295	09/16 >				S 4405 U
dryer filter / filtro essiccatore	PX7 Euro6	217	295	09/16 >				S 7393 A
power steering / servosterzo	PX7 Euro6	217	295	09/16 >				S 3081 PO
LF 320	PX7 Euro6	239	325	09/16 >	S 0620 R			S 3460 C
with filter Urea/Adblue / con filtro Urea/Adblue	PX7 Euro6	239	325	09/16 >				S 4405 U
dryer filter / filtro essiccatore	PX7 Euro6	239	325	09/16 >				S 7393 A
power steering / servosterzo	PX7 Euro6	239	325	09/16 >				S 3081 PO
LF45 Serie								
45LF.140	Paccar BE99C	99	135	01/01 > 07/10	S 0620 R	S 2220 NR	S 7F15 A	S 3217 C



**KW HP****...DAF - trucks/autocarri****D**

dryer filter / filtro essiccatore	Paccar BE99C	99	135	08/10	>	S 0620 R	S 2220 NR	S 7F15 A	S 7393 A
power steering / servosterzo	Paccar BE99C	99	135	01/01	>				S 3081 PO
45LF.150	Paccar BE110C	110	150	01/01	> 07/10	S 0620 R	S 2220 NR	S 7F15 A	S 3217 C
dryer filter / filtro essiccatore	Paccar BE110C	110	150	08/10	>	S 0620 R	S 2220 NR	S 7F15 A	
power steering / servosterzo	Paccar BE110C	110	150	01/01	>				S 7393 A
45LF.170	Paccar BE123C	123	167	01/01	> 07/10	S 0620 R	S 2220 NR	S 7F15 A	S 3217 C
dryer filter / filtro essiccatore	Paccar BE123C	123	167	08/10	>	S 0620 R	S 2220 NR	S 7F15 A	
power steering / servosterzo	Paccar BE123C	123	167	01/01	>				S 7393 A
45LF.180	Paccar CE136C	136	185	01/01	> 07/10	S 0620 R	S 2220 NR	S 7F15 A	S 3217 C
dryer filter / filtro essiccatore	Paccar CE136C	136	185	08/10	>	S 0620 R	S 2220 NR	S 7F15 A	
power steering / servosterzo	Paccar CE136C	136	185	01/01	>				S 7393 A
45LF.190	Paccar CE136C	136	185	01/01	> 07/10	S 0620 R	S 2220 NR	S 7F15 A	S 3217 C
dryer filter / filtro essiccatore	Paccar CE136C	136	185	08/10	>	S 0620 R	S 2220 NR	S 7F15 A	
power steering / servosterzo	Paccar CE136C	136	185	01/01	>				S 7393 A
45LF.220	Paccar CE162C	162	220	01/01	> 07/10	S 0620 R	S 2220 NR		S 3217 C
dryer filter / filtro essiccatore	Paccar CE162C	162	220	08/10	>	S 0620 R	S 2220 NR		
power steering / servosterzo	Paccar CE162C	162	220	01/01	>				S 7393 A
LF45.140	Paccar FR103 E4/E5/EEV	103	140	05/06	> 12/09	S 0620 R	S 2220 NR	S 7650 A	S 3217 C
with filter SCR-System / con filtro SCR-System	Paccar FR103 E4/E5/EEV	103	140	01/10	> 07/10	S 0620 R		S 7650 A	S 3217 C
with filter Urea/Adblue / con filtro Urea/Adblue	Paccar FR103 E4/E5/EEV	103	140	08/10	>	S 0620 R		S 7650 A	
dryer filter / filtro essiccatore	Paccar FR103 E4/E5/EEV	103	140	05/06	>				S 7A86 A
prefilter / prefiltrato	Paccar FR103 E4/E5/EEV	103	140	05/06	> 12/09		S 4089 NR		S 4403 U
power steering / servosterzo	Paccar FR103 E4/E5/EEV	103	140	05/06	>				S 7393 A
LF45.160	Paccar FR118 E4/E5/EEV	118	160	05/06	> 12/09	S 0620 R	S 2220 NR	S 7650 A	S 3217 C
with filter SCR-System / con filtro SCR-System	Paccar FR118 E4/E5/EEV	118	160	01/10	> 07/10	S 0620 R		S 7650 A	S 3217 C
with filter Urea/Adblue / con filtro Urea/Adblue	Paccar FR118 E4/E5/EEV	118	160	08/10	>	S 0620 R		S 7650 A	
dryer filter / filtro essiccatore	Paccar FR118 E4/E5/EEV	118	160	05/06	>				S 7A86 A
prefilter / prefiltrato	Paccar FR118 E4/E5/EEV	118	160	05/06	>				S 4403 U
power steering / servosterzo	Paccar FR118 E4/E5/EEV	118	160	05/06	> 12/09		S 4089 NR		S 7393 A
LF45.180	Paccar FR136 E4/E5/EEV	136	185	05/06	> 12/09	S 0620 R	S 2220 NR	S 7650 A	S 3217 C
with filter SCR-System / con filtro SCR-System	Paccar FR136 E4/E5/EEV	136	185	01/10	> 07/10	S 0620 R		S 7650 A	S 3217 C
with filter Urea/Adblue / con filtro Urea/Adblue	Paccar FR136 E4/E5/EEV	136	185	08/10	>	S 0620 R		S 7650 A	
dryer filter / filtro essiccatore	Paccar FR136 E4/E5/EEV	136	185	05/06	>				S 7A86 A
prefilter / prefiltrato	Paccar FR136 E4/E5/EEV	136	185	05/06	> 12/09		S 4089 NR		S 4403 U
power steering / servosterzo	Paccar FR136 E4/E5/EEV	136	185	05/06	>				S 7393 A
LF45.210	Paccar FR152 E5/EEV	152	207	06/09	> 12/09	S 0620 R	S 2220 NR	S 7650 A	S 3217 C
with filter SCR-System / con filtro SCR-System	Paccar FR152 E5/EEV	152	207	01/10	> 07/10	S 0620 R		S 7650 A	S 3217 C
with filter Urea/Adblue / con filtro Urea/Adblue	Paccar FR152 E5/EEV	152	207	08/10	>	S 0620 R		S 7650 A	
dryer filter / filtro essiccatore	Paccar FR152 E5/EEV	152	207	06/09	>				S 7A86 A
prefilter / prefiltrato	Paccar FR152 E5/EEV	152	207	06/09	>				S 4403 U
power steering / servosterzo	Paccar FR152 E5/EEV	152	207	06/09	> 12/09		S 4089 NR		S 7393 A
LF45.220	Paccar GR165 E4/E5	165	224	05/06	> 12/09	S 0620 R	S 2220 NR	S 7650 A	S 3217 C
with filter SCR-System / con filtro SCR-System	Paccar GR165 E4/E5	165	224	01/10	> 07/10	S 0620 R		S 7650 A	S 3217 C
with filter Urea/Adblue / con filtro Urea/Adblue	Paccar GR165 E4/E5	165	224	08/10	>	S 0620 R		S 7650 A	
dryer filter / filtro essiccatore	Paccar GR165 E4/E5	165	224	05/06	>				S 7A86 A
prefilter / prefiltrato	Paccar GR165 E4/E5	165	224	05/06	> 12/09		S 4089 NR		S 4403 U
power steering / servosterzo	Paccar GR165 E4/E5	165	224	05/06	>				S 7393 A
LF45.250	Paccar GR184 E4/E5	184	250	05/06	> 12/09	S 0620 R	S 2220 NR	S 7650 A	
with filter SCR-System / con filtro SCR-System	Paccar GR184 E4/E5	184	250	01/10	> 07/10	S 0620 R		S 7650 A	S 3217 C
	Paccar GR184 E4/E5	184	250	08/10	>	S 0620 R		S 7650 A	
	Paccar GR184 E4/E5	184	250	05/06	>				S 7A86 A

**KW HP**

...DAF - trucks/autocarri

with filter Urea/Adblue / con filtro Urea/Adblue	Paccar GR184 E4/E5	184	250	05/06	>				S 4403 U
dryer filter / filtro essiccatore	Paccar GR184 E4/E5	184	250	05/06	>				S 7393 A
prefilter / prefiltrato	Paccar GR184 E4/E5	184	250	05/06	>	12/09		S 4089 NR	
power steering / servosterzo	Paccar GR184 E4/E5	184	250	05/06	>				S 3081 PO
LF45.300	Paccar GR225 E5/EEV	225	300	06/09	>	12/09	S 0620 R	S 2220 NR	S 7650 A
	Paccar GR225 E5/EEV	225	300	01/10	>	07/10	S 0620 R		S 7650 A
	Paccar GR225 E5/EEV	225	300	08/10	>		S 0620 R		S 7650 A
with filter SCR-System / con filtro SCR-System	Paccar GR225 E5/EEV	225	300	06/09	>				S 7A86 A
with filter Urea/Adblue / con filtro Urea/Adblue	Paccar GR225 E5/EEV	225	300	06/09	>				S 4403 U
dryer filter / filtro essiccatore	Paccar GR225 E5/EEV	225	300	06/09	>				S 7393 A
prefilter / prefiltrato	Paccar GR225 E5/EEV	225	300	06/09	>	12/09		S 4089 NR	
power steering / servosterzo	Paccar GR225 E5/EEV	225	300	06/09	>				S 3081 PO
LF55 Serie									
55LF.170	Paccar BE123C	123	167	02/01	>	07/10	S 0620 R	S 2220 NR	S 7F15 A
	Paccar BE123C	123	167	08/10	>		S 0620 R	S 2220 NR	S 7F15 A
dryer filter / filtro essiccatore	Paccar BE123C	123	167	02/01	>				S 7393 A
power steering / servosterzo	Paccar BE123C	123	167	02/01	>				S 3081 PO
55LF.180	Paccar CE136C	136	185	02/01	>	07/10	S 0620 R	S 2220 NR	
	Paccar CE136C	136	185	08/10	>		S 0620 R	S 2220 NR	
dryer filter / filtro essiccatore	Paccar CE136C	136	185	02/01	>				S 7393 A
power steering / servosterzo	Paccar CE136C	136	185	02/01	>				S 3081 PO
55LF.190	Paccar CE136C	136	185	02/01	>	07/10	S 0620 R	S 2220 NR	
	Paccar CE136C	136	185	08/10	>		S 0620 R	S 2220 NR	
dryer filter / filtro essiccatore	Paccar CE136C	136	185	02/01	>				S 7393 A
power steering / servosterzo	Paccar CE136C	136	185	02/01	>				S 3081 PO
55LF.220	Paccar CE162C	162	220	02/01	>	07/10	S 0620 R	S 2220 NR	
	Paccar CE162C	162	220	08/10	>		S 0620 R	S 2220 NR	
dryer filter / filtro essiccatore	Paccar CE162C	162	220	02/01	>				S 7393 A
power steering / servosterzo	Paccar CE162C	162	220	02/01	>				S 3081 PO
55LF.250	Paccar CE184C	184	250	02/01	>	07/10	S 0620 R	S 2220 NR	
	Paccar CE184C	184	250	08/10	>		S 0620 R	S 2220 NR	
dryer filter / filtro essiccatore	Paccar CE184C	184	250	02/01	>				S 7393 A
power steering / servosterzo	Paccar CE184C	184	250	02/01	>				S 3081 PO
LF55.160	Paccar FR118 E4	118	160	05/06	>	12/09	S 0620 R	S 2220 NR	S 7650 A
	Paccar FR118 E4	118	160	01/10	>	07/10	S 0620 R		S 7650 A
	Paccar FR118 E4	118	160	08/10	>		S 0620 R		S 7650 A
with filter SCR-System / con filtro SCR-System	Paccar FR118 E4	118	160	05/06	>				S 7A86 A
with filter Urea/Adblue / con filtro Urea/Adblue	Paccar FR118 E4	118	160	05/06	>				S 4403 U
dryer filter / filtro essiccatore	Paccar FR118 E4	118	160	05/06	>				S 7393 A
prefilter / prefiltrato	Paccar FR118 E4	118	160	05/06	>	12/09		S 4089 NR	
power steering / servosterzo	Paccar FR118 E4	118	160	05/06	>				S 3081 PO
LF55.180	Paccar FR136 E4/E5/EEV	136	185	05/06	>	12/09	S 0620 R	S 2220 NR	S 7650 A
	Paccar FR136 E4/E5/EEV	136	185	01/10	>	07/10	S 0620 R		S 7650 A
	Paccar FR136 E4/E5/EEV	136	185	08/10	>		S 0620 R		S 7650 A
with filter SCR-System / con filtro SCR-System	Paccar FR136 E4/E5/EEV	136	185	05/06	>				S 7A86 A
with filter Urea/Adblue / con filtro Urea/Adblue	Paccar FR136 E4/E5/EEV	136	185	05/06	>				S 4403 U
dryer filter / filtro essiccatore	Paccar FR136 E4/E5/EEV	136	185	05/06	>				S 7393 A
prefilter / prefiltrato	Paccar FR136 E4/E5/EEV	136	185	05/06	>	12/09		S 4089 NR	
power steering / servosterzo	Paccar FR136 E4/E5/EEV	136	185	05/06	>				S 3081 PO
LF55.210	Paccar FR152 E4/E5/EEV	152	207	06/09	>	12/09	S 0620 R	S 2220 NR	S 7650 A
	Paccar FR152 E4/E5/EEV	152	207	01/10	>	07/10	S 0620 R		S 7650 A
	Paccar FR152 E4/E5/EEV	152	207	08/10	>		S 0620 R		S 7650 A
with filter SCR-System / con filtro SCR-System	Paccar FR152 E4/E5/EEV	152	207	06/09	>				S 7A86 A
with filter Urea/Adblue / con filtro Urea/Adblue	Paccar FR152 E4/E5/EEV	152	207	06/09	>				S 4403 U
dryer filter / filtro essiccatore	Paccar FR152 E4/E5/EEV	152	207	06/09	>				S 7393 A
prefilter / prefiltrato	Paccar FR152 E4/E5/EEV	152	207	06/09	>	12/09		S 4089 NR	
power steering / servosterzo	Paccar FR152 E4/E5/EEV	152	207	06/09	>				S 3081 PO
LF55.220	Paccar GR165 E4/E5	165	224	05/06	>	12/09	S 0620 R	S 2220 NR	S 7650 A
	Paccar GR165 E4/E5	165	224	01/10	>	07/10	S 0620 R		S 7650 A
with filter SCR-System / con filtro SCR-System	Paccar GR165 E4/E5	165	224	05/06	>				S 7A86 A
with filter Urea/Adblue / con filtro Urea/Adblue	Paccar GR165 E4/E5	165	224	05/06	>				S 4403 U
dryer filter / filtro essiccatore	Paccar GR165 E4/E5	165	224	05/06	>				S 7393 A
prefilter / prefiltrato	Paccar GR165 E4/E5	165	224	05/06	>	12/09		S 4089 NR	
power steering / servosterzo	Paccar GR165 E4/E5	165	224	05/06	>				S 3081 PO
LF55.250	Paccar GR184 E4/E5	184	250	05/06	>	12/09	S 0620 R	S 2220 NR	S 7650 A
	Paccar GR184 E4/E5	184	250	01/10	>	07/10	S 0620 R		S 7650 A
	Paccar GR184 E4/E5	184	250	08/10	>		S 0620 R		S 7650 A

D



...DAF - trucks/autocarri

D

with filter SCR-System / con filtro SCR-System	Paccar GR184 E4/E5	184	250	05/06 >				S 7A86 A
with filter Urea/Adblue / con filtro Urea/Adblue	Paccar GR184 E4/E5	184	250	05/06 >				S 4403 U
dryer filter / filtro essiccatore	Paccar GR184 E4/E5	184	250	05/06 >				S 7393 A
prefilter / prefiltrato	Paccar GR184 E4/E5	184	250	05/06 > 12/09		S 4089 NR		
power steering / servosterzo	Paccar GR184 E4/E5	184	250	05/06 >				S 3081 PO
LF55.290	Paccar GR210 E4/E5	210	286	05/06 > 12/09	S 0620 R	S 2220 NR	S 7650 A	S 3217 C
	Paccar GR210 E4/E5	210	286	01/10 > 07/10	S 0620 R		S 7650 A	S 3217 C
	Paccar GR210 E4/E5	210	286	08/10 >	S 0620 R		S 7650 A	
with filter SCR-System / con filtro SCR-System	Paccar GR210 E4/E5	210	286	05/06 >				S 7A86 A
with filter Urea/Adblue / con filtro Urea/Adblue	Paccar GR210 E4/E5	210	286	05/06 >				S 4403 U
dryer filter / filtro essiccatore	Paccar GR210 E4/E5	210	286	05/06 >				S 7393 A
prefilter / prefiltrato	Paccar GR210 E4/E5	210	286	05/06 > 12/09		S 4089 NR		
power steering / servosterzo	Paccar GR210 E4/E5	210	286	05/06 >				S 3081 PO
LF55.300	Paccar GR220 E5/EEV	220	300	06/09 > 12/09	S 0620 R	S 2220 NR	S 7650 A	S 3217 C
	Paccar GR220 E5/EEV	220	300	01/10 > 07/10	S 0620 R		S 7650 A	S 3217 C
	Paccar GR220 E5/EEV	220	300	08/10 >	S 0620 R		S 7650 A	
with filter SCR-System / con filtro SCR-System	Paccar GR220 E5/EEV	220	300	06/09 >				S 7A86 A
with filter Urea/Adblue / con filtro Urea/Adblue	Paccar GR220 E5/EEV	220	300	06/09 >				S 4403 U
dryer filter / filtro essiccatore	Paccar GR220 E5/EEV	220	300	06/09 >				S 7393 A
prefilter / prefiltrato	Paccar GR220 E5/EEV	220	300	06/09 > 12/09		S 4089 NR		
power steering / servosterzo	Paccar GR220 E5/EEV	220	300	06/09 >				S 3081 PO
N 2800 Serie								
N 2826 DKA								
some / alcuni	DKA 1160			10/80 > 09/91	S 8600 R	S 8110 NR	S 0550 A	
outer / esterno	DKA 1160			10/80 > 09/91			S 2450 A	
inner / interno	DKA 1160			10/80 > 09/91			S 3940 A	
power steering / servosterzo	DKA 1160			10/80 > 09/91				S 3081 PO
N 2826 DKS								
some / alcuni	DKS 1160	228	310	01/81 > 09/91	S 8600 R	S 8110 NR	S 0550 A	
outer / esterno	DKS 1160	228	310	01/81 > 09/91			S 2450 A	
inner / interno	DKS 1160	228	310	01/81 > 09/91			S 3940 A	
power steering / servosterzo	DKS 1160	228	310	01/81 > 09/91				S 3081 PO
N 2826 DKTD								
some / alcuni	DKTD 1160			01/82 > 09/91	S 8600 R	S 8110 NR	S 0550 A	
outer / esterno	DKTD 1160			01/82 > 09/91			S 2450 A	
inner / interno	DKTD 1160			01/82 > 09/91			S 3940 A	
power steering / servosterzo	DKTD 1160			01/82 > 09/91				S 3081 PO
XF105								
XF105.410								
	MX300S	300	408	10/05 > 06/11	S 5081 PE	S 6024 NE	S 7B45 A	S 3062 C
	MX300S	300	408	07/11 >	S 5081 PE	S 6024 NE		S 3062 C
with filter SCR-System / con filtro SCR-System	MX300S	300	408	10/05 >				S 7A86 A
with filter Urea/Adblue / con filtro Urea/Adblue	MX300S	300	408	10/05 >				S 4403 U
dryer filter / filtro essiccatore	MX300S	300	408	10/05 >				S 7393 A
power steering / servosterzo	MX300S	300	408	10/05 >				S 3081 PO
XF105.460								
	MX340S	340	462	10/05 > 06/11	S 5081 PE	S 6024 NE	S 7B45 A	S 3062 C
	MX340S	340	462	07/11 >	S 5081 PE	S 6024 NE		S 3062 C
with filter SCR-System / con filtro SCR-System	MX340S	340	462	10/05 >				S 7A86 A
with filter Urea/Adblue / con filtro Urea/Adblue	MX340S	340	462	10/05 >				S 4403 U
dryer filter / filtro essiccatore	MX340S	340	462	10/05 >				S 7393 A
power steering / servosterzo	MX340S	340	462	10/05 >				S 3081 PO
XF105.510								
	MX375S	375	510	10/05 > 06/11	S 5081 PE	S 6024 NE	S 7B45 A	S 3062 C
	MX375S	375	510	07/11 >	S 5081 PE	S 6024 NE		S 3062 C
with filter SCR-System / con filtro SCR-System	MX375S	375	510	10/05 >				S 7A86 A
with filter Urea/Adblue / con filtro Urea/Adblue	MX375S	375	510	10/05 >				S 4403 U
dryer filter / filtro essiccatore	MX375S	375	510	10/05 >				S 7393 A
power steering / servosterzo	MX375S	375	510	10/05 >				S 3081 PO
XF105.560								
	MX410S	410	560	04/06 > 06/11	S 5081 PE	S 6024 NE	S 7B45 A	S 3062 C
	MX410S	410	560	07/11 >	S 5081 PE	S 6024 NE		S 3062 C
with filter SCR-System / con filtro SCR-System	MX410S	410	560	04/06 >				S 7A86 A
with filter Urea/Adblue / con filtro Urea/Adblue	MX410S	410	560	04/06 >				S 4403 U
dryer filter / filtro essiccatore	MX410S	410	560	04/06 >				S 7393 A
power steering / servosterzo	MX410S	410	560	04/06 >				S 3081 PO
XF106								
XF106.400								
	MX11.291 Euro6	291	400	09/13 > 06/15	S 5240 PE			S 3062 C
	MX11.291 Euro6	291	400	07/15 >	S 5240 PE			S 4352 CA
with filter Urea/Adblue SCR Denoxtronic 2.2 / con filtro Urea/Adblue SCR Denoxtronic 2.2	MX11.291 Euro6	291	400	09/13 >				S 4405 U
dryer filter / filtro essiccatore	MX11.291 Euro6	291	400	09/13 >				S 7F14 A

**KW HP****...DAF - trucks/autocarri**

prefilter Preline / prefiltra Preline	MX11.291 Euro6	291	400	09/13 >		S 4142 NR		
rotor for oil centrifuge / rotore per filtro olio centrifugo	MX11.291 Euro6	291	400	09/13 >	S 5905 PO			
power steering / servosterzo	MX11.291 Euro6	291	400	09/13 >				S 3081 PO
power steering ZF RAS-EC / servosterzo ZF RAS-EC	MX11.291 Euro6	291	400	09/13 >				S 5664 PO
XF106.410	MX13.303 Euro6	303	412	09/13 > 06/15	S 5240 PE			S 3062 C
	MX13.303 Euro6	303	412	07/15 >	S 5240 PE			S 4352 CA
with filter Urea/Adblue SCR Denoxtronic 2.2 / con filtro Urea/Adblue SCR Denoxtronic 2.2	MX13.303 Euro6	303	412	09/13 >				S 4405 U
dryer filter / filtro essiccatore	MX13.303 Euro6	303	412	09/13 >				S 7F14 A
prefilter Preline / prefiltra Preline	MX13.303 Euro6	303	412	09/13 >		S 4142 NR		
rotor for oil centrifuge / rotore per filtro olio centrifugo	MX13.303 Euro6	303	412	09/13 >	S 5905 PO			
power steering / servosterzo	MX13.303 Euro6	303	412	09/13 >				S 3081 PO
power steering ZF RAS-EC / servosterzo ZF RAS-EC	MX13.303 Euro6	303	412	09/13 >				S 5664 PO
XF106.440	MX11.320 Euro6	320	440	09/13 > 06/15	S 5240 PE			S 3062 C
	MX11.320 Euro6	320	440	07/15 >	S 5240 PE			S 4352 CA
with filter Urea/Adblue SCR Denoxtronic 2.2 / con filtro Urea/Adblue SCR Denoxtronic 2.2	MX11.320 Euro6	320	440	09/13 >				S 4405 U
dryer filter / filtro essiccatore	MX11.320 Euro6	320	440	09/13 >				S 7F14 A
prefilter Preline / prefiltra Preline	MX11.320 Euro6	320	440	09/13 >		S 4142 NR		
rotor for oil centrifuge / rotore per filtro olio centrifugo	MX11.320 Euro6	320	440	09/13 >	S 5905 PO			
power steering / servosterzo	MX11.320 Euro6	320	440	09/13 >				S 3081 PO
power steering ZF RAS-EC / servosterzo ZF RAS-EC	MX11.320 Euro6	320	440	09/13 >				S 5664 PO
XF106.460	MX13.340 Euro6	340	462	09/13 > 06/15	S 5240 PE			S 3062 C
	MX13.340 Euro6	340	462	07/15 >	S 5240 PE			S 4352 CA
with filter Urea/Adblue SCR Denoxtronic 2.2 / con filtro Urea/Adblue SCR Denoxtronic 2.2	MX13.340 Euro6	340	462	09/13 >				S 4405 U
dryer filter / filtro essiccatore	MX13.340 Euro6	340	462	09/13 >				S 7F14 A
prefilter Preline / prefiltra Preline	MX13.340 Euro6	340	462	09/13 >		S 4142 NR		
rotor for oil centrifuge / rotore per filtro olio centrifugo	MX13.340 Euro6	340	462	09/13 >	S 5905 PO			
power steering / servosterzo	MX13.340 Euro6	340	462	09/13 >				S 3081 PO
power steering ZF RAS-EC / servosterzo ZF RAS-EC	MX13.340 Euro6	340	462	09/13 >				S 5664 PO
XF106.510	MX13.375 Euro6	375	510	09/13 > 06/15	S 5240 PE			S 3062 C
	MX13.375 Euro6	375	510	07/15 >	S 5240 PE			S 4352 CA
with filter Urea/Adblue SCR Denoxtronic 2.2 / con filtro Urea/Adblue SCR Denoxtronic 2.2	MX13.375 Euro6	375	510	09/13 >				S 4405 U
dryer filter / filtro essiccatore	MX13.375 Euro6	375	510	09/13 >				S 7F14 A
prefilter Preline / prefiltra Preline	MX13.375 Euro6	375	510	09/13 >		S 4142 NR		
rotor for oil centrifuge / rotore per filtro olio centrifugo	MX13.375 Euro6	375	510	09/13 >	S 5905 PO			
power steering / servosterzo	MX13.375 Euro6	375	510	09/13 >				S 3081 PO
power steering ZF RAS-EC / servosterzo ZF RAS-EC	MX13.375 Euro6	375	510	09/13 >				S 5664 PO

DAF buses/autobus**B 1000 Serie**

B 1100 DA	DA 475				S 6490 PO			
B 1300 DD	DD 575			01/70 > 05/79	S 6490 PO	S 6710 NR		
B 1600 DD	DD 575			01/70 > 05/79	S 6490 PO	S 6710 NR		
B 1600 DF	DF 615					S 6710 NR		
B 1600 DS								
spin-on / avvitalabile	DS 575				S 8600 R			

F 2200 Serie

F 2200 DU					S 5802 R	S 8110 NR	S 2650 A	
------------------	--	--	--	--	----------	-----------	----------	--

MB Serie

MB 200 DKDL	DKDL 1160	121	164	01/70 > 07/90	S 0530 PO	S 8110 NR		
some / alcuni	DKDL 1160	121	164	10/81 > 07/90	S 0530 PO	S 8110 NR	S 8570 A	
power steering / servosterzo	DKDL 1160	121	164	01/70 > 07/90				S 3081 PO
power steering / servosterzo	DKDL 1160	121	164	01/70 > 07/90				S 8790 PO
MB 200 DKL	DKL 1160	109	148	06/74 > 09/81	S 0530 PO	S 8110 NR		
	DKL 1160	109	148	10/81 >	S 0530 PO	S 8110 NR	S 8570 A	
with automatic gearbox ZF HP500/590 / con cambio automatico ZF HP500/590	DKL 1160	109	148	06/74 >				S 2234 Z
power steering / servosterzo	DKL 1160	109	148	06/74 >				S 8790 PO
power steering / servosterzo	DKL 1160	109	148	06/74 >				S 3081 PO
MB 200 DKTL	DKTL 1160			07/79 > 09/81	S 0530 PO	S 8110 NR		
	DKTL 1160			10/81 >	S 0530 PO	S 8110 NR	S 8570 A	
with automatic gearbox ZF HP500/590 / con cambio automatico ZF HP500/590	DKTL 1160			07/79 >	S 2234 Z			S 2234 Z
power steering / servosterzo	DKTL 1160			07/79 >				S 3081 PO
power steering / servosterzo	DKTL 1160			07/79 >				S 8790 PO
MB 230	DKVL			01/86 >	S 8600 R	S 8110 NR	S 8570 A	
MB 230 LB	DKLB 1160				S 8600 R	S 8110 NR	S 8570 A	
MB 230 LT	DKLT 1160				S 8600 R	S 8110 NR	S 8570 A	
MBG-DKTL					S 8600 R	S 8110 NR	S 8570 A	
power steering / servosterzo								S 8790 PO

**KW HP****...DAF - buses/autobus****D**

power steering / servosterzo							S 3081 PO
SB Serie							
SB 1600 DF	DF615					S 6710 NR	
SB 1600 DS							
spin-on / avvitabile	DS 575				S 8600 R		
SB 1602	DU 825					S 8110 NR	
SB 1602 DH	DH 825					S 8110 NR	S 2450 A
SB 200	DKDL 1160	89	121		S 0530 PO	S 8110 NR	S 8570 A
SB 2000							S 2650 A
SB 2005 DH	DH825	115	156	05/80 > 12/90		S 8110 NR	S 2450 A
with automatic gearbox ZF HP500/590 / con cambio automatico ZF HP500/590	DH825	115	156	05/80 > 12/90			S 2234 Z
power steering / servosterzo	DH825	115	156	05/80 > 12/90			S 3081 PO
SB 201	DKDL 1160			01/74 > 07/90	S 0530 PO	S 8110 NR	S 2650 A
with automatic gearbox ZF HP500/590 / con cambio automatico ZF HP500/590	DKDL 1160			01/74 > 07/90			S 2234 Z
inner / interno	DKDL 1160			01/74 > 07/90		S 7129 A	
power steering / servosterzo	DKDL 1160			01/74 > 07/90			S 3081 PO
SB 201 DKDL	DKDL 1160			01/74 > 07/90	S 0530 PO	S 8110 NR	S 2650 A
with automatic gearbox ZF HP500/590 / con cambio automatico ZF HP500/590	DKDL 1160			01/74 > 07/90			S 2234 Z
inner / interno	DKDL 1160			01/74 > 07/90		S 7129 A	
power steering / servosterzo	DKDL 1160			01/74 > 07/90			S 3081 PO
SB 210	DKDL 1160			01/74 > 07/90	S 0530 PO	S 8110 NR	S 2650 A
with automatic gearbox ZF HP500/590 / con cambio automatico ZF HP500/590	DKDL 1160			01/74 > 07/90			S 2234 Z
inner / interno	DKDL 1160			01/74 > 07/90		S 7129 A	
power steering / servosterzo	DKDL 1160			01/74 > 07/90			S 3081 PO
SB 220	DKT1160			03/88 > 12/01	S 8600 R	S 8110 NR	S 7187 A
power steering / servosterzo	DKT1160			03/88 > 12/01			S 3081 PO
SB 220 LC	DKLC 1160				S 8600 R	S 8110 NR	
SB 220 SC					S 8600 R	S 8110 NR	
power steering / servosterzo							S 3081 PO
SB 2300					S 5802 R	S 8110 NR	S 8570 A
power steering / servosterzo							S 8790 PO
power steering / servosterzo							S 3081 PO
SB 2305					S 5802 R	S 8110 NR	S 8570 A
power steering / servosterzo							S 8790 PO
power steering / servosterzo							S 3081 PO
SB 2305 DHS	DHS 825				S 5802 R	S 8110 NR	S 8570 A
power steering / servosterzo	DHS 825						S 8790 PO
power steering / servosterzo	DHS 825						S 3081 PO
SB 2305 DHTD	DHTD 825				S 5802 R	S 8110 NR	S 8570 A
power steering / servosterzo	DHTD 825						S 8790 PO
power steering / servosterzo	DHTD 825						S 3081 PO
SB 2705				01/90 >	S 3408 R		
some / alcuni							
SB 3000	DKSB 1160			01/87 > 12/93	S 8600 R	S 8110 NR	S 2650 A
dryer filter / filtro essiccatore	DKSB 1160			01/87 > 12/93			S 7259 A
inner / interno	DKSB 1160			01/87 > 12/93		S 7129 A	
power steering / servosterzo	DKSB 1160			01/87 > 12/93			S 3081 PO
SB 3000	DKV 1160			01/87 > 12/93	S 8600 R	S 8110 NR	S 0450 A
dryer filter / filtro essiccatore	DKV 1160			01/87 > 12/93			S 7259 A
inner / interno	DKV 1160			01/87 > 12/93		S 1450 A	
power steering / servosterzo	DKV 1160			01/87 > 12/93			S 3081 PO
SB 3000	WS 242	242	330	01/91 > 07/96	S 3408 R	S 8110 NR	S 8570 A
	WS 242	242	330	08/96 > 12/02	S 3408 R	S 4337 NR	S 8570 A
dryer filter / filtro essiccatore	WS 242	242	330	01/91 > 12/02			S 7259 A
power steering / servosterzo	WS 242	242	330	01/91 > 12/02			S 3081 PO
SB 3000	WS 268	268	365	01/91 > 07/96	S 3408 R	S 8110 NR	S 8570 A
	WS 268	268	365	08/96 > 12/02	S 3408 R	S 4337 NR	S 8570 A
dryer filter / filtro essiccatore	WS 268	268	365	01/91 > 12/02			S 7259 A
power steering / servosterzo	WS 268	268	365	01/91 > 12/02			S 3081 PO
SB 3000	WS315	315	430	01/91 > 07/96	S 3275 R	S 8110 NR	S 8570 A
	WS315	315	430	08/96 > 12/02	S 3275 R	S 4337 NR	S 8570 A
dryer filter / filtro essiccatore	WS315	315	430	01/91 > 12/02			S 7259 A
power steering / servosterzo	WS315	315	430	01/91 > 12/02			S 3081 PO
SB 4000	XF250C	250	341	01/02 >	S 5234 PE	S 6146 NE	S 7641 A
inner / interno	XF250C	250	341	01/02 >			S 0768 A
power steering / servosterzo	XF250C	250	341	01/02 >			S 3081 PO
SB 4000	XF280C	280	382	01/02 >	S 5234 PE	S 6146 NE	S 7641 A



kW HP



...DAF - buses/autobus

inner / interno	XF280C	280	382	01/02	>			S 0768 A	
power steering / servosterzo	XF280C	280	382	01/02	>				S 3081 PO
SB 4000	XF315C	315	430	01/02	>	S 5234 PE	S 6146 NE	S 7641 A	
inner / interno	XF315C	315	430	01/02	>			S 0768 A	
power steering / servosterzo	XF315C	315	430	01/02	>				S 3081 PO

TB Serie

TB 160 DF	DF 615			01/70	> 11/81			S 6710 NR	
TB 160 DS	DS 575					S 8600 R			
spin-on / avvitabile	DS 575								
TB 163 DF	DF 615			01/70	> 11/81			S 6710 NR	
TB 163 DS	DS 575					S 8600 R			
spin-on / avvitabile	DS 575								

DENNIS

buses/autobus

Enviro

200 Dart	Cummins ISBe	103	140	07/06	>			S 2220 NR	
with filter Urea/Adblue / con filtro Urea/Adblue	Cummins ISBe	103	140	07/06	>				S 4401 U
200 Dart	Cummins ISBe	118	160	07/06	>			S 2220 NR	
with filter Urea/Adblue / con filtro Urea/Adblue	Cummins ISBe	118	160	07/06	>				S 4401 U
200 Dart	Cummins ISBe	151	205	07/06	>			S 2220 NR	
with filter Urea/Adblue / con filtro Urea/Adblue	Cummins ISBe	151	205	07/06	>				S 4401 U

DENNIS EAGLE

trucks/autocarri

Elite 2

240	Volvo D7E-240	177	241	05/06	>	S 5097 PE	S 6039 NE		
290	Volvo D7E-290	213	290	05/06	>	S 5097 PE	S 6039 NE		
320	Volvo D7E-320	235	320	05/06	>	S 5097 PE	S 6039 NE		

DRESSER HAULPAK

off-highway trucks/autocarri fuoristrada

100 Serie

120C Electric	Caterpillar D348, D349					S 1910 PO			
120C Electric	Cummins KTA2300					S 3409 R			
120C Electric	Detroit Diesel 12V-1497/71					S 3301 PO			
140M	Cummins KTA19C					S 3409 R			
170	Detroit Diesel 16V-149					S 3301 PO			
170CW Electric	Detroit Diesel 16V-149					S 3301 PO			

200 Serie

210M	Cummins KTTA19C					S 3409 R			
-------------	-----------------	--	--	--	--	----------	--	--	--

300 Serie

330M	Cummins KTA38C					S 3409 R			
-------------	----------------	--	--	--	--	----------	--	--	--

500 Serie

510E	Cummins KTTA38C					S 3409 R			
-------------	-----------------	--	--	--	--	----------	--	--	--

DROEGMOELLER

buses/autobus

DR Serie

DR 30	Mercedes Benz OM352			01/73	> 12/79	S 2530 PO	S 2161 N		
DR 30	Mercedes Benz OM352A			01/73	> 12/79	S 0300 O	S 2162 N		
some / alcuni	Mercedes Benz OM352A			08/78	> 12/79	S 5124 PE	S 2162 N		
DR 35	Mercedes Benz OM327				> 12/69	S 0300 O	S 2162 N		
DR 35	Mercedes Benz OM3521				> 12/70	S 0300 O	S 2162 N		
DR 35 L	Mercedes Benz OM327				> 12/69	S 0300 O	S 2162 N		

E Serie

E 280	Mercedes Benz OM421.900			01/80	> 05/01	S 8260 PO	S 2161 N	S 0450 A	
some / alcuni	Mercedes Benz OM421.900			01/80	> 05/01	S 8260 PO	S 2162 N	S 0450 A	
E 280	Mercedes Benz OM422			01/80	> 05/01	S 7261 PO	S 2161 N	S 0450 A	
some / alcuni	Mercedes Benz OM422			01/80	> 05/01	S 7261 PO	S 2162 N	S 0450 A	
E 280 H	Mercedes Benz OM421.900			01/80	> 05/01	S 8260 PO	S 2161 N	S 0450 A	
some / alcuni	Mercedes Benz OM421.900			01/80	> 05/01	S 8260 PO	S 2162 N	S 0450 A	
E 280 H	Mercedes Benz OM422			01/80	> 05/01	S 7261 PO	S 2161 N	S 0450 A	
some / alcuni	Mercedes Benz OM422			01/80	> 05/01	S 7261 PO	S 2162 N	S 0450 A	
E 290	Mercedes Benz OM422.900			01/80	> 05/01	S 7261 PO	S 2162 N	S 0450 A	
E 290	Mercedes Benz OM442.900			04/88	> 05/01	S 7261 PO	S 2162 N		
E 290 H	Mercedes Benz OM422.900			01/80	> 05/01	S 7261 PO	S 2162 N	S 0450 A	
E 290 H	Mercedes Benz OM442.900			04/88	> 05/01	S 7261 PO	S 2162 N		
E 300	Mercedes Benz OM422.900			01/80	> 05/01	S 7261 PO	S 2162 N	S 0450 A	
E 300	Mercedes Benz OM442.900			04/88	> 05/01	S 7261 PO	S 2162 N		
E 300 H	Mercedes Benz OM422.900			01/80	> 05/01	S 7261 PO	S 2162 N	S 0450 A	

D





KW HP



...DROEGMOELLER - buses/autobus

E

E 300 H	Mercedes Benz OM442.900			04/88 > 05/01	S 7261 PO	S 2162 N		
E 310	Mercedes Benz OM422.900			01/80 > 05/01	S 7261 PO	S 2162 N	S 0450 A	
E 310	Mercedes Benz OM442.900			04/88 > 05/01	S 7261 PO	S 2162 N		
E 320	Mercedes Benz OM422.900			01/80 > 05/01	S 7261 PO	S 2162 N	S 0450 A	
E 320	Mercedes Benz OM423			01/80 > 05/01	S 7261 PO	S 2162 N	S 1050 A	
E 320	Mercedes Benz OM442.900			04/88 > 05/01	S 7261 PO	S 2162 N		
E 320 L	Mercedes Benz OM442.901 A			04/88 > 05/01	S 7261 PO	S 2162 N		
E 330	Mercedes Benz OM422.900			01/80 > 05/01	S 7261 PO	S 2162 N	S 0450 A	
E 330	Mercedes Benz OM442.900			04/88 > 05/01	S 7261 PO	S 2162 N		
E 330 H	Mercedes Benz OM422.900			01/80 > 05/01	S 7261 PO	S 2162 N	S 0450 A	
E 330 H	Mercedes Benz OM442.900			04/88 > 05/01	S 7261 PO	S 2162 N		
E 330 K	Mercedes Benz OM422.900			01/80 > 05/01	S 7261 PO	S 2162 N	S 0450 A	
E 330 K	Mercedes Benz OM442.900			04/88 > 05/01	S 7261 PO	S 2162 N		
E 420	Mercedes Benz OM422.901 A			01/80 > 05/01	S 7261 PO	S 2162 N	S 1050 A	
E 420	Mercedes Benz OM423			01/80 > 05/01	S 7261 PO	S 2162 N	S 1050 A	
E 420	Mercedes Benz OM442.901 A			04/88 > 05/01	S 7261 PO	S 2162 N		
E 430	Mercedes Benz OM422.901 A			01/80 > 05/01	S 7261 PO	S 2162 N	S 1050 A	
E 430	Mercedes Benz OM423			01/80 > 05/01	S 7261 PO	S 2162 N	S 1050 A	
E 430	Mercedes Benz OM442.901 A			04/88 > 05/01	S 7261 PO	S 2162 N		
E 430 Supercomet	Mercedes Benz OM402LA			09/91 > 05/01	S 7261 PO	S 2162 N	S 1050 A	
E 430 Supercomet	Mercedes Benz OM442LA			09/91 > 05/01	S 7261 PO	S 2162 N		
E 430 U Supercomet	Mercedes Benz OM442LA			01/90 > 05/01	S 7261 PO	S 2162 N		
E 440	Mercedes Benz OM422.901 A			01/80 > 05/01	S 7261 PO	S 2162 N	S 1050 A	
E 440	Mercedes Benz OM423			01/80 > 05/01	S 7261 PO	S 2162 N	S 1050 A	
E 440	Mercedes Benz OM442.901 A			04/88 > 05/01	S 7261 PO	S 2162 N		

Europullman Serie

E 320	MAN D 2866 LXOH			02/89 > 05/01	S 7260 PO	S 1411 N		
spin-on / avvitabile	MAN D 2866 LXOH			02/89 > 05/01	S 7260 PO	S 4378 NR		
Europullman	Mercedes Benz OM355			01/72 > 12/79	S 0300 O	S 2162 N		
some / alcuni	Mercedes Benz OM355			08/77 > 12/79	S 9490 PO	S 2162 N		
Europullman	Mercedes Benz OM402			01/73 > 12/79	S 7261 PO	S 2162 N	S 0450 A	
some / alcuni	Mercedes Benz OM402			01/73 > 12/79	S 8260 PO	S 2162 N	S 0450 A	

O Serie

LPO 608/36	Mercedes Benz OM314			> 12/70	S 4000 O	S 2161 N		
O 302	Mercedes Benz OM327			> 12/69	S 0300 O	S 2162 N		
O 302	Mercedes Benz OM355			01/72 > 12/79	S 0300 O			
some / alcuni	Mercedes Benz OM355			01/72 > 12/79	S 9490 PO	S 2162 N		
O 302	Mercedes Benz OM360			01/70 > 12/79	S 0300 O	S 2162 N		
some / alcuni	Mercedes Benz OM360			01/70 > 12/79	S 8260 PO	S 2162 N		

E.R.F.

trucks/autocarri

ECL Serie

ECL 7.28 RD3/TP3	MAN D0836	205 280		09/00 >	S 3292 R	S 4378 NR		
dryer filter / filtro essiccatore	MAN D0836	205 280		09/00 >				S 7259 A
power steering / servosterzo	MAN D0836	205 280		09/00 >				S 3081 PO

ECM Serie

ECM 12.36 MPT4	MAN D2866	265 360		09/02 >	S 5016 PE	S 6004 NE		
dryer filter / filtro essiccatore	MAN D2866	265 360		09/02 >				S 7259 A
power steering / servosterzo	MAN D2866	265 360		09/02 >				S 3081 PO
ECM 7.22 RD2	MAN D0836	162 220		09/00 >	S 3292 R	S 4378 NR		
dryer filter / filtro essiccatore	MAN D0836	162 220		09/00 >				S 7259 A
power steering / servosterzo	MAN D0836	162 220		09/00 >				S 3081 PO
ECM 7.28 RD2	MAN D0836	205 280		09/00 >	S 3292 R	S 4378 NR	S 7482 A	
dryer filter / filtro essiccatore	MAN D0836	205 280		09/00 >				S 7259 A
power steering / servosterzo	MAN D0836	205 280		09/00 >				S 3081 PO
ECM 7.28 RDRS3	MAN D0836	205 280		09/00 >	S 3292 R	S 4378 NR	S 7482 A	
dryer filter / filtro essiccatore	MAN D0836	205 280		09/00 >				S 7259 A
power steering / servosterzo	MAN D0836	205 280		09/00 >				S 3081 PO
ECM 7.28 RR3	MAN D0836	205 280		09/00 >	S 3292 R	S 4378 NR	S 7482 A	
dryer filter / filtro essiccatore	MAN D0836	205 280		09/00 >				S 7259 A
power steering / servosterzo	MAN D0836	205 280		09/00 >				S 3081 PO

ECT Serie

ECT 10.35 MT/MTL/ST/DB/DT	MAN D2066LF03	257 350		06/05 >	S 5046 PE	S 6011 NE		
dryer filter / filtro essiccatore	MAN D2066LF03	257 350		06/05 >				S 7259 A
power steering / servosterzo	MAN D2066LF03	257 350		06/05 >				S 3081 PO
ECT 10.43 MT/MTL/ST/DB/DT	MAN D2066LF01	316 430		06/05 >	S 5046 PE	S 6011 NE		
dryer filter / filtro essiccatore	MAN D2066LF01	316 430		06/05 >				S 7259 A

**KW HP****...E.R.F. - trucks/autocarri**

power steering / servosterzo	MAN D2066LF01	316	430	06/05	>				S 3081 PO
ECT 12.36 ST/DB2	MAN D2866	265	360	05/02	>	S 5016 PE	S 6004 NE		
dryer filter / filtro essiccatore	MAN D2866	265	360	05/02	>				S 7259 A
power steering / servosterzo	MAN D2866	265	360	05/02	>				S 3081 PO
ECT 13.46 MT/MTL/DT/RDB3	MAN D2876	338	460	05/02	>	S 5016 PE	S 6004 NE		
dryer filter / filtro essiccatore	MAN D2876	338	460	05/02	>				S 7259 A
power steering / servosterzo	MAN D2876	338	460	05/02	>				S 3081 PO
ECT 13.48 MT	MAN D2876	351	480	02/03	>	S 5016 PE	S 6016 NE		
dryer filter / filtro essiccatore	MAN D2876	351	480	02/03	>				S 7259 A
power steering / servosterzo	MAN D2876	351	480	02/03	>				S 3081 PO

EUCLID**dump trucks/autocarri ribaltabili****A Serie**

A 464							S 4510 NR		
spin-on / avvitabile	Cummins NT 855C								

B Serie

B 100							S 4510 NR		
spin-on / avvitabile	Cummins VT 1710C								
B 100						S 3301 PO			S 3301 PO
drive / trasmissione	Detroit Diesel 16V-71N								
	Detroit Diesel 16V-71N								
B 110							S 4510 NR		
spin-on / avvitabile	Cummins VT 1710C								
B 110						S 3301 PO			S 3301 PO
drive / trasmissione	Detroit Diesel 16V-71N								
	Detroit Diesel 16V-71N								
B 63							S 4510 NR		
spin-on / avvitabile	Cummins								
B 63						S 3301 PO			
drive / trasmissione	Detroit Diesel 12V-71								
B 70							S 4510 NR		
spin-on / avvitabile	Cummins								
B 70						S 3301 PO			
drive / trasmissione	Detroit Diesel 12V-71								

CH Serie

CH 100						S 3301 PO			
drive / trasmissione	Detroit Diesel 16V-71								
CH 120									S 3301 PO
drive / trasmissione	Cummins VT 1710								
CH 120						S 3301 PO			
drive / trasmissione	Detroit Diesel 16V-71								
CH 120						S 3301 PO			
drive / trasmissione	Detroit Diesel 16V-92								
CH 150						S 3301 PO			
drive / trasmissione	Detroit Diesel 12V-149								

R Serie

R 10 (mod. UD)						S 3301 PO			
some / alcuni	Detroit Diesel 4-71								
	Detroit Diesel 4-71								S 6940 A
R 100						S 3301 PO			S 7315 A
inner / interno	Detroit Diesel 12V-149								S 7314 A
	Detroit Diesel 12V-149								
R 12 (mod. UD)						S 3301 PO			
some / alcuni	Detroit Diesel 4-71								S 6940 A
	Detroit Diesel 4-71								
R 120						S 3301 PO			
drive / trasmissione	Detroit Diesel 12V-149								
R 120 E						S 3301 PO			
drive / trasmissione	Detroit Diesel 12V-149								
R 120 M						S 3301 PO			
drive / trasmissione	Detroit Diesel 12V-149								
R 13 (mod. UD)						S 3301 PO			
some / alcuni	Detroit Diesel 4-71								S 6940 A
	Detroit Diesel 4-71								
R 130						S 3301 PO			
drive / trasmissione	Detroit Diesel								
R 15 (mod. FD)									S 7011 A
spin-on / avvitabile	Cummins NH6, NH 220						S 4510 NR		S 7011 A
	Cummins NH6, NH 220								
R 15 (mod. FD)						S 3301 PO			S 9990 A
drive / trasmissione	Detroit Diesel 6-71								
R 17 (mod. FD)						S 3301 PO			S 9990 A
drive / trasmissione	Detroit Diesel 6-71								
R 170						S 3301 PO			
drive / trasmissione	Detroit Diesel 12V-149								
R 170						S 3301 PO			
drive / trasmissione	Detroit Diesel 16V-149								
R 18 (mod. FD)									S 7011 A
spin-on / avvitabile	Cummins NH6, NH 220						S 4510 NR		S 7011 A
	Cummins NH6, NH 220								
R 18 (mod. FD)						S 3301 PO			S 9990 A
drive / trasmissione	Detroit Diesel 6-71								
R 20 (mod. FD)									
spin-on / avvitabile	Cummins NH 250						S 4510 NR		
R 20 (mod. FD)						S 3301 PO			S 5450 A
with outer dry air filter / con filtro aria a secco, esterno	Detroit Diesel 6-71								S 6270 A
with inner dry air filter / con filtro aria a secco, interno	Detroit Diesel 6-71								S 8270 A
inner / interno	Detroit Diesel 6-71								S 3450 A
drive / trasmissione	Detroit Diesel 6-71								
R 22 (mod. TD)									S 3301 PO





KW HP



...EUCLID - dump trucks/autocarri ribaltabili

spin-on / avvitabile	Cummins NHRS 6			S 4510 NR	
R 22 (mod. TD)	Detroit Diesel 6-110		S 3301 PO	S 5450 A	
with outer dry air filter / con filtro aria a secco, esterno	Detroit Diesel 6-110			S 7945 A	
with inner dry air filter / con filtro aria a secco, interno	Detroit Diesel 6-110			S 7024 A	
inner / interno	Detroit Diesel 6-110			S 3450 A	
R 22 (mod. TD)	Detroit Diesel 6-71		S 3301 PO		
with outer dry air filter / con filtro aria a secco, esterno	Detroit Diesel 6-71			S 7945 A	
inner / interno	Detroit Diesel 6-71			S 7024 A	
R 24	Cummins NH 250			S 4510 NR	S 5450 A
with outer dry air filter / con filtro aria a secco, esterno	Cummins NH 250			S 7945 A	
with inner dry air filter / con filtro aria a secco, interno	Cummins NH 250			S 7024 A	
inner / interno	Cummins NH 250			S 3450 A	
R 25	Mercedes Benz OM421LA		S 7261 PO		
R 25 (mod. TD)	Cummins			S 9990 A	
spin-on / avvitabile	Cummins			S 4510 NR	S 9990 A
drive / trasmissione	Cummins				S 3301 PO
R 25 S (mod. TD)	Cummins			S 9990 A	
spin-on / avvitabile	Cummins			S 4510 NR	S 9990 A
drive / trasmissione	Cummins				S 3301 PO
R 27 (mod. TD)	Cummins			S 9990 A	
spin-on / avvitabile	Cummins			S 4510 NR	S 9990 A
drive / trasmissione	Cummins				S 3301 PO
R 27 (mod. TD)	Detroit Diesel 6-110		S 3301 PO		
with outer dry air filter / con filtro aria a secco, esterno	Detroit Diesel 6-110			S 7945 A	
inner / interno	Detroit Diesel 6-110			S 7024 A	
drive / trasmissione	Detroit Diesel 6-110				S 3301 PO
R 30 (mod. TD)	Cummins NT 335			S 9990 A	
some / alcuni	Cummins NT 335			S 7010 A	
spin-on / avvitabile	Cummins NT 335			S 4510 NR	S 7010 A
drive / trasmissione	Cummins NT 335				S 3301 PO
R 30 (mod. TD)	Detroit Diesel 12V-71		S 3301 PO	S 9990 A	
some / alcuni	Detroit Diesel 12V-71		S 3301 PO	S 7010 A	
drive / trasmissione	Detroit Diesel 12V-71				S 3301 PO
R 30 (mod. TD)					
with dry air filter / con filtro aria a secco	Detroit Diesel 6-110			S 7010 A	
full-flow	Detroit Diesel 6-110		S 3301 PO		
drive / trasmissione	Detroit Diesel 6-110				S 3301 PO
R 35	Mercedes Benz OM423LA		S 7261 PO		
R 35 (mod. 75TD)					
spin-on / avvitabile	Cummins NTA 380			S 4510 NR	
R 35 (mod. 75TD)					
spin-on / avvitabile	Cummins NTA 855C			S 4510 NR	
R 35 (mod. TD)	Cummins NT 335			S 9990 A	
some / alcuni	Cummins NT 335			S 7010 A	
spin-on / avvitabile	Cummins NT 335			S 4510 NR	S 7010 A
drive / trasmissione	Cummins NT 335				S 3301 PO
R 35 (mod. TD)	Detroit Diesel 12V-71		S 3301 PO	S 9990 A	
some / alcuni	Detroit Diesel 12V-71		S 3301 PO	S 7010 A	
drive / trasmissione	Detroit Diesel 12V-71				S 3301 PO
R 35 (mod. TD)	Detroit Diesel 6-110		S 3301 PO		
with dry air filter / con filtro aria a secco	Detroit Diesel 6-110			S 7010 A	
drive / trasmissione	Detroit Diesel 6-110				S 3301 PO
R 40 (mod. FFD)					
spin-on / avvitabile	2 Cummins NT 6			S 4510 NR	
drive / trasmissione	2 Cummins NT 6				S 3301 PO
R 40 (mod. FFD)	2 Detroit Diesel 6-71				S 9990 A
drive / trasmissione	2 Detroit Diesel 6-71				S 3301 PO
R 40 (mod. FFD)	Cummins V12-525				S 9990 A
spin-on / avvitabile	Cummins V12-525			S 4510 NR	S 9990 A
drive / trasmissione	Cummins V12-525				S 3301 PO
R 40 (mod. FFD)	Detroit Diesel 16V-71		S 3301 PO	S 9990 A	
drive / trasmissione	Detroit Diesel 16V-71				S 3301 PO
R 40 (mod. LD)					
spin-on / avvitabile	2 Cummins NT 6			S 4510 NR	
drive / trasmissione	2 Cummins NT 6				S 3301 PO
R 40 (mod. LD)	2 Detroit Diesel 6-71				S 9990 A
drive / trasmissione	2 Detroit Diesel 6-71				S 3301 PO



KW HP



...EUCLID - dump trucks/autocarri ribaltabili

R 40 (mod. LD) spin-on / avvitabile drive / trasmissione	Cummins V12-525 Cummins V12-525 Cummins V12-525			S 4510 NR	S 9990 A S 9990 A	S 3301 PO
R 40 (mod. LD) drive / trasmissione	Detroit Diesel 16V-71 Detroit Diesel 16V-71		S 3301 PO		S 9990 A	S 3301 PO
R 45 (mod. FFD) spin-on / avvitabile drive / trasmissione	2 Cummins NT 6 2 Cummins NT 6			S 4510 NR		S 3301 PO
R 45 (mod. FFD) drive / trasmissione	2 Detroit Diesel 6-71 2 Detroit Diesel 6-71				S 9990 A	S 3301 PO
R 45 (mod. FFD) spin-on / avvitabile drive / trasmissione	Cummins V12-525 Cummins V12-525			S 4510 NR	S 9990 A S 9990 A	S 3301 PO
R 45 (mod. FFD) drive / trasmissione	Detroit Diesel 16V-71 Detroit Diesel 16V-71		S 3301 PO		S 9990 A	S 3301 PO
R 45 (mod. LD) spin-on / avvitabile drive / trasmissione	2 Cummins NT 6 2 Cummins NT 6			S 4510 NR		S 3301 PO
R 45 (mod. LD) drive / trasmissione	2 Detroit Diesel 6-71 2 Detroit Diesel 6-71				S 9990 A	S 3301 PO
R 45 (mod. LD) spin-on / avvitabile drive / trasmissione	Cummins V12-525 Cummins V12-525			S 4510 NR	S 9990 A S 9990 A	S 3301 PO
R 45 (mod. LD) drive / trasmissione	Detroit Diesel 16V-71 Detroit Diesel 16V-71		S 3301 PO		S 9990 A	S 3301 PO
R 50 inner / interno	Cummins KTA1150 Cummins KTA1150		S 3409 R		S 7313 A S 7312 A	
R 50	Mercedes Benz OM424LA		S 7261 PO			
R 50 (mod. LLD) spin-on / avvitabile drive / trasmissione	2 Cummins NT 335 2 Cummins NT 335			S 4510 NR	S 9990 A S 9990 A	S 3301 PO
R 50 (mod. LLD) drive / trasmissione	2 Detroit Diesel 6-110 2 Detroit Diesel 6-110		S 3301 PO			S 3301 PO
R 50 (mod. LLD) spin-on / avvitabile drive / trasmissione	Cummins NRTO 6 Cummins NRTO 6			S 4510 NR	S 9990 A S 9990 A	S 3301 PO
R 50 (mod. LLD) drive / trasmissione	Detroit Diesel 16V-71N Detroit Diesel 16V-71N		S 3301 PO			S 3301 PO
R 62 (mod. LLD) spin-on / avvitabile drive / trasmissione	2 Cummins NT 335 2 Cummins NT 335			S 4510 NR	S 9990 A S 9990 A	S 3301 PO
R 62 (mod. LLD) drive / trasmissione	2 Detroit Diesel 6-110 2 Detroit Diesel 6-110		S 3301 PO			S 3301 PO
R 62 (mod. LLD) spin-on / avvitabile drive / trasmissione	Cummins NRTO 6 Cummins NRTO 6			S 4510 NR	S 9990 A S 9990 A	S 3301 PO
R 62 (mod. LLD) drive / trasmissione	Detroit Diesel 16V-71N Detroit Diesel 16V-71N		S 3301 PO			S 3301 PO
R 75 spin-on / avvitabile	Cummins VTA 1710C			S 4510 NR		
R 75	Detroit Diesel 16V-71T		S 3301 PO			
R 85	Detroit Diesel 16V-92		S 3301 PO			
RX 105 drive / trasmissione	Detroit Diesel 12V-149T Detroit Diesel 12V-149T		S 3301 PO			S 3301 PO

FAUN

dump trucks/autocarri ribaltabili

K Serie

K 10 2nd passage / 2.passaggio power steering / servosterzo	KHD F8L914 KHD F8L914 KHD F8L914			S 0201 N S 1411 N		S 8790 PO
K 10 2nd passage / 2.passaggio power steering / servosterzo	Mercedes Benz OM355 Mercedes Benz OM355 Mercedes Benz OM355		S 0300 O	S 0201 N S 1411 N		S 8790 PO
K 10/26 AV spin-on / avvitabile spin-on / avvitabile	KHD F6L514 KHD F6L514 KHD F6L514 KHD F6L514	> 12/66 01/67 >	S 4000 O S 8600 R S 4000 O S 8600 R	S 1411 N S 1411 N S 5400 NR S 5400 NR		

F





kW HP



...FAUN - dump trucks/autocarri ribaltabili

power steering / servosterzo	KHD F6L514					S 8790 PO
K 10/28 AP	KHD F6L514	> 12/66	S 4000 O	S 1411 N		
	KHD F6L514	01/67 >	S 8600 R	S 1411 N		
spin-on / avvitabile	KHD F6L514	> 12/66	S 4000 O	S 5400 NR		
spin-on / avvitabile	KHD F6L514	01/67 >	S 8600 R	S 5400 NR		
power steering / servosterzo	KHD F6L514					S 8790 PO
K 10/28 P	KHD F6L514	> 12/66	S 4000 O	S 1411 N		
	KHD F6L514	01/67 >	S 8600 R	S 1411 N		
spin-on / avvitabile	KHD F6L514	> 12/66	S 4000 O	S 5400 NR		
spin-on / avvitabile	KHD F6L514	01/67 >	S 8600 R	S 5400 NR		
power steering / servosterzo	KHD F6L514					S 8790 PO
K 100	Cummins NTA 855				S 7945 A	
power steering / servosterzo	Cummins NTA 855					S 8790 PO
K 100	Cummins V 1710				S 7945 A	
power steering / servosterzo	Cummins V 1710					S 8790 PO
K 15	KHD			S 1411 N		
K 15 V	KHD			S 0201 N		
2nd passage / 2.passaggio	KHD			S 1411 N		
power steering / servosterzo	KHD					S 8790 PO
K 15/37	KHD			S 1411 N		
K 20	KHD			S 0201 N		
2nd passage / 2.passaggio	KHD			S 1411 N		
power steering / servosterzo	KHD					S 8790 PO
K 20 VAS	KHD			S 0201 N		
2nd passage / 2.passaggio	KHD			S 1411 N		
power steering / servosterzo	KHD					S 8790 PO
K 20 W	Mercedes Benz OM355		S 0300 O	S 0201 N		
2nd passage / 2.passaggio	Mercedes Benz OM355			S 1411 N		
power steering / servosterzo	Mercedes Benz OM355					S 8790 PO
K 20/37 VA-WA	KHD F8L914			S 0201 N		
2nd passage / 2.passaggio	KHD F8L914			S 1411 N		
power steering / servosterzo	KHD F8L914					S 8790 PO
K 20/37 VA-WA	Mercedes Benz OM355		S 0300 O	S 0201 N		
2nd passage / 2.passaggio	Mercedes Benz OM355			S 1411 N		
power steering / servosterzo	Mercedes Benz OM355					S 8790 PO
K 20/41	KHD			S 0201 N		
2nd passage / 2.passaggio	KHD			S 1411 N		
power steering / servosterzo	KHD					S 8790 PO
K 22.2 B	KHD		S 8600 R	S 5400 NR		
hydraulic / idraulico	KHD					S 3301 PO
K 23.2	KHD		S 8600 R	S 5400 NR		
hydraulic / idraulico	KHD					S 3301 PO
K 23.2 A	KHD		S 8600 R	S 5400 NR		
hydraulic / idraulico	KHD					S 3301 PO
K 24.2	KHD		S 8600 R	S 5400 NR		
hydraulic / idraulico	KHD					S 3301 PO
K 24.2 A	KHD		S 8600 R	S 5400 NR		
hydraulic / idraulico	KHD					S 3301 PO
K 25	KHD F12L413		S 8600 R	S 0201 N	S 2450 A	
2nd passage / 2.passaggio	KHD F12L413			S 1411 N		
some / alcuni	KHD F12L413		S 8600 R	S 0201 N	S 0940 A	
power steering / servosterzo	KHD F12L413					S 8790 PO
K 25 4x4	KHD F12L413		S 8600 R	S 0201 N	S 2450 A	
2nd passage / 2.passaggio	KHD F12L413			S 1411 N		
some / alcuni	KHD F12L413		S 8600 R	S 0201 N	S 0940 A	
power steering / servosterzo	KHD F12L413					S 8790 PO
K 25.2	KHD F8L413F		S 8600 R	S 5400 NR	S 8950 A	
K 25/36 V	KHD F12L413		S 8600 R	S 0201 N	S 2450 A	
2nd passage / 2.passaggio	KHD F12L413			S 1411 N		
some / alcuni	KHD F12L413		S 8600 R	S 0201 N	S 0940 A	
power steering / servosterzo	KHD F12L413					S 8790 PO
K 25/36 V-VA	KHD F8L914			S 0201 N		
2nd passage / 2.passaggio	KHD F8L914			S 1411 N		
power steering / servosterzo	KHD F8L914					S 8790 PO
K 25/36 V-VA	Mercedes Benz OM355		S 0300 O	S 0201 N		
2nd passage / 2.passaggio	Mercedes Benz OM355			S 1411 N		
power steering / servosterzo	Mercedes Benz OM355					S 8790 PO



KW HP



...FAUN - dump trucks/autocarri ribaltabili

K 28	KHD F12L413		S 8600 R	S 0201 N	S 2450 A	
2nd passage / 2.passaggio	KHD F12L413			S 1411 N		
some / alcuni	KHD F12L413		S 8600 R	S 0201 N	S 0940 A	S 8790 PO
power steering / servosterzo	KHD F12L413					
K 28 4x4	KHD F12L413		S 8600 R	S 0201 N	S 2450 A	
2nd passage / 2.passaggio	KHD F12L413			S 1411 N		
some / alcuni	KHD F12L413		S 8600 R	S 0201 N	S 0940 A	
power steering / servosterzo	KHD F12L413					S 8790 PO
K 30	Cummins NTA 855				S 7945 A	
power steering / servosterzo	Cummins NTA 855					S 8790 PO
K 30	Cummins V 1710				S 7945 A	
power steering / servosterzo	Cummins V 1710					S 8790 PO
K 30 4x4	Cummins NTA 855				S 7945 A	
power steering / servosterzo	Cummins NTA 855					S 8790 PO
K 30 4x4	Cummins V 1710				S 7945 A	
power steering / servosterzo	Cummins V 1710					S 8790 PO
K 30.31	Cummins NTA 855				S 7945 A	
power steering / servosterzo	Cummins NTA 855					S 8790 PO
K 30.31	Cummins V 1710				S 7945 A	
power steering / servosterzo	Cummins V 1710					S 8790 PO
K 30/36 W-WA	KHD			S 0201 N		
2nd passage / 2.passaggio	KHD			S 1411 N		
power steering / servosterzo	KHD					S 8790 PO
K 30/40						
power steering / servosterzo	Rolls Royce CF TFL					S 8790 PO
K 35.4	KHD		S 8600 R	S 5400 NR		
hydraulic / idraulico	KHD					S 3301 PO
K 40	Cummins NTA 855				S 7945 A	
power steering / servosterzo	Cummins NTA 855					S 8790 PO
K 40	Cummins V 1710				S 7945 A	
power steering / servosterzo	Cummins V 1710					S 8790 PO
K 40	Detroit Diesel		S 3301 PO			
drive / trasmissione	Detroit Diesel					S 3301 PO
K 40 W	KHD BF12M716		S 0530 PO	S 0201 N		
2nd passage / 2.passaggio	KHD BF12M716			S 1411 N		
K 40.4	Cummins NTA 855				S 7945 A	
power steering / servosterzo	Cummins NTA 855					S 8790 PO
K 40.4	Cummins V 1710				S 7945 A	
power steering / servosterzo	Cummins V 1710					S 8790 PO
K 40.4	Detroit Diesel		S 3301 PO			
drive / trasmissione	Detroit Diesel					S 3301 PO
K 40.4	KHD		S 8600 R	S 5400 NR		
hydraulic / idraulico	KHD					S 3301 PO
K 40.4 A	KHD		S 8600 R	S 5400 NR		
hydraulic / idraulico	KHD					S 3301 PO
K 40.5	Cummins NTA 855				S 7945 A	
power steering / servosterzo	Cummins NTA 855					S 8790 PO
K 40.5	Cummins V 1710				S 7945 A	
power steering / servosterzo	Cummins V 1710					S 8790 PO
K 40.5	Detroit Diesel		S 3301 PO			
drive / trasmissione	Detroit Diesel					S 3301 PO
K 40/40 VW	KHD			S 0201 N		
2nd passage / 2.passaggio	KHD			S 1411 N		
power steering / servosterzo	KHD					S 8790 PO
K 55.6	Detroit Diesel		S 3301 PO			
drive / trasmissione	Detroit Diesel					S 3301 PO
K 55.8	Cummins					S 3301 PO
hydraulic / idraulico						
K 80	Cummins NTA 855				S 7945 A	
power steering / servosterzo	Cummins NTA 855					S 8790 PO
K 80	Cummins V 1710				S 7945 A	
power steering / servosterzo	Cummins V 1710					S 8790 PO
K 80	Detroit Diesel		S 3301 PO			
drive / trasmissione	Detroit Diesel					S 3301 PO
K 85.8	Cummins					S 3301 PO
hydraulic / idraulico						
K 85.8	Detroit Diesel		S 3301 PO			

F



**KW HP****...FAUN - dump trucks/autocarri ribaltabili****F**

drive / trasmissione	Detroit Diesel					S 3301 PO
UK Serie						
UK 10	KHD F4M716		S 0530 PO	S 0201 N		
2nd passage / 2.passaggio	KHD F4M716			S 1411 N		
power steering / servosterzo	KHD F4M716					S 8790 PO
FODEN trucks/autocarri						
2 Serie						
S 104	Caterpillar 3306B, 3408	01/84 >	S 0900 R	S 0810 NR	S 6550 A	
some / alcuni	Caterpillar 3306B, 3408	01/84 >	S 0900 R	S 0810 NR	S 7945 A	
S 104	Caterpillar 3406B		S 0900 R	S 0810 NR	S 7945 A	
S 104	Cummins E350, E400		S 3409 R	S 4510 NR	S 7945 A	
inner / interno	Cummins E350, E400				S 7024 A	
S 104	Cummins LT10-250		S 3409 R	S 4510 NR	S 0150 A	
some / alcuni	Cummins LT10-250		S 3409 R	S 4510 NR	S 7945 A	
some / alcuni	Cummins LT10-250		S 3409 R	S 4510 NR	S 6550 A	
S 104	Cummins NT250, NTE290		S 3409 R	S 4510 NR	S 7945 A	
some / alcuni	Cummins NT250, NTE290		S 3409 R	S 4510 NR	S 0150 A	
some / alcuni	Cummins NT250, NTE290		S 3409 R	S 4510 NR	S 6550 A	
inner / interno	Cummins NT250, NTE290				S 7024 A	
S 104	Cummins NTE350, VT504, V555		S 3409 R	S 4510 NR	S 0150 A	
some / alcuni	Cummins NTE350, VT504, V555		S 3409 R	S 4510 NR	S 7945 A	
some / alcuni	Cummins NTE350, VT504, V555		S 3409 R	S 4510 NR	S 6550 A	
S 104	Cummins Super E320TD		S 3409 R	S 4510 NR		
S 104	Gardner 6LXCT/8LXV/8LXCT		S 0900 R		S 0150 A	
some / alcuni	Gardner 6LXCT/8LXV/8LXCT		S 0900 R		S 6550 A	
S 104	Gardner 6LXDT		S 0900 R		S 6550 A	
S 104	Rolls Royce 220, 265, 290				S 0150 A	
some / alcuni	Rolls Royce 220, 265, 290				S 6550 A	
some / alcuni	Rolls Royce 220, 265, 290				S 7945 A	
S 104	Rolls Royce 305, 320L				S 0150 A	
some / alcuni	Rolls Royce 305, 320L				S 7945 A	
some / alcuni	Rolls Royce 305, 320L				S 6550 A	
S 104	Rolls Royce 325LE, 350LE				S 7945 A	
S 106	Caterpillar 3306B, 3408	01/84 >	S 0900 R	S 0810 NR	S 6550 A	
some / alcuni	Caterpillar 3306B, 3408	01/84 >	S 0900 R	S 0810 NR	S 7945 A	
S 106	Caterpillar 3406B		S 0900 R	S 0810 NR	S 7945 A	
S 106	Cummins E350, E400		S 3409 R	S 4510 NR	S 7945 A	
inner / interno	Cummins E350, E400				S 7024 A	
S 106	Cummins LT10-250		S 3409 R	S 4510 NR	S 0150 A	
some / alcuni	Cummins LT10-250		S 3409 R	S 4510 NR	S 7945 A	
some / alcuni	Cummins LT10-250		S 3409 R	S 4510 NR	S 6550 A	
S 106	Cummins NT250, NTE290		S 3409 R	S 4510 NR	S 7945 A	
some / alcuni	Cummins NT250, NTE290		S 3409 R	S 4510 NR	S 0150 A	
some / alcuni	Cummins NT250, NTE290		S 3409 R	S 4510 NR	S 6550 A	
inner / interno	Cummins NT250, NTE290				S 7024 A	
S 106	Cummins NTE350, VT504, V555		S 3409 R	S 4510 NR	S 0150 A	
some / alcuni	Cummins NTE350, VT504, V555		S 3409 R	S 4510 NR	S 7945 A	
some / alcuni	Cummins NTE350, VT504, V555		S 3409 R	S 4510 NR	S 6550 A	
S 106	Cummins Super E320TD		S 3409 R	S 4510 NR		
S 106	Gardner 6LXCT/8LXV/8LXCT		S 0900 R		S 0150 A	
some / alcuni	Gardner 6LXCT/8LXV/8LXCT		S 0900 R		S 6550 A	
S 106	Gardner 6LXDT		S 0900 R		S 6550 A	
S 106	Rolls Royce 220, 265, 290				S 0150 A	
some / alcuni	Rolls Royce 220, 265, 290				S 7945 A	
some / alcuni	Rolls Royce 220, 265, 290				S 6550 A	
S 106	Rolls Royce 305, 320L				S 0150 A	
some / alcuni	Rolls Royce 305, 320L				S 6550 A	
some / alcuni	Rolls Royce 305, 320L				S 7945 A	
S 106	Rolls Royce 325LE, 350LE				S 7945 A	
S 108	Caterpillar 3306B, 3408	01/84 >	S 0900 R	S 0810 NR	S 6550 A	
some / alcuni	Caterpillar 3306B, 3408	01/84 >	S 0900 R	S 0810 NR	S 7945 A	
S 108	Caterpillar 3406B		S 0900 R	S 0810 NR	S 7945 A	
S 108	Cummins E350, E400		S 3409 R	S 4510 NR	S 7945 A	
inner / interno	Cummins E350, E400				S 7024 A	
S 108	Cummins LT10-250		S 3409 R	S 4510 NR	S 0150 A	
some / alcuni	Cummins LT10-250		S 3409 R	S 4510 NR	S 7945 A	



KW HP



...FODEN - trucks/autocarri

some / alcuni	Cummins LT10-250		S 3409 R	S 4510 NR	S 6550 A	
S 108	Cummins NT250, NTE290		S 3409 R	S 4510 NR	S 7945 A	
some / alcuni	Cummins NT250, NTE290		S 3409 R	S 4510 NR	S 6550 A	
some / alcuni	Cummins NT250, NTE290		S 3409 R	S 4510 NR	S 0150 A	
inner / interno	Cummins NT250, NTE290				S 7024 A	
S 108	Cummins NTE360, VT504, V555		S 3409 R	S 4510 NR	S 0150 A	
some / alcuni	Cummins NTE360, VT504, V555		S 3409 R	S 4510 NR	S 6550 A	
some / alcuni	Cummins NTE360, VT504, V555		S 3409 R	S 4510 NR	S 7945 A	
S 108	Cummins Super E320TD		S 3409 R	S 4510 NR		
S 108	Gardner 6LXCT/8LXV/8LXCT		S 0900 R		S 0150 A	
some / alcuni	Gardner 6LXCT/8LXV/8LXCT		S 0900 R		S 6550 A	
S 108	Gardner 6LXDT		S 0900 R		S 6550 A	
S 108	Rolls Royce 220, 265, 290				S 0150 A	
some / alcuni	Rolls Royce 220, 265, 290				S 6550 A	
some / alcuni	Rolls Royce 220, 265, 290				S 7945 A	
S 108	Rolls Royce 305, 320L				S 0150 A	
some / alcuni	Rolls Royce 305, 320L				S 7945 A	
some / alcuni	Rolls Royce 305, 320L				S 6550 A	
S 108	Rolls Royce 325LE, 350LE				S 7945 A	
2000 Serie						
S 104 R						
2nd passage / 2.passaggio	Cummins 6BTA-180			S 5400 NR		
S 104 R	Cummins LTA10-250		S 3409 R	S 4510 NR	S 6550 A	
S 104 R	Cummins Super E320		S 3409 R	S 4510 NR	S 6550 A	
S 104 R	Perkins Phaser 210i		S 9400 R	S 7111 NC		
heavy duty	Perkins Phaser 210i		S 0420 R	S 7111 NC		
or / oppure	Perkins Phaser 210i		S 5600 R	S 7112 NC		
S 106 T						
2nd passage / 2.passaggio	Cummins 6BTA-180			S 5400 NR		
S 106 T	Cummins LTA10-250		S 3409 R	S 4510 NR	S 6550 A	
S 106 T	Cummins Super E320		S 3409 R	S 4510 NR	S 6550 A	
S 106 T	Perkins Phaser 210i		S 9400 R	S 7111 NC		
heavy duty	Perkins Phaser 210i		S 0420 R	S 7111 NC		
or / oppure	Perkins Phaser 210i		S 9400 R	S 7112 NC		
S 108 T						
2nd passage / 2.passaggio	Cummins 6BTA-180			S 5400 NR		
S 108 T	Cummins LTA10-250		S 3409 R	S 4510 NR	S 6550 A	
S 108 T	Cummins Super E320		S 3409 R	S 4510 NR	S 6550 A	
S 108 T	Perkins Phaser 210i		S 9400 R	S 7111 NC		
heavy duty	Perkins Phaser 210i		S 0420 R	S 7111 NC		
or / oppure	Perkins Phaser 210i		S 9400 R	S 7112 NC		
3000 Serie						
S 104	Cummins 6CT (8.3)				S 6550 A	
2nd passage / 2.passaggio	Cummins 6CT (8.3)			S 5400 NR		
S 104	Cummins 6CTAA (8.3)				S 6550 A	
2nd passage / 2.passaggio	Cummins 6CTAA (8.3)			S 5400 NR		
S 104	Cummins LTAA10-327		S 3409 R	S 4510 NR	S 6550 A	
S 106	Cummins 6CT (8.3)				S 6550 A	
2nd passage / 2.passaggio	Cummins 6CT (8.3)			S 5400 NR		
S 106	Cummins 6CTAA (8.3)				S 6550 A	
2nd passage / 2.passaggio	Cummins 6CTAA (8.3)			S 5400 NR		
S 106	Cummins LTAA10-327		S 3409 R	S 4510 NR	S 6550 A	
S 108	Cummins 6CT (8.3)				S 6550 A	
2nd passage / 2.passaggio	Cummins 6CT (8.3)			S 5400 NR		
S 108	Cummins 6CTAA (8.3)				S 6550 A	
2nd passage / 2.passaggio	Cummins 6CTAA (8.3)			S 5400 NR		
S 108	Cummins LTAA10-327		S 3409 R	S 4510 NR	S 6550 A	
4000 Serie						
S 104	Caterpillar 3306, 3306ATAAC	01/88 >	S 0900 R	S 0810 NR	S 6550 A	
some / alcuni	Caterpillar 3306, 3306ATAAC	01/88 >	S 0900 R	S 0810 NR	S 7945 A	
S 104	Caterpillar 3306B, 3306BATAAC		S 0900 R	S 0810 NR	S 6550 A	
some / alcuni	Caterpillar 3306B, 3306BATAAC		S 0900 R	S 0810 NR	S 7945 A	
S 104	Caterpillar 3406B, 3406BATAAC				S 6550 A	
S 104	Cummins 6CT (8.3)				S 6550 A	
2nd passage / 2.passaggio	Cummins 6CT (8.3)			S 5400 NR		
S 104	Cummins E320		S 3409 R	S 4510 NR	S 6550 A	
S 104	Cummins LT10-250		S 3409 R	S 4510 NR	S 6550 A	

F





KW HP



...FODEN - trucks/autocarri

F

S 104	Cummins LTA10-250		S 3409 R	S 4510 NR	S 6550 A
S 104	Cummins LTA10-275		S 3409 R	S 4510 NR	S 6550 A
S 104	Cummins LTAA10-325		S 3409 R	S 4510 NR	S 6550 A
S 104	Cummins NTAA410			S 4510 NR	
S 104	Cummins NTE320		S 3409 R	S 4510 NR	S 7945 A
S 104	Cummins NTE365		S 3409 R	S 4510 NR	S 7945 A
S 104	with two-stage filter / con filtro a doppio stadio	Perkins 300TX, 325TX			S 7945 A
S 104	with two-stage filter / con filtro a doppio stadio	Perkins 350TX, 375TX			S 7945 A
S 104	with two-stage filter / con filtro a doppio stadio	Rolls Royce 265LE			S 6550 A
S 104	with two-stage filter / con filtro a doppio stadio	Rolls Royce 300LE/325LE/350LE			S 7945 A
S 106	Caterpillar 3306, 3306ATAAC	01/88 >	S 0900 R	S 0810 NR	S 6550 A
some / alcuni	Caterpillar 3306, 3306ATAAC	01/88 >	S 0900 R	S 0810 NR	S 7945 A
S 106	Caterpillar 3306B, 3306BATAAC		S 0900 R	S 0810 NR	S 6550 A
some / alcuni	Caterpillar 3306B, 3306BATAAC		S 0900 R	S 0810 NR	S 7945 A
S 106	Caterpillar 3406B, 3406BATAAC				S 6550 A
S 106	Cummins 6CT (8.3)				S 6550 A
2nd passage / 2.passaggio	Cummins 6CT (8.3)			S 5400 NR	
S 106	Cummins E320		S 3409 R	S 4510 NR	S 6550 A
S 106	Cummins LT10-250		S 3409 R	S 4510 NR	S 6550 A
S 106	Cummins LTA10-250		S 3409 R	S 4510 NR	S 6550 A
S 106	Cummins LTA10-275		S 3409 R	S 4510 NR	S 6550 A
S 106	Cummins LTAA10-325		S 3409 R	S 4510 NR	S 6550 A
S 106	Cummins NTAA410			S 4510 NR	
S 106	Cummins NTE320		S 3409 R	S 4510 NR	S 7945 A
S 106	Cummins NTE365		S 3409 R	S 4510 NR	S 7945 A
S 106	with two-stage filter / con filtro a doppio stadio	Perkins 300TX, 325TX			S 7945 A
S 106	with two-stage filter / con filtro a doppio stadio	Perkins 350TX, 375TX			S 7945 A
S 106	with two-stage filter / con filtro a doppio stadio	Rolls Royce 265LE			S 6550 A
S 106	with two-stage filter / con filtro a doppio stadio	Rolls Royce 300LE/325LE/350LE			S 7945 A
S 108	Caterpillar 3306, 3306ATAAC	01/88 >	S 0900 R	S 0810 NR	S 6550 A
some / alcuni	Caterpillar 3306, 3306ATAAC	01/88 >	S 0900 R	S 0810 NR	S 7945 A
S 108	Caterpillar 3306B, 3306BATAAC		S 0900 R	S 0810 NR	S 6550 A
some / alcuni	Caterpillar 3306B, 3306BATAAC		S 0900 R	S 0810 NR	S 7945 A
S 108	Caterpillar 3406B, 3406BATAAC				S 6550 A
S 108	Cummins 6CT (8.3)				S 6550 A
2nd passage / 2.passaggio	Cummins 6CT (8.3)			S 5400 NR	
S 108	Cummins E320		S 3409 R	S 4510 NR	S 6550 A
S 108	Cummins LT10-250		S 3409 R	S 4510 NR	S 6550 A
S 108	Cummins LTA10-250		S 3409 R	S 4510 NR	S 6550 A
S 108	Cummins LTA10-275		S 3409 R	S 4510 NR	S 6550 A
S 108	Cummins LTAA10-325		S 3409 R	S 4510 NR	S 6550 A
S 108	Cummins NTAA410			S 4510 NR	
S 108	Cummins NTE320		S 3409 R	S 4510 NR	S 7945 A
S 108	Cummins NTE365		S 3409 R	S 4510 NR	S 7945 A
S 108	with two-stage filter / con filtro a doppio stadio	Perkins 300TX, 325TX			S 7945 A
S 108	with two-stage filter / con filtro a doppio stadio	Perkins 350TX, 375TX			S 7945 A
S 108	with two-stage filter / con filtro a doppio stadio	Rolls Royce 265LE			S 6550 A
S 108	with two-stage filter / con filtro a doppio stadio	Rolls Royce 300LE/325LE/350LE			S 7945 A
Artics/Rigids Serie					
04A031A3309	Cummins NHC 220				S 0150 A
04A031C2208	Cummins NHC 220				S 0150 A
04A031C2208	Cummins NHC250, NHK250				S 0150 A
04A031C2208	Cummins NTC290, NTK335				S 0150 A
04A032C2508	Cummins NHC 220				S 0150 A
04A032C2508	Cummins NHC250, NHK250				S 0150 A



KW HP



...FODEN - trucks/autocarri

04A032C2508	Cummins NTC290, NTK335				S 0150 A	
04A032G2508	Gardner 8LXB				S 0150 A	
04A032R808	Rolls Royce Eagle 220, 280			S 7111 NC	S 0150 A	
04A045C2508	Cummins NHC 220				S 0150 A	
04A045C2508	Cummins NHC250, NHK250				S 0150 A	
04A045C2508	Cummins NTC290, NTK335				S 0150 A	
04A32R2208	Rolls Royce Eagle 220, 280			S 7111 NC	S 0150 A	
06A075C2708	Cummins NHC 220				S 0150 A	
06A075C2708	Cummins NHC250, NHK250				S 0150 A	
06A075C2708	Cummins NTC290, NTK335				S 0150 A	
06A100C3308	Cummins NHC 220				S 0150 A	
06A100C3308	Cummins NHC250, NHK250				S 0150 A	
06A100C3308	Cummins NTC290, NTK335				S 0150 A	
06R024G1503	Gardner 6LX, 6LXB				S 0150 A	
06R024G1803	Gardner 6LX, 6LXB				S 0150 A	
08R030C2208	Cummins NHK 220				S 0150 A	
08R030G1808	Gardner 6LX, 6LXB				S 0150 A	
08R030R2208	Rolls Royce Eagle 220 MKII			S 7111 NC	S 0150 A	
4AXB8/32	Gardner 8LXB240				S 6550 A	
6X6/24	Gardner 6LX, 6LXB				S 7011 A	
some / alcuni	Gardner 6LX, 6LXB				S 7023 A	
6XB6/24	Gardner 6LX, 6LXB				S 7011 A	
some / alcuni	Gardner 6LX, 6LXB				S 7023 A	
8XB6/26	Gardner 6LX, 6LXB				S 7011 A	
some / alcuni	Gardner 6LX, 6LXB				S 7023 A	
8XB6/28	Gardner 6LX, 6LXB				S 7011 A	
some / alcuni	Gardner 6LX, 6LXB				S 7023 A	
8XB6/30	Gardner 6LX, 6LXB				S 7011 A	
some / alcuni	Gardner 6LX, 6LXB				S 7023 A	
8XB6/30FT	Gardner 6LXB180				S 0150 A	
some / alcuni	Gardner 6LXB180				S 0940 A	
8XB6/30FT	Leyland 680T			S 7111 NC	S 0060 A	
DAXB8/38	Gardner 8LXB240				S 6550 A	
Fleetmaster Serie						
AC 20/33	Gardner 6LXC 201				S 0150 A	
AC 24/38	Cummins Turbo 240		S 3409 R	S 4510 NR	S 7011 A	
some / alcuni	Cummins Turbo 240		S 3409 R	S 4510 NR	S 0150 A	
some / alcuni	Cummins Turbo 240		S 3409 R	S 4510 NR	S 9990 A	
AC 29/38	Cummins NTE 290		S 3409 R	S 4510 NR	S 7011 A	
some / alcuni	Cummins NTE 290		S 3409 R	S 4510 NR	S 9990 A	
some / alcuni	Cummins NTE 290		S 3409 R	S 4510 NR	S 0150 A	
AC 29/40	Cummins NTE 290		S 3409 R	S 4510 NR	S 7011 A	
some / alcuni	Cummins NTE 290		S 3409 R	S 4510 NR	S 0150 A	
some / alcuni	Cummins NTE 290		S 3409 R	S 4510 NR	S 9990 A	
AR 27/38	Rolls Royce 265 Eagle MKII				S 0150 A	
AR 27/38	Rolls Royce 290 Eagle MKII				S 0150 A	
AR 29/38	Rolls Royce 265 Eagle MKII				S 0150 A	
AR 29/38	Rolls Royce 290 Eagle MKII				S 0150 A	
AR 29/40	Rolls Royce 265 Eagle MKII				S 0150 A	
AR 29/40	Rolls Royce 290 Eagle MKII				S 0150 A	
Haulmaster Serie						
RC 21/25	Cummins VT 504			S 4510 NR	S 6550 A	
RC 24/30	Cummins NTE 290		S 3409 R	S 4510 NR	S 9990 A	
some / alcuni	Cummins NTE 290		S 3409 R	S 4510 NR	S 0150 A	
some / alcuni	Cummins NTE 290		S 3409 R	S 4510 NR	S 7011 A	
RC 24/30	Cummins Turbo 240		S 3409 R	S 4510 NR	S 9990 A	
some / alcuni	Cummins Turbo 240		S 3409 R	S 4510 NR	S 0150 A	
some / alcuni	Cummins Turbo 240		S 3409 R	S 4510 NR	S 7011 A	
RG 20/25	Gardner 6LXC 201				S 0150 A	
RG 20/27	Gardner 6LXC 201				S 0150 A	
RG 20/30	Gardner 6LXC 201				S 0150 A	
RR 27/30	Rolls Royce Eagle 265 MKII	01/77 >			S 0150 A	
RR 27/30	Rolls Royce Eagle 290 MKII	01/77 >			S 0150 A	
RR 29/30	Rolls Royce Eagle 265 MKII	01/77 >			S 0150 A	
RR 29/30	Rolls Royce Eagle 290 MKII	01/77 >			S 0150 A	
Super Haulmaster Serie						
AC 29/45	Cummins NTC 290 E		S 3409 R	S 4510 NR		

F





kW HP



...FODEN - trucks/autocarri

F

AC 29/65	Cummins NTC 290 E		S 3409 R	S 4510 NR		
RC 29/26	Cummins NTC 290 E		S 3409 R	S 4510 NR		
RC 29/38	Cummins NTC 290 E		S 3409 R	S 4510 NR		
Universal Serie						
A 108/1	Cummins LT10-250		S 3409 R	S 4510 NR		
AC 25/38	Cummins NHC 250, NTC 290			S 4510 NR	S 0150 A	
inner / interno	Cummins NHC 250, NTC 290				S 8940 A	
AC 29/38	Cummins NHC 250, NTC 290			S 4510 NR	S 0150 A	
inner / interno	Cummins NHC 250, NTC 290				S 8940 A	
AR 28/38	Rolls Royce Eagle 280				S 0150 A	
inner / interno	Rolls Royce Eagle 280				S 8940 A	
HH 10	Cummins NT 310, NT 380			S 4510 NR	S 9990 A	

FORD

trucks/autocarri

A Serie

2.0 V4		04/73 >	S 1270 R		S 2460 A	
2.4 Diesel						
spin-on / avvitabile		04/73 >	S 6380 PO	S 8501 NR	S 2460 A	
with in-line pump / con pompa in linea		04/73 >	S 6380 PO	S 7112 NC	S 2460 A	
with rotary pump BOSCH / con pompa rotativa BOSCH		04/73 >	S 6380 PO	S 7111 NC	S 2460 A	
3.0 V6		04/73 >	S 1270 R			
3.5 Diesel						
spin-on / avvitabile		04/73 >	S 4380 PO	S 8501 NR		
with in-line pump / con pompa in linea		04/73 >	S 4380 PO	S 7112 NC		
with rotary pump BOSCH / con pompa rotativa BOSCH		04/73 >	S 4380 PO	S 7111 NC		

Cargo

1117	filter without drain / filtro senza spurgo	Cummins V8-504	11/80 >		S 4510 NR	S 0150 A
1217	filter without drain / filtro senza spurgo	Cummins V8-504	11/80 >		S 4510 NR	S 0150 A
1218	some / alcuni	Cummins 6BTA 5.9				S 0150 A
some / alcuni	Cummins 6BTA 5.9					S 6550 A
some / alcuni	Cummins 6BTA 5.9					S 2570 A
1317	filter without drain / filtro senza spurgo	Cummins V8-504	11/80 >		S 4510 NR	S 0150 A
1318	some / alcuni	Cummins 6BTA 5.9				S 0150 A
some / alcuni	Cummins 6BTA 5.9					S 6550 A
some / alcuni	Cummins 6BTA 5.9					S 2570 A
1417	filter without drain / filtro senza spurgo	Cummins V8-504	11/80 >		S 4510 NR	S 0150 A
1418	some / alcuni	Cummins 6BTA 5.9				S 0150 A
some / alcuni	Cummins 6BTA 5.9					S 2570 A
some / alcuni	Cummins 6BTA 5.9					S 6550 A
1517	filter without drain / filtro senza spurgo	Cummins V8-504	11/80 >		S 4510 NR	S 0150 A
1617	filter without drain / filtro senza spurgo	Cummins V8-504	11/80 >		S 4510 NR	S 0150 A
1624	some / alcuni	Cummins LT10-250		S 3409 R	S 4510 NR	S 0150 A
some / alcuni	Cummins LT10-250			S 3409 R	S 4510 NR	S 2570 A
1628	some / alcuni	Cummins LTA10-290		S 3409 R	S 4510 NR	S 6550 A
1717	filter without drain / filtro senza spurgo	Cummins V8-504	11/80 >		S 4510 NR	S 0150 A
1718	some / alcuni	Cummins 6BTA 5.9				S 0150 A
some / alcuni	Cummins 6BTA 5.9					S 6550 A
some / alcuni	Cummins 6BTA 5.9					S 2570 A
1721	some / alcuni	Cummins 6CTA 8.3				S 0150 A
some / alcuni	Cummins 6CTA 8.3					S 2570 A
1724	some / alcuni	Cummins LT10-250		S 3409 R	S 4510 NR	S 0150 A
some / alcuni	Cummins LT10-250			S 3409 R	S 4510 NR	S 2570 A
1728	some / alcuni	Cummins LTA10-290		S 3409 R	S 4510 NR	S 6550 A
2417	filter without drain / filtro senza spurgo	Cummins V8-504	11/80 >		S 4510 NR	S 0150 A
2421	some / alcuni	Cummins 6CTA 8.3				S 0150 A
some / alcuni	Cummins 6CTA 8.3					S 2570 A
2424	some / alcuni	Cummins LT10-250		S 3409 R	S 4510 NR	S 0150 A
some / alcuni	Cummins LT10-250			S 3409 R	S 4510 NR	S 2570 A
2517						



kW HP



...FORD - trucks/autocarri

filter without drain / filtro senza spurgo	Cummins V8-504	11/80 >		S 4510 NR	S 0150 A	
2817						
filter without drain / filtro senza spurgo	Cummins V8-504	11/80 >		S 4510 NR	S 0150 A	
2824	Cummins LT10-250		S 3409 R	S 4510 NR	S 0150 A	
some / alcuni	Cummins LT10-250		S 3409 R	S 4510 NR	S 2570 A	
3224	Cummins LT10-250		S 3409 R	S 4510 NR	S 0150 A	
some / alcuni	Cummins LT10-250		S 3409 R	S 4510 NR	S 2570 A	
3424	Cummins LT10-250		S 3409 R	S 4510 NR	S 0150 A	
some / alcuni	Cummins LT10-250		S 3409 R	S 4510 NR	S 2570 A	
3824	Cummins LT10-250		S 3409 R	S 4510 NR	S 0150 A	
some / alcuni	Cummins LT10-250		S 3409 R	S 4510 NR	S 2570 A	
3828	Cummins LTA10-290		S 3409 R	S 4510 NR	S 6550 A	
Cargo						
with two-stage filter DONALDSON 12" / con filtro a doppio stadio DONALDSON 12"	4.255, 6.360, 6.363, 6.380	11/80 > 10/81		S 7112 NC	S 0150 A	
with two-stage filter DONALDSON 12" / con filtro a doppio stadio DONALDSON 12"	4.255, 6.360, 6.363, 6.380	11/81 >		S 7112 NC	S 0150 A	
with flat air filter / con filtro aria a sogliola	4.255, 6.360, 6.363, 6.380	11/80 > 10/81		S 7112 NC		
with flat air filter / con filtro aria a sogliola	4.255, 6.360, 6.363, 6.380	11/81 >		S 7112 NC		
Cargo						
with two-stage filter 12" / con filtro a doppio stadio 12"	KHD F6L413	11/80 >	S 8600 R	S 6710 NR	S 0150 A	
with two-stage filter DONALDSON 12" / con filtro a doppio stadio DONALDSON 12"	KHD F6L413	11/80 >	S 8600 R	S 6710 NR	S 2570 A	
Cargo						
with two-stage filter 12" / con filtro a doppio stadio 12"	Perkins V8.540	11/80 >	S 0420 R		S 0150 A	
Cargo						
with two-stage filter 12" / con filtro a doppio stadio 12"	Perkins V8.640	11/80 >	S 0420 R	S 5400 NR	S 0150 A	
D Serie						
D Serie	4.240, 4.255	02/65 > 07/79	S 6380 PO	S 7112 NC		
	4.240, 4.255	08/79 > 11/80		S 7112 NC		
D Serie						
with two-stage filter DONALDSON 12" / con filtro a doppio stadio DONALDSON 12"	4.255, 6.360, 6.363, 6.380	02/65 > 11/80		S 7112 NC	S 2570 A	
D Serie	6.330, 6.360	02/65 > 11/69	S 4380 PO	S 7112 NC		
D Serie	6.363	08/79 > 11/80		S 7112 NC		
D Serie	6.363, 6.380	11/69 > 07/79	S 4380 PO	S 7112 NC		
D Serie	Ford 240 cu.in., 300 cu.in.	02/65 > 06/66	S 5600 R			
	Ford 240 cu.in., 300 cu.in.	07/96 > 11/80	S 5600 R		S 8950 A	
D Serie						
spin-on / avvitabile	V8.470	01/67 > 11/80		S 0810 NR		
D Serie	V8.511, V8.540	09/68 > 07/75	S 4380 PO			
	V8.511, V8.540	08/75 > 11/80	S 0420 R			
D Serie Turbo		07/68 > 07/79	S 4380 PO			
N Serie						
N Serie	4.255	09/73 > 07/79	S 6380 PO	S 7112 NC		
	4.255	08/79 > 11/80		S 7112 NC		
N Serie	6.363, 6.380	09/73 > 07/79	S 4380 PO	S 7112 NC		
	6.363, 6.380	08/79 > 11/80		S 7112 NC		
N Serie Turbo		09/73 > 07/79	S 4380 PO	S 7112 NC		
		09/73 > 11/80		S 7112 NC		
Trader FC						
Trader FC	Ford 200, 220	03/57 > 01/65	S 7380 PO			
Trader FC	Ford 300, 330	03/57 > 01/65	S 6380 PO			
Trader FC Diesel		03/57 > 01/65		S 6481 N		
Trader NC						
Trader NC	240 cu.in., 255 cu.in., 300 cu.in., 330 cu.in.	03/62 > 03/73	S 6380 PO			
Trader NC	330 cu.in., 360 cu.in., 363 cu.in., 380 cu.in.	03/62 > 03/73	S 4380 PO			
Trader NC	Ford 200, 220	03/62 > 12/67	S 7380 PO			
Trader NC (Serie K/M)	240 cu.in., 255 cu.in., 300 cu.in., 330 cu.in.	03/62 > 03/73	S 6380 PO			
Trader NC (Serie K/M)	330 cu.in., 360 cu.in., 363 cu.in., 380 cu.in.	03/62 > 03/73	S 4380 PO			
Trader NC (Serie K/M)	Ford 200, 220	03/62 > 12/67	S 7380 PO			
Trader NC Diesel		03/62 > 02/65		S 6481 N		
		03/65 > 03/73		S 7112 NC		
Trader NC Diesel (Serie K/M)		03/62 > 02/65		S 6481 N		
		03/65 > 03/73		S 7112 NC		
Transcontinental						
3424	Cummins NH-250, NTC290, NTC335	09/78 >	S 3409 R	S 4510 NR	S 7004 A	
3427	Cummins NH-250, NTC290, NTC335	09/78 >	S 3409 R	S 4510 NR	S 7004 A	
4227	Cummins NH-250, NTC290, NTC335	09/78 >	S 3409 R	S 4510 NR	S 7004 A	
4231	Cummins NH-250, NTC290, NTC335	09/78 >	S 3409 R	S 4510 NR	S 7004 A	
4234	Cummins NH-250, NTC290, NTC335	09/78 >	S 3409 R	S 4510 NR	S 7004 A	

F





kW HP



...FORD - trucks/autocarri

H3424	Cummins Super 252	09/78 >	S 3409 R	S 4510 NR	S 7004 A	
HA3424	Cummins Super 252	09/78 >	S 3409 R	S 4510 NR	S 7004 A	
Turbo		10/78 >			S 7004 A	

FORD

buses/autobus

Harrington Coach MK III

Harrington Coach MK III	3.6l. Diesel	01/57 >	S 7380 PO	S 6481 N		
-------------------------	--------------	---------	-----------	----------	--	--

R Serie

R 130	Dover			S 7112 NC		
R 150	Dover			S 7112 NC		
R Serie	330 cu.in., 360 cu.in.	06/65 > 11/69	S 4380 PO			
R Serie	363 cu.in., 365 cu.in., 380 cu.in.	11/69 > 07/79	S 4380 PO			
R Serie	4.9 l. 300 cu.in.	06/65 > 12/71	S 5600 R			
R Serie Diesel		06/65 >		S 7112 NC		
R Serie Turbo	360 cu.in., 365 cu.in.	07/68 > 07/79	S 4380 PO			

FORD OTOSAN

trucks/autocarri

Cargo

1842 T	12.7 EcoTorq Euro6	309 420	01/16 >		S 4348 NR		
2 filters / N.2 filtri	12.7 EcoTorq Euro6	309 420	01/16 >	S 3572 R			
1848 T	12.7 EcoTorq Euro6	353 480	01/16 >		S 4348 NR		
2 filters / N.2 filtri	12.7 EcoTorq Euro6	353 480	01/16 >	S 3572 R			
1848 T Low Liner	12.7 EcoTorq Euro6	353 480	01/16 >		S 4348 NR		
2 filters / N.2 filtri	12.7 EcoTorq Euro6	353 480	01/16 >	S 3572 R			
2542 HR	12.7 EcoTorq Euro6	309 420	01/16 >		S 4348 NR		
2 filters / N.2 filtri	12.7 EcoTorq Euro6	309 420	01/16 >	S 3572 R			
3242 S HR	12.7 EcoTorq Euro6	309 420	01/16 >		S 4348 NR		
2 filters / N.2 filtri	12.7 EcoTorq Euro6	309 420	01/16 >	S 3572 R			
3542 D	12.7 EcoTorq Euro6	309 420	01/16 >		S 4348 NR		
2 filters / N.2 filtri	12.7 EcoTorq Euro6	309 420	01/16 >	S 3572 R			
3542 M	12.7 EcoTorq Euro6	309 420	01/16 >		S 4348 NR		
2 filters / N.2 filtri	12.7 EcoTorq Euro6	309 420	01/16 >	S 3572 R			
3542 P	12.7 EcoTorq Euro6	309 420	01/16 >		S 4348 NR		
2 filters / N.2 filtri	12.7 EcoTorq Euro6	309 420	01/16 >	S 3572 R			
4142 D	12.7 EcoTorq Euro6	309 420	01/16 >		S 4348 NR		
2 filters / N.2 filtri	12.7 EcoTorq Euro6	309 420	01/16 >	S 3572 R			
4142 M	12.7 EcoTorq Euro6	309 420	01/16 >		S 4348 NR		
2 filters / N.2 filtri	12.7 EcoTorq Euro6	309 420	01/16 >	S 3572 R			
4142 P	12.7 EcoTorq Euro6	309 420	01/16 >		S 4348 NR		
2 filters / N.2 filtri	12.7 EcoTorq Euro6	309 420	01/16 >	S 3572 R			
4142 P-6000	12.7 EcoTorq Euro6	309 420	01/16 >		S 4348 NR		
2 filters / N.2 filtri	12.7 EcoTorq Euro6	309 420	01/16 >	S 3572 R			

FREIGHTLINER

trucks/autocarri

Columbia

112	Detroit Diesel MBE4000	01/04 >	S 5062 PE	S 6001 NE		
-----	------------------------	---------	-----------	-----------	--	--

CST Serie

CST120	Detroit Diesel MBE4000	01/04 >	S 5062 PE	S 6001 NE		
--------	------------------------	---------	-----------	-----------	--	--

FLN Serie

FLN112	Detroit Diesel MBE4000	01/03 >	S 5062 PE	S 6001 NE		
--------	------------------------	---------	-----------	-----------	--	--

GINAF

special trucks/autocarri speciali

C Series

C2120N.210	Iveco F4AE0681D Tector6	154 210	09/03 >	S 0620 R	S 2220 NR		✗
with filter MANN+HUMMEL / con filtro MANN+HUMMEL	Iveco F4AE0681D Tector6	154 210	09/03 >			S 7625 A	
dryer filter / filtro essiccatore	Iveco F4AE0681D Tector6	154 210	09/03 >				S 7259 A
prefilter / prefiltro	Iveco F4AE0681D Tector6	154 210	09/03 >		S 0999 NR		
C2120N.240	Iveco F4AE0681B Tector6	176 239	09/03 >	S 0620 R	S 2220 NR		✗
with filter MANN+HUMMEL / con filtro MANN+HUMMEL	Iveco F4AE0681B Tector6	176 239	09/03 >			S 7626 A	
dryer filter / filtro essiccatore	Iveco F4AE0681B Tector6	176 239	09/03 >				S 7259 A
prefilter / prefiltro	Iveco F4AE0681B Tector6	176 239	09/03 >		S 0999 NR		
C2120N.275	Iveco F4AE0681A Tector6	202 275	09/03 >	S 0620 R	S 2220 NR		✗
with filter BLOW-BY / con filtro BLOW-BY	Iveco F4AE0681A Tector6	202 275	09/03 > 12/06				S 7B11 A
with filter MANN+HUMMEL / con filtro MANN+HUMMEL	Iveco F4AE0681A Tector6	202 275	09/03 >			S 7626 A	
dryer filter / filtro essiccatore	Iveco F4AE0681A Tector6	202 275	09/03 >				S 7259 A
prefilter / prefiltro	Iveco F4AE0681A Tector6	202 275	09/03 >		S 0999 NR		
C2121N.210	Iveco F4AE0681D Tector6	154 210	09/03 >	S 0620 R	S 2220 NR		✗

**KW HP****...GINAF - special trucks/autocarri speciali**

C3129N.275	Iveco F4AE0681A Tector6	202	275	09/03	>	S 0620 R	S 2220 NR		✗
with filter BLOW-BY / con filtro BLOW-BY	Iveco F4AE0681A Tector6	202	275	09/03	> 12/06			S 7B11 A	
with filter MANN+HUMMEL / con filtro MANN+HUMMEL	Iveco F4AE0681A Tector6	202	275	09/03	>			S 7626 A	
dryer filter / filtro essiccatore	Iveco F4AE0681A Tector6	202	275	09/03	>				S 7259 A
prefilter / prefiltro	Iveco F4AE0681A Tector6	202	275	09/03	>		S 0999 NR		
C3130N.240	Iveco F4AE0681B Tector6	176	239	09/03	>	S 0620 R	S 2220 NR		✗
with filter BLOW-BY / con filtro BLOW-BY	Iveco F4AE0681B Tector6	176	239	09/03	> 12/06			S 7B11 A	
with filter MANN+HUMMEL / con filtro MANN+HUMMEL	Iveco F4AE0681B Tector6	176	239	09/03	>			S 7626 A	
dryer filter / filtro essiccatore	Iveco F4AE0681B Tector6	176	239	09/03	>				S 7259 A
prefilter / prefiltro	Iveco F4AE0681B Tector6	176	239	09/03	>		S 0999 NR		
C3130N.275	Iveco F4AE0681A Tector6	202	275	09/03	>	S 0620 R	S 2220 NR		✗
with filter BLOW-BY / con filtro BLOW-BY	Iveco F4AE0681A Tector6	202	275	09/03	> 12/06			S 7B11 A	
with filter MANN+HUMMEL / con filtro MANN+HUMMEL	Iveco F4AE0681A Tector6	202	275	09/03	>			S 7626 A	
dryer filter / filtro essiccatore	Iveco F4AE0681A Tector6	202	275	09/03	>				S 7259 A
prefilter / prefiltro	Iveco F4AE0681A Tector6	202	275	09/03	>		S 0999 NR		
X Series									
X2219L.250	DAF PE183C	183	249	10/99	>	S 5045 PE	S 6009 NE		S 3139 C
with activated carbons / ai carboni attivi	DAF PE183C	183	249	10/99	>				S 4347 CA
with gearbox ZF Ecosplit + Intarder / con cambio ZF Ecosplit + Intarder	DAF PE183C	183	249	10/99	>				S 2234 Z
with filter DONALDSON / con filtro DONALDSON	DAF PE183C	183	249	10/99	>			S 7371 A	
with filter MANN+HUMMEL / con filtro MANN+HUMMEL	DAF PE183C	183	249	10/99	>			S 7A16 A	
dryer filter / filtro essiccatore	DAF PE183C	183	249	10/99	>				S 7393 A
LONG LIFE	DAF PE183C	183	249	10/99	>	S 5234 PE	S 6146 NE		
DONALDSON assembly flame retardant media / montaggio DONALDSON media filtrante ritardante di fiamma	DAF PE183C	183	249	10/99	>			S 7A59 A	
prefilter MANN+HUMMEL PreLine / prefiltro MANN+HUMMEL PreLine	DAF PE183C	183	249	10/99	>		S 4142 NR		
prefilter RACOR-PARKER / prefiltro RACOR-PARKER	DAF PE183C	183	249	10/99	>		S 4143 NR		
rotor for oil centrifuge / rotore per filtro olio centrifugo	DAF PE183C	183	249	10/99	>	S 5902 PO			
power steering / servosterzo	DAF PE183C	183	249	10/99	>				S 3081 PO
X2219L.310	DAF PE228C	228	310	10/99	>	S 5045 PE	S 6009 NE		S 3139 C
with activated carbons / ai carboni attivi	DAF PE228C	228	310	10/99	>				S 4347 CA
with gearbox ZF Ecosplit + Intarder / con cambio ZF Ecosplit + Intarder	DAF PE228C	228	310	10/99	>				S 2234 Z
with filter DONALDSON / con filtro DONALDSON	DAF PE228C	228	310	10/99	>			S 7371 A	
with filter MANN+HUMMEL / con filtro MANN+HUMMEL	DAF PE228C	228	310	10/99	>			S 7A16 A	
dryer filter / filtro essiccatore	DAF PE228C	228	310	10/99	>				S 7393 A
LONG LIFE	DAF PE228C	228	310	10/99	>	S 5234 PE	S 6146 NE		
DONALDSON assembly flame retardant media / montaggio DONALDSON media filtrante ritardante di fiamma	DAF PE228C	228	310	10/99	>			S 7A59 A	
prefilter MANN+HUMMEL PreLine / prefiltro MANN+HUMMEL PreLine	DAF PE228C	228	310	10/99	>		S 4142 NR		
prefilter RACOR-PARKER / prefiltro RACOR-PARKER	DAF PE228C	228	310	10/99	>		S 4143 NR		
rotor for oil centrifuge / rotore per filtro olio centrifugo	DAF PE228C	228	310	10/99	>	S 5902 PO			
power steering / servosterzo	DAF PE228C	228	310	10/99	>				S 3081 PO
X2219L.340	DAF XE250C	250	340	10/99	>	S 5045 PE	S 6009 NE		S 3139 C
some prefilter / alcuni prefiltro	DAF XE250C	250	340	05/02	>		S 4142 NR		
with gearbox ZF Ecosplit + Intarder / con cambio ZF Ecosplit + Intarder	DAF XE250C	250	340	10/99	>				S 2234 Z
dryer filter / filtro essiccatore	DAF XE250C	250	340	10/99	>				S 7393 A
LONG LIFE	DAF XE250C	250	340	10/99	>	S 5234 PE	S 6146 NE		
prefilter / prefiltro	DAF XE250C	250	340	10/99	>		S 4143 NR		
rotor for oil centrifuge / rotore per filtro olio centrifugo	DAF XE250C	250	340	10/99	>	S 5902 PO			
power steering / servosterzo	DAF XE250C	250	340	10/99	>				S 3081 PO
X2219L.360	DAF PE265C	265	360	10/99	>	S 5045 PE	S 6009 NE		S 3139 C
with activated carbons / ai carboni attivi	DAF PE265C	265	360	10/99	>				S 4347 CA
with gearbox ZF Ecosplit + Intarder / con cambio ZF Ecosplit + Intarder	DAF PE265C	265	360	10/99	>				S 2234 Z
with filter DONALDSON / con filtro DONALDSON	DAF PE265C	265	360	10/99	>			S 7371 A	
with filter MANN+HUMMEL / con filtro MANN+HUMMEL	DAF PE265C	265	360	10/99	>			S 7A16 A	
dryer filter / filtro essiccatore	DAF PE265C	265	360	10/99	>				S 7393 A
LONG LIFE	DAF PE265C	265	360	10/99	>	S 5234 PE	S 6146 NE		
DONALDSON assembly flame retardant media / montaggio DONALDSON media filtrante ritardante di fiamma	DAF PE265C	265	360	10/99	>			S 7A59 A	
prefilter MANN+HUMMEL PreLine / prefiltro MANN+HUMMEL PreLine	DAF PE265C	265	360	10/99	>		S 4142 NR		
prefilter RACOR-PARKER / prefiltro RACOR-PARKER	DAF PE265C	265	360	10/99	>		S 4143 NR		
rotor for oil centrifuge / rotore per filtro olio centrifugo	DAF PE265C	265	360	10/99	>	S 5902 PO			
power steering / servosterzo	DAF PE265C	265	360	10/99	>				S 3081 PO
X2219L.380	DAF XE280C	280	381	10/99	>	S 5045 PE	S 6009 NE		S 3139 C
some prefilter / alcuni prefiltro	DAF XE280C	280	381	05/02	>		S 4142 NR		
with gearbox ZF Ecosplit + Intarder / con cambio ZF Ecosplit + Intarder	DAF XE280C	280	381	10/99	>				S 2234 Z
dryer filter / filtro essiccatore	DAF XE280C	280	381	10/99	>				S 7393 A
LONG LIFE	DAF XE280C	280	381	10/99	>	S 5234 PE	S 6146 NE		
prefilter / prefiltro	DAF XE280C	280	381	10/99	>		S 4143 NR		
rotor for oil centrifuge / rotore per filtro olio centrifugo	DAF XE280C	280	381	10/99	>	S 5902 PO			

**KW HP****...GINAF - special trucks/autocarri speciali**

power steering / servosterzo	DAF XE280C	280	381	10/99	>				S 3081 PO
X2219L.430	DAF XE315C	315	428	10/99	>	S 5045 PE	S 6009 NE		S 3139 C
some prefilter / alcuni prefiltri	DAF XE315C	315	428	05/02	>		S 4142 NR		
with gearbox ZF Ecosplit + Intarder / con cambio ZF Ecosplit + Intarder	DAF XE315C	315	428	10/99	>				S 2234 Z
dryer filter / filtro essiccatore	DAF XE315C	315	428	10/99	>				S 7393 A
LONG LIFE	DAF XE315C	315	428	10/99	>	S 5234 PE	S 6146 NE		
prefilter / prefiltri	DAF XE315C	315	428	10/99	>		S 4143 NR		
rotor for oil centrifuge / rotore per filtro olio centrifugo	DAF XE315C	315	428	10/99	>	S 5902 PO			
power steering / servosterzo	DAF XE315C	315	428	10/99	>				S 3081 PO
X2219L.480	DAF XE355C	355	483	10/99	>	S 5045 PE	S 6009 NE	S 7409 A	S 3139 C
some prefilter / alcuni prefiltri	DAF XE355C	355	483	05/02	>		S 4142 NR		
with gearbox ZF Ecosplit + Intarder / con cambio ZF Ecosplit + Intarder	DAF XE355C	355	483	10/99	>				S 2234 Z
dryer filter / filtro essiccatore	DAF XE355C	355	483	10/99	>				S 7393 A
LONG LIFE	DAF XE355C	355	483	10/99	>	S 5234 PE	S 6146 NE		
prefilter / prefiltri	DAF XE355C	355	483	10/99	>		S 4143 NR		
rotor for oil centrifuge / rotore per filtro olio centrifugo	DAF XE355C	355	483	10/99	>	S 5902 PO			
power steering / servosterzo	DAF XE355C	355	483	10/99	>				S 3081 PO
X2220L.250	DAF PE183C	183	249	10/99	>	S 5045 PE	S 6009 NE		S 3139 C
with activated carbons / ai carboni attivi	DAF PE183C	183	249	10/99	>				S 4347 CA
with gearbox ZF Ecosplit + Intarder / con cambio ZF Ecosplit + Intarder	DAF PE183C	183	249	10/99	>				S 2234 Z
with filter DONALDSON / con filtro DONALDSON	DAF PE183C	183	249	10/99	>			S 7371 A	
with filter MANN+HUMMEL / con filtro MANN+HUMMEL	DAF PE183C	183	249	10/99	>			S 7A16 A	
dryer filter / filtro essiccatore	DAF PE183C	183	249	10/99	>				S 7393 A
LONG LIFE	DAF PE183C	183	249	10/99	>	S 5234 PE	S 6146 NE		
DONALDSON assembly flame retardant media / montaggio DONALDSON media filtrante ritardante di fiamma	DAF PE183C	183	249	10/99	>			S 7A59 A	
prefilter MANN+HUMMEL PreLine / prefiltri MANN+HUMMEL PreLine	DAF PE183C	183	249	10/99	>		S 4142 NR		
prefilter RACOR-PARKER / prefiltri RACOR-PARKER	DAF PE183C	183	249	10/99	>		S 4143 NR		
rotor for oil centrifuge / rotore per filtro olio centrifugo	DAF PE183C	183	249	10/99	>	S 5902 PO			
power steering / servosterzo	DAF PE183C	183	249	10/99	>				S 3081 PO
X2220L.310	DAF PE228C	228	310	10/99	>	S 5045 PE	S 6009 NE		S 3139 C
with activated carbons / ai carboni attivi	DAF PE228C	228	310	10/99	>				S 4347 CA
with gearbox ZF Ecosplit + Intarder / con cambio ZF Ecosplit + Intarder	DAF PE228C	228	310	10/99	>				S 2234 Z
with filter DONALDSON / con filtro DONALDSON	DAF PE228C	228	310	10/99	>			S 7371 A	
with filter MANN+HUMMEL / con filtro MANN+HUMMEL	DAF PE228C	228	310	10/99	>			S 7A16 A	
dryer filter / filtro essiccatore	DAF PE228C	228	310	10/99	>				S 7393 A
LONG LIFE	DAF PE228C	228	310	10/99	>	S 5234 PE	S 6146 NE		
DONALDSON assembly flame retardant media / montaggio DONALDSON media filtrante ritardante di fiamma	DAF PE228C	228	310	10/99	>			S 7A59 A	
prefilter MANN+HUMMEL PreLine / prefiltri MANN+HUMMEL PreLine	DAF PE228C	228	310	10/99	>		S 4142 NR		
prefilter RACOR-PARKER / prefiltri RACOR-PARKER	DAF PE228C	228	310	10/99	>		S 4143 NR		
rotor for oil centrifuge / rotore per filtro olio centrifugo	DAF PE228C	228	310	10/99	>	S 5902 PO			
power steering / servosterzo	DAF PE228C	228	310	10/99	>				S 3081 PO
X2220L.340	DAF XE250C	250	340	10/99	>	S 5045 PE	S 6009 NE		S 3139 C
some prefilter / alcuni prefiltri	DAF XE250C	250	340	05/02	>		S 4142 NR		
with gearbox ZF Ecosplit + Intarder / con cambio ZF Ecosplit + Intarder	DAF XE250C	250	340	10/99	>				S 2234 Z
dryer filter / filtro essiccatore	DAF XE250C	250	340	10/99	>				S 7393 A
LONG LIFE	DAF XE250C	250	340	10/99	>	S 5234 PE	S 6146 NE		
prefilter / prefiltri	DAF XE250C	250	340	10/99	>		S 4143 NR		
rotor for oil centrifuge / rotore per filtro olio centrifugo	DAF XE250C	250	340	10/99	>	S 5902 PO			
power steering / servosterzo	DAF XE250C	250	340	10/99	>				S 3081 PO
X2220L.360	DAF PE265C	265	360	10/99	>	S 5045 PE	S 6009 NE		S 3139 C
with activated carbons / ai carboni attivi	DAF PE265C	265	360	10/99	>				S 4347 CA
with gearbox ZF Ecosplit + Intarder / con cambio ZF Ecosplit + Intarder	DAF PE265C	265	360	10/99	>				S 2234 Z
with filter DONALDSON / con filtro DONALDSON	DAF PE265C	265	360	10/99	>			S 7371 A	
with filter MANN+HUMMEL / con filtro MANN+HUMMEL	DAF PE265C	265	360	10/99	>			S 7A16 A	
dryer filter / filtro essiccatore	DAF PE265C	265	360	10/99	>				S 7393 A
LONG LIFE	DAF PE265C	265	360	10/99	>	S 5234 PE	S 6146 NE		
DONALDSON assembly flame retardant media / montaggio DONALDSON media filtrante ritardante di fiamma	DAF PE265C	265	360	10/99	>			S 7A59 A	
prefilter MANN+HUMMEL PreLine / prefiltri MANN+HUMMEL PreLine	DAF PE265C	265	360	10/99	>		S 4142 NR		
prefilter RACOR-PARKER / prefiltri RACOR-PARKER	DAF PE265C	265	360	10/99	>		S 4143 NR		
rotor for oil centrifuge / rotore per filtro olio centrifugo	DAF PE265C	265	360	10/99	>	S 5902 PO			
power steering / servosterzo	DAF PE265C	265	360	10/99	>				S 3081 PO
X2220L.430	DAF XE315C	315	428	10/99	>	S 5045 PE	S 6009 NE		S 3139 C
some prefilter / alcuni prefiltri	DAF XE315C	315	428	05/02	>		S 4142 NR		
with gearbox ZF Ecosplit + Intarder / con cambio ZF Ecosplit + Intarder	DAF XE315C	315	428	10/99	>				S 2234 Z
dryer filter / filtro essiccatore	DAF XE315C	315	428	10/99	>				S 7393 A
LONG LIFE	DAF XE315C	315	428	10/99	>	S 5234 PE	S 6146 NE		
prefilter / prefiltri	DAF XE315C	315	428	10/99	>		S 4143 NR		

G



...GINAF - special trucks/autocarri speciali

rotor for oil centrifuge / rotore per filtro olio centrifugo	DAF XE315C	315	428	10/99	>	S 5902 PO			
power steering / servosterzo	DAF XE315C	315	428	10/99	>				S 3081 PO
X2221L.250	DAF PE183C	183	249	10/99	>	S 5045 PE	S 6009 NE		S 3139 C
with activated carbons / ai carboni attivi	DAF PE183C	183	249	10/99	>				S 4347 CA
with gearbox ZF Ecosplit + Intarder / con cambio ZF Ecosplit + Intarder	DAF PE183C	183	249	10/99	>				S 2234 Z
with filter DONALDSON / con filtro DONALDSON	DAF PE183C	183	249	10/99	>			S 7371 A	
with filter MANN+HUMMEL / con filtro MANN+HUMMEL	DAF PE183C	183	249	10/99	>			S 7A16 A	
dryer filter / filtro essiccatore	DAF PE183C	183	249	10/99	>				S 7393 A
LONG LIFE	DAF PE183C	183	249	10/99	>	S 5234 PE	S 6146 NE		
DONALDSON assembly flame retardant media / montaggio DONALDSON media filtrante ritardante di fiamma	DAF PE183C	183	249	10/99	>			S 7A59 A	
prefilter MANN+HUMMEL PreLine / prefilto MANN+HUMMEL PreLine	DAF PE183C	183	249	10/99	>		S 4142 NR		
prefilter RACOR-PARKER / prefilto RACOR-PARKER	DAF PE183C	183	249	10/99	>		S 4143 NR		
rotor for oil centrifuge / rotore per filtro olio centrifugo	DAF PE183C	183	249	10/99	>	S 5902 PO			
power steering / servosterzo	DAF PE183C	183	249	10/99	>				S 3081 PO
X2221L.310	DAF PE228C	228	310	10/99	>	S 5045 PE	S 6009 NE		S 3139 C
with activated carbons / ai carboni attivi	DAF PE228C	228	310	10/99	>				S 4347 CA
with gearbox ZF Ecosplit + Intarder / con cambio ZF Ecosplit + Intarder	DAF PE228C	228	310	10/99	>				S 2234 Z
with filter DONALDSON / con filtro DONALDSON	DAF PE228C	228	310	10/99	>			S 7371 A	
with filter MANN+HUMMEL / con filtro MANN+HUMMEL	DAF PE228C	228	310	10/99	>			S 7A16 A	
dryer filter / filtro essiccatore	DAF PE228C	228	310	10/99	>				S 7393 A
LONG LIFE	DAF PE228C	228	310	10/99	>	S 5234 PE	S 6146 NE		
DONALDSON assembly flame retardant media / montaggio DONALDSON media filtrante ritardante di fiamma	DAF PE228C	228	310	10/99	>			S 7A59 A	
prefilter MANN+HUMMEL PreLine / prefilto MANN+HUMMEL PreLine	DAF PE228C	228	310	10/99	>		S 4142 NR		
prefilter RACOR-PARKER / prefilto RACOR-PARKER	DAF PE228C	228	310	10/99	>		S 4143 NR		
rotor for oil centrifuge / rotore per filtro olio centrifugo	DAF PE228C	228	310	10/99	>	S 5902 PO			
power steering / servosterzo	DAF PE228C	228	310	10/99	>				S 3081 PO
X2221L.340	DAF XE250C	250	340	10/99	>	S 5045 PE	S 6009 NE		S 3139 C
some prefilter / alcuni prefilto	DAF XE250C	250	340	05/02	>		S 4142 NR		
with gearbox ZF Ecosplit + Intarder / con cambio ZF Ecosplit + Intarder	DAF XE250C	250	340	10/99	>				S 2234 Z
dryer filter / filtro essiccatore	DAF XE250C	250	340	10/99	>				S 7393 A
LONG LIFE	DAF XE250C	250	340	10/99	>	S 5234 PE	S 6146 NE		
prefilter / prefilto	DAF XE250C	250	340	10/99	>		S 4143 NR		
rotor for oil centrifuge / rotore per filtro olio centrifugo	DAF XE250C	250	340	10/99	>	S 5902 PO			
power steering / servosterzo	DAF XE250C	250	340	10/99	>				S 3081 PO
X2221L.360	DAF PE265C	265	360	10/99	>	S 5045 PE	S 6009 NE		S 3139 C
with activated carbons / ai carboni attivi	DAF PE265C	265	360	10/99	>				S 4347 CA
with gearbox ZF Ecosplit + Intarder / con cambio ZF Ecosplit + Intarder	DAF PE265C	265	360	10/99	>				S 2234 Z
with filter DONALDSON / con filtro DONALDSON	DAF PE265C	265	360	10/99	>			S 7371 A	
with filter MANN+HUMMEL / con filtro MANN+HUMMEL	DAF PE265C	265	360	10/99	>			S 7A16 A	
dryer filter / filtro essiccatore	DAF PE265C	265	360	10/99	>				S 7393 A
LONG LIFE	DAF PE265C	265	360	10/99	>	S 5234 PE	S 6146 NE		
DONALDSON assembly flame retardant media / montaggio DONALDSON media filtrante ritardante di fiamma	DAF PE265C	265	360	10/99	>			S 7A59 A	
prefilter MANN+HUMMEL PreLine / prefilto MANN+HUMMEL PreLine	DAF PE265C	265	360	10/99	>		S 4142 NR		
prefilter RACOR-PARKER / prefilto RACOR-PARKER	DAF PE265C	265	360	10/99	>		S 4143 NR		
rotor for oil centrifuge / rotore per filtro olio centrifugo	DAF PE265C	265	360	10/99	>	S 5902 PO			
power steering / servosterzo	DAF PE265C	265	360	10/99	>				S 3081 PO
X2221L.430	DAF XE315C	315	428	10/99	>	S 5045 PE	S 6009 NE		S 3139 C
some prefilter / alcuni prefilto	DAF XE315C	315	428	05/02	>		S 4142 NR		
with gearbox ZF Ecosplit + Intarder / con cambio ZF Ecosplit + Intarder	DAF XE315C	315	428	10/99	>				S 2234 Z
dryer filter / filtro essiccatore	DAF XE315C	315	428	10/99	>				S 7393 A
LONG LIFE	DAF XE315C	315	428	10/99	>	S 5234 PE	S 6146 NE		
prefilter / prefilto	DAF XE315C	315	428	10/99	>		S 4143 NR		
rotor for oil centrifuge / rotore per filtro olio centrifugo	DAF XE315C	315	428	10/99	>	S 5902 PO			
power steering / servosterzo	DAF XE315C	315	428	10/99	>				S 3081 PO
X2222L.250	DAF PE183C	183	249	10/99	>	S 5045 PE	S 6009 NE		S 3139 C
with activated carbons / ai carboni attivi	DAF PE183C	183	249	10/99	>				S 4347 CA
with gearbox ZF Ecosplit + Intarder / con cambio ZF Ecosplit + Intarder	DAF PE183C	183	249	10/99	>				S 2234 Z
with filter DONALDSON / con filtro DONALDSON	DAF PE183C	183	249	10/99	>			S 7371 A	
with filter MANN+HUMMEL / con filtro MANN+HUMMEL	DAF PE183C	183	249	10/99	>			S 7A16 A	
dryer filter / filtro essiccatore	DAF PE183C	183	249	10/99	>				S 7393 A
LONG LIFE	DAF PE183C	183	249	10/99	>	S 5234 PE	S 6146 NE		
DONALDSON assembly flame retardant media / montaggio DONALDSON media filtrante ritardante di fiamma	DAF PE183C	183	249	10/99	>			S 7A59 A	
prefilter MANN+HUMMEL PreLine / prefilto MANN+HUMMEL PreLine	DAF PE183C	183	249	10/99	>		S 4142 NR		
prefilter RACOR-PARKER / prefilto RACOR-PARKER	DAF PE183C	183	249	10/99	>		S 4143 NR		
rotor for oil centrifuge / rotore per filtro olio centrifugo	DAF PE183C	183	249	10/99	>	S 5902 PO			
power steering / servosterzo	DAF PE183C	183	249	10/99	>				S 3081 PO
X2222L.310	DAF PE228C	228	310	10/99	>	S 5045 PE	S 6009 NE		S 3139 C

**KW HP****...GINAF - special trucks/autocarri speciali**

with activated carbons / ai carboni attivi	DAF PE228C	228	310	10/99	>				S 4347 CA
with gearbox ZF Ecosplit + Intarder / con cambio ZF Ecosplit + Intarder	DAF PE228C	228	310	10/99	>				S 2234 Z
with filter DONALDSON / con filtro DONALDSON	DAF PE228C	228	310	10/99	>			S 7371 A	
with filter MANN+HUMMEL / con filtro MANN+HUMMEL	DAF PE228C	228	310	10/99	>			S 7A16 A	
dryer filter / filtro essiccatore	DAF PE228C	228	310	10/99	>				S 7393 A
LONG LIFE	DAF PE228C	228	310	10/99	>	S 5234 PE	S 6146 NE		
DONALDSON assembly flame retardant media / montaggio DONALDSON media filtrante ritardante di fiamma	DAF PE228C	228	310	10/99	>			S 7A59 A	
prefilter MANN+HUMMEL PreLine / prefiltro MANN+HUMMEL PreLine	DAF PE228C	228	310	10/99	>		S 4142 NR		
prefilter RACOR-PARKER / prefiltro RACOR-PARKER	DAF PE228C	228	310	10/99	>		S 4143 NR		
rotor for oil centrifuge / rotore per filtro olio centrifugo	DAF PE228C	228	310	10/99	>	S 5902 PO			
power steering / servosterzo	DAF PE228C	228	310	10/99	>				S 3081 PO
X2222L.340	DAF XE250C	250	340	10/99	>	S 5045 PE	S 6009 NE		S 3139 C
some prefilter / alcuni prefiltro	DAF XE250C	250	340	05/02	>		S 4142 NR		
with gearbox ZF Ecosplit + Intarder / con cambio ZF Ecosplit + Intarder	DAF XE250C	250	340	10/99	>				S 2234 Z
dryer filter / filtro essiccatore	DAF XE250C	250	340	10/99	>				S 7393 A
LONG LIFE	DAF XE250C	250	340	10/99	>	S 5234 PE	S 6146 NE		
prefilter / prefiltro	DAF XE250C	250	340	10/99	>		S 4143 NR		
rotor for oil centrifuge / rotore per filtro olio centrifugo	DAF XE250C	250	340	10/99	>	S 5902 PO			
power steering / servosterzo	DAF XE250C	250	340	10/99	>				S 3081 PO
X2222L.360	DAF PE265C	265	360	10/99	>	S 5045 PE	S 6009 NE		S 3139 C
with activated carbons / ai carboni attivi	DAF PE265C	265	360	10/99	>				S 4347 CA
with gearbox ZF Ecosplit + Intarder / con cambio ZF Ecosplit + Intarder	DAF PE265C	265	360	10/99	>				S 2234 Z
with filter DONALDSON / con filtro DONALDSON	DAF PE265C	265	360	10/99	>			S 7371 A	
with filter MANN+HUMMEL / con filtro MANN+HUMMEL	DAF PE265C	265	360	10/99	>			S 7A16 A	
dryer filter / filtro essiccatore	DAF PE265C	265	360	10/99	>				S 7393 A
LONG LIFE	DAF PE265C	265	360	10/99	>	S 5234 PE	S 6146 NE		
DONALDSON assembly flame retardant media / montaggio DONALDSON media filtrante ritardante di fiamma	DAF PE265C	265	360	10/99	>			S 7A59 A	
prefilter MANN+HUMMEL PreLine / prefiltro MANN+HUMMEL PreLine	DAF PE265C	265	360	10/99	>		S 4142 NR		
prefilter RACOR-PARKER / prefiltro RACOR-PARKER	DAF PE265C	265	360	10/99	>		S 4143 NR		
rotor for oil centrifuge / rotore per filtro olio centrifugo	DAF PE265C	265	360	10/99	>	S 5902 PO			
power steering / servosterzo	DAF PE265C	265	360	10/99	>				S 3081 PO
X2223L.340	DAF XE250C	250	340	10/99	>	S 5045 PE	S 6009 NE		S 3139 C
some prefilter / alcuni prefiltro	DAF XE250C	250	340	05/02	>		S 4142 NR		
with gearbox ZF Ecosplit + Intarder / con cambio ZF Ecosplit + Intarder	DAF XE250C	250	340	10/99	>				S 2234 Z
dryer filter / filtro essiccatore	DAF XE250C	250	340	10/99	>				S 7393 A
LONG LIFE	DAF XE250C	250	340	10/99	>	S 5234 PE	S 6146 NE		
prefilter / prefiltro	DAF XE250C	250	340	10/99	>		S 4143 NR		
rotor for oil centrifuge / rotore per filtro olio centrifugo	DAF XE250C	250	340	10/99	>	S 5902 PO			
power steering / servosterzo	DAF XE250C	250	340	10/99	>				S 3081 PO
X3333S.340	DAF XE250C	250	340	10/99	>	S 5045 PE	S 6009 NE		S 3139 C
some prefilter / alcuni prefiltro	DAF XE250C	250	340	05/02	>		S 4142 NR		
with gearbox ZF Ecosplit + Intarder / con cambio ZF Ecosplit + Intarder	DAF XE250C	250	340	10/99	>				S 2234 Z
dryer filter / filtro essiccatore	DAF XE250C	250	340	10/99	>				S 7393 A
LONG LIFE	DAF XE250C	250	340	10/99	>	S 5234 PE	S 6146 NE		
prefilter / prefiltro	DAF XE250C	250	340	10/99	>		S 4143 NR		
rotor for oil centrifuge / rotore per filtro olio centrifugo	DAF XE250C	250	340	10/99	>	S 5902 PO			
power steering / servosterzo	DAF XE250C	250	340	10/99	>				S 3081 PO
X3333S.380	DAF XE280C	280	381	10/99	>	S 5045 PE	S 6009 NE		S 3139 C
some prefilter / alcuni prefiltro	DAF XE280C	280	381	05/02	>		S 4142 NR		
with gearbox ZF Ecosplit + Intarder / con cambio ZF Ecosplit + Intarder	DAF XE280C	280	381	10/99	>				S 2234 Z
dryer filter / filtro essiccatore	DAF XE280C	280	381	10/99	>				S 7393 A
LONG LIFE	DAF XE280C	280	381	10/99	>	S 5234 PE	S 6146 NE		
prefilter / prefiltro	DAF XE280C	280	381	10/99	>		S 4143 NR		
rotor for oil centrifuge / rotore per filtro olio centrifugo	DAF XE280C	280	381	10/99	>	S 5902 PO			
power steering / servosterzo	DAF XE280C	280	381	10/99	>				S 3081 PO
X3335S.340	DAF XE250C	250	340	10/99	>	S 5045 PE	S 6009 NE		S 3139 C
some prefilter / alcuni prefiltro	DAF XE250C	250	340	05/02	>		S 4142 NR		
with gearbox ZF Ecosplit + Intarder / con cambio ZF Ecosplit + Intarder	DAF XE250C	250	340	10/99	>				S 2234 Z
dryer filter / filtro essiccatore	DAF XE250C	250	340	10/99	>				S 7393 A
LONG LIFE	DAF XE250C	250	340	10/99	>	S 5234 PE	S 6146 NE		
prefilter / prefiltro	DAF XE250C	250	340	10/99	>		S 4143 NR		
rotor for oil centrifuge / rotore per filtro olio centrifugo	DAF XE250C	250	340	10/99	>	S 5902 PO			
power steering / servosterzo	DAF XE250C	250	340	10/99	>				S 3081 PO
X3335S.380	DAF XE280C	280	381	10/99	>	S 5045 PE	S 6009 NE		S 3139 C
some prefilter / alcuni prefiltro	DAF XE280C	280	381	05/02	>		S 4142 NR		
with gearbox ZF Ecosplit + Intarder / con cambio ZF Ecosplit + Intarder	DAF XE280C	280	381	10/99	>				S 2234 Z
dryer filter / filtro essiccatore	DAF XE280C	280	381	10/99	>				S 7393 A

G

**KW HP****...GINAF - special trucks/autocarri speciali**

power steering / servosterzo	DAF XE355C	355	483	10/99	>				S 3081 PO
X4245TS.480	DAF XE355C	355	483	10/99	>	S 5045 PE	S 6009 NE	S 7409 A	S 3139 C
some prefilter / alcuni prefiltri	DAF XE355C	355	483	05/02	>		S 4142 NR		
with gearbox ZF Ecosplit + Intarder / con cambio ZF Ecosplit + Intarder	DAF XE355C	355	483	10/99	>				S 2234 Z
dryer filter / filtro essiccatore	DAF XE355C	355	483	10/99	>				S 7393 A
LONG LIFE	DAF XE355C	355	483	10/99	>	S 5234 PE	S 6146 NE		
prefilter / prefiltri	DAF XE355C	355	483	10/99	>		S 4143 NR		
rotor for oil centrifuge / rotore per filtro olio centrifugo	DAF XE355C	355	483	10/99	>	S 5902 PO			
power steering / servosterzo	DAF XE355C	355	483	10/99	>				S 3081 PO
X4245TSV.480	DAF XE355C	355	483	10/99	>	S 5045 PE	S 6009 NE	S 7409 A	S 3139 C
some prefilter / alcuni prefiltri	DAF XE355C	355	483	05/02	>		S 4142 NR		
with gearbox ZF Ecosplit + Intarder / con cambio ZF Ecosplit + Intarder	DAF XE355C	355	483	10/99	>				S 2234 Z
dryer filter / filtro essiccatore	DAF XE355C	355	483	10/99	>				S 7393 A
LONG LIFE	DAF XE355C	355	483	10/99	>	S 5234 PE	S 6146 NE		
prefilter / prefiltri	DAF XE355C	355	483	10/99	>		S 4143 NR		
rotor for oil centrifuge / rotore per filtro olio centrifugo	DAF XE355C	355	483	10/99	>	S 5902 PO			
power steering / servosterzo	DAF XE355C	355	483	10/99	>				S 3081 PO
X4345TS.480	DAF XE355C	355	483	10/99	>	S 5045 PE	S 6009 NE	S 7409 A	S 3139 C
some prefilter / alcuni prefiltri	DAF XE355C	355	483	05/02	>		S 4142 NR		
with gearbox ZF Ecosplit + Intarder / con cambio ZF Ecosplit + Intarder	DAF XE355C	355	483	10/99	>				S 2234 Z
dryer filter / filtro essiccatore	DAF XE355C	355	483	10/99	>				S 7393 A
LONG LIFE	DAF XE355C	355	483	10/99	>	S 5234 PE	S 6146 NE		
prefilter / prefiltri	DAF XE355C	355	483	10/99	>		S 4143 NR		
rotor for oil centrifuge / rotore per filtro olio centrifugo	DAF XE355C	355	483	10/99	>	S 5902 PO			
power steering / servosterzo	DAF XE355C	355	483	10/99	>				S 3081 PO
X4446TS.480	DAF XE355C	355	483	10/99	>	S 5045 PE	S 6009 NE	S 7409 A	S 3139 C
some prefilter / alcuni prefiltri	DAF XE355C	355	483	05/02	>		S 4142 NR		
with gearbox ZF Ecosplit + Intarder / con cambio ZF Ecosplit + Intarder	DAF XE355C	355	483	10/99	>				S 2234 Z
dryer filter / filtro essiccatore	DAF XE355C	355	483	10/99	>				S 7393 A
LONG LIFE	DAF XE355C	355	483	10/99	>	S 5234 PE	S 6146 NE		
prefilter / prefiltri	DAF XE355C	355	483	10/99	>		S 4143 NR		
rotor for oil centrifuge / rotore per filtro olio centrifugo	DAF XE355C	355	483	10/99	>	S 5902 PO			
power steering / servosterzo	DAF XE355C	355	483	10/99	>				S 3081 PO
X4449B.480	DAF XE355C	355	483	10/99	>	S 5045 PE	S 6009 NE	S 7409 A	S 3139 C
some prefilter / alcuni prefiltri	DAF XE355C	355	483	05/02	>		S 4142 NR		
with gearbox ZF Ecosplit + Intarder / con cambio ZF Ecosplit + Intarder	DAF XE355C	355	483	10/99	>				S 2234 Z
dryer filter / filtro essiccatore	DAF XE355C	355	483	10/99	>				S 7393 A
LONG LIFE	DAF XE355C	355	483	10/99	>	S 5234 PE	S 6146 NE		
prefilter / prefiltri	DAF XE355C	355	483	10/99	>		S 4143 NR		
rotor for oil centrifuge / rotore per filtro olio centrifugo	DAF XE355C	355	483	10/99	>	S 5902 PO			
power steering / servosterzo	DAF XE355C	355	483	10/99	>				S 3081 PO
X5250TS.480	DAF XE355C	355	483	10/99	>	S 5045 PE	S 6009 NE	S 7409 A	S 3139 C
some prefilter / alcuni prefiltri	DAF XE355C	355	483	05/02	>		S 4142 NR		
with gearbox ZF Ecosplit + Intarder / con cambio ZF Ecosplit + Intarder	DAF XE355C	355	483	10/99	>				S 2234 Z
dryer filter / filtro essiccatore	DAF XE355C	355	483	10/99	>				S 7393 A
LONG LIFE	DAF XE355C	355	483	10/99	>	S 5234 PE	S 6146 NE		
prefilter / prefiltri	DAF XE355C	355	483	10/99	>		S 4143 NR		
rotor for oil centrifuge / rotore per filtro olio centrifugo	DAF XE355C	355	483	10/99	>	S 5902 PO			
power steering / servosterzo	DAF XE355C	355	483	10/99	>				S 3081 PO
X5350TS.480	DAF XE355C	355	483	10/99	>	S 5045 PE	S 6009 NE	S 7409 A	S 3139 C
some prefilter / alcuni prefiltri	DAF XE355C	355	483	05/02	>		S 4142 NR		
with gearbox ZF Ecosplit + Intarder / con cambio ZF Ecosplit + Intarder	DAF XE355C	355	483	10/99	>				S 2234 Z
dryer filter / filtro essiccatore	DAF XE355C	355	483	10/99	>				S 7393 A
LONG LIFE	DAF XE355C	355	483	10/99	>	S 5234 PE	S 6146 NE		
prefilter / prefiltri	DAF XE355C	355	483	10/99	>		S 4143 NR		
rotor for oil centrifuge / rotore per filtro olio centrifugo	DAF XE355C	355	483	10/99	>	S 5902 PO			
power steering / servosterzo	DAF XE355C	355	483	10/99	>				S 3081 PO
X5364T.460	DAF MX340S	340	462	07/08	>	S 5081 PE	S 6024 NE		S 3139 C
with filter SCR-System / con filtro SCR-System	DAF MX340S	340	462	07/08	>				S 7A86 A
with filter Urea/Adblue / con filtro Urea/Adblue	DAF MX340S	340	462	07/08	>				S 4403 U
dryer filter / filtro essiccatore	DAF MX340S	340	462	07/08	>				S 7393 A
prefilter PARKER-RACOR / prefiltri PARKER-RACOR	DAF MX340S	340	462	07/08	>		S 4143 NR		
prefilter PRELINE / prefiltri PRELINE	DAF MX340S	340	462	07/08	>		S 4142 NR		
power steering / servosterzo	DAF MX340S	340	462	07/08	>				S 3081 PO
X5364T.480	DAF XE355C	355	483	10/99	>	S 5045 PE	S 6009 NE	S 7409 A	S 3139 C
some prefilter / alcuni prefiltri	DAF XE355C	355	483	05/02	>		S 4142 NR		
with gearbox ZF Ecosplit + Intarder / con cambio ZF Ecosplit + Intarder	DAF XE355C	355	483	10/99	>				S 2234 Z

G



KW HP



...GINAF - special trucks/autocarri speciali

G



dryer filter / filtro essiccatore	DAF XE355C	355	483	10/99	>				S 7393 A
LONG LIFE	DAF XE355C	355	483	10/99	>	S 5234 PE	S 6146 NE		
prefilter / prefiltro	DAF XE355C	355	483	10/99	>		S 4143 NR		
rotor for oil centrifuge / rotore per filtro olio centrifugo	DAF XE355C	355	483	10/99	>	S 5902 PO			
power steering / servosterzo	DAF XE355C	355	483	10/99	>				S 3081 PO
X5376T.460	DAF MX340S	340	462	07/08	>	S 5081 PE	S 6024 NE		S 3139 C
with filter SCR-System / con filtro SCR-System	DAF MX340S	340	462	07/08	>				S 7A86 A
with filter Urea/Adblue / con filtro Urea/Adblue	DAF MX340S	340	462	07/08	>				S 4403 U
dryer filter / filtro essiccatore	DAF MX340S	340	462	07/08	>				S 7393 A
prefilter PARKER-RACOR / prefiltro PARKER-RACOR	DAF MX340S	340	462	07/08	>		S 4143 NR		
prefilter PRELINE / prefiltro PRELINE	DAF MX340S	340	462	07/08	>		S 4142 NR		
power steering / servosterzo	DAF MX340S	340	462	07/08	>				S 3081 PO
X5450B.480	DAF XE355C	355	483	10/99	>	S 5045 PE	S 6009 NE	S 7409 A	S 3139 C
some prefilter / alcuni prefiltro	DAF XE355C	355	483	05/02	>		S 4142 NR		
with gearbox ZF Ecosplit + Intarder / con cambio ZF Ecosplit + Intarder	DAF XE355C	355	483	10/99	>				S 2234 Z
dryer filter / filtro essiccatore	DAF XE355C	355	483	10/99	>				S 7393 A
LONG LIFE	DAF XE355C	355	483	10/99	>	S 5234 PE	S 6146 NE		
prefilter / prefiltro	DAF XE355C	355	483	10/99	>		S 4143 NR		
rotor for oil centrifuge / rotore per filtro olio centrifugo	DAF XE355C	355	483	10/99	>	S 5902 PO			
power steering / servosterzo	DAF XE355C	355	483	10/99	>				S 3081 PO
X5450S.480	DAF XE355C	355	483	10/99	>	S 5045 PE	S 6009 NE	S 7409 A	S 3139 C
some prefilter / alcuni prefiltro	DAF XE355C	355	483	05/02	>		S 4142 NR		
with gearbox ZF Ecosplit + Intarder / con cambio ZF Ecosplit + Intarder	DAF XE355C	355	483	10/99	>				S 2234 Z
dryer filter / filtro essiccatore	DAF XE355C	355	483	10/99	>				S 7393 A
LONG LIFE	DAF XE355C	355	483	10/99	>	S 5234 PE	S 6146 NE		
prefilter / prefiltro	DAF XE355C	355	483	10/99	>		S 4143 NR		
rotor for oil centrifuge / rotore per filtro olio centrifugo	DAF XE355C	355	483	10/99	>	S 5902 PO			
power steering / servosterzo	DAF XE355C	355	483	10/99	>				S 3081 PO
X5460B.480	DAF XE355C	355	483	10/99	>	S 5045 PE	S 6009 NE	S 7409 A	S 3139 C
some prefilter / alcuni prefiltro	DAF XE355C	355	483	05/02	>		S 4142 NR		
with gearbox ZF Ecosplit + Intarder / con cambio ZF Ecosplit + Intarder	DAF XE355C	355	483	10/99	>				S 2234 Z
dryer filter / filtro essiccatore	DAF XE355C	355	483	10/99	>				S 7393 A
LONG LIFE	DAF XE355C	355	483	10/99	>	S 5234 PE	S 6146 NE		
prefilter / prefiltro	DAF XE355C	355	483	10/99	>		S 4143 NR		
rotor for oil centrifuge / rotore per filtro olio centrifugo	DAF XE355C	355	483	10/99	>	S 5902 PO			
power steering / servosterzo	DAF XE355C	355	483	10/99	>				S 3081 PO

GUY

trucks/autocarri

Big J Serie

J4	A.E.C. AV505					S 5446 PO	S 8381 NC	S 0150 A	
some / alcuni	A.E.C. AV505					S 5446 PO	S 7111 NC	S 0150 A	
J4	Cummins NH/NHK205						S 4510 NR	S 0150 A	
some / alcuni	Cummins NH/NHK205						S 4510 NR	S 6550 A	
J4	Cummins NH220, NH250						S 4510 NR	S 0150 A	
some / alcuni	Cummins NH220, NH250						S 4510 NR	S 6550 A	
J4	Cummins V6-170, V6-200						S 4510 NR	S 8950 A	
J4	Gardner 6LX, 6LXB							S 0150 A	
J4	Leyland 401						S 7111 NC		
J4	Rolls Royce Eagle 220, 250						S 7111 NC	S 0150 A	
J4T	A.E.C. AV505					S 5446 PO	S 8381 NC	S 0150 A	
some / alcuni	A.E.C. AV505					S 5446 PO	S 7111 NC	S 0150 A	
J4T	Cummins NH/NHK205						S 4510 NR	S 0150 A	
some / alcuni	Cummins NH/NHK205						S 4510 NR	S 6550 A	
J4T	Cummins NH220, NH250						S 4510 NR	S 0150 A	
some / alcuni	Cummins NH220, NH250						S 4510 NR	S 6550 A	
J4T	Gardner 6LX, 6LXB							S 0150 A	
J4T	Leyland 500							S 6550 A	
J4T	Perkins V8.510							S 8950 A	
some / alcuni	Perkins V8.510							S 0150 A	
spin-on / avvitabile	Perkins V8.510					S 0420 R			
cartridge / immersione	Perkins V8.510					S 4380 PO			
J4T	Rolls Royce Eagle 220, 250						S 7111 NC	S 0150 A	
J4T	Rolls Royce Eagle 265						S 7111 NC	S 6550 A	
J6	A.E.C. AV505					S 5446 PO	S 8381 NC	S 0150 A	
some / alcuni	A.E.C. AV505					S 5446 PO	S 7111 NC	S 0150 A	
J6	Cummins NH/NHK205						S 4510 NR	S 0150 A	



kW HP



...GUY - trucks/autocarri

some / alcuni	Cummins NH/NHK205			S 4510 NR	S 6550 A	
J6	Cummins NH220, NH250			S 4510 NR	S 0150 A	
some / alcuni	Cummins NH220, NH250			S 4510 NR	S 6550 A	
J6	Gardner 6LX, 6LXB				S 0150 A	
2nd passage / 2.passaggio	Gardner 6LX, 6LXB				S 0150 A	
J6						
some / alcuni	Leyland 500				S 6550 A	
J6	Perkins V8.510				S 8950 A	
some / alcuni	Perkins V8.510				S 0150 A	
spin-on / avvitabile	Perkins V8.510		S 0420 R			
cartridge / immersione	Perkins V8.510		S 4380 PO			
J6T	Cummins NH/NHK205			S 4510 NR	S 0150 A	
some / alcuni	Cummins NH/NHK205			S 4510 NR	S 6550 A	
J6T	Cummins NH220, NH250			S 4510 NR	S 0150 A	
some / alcuni	Cummins NH220, NH250			S 4510 NR	S 6550 A	
J6T	Cummins NTK350, NTC290			S 4510 NR	S 0150 A	
some / alcuni	Cummins NTK350, NTC290			S 4510 NR	S 6550 A	
J6T	Cummins V6-170, V6-200			S 4510 NR	S 8950 A	
J6T	Gardner 6LX, 6LXB				S 0150 A	
J8	A.E.C. AV505		S 5446 PO	S 8381 NC	S 0150 A	
some / alcuni	A.E.C. AV505		S 5446 PO	S 7111 NC	S 0150 A	
J8	Cummins NH/NHK205			S 4510 NR	S 0150 A	
some / alcuni	Cummins NH/NHK205			S 4510 NR	S 6550 A	
J8	Cummins NH220, NH250			S 4510 NR	S 0150 A	
some / alcuni	Cummins NH220, NH250			S 4510 NR	S 6550 A	
J8	Cummins NTK350, NTC290			S 4510 NR	S 0150 A	
some / alcuni	Cummins NTK350, NTC290			S 4510 NR	S 6550 A	
J8	Gardner 6LX, 6LXB				S 0150 A	
2nd passage / 2.passaggio	Gardner 6LX, 6LXB				S 0150 A	
J8						
some / alcuni	Leyland 500				S 6550 A	
J8	Leyland 680			S 7111 NC		
J8	Rolls Royce Eagle 205			S 7111 NC	S 0150 A	
J8	Rolls Royce Eagle 220, 250			S 7111 NC	S 0150 A	

HAULAMATIC

dump trucks/autocarri ribaltabili

4-10						
4-10	Bedford 466 cu.in.			S 4380 PO	S 7111 NC	S 8950 A
4-10	Perkins 6.354				S 7111 NC	S 8950 A
spin-on / avvitabile	Perkins 6.354			S 0420 R		
cartridge / immersione	Perkins 6.354			S 4380 PO		
4-76						
4-76	Perkins V8.540			S 0420 R		
6-15						
6-15	Perkins V8.510					S 8950 A
spin-on / avvitabile	Perkins V8.510			S 0420 R		
cartridge / immersione	Perkins V8.510			S 4380 PO		
6-15 B	Perkins V8.510					S 0150 A
spin-on / avvitabile	Perkins V8.510			S 0420 R		
cartridge / immersione	Perkins V8.510			S 4380 PO		
6-20						
6-20	Perkins V8.640			S 0420 R		S 0150 A
6-76						
6-76	Caterpillar 3208NA				S 0810 NR	
6-76	Perkins V8.640			S 0420 R		
A 420						
A 420	Detroit Diesel 6V-71			S 3301 PO		
A 420	Detroit Diesel 6V-71T			S 3301 PO		
A 625						
A 625	Detroit Diesel 6V-71			S 3301 PO		
A 625	Detroit Diesel 6V-71T			S 3301 PO		
A 626						
A 626	Detroit Diesel 6V-71			S 3301 PO		
A 626	Detroit Diesel 6V-71T			S 3301 PO		
A 630						
A 630	Detroit Diesel 6V-71			S 3301 PO		
A 630	Detroit Diesel 6V-71T			S 3301 PO		

H





kW HP

**HEATHFIELD****dump trucks/autocarri ribaltabili****DE Serie**

DE 50	Cummins NT 280			S 4510 NR	S 7011 A	
some / alcuni	Cummins NT 280			S 4510 NR	S 0060 A	
some / alcuni	Cummins NT 280			S 4510 NR	S 8950 A	
some / alcuni	Cummins NT 280			S 4510 NR	S 9990 A	
drive / trasmissione	Cummins NT 280					S 3301 PO
DE 50	Dorman 6 LDT			S 8111 NC	S 9990 A	
some / alcuni	Dorman 6 LDT			S 8111 NC	S 6550 A	
some / alcuni	Dorman 6 LDT			S 8111 NC	S 8950 A	
cartridge / immersione	Dorman 6 LDT			S 6181 N		
DE 60	Cummins NT 280			S 4510 NR	S 7011 A	
some / alcuni	Cummins NT 280			S 4510 NR	S 9990 A	
some / alcuni	Cummins NT 280			S 4510 NR	S 0060 A	
some / alcuni	Cummins NT 280			S 4510 NR	S 8950 A	
drive / trasmissione	Cummins NT 280					S 3301 PO
DE 60	Dorman 6 LDT			S 8111 NC	S 9990 A	
some / alcuni	Dorman 6 LDT			S 8111 NC	S 6550 A	
some / alcuni	Dorman 6 LDT			S 8111 NC	S 8950 A	
cartridge / immersione	Dorman 6 LDT			S 6181 N		

DF Serie

DF 20	Perkins 6.354			S 7111 NC	S 0060 A	
spin-on / avvitabile	Perkins 6.354		S 0420 R			
cartridge / immersione	Perkins 6.354		S 4380 PO			
DF 24	Perkins 6.354			S 7111 NC	S 0060 A	
spin-on / avvitabile	Perkins 6.354		S 0420 R			
cartridge / immersione	Perkins 6.354		S 4380 PO			
DF 25 E	Perkins 6.354			S 7111 NC	S 0060 A	
spin-on / avvitabile	Perkins 6.354		S 0420 R			
cartridge / immersione	Perkins 6.354		S 4380 PO			

DG Serie

DG 35	Leyland 680			S 7111 NC	S 0150 A	
DG 35	Perkins V8.510				S 8950 A	
spin-on / avvitabile	Perkins V8.510		S 0420 R			
cartridge / immersione	Perkins V8.510		S 4380 PO			

H Serie

H 11	Perkins 6.354			S 7111 NC	S 0060 A	
spin-on / avvitabile	Perkins 6.354		S 0420 R			
cartridge / immersione	Perkins 6.354		S 4380 PO			
H 19	Leyland 680			S 7111 NC	S 0150 A	
H 19	Perkins V8.510				S 8950 A	
spin-on / avvitabile	Perkins V8.510		S 0420 R			
cartridge / immersione	Perkins V8.510		S 4380 PO			
H 20	Cummins E 290			S 4510 NR		
some / alcuni						
H 20	Cummins E 355			S 4510 NR		
some / alcuni						
H 20	Cummins NT 240			S 4510 NR		
some / alcuni						
H 20	Leyland 680			S 7111 NC	S 0150 A	
H 20	Perkins V8.510				S 8950 A	
spin-on / avvitabile	Perkins V8.510		S 0420 R			
cartridge / immersione	Perkins V8.510		S 4380 PO			
H 25	Cummins NT 280			S 4510 NR	S 7011 A	
some / alcuni	Cummins NT 280			S 4510 NR	S 9990 A	
some / alcuni	Cummins NT 280			S 4510 NR	S 8950 A	
some / alcuni	Cummins NT 280			S 4510 NR	S 0060 A	
drive / trasmissione	Cummins NT 280					S 3301 PO
H 25	Dorman 6 LDT			S 8111 NC	S 9990 A	
some / alcuni	Dorman 6 LDT			S 8111 NC	S 8950 A	
some / alcuni	Dorman 6 LDT			S 8111 NC	S 6550 A	
cartridge / immersione	Dorman 6 LDT			S 6181 N		
H 28	Cummins NT 310			S 4510 NR		
H 28	Cummins NTA 855			S 4510 NR		
H 28	Detroit Diesel 8V-71		S 3301 PO			
H 30						
some / alcuni	Cummins E 290			S 4510 NR		
H 30						



kW HP



...HEATHFIELD - dump trucks/autocarri ribaltabili

some / alcuni	Cummins E 355			S 4510 NR		
H 30						
some / alcuni	Cummins NT 240			S 4510 NR		
H 30	Cummins NT 310			S 4510 NR		
H 30	Cummins NTA 855			S 4510 NR		
H 30	Detroit Diesel 8V-71		S 3301 PO			
H 30 M	Cummins NT 310			S 4510 NR		
H 30 M	Cummins NTA 855			S 4510 NR		
H 30 M	Detroit Diesel 8V-71		S 3301 PO			
H 33						
some / alcuni	Cummins E 290			S 4510 NR		
H 33						
some / alcuni	Cummins E 355			S 4510 NR		
H 33						
some / alcuni	Cummins NT 240			S 4510 NR		

HEULIEZ BUS

buses/autobus

Access Serie

GX 117	Iveco Tector F4A Euro3	154 210	05/02 >	S 0620 R	S 2220 NR	S 7627 A	
dryer filter / filtro essiccatore	Iveco Tector F4A Euro3	154 210	05/02 >				S 7259 A
prefilter / prefiltra	Iveco Tector F4A Euro3	154 210	05/02 >		S 0999 NR		
power steering / servosterzo	Iveco Tector F4A Euro3	154 210	05/02 >				S 3081 PO
GX 117 L	Iveco Tector F4A Euro3	154 210	05/02 >	S 0620 R	S 2220 NR	S 7627 A	
dryer filter / filtro essiccatore	Iveco Tector F4A Euro3	154 210	05/02 >				S 7259 A
prefilter / prefiltra	Iveco Tector F4A Euro3	154 210	05/02 >		S 0999 NR		
power steering / servosterzo	Iveco Tector F4A Euro3	154 210	05/02 >				S 3081 PO
GX 127	Iveco Tector F4A Euro4	160 218	03/06 >	S 0620 R	S 2220 NR	S 7627 A	
with air-conditioner WEBASTO Aerosphere / con climatizzatore WEBASTO Aerosphere	Iveco Tector F4A Euro4	160 218	03/06 >				S 3081 C
with filter Urea/Adblue / con filtro Urea/Adblue	Iveco Tector F4A Euro4	160 218	03/06 >				S 4401 U
dryer filter / filtro essiccatore	Iveco Tector F4A Euro4	160 218	03/06 >				S 7259 A
prefilter / prefiltra	Iveco Tector F4A Euro4	160 218	03/06 >		S 1999 NR		
power steering / servosterzo	Iveco Tector F4A Euro4	160 218	03/06 >				S 3081 PO
GX 127 L	Iveco Tector F4A Euro4	160 218	03/06 >	S 0620 R	S 2220 NR	S 7627 A	
with air-conditioner WEBASTO Aerosphere / con climatizzatore WEBASTO Aerosphere	Iveco Tector F4A Euro4	160 218	03/06 >				S 3081 C
with filter Urea/Adblue / con filtro Urea/Adblue	Iveco Tector F4A Euro4	160 218	03/06 >				S 4401 U
dryer filter / filtro essiccatore	Iveco Tector F4A Euro4	160 218	03/06 >				S 7259 A
prefilter / prefiltra	Iveco Tector F4A Euro4	160 218	03/06 >		S 1999 NR		
power steering / servosterzo	Iveco Tector F4A Euro4	160 218	03/06 >				S 3081 PO
GX 137 Hybride	Iveco Tector 7 Euro6	184 250	10/13 >	S 0620 R	S 4480 NR		
additional WEBASTO / addizionale WEBASTO	Iveco Tector 7 Euro6	184 250	10/13 >		S 4323 NR		
with automatic gearbox ZF HP500/502 / con cambio automatico ZF HP500/502	Iveco Tector 7 Euro6	184 250	10/13 >				S 2234 Z
with air-conditioner WEBASTO Aerosphere / con climatizzatore WEBASTO Aerosphere	Iveco Tector 7 Euro6	184 250	10/13 >				S 3081 C
with filter AdBlue/SCR Denoxtronic 1 / con filtro AdBlue/SCR Denoxtronic 1	Iveco Tector 7 Euro6	184 250	10/13 >				S 4401 U
with filter AdBlue/SCR Denoxtronic 2 / con filtro AdBlue/SCR Denoxtronic 2	Iveco Tector 7 Euro6	184 250	10/13 >				S 4402 U
dryer filter / filtro essiccatore	Iveco Tector 7 Euro6	184 250	10/13 >				S 7259 A
dryer filter WABCO, right-hand thread / filtro essiccatore WABCO, filetto destro	Iveco Tector 7 Euro6	184 250	10/13 >				S 7A66 A
prefilter / prefiltra	Iveco Tector 7 Euro6	184 250	10/13 >		S 1999 NR		
power steering / servosterzo	Iveco Tector 7 Euro6	184 250	10/13 >				S 3081 PO
GX 217	Volvo DH10A	180 245	08/96 > 07/01	S 0900 R		S 0070 A	
by-pass	Volvo DH10A	180 245	08/96 > 07/01	S 4120 R			
dryer filter / filtro essiccatore	Volvo DH10A	180 245	08/96 > 07/01				S 7259 A
fan cooling filter / filtro raffreddamento ventola	Volvo DH10A	180 245	08/96 > 07/01				S 8137 RH
inner / interno	Volvo DH10A	180 245	08/96 > 07/01			S 7A34 A	
LONG LIFE	Volvo DH10A	180 245	08/96 > 07/01	S 4402 R			
2 filters / N.2 filtri	Volvo DH10A	180 245	08/96 > 07/01		S 4323 NR		
drive G7 EGS/G8 EGS/MGS / trasmissione G7 EGS/G8 EGS/MGS	Volvo DH10A	180 245	08/96 > 07/01				S 3257 R
GX 317	Iveco Cursor8 F2BE0682D	180 245	09/01 >	S 3288 R	S 4396 NR	S 7637 A	
with automatic gearbox ZF HP500 / con cambio automatico ZF HP500	Iveco Cursor8 F2BE0682D	180 245	09/01 >				S 2234 Z
dryer filter / filtro essiccatore	Iveco Cursor8 F2BE0682D	180 245	09/01 >				S 7259 A
dryer filter WABCO, right-hand thread / filtro essiccatore WABCO, filetto destro	Iveco Cursor8 F2BE0682D	180 245	09/01 >				S 7A66 A
VGT filter / filtro VGT	Iveco Cursor8 F2BE0682D	180 245	09/01 >				S 0VGT A
inner / interno	Iveco Cursor8 F2BE0682D	180 245	09/01 >			S 7649 A	
power steering / servosterzo	Iveco Cursor8 F2BE0682D	180 245	09/01 >				S 3081 PO
GX 317	Renault MIDR06.20.45	152 206	09/95 > 12/00	S 3698 R		S 7343 A	
with automatic gearbox ZF HP502 / con cambio automatico ZF HP502	Renault MIDR06.20.45	152 206	09/95 > 12/00				S 2234 Z
dryer filter / filtro essiccatore	Renault MIDR06.20.45	152 206	09/95 > 12/00				S 7259 A
hydrostatic steering / guida idrostatica	Renault MIDR06.20.45	152 206	09/95 > 12/00				S 8137 RH

H





...HEULIEZ BUS - buses/autobus



2 filters / N.2 filtri	Renault MIDR06.20.45	152	206	09/95	>	12/00		S 4323 NR		
power steering / servosterzo	Renault MIDR06.20.45	152	206	09/95	>	12/00				S 3081 PO
GX 327	Iveco Cursor8 F2BE0682C Euro 4/5/EEV	213	290	06/04	>		S 3288 R	S 4396 NR	S 7627 A	
additional WEBASTO / addizionale WEBASTO	Iveco Cursor8 F2BE0682C Euro 4/5/EEV	213	290	06/04	>			S 4323 NR		
some / alcuni	Iveco Cursor8 F2BE0682C Euro 4/5/EEV	213	290	06/04	>				S 7637 A	
some / alcuni	Iveco Cursor8 F2BE0682C Euro 4/5/EEV	213	290	09/09	>				S 7A09 A	
with automatic gearbox ZF 5HP504C / con cambio automatico ZF 5HP504C	Iveco Cursor8 F2BE0682C Euro 4/5/EEV	213	290	06/04	>					S 2234 Z
with air-conditioner WEBASTO Aerosphere / con climatizzatore WEBASTO Aerosphere	Iveco Cursor8 F2BE0682C Euro 4/5/EEV	213	290	06/04	>					S 3081 C
with filter AdBlue/SCR / con filtro AdBlue/SCR	Iveco Cursor8 F2BE0682C Euro 4/5/EEV	213	290	06/04	>					S 7A86 A
with filter AdBlue/SCR Denoxtronic 1 / con filtro AdBlue/SCR Denoxtronic 1	Iveco Cursor8 F2BE0682C Euro 4/5/EEV	213	290	06/04	>					S 4401 U
with filter AdBlue/SCR Denoxtronic 2 / con filtro AdBlue/SCR Denoxtronic 2	Iveco Cursor8 F2BE0682C Euro 4/5/EEV	213	290							S 4402 U
dryer filter / filtro essiccatore	Iveco Cursor8 F2BE0682C Euro 4/5/EEV	213	290	06/04	>					S 7259 A
dryer filter WABCO, right-hand thread / filtro essiccatore WABCO, filetto destro	Iveco Cursor8 F2BE0682C Euro 4/5/EEV	213	290							S 7A66 A
VGT filter / filtro VGT	Iveco Cursor8 F2BE0682C Euro 4/5/EEV	213	290	06/04	>					S 0VGT A
prefilter / prefiltra	Iveco Cursor8 F2BE0682C Euro 4/5/EEV	213	290	06/04	>			S 1999 NR		
power steering / servosterzo	Iveco Cursor8 F2BE0682C Euro 4/5/EEV	213	290	06/04	>					S 3081 PO
GX 327	Iveco Cursor8 F2BE0682D Euro 3/4/5/EEV	180	245	06/04	>		S 3288 R	S 4396 NR		
Euro 3	Iveco Cursor8 F2BE0682D Euro 3/4/5/EEV	180	245	06/04	>				S 0450 A	
additional WEBASTO / addizionale WEBASTO	Iveco Cursor8 F2BE0682D Euro 3/4/5/EEV	180	245	06/04	>			S 4323 NR		
some Euro 4/5/EEV / alcuni Euro 4/5/EEV	Iveco Cursor8 F2BE0682D Euro 3/4/5/EEV	180	245	06/04	>				S 7627 A	
some Euro 4/5/EEV / alcuni Euro 4/5/EEV	Iveco Cursor8 F2BE0682D Euro 3/4/5/EEV	180	245	09/09	>				S 7A09 A	
with automatic gearbox ZF 5HP504C / con cambio automatico ZF 5HP504C	Iveco Cursor8 F2BE0682D Euro 3/4/5/EEV	180	245	06/04	>					S 2234 Z
with air-conditioner WEBASTO Aerosphere / con climatizzatore WEBASTO Aerosphere	Iveco Cursor8 F2BE0682D Euro 3/4/5/EEV	180	245	06/04	>					S 3081 C
with filter AdBlue/SCR / con filtro AdBlue/SCR	Iveco Cursor8 F2BE0682D Euro 3/4/5/EEV	180	245	06/04	>					S 7A86 A
with filter AdBlue/SCR Denoxtronic 1 / con filtro AdBlue/SCR Denoxtronic 1	Iveco Cursor8 F2BE0682D Euro 3/4/5/EEV	180	245	06/04	>					S 4401 U
with filter AdBlue/SCR Denoxtronic 2 / con filtro AdBlue/SCR Denoxtronic 2	Iveco Cursor8 F2BE0682D Euro 3/4/5/EEV	180	245							S 4402 U
dryer filter / filtro essiccatore	Iveco Cursor8 F2BE0682D Euro 3/4/5/EEV	180	245	06/04	>					S 7259 A
dryer filter WABCO, right-hand thread / filtro essiccatore WABCO, filetto destro	Iveco Cursor8 F2BE0682D Euro 3/4/5/EEV	180	245							S 7A66 A
VGT filter / filtro VGT	Iveco Cursor8 F2BE0682D Euro 3/4/5/EEV	180	245	06/04	>					S 0VGT A
prefilter / prefiltra	Iveco Cursor8 F2BE0682D Euro 3/4/5/EEV	180	245	06/04	>			S 1999 NR		
power steering / servosterzo	Iveco Cursor8 F2BE0682D Euro 3/4/5/EEV	180	245	06/04	>					S 3081 PO
GX 327 GNV	Iveco Cursor8 GNG F2BE0642A	200	272	07/04	>		S 3288 R			
VGT filter / filtro VGT	Iveco Cursor8 GNG F2BE0642A	200	272	07/04	>					S 0VGT A
GX 417	Volvo DH10A	210	285	08/96	>	07/01	S 0900 R		S 0070 A	
by-pass	Volvo DH10A	210	285	08/96	>	07/01	S 4120 R			
dryer filter / filtro essiccatore	Volvo DH10A	210	285	08/96	>	07/01				S 7259 A
fan cooling filter / filtro raffreddamento ventola	Volvo DH10A	210	285	08/96	>	07/01				S 8137 RH
inner / interno	Volvo DH10A	210	285	08/96	>	07/01			S 7A34 A	
LONG LIFE	Volvo DH10A	210	285	08/96	>	07/01	S 4402 R			
2 filters / N.2 filtri	Volvo DH10A	210	285	08/96	>	07/01		S 4323 NR		
drive G7 EGS/G8 EGS/MGS / trasmissione G7 EGS/G8 EGS/MGS	Volvo DH10A	210	285	08/96	>	07/01				S 3257 R
GX 427	Iveco Cursor 8	213	290	01/08	>		S 3288 R	S 4396 NR	S 7637 A	
additional WEBASTO / addizionale WEBASTO	Iveco Cursor 8	213	290	01/08	>					S 4323 NR
with air-conditioner WEBASTO Aerosphere / con climatizzatore WEBASTO Aerosphere	Iveco Cursor 8	213	290	01/08	>					S 3081 C
with filter Urea/Adblue Denoxtronic 1 / con filtro Urea/Adblue Denoxtronic 1	Iveco Cursor 8	213	290	01/08	>					S 4401 U
with filter Urea/Adblue Denoxtronic 2 / con filtro Urea/Adblue Denoxtronic 2	Iveco Cursor 8	213	290	01/08	>					S 4402 U
dryer filter / filtro essiccatore	Iveco Cursor 8	213	290	01/08	>					S 7259 A
dryer filter WABCO, right-hand thread / filtro essiccatore WABCO, filetto destro	Iveco Cursor 8	213	290	01/08	>					S 7A66 A
VGT filter / filtro VGT	Iveco Cursor 8	213	290	01/08	>					S 0VGT A
inner / interno	Iveco Cursor 8	213	290	01/08	>				S 7649 A	
prefilter / prefiltra	Iveco Cursor 8	213	290	01/08	>			S 1999 NR		
power steering / servosterzo	Iveco Cursor 8	213	290	01/08	>					S 3081 PO
GX 427	Iveco Cursor 8	280	380	01/08	>		S 3288 R	S 4396 NR	S 7637 A	
additional WEBASTO / addizionale WEBASTO	Iveco Cursor 8	280	380	01/08	>					S 4323 NR
with air-conditioner WEBASTO Aerosphere / con climatizzatore WEBASTO Aerosphere	Iveco Cursor 8	280	380	01/08	>					S 3081 C
with filter Urea/Adblue Denoxtronic 1 / con filtro Urea/Adblue Denoxtronic 1	Iveco Cursor 8	280	380	01/08	>					S 4401 U
with filter Urea/Adblue Denoxtronic 2 / con filtro Urea/Adblue Denoxtronic 2	Iveco Cursor 8	280	380	01/08	>					S 4402 U
dryer filter / filtro essiccatore	Iveco Cursor 8	280	380	01/08	>					S 7259 A
dryer filter WABCO, right-hand thread / filtro essiccatore WABCO, filetto destro	Iveco Cursor 8	280	380	01/08	>					S 7A66 A
VGT filter / filtro VGT	Iveco Cursor 8	280	380	01/08	>					S 0VGT A
inner / interno	Iveco Cursor 8	280	380	01/08	>				S 7649 A	
prefilter / prefiltra	Iveco Cursor 8	280	380	01/08	>			S 1999 NR		
power steering / servosterzo	Iveco Cursor 8	280	380	01/08	>					S 3081 PO



kW HP



IFA

trucks/autocarri

L 60 Serie

L 60	6 VD		S 0530 PO	S 2650 A	
2nd passage / 2.passaggio	6 VD			S 1411 N	
2nd passage / 2.passaggio	6 VD			S 7411 N	

W 50 Serie

W 50	4 VD 14.5		S 0530 PO		
2nd passage / 2.passaggio	4 VD 14.5			S 1411 N	
2nd passage / 2.passaggio	4 VD 14.5			S 7411 N	

IKARUS

buses/autobus

100 Serie

IK 100			S 0530 PO	S 0201 N	S 6550 A
2nd passage / 2.passaggio				S 1411 N	
IK 105			S 0530 PO	S 0201 N	S 6550 A
2nd passage / 2.passaggio				S 1411 N	
inner / interno					S 2840 A
IK 108			S 0530 PO	S 0201 N	S 6550 A
2nd passage / 2.passaggio				S 1411 N	
inner / interno					S 2840 A
IK 110			S 0530 PO	S 0201 N	S 6550 A
2nd passage / 2.passaggio				S 1411 N	
inner / interno					S 2840 A
IK 111			S 0530 PO	S 0201 N	S 6550 A
2nd passage / 2.passaggio				S 1411 N	
inner / interno					S 2840 A
IK 115			S 0530 PO	S 0201 N	S 6550 A
2nd passage / 2.passaggio				S 1411 N	
inner / interno					S 2840 A

160 Serie

IK 160	Jelez		S 0530 PO	S 0101 N	S 6550 A
2nd passage / 2.passaggio	Jelez			S 7411 N	
inner / interno	Jelez				S 2840 A
IK 160	Raba		S 0530 PO	S 0201 N	S 6550 A
2nd passage / 2.passaggio	Raba			S 1411 N	
inner / interno	Raba				S 2840 A
IK 161	MAN			S 0201 N	S 6550 A
2nd passage / 2.passaggio	MAN			S 1411 N	
inner / interno	MAN				S 2840 A

190 Serie

196 (B 10 M)	Volvo	09/82 >	S 0900 R	S 4323 NR	
by-pass	Volvo	09/82 >	S 4120 R		

4 Serie

IK 4			S 0530 PO	S 0201 N	S 6550 A
2nd passage / 2.passaggio				S 1411 N	
inner / interno					S 2840 A

400 Serie

IK 435	MAN D 2866 TUH		S 7260 PO	S 0201 N	
2nd passage / 2.passaggio	MAN D 2866 TUH			S 1411 N	

600 Serie

664.10 (B 58)	Volvo		S 0900 R	S 4323 NR	
by-pass	Volvo		S 4120 R		

90 Serie

IK 92			S 0530 PO	S 0201 N	S 0150 A
2nd passage / 2.passaggio				S 1411 N	
IK 93			S 0530 PO	S 0201 N	S 0150 A
2nd passage / 2.passaggio				S 1411 N	

INBUS

buses/autobus

150 Serie

U 150	Aifo		S 0230 R	S 7200 N	S 2370 A
--------------	------	--	----------	----------	----------

176 Serie

U 176	Aifo		S 0230 R	S 0710 NR	S 0150 A
--------------	------	--	----------	-----------	----------

177 Serie

177 FT	Aifo			S 0710 NR	S 0150 A
some / alcuni	Aifo		S 8600 R	S 0710 NR	S 0150 A
177 FTN	Aifo			S 0710 NR	S 0150 A
some / alcuni	Aifo		S 8600 R	S 0710 NR	S 0150 A



...INBUS - buses/autobus

U 177 power steering / servosterzo	Aifo 8220.12		S 7600 R	S 0710 NR	S 0150 A	S 8410 AR S 3081 PO
U 177-4 power steering / servosterzo	Aifo 8220.12		S 7600 R	S 0710 NR	S 0150 A	S 8410 AR S 3081 PO

210 Serie

U 210	Aifo		S 7600 R	S 0710 NR	S 0150 A	
--------------	------	--	----------	-----------	----------	--

IRISBUS

buses/autobus

Ares N

10.60 m	Iveco Cursor8 Euro3	228 310	09/04 >	S 3288 R	S 4396 NR	S 7637 A	
with automatic gearbox ZF 5HP500/5HP502 / con cambio automatico ZF 5HP500/5HP502	Iveco Cursor8 Euro3	228 310	09/04 >				S 2234 Z
with air-conditioner WEBASTO Aerosphere / con climatizzatore WEBASTO Aerosphere	Iveco Cursor8 Euro3	228 310	09/04 >				S 3081 C
dryer filter / filtro essiccatore	Iveco Cursor8 Euro3	228 310	09/04 >				S 7259 A
dryer filter WABCO, right-hand thread / filtro essiccatore WABCO, filetto destro	Iveco Cursor8 Euro3	228 310	09/04 >				S 7A66 A
VGT filter / filtro VGT	Iveco Cursor8 Euro3	228 310	09/04 >				S 0VGT A
inner / interno	Iveco Cursor8 Euro3	228 310	09/04 >			S 7649 A	
prefilter / prefiltra	Iveco Cursor8 Euro3	228 310	09/04 >		S 0999 NR		
power steering / servosterzo	Iveco Cursor8 Euro3	228 310	09/04 >				S 3081 PO
10.60 m	Iveco Cursor8 Euro3	259 352	09/04 >	S 3288 R	S 4396 NR	S 7637 A	
with automatic gearbox ZF 5HP500/5HP502 / con cambio automatico ZF 5HP500/5HP502	Iveco Cursor8 Euro3	259 352	09/04 >				S 2234 Z
with air-conditioner WEBASTO Aerosphere / con climatizzatore WEBASTO Aerosphere	Iveco Cursor8 Euro3	259 352	09/04 >				S 3081 C
dryer filter / filtro essiccatore	Iveco Cursor8 Euro3	259 352	09/04 >				S 7259 A
dryer filter / filtro essiccatore WABCO, filetto destro	Iveco Cursor8 Euro3	259 352	09/04 >				S 7A66 A
VGT filter / filtro VGT	Iveco Cursor8 Euro3	259 352	09/04 >				S 0VGT A
inner / interno	Iveco Cursor8 Euro3	259 352	09/04 >			S 7649 A	
prefilter / prefiltra	Iveco Cursor8 Euro3	259 352	09/04 >		S 0999 NR		
power steering / servosterzo	Iveco Cursor8 Euro3	259 352	09/04 >				S 3081 PO
12 m	dCi 11 Euro 3	230 313	05/02 >			S 7637 A	
with gearbox ZF ECOSPLIT + RETARDER / con cambio ZF ECOSPLIT + RETARDER	dCi 11 Euro 3	230 313	05/02 >				S 2234 Z
with air-conditioner WEBASTO Aerosphere / con climatizzatore WEBASTO Aerosphere	dCi 11 Euro 3	230 313	05/02 >				S 3081 C
dryer filter / filtro essiccatore	dCi 11 Euro 3	230 313	05/02 >				S 7259 A
dryer filter WABCO, right-hand thread / filtro essiccatore WABCO, filetto destro	dCi 11 Euro 3	230 313	05/12 >				S 7A66 A
inner / interno	dCi 11 Euro 3	230 313	05/02 >			S 7649 A	
2 filters / N.2 filtri	dCi 11 Euro 3	230 313	05/02 >	S 0900 R	S 0712 NR		
prefilter / prefiltra	dCi 11 Euro 3	230 313	05/12 >		S 6088 NE		
rotor for oil centrifuge / rotore per filtro olio centrifugo	dCi 11 Euro 3	230 313	02/02 >	S 5903 PO			
power steering / servosterzo	dCi 11 Euro 3	230 313	05/02 >				S 3081 PO
12 m	dCi 11 Euro 3	266 362	05/02 >			S 7637 A	
with gearbox ZF ECOSPLIT + RETARDER / con cambio ZF ECOSPLIT + RETARDER	dCi 11 Euro 3	266 362	05/02 >				S 2234 Z
with air-conditioner WEBASTO Aerosphere / con climatizzatore WEBASTO Aerosphere	dCi 11 Euro 3	266 362	05/02 >				S 3081 C
dryer filter / filtro essiccatore	dCi 11 Euro 3	266 362	05/02 >				S 7259 A
dryer filter WABCO, right-hand thread / filtro essiccatore WABCO, filetto destro	dCi 11 Euro 3	266 362	05/12 >				S 7A66 A
inner / interno	dCi 11 Euro 3	266 362	05/02 >			S 7649 A	
2 filters / N.2 filtri	dCi 11 Euro 3	266 362	05/02 >	S 0900 R	S 0712 NR		
prefilter / prefiltra	dCi 11 Euro 3	266 362	05/12 >		S 6088 NE		
rotor for oil centrifuge / rotore per filtro olio centrifugo	dCi 11 Euro 3	266 362	02/02 >	S 5903 PO			
power steering / servosterzo	dCi 11 Euro 3	266 362	05/02 >				S 3081 PO
12 m	Iveco Cursor8 Euro3	228 310	09/04 >	S 3288 R	S 4396 NR	S 7637 A	
with automatic gearbox ZF 5HP500/5HP502 / con cambio automatico ZF 5HP500/5HP502	Iveco Cursor8 Euro3	228 310	09/04 >				S 2234 Z
with air-conditioner WEBASTO Aerosphere / con climatizzatore WEBASTO Aerosphere	Iveco Cursor8 Euro3	228 310	09/04 >				S 3081 C
dryer filter / filtro essiccatore	Iveco Cursor8 Euro3	228 310	09/04 >				S 7259 A
dryer filter WABCO, right-hand thread / filtro essiccatore WABCO, filetto destro	Iveco Cursor8 Euro3	228 310	09/04 >				S 7A66 A
VGT filter / filtro VGT	Iveco Cursor8 Euro3	228 310	09/04 >				S 0VGT A
inner / interno	Iveco Cursor8 Euro3	228 310	09/04 >			S 7649 A	
prefilter / prefiltra	Iveco Cursor8 Euro3	228 310	09/04 >		S 0999 NR		
power steering / servosterzo	Iveco Cursor8 Euro3	228 310	09/04 >				S 3081 PO
12 m	Iveco Cursor8 Euro3	259 352	09/04 >	S 3288 R	S 4396 NR	S 7637 A	
with automatic gearbox ZF 5HP500/5HP502 / con cambio automatico ZF 5HP500/5HP502	Iveco Cursor8 Euro3	259 352	09/04 >				S 2234 Z
with air-conditioner WEBASTO Aerosphere / con climatizzatore WEBASTO Aerosphere	Iveco Cursor8 Euro3	259 352	09/04 >				S 3081 C
dryer filter / filtro essiccatore	Iveco Cursor8 Euro3	259 352	09/04 >				S 7259 A
dryer filter WABCO, right-hand thread / filtro essiccatore WABCO, filetto destro	Iveco Cursor8 Euro3	259 352	09/04 >				S 7A66 A
VGT filter / filtro VGT	Iveco Cursor8 Euro3	259 352	09/04 >				S 0VGT A
inner / interno	Iveco Cursor8 Euro3	259 352	09/04 >			S 7649 A	
prefilter / prefiltra	Iveco Cursor8 Euro3	259 352	09/04 >		S 0999 NR		
power steering / servosterzo	Iveco Cursor8 Euro3	259 352	09/04 >				S 3081 PO
12.80 m	Iveco Cursor8 Euro3	228 310	09/04 >	S 3288 R	S 4396 NR	S 7637 A	
with automatic gearbox ZF 5HP500/5HP502 / con cambio automatico ZF 5HP500/5HP502	Iveco Cursor8 Euro3	228 310	09/04 >				S 2234 Z

**KW HP****...IRISBUS - buses/autobus**

with air-conditioner WEBASTO Aerosphere / con climatizzatore WEBASTO Aerosphere	Iveco Cursor8 Euro3	228	310	09/04	>				S 3081 C
dryer filter / filtro essiccatore	Iveco Cursor8 Euro3	228	310	09/04	>				S 7259 A
dryer filter WABCO, right-hand thread / filtro essiccatore WABCO, filetto destro	Iveco Cursor8 Euro3	228	310	09/04	>				S 7A66 A
VGT filter / filtro VGT	Iveco Cursor8 Euro3	228	310	09/04	>				S 0VGT A
inner / interno	Iveco Cursor8 Euro3	228	310	09/04	>			S 7649 A	
prefilter / prefiltra	Iveco Cursor8 Euro3	228	310	09/04	>		S 0999 NR		
power steering / servosterzo	Iveco Cursor8 Euro3	228	310	09/04	>				S 3081 PO
12.80 m	Iveco Cursor8 Euro3	259	352	09/04	>	S 3288 R	S 4396 NR	S 7637 A	
with automatic gearbox ZF 5HP500/5HP502 / con cambio automatico ZF 5HP500/5HP502	Iveco Cursor8 Euro3	259	352	09/04	>				S 2234 Z
with air-conditioner WEBASTO Aerosphere / con climatizzatore WEBASTO Aerosphere	Iveco Cursor8 Euro3	259	352	09/04	>				S 3081 C
dryer filter / filtro essiccatore	Iveco Cursor8 Euro3	259	352	09/04	>				S 7259 A
dryer filter WABCO, right-hand thread / filtro essiccatore WABCO, filetto destro	Iveco Cursor8 Euro3	259	352	09/04	>				S 7A66 A
VGT filter / filtro VGT	Iveco Cursor8 Euro3	259	352	09/04	>				S 0VGT A
inner / interno	Iveco Cursor8 Euro3	259	352	09/04	>			S 7649 A	
prefilter / prefiltra	Iveco Cursor8 Euro3	259	352	09/04	>		S 0999 NR		
power steering / servosterzo	Iveco Cursor8 Euro3	259	352	09/04	>				S 3081 PO
Arway									
10.6 m	Iveco Cursor8 Euro4/5	243	330	12/05	>	S 3288 R	S 4396 NR	S 7637 A	
additional WEBASTO / addizionale WEBASTO	Iveco Cursor8 Euro4/5	243	330	12/05	>		S 4323 NR		
with automatic gearbox ZF HP592 / con cambio automatico ZF HP592	Iveco Cursor8 Euro4/5	243	330	12/05	>				S 2234 Z
with air-conditioner WEBASTO Aerosphere / con climatizzatore WEBASTO Aerosphere	Iveco Cursor8 Euro4/5	243	330	12/05	>				S 3081 C
with air-conditioner WEBASTO Aerosphere World 32/35 kW / con climatizzatore WEBASTO Aerosphere World 32/35 kW	Iveco Cursor8 Euro4/5	243	330	12/05	>				S 3283 C
with filter / con filtro	Iveco Cursor8 Euro4/5	243	330	12/05	>				S 4402 U
with filter Urea/Adblue Denoxtronic 1 / con filtro Urea/Adblue Denoxtronic 1	Iveco Cursor8 Euro4/5	243	330	12/05	>				S 4401 U
dryer filter / filtro essiccatore	Iveco Cursor8 Euro4/5	243	330	12/05	>				S 7259 A
dryer filter WABCO, right-hand thread / filtro essiccatore WABCO, filetto destro	Iveco Cursor8 Euro4/5	243	330	12/05	>				S 7A66 A
VGT filter / filtro VGT	Iveco Cursor8 Euro4/5	243	330	12/05	>				S 0VGT A
hydrostatic steering / guida idrostatica	Iveco Cursor8 Euro4/5	243	330	12/05	>				S 8137 RH
inner / interno	Iveco Cursor8 Euro4/5	243	330	12/05	>			S 7649 A	
prefilter / prefiltra	Iveco Cursor8 Euro4/5	243	330	12/05	>		S 1999 NR		
power steering / servosterzo	Iveco Cursor8 Euro4/5	243	330	12/05	>				S 3081 PO
10.6 m	Iveco Cursor8 Euro4/5	280	381	12/05	>	S 3288 R	S 4396 NR	S 7637 A	
additional WEBASTO / addizionale WEBASTO	Iveco Cursor8 Euro4/5	280	381	12/05	>		S 4323 NR		
with automatic gearbox ZF HP592 / con cambio automatico ZF HP592	Iveco Cursor8 Euro4/5	280	381	12/05	>				S 2234 Z
with air-conditioner WEBASTO Aerosphere / con climatizzatore WEBASTO Aerosphere	Iveco Cursor8 Euro4/5	280	381	12/05	>				S 3081 C
with air-conditioner WEBASTO Aerosphere World 32/35 kW / con climatizzatore WEBASTO Aerosphere World 32/35 kW	Iveco Cursor8 Euro4/5	280	381	12/05	>				S 3283 C
with filter Urea/Adblue Denoxtronic 1 / con filtro Urea/Adblue Denoxtronic 1	Iveco Cursor8 Euro4/5	280	381	12/05	>				S 4401 U
with filter Urea/Adblue Denoxtronic 2 / con filtro Urea/Adblue Denoxtronic 2	Iveco Cursor8 Euro4/5	280	381	12/05	>				S 4402 U
dryer filter / filtro essiccatore	Iveco Cursor8 Euro4/5	280	381	12/05	>				S 7259 A
dryer filter WABCO, right-hand thread / filtro essiccatore WABCO, filetto destro	Iveco Cursor8 Euro4/5	280	381	12/05	>				S 7A66 A
VGT filter / filtro VGT	Iveco Cursor8 Euro4/5	280	381	12/05	>				S 0VGT A
hydrostatic steering / guida idrostatica	Iveco Cursor8 Euro4/5	280	381	12/05	>				S 8137 RH
inner / interno	Iveco Cursor8 Euro4/5	280	381	12/05	>			S 7649 A	
prefilter / prefiltra	Iveco Cursor8 Euro4/5	280	381	12/05	>		S 1999 NR		
power steering / servosterzo	Iveco Cursor8 Euro4/5	280	381	12/05	>				S 3081 PO
10.6 m	Iveco Cursor8 Euro4/5	331	450	12/05	>	S 3288 R	S 4396 NR	S 7637 A	
additional WEBASTO / addizionale WEBASTO	Iveco Cursor8 Euro4/5	331	450	12/05	>		S 4323 NR		
with automatic gearbox ZF HP592 / con cambio automatico ZF HP592	Iveco Cursor8 Euro4/5	331	450	12/05	>				S 2234 Z
with air-conditioner WEBASTO Aerosphere / con climatizzatore WEBASTO Aerosphere	Iveco Cursor8 Euro4/5	331	450	12/05	>				S 3081 C
with air-conditioner WEBASTO Aerosphere World 32/35 kW / con climatizzatore WEBASTO Aerosphere World 32/35 kW	Iveco Cursor8 Euro4/5	331	450	12/05	>				S 3283 C
with filter Urea/Adblue Denoxtronic 1 / con filtro Urea/Adblue Denoxtronic 1	Iveco Cursor8 Euro4/5	331	450	12/05	>				S 4401 U
with filter Urea/Adblue Denoxtronic 2 / con filtro Urea/Adblue Denoxtronic 2	Iveco Cursor8 Euro4/5	331	450	12/05	>				S 4402 U
dryer filter / filtro essiccatore	Iveco Cursor8 Euro4/5	331	450	12/05	>				S 7259 A
dryer filter WABCO, right-hand thread / filtro essiccatore WABCO, filetto destro	Iveco Cursor8 Euro4/5	331	450	12/05	>				S 7A66 A
VGT filter / filtro VGT	Iveco Cursor8 Euro4/5	331	450	12/05	>				S 0VGT A
hydrostatic steering / guida idrostatica	Iveco Cursor8 Euro4/5	331	450	12/05	>				S 8137 RH
inner / interno	Iveco Cursor8 Euro4/5	331	450	12/05	>			S 7649 A	
prefilter / prefiltra	Iveco Cursor8 Euro4/5	331	450	12/05	>		S 1999 NR		
power steering / servosterzo	Iveco Cursor8 Euro4/5	331	450	12/05	>				S 3081 PO
12 m	Iveco Cursor8 Euro4/5	243	330	12/05	>	S 3288 R	S 4396 NR	S 7637 A	
additional WEBASTO / addizionale WEBASTO	Iveco Cursor8 Euro4/5	243	330	12/05	>		S 4323 NR		
with automatic gearbox ZF HP592 / con cambio automatico ZF HP592	Iveco Cursor8 Euro4/5	243	330	12/05	>				S 2234 Z
with air-conditioner WEBASTO Aerosphere / con climatizzatore WEBASTO Aerosphere	Iveco Cursor8 Euro4/5	243	330	12/05	>				S 3081 C
with air-conditioner WEBASTO Aerosphere World 32/35 kW / con climatizzatore WEBASTO Aerosphere World 32/35 kW	Iveco Cursor8 Euro4/5	243	330	12/05	>				S 3283 C
with filter Urea/Adblue Denoxtronic 1 / con filtro Urea/Adblue Denoxtronic 1	Iveco Cursor8 Euro4/5	243	330	12/05	>				S 4401 U
with filter Urea/Adblue Denoxtronic 2 / con filtro Urea/Adblue Denoxtronic 2	Iveco Cursor8 Euro4/5	243	330	12/05	>				S 4402 U
dryer filter / filtro essiccatore	Iveco Cursor8 Euro4/5	243	330	12/05	>				S 7259 A

**KW HP****...IRISBUS - buses/autobus**

dryer filter WABCO, right-hand thread / filtro essiccatore WABCO, filetto destro	Iveco Cursor8 Euro4/5	243	330	12/05	>				S 7A66 A
VGT filter / filtro VGT	Iveco Cursor8 Euro4/5	243	330	12/05	>				S 0VGT A
hydrostatic steering / guida idrostatica	Iveco Cursor8 Euro4/5	243	330	12/05	>				S 8137 RH
inner / interno	Iveco Cursor8 Euro4/5	243	330	12/05	>			S 7649 A	
prefilter / prefiltrò	Iveco Cursor8 Euro4/5	243	330	12/05	>		S 1999 NR		
power steering / servosterzo	Iveco Cursor8 Euro4/5	243	330	12/05	>				S 3081 PO
12 m	Iveco Cursor8 Euro4/5	280	381	12/05	>	S 3288 R	S 4396 NR	S 7637 A	
additional WEBASTO / addizionale WEBASTO	Iveco Cursor8 Euro4/5	280	381	12/05	>		S 4323 NR		
with automatic gearbox ZF HP592 / con cambio automatico ZF HP592	Iveco Cursor8 Euro4/5	280	381	12/05	>				S 2234 Z
with air-conditioner WEBASTO Aerosphere / con climatizzatore WEBASTO Aerosphere	Iveco Cursor8 Euro4/5	280	381	12/05	>				S 3081 C
with air-conditioner WEBASTO Aerosphere World 32/35 kW / con climatizzatore WEBASTO Aerosphere World 32/35 kW	Iveco Cursor8 Euro4/5	280	381	12/05	>				S 3283 C
with filter Urea/Adblue / con filtro Urea/Adblue	Iveco Cursor8 Euro4/5	280	381	12/05	>				S 4401 U
with filter Urea/Adblue Denoxtronic 2 / con filtro Urea/Adblue Denoxtronic 2	Iveco Cursor8 Euro4/5	280	381	12/05	>				S 4402 U
dryer filter / filtro essiccatore	Iveco Cursor8 Euro4/5	280	381	12/05	>				S 7259 A
dryer filter WABCO, filetto destro / filtro essiccatore WABCO, filetto destro	Iveco Cursor8 Euro4/5	280	381	12/05	>				S 7A66 A
VGT filter / filtro VGT	Iveco Cursor8 Euro4/5	280	381	12/05	>				S 0VGT A
hydrostatic steering / guida idrostatica	Iveco Cursor8 Euro4/5	280	381	12/05	>				S 8137 RH
inner / interno	Iveco Cursor8 Euro4/5	280	381	12/05	>			S 7649 A	
prefilter / prefiltrò	Iveco Cursor8 Euro4/5	280	381	12/05	>		S 1999 NR		
power steering / servosterzo	Iveco Cursor8 Euro4/5	280	381	12/05	>				S 3081 PO
12 m	Iveco Cursor8 Euro4/5	331	450	12/05	>	S 3288 R	S 4396 NR	S 7637 A	
additional WEBASTO / addizionale WEBASTO	Iveco Cursor8 Euro4/5	331	450	12/05	>		S 4323 NR		
with automatic gearbox ZF HP592 / con cambio automatico ZF HP592	Iveco Cursor8 Euro4/5	331	450	12/05	>				S 2234 Z
with air-conditioner WEBASTO Aerosphere / con climatizzatore WEBASTO Aerosphere	Iveco Cursor8 Euro4/5	331	450	12/05	>				S 3081 C
with air-conditioner WEBASTO Aerosphere World 32/35 kW / con climatizzatore WEBASTO Aerosphere World 32/35 kW	Iveco Cursor8 Euro4/5	331	450	12/05	>				S 3283 C
with filter Urea/Adblue Denoxtronic 1 / con filtro Urea/Adblue Denoxtronic 1	Iveco Cursor8 Euro4/5	331	450	12/05	>				S 4401 U
with filter Urea/Adblue Denoxtronic 2 / con filtro Urea/Adblue Denoxtronic 2	Iveco Cursor8 Euro4/5	331	450	12/05	>				S 4402 U
dryer filter / filtro essiccatore	Iveco Cursor8 Euro4/5	331	450	12/05	>				S 7259 A
dryer filter WABCO, right-hand thread / filtro essiccatore WABCO, filetto destro	Iveco Cursor8 Euro4/5	331	450	12/05	>				S 7A66 A
VGT filter / filtro VGT	Iveco Cursor8 Euro4/5	331	450	12/05	>				S 0VGT A
hydrostatic steering / guida idrostatica	Iveco Cursor8 Euro4/5	331	450	12/05	>				S 8137 RH
inner / interno	Iveco Cursor8 Euro4/5	331	450	12/05	>			S 7649 A	
prefilter / prefiltrò	Iveco Cursor8 Euro4/5	331	450	12/05	>		S 1999 NR		
power steering / servosterzo	Iveco Cursor8 Euro4/5	331	450	12/05	>				S 3081 PO
12.8 m	Iveco Cursor8 Euro4/5	243	330	12/05	>	S 3288 R	S 4396 NR	S 7637 A	
additional WEBASTO / addizionale WEBASTO	Iveco Cursor8 Euro4/5	243	330	12/05	>		S 4323 NR		
with automatic gearbox ZF HP592 / con cambio automatico ZF HP592	Iveco Cursor8 Euro4/5	243	330	12/05	>				S 2234 Z
with air-conditioner WEBASTO Aerosphere / con climatizzatore WEBASTO Aerosphere	Iveco Cursor8 Euro4/5	243	330	12/05	>				S 3081 C
with air-conditioner WEBASTO Aerosphere World 32/35 kW / con climatizzatore WEBASTO Aerosphere World 32/35 kW	Iveco Cursor8 Euro4/5	243	330	12/05	>				S 3283 C
with filter Urea/Adblue Denoxtronic 1 / con filtro Urea/Adblue Denoxtronic 1	Iveco Cursor8 Euro4/5	243	330	12/05	>				S 4401 U
with filter Urea/Adblue Denoxtronic 2 / con filtro Urea/Adblue Denoxtronic 2	Iveco Cursor8 Euro4/5	243	330	12/05	>				S 4402 U
dryer filter / filtro essiccatore	Iveco Cursor8 Euro4/5	243	330	12/05	>				S 7259 A
dryer filter WABCO, right-hand thread / filtro essiccatore WABCO, filetto destro	Iveco Cursor8 Euro4/5	243	330	12/05	>				S 7A66 A
VGT filter / filtro VGT	Iveco Cursor8 Euro4/5	243	330	12/05	>				S 0VGT A
hydrostatic steering / guida idrostatica	Iveco Cursor8 Euro4/5	243	330	12/05	>				S 8137 RH
inner / interno	Iveco Cursor8 Euro4/5	243	330	12/05	>			S 7649 A	
prefilter / prefiltrò	Iveco Cursor8 Euro4/5	243	330	12/05	>		S 1999 NR		
power steering / servosterzo	Iveco Cursor8 Euro4/5	243	330	12/05	>				S 3081 PO
12.8 m	Iveco Cursor8 Euro4/5	280	381	12/05	>	S 3288 R	S 4396 NR	S 7637 A	
additional WEBASTO / addizionale WEBASTO	Iveco Cursor8 Euro4/5	280	381	12/05	>		S 4323 NR		
with automatic gearbox ZF HP592 / con cambio automatico ZF HP592	Iveco Cursor8 Euro4/5	280	381	12/05	>				S 2234 Z
with air-conditioner WEBASTO Aerosphere / con climatizzatore WEBASTO Aerosphere	Iveco Cursor8 Euro4/5	280	381	12/05	>				S 3081 C
with air-conditioner WEBASTO Aerosphere World 32/35 kW / con climatizzatore WEBASTO Aerosphere World 32/35 kW	Iveco Cursor8 Euro4/5	280	381	12/05	>				S 3283 C
with filter Urea/Adblue Denoxtronic 1 / con filtro Urea/Adblue Denoxtronic 1	Iveco Cursor8 Euro4/5	280	381	12/05	>				S 4401 U
with filter Urea/Adblue Denoxtronic 2 / con filtro Urea/Adblue Denoxtronic 2	Iveco Cursor8 Euro4/5	280	381	12/05	>				S 4402 U
dryer filter / filtro essiccatore	Iveco Cursor8 Euro4/5	280	381	12/05	>				S 7259 A
dryer filter WABCO, right-hand thread / filtro essiccatore WABCO, filetto destro	Iveco Cursor8 Euro4/5	280	381	12/05	>				S 7A66 A
VGT filter / filtro VGT	Iveco Cursor8 Euro4/5	280	381	12/05	>				S 0VGT A
hydrostatic steering / guida idrostatica	Iveco Cursor8 Euro4/5	280	381	12/05	>				S 8137 RH
inner / interno	Iveco Cursor8 Euro4/5	280	381	12/05	>			S 7649 A	
prefilter / prefiltrò	Iveco Cursor8 Euro4/5	280	381	12/05	>		S 1999 NR		
power steering / servosterzo	Iveco Cursor8 Euro4/5	280	381	12/05	>				S 3081 PO
12.8 m	Iveco Cursor8 Euro4/5	331	450	12/05	>	S 3288 R	S 4396 NR	S 7637 A	
additional WEBASTO / addizionale WEBASTO	Iveco Cursor8 Euro4/5	331	450	12/05	>		S 4323 NR		
with automatic gearbox ZF HP592 / con cambio automatico ZF HP592	Iveco Cursor8 Euro4/5	331	450	12/05	>				S 2234 Z
with air-conditioner WEBASTO Aerosphere / con climatizzatore WEBASTO Aerosphere	Iveco Cursor8 Euro4/5	331	450	12/05	>				S 3081 C
with air-conditioner WEBASTO Aerosphere World 32/35 kW / con climatizzatore WEBASTO Aerosphere World 32/35 kW	Iveco Cursor8 Euro4/5	331	450	12/05	>				S 3283 C



...IRISBUS - buses/autobus

with filter Urea/Adblue Denoxtronic 1 / con filtro Urea/Adblue Denoxtronic 1	Iveco Cursor8 Euro4/5	331	450	12/05	>				S 4401 U
with filter Urea/Adblue Denoxtronic 2 / con filtro Urea/Adblue Denoxtronic 2	Iveco Cursor8 Euro4/5	331	450	12/05	>				S 4402 U
dryer filter / filtro essiccatore	Iveco Cursor8 Euro4/5	331	450	12/05	>				S 7259 A
dryer filter WABCO, right-hand thread / filtro essiccatore WABCO, filetto destro	Iveco Cursor8 Euro4/5	331	450	12/05	>				S 7A66 A
VGT filter / filtro VGT	Iveco Cursor8 Euro4/5	331	450	12/05	>				S 0VGT A
hydrostatic steering / guida idrostatica	Iveco Cursor8 Euro4/5	331	450	12/05	>				S 8137 RH
inner / interno	Iveco Cursor8 Euro4/5	331	450	12/05	>				
prefilter / prefiltrato	Iveco Cursor8 Euro4/5	331	450	12/05	>		S 1999 NR	S 7649 A	
power steering / servosterzo	Iveco Cursor8 Euro4/5	331	450	12/05	>				S 3081 PO
15 m	Iveco Cursor8 Euro4/5	243	330	12/05	>	S 3288 R	S 4396 NR	S 7637 A	
additional WEBASTO / addizionale WEBASTO	Iveco Cursor8 Euro4/5	243	330	12/05	>		S 4323 NR		
with automatic gearbox ZF HP592 / con cambio automatico ZF HP592	Iveco Cursor8 Euro4/5	243	330	12/05	>				S 2234 Z
with air-conditioner WEBASTO Aerosphere / con climatizzatore WEBASTO Aerosphere	Iveco Cursor8 Euro4/5	243	330	12/05	>				S 3081 C
with air-conditioner WEBASTO Aerosphere World 32/35 kW / con climatizzatore WEBASTO Aerosphere World 32/35 kW	Iveco Cursor8 Euro4/5	243	330	12/05	>				S 3283 C
with filter Urea/Adblue Denoxtronic 1 / con filtro Urea/Adblue Denoxtronic 1	Iveco Cursor8 Euro4/5	243	330	12/05	>				S 4401 U
with filter Urea/Adblue Denoxtronic 2 / con filtro Urea/Adblue Denoxtronic 2	Iveco Cursor8 Euro4/5	243	330	12/05	>				S 4402 U
dryer filter / filtro essiccatore	Iveco Cursor8 Euro4/5	243	330	12/05	>				S 7259 A
dryer filter WABCO, right-hand thread / filtro essiccatore WABCO, filetto destro	Iveco Cursor8 Euro4/5	243	330	12/05	>				S 7A66 A
VGT filter / filtro VGT	Iveco Cursor8 Euro4/5	243	330	12/05	>				S 0VGT A
hydrostatic steering / guida idrostatica	Iveco Cursor8 Euro4/5	243	330	12/05	>				S 8137 RH
inner / interno	Iveco Cursor8 Euro4/5	243	330	12/05	>			S 7649 A	
prefilter / prefiltrato	Iveco Cursor8 Euro4/5	243	330	12/05	>		S 1999 NR		
power steering / servosterzo	Iveco Cursor8 Euro4/5	243	330	12/05	>				S 3081 PO
15 m	Iveco Cursor8 Euro4/5	280	381	12/05	>	S 3288 R	S 4396 NR	S 7637 A	
additional WEBASTO / addizionale WEBASTO	Iveco Cursor8 Euro4/5	280	381	12/05	>		S 4323 NR		
with automatic gearbox ZF HP592 / con cambio automatico ZF HP592	Iveco Cursor8 Euro4/5	280	381	12/05	>				S 2234 Z
with air-conditioner / con climatizzatore	Iveco Cursor8 Euro4/5	280	381	12/05	>				S 3283 C
with air-conditioner WEBASTO Aerosphere / con climatizzatore WEBASTO Aerosphere	Iveco Cursor8 Euro4/5	280	381	12/05	>				S 3081 C
with filter Urea/Adblue Denoxtronic 1 / con filtro Urea/Adblue Denoxtronic 1	Iveco Cursor8 Euro4/5	280	381	12/05	>				S 4401 U
with filter Urea/Adblue Denoxtronic 2 / con filtro Urea/Adblue Denoxtronic 2	Iveco Cursor8 Euro4/5	280	381	12/05	>				S 4402 U
dryer filter / filtro essiccatore	Iveco Cursor8 Euro4/5	280	381	12/05	>				S 7259 A
dryer filter WABCO, right-hand thread / filtro essiccatore WABCO, filetto destro	Iveco Cursor8 Euro4/5	280	381	12/05	>				S 7A66 A
VGT filter / filtro VGT	Iveco Cursor8 Euro4/5	280	381	12/05	>				S 0VGT A
hydrostatic steering / guida idrostatica	Iveco Cursor8 Euro4/5	280	381	12/05	>				S 8137 RH
inner / interno	Iveco Cursor8 Euro4/5	280	381	12/05	>			S 7649 A	
prefilter / prefiltrato	Iveco Cursor8 Euro4/5	280	381	12/05	>		S 1999 NR		
power steering / servosterzo	Iveco Cursor8 Euro4/5	280	381	12/05	>				S 3081 PO
15 m	Iveco Cursor8 Euro4/5	331	450	12/05	>	S 3288 R	S 4396 NR	S 7637 A	
additional WEBASTO / addizionale WEBASTO	Iveco Cursor8 Euro4/5	331	450	12/05	>		S 4323 NR		
with automatic gearbox ZF HP592 / con cambio automatico ZF HP592	Iveco Cursor8 Euro4/5	331	450	12/05	>				S 2234 Z
with air-conditioner WEBASTO Aerosphere / con climatizzatore WEBASTO Aerosphere	Iveco Cursor8 Euro4/5	331	450	12/05	>				S 3081 C
with air-conditioner WEBASTO Aerosphere World 32/35 kW / con climatizzatore WEBASTO Aerosphere World 32/35 kW	Iveco Cursor8 Euro4/5	331	450	12/05	>				S 3283 C
with filter Urea/Adblue Denoxtronic 1 / con filtro Urea/Adblue Denoxtronic 1	Iveco Cursor8 Euro4/5	331	450	12/05	>				S 4401 U
with filter Urea/Adblue Denoxtronic 2 / con filtro Urea/Adblue Denoxtronic 2	Iveco Cursor8 Euro4/5	331	450	12/05	>				S 4402 U
dryer filter / filtro essiccatore	Iveco Cursor8 Euro4/5	331	450	12/05	>				S 7259 A
dryer filter WABCO, right-hand thread / filtro essiccatore WABCO, filetto destro	Iveco Cursor8 Euro4/5	331	450	12/05	>				S 7A66 A
VGT filter / filtro VGT	Iveco Cursor8 Euro4/5	331	450	12/05	>				S 0VGT A
hydrostatic steering / guida idrostatica	Iveco Cursor8 Euro4/5	331	450	12/05	>				S 8137 RH
inner / interno	Iveco Cursor8 Euro4/5	331	450	12/05	>			S 7649 A	
prefilter / prefiltrato	Iveco Cursor8 Euro4/5	331	450	12/05	>		S 1999 NR		
power steering / servosterzo	Iveco Cursor8 Euro4/5	331	450	12/05	>				S 3081 PO
Axer									
12 m	Iveco Cursor8 Euro3	228	310	09/04	>	S 3288 R	S 4396 NR	S 7637 A	
with automatic gearbox ZF HP500/5HP502 / con cambio automatico ZF HP500/5HP502	Iveco Cursor8 Euro3	228	310	09/04	>				S 2234 Z
with air-conditioner WEBASTO Aerosphere / con climatizzatore WEBASTO Aerosphere	Iveco Cursor8 Euro3	228	310	09/04	>				S 3081 C
dryer filter / filtro essiccatore	Iveco Cursor8 Euro3	228	310	09/04	>				S 7259 A
dryer filter WABCO, filetto destro / filtro essiccatore WABCO, filetto destro	Iveco Cursor8 Euro3	228	310	09/04	>				S 7A66 A
VGT filter / filtro VGT	Iveco Cursor8 Euro3	228	310	09/04	>				S 0VGT A
hydrostatic steering / guida idrostatica	Iveco Cursor8 Euro3	228	310	09/04	>				S 8137 RH
inner / interno	Iveco Cursor8 Euro3	228	310	09/04	>			S 7649 A	
prefilter / prefiltrato	Iveco Cursor8 Euro3	228	310	09/04	>		S 0999 NR		
prefilter RACOR / prefiltrato RACOR	Iveco Cursor8 Euro3	228	310	09/04	>				S 4470 NR
power steering / servosterzo	Iveco Cursor8 Euro3	228	310	09/04	>				S 3081 PO
12 m	Iveco Cursor8 Euro3	259	352	09/04	>	S 3288 R	S 4396 NR	S 7637 A	
with automatic gearbox ZF HP500/5HP502 / con cambio automatico ZF HP500/5HP502	Iveco Cursor8 Euro3	259	352	09/04	>				S 2234 Z
with air-conditioner WEBASTO Aerosphere / con climatizzatore WEBASTO Aerosphere	Iveco Cursor8 Euro3	259	352	09/04	>				S 3081 C
dryer filter / filtro essiccatore	Iveco Cursor8 Euro3	259	352	09/04	>				S 7259 A



kW HP



...IRISBUS - buses/autobus

dryer filter WABCO, right-hand thread / filtro essiccatore WABCO, filetto destro	Iveco Cursor8 Euro3	259	352	09/04	>				S 7A66 A
VGT filter / filtro VGT	Iveco Cursor8 Euro3	259	352	09/04	>				S 0VGT A
hydrostatic steering / guida idrostatica	Iveco Cursor8 Euro3	259	352	09/04	>				S 8137 RH
inner / interno	Iveco Cursor8 Euro3	259	352	09/04	>			S 7649 A	
prefilter / prefiltro	Iveco Cursor8 Euro3	259	352	09/04	>		S 0999 NR		
prefilter RACOR / prefiltro RACOR	Iveco Cursor8 Euro3	259	352	09/04	>				S 4470 NR
power steering / servosterzo	Iveco Cursor8 Euro3	259	352	09/04	>				S 3081 PO
12.80 m	Iveco Cursor8 Euro3	228	310	09/04	>	S 3288 R	S 4396 NR		
with automatic gearbox ZF HP500/5HP502 / con cambio automatico ZF HP500/5HP502	Iveco Cursor8 Euro3	228	310	09/04	>				S 2234 Z
with air-conditioner WEBASTO Aerosphere / con climatizzatore WEBASTO Aerosphere	Iveco Cursor8 Euro3	228	310	09/04	>				S 3081 C
dryer filter / filtro essiccatore	Iveco Cursor8 Euro3	228	310	09/04	>				S 7259 A
dryer filter WABCO, right-hand thread / filtro essiccatore WABCO, filetto destro	Iveco Cursor8 Euro3	228	310	09/04	>				S 7A66 A
VGT filter / filtro VGT	Iveco Cursor8 Euro3	228	310	09/04	>				S 0VGT A
hydrostatic steering / guida idrostatica	Iveco Cursor8 Euro3	228	310	09/04	>				S 8137 RH
inner / interno	Iveco Cursor8 Euro3	228	310	09/04	>			S 7649 A	
prefilter / prefiltro	Iveco Cursor8 Euro3	228	310	09/04	>		S 0999 NR		
prefilter RACOR / prefiltro RACOR	Iveco Cursor8 Euro3	228	310	09/04	>				S 4470 NR
power steering / servosterzo	Iveco Cursor8 Euro3	228	310	09/04	>				S 3081 PO
12.80 m	Iveco Cursor8 Euro3	259	352	09/04	>	S 3288 R	S 4396 NR	S 7637 A	
with automatic gearbox ZF HP500/5HP502 / con cambio automatico ZF HP500/5HP502	Iveco Cursor8 Euro3	259	352	09/04	>				S 2234 Z
with air-conditioner WEBASTO Aerosphere / con climatizzatore WEBASTO Aerosphere	Iveco Cursor8 Euro3	259	352	09/04	>				S 3081 C
dryer filter / filtro essiccatore	Iveco Cursor8 Euro3	259	352	09/04	>				S 7259 A
dryer filter WABCO, filetto destro / filtro essiccatore WABCO, filetto destro	Iveco Cursor8 Euro3	259	352	09/04	>				S 7A66 A
VGT filter / filtro VGT	Iveco Cursor8 Euro3	259	352	09/04	>				S 0VGT A
hydrostatic steering / guida idrostatica	Iveco Cursor8 Euro3	259	352	09/04	>				S 8137 RH
inner / interno	Iveco Cursor8 Euro3	259	352	09/04	>			S 7649 A	
prefilter / prefiltro	Iveco Cursor8 Euro3	259	352	09/04	>		S 0999 NR		
prefilter RACOR / prefiltro RACOR	Iveco Cursor8 Euro3	259	352	09/04	>				S 4470 NR
power steering / servosterzo	Iveco Cursor8 Euro3	259	352	09/04	>				S 3081 PO
Citelis									
10.5 m	Iveco Cursor8 F2B	180	245	04/05	>	S 3288 R	S 4396 NR	S 7575 A	
with automatic gearbox ZF HP500 / con cambio automatico ZF HP500	Iveco Cursor8 F2B	180	245	04/05	>				S 2234 Z
with air-conditioner WEBASTO Aerosphere / con climatizzatore WEBASTO Aerosphere	Iveco Cursor8 F2B	180	245	04/05	>				S 3081 C
dryer filter / filtro essiccatore	Iveco Cursor8 F2B	180	245	04/05	>				S 7259 A
VGT filter / filtro VGT	Iveco Cursor8 F2B	180	245	04/05	>				S 0VGT A
prefilter / prefiltro	Iveco Cursor8 F2B	180	245	04/05	>		S 1999 NR		
power steering / servosterzo	Iveco Cursor8 F2B	180	245	04/05	>				S 3081 PO
10.5 m CNG	Iveco Cursor8 F2B CNG	228	310	04/05	>	S 3288 R		S 7575 A	
with automatic gearbox ZF HP500 / con cambio automatico ZF HP500	Iveco Cursor8 F2B CNG	228	310	04/05	>				S 2234 Z
with air-conditioner WEBASTO Aerosphere / con climatizzatore WEBASTO Aerosphere	Iveco Cursor8 F2B CNG	228	310	04/05	>				S 3081 C
dryer filter / filtro essiccatore	Iveco Cursor8 F2B CNG	228	310	04/05	>				S 7259 A
dryer filter WABCO, filetto destro / filtro essiccatore WABCO, filetto destro	Iveco Cursor8 F2B CNG	228	310	04/05	>				S 7A66 A
VGT filter / filtro VGT	Iveco Cursor8 F2B CNG	228	310	04/05	>				S 0VGT A
power steering / servosterzo	Iveco Cursor8 F2B CNG	228	310	04/05	>				S 3081 PO
12 m	Iveco Cursor8 Euro4/5/EEV	180	245	09/06	>	S 3288 R	S 4396 NR	S 7627 A	
additional WEBASTO / addizionale WEBASTO	Iveco Cursor8 Euro4/5/EEV	180	245	09/06	>		S 4323 NR		
some / alcuni	Iveco Cursor8 Euro4/5/EEV	180	245	09/09	>			S 7A09 A	
with automatic gearbox ZF HP592 / con cambio automatico ZF HP592	Iveco Cursor8 Euro4/5/EEV	180	245	09/06	>				S 2234 Z
with air-conditioner WEBASTO Aerosphere / con climatizzatore WEBASTO Aerosphere	Iveco Cursor8 Euro4/5/EEV	180	245	09/06	>				S 3081 C
with filter Urea/Adblue / con filtro Urea/Adblue	Iveco Cursor8 Euro4/5/EEV	180	245	09/06	>				S 4401 U
dryer filter / filtro essiccatore	Iveco Cursor8 Euro4/5/EEV	180	245	09/06	>				S 7259 A
VGT filter / filtro VGT	Iveco Cursor8 Euro4/5/EEV	180	245	09/06	>				S 0VGT A
prefilter / prefiltro	Iveco Cursor8 Euro4/5/EEV	180	245	09/06	>		S 1999 NR		
power steering / servosterzo	Iveco Cursor8 Euro4/5/EEV	180	245	09/06	>				S 3081 PO
12 m	Iveco Cursor8 Euro4/5/EEV	243	330	09/06	>	S 3288 R	S 4396 NR	S 7637 A	
additional WEBASTO / addizionale WEBASTO	Iveco Cursor8 Euro4/5/EEV	243	330	09/06	>		S 4323 NR		
some / alcuni	Iveco Cursor8 Euro4/5/EEV	243	330	09/09	>			S 7A09 A	
with automatic gearbox ZF HP592 / con cambio automatico ZF HP592	Iveco Cursor8 Euro4/5/EEV	243	330	09/06	>				S 2234 Z
with air-conditioner WEBASTO Aerosphere / con climatizzatore WEBASTO Aerosphere	Iveco Cursor8 Euro4/5/EEV	243	330	09/06	>				S 3081 C
with filter Urea/Adblue / con filtro Urea/Adblue	Iveco Cursor8 Euro4/5/EEV	243	330	09/06	>				S 4401 U
dryer filter / filtro essiccatore	Iveco Cursor8 Euro4/5/EEV	243	330	09/06	>				S 7259 A
VGT filter / filtro VGT	Iveco Cursor8 Euro4/5/EEV	243	330	09/06	>				S 0VGT A
prefilter / prefiltro	Iveco Cursor8 Euro4/5/EEV	243	330	09/06	>		S 1999 NR		
power steering / servosterzo	Iveco Cursor8 Euro4/5/EEV	243	330	09/06	>				S 3081 PO
12 m	Iveco Cursor8 Euro4/5/EEV	279	380	09/06	>	S 3288 R	S 4396 NR	S 7637 A	
additional WEBASTO / addizionale WEBASTO	Iveco Cursor8 Euro4/5/EEV	279	380	09/06	>		S 4323 NR		
some / alcuni	Iveco Cursor8 Euro4/5/EEV	279	380	09/09	>			S 7A09 A	

**KW HP****...IRISBUS - buses/autobus**

with automatic gearbox ZF HP592 / con cambio automatico ZF HP592	Iveco Cursor8 Euro4/5/EEV	279	380	09/06	>				S 2234 Z
with air-conditioner WEBASTO Aerosphere / con climatizzatore WEBASTO Aerosphere	Iveco Cursor8 Euro4/5/EEV	279	380	09/06	>				S 3081 C
with filter Urea/Adblue / con filtro Urea/Adblue	Iveco Cursor8 Euro4/5/EEV	279	380	09/06	>				S 4401 U
dryer filter / filtro essiccatore	Iveco Cursor8 Euro4/5/EEV	279	380	09/06	>				S 7259 A
VGT filter / filtro VGT	Iveco Cursor8 Euro4/5/EEV	279	380	09/06	>				S 0VGT A
prefilter / prefiltra	Iveco Cursor8 Euro4/5/EEV	279	380	09/06	>		S 1999 NR		
power steering / servosterzo	Iveco Cursor8 Euro4/5/EEV	279	380	09/06	>				S 3081 PO
12 m	Iveco Cursor8 F2B	180	245	04/05	>	S 3288 R	S 4396 NR	S 7575 A	
with automatic gearbox ZF HP500 / con cambio automatico ZF HP500	Iveco Cursor8 F2B	180	245	04/05	>				S 2234 Z
with air-conditioner WEBASTO Aerosphere / con climatizzatore WEBASTO Aerosphere	Iveco Cursor8 F2B	180	245	04/05	>				S 3081 C
dryer filter / filtro essiccatore	Iveco Cursor8 F2B	180	245	04/05	>				S 7259 A
dryer filter WABCO, right-hand thread / filtro essiccatore WABCO, filetto destro	Iveco Cursor8 F2B	180	245	04/05	>				S 7A66 A
VGT filter / filtro VGT	Iveco Cursor8 F2B	180	245	04/05	>				S 0VGT A
prefilter / prefiltra	Iveco Cursor8 F2B	180	245	04/05	>		S 1999 NR		
power steering / servosterzo	Iveco Cursor8 F2B	180	245	04/05	>				S 3081 PO
12 m	Iveco Cursor8 F2B	213	290	04/05	>	S 3288 R	S 4396 NR	S 7575 A	
with automatic gearbox ZF HP500 / con cambio automatico ZF HP500	Iveco Cursor8 F2B	213	290	04/05	>				S 2234 Z
with air-conditioner WEBASTO Aerosphere / con climatizzatore WEBASTO Aerosphere	Iveco Cursor8 F2B	213	290	04/05	>				S 3081 C
dryer filter / filtro essiccatore	Iveco Cursor8 F2B	213	290	04/05	>				S 7259 A
VGT filter / filtro VGT	Iveco Cursor8 F2B	213	290	04/05	>				S 0VGT A
prefilter / prefiltra	Iveco Cursor8 F2B	213	290	04/05	>		S 1999 NR		
power steering / servosterzo	Iveco Cursor8 F2B	213	290	04/05	>				S 3081 PO
12 m CNG	Iveco Cursor8 F2B CNG	154	210	04/05	>	S 3288 R		S 7575 A	
with automatic gearbox / con cambio automatico	Iveco Cursor8 F2B CNG	154	210	04/05	>				S 2234 Z
with air-conditioner WEBASTO Aerosphere / con climatizzatore WEBASTO Aerosphere	Iveco Cursor8 F2B CNG	154	210	04/05	>				S 3081 C
dryer filter / filtro essiccatore	Iveco Cursor8 F2B CNG	154	210	04/05	>				S 7259 A
VGT filter / filtro VGT	Iveco Cursor8 F2B CNG	154	210	04/05	>				S 0VGT A
power steering / servosterzo	Iveco Cursor8 F2B CNG	154	210	04/05	>				S 3081 PO
12 m CNG	Iveco Cursor8 F2B CNG	200	272	04/05	>	S 3288 R		S 7575 A	
with automatic gearbox ZF HP500 / con cambio automatico ZF HP500	Iveco Cursor8 F2B CNG	200	272	04/05	>				S 2234 Z
with air-conditioner WEBASTO Aerosphere / con climatizzatore WEBASTO Aerosphere	Iveco Cursor8 F2B CNG	200	272	04/05	>				S 3081 C
dryer filter / filtro essiccatore	Iveco Cursor8 F2B CNG	200	272	04/05	>				S 7259 A
VGT filter / filtro VGT	Iveco Cursor8 F2B CNG	200	272	04/05	>				S 0VGT A
power steering / servosterzo	Iveco Cursor8 F2B CNG	200	272	04/05	>				S 3081 PO
12 m CNG	Iveco Cursor8 F2B CNG	228	310	04/05	>	S 3288 R		S 7575 A	
with automatic gearbox ZF HP500 / con cambio automatico ZF HP500	Iveco Cursor8 F2B CNG	228	310	04/05	>				S 2234 Z
with air-conditioner WEBASTO Aerosphere / con climatizzatore WEBASTO Aerosphere	Iveco Cursor8 F2B CNG	228	310	04/05	>				S 3081 C
dryer filter / filtro essiccatore	Iveco Cursor8 F2B CNG	228	310	04/05	>				S 7259 A
dryer filter WABCO, right-hand thread / filtro essiccatore WABCO, filetto destro	Iveco Cursor8 F2B CNG	228	310	04/05	>				S 7A66 A
VGT filter / filtro VGT	Iveco Cursor8 F2B CNG	228	310	04/05	>				S 0VGT A
power steering / servosterzo	Iveco Cursor8 F2B CNG	228	310	04/05	>				S 3081 PO
18 m	Iveco Cursor8 Euro4/5/EEV	243	330	09/06	>	S 3288 R	S 4396 NR	S 7637 A	
additional WEBASTO / addizionale WEBASTO	Iveco Cursor8 Euro4/5/EEV	243	330	09/06	>		S 4323 NR		
some / alcuni	Iveco Cursor8 Euro4/5/EEV	243	330	09/09	>			S 7A09 A	
with automatic gearbox ZF HP592 / con cambio automatico ZF HP592	Iveco Cursor8 Euro4/5/EEV	243	330	09/06	>				S 2234 Z
with air-conditioner WEBASTO Aerosphere / con climatizzatore WEBASTO Aerosphere	Iveco Cursor8 Euro4/5/EEV	243	330	09/06	>				S 3081 C
with filter Urea/Adblue / con filtro Urea/Adblue	Iveco Cursor8 Euro4/5/EEV	243	330	09/06	>				S 4401 U
dryer filter / filtro essiccatore	Iveco Cursor8 Euro4/5/EEV	243	330	09/06	>				S 7259 A
VGT filter / filtro VGT	Iveco Cursor8 Euro4/5/EEV	243	330	09/06	>				S 0VGT A
prefilter / prefiltra	Iveco Cursor8 Euro4/5/EEV	243	330	09/06	>		S 1999 NR		
power steering / servosterzo	Iveco Cursor8 Euro4/5/EEV	243	330	09/06	>				S 3081 PO
18 m	Iveco Cursor8 Euro4/5/EEV	279	380	09/06	>	S 3288 R	S 4396 NR	S 7637 A	
additional WEBASTO / addizionale WEBASTO	Iveco Cursor8 Euro4/5/EEV	279	380	09/06	>		S 4323 NR		
some / alcuni	Iveco Cursor8 Euro4/5/EEV	279	380	09/09	>			S 7A09 A	
with automatic gearbox ZF HP592 / con cambio automatico ZF HP592	Iveco Cursor8 Euro4/5/EEV	279	380	09/06	>				S 2234 Z
with air-conditioner WEBASTO Aerosphere / con climatizzatore WEBASTO Aerosphere	Iveco Cursor8 Euro4/5/EEV	279	380	09/06	>				S 3081 C
with filter Urea/Adblue / con filtro Urea/Adblue	Iveco Cursor8 Euro4/5/EEV	279	380	09/06	>				S 4401 U
dryer filter / filtro essiccatore	Iveco Cursor8 Euro4/5/EEV	279	380	09/06	>				S 7259 A
VGT filter / filtro VGT	Iveco Cursor8 Euro4/5/EEV	279	380	09/06	>				S 0VGT A
prefilter / prefiltra	Iveco Cursor8 Euro4/5/EEV	279	380	09/06	>		S 1999 NR		
power steering / servosterzo	Iveco Cursor8 Euro4/5/EEV	279	380	09/06	>				S 3081 PO
18 m	Iveco Cursor8 F2B	213	290	04/05	>	S 3288 R	S 4396 NR	S 7575 A	
with automatic gearbox ZF HP500 / con cambio automatico ZF HP500	Iveco Cursor8 F2B	213	290	04/05	>				S 2234 Z
with air-conditioner WEBASTO Aerosphere / con climatizzatore WEBASTO Aerosphere	Iveco Cursor8 F2B	213	290	04/05	>				S 3081 C
dryer filter / filtro essiccatore	Iveco Cursor8 F2B	213	290	04/05	>				S 7259 A
VGT filter / filtro VGT	Iveco Cursor8 F2B	213	290	04/05	>				S 0VGT A
prefilter / prefiltra	Iveco Cursor8 F2B	213	290	04/05	>		S 1999 NR		



**KW HP****...IRISBUS - buses/autobus**

power steering / servosterzo	Iveco Cursor8 F2B	213	290	04/05	>				S 3081 PO
18 m CNG	Iveco Cursor8 F2B CNG	200	272	04/05	>	S 3288 R		S 7575 A	
with automatic gearbox ZF HP500 / con cambio automatico ZF HP500	Iveco Cursor8 F2B CNG	200	272	04/05	>				S 2234 Z
with air-conditioner WEBASTO Aerosphere / con climatizzatore WEBASTO Aerosphere	Iveco Cursor8 F2B CNG	200	272	04/05	>				S 3081 C
dryer filter / filtro essiccatore	Iveco Cursor8 F2B CNG	200	272	04/05	>				S 7259 A
VGT filter / filtro VGT	Iveco Cursor8 F2B CNG	200	272	04/05	>				S 0VGT A
power steering / servosterzo	Iveco Cursor8 F2B CNG	200	272	04/05	>				S 3081 PO
18 m CNG	Iveco Cursor8 F2B CNG	228	310	04/05	>	S 3288 R		S 7575 A	
with automatic gearbox ZF HP500 / con cambio automatico ZF HP500	Iveco Cursor8 F2B CNG	228	310	04/05	>				S 2234 Z
with air-conditioner WEBASTO Aerosphere / con climatizzatore WEBASTO Aerosphere	Iveco Cursor8 F2B CNG	228	310	04/05	>				S 3081 C
dryer filter / filtro essiccatore	Iveco Cursor8 F2B CNG	228	310	04/05	>				S 7259 A
dryer filter WABCO, right-hand thread / filtro essiccatore WABCO, filetto destro	Iveco Cursor8 F2B CNG	228	310	04/05	>				S 7A66 A
VGT filter / filtro VGT	Iveco Cursor8 F2B CNG	228	310	04/05	>				S 0VGT A
power steering / servosterzo	Iveco Cursor8 F2B CNG	228	310	04/05	>				S 3081 PO

CityClass

10.8 m	Cursor 8	180	245	01/02	>	S 3288 R	S 4396 NR	S 7637 A	
with automatic gearbox ZF HP592 / con cambio automatico ZF HP592	Cursor 8	180	245	01/02	>				S 2234 Z
with air-conditioner WEBASTO Aerosphere / con climatizzatore WEBASTO Aerosphere	Cursor 8	180	245	01/02	>				S 3081 C
dryer filter / filtro essiccatore	Cursor 8	180	245	01/02	>				S 7259 A
dryer filter WABCO, right-hand thread / filtro essiccatore WABCO, filetto destro	Cursor 8	180	245	01/02	>				S 7A66 A
VGT filter / filtro VGT	Cursor 8	180	245	01/02	>				S 0VGT A
hydrostatic steering / guida idrostatica	Cursor 8	180	245	01/02	>				S 8137 RH
inner / interno	Cursor 8	180	245	01/02	>			S 7649 A	
prefilter / prefiltrato	Cursor 8	180	245	01/02	>		S 0999 NR		
power steering / servosterzo	Cursor 8	180	245	01/02	>				S 3081 PO
12 m	Cursor 8	213	290	01/02	>	S 3288 R	S 4396 NR	S 7637 A	
with automatic gearbox ZF HP592 / con cambio automatico ZF HP592	Cursor 8	213	290	01/02	>				S 2234 Z
with air-conditioner WEBASTO Aerosphere / con climatizzatore WEBASTO Aerosphere	Cursor 8	213	290	01/02	>				S 3081 C
dryer filter / filtro essiccatore	Cursor 8	213	290	01/02	>				S 7259 A
dryer filter WABCO, right-hand thread / filtro essiccatore WABCO, filetto destro	Cursor 8	213	290	01/02	>				S 7A66 A
VGT filter / filtro VGT	Cursor 8	213	290	01/02	>				S 0VGT A
hydrostatic steering / guida idrostatica	Cursor 8	213	290	01/02	>				S 8137 RH
inner / interno	Cursor 8	213	290	01/02	>			S 7649 A	
prefilter / prefiltrato	Cursor 8	213	290	01/02	>		S 0999 NR		
power steering / servosterzo	Cursor 8	213	290	01/02	>				S 3081 PO
18 m	Cursor 8	257	350	01/02	>	S 3288 R	S 4396 NR	S 7637 A	
with automatic gearbox ZF HP592 / con cambio automatico ZF HP592	Cursor 8	257	350	01/02	>				S 2234 Z
with air-conditioner WEBASTO Aerosphere / con climatizzatore WEBASTO Aerosphere	Cursor 8	257	350	01/02	>				S 3081 C
dryer filter / filtro essiccatore	Cursor 8	257	350	01/02	>				S 7259 A
dryer filter WABCO, right-hand thread / filtro essiccatore WABCO, filetto destro	Cursor 8	257	350	01/02	>				S 7A66 A
VGT filter / filtro VGT	Cursor 8	257	350	01/02	>				S 0VGT A
hydrostatic steering / guida idrostatica	Cursor 8	257	350	01/02	>				S 8137 RH
inner / interno	Cursor 8	257	350	01/02	>			S 7649 A	
prefilter / prefiltrato	Cursor 8	257	350	01/02	>		S 0999 NR		
power steering / servosterzo	Cursor 8	257	350	01/02	>				S 3081 PO

Civis

Civis	Iveco Cursor8			05/01	>	S 3288 R	S 4396 NR		
with automatic gearbox ZF HP500/5HP502 / con cambio automatico ZF HP500/5HP502	Iveco Cursor8			05/01	>				S 2234 Z
dryer filter / filtro essiccatore	Iveco Cursor8			05/01	>				S 7259 A
VGT filter / filtro VGT	Iveco Cursor8			05/01	>				S 0VGT A
prefilter / prefiltrato	Iveco Cursor8			05/01	>		S 0999 NR		
power steering / servosterzo	Iveco Cursor8			05/01	>				S 3081 PO

Crealis

12 m	Iveco Cursor8 F2B Euro4/5/EEV	180	245	09/08	>	S 3288 R	S 4396 NR	S 7627 A	
additional WEBASTO / addizionale WEBASTO	Iveco Cursor8 F2B Euro4/5/EEV	180	245	09/08	>				S 4323 NR
with automatic gearbox ZF HP592 / con cambio automatico ZF HP592	Iveco Cursor8 F2B Euro4/5/EEV	180	245	09/08	>				S 2234 Z
with air-conditioner WEBASTO Aerosphere / con climatizzatore WEBASTO Aerosphere	Iveco Cursor8 F2B Euro4/5/EEV	180	245	09/08	>				S 3081 C
with filter Urea/Adblue Denoxtronic 1 / con filtro Urea/Adblue Denoxtronic 1	Iveco Cursor8 F2B Euro4/5/EEV	180	245	09/08	>				S 4401 U
with filter Urea/Adblue Denoxtronic 2 / con filtro Urea/Adblue Denoxtronic 2	Iveco Cursor8 F2B Euro4/5/EEV	180	245	09/08	>				S 4402 U
dryer filter / filtro essiccatore	Iveco Cursor8 F2B Euro4/5/EEV	180	245	09/08	>				S 7259 A
dryer filter WABCO, right-hand thread / filtro essiccatore WABCO, filetto destro	Iveco Cursor8 F2B Euro4/5/EEV	180	245	09/08	>				S 7A66 A
VGT filter / filtro VGT	Iveco Cursor8 F2B Euro4/5/EEV	180	245	09/08	>				S 0VGT A
prefilter / prefiltrato	Iveco Cursor8 F2B Euro4/5/EEV	180	245	09/08	>		S 1999 NR		
power steering / servosterzo	Iveco Cursor8 F2B Euro4/5/EEV	180	245	09/08	>				S 3081 PO
12 m	Iveco Cursor8 F2B Euro4/5/EEV	213	290	09/08	>	S 3288 R	S 4396 NR	S 7627 A	
additional WEBASTO / addizionale WEBASTO	Iveco Cursor8 F2B Euro4/5/EEV	213	290	09/08	>				S 4323 NR
with automatic gearbox ZF HP592 / con cambio automatico ZF HP592	Iveco Cursor8 F2B Euro4/5/EEV	213	290	09/08	>				S 2234 Z

**KW HP**

...IRISBUS - buses/autobus

with air-conditioner WEBASTO Aerosphere / con climatizzatore WEBASTO Aerosphere	Iveco Cursor8 F2B Euro4/5/EEV	213	290	09/08	>			S 3081 C
with filter Urea/Adblue Denoxtronic 1 / con filtro Urea/Adblue Denoxtronic 1	Iveco Cursor8 F2B Euro4/5/EEV	213	290	09/08	>			S 4401 U
with filter Urea/Adblue Denoxtronic 2 / con filtro Urea/Adblue Denoxtronic 2	Iveco Cursor8 F2B Euro4/5/EEV	213	290	09/08	>			S 4402 U
dryer filter / filtro essiccatore	Iveco Cursor8 F2B Euro4/5/EEV	213	290	09/08	>			S 7259 A
dryer filter WABCO, right-hand thread / filtro essiccatore WABCO, filetto destro	Iveco Cursor8 F2B Euro4/5/EEV	213	290	09/08	>			S 7A66 A
VGT filter / filtro VGT	Iveco Cursor8 F2B Euro4/5/EEV	213	290	09/08	>			S 0VGT A
prefilter / prefiltrato	Iveco Cursor8 F2B Euro4/5/EEV	213	290	09/08	>		S 1999 NR	
power steering / servosterzo	Iveco Cursor8 F2B Euro4/5/EEV	213	290	09/08	>			S 3081 PO
12 m CNG/Metano	Iveco Cursor8 F2G EEV	180	245	09/08	>	S 3288 R		S 7627 A
with automatic gearbox VOITH D651.3 / con cambio automatico VOITH D651.3	Iveco Cursor8 F2G EEV	180	245	09/08	>			S 5663 PO
with automatic gearbox ZF HP500 / con cambio automatico ZF HP500	Iveco Cursor8 F2G EEV	180	245	09/08	>			S 2234 Z
with air-conditioner WEBASTO Aerosphere / con climatizzatore WEBASTO Aerosphere	Iveco Cursor8 F2G EEV	180	245	09/08	>			S 3081 C
dryer filter / filtro essiccatore	Iveco Cursor8 F2G EEV	180	245	09/08	>			S 7259 A
dryer filter WABCO, right-hand thread / filtro essiccatore WABCO, filetto destro	Iveco Cursor8 F2G EEV	180	245	09/08	>			S 7A66 A
VGT filter / filtro VGT	Iveco Cursor8 F2G EEV	180	245	09/08	>			S 0VGT A
power steering / servosterzo	Iveco Cursor8 F2G EEV	180	245	09/08	>			S 3081 PO
12 m CNG/Metano	Iveco Cursor8 F2G EEV	213	290	09/08	>	S 3288 R		S 7627 A
with automatic gearbox VOITH D651.3 / con cambio automatico VOITH D651.3	Iveco Cursor8 F2G EEV	213	290	09/08	>			S 5663 PO
with automatic gearbox ZF HP500 / con cambio automatico ZF HP500	Iveco Cursor8 F2G EEV	213	290	09/08	>			S 2234 Z
with air-conditioner WEBASTO Aerosphere / con climatizzatore WEBASTO Aerosphere	Iveco Cursor8 F2G EEV	213	290	09/08	>			S 3081 C
dryer filter / filtro essiccatore	Iveco Cursor8 F2G EEV	213	290	09/08	>			S 7259 A
dryer filter WABCO, right-hand thread / filtro essiccatore WABCO, filetto destro	Iveco Cursor8 F2G EEV	213	290	09/08	>			S 7A66 A
VGT filter / filtro VGT	Iveco Cursor8 F2G EEV	213	290	09/08	>			S 0VGT A
power steering / servosterzo	Iveco Cursor8 F2G EEV	213	290	09/08	>			S 3081 PO
18 m	Iveco Cursor8 F2B Euro4/5/EEV	213	290	09/08	>	S 3288 R	S 4396 NR	S 7627 A
additional WEBASTO / addizionale WEBASTO	Iveco Cursor8 F2B Euro4/5/EEV	213	290	09/08	>			S 4323 NR
with automatic gearbox ZF HP592 / con cambio automatico ZF HP592	Iveco Cursor8 F2B Euro4/5/EEV	213	290	09/08	>			S 2234 Z
with air-conditioner WEBASTO Aerosphere / con climatizzatore WEBASTO Aerosphere	Iveco Cursor8 F2B Euro4/5/EEV	213	290	09/08	>			S 3081 C
with filter Urea/Adblue Denoxtronic 1 / con filtro Urea/Adblue Denoxtronic 1	Iveco Cursor8 F2B Euro4/5/EEV	213	290	09/08	>			S 4401 U
with filter Urea/Adblue Denoxtronic 2 / con filtro Urea/Adblue Denoxtronic 2	Iveco Cursor8 F2B Euro4/5/EEV	213	290	09/08	>			S 4402 U
dryer filter / filtro essiccatore	Iveco Cursor8 F2B Euro4/5/EEV	213	290	09/08	>			S 7259 A
dryer filter WABCO, right-hand thread / filtro essiccatore WABCO, filetto destro	Iveco Cursor8 F2B Euro4/5/EEV	213	290	09/08	>			S 7A66 A
VGT filter / filtro VGT	Iveco Cursor8 F2B Euro4/5/EEV	213	290	09/08	>			S 0VGT A
prefilter / prefiltrato	Iveco Cursor8 F2B Euro4/5/EEV	213	290	09/08	>		S 1999 NR	
power steering / servosterzo	Iveco Cursor8 F2B Euro4/5/EEV	213	290	09/08	>			S 3081 PO
18 m	Iveco Cursor8 F2B Euro4/5/EEV	279	380	09/08	>	S 3288 R	S 4396 NR	S 7627 A
additional WEBASTO / addizionale WEBASTO	Iveco Cursor8 F2B Euro4/5/EEV	279	380	09/08	>			S 4323 NR
with automatic gearbox ZF HP592 / con cambio automatico ZF HP592	Iveco Cursor8 F2B Euro4/5/EEV	279	380	09/08	>			S 2234 Z
with air-conditioner WEBASTO Aerosphere / con climatizzatore WEBASTO Aerosphere	Iveco Cursor8 F2B Euro4/5/EEV	279	380	09/08	>			S 3081 C
with filter Urea/Adblue Denoxtronic 1 / con filtro Urea/Adblue Denoxtronic 1	Iveco Cursor8 F2B Euro4/5/EEV	279	380	09/08	>			S 4401 U
with filter Urea/Adblue Denoxtronic 2 / con filtro Urea/Adblue Denoxtronic 2	Iveco Cursor8 F2B Euro4/5/EEV	279	380	09/08	>			S 4402 U
dryer filter / filtro essiccatore	Iveco Cursor8 F2B Euro4/5/EEV	279	380	09/08	>			S 7259 A
dryer filter WABCO, right-hand thread / filtro essiccatore WABCO, filetto destro	Iveco Cursor8 F2B Euro4/5/EEV	279	380	09/08	>			S 7A66 A
VGT filter / filtro VGT	Iveco Cursor8 F2B Euro4/5/EEV	279	380	09/08	>			S 0VGT A
prefilter / prefiltrato	Iveco Cursor8 F2B Euro4/5/EEV	279	380	09/08	>		S 1999 NR	
power steering / servosterzo	Iveco Cursor8 F2B Euro4/5/EEV	279	380	09/08	>			S 3081 PO
18 m CNG/Metano	Iveco Cursor8 F2G EEV	213	290	09/08	>	S 3288 R		S 7627 A
with automatic gearbox VOITH D651.3 / con cambio automatico VOITH D651.3	Iveco Cursor8 F2G EEV	213	290	09/08	>			S 5663 PO
with automatic gearbox ZF HP500 / con cambio automatico ZF HP500	Iveco Cursor8 F2G EEV	213	290	09/08	>			S 2234 Z
with air-conditioner WEBASTO Aerosphere / con climatizzatore WEBASTO Aerosphere	Iveco Cursor8 F2G EEV	213	290	09/08	>			S 3081 C
dryer filter / filtro essiccatore	Iveco Cursor8 F2G EEV	213	290	09/08	>			S 7259 A
dryer filter WABCO, right-hand thread / filtro essiccatore WABCO, filetto destro	Iveco Cursor8 F2G EEV	213	290	09/08	>			S 7A66 A
VGT filter / filtro VGT	Iveco Cursor8 F2G EEV	213	290	09/08	>			S 0VGT A
power steering / servosterzo	Iveco Cursor8 F2G EEV	213	290	09/08	>			S 3081 PO
18 m CNG/Metano	Iveco Cursor8 F2G EEV	243	330	09/08	>	S 3288 R		S 7627 A
with automatic gearbox VOITH D651.3 / con cambio automatico VOITH D651.3	Iveco Cursor8 F2G EEV	243	330	09/08	>			S 5663 PO
with automatic gearbox ZF HP500 / con cambio automatico ZF HP500	Iveco Cursor8 F2G EEV	243	330	09/08	>			S 2234 Z
with air-conditioner WEBASTO Aerosphere / con climatizzatore WEBASTO Aerosphere	Iveco Cursor8 F2G EEV	243	330	09/08	>			S 3081 C
dryer filter / filtro essiccatore	Iveco Cursor8 F2G EEV	243	330	09/08	>			S 7259 A
dryer filter WABCO, right-hand thread / filtro essiccatore WABCO, filetto destro	Iveco Cursor8 F2G EEV	243	330	09/08	>			S 7A66 A
VGT filter / filtro VGT	Iveco Cursor8 F2G EEV	243	330	09/08	>			S 0VGT A
power steering / servosterzo	Iveco Cursor8 F2G EEV	243	330	09/08	>			S 3081 PO
Crealis NEO								
12 m	Iveco Cursor8 F2B Euro4/5/EEV	180	245	09/08	>	S 3288 R	S 4396 NR	S 7627 A
additional WEBASTO / addizionale WEBASTO	Iveco Cursor8 F2B Euro4/5/EEV	180	245	09/08	>			S 4323 NR
with automatic gearbox ZF HP592 / con cambio automatico ZF HP592	Iveco Cursor8 F2B Euro4/5/EEV	180	245	09/08	>			S 2234 Z
with air-conditioner WEBASTO Aerosphere / con climatizzatore WEBASTO Aerosphere	Iveco Cursor8 F2B Euro4/5/EEV	180	245	09/08	>			S 3081 C



**KW HP**

...IRISBUS - buses/autobus

with air-conditioner WEBASTO Aerosphere / con climatizzatore WEBASTO Aerosphere	Iveco Cursor8 F2G EEV	243	330	09/08	>				S 3081 C
dryer filter / filtro essiccatore	Iveco Cursor8 F2G EEV	243	330	09/08	>				S 7259 A
dryer filter WABCO, right-hand thread / filtro essiccatore WABCO, filetto destro	Iveco Cursor8 F2G EEV	243	330	09/08	>				S 7A66 A
VGT filter / filtro VGT	Iveco Cursor8 F2G EEV	243	330	09/08	>				S 0VGT A
power steering / servosterzo	Iveco Cursor8 F2G EEV	243	330	09/08	>				S 3081 PO
Crossway									
12 m	Iveco Cursor8 Euro4	243	330	06/06	>	S 3288 R	S 4396 NR	S 7A11 A	
additional WEBASTO / addizionale WEBASTO	Iveco Cursor8 Euro4	243	330	06/06	>		S 4323 NR		
with filter Urea/Adblue / con filtro Urea/Adblue	Iveco Cursor8 Euro4	243	330	06/06	>				S 4401 U
dryer filter / filtro essiccatore	Iveco Cursor8 Euro4	243	330	06/06	>				S 7259 A
VGT filter / filtro VGT	Iveco Cursor8 Euro4	243	330	06/06	>				S 0VGT A
prefilter / prefiltro	Iveco Cursor8 Euro4	243	330	06/06	>		S 1999 NR		
power steering / servosterzo	Iveco Cursor8 Euro4	243	330	06/06	>				S 3081 PO
12 m	Iveco Tector6 Euro4	194	264	06/06	>	S 0620 R	S 2220 NR	S 7A11 A	
additional WEBASTO / addizionale WEBASTO	Iveco Tector6 Euro4	194	264	06/06	>		S 4323 NR		
with filter Urea/Adblue / con filtro Urea/Adblue	Iveco Tector6 Euro4	194	264	06/06	>				S 4401 U
dryer filter / filtro essiccatore	Iveco Tector6 Euro4	194	264	06/06	>				S 7259 A
power steering / servosterzo	Iveco Tector6 Euro4	194	264	06/06	>				S 3081 PO
12 m	Iveco Tector6 Euro4	220	299	06/06	>	S 0620 R	S 2220 NR	S 7A11 A	
additional WEBASTO / addizionale WEBASTO	Iveco Tector6 Euro4	220	299	06/06	>		S 4323 NR		
with filter Urea/Adblue / con filtro Urea/Adblue	Iveco Tector6 Euro4	220	299	06/06	>				S 4401 U
dryer filter / filtro essiccatore	Iveco Tector6 Euro4	220	299	06/06	>				S 7259 A
power steering / servosterzo	Iveco Tector6 Euro4	220	299	06/06	>				S 3081 PO
12.8 m	Iveco Cursor8 Euro4	243	330	06/06	>	S 3288 R	S 4396 NR	S 7A11 A	
additional WEBASTO / addizionale WEBASTO	Iveco Cursor8 Euro4	243	330	06/06	>		S 4323 NR		
with filter Urea/Adblue / con filtro Urea/Adblue	Iveco Cursor8 Euro4	243	330	06/06	>				S 4401 U
dryer filter / filtro essiccatore	Iveco Cursor8 Euro4	243	330	06/06	>				S 7259 A
VGT filter / filtro VGT	Iveco Cursor8 Euro4	243	330	06/06	>				S 0VGT A
prefilter / prefiltro	Iveco Cursor8 Euro4	243	330	06/06	>		S 1999 NR		
power steering / servosterzo	Iveco Cursor8 Euro4	243	330	06/06	>				S 3081 PO
12.8 m	Iveco Tector6 Euro4	194	264	06/06	>	S 0620 R	S 2220 NR	S 7A11 A	
additional WEBASTO / addizionale WEBASTO	Iveco Tector6 Euro4	194	264	06/06	>		S 4323 NR		
with filter Urea/Adblue / con filtro Urea/Adblue	Iveco Tector6 Euro4	194	264	06/06	>				S 4401 U
dryer filter / filtro essiccatore	Iveco Tector6 Euro4	194	264	06/06	>				S 7259 A
power steering / servosterzo	Iveco Tector6 Euro4	194	264	06/06	>				S 3081 PO
12.8 m	Iveco Tector6 Euro4	220	299	06/06	>	S 0620 R	S 2220 NR	S 7A11 A	
additional WEBASTO / addizionale WEBASTO	Iveco Tector6 Euro4	220	299	06/06	>		S 4323 NR		
with filter Urea/Adblue / con filtro Urea/Adblue	Iveco Tector6 Euro4	220	299	06/06	>				S 4401 U
dryer filter / filtro essiccatore	Iveco Tector6 Euro4	220	299	06/06	>				S 7259 A
power steering / servosterzo	Iveco Tector6 Euro4	220	299	06/06	>				S 3081 PO
Crossway LE									
10.6 m	Iveco Cursor8 Euro4	243	330	05/07	>	S 3288 R	S 4396 NR	S 7A11 A	
additional WEBASTO / addizionale WEBASTO	Iveco Cursor8 Euro4	243	330	05/07	>		S 4323 NR		
with filter Urea/Adblue / con filtro Urea/Adblue	Iveco Cursor8 Euro4	243	330	05/07	>				S 4401 U
dryer filter / filtro essiccatore	Iveco Cursor8 Euro4	243	330	05/07	>				S 7259 A
VGT filter / filtro VGT	Iveco Cursor8 Euro4	243	330	05/07	>				S 0VGT A
prefilter / prefiltro	Iveco Cursor8 Euro4	243	330	05/07	>		S 1999 NR		
power steering / servosterzo	Iveco Cursor8 Euro4	243	330	05/07	>				S 3081 PO
10.6 m	Iveco Tector6 Euro4	194	264	05/07	>	S 0620 R	S 2220 NR	S 7A11 A	
additional WEBASTO / addizionale WEBASTO	Iveco Tector6 Euro4	194	264	05/07	>		S 4323 NR		
with filter Urea/Adblue / con filtro Urea/Adblue	Iveco Tector6 Euro4	194	264	05/07	>				S 4401 U
dryer filter / filtro essiccatore	Iveco Tector6 Euro4	194	264	05/07	>				S 7259 A
power steering / servosterzo	Iveco Tector6 Euro4	194	264	05/07	>				S 3081 PO
10.6 m	Iveco Tector6 Euro4	220	299	05/07	>	S 0620 R	S 2220 NR	S 7A11 A	
additional WEBASTO / addizionale WEBASTO	Iveco Tector6 Euro4	220	299	05/07	>		S 4323 NR		
with filter Urea/Adblue / con filtro Urea/Adblue	Iveco Tector6 Euro4	220	299	05/07	>				S 4401 U
dryer filter / filtro essiccatore	Iveco Tector6 Euro4	220	299	05/07	>				S 7259 A
power steering / servosterzo	Iveco Tector6 Euro4	220	299	05/07	>				S 3081 PO
12 m	Iveco Cursor8 Euro4	243	330	05/07	>	S 3288 R	S 4396 NR	S 7A11 A	
additional WEBASTO / addizionale WEBASTO	Iveco Cursor8 Euro4	243	330	05/07	>		S 4323 NR		
with filter Urea/Adblue / con filtro Urea/Adblue	Iveco Cursor8 Euro4	243	330	05/07	>				S 4401 U
dryer filter / filtro essiccatore	Iveco Cursor8 Euro4	243	330	05/07	>				S 7259 A
VGT filter / filtro VGT	Iveco Cursor8 Euro4	243	330	05/07	>				S 0VGT A
prefilter / prefiltro	Iveco Cursor8 Euro4	243	330	05/07	>		S 1999 NR		
power steering / servosterzo	Iveco Cursor8 Euro4	243	330	05/07	>				S 3081 PO
12 m	Iveco Tector6 Euro4	194	264	05/07	>	S 0620 R	S 2220 NR	S 7A11 A	
additional WEBASTO / addizionale WEBASTO	Iveco Tector6 Euro4	194	264	05/07	>		S 4323 NR		



KW HP



...IRISBUS - buses/autobus

with filter Urea/Adblue / con filtro Urea/Adblue	Iveco Tector6 Euro4	194	264	05/07	>				S 4401 U
dryer filter / filtro essiccatore	Iveco Tector6 Euro4	194	264	05/07	>				S 7259 A
power steering / servosterzo	Iveco Tector6 Euro4	194	264	05/07	>				S 3081 PO
12 m	Iveco Tector6 Euro4	220	299	05/07	>	S 0620 R	S 2220 NR	S 7A11 A	
additional WEBASTO / addizionale WEBASTO	Iveco Tector6 Euro4	220	299	05/07	>		S 4323 NR		
with filter Urea/Adblue / con filtro Urea/Adblue	Iveco Tector6 Euro4	220	299	05/07	>				S 4401 U
dryer filter / filtro essiccatore	Iveco Tector6 Euro4	220	299	05/07	>				S 7259 A
power steering / servosterzo	Iveco Tector6 Euro4	220	299	05/07	>				S 3081 PO
12.8 m	Iveco Cursor8 Euro4	243	330	05/07	>	S 3288 R	S 4396 NR	S 7A11 A	
additional WEBASTO / addizionale WEBASTO	Iveco Cursor8 Euro4	243	330	05/07	>		S 4323 NR		
with filter Urea/Adblue / con filtro Urea/Adblue	Iveco Cursor8 Euro4	243	330	05/07	>				S 4401 U
dryer filter / filtro essiccatore	Iveco Cursor8 Euro4	243	330	05/07	>				S 7259 A
VGT filter / filtro VGT	Iveco Cursor8 Euro4	243	330	05/07	>				S 0VGT A
prefilter / prefiltra	Iveco Cursor8 Euro4	243	330	05/07	>		S 1999 NR		
power steering / servosterzo	Iveco Cursor8 Euro4	243	330	05/07	>				S 3081 PO
12.8 m	Iveco Tector6 Euro4	194	264	05/07	>	S 0620 R	S 2220 NR	S 7A11 A	
additional WEBASTO / addizionale WEBASTO	Iveco Tector6 Euro4	194	264	05/07	>		S 4323 NR		
with filter Urea/Adblue / con filtro Urea/Adblue	Iveco Tector6 Euro4	194	264	05/07	>				S 4401 U
dryer filter / filtro essiccatore	Iveco Tector6 Euro4	194	264	05/07	>				S 7259 A
power steering / servosterzo	Iveco Tector6 Euro4	194	264	05/07	>				S 3081 PO
12.8 m	Iveco Tector6 Euro4	220	299	05/07	>	S 0620 R	S 2220 NR	S 7A11 A	
additional WEBASTO / addizionale WEBASTO	Iveco Tector6 Euro4	220	299	05/07	>		S 4323 NR		
with filter Urea/Adblue / con filtro Urea/Adblue	Iveco Tector6 Euro4	220	299	05/07	>				S 4401 U
dryer filter / filtro essiccatore	Iveco Tector6 Euro4	220	299	05/07	>				S 7259 A
power steering / servosterzo	Iveco Tector6 Euro4	220	299	05/07	>				S 3081 PO
Daily S2000									
3.0 HPI	Sofim F1C Euro4	100	136	09/04	>		S 1H20 NR	S 7356 A	S 3023 C
Daily Touring									
3.0 HPT	Sofim F1C Euro4	122	166	09/04	>		S 1H20 NR	S 7356 A	S 3023 C
Domino HD									
12 m	Iveco Cursor8 Euro3	259	352	01/01	>	S 3288 R	S 4396 NR		
dryer filter / filtro essiccatore	Iveco Cursor8 Euro3	259	352	01/01	>				S 7259 A
VGT filter / filtro VGT	Iveco Cursor8 Euro3	259	352	01/01	>				S 0VGT A
prefilter / prefiltra	Iveco Cursor8 Euro3	259	352	01/01	>		S 0999 NR		
power steering / servosterzo	Iveco Cursor8 Euro3	259	352	01/01	>				S 3081 PO
12.4 m	Iveco Cursor10 Euro4/5	279	380	09/06	>		S 1395 NR	S 7637 A	
with air-conditioner WEBASTO Aerosphere / con climatizzatore WEBASTO Aerosphere	Iveco Cursor10 Euro4/5	279	380	09/06	>				S 3081 C
with filter Urea/Adblue Denoxtronic 1 / con filtro Urea/Adblue Denoxtronic 1	Iveco Cursor10 Euro4/5	279	380	09/06	>				S 4401 U
with filter Urea/Adblue Denoxtronic 2 / con filtro Urea/Adblue Denoxtronic 2	Iveco Cursor10 Euro4/5	279	380	09/06	>				S 4402 U
dryer filter / filtro essiccatore	Iveco Cursor10 Euro4/5	279	380	09/06	>				S 7259 A
dryer filter WABCO, right-hand thread / filtro essiccatore WABCO, filetto destro	Iveco Cursor10 Euro4/5	279	380	09/06	>				S 7A66 A
VGT filter / filtro VGT	Iveco Cursor10 Euro4/5	279	380	09/06	>				S 0VGT A
inner / interno	Iveco Cursor10 Euro4/5	279	380	09/06	>			S 7649 A	
2 filters / N.2 filtri	Iveco Cursor10 Euro4/5	279	380	09/06	>	S 3288 R			
prefilter / prefiltra	Iveco Cursor10 Euro4/5	279	380	09/06	>		S 1999 NR		
power steering / servosterzo	Iveco Cursor10 Euro4/5	279	380	09/06	>				S 3081 PO
12.4 m	Iveco Cursor10 Euro4/5	331	450	09/06	>		S 1395 NR	S 7637 A	
with air-conditioner WEBASTO Aerosphere / con climatizzatore WEBASTO Aerosphere	Iveco Cursor10 Euro4/5	331	450	09/06	>				S 3081 C
with filter Urea/Adblue Denoxtronic 1 / con filtro Urea/Adblue Denoxtronic 1	Iveco Cursor10 Euro4/5	331	450	09/06	>				S 4401 U
with filter Urea/Adblue Denoxtronic 2 / con filtro Urea/Adblue Denoxtronic 2	Iveco Cursor10 Euro4/5	331	450	09/06	>				S 4402 U
dryer filter / filtro essiccatore	Iveco Cursor10 Euro4/5	331	450	09/06	>				S 7259 A
dryer filter WABCO, right-hand thread / filtro essiccatore WABCO, filetto destro	Iveco Cursor10 Euro4/5	331	450	09/06	>				S 7A66 A
VGT filter / filtro VGT	Iveco Cursor10 Euro4/5	331	450	09/06	>				S 0VGT A
inner / interno	Iveco Cursor10 Euro4/5	331	450	09/06	>			S 7649 A	
2 filters / N.2 filtri	Iveco Cursor10 Euro4/5	331	450	09/06	>	S 3288 R			
prefilter / prefiltra	Iveco Cursor10 Euro4/5	331	450	09/06	>		S 1999 NR		
power steering / servosterzo	Iveco Cursor10 Euro4/5	331	450	09/06	>				S 3081 PO
Domino HDH									
12.4 m	Iveco Cursor10 Euro4/5	279	380	09/06	>		S 1395 NR	S 7637 A	
with air-conditioner WEBASTO Aerosphere / con climatizzatore WEBASTO Aerosphere	Iveco Cursor10 Euro4/5	279	380	09/06	>				S 3081 C
with filter Urea/Adblue Denoxtronic 1 / con filtro Urea/Adblue Denoxtronic 1	Iveco Cursor10 Euro4/5	279	380	09/06	>				S 4401 U
with filter Urea/Adblue Denoxtronic 2 / con filtro Urea/Adblue Denoxtronic 2	Iveco Cursor10 Euro4/5	279	380	09/06	>				S 4402 U
dryer filter / filtro essiccatore	Iveco Cursor10 Euro4/5	279	380	09/06	>				S 7259 A
dryer filter WABCO, right-hand thread / filtro essiccatore WABCO, filetto destro	Iveco Cursor10 Euro4/5	279	380	09/06	>				S 7A66 A
VGT filter / filtro VGT	Iveco Cursor10 Euro4/5	279	380	09/06	>				S 0VGT A
inner / interno	Iveco Cursor10 Euro4/5	279	380	09/06	>			S 7649 A	
2 filters / N.2 filtri	Iveco Cursor10 Euro4/5	279	380	09/06	>	S 3288 R			

**KW HP****...IRISBUS - buses/autobus**

prefilter / prefiltrato	Iveco Cursor10 Euro4/5	279	380	09/06	>		S 1999 NR		S 3081 PO
power steering / servosterzo	Iveco Cursor10 Euro4/5	279	380	09/06	>				
12.4 m	Iveco Cursor10 Euro4/5	331	450	09/06	>		S 1395 NR	S 7637 A	
with air-conditioner WEBASTO Aerosphere / con climatizzatore WEBASTO Aerosphere	Iveco Cursor10 Euro4/5	331	450	09/06	>				S 3081 C
with filter Urea/Adblue Denoxtronic 1 / con filtro Urea/Adblue Denoxtronic 1	Iveco Cursor10 Euro4/5	331	450	09/06	>				S 4401 U
with filter Urea/Adblue Denoxtronic 2 / con filtro Urea/Adblue Denoxtronic 2	Iveco Cursor10 Euro4/5	331	450	09/06	>				S 4402 U
dryer filter / filtro essiccatore	Iveco Cursor10 Euro4/5	331	450	09/06	>				S 7259 A
dryer filter WABCO, right-hand thread / filtro essiccatore WABCO, filetto destro	Iveco Cursor10 Euro4/5	331	450	09/06	>				S 7A66 A
VGT filter / filtro VGT	Iveco Cursor10 Euro4/5	331	450	09/06	>				S 0VGT A
inner / interno	Iveco Cursor10 Euro4/5	331	450	09/06	>			S 7649 A	
2 filters / N.2 filtri	Iveco Cursor10 Euro4/5	331	450	09/06	>	S 3288 R			
prefilter / prefiltrato	Iveco Cursor10 Euro4/5	331	450	09/06	>		S 1999 NR		
power steering / servosterzo	Iveco Cursor10 Euro4/5	331	450	09/06	>				S 3081 PO
Evadys									
12 m	Iveco Cursor10	279	380	09/04	>		S 4395 NR		
some / alcuni	Iveco Cursor10	279	380	09/04	>			S 7A21 A	
with automatic gearbox ZF HP500/5HP502 / con cambio automatico ZF HP500/5HP502	Iveco Cursor10	279	380	09/04	>				S 2234 Z
dryer filter / filtro essiccatore	Iveco Cursor10	279	380	09/04	>				S 7259 A
VGT filter / filtro VGT	Iveco Cursor10	279	380	09/04	>				S 0VGT A
2 filters / N.2 filtri	Iveco Cursor10	279	380	09/04	>	S 3288 R			
prefilter / prefiltrato	Iveco Cursor10	279	380	09/04	>		S 0999 NR		
power steering / servosterzo	Iveco Cursor10	279	380	09/04	>				S 3081 PO
12 m	Iveco Cursor10	316	430	09/04	>		S 4395 NR		
some / alcuni	Iveco Cursor10	316	430	09/04	>			S 7A21 A	
with automatic gearbox ZF HP500/5HP502 / con cambio automatico ZF HP500/5HP502	Iveco Cursor10	316	430	09/04	>				S 2234 Z
dryer filter / filtro essiccatore	Iveco Cursor10	316	430	09/04	>				S 7259 A
VGT filter / filtro VGT	Iveco Cursor10	316	430	09/04	>				S 0VGT A
2 filters / N.2 filtri	Iveco Cursor10	316	430	09/04	>	S 3288 R			
prefilter / prefiltrato	Iveco Cursor10	316	430	09/04	>		S 0999 NR		
power steering / servosterzo	Iveco Cursor10	316	430	09/04	>				S 3081 PO
12 m	Iveco Cursor8	228	310	09/04	>	S 3288 R	S 4396 NR		
some / alcuni	Iveco Cursor8	228	310	09/04	>			S 7A21 A	
with automatic gearbox ZF HP500/5HP502 / con cambio automatico ZF HP500/5HP502	Iveco Cursor8	228	310	09/04	>				S 2234 Z
dryer filter / filtro essiccatore	Iveco Cursor8	228	310	09/04	>				S 7259 A
VGT filter / filtro VGT	Iveco Cursor8	228	310	09/04	>				S 0VGT A
prefilter / prefiltrato	Iveco Cursor8	228	310	09/04	>		S 0999 NR		
power steering / servosterzo	Iveco Cursor8	228	310	09/04	>				S 3081 PO
12 m	Iveco Cursor8	259	352	09/04	>	S 3288 R	S 4396 NR		
some / alcuni	Iveco Cursor8	259	352	09/04	>			S 7A21 A	
with automatic gearbox ZF HP500/5HP502 / con cambio automatico ZF HP500/5HP502	Iveco Cursor8	259	352	09/04	>				S 2234 Z
dryer filter / filtro essiccatore	Iveco Cursor8	259	352	09/04	>				S 7259 A
VGT filter / filtro VGT	Iveco Cursor8	259	352	09/04	>				S 0VGT A
prefilter / prefiltrato	Iveco Cursor8	259	352	09/04	>		S 0999 NR		
power steering / servosterzo	Iveco Cursor8	259	352	09/04	>				S 3081 PO
12.80 m	Iveco Cursor10	279	380	09/04	>		S 4395 NR		
some / alcuni	Iveco Cursor10	279	380	09/04	>			S 7A21 A	
with automatic gearbox ZF HP500/5HP502 / con cambio automatico ZF HP500/5HP502	Iveco Cursor10	279	380	09/04	>				S 2234 Z
dryer filter / filtro essiccatore	Iveco Cursor10	279	380	09/04	>				S 7259 A
VGT filter / filtro VGT	Iveco Cursor10	279	380	09/04	>				S 0VGT A
2 filters / N.2 filtri	Iveco Cursor10	279	380	09/04	>	S 3288 R			
prefilter / prefiltrato	Iveco Cursor10	279	380	09/04	>		S 0999 NR		
power steering / servosterzo	Iveco Cursor10	279	380	09/04	>				S 3081 PO
12.80 m	Iveco Cursor10	316	430	09/04	>		S 4395 NR		
some / alcuni	Iveco Cursor10	316	430	09/04	>			S 7A21 A	
with automatic gearbox ZF HP500/5HP502 / con cambio automatico ZF HP500/5HP502	Iveco Cursor10	316	430	09/04	>				S 2234 Z
dryer filter / filtro essiccatore	Iveco Cursor10	316	430	09/04	>				S 7259 A
VGT filter / filtro VGT	Iveco Cursor10	316	430	09/04	>				S 0VGT A
2 filters / N.2 filtri	Iveco Cursor10	316	430	09/04	>	S 3288 R			
prefilter / prefiltrato	Iveco Cursor10	316	430	09/04	>		S 0999 NR		
power steering / servosterzo	Iveco Cursor10	316	430	09/04	>				S 3081 PO
12.80 m	Iveco Cursor8	228	310	09/04	>	S 3288 R	S 4396 NR		
some / alcuni	Iveco Cursor8	228	310	09/04	>			S 7A21 A	
with automatic gearbox ZF HP500/5HP502 / con cambio automatico ZF HP500/5HP502	Iveco Cursor8	228	310	09/04	>				S 2234 Z
dryer filter / filtro essiccatore	Iveco Cursor8	228	310	09/04	>				S 7259 A
VGT filter / filtro VGT	Iveco Cursor8	228	310	09/04	>				S 0VGT A
prefilter / prefiltrato	Iveco Cursor8	228	310	09/04	>		S 0999 NR		
power steering / servosterzo	Iveco Cursor8	228	310	09/04	>				S 3081 PO



**KW HP****...IRISBUS - buses/autobus**

12.80 m	Iveco Cursor8	259	352	09/04	>	S 3288 R	S 4396 NR		
some / alcuni	Iveco Cursor8	259	352	09/04	>			S 7A21 A	
with automatic gearbox ZF HP500/5HP502 / con cambio automatico ZF HP500/5HP502	Iveco Cursor8	259	352	09/04	>				S 2234 Z
dryer filter / filtro essiccatore	Iveco Cursor8	259	352	09/04	>				S 7259 A
VGT filter / filtro VGT	Iveco Cursor8	259	352	09/04	>				S 0VGT A
prefilter / prefiltrato	Iveco Cursor8	259	352	09/04	>		S 0999 NR		
power steering / servosterzo	Iveco Cursor8	259	352	09/04	>				S 3081 PO
H 12 m	Iveco Cursor10	316	430	09/04	>		S 1395 NR	S 7637 A	
some / alcuni	Iveco Cursor10	316	430	09/04	>			S 7A21 A	
with automatic gearbox ZF 5HP502 / con cambio automatico ZF 5HP502	Iveco Cursor10	316	430	09/04	>				S 2234 Z
with air-conditioner WEBASTO Aerosphere / con climatizzatore WEBASTO Aerosphere	Iveco Cursor10	316	430	09/04	>				S 3081 C
dryer filter / filtro essiccatore	Iveco Cursor10	316	430	09/04	>				S 7259 A
dryer filter WABCO, right-hand thread / filtro essiccatore WABCO, filetto destro	Iveco Cursor10	316	430	09/04	>				S 7A66 A
VGT filter / filtro VGT	Iveco Cursor10	316	430	09/04	>				S 0VGT A
inner / interno	Iveco Cursor10	316	430	09/04	>			S 7649 A	
2 filters / N.2 filtri	Iveco Cursor10	316	430	09/04	>	S 3288 R			
prefilter / prefiltrato	Iveco Cursor10	316	430	09/04	>		S 1999 NR		
power steering / servosterzo	Iveco Cursor10	316	430	09/04	>				S 3081 PO
H 12 m	Iveco Cursor8	259	352	03/04	>	S 3288 R	S 4396 NR	S 7637 A	
some / alcuni	Iveco Cursor8	259	352	03/04	>			S 7A21 A	
with automatic gearbox ZF HP592 / con cambio automatico ZF HP592	Iveco Cursor8	259	352	03/04	>				S 2234 Z
with air-conditioner WEBASTO Aerosphere / con climatizzatore WEBASTO Aerosphere	Iveco Cursor8	259	352	03/04	>				S 3081 C
dryer filter / filtro essiccatore	Iveco Cursor8	259	352	03/04	>				S 7259 A
dryer filter WABCO, right-hand thread / filtro essiccatore WABCO, filetto destro	Iveco Cursor8	259	352	03/04	>				S 7A66 A
VGT filter / filtro VGT	Iveco Cursor8	259	352	03/04	>				S 0VGT A
inner / interno	Iveco Cursor8	259	352	03/04	>			S 7649 A	
prefilter / prefiltrato	Iveco Cursor8	259	352	03/04	>		S 0999 NR		
power steering / servosterzo	Iveco Cursor8	259	352	03/04	>				S 3081 PO
H 12 m	Iveco Tector F4A Euro3	194	264	09/04	>	S 0620 R	S 2220 NR	S 7637 A	
with air-conditioner WEBASTO Aerosphere / con climatizzatore WEBASTO Aerosphere	Iveco Tector F4A Euro3	194	264	09/04	>				S 3081 C
with filter BLOW-BY / con filtro BLOW-BY	Iveco Tector F4A Euro3	194	264	09/04	>	12/06			S 7B11 A
dryer filter / filtro essiccatore	Iveco Tector F4A Euro3	194	264	09/04	>				S 7259 A
dryer filter WABCO, right-hand thread / filtro essiccatore WABCO, filetto destro	Iveco Tector F4A Euro3	194	264	09/04	>				S 7A66 A
inner / interno	Iveco Tector F4A Euro3	194	264	09/04	>			S 7649 A	
power steering / servosterzo	Iveco Tector F4A Euro3	194	264	09/04	>				S 3081 PO
H 12.8 m	Iveco Cursor8	259	352	03/04	>	S 3288 R	S 4396 NR	S 7637 A	
some / alcuni	Iveco Cursor8	259	352	03/04	>			S 7A21 A	
with automatic gearbox ZF HP592 / con cambio automatico ZF HP592	Iveco Cursor8	259	352	03/04	>				S 2234 Z
with air-conditioner WEBASTO Aerosphere / con climatizzatore WEBASTO Aerosphere	Iveco Cursor8	259	352	03/04	>				S 3081 C
dryer filter / filtro essiccatore	Iveco Cursor8	259	352	03/04	>				S 7259 A
dryer filter WABCO, right-hand thread / filtro essiccatore WABCO, filetto destro	Iveco Cursor8	259	352	03/04	>				S 7A66 A
VGT filter / filtro VGT	Iveco Cursor8	259	352	03/04	>				S 0VGT A
inner / interno	Iveco Cursor8	259	352	03/04	>			S 7649 A	
prefilter / prefiltrato	Iveco Cursor8	259	352	03/04	>		S 0999 NR		
power steering / servosterzo	Iveco Cursor8	259	352	03/04	>				S 3081 PO
HD 12 m	Iveco Cursor10	279	380	09/04	>		S 1395 NR	S 7637 A	
some / alcuni	Iveco Cursor10	279	380	09/04	>			S 7A21 A	
with automatic gearbox ZF 5HP502 / con cambio automatico ZF 5HP502	Iveco Cursor10	279	380	09/04	>				S 2234 Z
with air-conditioner WEBASTO Aerosphere / con climatizzatore WEBASTO Aerosphere	Iveco Cursor10	279	380	09/04	>				S 3081 C
dryer filter / filtro essiccatore	Iveco Cursor10	279	380	09/04	>				S 7259 A
dryer filter WABCO, right-hand thread / filtro essiccatore WABCO, filetto destro	Iveco Cursor10	279	380	09/04	>				S 7A66 A
VGT filter / filtro VGT	Iveco Cursor10	279	380	09/04	>				S 0VGT A
inner / interno	Iveco Cursor10	279	380	09/04	>			S 7649 A	
2 filters / N.2 filtri	Iveco Cursor10	279	380	09/04	>	S 3288 R			
prefilter / prefiltrato	Iveco Cursor10	279	380	09/04	>		S 1999 NR		
power steering / servosterzo	Iveco Cursor10	279	380	09/04	>				S 3081 PO
HD 12 m	Iveco Cursor10	316	430	09/04	>		S 1395 NR	S 7637 A	
with automatic gearbox ZF 5HP502 / con cambio automatico ZF 5HP502	Iveco Cursor10	316	430	09/04	>				S 2234 Z
with air-conditioner WEBASTO Aerosphere / con climatizzatore WEBASTO Aerosphere	Iveco Cursor10	316	430	09/04	>				S 3081 C
dryer filter / filtro essiccatore	Iveco Cursor10	316	430	09/04	>				S 7259 A
dryer filter WABCO, right-hand thread / filtro essiccatore WABCO, filetto destro	Iveco Cursor10	316	430	09/04	>				S 7A66 A
VGT filter / filtro VGT	Iveco Cursor10	316	430	09/04	>				S 0VGT A
inner / interno	Iveco Cursor10	316	430	09/04	>			S 7649 A	
2 filters / N.2 filtri	Iveco Cursor10	316	430	09/04	>	S 3288 R			
prefilter / prefiltrato	Iveco Cursor10	316	430	09/04	>		S 1999 NR		
power steering / servosterzo	Iveco Cursor10	316	430	09/04	>				S 3081 PO
HD 12 m	Iveco Cursor10 Euro4	331	450	09/06	>		S 1395 NR	S 7637 A	

**kW HP****...IRISBUS - buses/autobus**

some / alcuni	Iveco Cursor10 Euro4	331	450	09/06	>			S 7A21 A	S 2234 Z
with automatic gearbox ZF 5HP502 / con cambio automatico ZF 5HP502	Iveco Cursor10 Euro4	331	450	09/06	>				S 3081 C
with air-conditioner WEBASTO Aerosphere / con climatizzatore WEBASTO Aerosphere	Iveco Cursor10 Euro4	331	450	09/06	>				S 4401 U
with filter Urea/Adblue Denoxtronic 1 / con filtro Urea/Adblue Denoxtronic 1	Iveco Cursor10 Euro4	331	450	09/06	>				S 4402 U
with filter Urea/Adblue Denoxtronic 2 / con filtro Urea/Adblue Denoxtronic 2	Iveco Cursor10 Euro4	331	450	09/06	>				S 7259 A
dryer filter / filtro essiccatore	Iveco Cursor10 Euro4	331	450	09/06	>				S 7A66 A
dryer filter WABCO, right-hand thread / filtro essiccatore WABCO, filetto destro	Iveco Cursor10 Euro4	331	450	09/06	>				S 0VGT A
VGT filter / filtro VGT	Iveco Cursor10 Euro4	331	450	09/06	>				
inner / interno	Iveco Cursor10 Euro4	331	450	09/06	>			S 7649 A	
2 filters / N.2 filtri	Iveco Cursor10 Euro4	331	450	09/06	>	S 3288 R			
prefilter / prefiltra	Iveco Cursor10 Euro4	331	450	09/06	>		S 1999 NR		
power steering / servosterzo	Iveco Cursor10 Euro4	331	450	09/06	>				S 3081 PO
Iliade									
10.6 m GTC/RTC/TEC									
with gearbox ZF Ecosplit + Intarder / con cambio ZF Ecosplit + Intarder	dCi 11 Euro3	266	362	05/02	>	03/07			S 2234 Z
with air-conditioner WEBASTO Aerosphere / con climatizzatore WEBASTO Aerosphere	dCi 11 Euro3	266	362	05/02	>	03/07	S 0900 R		S 3081 C
dryer filter / filtro essiccatore	dCi 11 Euro3	266	362	05/02	>	03/07			S 7259 A
2 filters / N.2 filtri	dCi 11 Euro3	266	362	05/02	>	03/07		S 0712 NR	
power steering / servosterzo	dCi 11 Euro3	266	362	05/02	>	03/07			S 3081 PO
12 m GT									
with gearbox ZF Ecosplit + Intarder / con cambio ZF Ecosplit + Intarder	dCi 11 Euro3	266	362	05/02	>	03/07			S 2234 Z
with air-conditioner WEBASTO Aerosphere / con climatizzatore WEBASTO Aerosphere	dCi 11 Euro3	266	362	05/02	>	03/07	S 0900 R		S 3081 C
dryer filter / filtro essiccatore	dCi 11 Euro3	266	362	05/02	>	03/07			S 7259 A
2 filters / N.2 filtri	dCi 11 Euro3	266	362	05/02	>	03/07		S 0712 NR	
power steering / servosterzo	dCi 11 Euro3	266	362	05/02	>	03/07			S 3081 PO
12 m GTX									
with gearbox ZF Ecosplit + Intarder / con cambio ZF Ecosplit + Intarder	dCi 12 Euro3	317	431	05/02	>	03/07			S 2234 Z
with air-conditioner WEBASTO Aerosphere / con climatizzatore WEBASTO Aerosphere	dCi 12 Euro3	317	431	05/02	>	03/07	S 0900 R		S 3081 C
dryer filter / filtro essiccatore	dCi 12 Euro3	317	431	05/02	>	03/07			S 7259 A
2 filters / N.2 filtri	dCi 12 Euro3	317	431	05/02	>	03/07		S 0712 NR	
power steering / servosterzo	dCi 12 Euro3	317	431	05/02	>	03/07			S 3081 PO
12 m RT									
with gearbox ZF Ecosplit + Intarder / con cambio ZF Ecosplit + Intarder	dCi 11 Euro3	266	362	05/02	>	03/07			S 2234 Z
with air-conditioner WEBASTO Aerosphere / con climatizzatore WEBASTO Aerosphere	dCi 11 Euro3	266	362	05/02	>	03/07	S 0900 R		S 3081 C
dryer filter / filtro essiccatore	dCi 11 Euro3	266	362	05/02	>	03/07			S 7259 A
2 filters / N.2 filtri	dCi 11 Euro3	266	362	05/02	>	03/07		S 0712 NR	
power steering / servosterzo	dCi 11 Euro3	266	362	05/02	>	03/07			S 3081 PO
12 m TE									
with gearbox ZF Ecosplit + Intarder / con cambio ZF Ecosplit + Intarder	dCi 11 Euro3	230	313	05/02	>	03/07			S 2234 Z
with air-conditioner WEBASTO Aerosphere / con climatizzatore WEBASTO Aerosphere	dCi 11 Euro3	230	313	05/02	>	03/07	S 0900 R		S 3081 C
dryer filter / filtro essiccatore	dCi 11 Euro3	230	313	05/02	>	03/07			S 7259 A
2 filters / N.2 filtri	dCi 11 Euro3	230	313	05/02	>	03/07		S 0712 NR	
power steering / servosterzo	dCi 11 Euro3	230	313	05/02	>	03/07			S 3081 PO
Magelys HD									
12.2 m									
additional WEBASTO / addizionale WEBASTO	Iveco Cursor10 Euro4/5/EEV	279	380	07/07	>			S 1395 NR	S 7637 A
with automatic gearbox ZF 5HP502 / con cambio automatico ZF 5HP502	Iveco Cursor10 Euro4/5/EEV	279	380	07/07	>				S 4323 NR
with filter Urea/Adblue Denoxtronic 1 / con filtro Urea/Adblue Denoxtronic 1	Iveco Cursor10 Euro4/5/EEV	279	380	07/07	>				S 2234 Z
with filter Urea/Adblue Denoxtronic 2 / con filtro Urea/Adblue Denoxtronic 2	Iveco Cursor10 Euro4/5/EEV	279	380	07/07	>				S 4401 U
dryer filter / filtro essiccatore	Iveco Cursor10 Euro4/5/EEV	279	380	07/07	>				S 4402 U
dryer filter WABCO, right-hand thread / filtro essiccatore WABCO, filetto destro	Iveco Cursor10 Euro4/5/EEV	279	380	07/07	>				S 7259 A
VGT filter / filtro VGT	Iveco Cursor10 Euro4/5/EEV	279	380	07/07	>				S 7A66 A
hydrostatic steering / guida idrostatica	Iveco Cursor10 Euro4/5/EEV	279	380	07/07	>				S 0VGT A
inner / interno	Iveco Cursor10 Euro4/5/EEV	279	380	07/07	>			S 7649 A	S 8137 RH
2 filters / N.2 filtri	Iveco Cursor10 Euro4/5/EEV	279	380	07/07	>		S 3288 R		
prefilter / prefiltra	Iveco Cursor10 Euro4/5/EEV	279	380	07/07	>			S 1999 NR	
power steering / servosterzo	Iveco Cursor10 Euro4/5/EEV	279	380	07/07	>				S 3081 PO
12.2 m									
additional WEBASTO / addizionale WEBASTO	Iveco Cursor10 Euro4/5/EEV	331	450	07/07	>			S 1395 NR	S 7637 A
with automatic gearbox ZF 5HP502 / con cambio automatico ZF 5HP502	Iveco Cursor10 Euro4/5/EEV	331	450	07/07	>				S 4323 NR
with filter Urea/Adblue Denoxtronic 1 / con filtro Urea/Adblue Denoxtronic 1	Iveco Cursor10 Euro4/5/EEV	331	450	07/07	>				S 2234 Z
with filter Urea/Adblue Denoxtronic 2 / con filtro Urea/Adblue Denoxtronic 2	Iveco Cursor10 Euro4/5/EEV	331	450	07/07	>				S 4401 U
dryer filter / filtro essiccatore	Iveco Cursor10 Euro4/5/EEV	331	450	07/07	>				S 4402 U
dryer filter WABCO, right-hand thread / filtro essiccatore WABCO, filetto destro	Iveco Cursor10 Euro4/5/EEV	331	450	07/07	>				S 7259 A
VGT filter / filtro VGT	Iveco Cursor10 Euro4/5/EEV	331	450	07/07	>				S 7A66 A
hydrostatic steering / guida idrostatica	Iveco Cursor10 Euro4/5/EEV	331	450	07/07	>				S 0VGT A
inner / interno	Iveco Cursor10 Euro4/5/EEV	331	450	07/07	>			S 7649 A	S 8137 RH

**KW HP**

...IRISBUS - buses/autobus

additional WEBASTO / addizionale WEBASTO	Iveco Cursor10 Euro4/5/EEV	331	450	07/07	>				S 4323 NR
with automatic gearbox ZF 5HP502 / con cambio automatico ZF 5HP502	Iveco Cursor10 Euro4/5/EEV	331	450	07/07	>				S 2234 Z
with filter Urea/Adblue / con filtro Urea/Adblue	Iveco Cursor10 Euro4/5/EEV	331	450	07/07	>				S 4401 U
with filter Urea/Adblue Denoxtronic 2 / con filtro Urea/Adblue Denoxtronic 2	Iveco Cursor10 Euro4/5/EEV	331	450	07/07	>				S 4402 U
dryer filter / filtro essiccatore	Iveco Cursor10 Euro4/5/EEV	331	450	07/07	>				S 7259 A
dryer filter WABCO, right-hand thread / filtro essiccatore WABCO, filetto destro	Iveco Cursor10 Euro4/5/EEV	331	450	07/07	>				S 7A66 A
VGT filter / filtro VGT	Iveco Cursor10 Euro4/5/EEV	331	450	07/07	>				S 0VGT A
hydrostatic steering / guida idrostatica	Iveco Cursor10 Euro4/5/EEV	331	450	07/07	>				S 8137 RH
inner / interno	Iveco Cursor10 Euro4/5/EEV	331	450	07/07	>			S 7649 A	
2 filters / N.2 filtri	Iveco Cursor10 Euro4/5/EEV	331	450	07/07	>	S 3288 R			
prefilter / prefiltra	Iveco Cursor10 Euro4/5/EEV	331	450	07/07	>		S 1999 NR		
power steering / servosterzo	Iveco Cursor10 Euro4/5/EEV	331	450	07/07	>				S 3081 PO
Midi GX									
117	Iveco Tector F4A Euro3	154	210	09/04	>	S 0620 R	S 2220 NR	S 7627 A	
with air-conditioner WEBASTO Aerosphere / con climatizzatore WEBASTO Aerosphere	Iveco Tector F4A Euro3	154	210	09/04	>				S 3081 C
dryer filter / filtro essiccatore	Iveco Tector F4A Euro3	154	210	09/04	>				S 7259 A
power steering / servosterzo	Iveco Tector F4A Euro3	154	210	09/04	>				S 3081 PO
117	Iveco Tector F4A Euro4	154	210	02/06	>	S 0620 R	S 2220 NR	S 7637 A	
with filter Urea/Adblue / con filtro Urea/Adblue	Iveco Tector F4A Euro4	154	210	02/06	>				S 4401 U
dryer filter / filtro essiccatore	Iveco Tector F4A Euro4	154	210	02/06	>				S 7259 A
power steering / servosterzo	Iveco Tector F4A Euro4	154	210	02/06	>				S 3081 PO
Midys									
Midys	Iveco Tector F4A Euro3	154	209	09/04	>	S 0620 R	S 2220 NR	S 7637 A	
with air-conditioner WEBASTO Aerosphere / con climatizzatore WEBASTO Aerosphere	Iveco Tector F4A Euro3	154	209	09/04	>				S 3081 C
dryer filter / filtro essiccatore	Iveco Tector F4A Euro3	154	209	09/04	>				S 7259 A
power steering / servosterzo	Iveco Tector F4A Euro3	154	209	09/04	>				S 3081 PO
Moovy									
12 m	Iveco Cursor8 F2B	180	245	09/04	>	S 3288 R	S 4396 NR	S 7575 A	
with automatic gearbox ZF 5HP502 / con cambio automatico ZF 5HP502	Iveco Cursor8 F2B	180	245	09/04	>				S 2234 Z
with air-conditioner WEBASTO Aerosphere / con climatizzatore WEBASTO Aerosphere	Iveco Cursor8 F2B	180	245	09/04	>				S 3081 C
dryer filter / filtro essiccatore	Iveco Cursor8 F2B	180	245	09/04	>				S 7259 A
VGT filter / filtro VGT	Iveco Cursor8 F2B	180	245	09/04	>				S 0VGT A
prefilter / prefiltra	Iveco Cursor8 F2B	180	245	09/04	>		S 0999 NR		
power steering / servosterzo	Iveco Cursor8 F2B	180	245	09/04	>				S 3081 PO
12 m	Iveco Cursor8 F2B Euro3	213	290	09/04	>	S 3288 R	S 4396 NR	S 7575 A	
with automatic gearbox ZF 5HP502 / con cambio automatico ZF 5HP502	Iveco Cursor8 F2B Euro3	213	290	09/04	>				S 2234 Z
with air-conditioner WEBASTO Aerosphere / con climatizzatore WEBASTO Aerosphere	Iveco Cursor8 F2B Euro3	213	290	09/04	>				S 3081 C
dryer filter / filtro essiccatore	Iveco Cursor8 F2B Euro3	213	290	09/04	>				S 7259 A
VGT filter / filtro VGT	Iveco Cursor8 F2B Euro3	213	290	09/04	>				S 0VGT A
prefilter / prefiltra	Iveco Cursor8 F2B Euro3	213	290	09/04	>		S 0999 NR		
power steering / servosterzo	Iveco Cursor8 F2B Euro3	213	290	09/04	>				S 3081 PO
MyWay									
399.12.29	Iveco Cursor8 Euro3	213	290	01/02	>	S 3288 R	S 4396 NR	S 7637 A	
with automatic gearbox ZF HP500/5HP502 / con cambio automatico ZF HP500/5HP502	Iveco Cursor8 Euro3	213	290	01/02	>				S 2234 Z
dryer filter / filtro essiccatore	Iveco Cursor8 Euro3	213	290	01/02	>				S 7259 A
VGT filter / filtro VGT	Iveco Cursor8 Euro3	213	290	01/02	>				S 0VGT A
prefilter / prefiltra	Iveco Cursor8 Euro3	213	290	01/02	>		S 0999 NR		
power steering / servosterzo	Iveco Cursor8 Euro3	213	290	01/02	>				S 3081 PO
399.12.31	Iveco Cursor8 Euro3	228	310	01/02	>	S 3288 R	S 4396 NR	S 7637 A	
with automatic gearbox ZF HP500/5HP502 / con cambio automatico ZF HP500/5HP502	Iveco Cursor8 Euro3	228	310	01/02	>				S 2234 Z
dryer filter / filtro essiccatore	Iveco Cursor8 Euro3	228	310	01/02	>				S 7259 A
VGT filter / filtro VGT	Iveco Cursor8 Euro3	228	310	01/02	>				S 0VGT A
prefilter / prefiltra	Iveco Cursor8 Euro3	228	310	01/02	>		S 0999 NR		
power steering / servosterzo	Iveco Cursor8 Euro3	228	310	01/02	>				S 3081 PO
399.12.35	Iveco Cursor8 Euro3	259	352	01/02	>	S 3288 R	S 4396 NR	S 7637 A	
with automatic gearbox ZF HP500/5HP502 / con cambio automatico ZF HP500/5HP502	Iveco Cursor8 Euro3	259	352	01/02	>				S 2234 Z
dryer filter / filtro essiccatore	Iveco Cursor8 Euro3	259	352	01/02	>				S 7259 A
VGT filter / filtro VGT	Iveco Cursor8 Euro3	259	352	01/02	>				S 0VGT A
prefilter / prefiltra	Iveco Cursor8 Euro3	259	352	01/02	>		S 0999 NR		
power steering / servosterzo	Iveco Cursor8 Euro3	259	352	01/02	>				S 3081 PO
Proway									
7.75 m	Iveco Tector4 Euro4	125	170	03/06	>	S 0620 R	S 2220 NR	S 7625 A	
dryer filter / filtro essiccatore	Iveco Tector4 Euro4	125	170	03/06	>				S 7259 A
prefilter / prefiltra	Iveco Tector4 Euro4	125	170	03/06	>		S 1999 NR		
power steering / servosterzo	Iveco Tector4 Euro4	125	170	03/06	>				S 3081 PO
7.75 m	Iveco Tector6 Euro5	160	218	07/08	>	S 0620 R	S 2220 NR	S 7627 A	
with filter Urea/Adblue / con filtro Urea/Adblue	Iveco Tector6 Euro5	160	218	07/08	>				S 4401 U

**kW HP****...IRISBUS - buses/autobus**

dryer filter / filtro essiccatore	Iveco Tector6 Euro5	160	218	07/08	>			S 1999 NR		S 7259 A
prefilter / prefiltrato	Iveco Tector6 Euro5	160	218	07/08	>					
power steering / servosterzo	Iveco Tector6 Euro5	160	218	07/08	>					S 3081 PO
8.45 m	Iveco Tector6 Euro5	160	218	07/08	>	S 0620 R		S 2220 NR	S 7627 A	
with filter Urea/Adblue / con filtro Urea/Adblue	Iveco Tector6 Euro5	160	218	07/08	>					S 4401 U
dryer filter / filtro essiccatore	Iveco Tector6 Euro5	160	218	07/08	>					S 7259 A
prefilter / prefiltrato	Iveco Tector6 Euro5	160	218	07/08	>			S 1999 NR		
power steering / servosterzo	Iveco Tector6 Euro5	160	218	07/08	>					S 3081 PO
Proxys										
7.75 m	Iveco Tector4 Euro4	125	170	02/06	>	S 0620 R		S 2220 NR	S 7625 A	
dryer filter / filtro essiccatore	Iveco Tector4 Euro4	125	170	02/06	>					S 7259 A
prefilter / prefiltrato	Iveco Tector4 Euro4	125	170	02/06	>			S 1999 NR		
power steering / servosterzo	Iveco Tector4 Euro4	125	170	02/06	>					S 3081 PO
7.75 m	Iveco Tector6 Euro5	160	218	07/08	>	S 0620 R		S 2220 NR	S 7627 A	
with filter Urea/Adblue / con filtro Urea/Adblue	Iveco Tector6 Euro5	160	218	07/08	>					S 4401 U
dryer filter / filtro essiccatore	Iveco Tector6 Euro5	160	218	07/08	>					S 7259 A
prefilter / prefiltrato	Iveco Tector6 Euro5	160	218	07/08	>			S 1999 NR		
power steering / servosterzo	Iveco Tector6 Euro5	160	218	07/08	>					S 3081 PO
8.45 m	Iveco Tector6 Euro5	160	218	07/08	>	S 0620 R		S 2220 NR	S 7627 A	
with filter Urea/Adblue / con filtro Urea/Adblue	Iveco Tector6 Euro5	160	218	07/08	>					S 4401 U
dryer filter / filtro essiccatore	Iveco Tector6 Euro5	160	218	07/08	>					S 7259 A
prefilter / prefiltrato	Iveco Tector6 Euro5	160	218	07/08	>			S 1999 NR		
power steering / servosterzo	Iveco Tector6 Euro5	160	218	07/08	>					S 3081 PO
Recreo										
10.6 m	Iveco Cursor8 Euro 4/5/EEV	243	330	11/06	>	S 3288 R		S 4396 NR	S 7A11 A	
additional WEBASTO / addizionale WEBASTO	Iveco Cursor8 Euro 4/5/EEV	243	330	11/06	>			S 4323 NR		
some / alcuni	Iveco Cursor8 Euro 4/5/EEV	243	330	11/06	>				S 7694 A	
some / alcuni	Iveco Cursor8 Euro 4/5/EEV	243	330	11/06	>				S 7637 A	
with automatic gearbox ZF 6HP / con cambio automatico ZF 6HP	Iveco Cursor8 Euro 4/5/EEV	243	330	11/06	>					S 2234 Z
with filter AdBlue/SCR Denoxtronic 1 / con filtro AdBlue/SCR Denoxtronic 1	Iveco Cursor8 Euro 4/5/EEV	243	330	11/06	>					S 4401 U
with filter AdBlue/SCR Denoxtronic 2 / con filtro AdBlue/SCR Denoxtronic 2	Iveco Cursor8 Euro 4/5/EEV	243	330							S 4402 U
dryer filter / filtro essiccatore	Iveco Cursor8 Euro 4/5/EEV	243	330	11/06	>					S 7259 A
filter VGT / filtro VGT	Iveco Cursor8 Euro 4/5/EEV	243	330	11/06	>					S 0VGT A
prefilter / prefiltrato	Iveco Cursor8 Euro 4/5/EEV	243	330	11/06	>			S 1999 NR		
power steering / servosterzo	Iveco Cursor8 Euro 4/5/EEV	243	330	11/06	>					S 3081 PO
10.6 m	Iveco Tector6 Euro 4/5/EEV	194	264	11/06	>	S 0620 R		S 2220 NR		
to frame No. VNESFR1500M010937 / a telaio N. VNESFR1500M010937	Iveco Tector6 Euro 4/5/EEV	194	264						S 7694 A	
additional WEBASTO / addizionale WEBASTO	Iveco Tector6 Euro 4/5/EEV	194	264	11/06	>			S 4323 NR		
with automatic gearbox ZF 6HP / con cambio automatico ZF 6HP	Iveco Tector6 Euro 4/5/EEV	194	264	11/06	>					S 2234 Z
with filter AdBlue/SCR Denoxtronic 1 / con filtro AdBlue/SCR Denoxtronic 1	Iveco Tector6 Euro 4/5/EEV	194	264	11/06	>					S 4401 U
with filter AdBlue/SCR Denoxtronic 2 / con filtro AdBlue/SCR Denoxtronic 2	Iveco Tector6 Euro 4/5/EEV	194	264							S 4402 U
dryer filter / filtro essiccatore	Iveco Tector6 Euro 4/5/EEV	194	264	11/06	>					S 7259 A
prefilter / prefiltrato	Iveco Tector6 Euro 4/5/EEV	194	264	11/06	>			S 1999 NR		
power steering / servosterzo	Iveco Tector6 Euro 4/5/EEV	194	264	11/06	>					S 3081 PO
10.6 m	Iveco Tector6 Euro 4/5/EEV	220	299	11/06	>	S 0620 R		S 2220 NR		
to frame No. VNESFR1500M010937 / a telaio N. VNESFR1500M010937	Iveco Tector6 Euro 4/5/EEV	220	299						S 7694 A	
additional WEBASTO / addizionale WEBASTO	Iveco Tector6 Euro 4/5/EEV	220	299	11/06	>			S 4323 NR		
with automatic gearbox ZF 6HP / con cambio automatico ZF 6HP	Iveco Tector6 Euro 4/5/EEV	220	299	11/06	>					S 2234 Z
with filter AdBlue/SCR Denoxtronic 1 / con filtro AdBlue/SCR Denoxtronic 1	Iveco Tector6 Euro 4/5/EEV	220	299	11/06	>					S 4401 U
with filter AdBlue/SCR Denoxtronic 2 / con filtro AdBlue/SCR Denoxtronic 2	Iveco Tector6 Euro 4/5/EEV	220	299							S 4402 U
dryer filter / filtro essiccatore	Iveco Tector6 Euro 4/5/EEV	220	299	11/06	>					S 7259 A
prefilter / prefiltrato	Iveco Tector6 Euro 4/5/EEV	220	299	11/06	>			S 1999 NR		
power steering / servosterzo	Iveco Tector6 Euro 4/5/EEV	220	299	11/06	>					S 3081 PO
12 m	Iveco Cursor8 Euro 3	228	310	09/04	> 03/07	S 3288 R		S 4396 NR		
with automatic gearbox ZF HP500/5HP502 / con cambio automatico ZF HP500/5HP502	Iveco Cursor8 Euro 3	228	310	09/04	> 03/07					S 2234 Z
with filter DONALDSON / con filtro DONALDSON	Iveco Cursor8 Euro 3	228	310	09/04	> 03/07				S 7575 A	
with filter MANN+HUMMEL / con filtro MANN+HUMMEL	Iveco Cursor8 Euro 3	228	310	09/07	> 03/07				S 7694 A	
dryer filter / filtro essiccatore	Iveco Cursor8 Euro 3	228	310	09/04	> 03/07					S 7259 A
VGT filter / filtro VGT	Iveco Cursor8 Euro 3	228	310	09/04	> 03/07					S 0VGT A
prefilter / prefiltrato	Iveco Cursor8 Euro 3	228	310	09/04	> 03/07			S 0999 NR		
power steering / servosterzo	Iveco Cursor8 Euro 3	228	310	09/04	> 03/07					S 3081 PO
12 m	Iveco Cursor8 Euro 4/5/EEV	243	330	11/06	>	S 3288 R		S 4396 NR	S 7A11 A	
additional WEBASTO / addizionale WEBASTO	Iveco Cursor8 Euro 4/5/EEV	243	330	11/06	>			S 4323 NR		
some / alcuni	Iveco Cursor8 Euro 4/5/EEV	243	330	11/06	>				S 7694 A	
some / alcuni	Iveco Cursor8 Euro 4/5/EEV	243	330	11/06	>				S 7637 A	
with automatic gearbox ZF 6HP / con cambio automatico ZF 6HP	Iveco Cursor8 Euro 4/5/EEV	243	330	11/06	>					S 2234 Z
with filter AdBlue/SCR Denoxtronic 1 / con filtro AdBlue/SCR Denoxtronic 1	Iveco Cursor8 Euro 4/5/EEV	243	330	11/06	>					S 4401 U

**kW HP****...IRISBUS - buses/autobus**

with filter AdBlue/SCR Denoxtronic 2 / con filtro AdBlue/SCR Denoxtronic 2	Iveco Cursor8 Euro 4/5/EEV	243	330					S 4402 U
dryer filter / filtro essiccatore	Iveco Cursor8 Euro 4/5/EEV	243	330	11/06 >				S 7259 A
filter VGT / filtro VGT	Iveco Cursor8 Euro 4/5/EEV	243	330	11/06 >				S 0VGT A
prefilter / prefiltra	Iveco Cursor8 Euro 4/5/EEV	243	330	11/06 >			S 1999 NR	
power steering / servosterzo	Iveco Cursor8 Euro 4/5/EEV	243	330	11/06 >				S 3081 PO
12 m	Iveco Tector6 Euro 4/5/EEV	194	264	11/06 >	S 0620 R	S 2220 NR		
to frame No. VNESFR1500M010937 / a telaio N. VNESFR1500M010937	Iveco Tector6 Euro 4/5/EEV	194	264				S 7694 A	
additional WEBASTO / addizionale WEBASTO	Iveco Tector6 Euro 4/5/EEV	194	264	11/06 >		S 4323 NR		
with automatic gearbox ZF 6HP / con cambio automatico ZF 6HP	Iveco Tector6 Euro 4/5/EEV	194	264	11/06 >				S 2234 Z
with filter AdBlue/SCR Denoxtronic 1 / con filtro AdBlue/SCR Denoxtronic 1	Iveco Tector6 Euro 4/5/EEV	194	264	11/06 >				S 4401 U
with filter AdBlue/SCR Denoxtronic 2 / con filtro AdBlue/SCR Denoxtronic 2	Iveco Tector6 Euro 4/5/EEV	194	264					S 4402 U
dryer filter / filtro essiccatore	Iveco Tector6 Euro 4/5/EEV	194	264	11/06 >				S 7259 A
prefilter / prefiltra	Iveco Tector6 Euro 4/5/EEV	194	264	11/06 >		S 1999 NR		
power steering / servosterzo	Iveco Tector6 Euro 4/5/EEV	194	264	11/06 >				S 3081 PO
12 m	Iveco Tector6 Euro 4/5/EEV	220	299	11/06 >	S 0620 R	S 2220 NR		
to frame No. VNESFR1500M010937 / a telaio N. VNESFR1500M010937	Iveco Tector6 Euro 4/5/EEV	220	299				S 7694 A	
additional WEBASTO / addizionale WEBASTO	Iveco Tector6 Euro 4/5/EEV	220	299	11/06 >		S 4323 NR		
with automatic gearbox ZF 6HP / con cambio automatico ZF 6HP	Iveco Tector6 Euro 4/5/EEV	220	299	11/06 >				S 2234 Z
with filter AdBlue/SCR Denoxtronic 1 / con filtro AdBlue/SCR Denoxtronic 1	Iveco Tector6 Euro 4/5/EEV	220	299	11/06 >				S 4401 U
with filter AdBlue/SCR Denoxtronic 2 / con filtro AdBlue/SCR Denoxtronic 2	Iveco Tector6 Euro 4/5/EEV	220	299					S 4402 U
dryer filter / filtro essiccatore	Iveco Tector6 Euro 4/5/EEV	220	299	11/06 >				S 7259 A
prefilter / prefiltra	Iveco Tector6 Euro 4/5/EEV	220	299	11/06 >		S 1999 NR		
power steering / servosterzo	Iveco Tector6 Euro 4/5/EEV	220	299	11/06 >				S 3081 PO
12.8 m	Iveco Cursor8 Euro 3	228	310	09/04 > 03/07	S 3288 R	S 4396 NR		
with automatic gearbox ZF HP500/5HP502 / con cambio automatico ZF HP500/5HP502	Iveco Cursor8 Euro 3	228	310	09/04 > 03/07			S 7575 A	S 2234 Z
with filter DONALDSON / con filtro DONALDSON	Iveco Cursor8 Euro 3	228	310	09/04 > 03/07			S 7694 A	
with filter MANN+HUMMEL / con filtro MANN+HUMMEL	Iveco Cursor8 Euro 3	228	310	09/04 > 03/07				S 7259 A
dryer filter / filtro essiccatore	Iveco Cursor8 Euro 3	228	310	09/04 > 03/07				S 0VGT A
VGT filter / filtro VGT	Iveco Cursor8 Euro 3	228	310	09/04 > 03/07				
prefilter / prefiltra	Iveco Cursor8 Euro 3	228	310	09/04 > 03/07		S 0999 NR		
power steering / servosterzo	Iveco Cursor8 Euro 3	228	310	09/04 > 03/07				S 3081 PO
12.8 m	Iveco Cursor8 Euro 4/5/EEV	243	330	11/06 >	S 3288 R	S 4396 NR	S 7A11 A	
additional WEBASTO / addizionale WEBASTO	Iveco Cursor8 Euro 4/5/EEV	243	330	11/06 >		S 4323 NR		
some / alcuni	Iveco Cursor8 Euro 4/5/EEV	243	330	11/06 >			S 7694 A	
some / alcuni	Iveco Cursor8 Euro 4/5/EEV	243	330	11/06 >			S 7637 A	
with automatic gearbox ZF 6HP / con cambio automatico ZF 6HP	Iveco Cursor8 Euro 4/5/EEV	243	330	11/06 >				S 2234 Z
with filter AdBlue/SCR Denoxtronic 1 / con filtro AdBlue/SCR Denoxtronic 1	Iveco Cursor8 Euro 4/5/EEV	243	330	11/06 >				S 4401 U
with filter AdBlue/SCR Denoxtronic 2 / con filtro AdBlue/SCR Denoxtronic 2	Iveco Cursor8 Euro 4/5/EEV	243	330					S 4402 U
dryer filter / filtro essiccatore	Iveco Cursor8 Euro 4/5/EEV	243	330	11/06 >				S 7259 A
filter VGT / filtro VGT	Iveco Cursor8 Euro 4/5/EEV	243	330	11/06 >				S 0VGT A
prefilter / prefiltra	Iveco Cursor8 Euro 4/5/EEV	243	330	11/06 >		S 1999 NR		
power steering / servosterzo	Iveco Cursor8 Euro 4/5/EEV	243	330	11/06 >				S 3081 PO
12.8 m	Iveco Tector6 Euro 4/5/EEV	194	264	11/06 >	S 0620 R	S 2220 NR		
to frame No. VNESFR1500M010937 / a telaio N. VNESFR1500M010937	Iveco Tector6 Euro 4/5/EEV	194	264				S 7694 A	
additional WEBASTO / addizionale WEBASTO	Iveco Tector6 Euro 4/5/EEV	194	264	11/06 >		S 4323 NR		
with automatic gearbox ZF 6HP / con cambio automatico ZF 6HP	Iveco Tector6 Euro 4/5/EEV	194	264	11/06 >				S 2234 Z
with filter AdBlue/SCR Denoxtronic 1 / con filtro AdBlue/SCR Denoxtronic 1	Iveco Tector6 Euro 4/5/EEV	194	264	11/06 >				S 4401 U
with filter AdBlue/SCR Denoxtronic 2 / con filtro AdBlue/SCR Denoxtronic 2	Iveco Tector6 Euro 4/5/EEV	194	264					S 4402 U
dryer filter / filtro essiccatore	Iveco Tector6 Euro 4/5/EEV	194	264	11/06 >				S 7259 A
prefilter / prefiltra	Iveco Tector6 Euro 4/5/EEV	194	264	11/06 >		S 1999 NR		
power steering / servosterzo	Iveco Tector6 Euro 4/5/EEV	194	264	11/06 >				S 3081 PO
12.8 m	Iveco Tector6 Euro 4/5/EEV	220	299	11/06 >	S 0620 R	S 2220 NR		
to frame No. VNESFR1500M010937 / a telaio N. VNESFR1500M010937	Iveco Tector6 Euro 4/5/EEV	220	299				S 7694 A	
additional WEBASTO / addizionale WEBASTO	Iveco Tector6 Euro 4/5/EEV	220	299	11/06 >		S 4323 NR		
with automatic gearbox ZF 6HP / con cambio automatico ZF 6HP	Iveco Tector6 Euro 4/5/EEV	220	299	11/06 >				S 2234 Z
with filter AdBlue/SCR Denoxtronic 1 / con filtro AdBlue/SCR Denoxtronic 1	Iveco Tector6 Euro 4/5/EEV	220	299	11/06 >				S 4401 U
with filter AdBlue/SCR Denoxtronic 2 / con filtro AdBlue/SCR Denoxtronic 2	Iveco Tector6 Euro 4/5/EEV	220	299					S 4402 U
dryer filter / filtro essiccatore	Iveco Tector6 Euro 4/5/EEV	220	299	11/06 >				S 7259 A
prefilter / prefiltra	Iveco Tector6 Euro 4/5/EEV	220	299	11/06 >		S 1999 NR		
power steering / servosterzo	Iveco Tector6 Euro 4/5/EEV	220	299	11/06 >				S 3081 PO

IRIZAR**buses/autobus****i4**

H	Scania DC12.10 Euro4	250	340	09/07 >	S 4402 R	S 6010 NE		
power steering / servosterzo	Scania DC12.10 Euro4	250	340	09/07 >				S 3081 PO
H	Scania DC12.13 Euro4	280	380	09/07 >	S 4402 R	S 6010 NE		
power steering / servosterzo	Scania DC12.13 Euro4	280	380	09/07 >				S 3081 PO

**KW HP****...IRIZAR - buses/autobus**

power steering / servosterzo	Scania DT12.03.470 Euro4	345	470	09/06	>				S 3081 PO
GT 12.9 m	Scania DT12.12.420 Euro4	309	420	09/06	>	S 4402 R	S 6010 NE	S 7A11 A	
with automatic gearbox ZF 6HP592/6HP692 / con cambio automatico ZF 6HP592/6HP692	Scania DT12.12.420 Euro4	309	420	09/06	>				S 2234 Z
retarder / freno di rallentamento	Scania DT12.12.420 Euro4	309	420	09/06	>				S 5613 PO
inner / interno	Scania DT12.12.420 Euro4	309	420	09/06	>			S 7649 A	
power steering / servosterzo	Scania DT12.12.420 Euro4	309	420	09/06	>				S 3081 PO
GT 12.9 m	Scania DT12.17.480 Euro4	353	480	09/07	>	S 4402 R	S 6010 NE	S 7A11 A	
with automatic gearbox ZF 6HP592/6HP692 / con cambio automatico ZF 6HP592/6HP692	Scania DT12.17.480 Euro4	353	480	09/07	>				S 2234 Z
retarder / freno di rallentamento	Scania DT12.17.480 Euro4	353	480	09/07	>				S 5613 PO
inner / interno	Scania DT12.17.480 Euro4	353	480	09/07	>			S 7649 A	
power steering / servosterzo	Scania DT12.17.480 Euro4	353	480	09/07	>				S 3081 PO
GT 13.9 m	Scania DT12.03.470 Euro4	345	470	09/06	>	S 4402 R	S 6010 NE	S 7A11 A	
with automatic gearbox ZF 6HP592/6HP692 / con cambio automatico ZF 6HP592/6HP692	Scania DT12.03.470 Euro4	345	470	09/06	>				S 2234 Z
retarder / freno di rallentamento	Scania DT12.03.470 Euro4	345	470	09/06	>				S 5613 PO
inner / interno	Scania DT12.03.470 Euro4	345	470	09/06	>			S 7649 A	
power steering / servosterzo	Scania DT12.03.470 Euro4	345	470	09/06	>				S 3081 PO
GT 13.9 m	Scania DT12.12.420 Euro4	309	420	09/06	>	S 4402 R	S 6010 NE	S 7A11 A	
with automatic gearbox ZF 6HP592/6HP692 / con cambio automatico ZF 6HP592/6HP692	Scania DT12.12.420 Euro4	309	420	09/06	>				S 2234 Z
retarder / freno di rallentamento	Scania DT12.12.420 Euro4	309	420	09/06	>				S 5613 PO
inner / interno	Scania DT12.12.420 Euro4	309	420	09/06	>			S 7649 A	
power steering / servosterzo	Scania DT12.12.420 Euro4	309	420	09/06	>				S 3081 PO
GT 13.9 m	Scania DT12.17.480 Euro4	353	480	09/07	>	S 4402 R	S 6010 NE	S 7A11 A	
with automatic gearbox ZF 6HP592/6HP692 / con cambio automatico ZF 6HP592/6HP692	Scania DT12.17.480 Euro4	353	480	09/07	>				S 2234 Z
retarder / freno di rallentamento	Scania DT12.17.480 Euro4	353	480	09/07	>				S 5613 PO
inner / interno	Scania DT12.17.480 Euro4	353	480	09/07	>			S 7649 A	
power steering / servosterzo	Scania DT12.17.480 Euro4	353	480	09/07	>				S 3081 PO
GT 15 m	Scania DT12.03.470 Euro4	345	470	09/06	>	S 4402 R	S 6010 NE	S 7A11 A	
with automatic gearbox ZF 6HP592/6HP692 / con cambio automatico ZF 6HP592/6HP692	Scania DT12.03.470 Euro4	345	470	09/06	>				S 2234 Z
retarder / freno di rallentamento	Scania DT12.03.470 Euro4	345	470	09/06	>				S 5613 PO
inner / interno	Scania DT12.03.470 Euro4	345	470	09/06	>			S 7649 A	
power steering / servosterzo	Scania DT12.03.470 Euro4	345	470	09/06	>				S 3081 PO
GT 15 m	Scania DT12.12.420 Euro4	309	420	09/06	>	S 4402 R	S 6010 NE	S 7A11 A	
with automatic gearbox ZF 6HP592/6HP692 / con cambio automatico ZF 6HP592/6HP692	Scania DT12.12.420 Euro4	309	420	09/06	>				S 2234 Z
retarder / freno di rallentamento	Scania DT12.12.420 Euro4	309	420	09/06	>				S 5613 PO
inner / interno	Scania DT12.12.420 Euro4	309	420	09/06	>			S 7649 A	
power steering / servosterzo	Scania DT12.12.420 Euro4	309	420	09/06	>				S 3081 PO
GT 15 m	Scania DT12.17.480 Euro4	353	480	09/07	>	S 4402 R	S 6010 NE	S 7A11 A	
with automatic gearbox ZF 6HP592/6HP692 / con cambio automatico ZF 6HP592/6HP692	Scania DT12.17.480 Euro4	353	480	09/07	>				S 2234 Z
retarder / freno di rallentamento	Scania DT12.17.480 Euro4	353	480	09/07	>				S 5613 PO
inner / interno	Scania DT12.17.480 Euro4	353	480	09/07	>			S 7649 A	
power steering / servosterzo	Scania DT12.17.480 Euro4	353	480	09/07	>				S 3081 PO

ISUZU**trucks/autocarri****Forward Serie**

F110.210	4HK1-E6S Euro 6	154	210	02/14	>	S 3577 R			✗
N110.210	4HK1-E6S Euro 6	154	210	02/14	>	S 3577 R			✗
N210.190	4HK1-TCS Euro 4/5/EEV	140	190	06/06	>	S 3577 R			✗
N75.190	4HK1-TCS Euro 4/5/EEV	140	190	01/06	>	S 3577 R			✗

N Serie

L 35 A	prefilter RACOR / prefiltrato RACOR	4JJ1-TCS	110	150	01/10	>		S 4138 NR	
---------------	-------------------------------------	----------	-----	-----	-------	---	--	-----------	--

NPR Serie

NPR 300	4HK1-TCN	110	150	07/08	>	S 3577 R			✗
NPR 400	4HK1-TCN	110	150	07/08	>	S 3577 R			✗
NPR 75L	4HK1-TCS Euro 4/5/EEV	140	190	07/08	>	S 3577 R			✗

NPS Serie

NPS 250	4HE1-XN	103	140	06/98	> 12/02	S 3577 R			✗
	4HE1-XN	103	140	01/03	>				✗
NPS 300	4HE1-XN	103	140	06/98	> 12/02	S 3577 R			✗
	4HE1-XN	103	140	01/03	>				✗

NQR Serie

NQR 500	4HK1-TCN	110	150	07/08	>	S 3577 R			✗
NQR 70	4HE1-TC	107	145	06/98	>	S 3577 R			✗
NQR 75	4HK1-TCS Euro 4/5/EEV	140	190	06/06	>	S 3577 R			✗



kW HP



IVECO

trucks/autocarri

100 Serie

100.13	8060.04		S 0700 R	S 7111 NC		
some / alcuni	8060.04		S 0700 R	S 8500 NR		
with antidraining pipe / con tubo antisvuotamento	8060.04		S 9610 R	S 7111 NC		
100EC			S 0700 R	S 7111 NC		
with antidraining pipe / con tubo antisvuotamento			S 9610 R	S 7111 NC		
100NC			S 0700 R	S 7111 NC		
with antidraining pipe / con tubo antisvuotamento			S 9610 R	S 7111 NC		
OMN100			S 0700 R	S 7111 NC		
with antidraining pipe / con tubo antisvuotamento			S 9610 R	S 7111 NC		

109 Serie

109.17	8060.24, 8060.25		S 0700 R	S 8500 NR	S 5650 A	
	8060.24, 8060.25		S 3003 DR			
some / alcuni	8060.24, 8060.25			S 8500 NR	S 2450 A	
some / alcuni	8060.24, 8060.25			S 8500 NR	S 2650 A	
some / alcuni	8060.24, 8060.25			S 8500 NR	S 5650 A	
with IVECO 1902134 / con IVECO 1902134	8060.24, 8060.25			S 5400 NR		
with drain / con spurgo	8060.24, 8060.25			S 8500 NR		
with antidraining pipe (- N.334356) / con tubo antisvuotamento (- N.334356)	8060.24, 8060.25		S 9610 R			
assembly DELPHI / montaggio DELPHI	8060.24, 8060.25			S 7111 NC		

110 Serie

110.13	8060.04		S 0700 R	S 7111 NC	S 0940 A	
with antidraining pipe / con tubo antisvuotamento	8060.04		S 9610 R	S 8500 NR	S 0940 A	
110.13	KHD F6L913		S 8600 R	S 5400 NR	S 0950 A	
some / alcuni	KHD F6L913		S 8600 R	S 5400 NR	S 0270 A	
110.14 (4x4)			S 0700 R	S 7111 NC		
with antidraining pipe / con tubo antisvuotamento			S 9610 R	S 7111 NC		
110.14P (4x4)			S 0700 R	S 7111 NC		
with antidraining pipe / con tubo antisvuotamento			S 9610 R	S 7111 NC		
110.16	KHD F6L913		S 8600 R	S 5400 NR	S 2450 A	
110.17 W (4x4)			S 3003 DR	S 8500 NR	S 2450 A	
some / alcuni			S 3003 DR	S 8500 NR	S 2650 A	
110D11	KHD F6L912		S 8600 R	S 5400 NR	S 0950 A	
2nd passage / 2.passaggio	KHD F6L912			S 8501 NR		
110D7	KHD F6L912		S 8600 R	S 5400 NR	S 0950 A	
2nd passage / 2.passaggio	KHD F6L912			S 8501 NR		
110D8	KHD F6L912		S 8600 R	S 5400 NR	S 0950 A	
2nd passage / 2.passaggio	KHD F6L912			S 8501 NR		
110D9	KHD F6L912		S 8600 R	S 5400 NR	S 0950 A	
2nd passage / 2.passaggio	KHD F6L912			S 8501 NR		
110NC			S 0700 R	S 7111 NC		
with antidraining pipe / con tubo antisvuotamento			S 9610 R	S 7111 NC		
OMN110/10			S 9710 R	S 0610 NR		

115 Serie

115.14	8060.04, 8060.05	> 10/85	S 0700 R	S 7111 NC	S 5650 A	
	8060.04, 8060.05	11/85 >	S 3003 DR	S 8500 NR	S 5650 A	
with antidraining pipe / con tubo antisvuotamento	8060.04, 8060.05	> 10/85	S 9610 R	S 7111 NC	S 5650 A	
power steering / servosterzo	8060.04, 8060.05					S 3081 PO
115.17						
with pump BOSCH / con pompa BOSCH	8060.24	09/83 > 12/85	S 3003 DR	S 5401 NR	S 2450 A	
with pump DELPHI / con pompa DELPHI	8060.24	09/83 > 12/85	S 3003 DR	S 7111 NC	S 2450 A	
115.17						
some / alcuni	8060.25	01/86 >	S 3003 DR	S 5401 NR	S 5650 A	
with pump BOSCH / con pompa BOSCH	8060.25	01/86 >	S 3003 DR	S 5401 NR	S 2450 A	
with pump DELPHI / con pompa DELPHI	8060.25	01/86 >	S 3003 DR	S 7111 NC	S 2450 A	

120 Serie

120.13	8060.04		S 0700 R	S 7111 NC	S 2670 A	
some / alcuni	8060.04		S 0700 R	S 8500 NR	S 2670 A	
with antidraining pipe / con tubo antisvuotamento	8060.04		S 9610 R	S 7111 NC	S 2670 A	
120.13	KHD F6L913		S 8600 R	S 5400 NR	S 0950 A	
some / alcuni	KHD F6L913		S 8600 R	S 5400 NR	S 0270 A	
120.14	8360.04		S 0230 R	S 0710 NR	S 2670 A	S 8410 AR
120.16	KHD BF6L913		S 8600 R	S 5400 NR	S 2450 A	
some / alcuni	KHD BF6L913		S 9030 R	S 5400 NR	S 0270 A	
inner / interno	KHD BF6L913				S 3940 A	
120.17H			S 0230 R	S 0710 NR	S 2650 A	S 8410 AR
inner / interno					S 7129 A	



KW HP



...IVECO - trucks/autocarri

120.17HW inner / interno			S 0230 R	S 0710 NR	S 2650 A S 7129 A	S 8410 AR
120D11 1st passage / 1.passaggio 2nd passage / 2.passaggio	KHD F6L912 KHD F6L912 KHD F6L912		S 8600 R S 8600 R	S 5400 NR S 8501 NR	S 0950 A S 0950 A	
120D12 1st passage / 1.passaggio 2nd passage / 2.passaggio	KHD F6L912 KHD F6L912 KHD F6L912		S 8600 R S 8600 R	S 5400 NR S 8501 NR	S 0950 A S 0950 A	
120D13 1st passage / 1.passaggio 2nd passage / 2.passaggio	KHD F6L912 KHD F6L912 KHD F6L912		S 8600 R S 8600 R	S 5400 NR S 8501 NR	S 0950 A S 0950 A	
120D13 120D7	KHD F6L913 KHD F6L912		S 8600 R S 8600 R	S 5400 NR S 5400 NR	S 0270 A S 0950 A	
1st passage / 1.passaggio 2nd passage / 2.passaggio	KHD F6L912 KHD F6L912		S 8600 R S 8600 R	S 5400 NR S 8501 NR	S 0950 A S 0950 A	
120D9 1st passage / 1.passaggio 2nd passage / 2.passaggio	KHD F6L912 KHD F6L912 KHD F6L912		S 8600 R S 8600 R	S 5400 NR S 8501 NR	S 0950 A S 0950 A	
130 Serie						
130 to engine No. 006980 / a motore N. 006980 from engine No. 006981 / da motore N. 006981			S 9710 R S 0230 R	S 7200 N S 7200 N		
130.13 some / alcuni	KHD F6L913 KHD F6L913		S 8600 R S 8600 R	S 5400 NR S 5400 NR	S 0950 A S 0270 A	
130.16 some / alcuni inner / interno	KHD BF6L913 KHD BF6L913 KHD BF6L913		S 8600 R S 9030 R	S 5400 NR S 5400 NR	S 2450 A S 0270 A S 3940 A	
130.20 130D11	KHD F6L913 KHD F6L913		S 8600 R S 8600 R	S 0710 NR S 5400 NR	S 7142 A S 0270 A	
130D12 130D12AK	KHD F6L913 KHD		S 8600 R S 8600 R	S 5400 NR S 5400 NR	S 0270 A S 0950 A	
inner / interno	KHD				S 1940 A	
130D12K inner / interno	KHD KHD		S 8600 R	S 5400 NR	S 0950 A S 1940 A	
130D14 130D15 130D16	KHD F6L913 KHD F6L913 KHD F6L913		S 8600 R S 8600 R S 8600 R	S 5400 NR S 5400 NR S 5400 NR	S 0270 A S 0270 A S 0270 A	
130D9 130M11 130M13 130M14 130M7 130M8 130M8 130M9	KHD F6L913 KHD F6L913 KHD F6L913 KHD F6L913 KHD F6L913 KHD BF6L913 KHD F6L913 KHD F6L913		S 8600 R S 8600 R S 8600 R S 8600 R S 8600 R S 8600 R S 8600 R S 8600 R	S 5400 NR S 5400 NR S 5400 NR S 5400 NR S 5400 NR S 5400 NR S 5400 NR S 5400 NR	S 0270 A S 0270 A S 0950 A S 0950 A S 0950 A S 2450 A S 0950 A S 0950 A	
135 Serie						
135.14 with antidraining pipe / con tubo antisvuotamento power steering / servosterzo	8060.04, 8060.05 8060.04, 8060.05 8060.04, 8060.05 8060.04, 8060.05	> 10/85 11/85 > > 10/85	S 0700 R S 3003 DR S 9610 R	S 7111 NC S 8500 NR S 7111 NC	S 5650 A S 5650 A S 5650 A	S 3081 PO
135.17 some / alcuni some / alcuni some / alcuni with IVECO 1902134 / con IVECO 1902134 with drain / con spurgo with antidraining pipe (- N.334356) / con tubo antisvuotamento (- N.334356) assembly DELPHI / montaggio DELPHI	8060.24, 8060.25 8060.24, 8060.25 8060.24, 8060.25 8060.24, 8060.25 8060.24, 8060.25 8060.24, 8060.25 8060.24, 8060.25 8060.24, 8060.25		S 0700 R S 3003 DR	S 8500 NR S 8500 NR S 8500 NR S 8500 NR S 5400 NR S 8500 NR	S 5650 A S 2450 A S 2650 A S 5650 A	
135D10 2nd passage / 2.passaggio	KHD F6L312 KHD F6L312		S 8600 R	S 0201 N S 1411 N		
135D11 2nd passage / 2.passaggio	KHD F6L312 KHD F6L312		S 8600 R	S 0201 N S 1411 N		
135D11 135D12	KHD F6L912 KHD F6L312		S 8600 R S 8600 R	S 5400 NR S 0201 N	S 0950 A	
2nd passage / 2.passaggio	KHD F6L312			S 1411 N		
135D12	KHD F6L912		S 8600 R	S 5400 NR	S 0950 A	



kW HP



...IVECO - trucks/autocarri

135D13	KHD F6L912		S 8600 R	S 5400 NR	S 0950 A	
135D14	KHD		S 8600 R	S 5400 NR	S 0270 A	
135D14	KHD F6L912		S 8600 R	S 5400 NR	S 0950 A	
135D15	KHD F6L312		S 8600 R	S 0201 N		
2nd passage / 2.passaggio	KHD F6L312			S 1411 N		
140 Serie						
140.13	KHD F6L913		S 8600 R	S 5400 NR	S 0950 A	
some / alcuni	KHD F6L913		S 8600 R	S 5400 NR	S 0270 A	
140.14	8360.04		S 0230 R	S 0710 NR	S 2670 A	S 8410 AR
140.19	KHD BF6L913		S 9030 R	S 5400 NR	S 2650 A	
some / alcuni	KHD BF6L913		S 9030 R	S 5400 NR	S 0270 A	
inner / interno	KHD BF6L913				S 7129 A	
140.20			S 8600 R		S 2670 A	S 8410 AR
145 Serie						
145.17	8060.24, 8060.25		S 0700 R	S 8500 NR	S 5650 A	
some / alcuni	8060.24, 8060.25		S 3003 DR			
some / alcuni	8060.24, 8060.25			S 8500 NR	S 2450 A	
some / alcuni	8060.24, 8060.25			S 8500 NR	S 2650 A	
some / alcuni	8060.24, 8060.25			S 8500 NR	S 5650 A	
with IVECO 1902134 / con IVECO 1902134	8060.24, 8060.25			S 5400 NR		
with drain / con spurgo	8060.24, 8060.25			S 8500 NR		
with antidraining pipe (- N.334356) / con tubo antisvuotamento (- N.334356)	8060.24, 8060.25		S 9610 R			
assembly DELPHI / montaggio DELPHI	8060.24, 8060.25			S 7111 NC		
150 Serie						
150.14	8360.04		S 0230 R	S 0710 NR	S 2670 A	S 8410 AR
150.16	KHD BF6L913		S 8600 R	S 5400 NR	S 2450 A	
some / alcuni	KHD BF6L913		S 9030 R	S 5400 NR	S 0270 A	
inner / interno	KHD BF6L913				S 3940 A	
150.17	8060.24, 8060.25			S 8500 NR	S 5650 A	
to engine No. 334356 / a motore N. 334356	8060.24, 8060.25		S 0700 R			
some / alcuni	8060.24, 8060.25			S 8500 NR	S 2450 A	
some / alcuni	8060.24, 8060.25			S 8500 NR	S 2650 A	
with IVECO 1902134 / con IVECO 1902134	8060.24, 8060.25			S 5400 NR		
with antidraining pipe / con tubo antisvuotamento	8060.24, 8060.25		S 9610 R			
from engine No. 334357 / da motore N. 334357	8060.24, 8060.25		S 3003 DR			
assembly DELPHI / montaggio DELPHI	8060.24, 8060.25			S 7111 NC		
150.17	OM 8360.05	07/82 > 09/86	S 0230 R	S 0710 NR		S 8410 AR
150.17 (var. 740)	OM 8360.05	07/82 > 09/86	S 0230 R	S 0710 NR	S 2650 A	S 8410 AR
some / alcuni	OM 8360.05	07/82 > 09/86	S 0230 R	S 0710 NR	S 0550 A	S 8410 AR
150.18	KHD F6L413		S 8600 R	S 5400 NR	S 0950 A	
2nd passage / 2.passaggio	KHD F6L413			S 7411 N		
some / alcuni	KHD F6L413		S 8600 R	S 7411 N	S 0270 A	
outer / esterno	KHD F6L413		S 8600 R	S 7411 N	S 0950 A	
outer / esterno	KHD F6L413		S 8600 R	S 7411 N	S 2450 A	
inner / interno	KHD F6L413		S 8600 R	S 7411 N	S 1940 A	
inner / interno	KHD F6L413		S 8600 R	S 7411 N	S 3940 A	
150.23	KHD F8L413		S 8600 R	S 5400 NR	S 0270 A	
150D13	KHD F6L312		S 8600 R	S 0201 N		
2nd passage / 2.passaggio	KHD F6L312			S 1411 N		
150NC17			S 0230 R	S 7200 N		S 8410 AR
150NC20			S 8600 R	S 0710 NR		S 8410 AR
some / alcuni			S 8600 R		S 7142 A	S 8410 AR
156 Serie						
156D15	IVD F6L814, F6L714, F6L814, F10L714, F10L814			S 0201 N		
2nd passage / 2.passaggio	IVD F6L814, F6L714, F6L814, F10L714, F10L814			S 1411 N		
power steering / servosterzo	IVD F6L814, F6L714, F6L814, F10L714, F10L814					S 8790 PO
156D16	IVD F6L814, F6L714, F6L814, F10L714, F10L814			S 0201 N		
2nd passage / 2.passaggio	IVD F6L814, F6L714, F6L814, F10L714, F10L814			S 1411 N		
power steering / servosterzo	IVD F6L814, F6L714, F6L814, F10L714, F10L814					S 8790 PO
156D22	IVD F6L814, F6L714, F6L814, F10L714, F10L814			S 0201 N		
2nd passage / 2.passaggio	IVD F6L814, F6L714, F6L814, F10L714, F10L814			S 1411 N		
power steering / servosterzo	IVD F6L814, F6L714, F6L814, F10L714, F10L814					S 8790 PO
159 Serie						
159.17			S 0700 R			
to engine No. 334356 / a motore N. 334356	8060.24, 8060.25			S 8500 NR	S 2450 A	
some / alcuni	8060.24, 8060.25			S 8500 NR	S 2650 A	
some / alcuni	8060.24, 8060.25					



kW HP



...IVECO - trucks/autocarri

some / alcuni	8060.24, 8060.25				S 8500 NR	S 5650 A	
with IVECO 1902134 / con IVECO 1902134	8060.24, 8060.25				S 5400 NR		
with antidraining pipe / con tubo antisvuotamento	8060.24, 8060.25			S 9610 R			
from engine No. 334357 / da motore N. 334357	8060.24, 8060.25			S 3003 DR			
assembly DELPHI / montaggio DELPHI	8060.24, 8060.25				S 7111 NC		
159.17	8360.05	124 169	07/82 > 09/86	S 0230 R	S 0710 NR		S 8410 AR
159.17 (var. 740)	8360		07/82 > 09/86	S 0230 R	S 0710 NR	S 2650 A	S 8410 AR
some / alcuni	8360		07/82 > 09/86	S 0230 R	S 0710 NR	S 0550 A	S 8410 AR
159.20				S 8600 R		S 2670 A	S 8410 AR
159NC17				S 0230 R	S 7200 N		S 8410 AR
159NC20				S 8600 R	S 0710 NR		S 8410 AR
some / alcuni				S 8600 R		S 7142 A	S 8410 AR
160 Serie							
160.16	KHD BF6L913			S 8600 R	S 5400 NR	S 2650 A	
some / alcuni	KHD BF6L913			S 9030 R	S 6710 NR	S 0270 A	
inner / interno	KHD BF6L913					S 7129 A	
160.19	KHD F6L413/913			S 8600 R	S 5400 NR	S 2450 A	
inner / interno	KHD F6L413/913					S 3940 A	
160.23	KHD F8L413/F8L413F	168 228	04/84 > 05/89	S 8600 R	S 5400 NR	S 0450 A	
160.23AH	KHD F8L413F	168 228	04/84 > 05/89	S 8600 R	S 5400 NR	S 0450 A	
160.23AHW	KHD F8L413F	168 228	04/84 > 05/89	S 8600 R	S 5400 NR	S 0450 A	
160.26				S 0230 R	S 0710 NR		
160.30AH	KHD BF8L513	225 306	06/86 > 05/89	S 8600 R	S 5400 NR	S 0450 A	
power steering / servosterzo	KHD BF8L513	225 306	06/86 > 05/89				S 3081 PO
160.30AHW	KHD BF8L513	225 306	06/86 > 05/89	S 8600 R	S 5400 NR	S 0450 A	
power steering / servosterzo	KHD BF8L513	225 306	06/86 > 05/89				S 3081 PO
160D11	KHD BF6L913			S 8600 R	S 5400 NR	S 2450 A	
some / alcuni	KHD BF6L913			S 9030 R	S 5400 NR	S 0270 A	
160D12	KHD BF6L913			S 8600 R	S 5400 NR	S 2450 A	
some / alcuni	KHD BF6L913			S 9030 R	S 5400 NR	S 0270 A	
160D14	KHD BF6L913			S 8600 R	S 5400 NR	S 2450 A	
some / alcuni	KHD BF6L913			S 9030 R	S 5400 NR	S 0270 A	
160D15	KHD BF6L913			S 8600 R	S 5400 NR	S 2450 A	
some / alcuni	KHD BF6L913			S 9030 R	S 5400 NR	S 0270 A	
160D16	KHD BF6L913			S 8600 R	S 5400 NR	S 2450 A	
some / alcuni	KHD BF6L913			S 9030 R	S 5400 NR	S 0270 A	
160M11	KHD BF6L913			S 8600 R	S 5400 NR	S 2450 A	
some / alcuni	KHD BF6L913			S 9030 R	S 5400 NR	S 2650 A	
160M13	KHD BF6L913			S 8600 R	S 5400 NR	S 2450 A	
some / alcuni	KHD BF6L913			S 9030 R	S 5400 NR	S 2650 A	
160M15	KHD BF6L913			S 8600 R	S 5400 NR	S 2450 A	
some / alcuni	KHD BF6L913			S 9030 R	S 5400 NR	S 2650 A	
160M16	KHD BF6L913			S 8600 R	S 5400 NR	S 2650 A	
some / alcuni	KHD BF6L913			S 9030 R	S 6710 NR	S 0270 A	
inner / interno	KHD BF6L913					S 7129 A	
160M8	KHD BF6L913			S 8600 R	S 5400 NR	S 2450 A	
some / alcuni	KHD BF6L913			S 9030 R	S 5400 NR	S 2650 A	
160NC				S 0230 R	S 0710 NR		
160NT				S 0230 R	S 0710 NR		
165 Serie							
165.24				S 8600 R	S 0710 NR	S 2650 A	S 8410 AR
168 Serie							
168M14	KHD BF6L913			S 8600 R	S 5400 NR	S 2650 A	
some / alcuni	KHD BF6L913			S 9030 R	S 5400 NR	S 2650 A	
168M16	KHD BF6L913			S 8600 R	S 5400 NR	S 2650 A	
some / alcuni	KHD BF6L913			S 9030 R	S 5400 NR	S 2650 A	
170 Serie							
170.18	KHD F6L413			S 8600 R	S 5400 NR		
1st passage / 1.passaggio	KHD F6L413			S 8600 R	S 0101 N		
2nd passage / 2.passaggio	KHD F6L413			S 8600 R	S 7411 N		
some / alcuni	KHD F6L413			S 8600 R	S 7411 N	S 0270 A	
outer / esterno	KHD F6L413			S 8600 R	S 7411 N	S 0950 A	
outer / esterno	KHD F6L413			S 8600 R	S 7411 N	S 2450 A	
inner / interno	KHD F6L413			S 8600 R	S 7411 N	S 1940 A	
inner / interno	KHD F6L413			S 8600 R	S 7411 N	S 3940 A	
170.20				S 8600 R	S 0710 NR		S 8410 AR
some / alcuni				S 8600 R			S 8410 AR

**KW HP****...IVECO - trucks/autocarri**

170.23AH dryer filter / filtro essiccatore	KHD BF8L513/F8L513	174	237	04/88 >	12/93	S 8600 R	S 5400 NR	S 0450 A	S 7259 A
170.23AHW dryer filter / filtro essiccatore	KHD F8L513	174	237	04/88 >	12/93	S 8600 R	S 5400 NR	S 0450 A	S 7259 A
170.25AH dryer filter / filtro essiccatore	KHD F8L513	194	264	03/89 >	12/93	S 8600 R	S 5400 NR	S 0450 A	S 7259 A
170.25AHW dryer filter / filtro essiccatore	KHD F8L513	194	264	03/89 >	12/93	S 8600 R	S 5400 NR	S 0450 A	S 7259 A
170.26						S 0230 R	S 0710 NR		S 8410 AR
170.34AH dryer filter / filtro essiccatore	KHD BF8L513	250	340	03/89 >	12/93	S 8600 R	S 5400 NR	S 0450 A	S 7259 A
170.34AHW dryer filter / filtro essiccatore	KHD BF8L513	250	340	03/89 >	12/93	S 8600 R	S 5400 NR	S 0450 A	S 7259 A
170.35						S 0230 R	S 0710 NR		S 8410 AR
170D11AK	KHD					S 8600 R	S 5400 NR	S 0950 A	
170D11FA 2nd passage / 2.passaggio	KHD					S 8600 R	S 0101 N	S 0270 A	
170D11FL 2nd passage / 2.passaggio	KHD					S 8600 R	S 0101 N	S 0270 A	
170D12AK	KHD					S 8600 R	S 5400 NR	S 0950 A	
170D12FL 2nd passage / 2.passaggio	KHD					S 8600 R	S 0101 N	S 0270 A	
170D13AK	KHD					S 8600 R	S 5400 NR	S 0950 A	
170D13FK 2nd passage / 2.passaggio	KHD					S 8600 R	S 0101 N	S 0270 A	
170D13FL 2nd passage / 2.passaggio	KHD					S 8600 R	S 0101 N	S 0270 A	
170D13FS 2nd passage / 2.passaggio	KHD					S 8600 R	S 0101 N	S 0270 A	
170D14A	KHD					S 8600 R	S 5400 NR	S 0950 A	
170D14FK 2nd passage / 2.passaggio	KHD					S 8600 R	S 0101 N	S 0270 A	
170D14FL 2nd passage / 2.passaggio	KHD					S 8600 R	S 0101 N	S 0270 A	
170D15AK/2	KHD					S 8600 R	S 5400 NR	S 0950 A	
170D15FK 2nd passage / 2.passaggio	KHD					S 8600 R	S 0101 N	S 0270 A	
170D15FL 2nd passage / 2.passaggio	KHD					S 8600 R	S 0101 N	S 0270 A	
170D16AK	KHD					S 8600 R	S 5400 NR	S 0950 A	
170D16FAK 2nd passage / 2.passaggio	KHD					S 8600 R	S 0101 N	S 0270 A	
170D16FK 2nd passage / 2.passaggio	KHD					S 8600 R	S 0101 N	S 0270 A	
170D17AK	KHD					S 8600 R	S 5400 NR	S 0950 A	
170D17FAK 2nd passage / 2.passaggio	KHD					S 8600 R	S 0101 N	S 0270 A	
170D17FK 2nd passage / 2.passaggio	KHD					S 8600 R	S 0101 N	S 0270 A	
170D17FL 2nd passage / 2.passaggio	KHD					S 8600 R	S 0101 N	S 0270 A	
170D19AK/L	KHD					S 8600 R	S 5400 NR	S 0950 A	
170D19FK 2nd passage / 2.passaggio	KHD					S 8600 R	S 0101 N	S 0270 A	
170D19FL 2nd passage / 2.passaggio	KHD					S 8600 R	S 0101 N	S 0270 A	
170D21AK	KHD					S 8600 R	S 5400 NR	S 0950 A	
170D21FK 2nd passage / 2.passaggio	KHD					S 8600 R	S 0101 N	S 0270 A	
170D21FL 2nd passage / 2.passaggio	KHD					S 8600 R	S 0101 N	S 0270 A	
170NC26						S 0230 R	S 0710 NR		
170NC33						S 0230 R	S 0710 NR		
170NC33 var. 848						S 0230 R	S 0710 NR		S 8410 AR
175 Serie									
175.17 or / oppure						S 3003 DR	S 5401 NR	S 2650 A	
						S 3003 DR	S 5400 NR	S 2650 A	





kW HP



...IVECO - trucks/autocarri

175.24	8460.21				S 5003 DR	S 0710 NR	S 2650 A	S 8410 AR
180 Serie								
180.24					S 8600 R	S 0710 NR	S 6550 A	S 8410 AR
180.26					S 0230 R	S 0710 NR	S 6550 A	
180D12	KHD F8L312				S 8600 R	S 0201 N		
2nd passage / 2.passaggio	KHD F8L312					S 1411 N		
power steering / servosterzo	KHD F8L312							S 8790 PO
180NC					S 0230 R	S 0710 NR		
186 Serie								
186D13	KHD F8L312				S 8600 R	S 0201 N		
2nd passage / 2.passaggio	KHD F8L312					S 1411 N		
power steering / servosterzo	KHD F8L312							S 8790 PO
186D15	KHD F8L312				S 8600 R	S 0201 N		
2nd passage / 2.passaggio	KHD F8L312					S 1411 N		
power steering / servosterzo	KHD F8L312							S 8790 PO
190 Serie								
190.18	KHD F6L413				S 8600 R	S 5400 NR		
1st passage / 1.passaggio	KHD F6L413				S 8600 R	S 0101 N		
2nd passage / 2.passaggio	KHD F6L413				S 8600 R	S 7411 N		
some / alcuni	KHD F6L413				S 8600 R	S 7411 N	S 0270 A	
outer / esterno	KHD F6L413				S 8600 R	S 7411 N	S 0950 A	
outer / esterno	KHD F6L413				S 8600 R	S 7411 N	S 2450 A	
inner / interno	KHD F6L413				S 8600 R	S 7411 N	S 1940 A	
inner / interno	KHD F6L413				S 8600 R	S 7411 N	S 3940 A	
190.20					S 8600 R	S 0710 NR		S 8410 AR
some / alcuni					S 8600 R			S 8410 AR
190.20N					S 8600 R	S 0710 NR	S 2650 A	S 8410 AR
some / alcuni					S 8600 R		S 2650 A	S 8410 AR
inner / interno							S 7129 A	
190.25	KHD F8L413	188 256	07/83 > 06/86		S 8600 R	S 5400 NR	S 0450 A	
some / alcuni	KHD F8L413	188 256	07/83 > 06/86		S 8600 R	S 5400 NR	S 2650 A	
some / alcuni	KHD F8L413	188 256	07/83 > 06/86		S 8600 R	S 5400 NR	S 2450 A	
190.25AH	KHD F8L413F	188 256	07/83 > 06/86		S 8600 R	S 5400 NR	S 0450 A	
some / alcuni	KHD F8L413F	188 256	07/83 > 06/86		S 8600 R	S 5400 NR	S 2650 A	
some / alcuni	KHD F8L413F	188 256	07/83 > 06/86		S 8600 R	S 5400 NR	S 2450 A	
190.25AHW	KHD F8L413F	188 256	07/83 > 06/86		S 8600 R	S 5400 NR	S 0450 A	
some / alcuni	KHD F8L413F	188 256	07/83 > 06/86		S 8600 R	S 5400 NR	S 2650 A	
some / alcuni	KHD F8L413F	188 256	07/83 > 06/86		S 8600 R	S 5400 NR	S 2450 A	
190.26					S 0230 R	S 0710 NR		S 8410 AR
190.26	8460.21		09/86 >		S 5003 DR	S 0710 NR	S 7546 A	S 8410 AR
190.26 (3^ Serie)					S 0230 R	S 0710 NR	S 6550 A	S 8410 AR
190.26H					S 0230 R	S 0710 NR	S 0450 A	
190.26HT					S 0230 R	S 0710 NR	S 0450 A	
190.26N					S 0230 R	S 0710 NR	S 0450 A	
190.26NT					S 0230 R	S 0710 NR	S 0450 A	
190.29	KHD BF8L413				S 8600 R	S 6710 NR	S 7546 A	
some / alcuni	KHD BF8L413				S 8600 R	S 6710 NR	S 0450 A	
some / alcuni	KHD BF8L413				S 8600 R	S 6710 NR	S 0270 A	
190.30			> 12/84		S 0230 R	S 0710 NR	S 6550 A	
			01/85 > 09/86		S 5003 DR	S 0710 NR	S 6550 A	
			10/86 >		S 5003 DR	S 0710 NR	S 7546 A	
some / alcuni			01/85 >		S 5003 DR	S 0710 NR	S 4270 A	
dryer filter / filtro essiccatore			01/85 >					S 7259 A
190.30 G.V.			01/88 >		S 5003 DR	S 0710 NR	S 0450 A	
dryer filter / filtro essiccatore			01/88 >					S 7259 A
190.30H	8210.22				S 0230 R	S 0710 NR	S 0450 A	
some / alcuni	8210.22				S 0230 R	S 0710 NR	S 7546 A	
some 1902096 / alcuni 1902096	8210.22					S 4311 N		
dryer filter / filtro essiccatore	8210.22							S 7259 A
power steering / servosterzo	8210.22							S 3081 PO
190.30HT					S 0230 R	S 0710 NR	S 0450 A	
190.32			04/87 >		S 5003 DR	S 0710 NR	S 0450 A	S 8410 AR
190.32 AH	KHD F10L413F		01/83 > 12/85		S 8600 R	S 6710 NR	S 0450 A	
some / alcuni	KHD F10L413F		01/83 > 12/85		S 8600 R	S 5400 NR	S 0450 A	
190.32 G.V.			01/89 >		S 5003 DR	S 0710 NR	S 6550 A	S 8410 AR
190.35					S 0230 R	S 0710 NR	S 0450 A	S 8410 AR
190.35H					S 0230 R	S 0710 NR	S 0450 A	S 8410 AR



| kW | HP |



...IVECO - trucks/autocarri

190.35HT			S 0230 R	S 0710 NR	S 0450 A	S 8410 AR
190NC26			S 0230 R	S 0710 NR		
190NC33			S 0230 R	S 0710 NR		
190NC33 var. 298-652-876			S 0230 R	S 0710 NR		S 8410 AR
190PAC20			S 8600 R	S 0710 NR	S 2650 A	S 8410 AR
some / alcuni			S 8600 R		S 2650 A	S 8410 AR
some / alcuni			S 8600 R	S 0710 NR	S 2650 A	S 8410 AR
inner / interno					S 7129 A	
190PAC26			S 0230 R	S 0710 NR	S 0450 A	
190PAT26			S 0230 R	S 0710 NR	S 0450 A	
190PC26			S 0230 R	S 0710 NR	S 0450 A	
190PC30			S 0230 R	S 0710 NR	S 0450 A	
190PC35			S 0230 R	S 0710 NR	S 0450 A	S 8410 AR
190PT26			S 0230 R	S 0710 NR	S 0450 A	
190PT30			S 0230 R	S 0710 NR	S 0450 A	
190PT35			S 0230 R	S 0710 NR	S 0450 A	S 8410 AR
190T	Unic V85S/4				S 7968 A	
power steering / servosterzo	Unic V85S/4					S 8790 PO
192 Serie						
192M14	KHD BF6L913		S 9030 R	S 5400 NR	S 2650 A	
some / alcuni	KHD BF6L913		S 9030 R	S 5400 NR	S 0270 A	
inner / interno	KHD BF6L913				S 7129 A	
192M16	KHD F6L413F		S 8600 R	S 5400 NR	S 2450 A	
inner / interno	KHD F6L413F				S 3940 A	
192M16 Turbo	KHD BF6L913		S 9030 R	S 5400 NR	S 2650 A	
some / alcuni	KHD BF6L913		S 9030 R	S 5400 NR	S 0270 A	
inner / interno	KHD BF6L913				S 7129 A	
195 Serie						
195	V4D F6L814, F6L714, F6L814, F10L714, F10L814		S 8790 PO	S 0201 N		
2nd passage / 2.passaggio	V4D F6L814, F6L714, F6L814, F10L714, F10L814			S 1411 N		
power steering / servosterzo	V4D F6L814, F6L714, F6L814, F10L714, F10L814					S 8790 PO
200 Serie						
200D16	V4D F6L814, F6L714, F6L814, F10L714, F10L814			S 0201 N		
2nd passage / 2.passaggio	V4D F6L814, F6L714, F6L814, F10L714, F10L814			S 1411 N		
power steering / servosterzo	V4D F6L814, F6L714, F6L814, F10L714, F10L814					S 8790 PO
200D22	V4D F6L814, F6L714, F6L814, F10L714, F10L814			S 0201 N		
2nd passage / 2.passaggio	V4D F6L814, F6L714, F6L814, F10L714, F10L814			S 1411 N		
power steering / servosterzo	V4D F6L814, F6L714, F6L814, F10L714, F10L814					S 8790 PO
200D26	V4D F6L814, F6L714, F6L814, F10L714, F10L814			S 0201 N		
2nd passage / 2.passaggio	V4D F6L814, F6L714, F6L814, F10L714, F10L814			S 1411 N		
power steering / servosterzo	V4D F6L814, F6L714, F6L814, F10L714, F10L814					S 8790 PO
210 Serie						
210D16	V4D F6L814, F6L714, F6L814, F10L714, F10L814			S 0201 N		
2nd passage / 2.passaggio	V4D F6L814, F6L714, F6L814, F10L714, F10L814			S 1411 N		
power steering / servosterzo	V4D F6L814, F6L714, F6L814, F10L714, F10L814					S 8790 PO
210D18	V4D F6L814, F6L714, F6L814, F10L714, F10L814			S 0201 N		
2nd passage / 2.passaggio	V4D F6L814, F6L714, F6L814, F10L714, F10L814			S 1411 N		
power steering / servosterzo	V4D F6L814, F6L714, F6L814, F10L714, F10L814					S 8790 PO
220 Serie						
220.29	KHD BF8L413	01/77 > 12/82	S 8600 R	S 6710 NR	S 7546 A	
some / alcuni	KHD BF8L413	01/77 > 12/82	S 8600 R	S 6710 NR	S 0450 A	
some / alcuni	KHD BF8L413	01/77 > 12/82	S 8600 R	S 6710 NR	S 0270 A	
220.30	assembly DONALDSON / montaggio DONALDSON		S 5003 DR	S 0710 NR	S 4270 A	
assembly MANN / montaggio MANN			S 5003 DR	S 0710 NR	S 7546 A	
220.35			S 0230 R	S 0710 NR	S 0450 A	S 8410 AR
220.36 PT			S 5003 DR	S 0710 NR	S 7546 A	
230 Serie						
230D16	KHD F8L914			S 0101 N		
2nd passage / 2.passaggio	KHD F8L914			S 7411 N		
power steering / servosterzo	KHD F8L914					S 8790 PO
230D22	KHD F8L914			S 0101 N		
2nd passage / 2.passaggio	KHD F8L914			S 7411 N		
power steering / servosterzo	KHD F8L914					S 8790 PO
230D26	KHD F8L914			S 0101 N		
2nd passage / 2.passaggio	KHD F8L914			S 7411 N		
power steering / servosterzo	KHD F8L914					S 8790 PO



KW HP



...IVECO - trucks/autocarri

232 Serie						
232D13AK	KHD		S 8600 R	S 5400 NR	S 0950 A	
232D13FK	KHD		S 8600 R	S 0101 N	S 0270 A	
2nd passage / 2.passaggio	KHD			S 7411 N		
232D13FL	KHD		S 8600 R	S 0101 N	S 0270 A	
2nd passage / 2.passaggio	KHD			S 7411 N		
232D15A	KHD		S 8600 R	S 5400 NR	S 0950 A	
232D15FK	KHD		S 8600 R	S 0101 N	S 0270 A	
2nd passage / 2.passaggio	KHD			S 7411 N		
232D15FL	KHD		S 8600 R	S 0101 N	S 0270 A	
2nd passage / 2.passaggio	KHD			S 7411 N		
232D15FS	KHD		S 8600 R	S 0101 N	S 0270 A	
2nd passage / 2.passaggio	KHD			S 7411 N		
232D16AK	KHD		S 8600 R	S 5400 NR	S 0950 A	
232D16FK	KHD		S 8600 R	S 0101 N	S 0270 A	
2nd passage / 2.passaggio	KHD			S 7411 N		
232D16FL	KHD		S 8600 R	S 0101 N	S 0270 A	
2nd passage / 2.passaggio	KHD			S 7411 N		
232D16K	KHD		S 8600 R	S 5400 NR	S 0950 A	
232D16S	KHD		S 8600 R	S 5400 NR	S 0950 A	
232D17A	KHD		S 8600 R	S 5400 NR	S 0950 A	
232D17FAK	KHD		S 8600 R	S 0101 N	S 0270 A	
2nd passage / 2.passaggio	KHD			S 7411 N		
232D17FK	KHD		S 8600 R	S 0101 N	S 0270 A	
2nd passage / 2.passaggio	KHD			S 7411 N		
232D17FL	KHD		S 8600 R	S 0101 N	S 0270 A	
2nd passage / 2.passaggio	KHD			S 7411 N		
232D17FS	KHD		S 8600 R	S 0101 N	S 0270 A	
2nd passage / 2.passaggio	KHD			S 7411 N		
232D19AK	KHD		S 8600 R	S 5400 NR	S 0950 A	
232D19FAK	KHD		S 8600 R	S 0101 N	S 0270 A	
2nd passage / 2.passaggio	KHD			S 7411 N		
232D19FK	KHD		S 8600 R	S 0101 N	S 0270 A	
2nd passage / 2.passaggio	KHD			S 7411 N		
232D19FL	KHD		S 8600 R	S 0101 N	S 0270 A	
2nd passage / 2.passaggio	KHD			S 7411 N		
232D19K	KHD		S 8600 R	S 5400 NR	S 0950 A	
232D22AK	KHD		S 8600 R	S 5400 NR	S 0950 A	
232D22FL	KHD		S 8600 R	S 0101 N	S 0270 A	
2nd passage / 2.passaggio	KHD			S 7411 N		
232D22FS	KHD		S 8600 R	S 0101 N	S 0270 A	
2nd passage / 2.passaggio	KHD			S 7411 N		
232D26AK	KHD		S 8600 R	S 5400 NR	S 0950 A	
inner / interno	KHD		S 8600 R	S 5400 NR	S 1940 A	
232D26FK	KHD		S 8600 R	S 0101 N	S 0270 A	
2nd passage / 2.passaggio	KHD			S 7411 N		
232D26FL	KHD		S 8600 R	S 0101 N	S 0270 A	
2nd passage / 2.passaggio	KHD			S 7411 N		
232D26K	KHD		S 8600 R	S 5400 NR	S 0950 A	
inner / interno	KHD		S 8600 R	S 5400 NR	S 1940 A	
232D30AK	KHD		S 8600 R	S 5400 NR	S 0950 A	
232D30FK	KHD		S 8600 R	S 0101 N	S 0270 A	
2nd passage / 2.passaggio	KHD			S 7411 N		
232D30FL	KHD		S 8600 R	S 0101 N	S 0270 A	
2nd passage / 2.passaggio	KHD			S 7411 N		
235 Serie						
235D20	KHD	VEI FOLB14, FOL714, FOLB14, F10L714, F10L814		S 0201 N		
2nd passage / 2.passaggio	KHD	VEI FOLB14, FOL714, FOLB14, F10L714, F10L814		S 1411 N		
power steering / servosterzo	KHD	VEI FOLB14, FOL714, FOLB14, F10L714, F10L814				S 8790 PO
235D22	KHD	VEI FOLB14, FOL714, FOLB14, F10L714, F10L814		S 0201 N		
2nd passage / 2.passaggio	KHD	VEI FOLB14, FOL714, FOLB14, F10L714, F10L814		S 1411 N		
power steering / servosterzo	KHD	VEI FOLB14, FOL714, FOLB14, F10L714, F10L814				S 8790 PO
240 Serie						
240.26			S 0230 R	S 0710 NR	S 6550 A	S 8410 AR
240.30		07/80 > 12/84	S 0230 R	S 0710 NR	S 6550 A	
		01/85 > 09/86	S 5003 DR	S 0710 NR	S 6550 A	
		10/86 > 04/89	S 5003 DR	S 0710 NR	S 7546 A	

**KW HP**

...IVECO - trucks/autocarri

some / alcuni			01/85 > 04/89	S 5003 DR	S 0710 NR	S 4270 A	
240.32 G.V.			01/89 >	S 5003 DR	S 0710 NR	S 6550 A	S 8410 AR
240.35				S 0230 R	S 0710 NR	S 0450 A	S 8410 AR
250 Serie							
250D22						S 0201 N	
2nd passage / 2.passaggio						S 1411 N	
power steering / servosterzo							S 8790 PO
256 Serie							
256M19AK	KHD			S 8600 R	S 5400 NR	S 2450 A	
inner / interno	KHD					S 3940 A	
256M19F	KHD			S 8600 R	S 6710 NR	S 2650 A	
256M19FAK	KHD			S 8600 R	S 5400 NR	S 0450 A	
256M19FK	KHD			S 8600 R	S 5400 NR	S 0450 A	
256M19FL	KHD			S 8600 R	S 6710 NR	S 2650 A	
256M19K	KHD			S 8600 R	S 5400 NR	S 2450 A	
inner / interno	KHD					S 3940 A	
256M19S	KHD			S 8600 R	S 5400 NR	S 2450 A	
inner / interno	KHD					S 3940 A	
256M26AK	KHD			S 8600 R	S 5400 NR	S 2450 A	
inner / interno	KHD					S 3940 A	
256M26FK	KHD			S 8600 R	S 5400 NR	S 0450 A	
256M26FKL	KHD			S 8600 R	S 5400 NR	S 0450 A	
256M26K	KHD			S 8600 R	S 5400 NR	S 2450 A	
inner / interno	KHD					S 3940 A	
256M26L	KHD			S 8600 R	S 5400 NR	S 2450 A	
inner / interno	KHD					S 3940 A	
260 Serie							
260 (6x4)	Unic V85S/4					S 7968 A	
power steering / servosterzo	Unic V85S/4						S 8790 PO
260.23	KHD F8L413			S 8600 R	S 5400 NR	S 0270 A	
260.25H/AH/AHB	KHD F8L413F/513			S 8600 R	S 5400 NR	S 0450 A	
some / alcuni	KHD F8L413F/513			S 8600 R	S 5400 NR	S 2450 A	
some / alcuni	KHD F8L413F/513			S 8600 R	S 5400 NR	S 2650 A	
dryer filter / filtro essiccatore	KHD F8L413F/513		04/89 > 12/83				S 7259 A
power steering / servosterzo	KHD F8L413F/513						S 3081 PO
260.26H				S 0230 R	S 0710 NR	S 0450 A	
260.26HT				S 0230 R	S 0710 NR	S 0450 A	
260.30							
assembly DONALDSON / montaggio DONALDSON				S 5003 DR	S 0710 NR	S 4270 A	
assembly MANN / montaggio MANN				S 5003 DR	S 0710 NR	S 7546 A	
260.30H/AH/AHT/AHW	KHD BF8L513	225 306	06/86 > 05/90	S 8600 R	S 5400 NR	S 0450 A	
dryer filter / filtro essiccatore	KHD BF8L513	225 306	06/86 > 05/90				S 7259 A
power steering / servosterzo	KHD BF8L513	225 306	06/86 > 05/90				S 3081 PO
260.32H/AH/AHT/AHW	KHD F10L413F	235 320	01/83 > 12/85	S 8600 R	S 6710 NR	S 0450 A	
some / alcuni	KHD F10L413F	235 320	01/83 > 12/85	S 8600 R	S 5400 NR	S 0450 A	
260.34H/AH/AHT/AHW	KHD BF8L513	250 340	04/89 > 12/93	S 8600 R	S 5400 NR	S 0450 A	
dryer filter / filtro essiccatore	KHD BF8L513	250 340	04/89 > 12/93				S 7259 A
power steering / servosterzo	KHD BF8L513	250 340	04/89 > 12/93				S 3081 PO
260.35H				S 0230 R	S 0710 NR	S 0450 A	S 8410 AR
260.35HT				S 0230 R	S 0710 NR	S 0450 A	S 8410 AR
260D26	8210			S 0230 R	S 0710 NR	S 2650 A	
outer / esterno	8210					S 0450 A	
inner / interno	8210					S 7129 A	
inner / interno	8210					S 1450 A	
260PC26				S 0230 R	S 0710 NR	S 0450 A	
260PC35				S 0230 R	S 0710 NR	S 0450 A	S 8410 AR
260PT26				S 0230 R	S 0710 NR	S 0450 A	
260PT35				S 0230 R	S 0710 NR	S 0450 A	S 8410 AR
260T (6x4)	Unic V85S/4					S 7968 A	
power steering / servosterzo	Unic V85S/4						S 8790 PO
290 Serie							
290M19FL	KHD			S 8600 R	S 6710 NR	S 7546 A	
290M22FL	KHD			S 8600 R	S 6710 NR	S 7546 A	
300 Serie							
300PC				S 0230 R	S 0710 NR		
300PC (var.185)				S 0230 R	S 0710 NR		
300PC (var.270)				S 0230 R	S 4311 N		





KW HP



...IVECO - trucks/autocarri

1st passage (felt spare part) / 1.passaggio (ricambio in feltro)				S 2163 N		
2nd passage / 2.passaggio				S 0710 NR		
300PT			S 0230 R	S 0710 NR		
300PT (var.185)			S 0230 R	S 0710 NR		
300PT (var.270)			S 0230 R	S 4311 N		
1st passage (felt spare part) / 1.passaggio (ricambio in feltro)				S 2163 N		
2nd passage / 2.passaggio				S 0710 NR		
310 Serie						
310D15.5	KHD F10L413		S 8600 R	S 5400 NR	S 2450 A	
some / alcuni	KHD F10L413		S 8600 R	S 6710 NR	S 0270 A	
inner / interno	KHD F10L413				S 3940 A	
310D15AK	KHD		S 8600 R	S 6710 NR	S 2450 A	
310D15FK	KHD		S 8600 R	S 5400 NR	S 0270 A	
310D15FL	KHD		S 8600 R	S 5400 NR	S 0270 A	
310D15FS	KHD		S 8600 R	S 5400 NR	S 0270 A	
310D15K	KHD		S 8600 R	S 6710 NR	S 2450 A	
310D16	KHD F10L413		S 8600 R	S 5400 NR	S 2450 A	
some / alcuni	KHD F10L413		S 8600 R	S 6710 NR	S 0270 A	
inner / interno	KHD F10L413				S 3940 A	
310D16AK	KHD		S 8600 R	S 6710 NR	S 2450 A	
310D16FK	KHD		S 8600 R	S 5400 NR	S 0270 A	
310D16FL	KHD		S 8600 R	S 5400 NR	S 0270 A	
310D16FS	KHD		S 8600 R	S 5400 NR	S 0270 A	
310D16K	KHD		S 8600 R	S 6710 NR	S 2450 A	
310D19	KHD F10L413		S 8600 R	S 5400 NR	S 2450 A	
some / alcuni	KHD F10L413		S 8600 R	S 6710 NR	S 0270 A	
inner / interno	KHD F10L413				S 3940 A	
310D22	KHD F10L413		S 8600 R	S 5400 NR	S 2450 A	
some / alcuni	KHD F10L413		S 8600 R	S 6710 NR	S 0270 A	
inner / interno	KHD F10L413				S 3940 A	
310D22AK	KHD		S 8600 R	S 6710 NR	S 2450 A	
310D22FK	KHD		S 8600 R	S 5400 NR	S 0270 A	
310D22FL	KHD		S 8600 R	S 5400 NR	S 0270 A	
310D26	KHD F10L413		S 8600 R	S 5400 NR	S 2450 A	
some / alcuni	KHD F10L413		S 8600 R	S 6710 NR	S 0270 A	
inner / interno	KHD F10L413				S 3940 A	
310D26AK	KHD		S 8600 R	S 6710 NR	S 2450 A	
inner / interno	KHD				S 3940 A	
310D26FK	KHD		S 8600 R	S 5400 NR	S 0270 A	
310D26FL	KHD		S 8600 R	S 5400 NR	S 0270 A	
310D31	KHD F10L413		S 8600 R	S 5400 NR	S 2450 A	
some / alcuni	KHD F10L413		S 8600 R	S 6710 NR	S 0270 A	
inner / interno	KHD F10L413				S 3940 A	
310D32	KHD F10L413		S 8600 R	S 5400 NR	S 2450 A	
some / alcuni	KHD F10L413		S 8600 R	S 6710 NR	S 0270 A	
inner / interno	KHD F10L413				S 3940 A	
310D32AK	KHD		S 8600 R	S 6710 NR	S 2450 A	
310D32FK	KHD		S 8600 R	S 5400 NR	S 0270 A	
310D32FL	KHD		S 8600 R	S 5400 NR	S 0270 A	
310D32FS	KHD		S 8600 R	S 5400 NR	S 0270 A	
310D32K	KHD		S 8600 R	S 6710 NR	S 2450 A	
320 Serie						
320.31	KHD F10L413		S 8600 R	S 5400 NR	S 0270 A	
some / alcuni	KHD F10L413		S 8600 R	S 5400 NR	S 2450 A	
320.45 WTM	8282.22			S 4311 N	S 0450 A	S 8410 AR
1st passage (felt spare part) / 1.passaggio (ricambio in feltro)	8282.22			S 2163 N	S 0450 A	S 8410 AR
2nd passage / 2.passaggio	8282.22			S 0710 NR		
1 filter / N.1 filtro	8282.22		S 8020 R			
2 filters / N.2 filtri	8282.22		S 0120 R			
320D26AK	KHD		S 8600 R	S 5400 NR	S 2450 A	
inner / interno	KHD				S 3940 A	
320M19FAK			S 8600 R	S 6710 NR	S 0450 A	
320M19FK			S 8600 R	S 6710 NR	S 0450 A	
320M19FKS			S 8600 R	S 6710 NR	S 0450 A	
320M19FL	KHD	05/78 > 07/82	S 8600 R	S 6710 NR	S 7546 A	
320M22FL	KHD	05/78 > 07/82	S 8600 R	S 6710 NR	S 7546 A	
320M26FAK	KHD		S 8600 R	S 5400 NR	S 0450 A	



kW HP



...IVECO - trucks/autocarri

320M26FK	KHD				S 8600 R	S 5400 NR	S 0450 A	
320M26FKL	KHD				S 8600 R	S 5400 NR	S 0450 A	
320M26FKS	KHD				S 8600 R	S 5400 NR	S 0450 A	
330 Serie								
330.26H					S 0230 R	S 0710 NR	S 0450 A	
330.26HT					S 0230 R	S 0710 NR	S 0450 A	
330.30			01/86 >		S 0230 R	S 0710 NR	S 7546 A	
330.30 AH	KHD BF8L513	225 306	04/87 > 05/89		S 8600 R	S 0201 N	S 2450 A	
2nd passage / 2.passaggio	KHD BF8L513	225 306	04/87 > 05/89			S 1411 N		
some / alcuni	KHD BF8L513	225 306	04/87 > 05/89			S 6710 NR		
dryer filter / filtro essiccatore	KHD BF8L513	225 306	04/87 > 05/89					S 7259 A
power steering / servosterzo	KHD BF8L513	225 306	04/87 > 05/89					S 3081 PO
330.30 ANW	KHD BF8L413/513				S 8600 R	S 6710 NR	S 2450 A	
330.30H					S 0230 R	S 0710 NR	S 0450 A	
330.30HT	8210.22	224 305			S 0230 R	S 0710 NR	S 0450 A	
some / alcuni	8210.22	224 305					S 7546 A	
with double filter, 1st passage / con filtro doppio, 1.passaggio	8210.22	224 305				S 4311 N		
with double filter, 1st passage (felt spare part) / con filtro doppio, 1.passaggio (ricambio in feltro)	8210.22	224 305				S 2163 N		
dryer filter / filtro essiccatore	8210.22	224 305						S 7259 A
power steering / servosterzo	8210.22	224 305						S 3081 PO
330.32	KHD F10L413				S 5802 R	S 5401 NR	S 2450 A	
some / alcuni	KHD F10L413				S 5802 R	S 5400 NR	S 0270 A	
or / oppure	KHD F10L413				S 5802 R	S 5400 NR	S 2450 A	
330.35H					S 0230 R	S 0710 NR	S 0450 A	S 8410 AR
330.35HT					S 0230 R	S 0710 NR	S 0450 A	S 8410 AR
330.36	8210.42R	265 360	01/89 > 12/93		S 5003 DR	S 0710 NR	S 7546 A	
with double filter, 1st passage / con filtro doppio, 1.passaggio	8210.42R	265 360	01/89 > 12/93			S 4311 N		
with double filter, 1st passage (felt spare part) / con filtro doppio, 1.passaggio (ricambio in feltro)	8210.42R	265 360	01/89 > 12/93			S 2163 N		
dryer filter / filtro essiccatore	8210.42R	265 360	01/89 > 12/93					S 7259 A
power steering / servosterzo	8210.42R	265 360	01/89 > 12/93					S 3081 PO
330.36	KHD BF10L413F				S 8600 R	S 6710 NR		
330.36H	8210.42R	265 360	01/89 > 12/93		S 5003 DR	S 0710 NR	S 7546 A	
with double filter, 1st passage / con filtro doppio, 1.passaggio	8210.42R	265 360	01/89 > 12/93			S 4311 N		
with double filter, 1st passage (felt spare part) / con filtro doppio, 1.passaggio (ricambio in feltro)	8210.42R	265 360	01/89 > 12/93			S 2163 N		
dryer filter / filtro essiccatore	8210.42R	265 360	01/89 > 12/93					S 7259 A
power steering / servosterzo	8210.42R	265 360	01/89 > 12/93					S 3081 PO
330PC26					S 0230 R	S 0710 NR	S 0450 A	
330PC30					S 0230 R	S 0710 NR	S 0450 A	
330PC35					S 0230 R	S 0710 NR	S 0450 A	S 8410 AR
330PT26					S 0230 R	S 0710 NR	S 0450 A	
330PT30					S 0230 R	S 0710 NR	S 0450 A	
330PT35					S 0230 R	S 0710 NR	S 0450 A	S 8410 AR
340 Serie								
334.34AH	KHD BF8L513	250 340	03/89 > 12/93		S 8600 R	S 5400 NR	S 0450 A	
dryer filter / filtro essiccatore	KHD BF8L513	250 340	03/89 > 12/93					S 7259 A
power steering / servosterzo	KHD BF8L513	250 340	03/89 > 12/93					S 8790 PO
360 Serie								
360M19FL	KHD				S 8600 R	S 6710 NR	S 7546 A	
360M22F	KHD				S 8600 R	S 6710 NR	S 7546 A	
40 Serie								
40					S 9710 R	S 7111 NC	S 8760 A	
40/35					S 9710 R	S 7111 NC	S 8760 A	
C40	213 vertic.				S 0580 PO	S 4211 N		
C40N	213 vertic.				S 0580 PO	S 4211 N		
50 Serie								
50	8040.25				S 3003 DR	S 7111 NC		
50NC					S 9710 R	S 7111 NC		
to frame No. 017645 / a telaio N. 017645							S 8760 A	
50NC var. 836					S 9710 R	S 7111 NC		
C50	213 vertic.				S 0580 PO	S 4211 N		
C50N	213 vertic.				S 0580 PO	S 4211 N		
OM50	CO3/110x120		> 10/74		S 9710 R	S 7200 N		
	CO3/110x120		11/74 >		S 9710 R	S 0610 NR		
OM50 var. 836					S 9710 R	S 7111 NC		
55 Serie								
55NC					S 9710 R	S 7111 NC		
to frame No. 000599 / a telaio N. 000599							S 8760 A	



kW HP



...IVECO - trucks/autocarri

OM55	CO3/110x120	> 10/74	S 9710 R	S 7200 N		
	CO3/110x120	11/74 >	S 9710 R	S 0610 NR		
60 Serie						
60	8040.25		S 3003 DR	S 7111 NC		
65NC/60	CO3/110x120	> 10/74	S 9710 R	S 7200 N		
	CO3/110x120	11/74 >	S 9710 R	S 0610 NR		
OM65/60	CO3/110x120	> 10/74	S 9710 R	S 7200 N		
	CO3/110x120	11/74 >	S 9710 R	S 0610 NR		
615 Serie						
615N				S 4211 N		
615N1				S 4211 N	S 0760 A	
615N2				S 4211 N	S 0760 A	
616 Serie						
616N	230.022		S 0580 PO	S 4211 N	S 8760 A	
616N1	230.022		S 0580 PO	S 4211 N	S 8760 A	
616N2			S 9710 R	S 7111 NC	S 5060 A	
616N2/4			S 9710 R	S 7111 NC	S 5060 A	
616N2/A			S 9710 R	S 7111 NC	S 5060 A	
616N3			S 9710 R	S 7111 NC	S 5060 A	
616N4			S 9710 R	S 7111 NC	S 5060 A	
616NM	230.022		S 0580 PO	S 4211 N	S 8760 A	
OM616			S 9710 R	S 7111 NC	S 5060 A	
619 Serie						
619N		> 12/68	S 3300 PO			
		01/69 > 12/71	S 3300 PO	S 0710 NR		
		01/72 >	S 0230 R	S 0710 NR		
some / alcuni or / oppure				S 5401 NR		
				S 5400 NR		
619N1			S 0230 R	S 0710 NR		
spin-on / avvitabile cartridge / immersione			S 3300 PO	S 0710 NR		
619N1 (var. 185)			S 0230 R	S 0710 NR		
spin-on / avvitabile cartridge / immersione			S 3300 PO	S 0710 NR		
619N1 (var. 270-1141)			S 3300 PO	S 2163 N		
1st passage (felt spare part) / 1.passaggio (ricambio in feltro)				S 0710 NR		
2nd passage / 2.passaggio			S 0230 R	S 4311 N		
spin-on / avvitabile cartridge / immersione			S 3300 PO	S 4311 N		
619N1P			S 0230 R	S 0710 NR		
spin-on / avvitabile cartridge / immersione			S 3300 PO	S 0710 NR		
619N1P (var. 185)			S 0230 R	S 0710 NR		
spin-on / avvitabile cartridge / immersione			S 3300 PO	S 0710 NR		
619N1P (var. 270-1141)			S 3300 PO	S 2163 N		
1st passage (felt spare part) / 1.passaggio (ricambio in feltro)				S 0710 NR		
2nd passage / 2.passaggio			S 0230 R	S 4311 N		
spin-on / avvitabile cartridge / immersione			S 3300 PO	S 4311 N		
619T		> 12/68	S 3300 PO			
		01/69 > 12/71	S 3300 PO	S 0710 NR		
		01/72 >	S 0230 R	S 0710 NR		
some / alcuni or / oppure				S 5401 NR		
				S 5400 NR		
619T1			S 0230 R	S 0710 NR		
spin-on / avvitabile cartridge / immersione			S 3300 PO	S 0710 NR		
619T1 (var. 185)			S 0230 R	S 0710 NR		
spin-on / avvitabile cartridge / immersione			S 3300 PO	S 0710 NR		
619T1 (var. 270-1141)			S 3300 PO	S 2163 N		
1st passage (felt spare part) / 1.passaggio (ricambio in feltro)				S 0710 NR		
2nd passage / 2.passaggio			S 0230 R	S 4311 N		
spin-on / avvitabile cartridge / immersione			S 3300 PO	S 4311 N		
619T1P			S 3300 PO	S 4311 N		



kW HP



...IVECO - trucks/autocarri

spin-on / avvitabile cartridge / immersione		S 0230 R S 3300 PO	S 0710 NR S 0710 NR		
619T1P (var. 185)					
spin-on / avvitabile cartridge / immersione		S 0230 R S 3300 PO	S 0710 NR S 0710 NR		
619T1P (var. 270-1141)					
1st passage (felt spare part) / 1.passaggio (ricambio in feltro)		S 3300 PO	S 2163 N		
2nd passage / 2.passaggio			S 0710 NR		
spin-on / avvitabile		S 0230 R	S 4311 N		
cartridge / immersione		S 3300 PO	S 4311 N		
625 Serie					
625N		S 0580 PO		S 8760 A	
625N1		S 0580 PO		S 8760 A	
625N2	804A, 8040.02	S 9710 R	S 7111 NC	S 8760 A	
625N3	804A, 8040.02	S 9710 R	S 7111 NC	S 8760 A	
635 Serie					
635N		S 9710 R	S 4211 N		
639 Serie					
639N			S 6911 N		
639N2			S 6911 N		
639N2	364A/60 var.71	S 3300 PO	S 6911 N		
639N2/58			S 6911 N		
some / alcuni		S 3300 PO	S 6911 N		
639N3		S 3300 PO	S 6911 N	S 8760 A	
639N3	364A/60 var.71	S 3300 PO	S 6911 N		
640 Serie					
640			S 6911 N		
642 Serie					
642N			S 6911 N		
642N2			S 6911 N		
642N5			S 6911 N		
some / alcuni		S 3300 PO	S 6911 N		
642N5R			S 6911 N		
some / alcuni		S 3300 PO	S 6911 N		
642N6			S 6911 N		
some / alcuni		S 3300 PO	S 6911 N		
642N65		S 3300 PO	S 6911 N		
642N65R		S 3300 PO	S 6911 N		
642N6R			S 6911 N		
some / alcuni		S 3300 PO	S 6911 N		
642T			S 6911 N		
642T2			S 6911 N		
642T6			S 6911 N		
some / alcuni		S 3300 PO	S 6911 N		
642T65		S 3300 PO	S 6911 N		
643 Serie					
643E		> 12/68	S 3300 PO		
	01/69 >	07/72	S 3300 PO	S 0710 NR	S 0940 A
	08/72 >		S 0230 R	S 0710 NR	S 0940 A
643EP		> 12/68	S 3300 PO		
	01/69 >	07/72	S 3300 PO	S 0710 NR	S 0940 A
	08/72 >		S 0230 R	S 0710 NR	S 0940 A
643N		> 12/68	S 3300 PO		
	01/69 >	07/72	S 3300 PO	S 0710 NR	S 0940 A
	08/72 >		S 0230 R	S 0710 NR	S 0940 A
643N1		> 12/68	S 3300 PO		
	01/69 >	07/72	S 3300 PO	S 0710 NR	S 0940 A
	08/72 >		S 0230 R	S 0710 NR	S 0940 A
643NI		> 12/68	S 3300 PO		
	01/69 >	07/72	S 3300 PO	S 0710 NR	S 0940 A
	08/72 >		S 0230 R	S 0710 NR	S 0940 A
643T		> 12/68	S 3300 PO		
	01/69 >	07/72	S 3300 PO	S 0710 NR	S 0940 A
	08/72 >		S 0230 R	S 0710 NR	S 0940 A
643T1		> 12/68	S 3300 PO		
	01/69 >	07/72	S 3300 PO	S 0710 NR	S 0940 A
	08/72 >		S 0230 R	S 0710 NR	S 0940 A



kW HP



...IVECO - trucks/autocarri

645 Serie

645N	213		S 0580 PO	S 4211 N		
645N1			S 0700 R	S 4211 N		
some / alcuni			S 0700 R	S 7111 NC		
with antidraining pipe / con tubo antisvuotamento			S 9610 R	S 4211 N		
645N2	806A		S 0700 R	S 7111 NC		
with antidraining pipe / con tubo antisvuotamento	806A		S 9610 R	S 7111 NC		
645N3			S 0700 R	S 7111 NC		
with antidraining pipe / con tubo antisvuotamento			S 9610 R	S 7111 NC		

65 Serie

65.10	8040.25		S 3003 DR	S 7111 NC		
65.14	8060.04, 8060.05		S 0700 R	S 7111 NC		
some / alcuni	8060.04, 8060.05		S 0700 R	S 8500 NR	S 0950 A	
with antidraining pipe / con tubo antisvuotamento	8060.04, 8060.05		S 9610 R	S 7111 NC		
power steering / servosterzo	8060.04, 8060.05					S 3081 PO
65NC	CO3/110x120	> 10/74	S 9710 R	S 7200 N		
	CO3/110x120	11/74 >	S 9710 R	S 0610 NR		
65PC			S 9710 R	S 7111 NC	S 7170 A	
OM65	CO3/110x120	> 10/74	S 9710 R	S 7200 N		
	CO3/110x120	11/74 >	S 9710 R	S 0610 NR		

650 Serie

650E	213		S 0580 PO	S 4211 N		
650E1	806A		S 0700 R			
some / alcuni	806A		S 0700 R	S 7111 NC		
with antidraining pipe / con tubo antisvuotamento	806A		S 9610 R			
650N	213		S 0580 PO	S 4211 N		
650N1	806A		S 0700 R			
some / alcuni	806A		S 0700 R	S 7111 NC		
with antidraining pipe / con tubo antisvuotamento	806A		S 9610 R			
650N2			S 0700 R	S 7111 NC		
with antidraining pipe / con tubo antisvuotamento			S 9610 R	S 7111 NC		
650N3			S 0700 R	S 7111 NC		
with antidraining pipe / con tubo antisvuotamento			S 9610 R	S 7111 NC		

655 Serie

655N1			S 0700 R	S 7111 NC		
with antidraining pipe / con tubo antisvuotamento			S 9610 R	S 7111 NC		

662 Serie

662N	213		S 0580 PO	S 4211 N		
662N	213 vertic.	> 03/68	S 0580 PO	S 4211 N		
662N1	806A		S 0700 R			
some / alcuni	806A		S 0700 R	S 7111 NC		
with antidraining pipe / con tubo antisvuotamento	806A		S 9610 R			
662N1P	806A		S 0700 R			
some / alcuni	806A		S 0700 R	S 7111 NC		
with antidraining pipe / con tubo antisvuotamento	806A		S 9610 R			
662N2	806A		S 0700 R	S 7111 NC		
with antidraining pipe / con tubo antisvuotamento	806A		S 9610 R	S 7111 NC		
662N2P	806A		S 0700 R	S 7111 NC		
with antidraining pipe / con tubo antisvuotamento	806A		S 9610 R	S 7111 NC		
662N3			S 0700 R	S 7111 NC		
with antidraining pipe / con tubo antisvuotamento			S 9610 R	S 7111 NC		
662N3	8060.02		S 0700 R	S 7111 NC	S 0060 A	
with antidraining pipe / con tubo antisvuotamento	8060.02		S 9610 R	S 7111 NC	S 0060 A	
662N3P	8060.02		S 0700 R	S 7111 NC	S 0060 A	
with antidraining pipe / con tubo antisvuotamento	8060.02		S 9610 R	S 7111 NC	S 0060 A	
662N3PR	806A		S 0700 R	S 7111 NC		
with antidraining pipe / con tubo antisvuotamento	806A		S 9610 R	S 7111 NC		
662N3T	806A		S 0700 R	S 7111 NC		
with antidraining pipe / con tubo antisvuotamento	806A		S 9610 R	S 7111 NC		
662T	8060.02		S 0700 R	S 7111 NC	S 0060 A	
with antidraining pipe / con tubo antisvuotamento	8060.02		S 9610 R	S 7111 NC	S 0060 A	

670 Serie

670				S 6911 N		
670N				S 6911 N		

671 Serie

671N				S 6911 N		
671N2	364A/60		S 3300 PO	S 6911 N		



kW HP



...IVECO - trucks/autocarri

671N3	364A/60		S 3300 PO	S 6911 N		
672 Serie						
672N			S 0700 R	S 6911 N		
with antidraining pipe / con tubo antisvuotamento			S 9610 R	S 7111 NC		
673 Serie						
673N			S 3300 PO	S 7200 N		
to engine No. 003390 / a motore N. 003390			S 0230 R	S 7200 N		
from engine No. 003391 a 005505 / da motore N. 003391 a 005505			S 9710 R	S 7200 N		
from engine No. 005506 / da motore N. 005506						
673T			S 3300 PO	S 7200 N		
to engine No. 003390 / a motore N. 003390			S 0230 R	S 7200 N		
from engine No. 003391 a 005505 / da motore N. 003391 a 005505			S 9710 R	S 7200 N		
from engine No. 005506 / da motore N. 005506						
680 Serie						
680N				S 6911 N		
682 Serie						
682BT5				S 5401 NR		
or / oppure				S 5400 NR		
682N	203 vertic.			S 6911 N		
682N2		> 04/64		S 6911 N		
682N2	203 vertic.			S 6911 N		
682N3		> 04/64	S 3300 PO	S 6911 N		
				S 6911 N		
682N4		> 04/64	S 3300 PO	S 6911 N		
				S 6911 N		
682RN2	203 vertic.			S 6911 N		
682T2	203 vertic.			S 6911 N		
682T3		> 04/64	S 3300 PO	S 6911 N		
				S 6911 N		
682T4			S 3300 PO	S 6911 N		
684 Serie						
684N			S 3300 PO	S 0710 NR		
to engine No. 18082 / a motore N. 18082			S 0230 R	S 0710 NR		
from engine No. 18083 / da motore N. 18083						
684NP			S 3300 PO	S 0710 NR		
to engine No. 18082 / a motore N. 18082			S 0230 R	S 0710 NR		
from engine No. 18083 / da motore N. 18083						
684T			S 3300 PO	S 0710 NR		
to engine No. 18216 / a motore N. 18216			S 0230 R	S 0710 NR		
from engine No. 18217 / da motore N. 18217						
684TP			S 3300 PO	S 0710 NR		
to engine No. 18216 / a motore N. 18216			S 0230 R	S 0710 NR		
from engine No. 18217 / da motore N. 18217						
685 Serie						
685N			S 0700 R	S 7111 NC		
with antidraining pipe / con tubo antisvuotamento			S 9610 R	S 7111 NC		
685N1			S 0700 R	S 7111 NC		
with antidraining pipe / con tubo antisvuotamento			S 9610 R	S 7111 NC		
685N1A			S 0700 R	S 7111 NC		
with antidraining pipe / con tubo antisvuotamento			S 9610 R	S 7111 NC		
685N1B			S 0700 R	S 7111 NC		
with antidraining pipe / con tubo antisvuotamento			S 9610 R	S 7111 NC		
690 Serie						
690N	203 vertic.			S 6911 N		
690N1		05/64 > 08/73	S 3300 PO	S 6911 N		
		09/73 >	S 0230 R			
690N2		05/64 > 08/73	S 3300 PO	S 6911 N		
		09/73 >	S 0230 R			
690N3		> 07/72	S 3300 PO			
		08/72 >	S 0230 R	S 0710 NR		
690N4			S 3300 PO	S 0710 NR		
to engine No. 25420 / a motore N. 25420			S 0230 R	S 0710 NR		
from engine No. 25421 / da motore N. 25421						
690T	203 vertic.			S 6911 N		
690T1		05/64 > 08/73	S 3300 PO	S 6911 N		
		09/73 >	S 0230 R			



kW HP



...IVECO - trucks/autocarri

690T1R		05/64 > 08/73 09/73 >	S 3300 PO S 0230 R	S 6911 N		
690T2		05/64 > 08/73 09/73 >	S 3300 PO S 0230 R	S 6911 N		
691 Serie						
691N			S 3300 PO S 0230 R	S 0710 NR S 0710 NR		
691T			S 3300 PO S 0230 R	S 0710 NR S 0710 NR		
693 Serie						
693N1			S 3300 PO			
693T1			S 3300 PO			
697 Serie						
697N			S 3300 PO S 0230 R	S 0710 NR S 0710 NR		
697N var. 185			S 3300 PO S 0230 R	S 0710 NR S 0710 NR		
697T			S 3300 PO S 0230 R	S 0710 NR S 0710 NR		
697T var. 185			S 3300 PO S 0230 R	S 0710 NR S 0710 NR		
70 Serie						
70NC	CO3/110x120	> 10/74	S 9710 R	S 7200 N		
	CO3/110x120	11/74 >	S 9710 R	S 0610 NR		
OM70	CO3/110x120	> 10/74	S 9710 R	S 7200 N		
	CO3/110x120	11/74 >	S 9710 R	S 0610 NR		
75 Serie						
75.12	8040.25		S 3003 DR	S 8500 NR		
75.14 W	8062.04		S 0700 R	S 7111 NC		
some / alcuni	8062.04		S 0700 R	S 8500 NR	S 0950 A	
with antidraining pipe / con tubo antisvuotamento	8062.04		S 9610 R	S 7111 NC		S 3081 PO
power steering / servosterzo	8062.04					
75.9 A	KHD BF4L913T, F4L913	01/83 > 05/89	S 7600 R	S 5400 NR		
some / alcuni	KHD BF4L913T, F4L913	01/83 > 05/89	S 7600 R	S 5400 NR	S 4940 A	
power steering / servosterzo	KHD BF4L913T, F4L913	01/83 > 05/89				S 3081 PO
75.9 H	KHD BF4L913T, F4L913	01/83 > 05/89	S 7600 R	S 5400 NR		
some / alcuni	KHD BF4L913T, F4L913	01/83 > 05/89	S 7600 R	S 5400 NR	S 4940 A	
power steering / servosterzo	KHD BF4L913T, F4L913	01/83 > 05/89				S 3081 PO
75NC	CO3/110x120	> 10/74	S 9710 R	S 7200 N		
	CO3/110x120	11/74 >	S 9710 R	S 0610 NR		
75PC			S 0700 R	S 7111 NC	S 7170 A	
with antidraining pipe / con tubo antisvuotamento			S 9610 R			
75PM	8060.02		S 0700 R	S 7111 NC	S 7170 A	
some / alcuni	8060.02		S 0700 R	S 7111 NC	S 7017 A	
with antidraining pipe / con tubo antisvuotamento	8060.02		S 9610 R	S 7111 NC	S 7170 A	
inner / interno	8060.02				S 7670 A	
OM75	CO3/110x120	> 10/74	S 9710 R	S 7200 N		
	CO3/110x120	11/74 >	S 9710 R	S 0610 NR		
79 Serie						
79.12	8040.25		S 3003 DR	S 8500 NR		
79.14	8060.04, 8060,05	01/87 > 05/91	S 0700 R	S 7111 NC		
some / alcuni	8060.04, 8060,05		S 0700 R	S 8500 NR	S 0950 A	
with antidraining pipe / con tubo antisvuotamento	8060.04, 8060,05		S 9610 R	S 7111 NC		S 3081 PO
power steering / servosterzo	8060.04, 8060,05					
80 Serie						
80.13	8060.04		S 0700 R	S 7111 NC		
some / alcuni	8060.04		S 0700 R	S 8500 NR		
with antidraining pipe / con tubo antisvuotamento	8060.04		S 9610 R	S 7111 NC		
80.13	KHD F6L913		S 8600 R	S 5400 NR	S 0950 A	
some / alcuni	KHD F6L913		S 8600 R	S 5400 NR	S 0270 A	
80.14 (4x4)			S 0700 R	S 7111 NC	S 2570 A	



kW HP



...IVECO - trucks/autocarri

with antidraining pipe / con tubo antisvuotamento			S 9610 R	S 7111 NC	S 2570 A	
80.16	KHD BF6L913		S 8600 R	S 5400 NR	S 2450 A	
80.16 (4x4)			S 0700 R	S 7111 NC	S 2570 A	
with antidraining pipe / con tubo antisvuotamento			S 9610 R	S 7111 NC	S 2570 A	
80.17 W (4x4)			S 3003 DR	S 8500 NR	S 2450 A	
some / alcuni			S 3003 DR	S 8500 NR	S 2650 A	
80.9 A	KHD F4L913	01/83 > 02/86	S 7600 R	S 5400 NR		
some / alcuni	KHD F4L913	01/83 > 02/86	S 7600 R	S 5400 NR	S 4940 A	
power steering / servosterzo	KHD F4L913	01/83 > 02/86				S 3081 PO
80.9 AH	KHD F4L913	01/83 > 02/86	S 7600 R	S 5400 NR		
some / alcuni	KHD F4L913	01/83 > 02/86	S 7600 R	S 5400 NR	S 4940 A	
power steering / servosterzo	KHD F4L913	01/83 > 02/86				S 3081 PO
80NC			S 0700 R	S 7111 NC		
with antidraining pipe / con tubo antisvuotamento			S 9610 R	S 7111 NC		
80NC var. 836			S 0700 R	S 0201 N		
2nd passage / 2.passaggio				S 1411 N		
with antidraining pipe / con tubo antisvuotamento			S 9610 R	S 0201 N		
OM80			S 9710 R	S 0610 NR		
85 Serie						
85.14	8060.04, 8060,05	01/87 > 05/91	S 0700 R	S 7111 NC		
some / alcuni	8060.04, 8060,05		S 9610 R	S 8500 NR	S 0950 A	
with antidraining pipe / con tubo antisvuotamento	8060.04, 8060,05		S 9610 R	S 7111 NC		
power steering / servosterzo	8060.04, 8060,05					S 3081 PO
90 Serie						
90.13	8060.04		S 0700 R	S 7111 NC		
some / alcuni	8060.04		S 0700 R	S 8500 NR		
with antidraining pipe / con tubo antisvuotamento	8060.04		S 9610 R	S 7111 NC		
90.13	KHD F6L913		S 8600 R	S 5400 NR	S 0950 A	
some / alcuni	KHD F6L913		S 8600 R	S 5400 NR	S 0270 A	
90.16WM	8062.24/25		S 3003 DR	S 7111 NC	S 2570 A	
some / alcuni	8062.24/25		S 3003 DR	S 8500 NR	S 2570 A	
90.17WM	8060.25	01/87 >	S 3003 DR	S 7111 NC	S 2570 A	
some / alcuni	8060.25	01/87 >	S 3003 DR	S 7111 NC	S 2650 A	
90.9 A	KHD F4L913	01/83 > 02/86	S 7600 R	S 5400 NR		
some / alcuni	KHD F4L913	01/83 > 02/86	S 7600 R	S 5400 NR	S 4940 A	
power steering / servosterzo	KHD F4L913	01/83 > 02/86				S 3081 PO
90.9 AH	KHD F4L913	01/83 > 02/86	S 7600 R	S 5400 NR		
some / alcuni	KHD F4L913	01/83 > 02/86	S 7600 R	S 5400 NR	S 4940 A	
power steering / servosterzo	KHD F4L913	01/83 > 02/86				S 3081 PO
90D5.2	KHD		S 7600 R	S 5400 NR	S 4940 A	
90D5.6	KHD		S 7600 R	S 5400 NR	S 4940 A	
90D6.5	KHD		S 7600 R	S 5400 NR	S 4940 A	
90D7.5	KHD		S 7600 R	S 5400 NR	S 4940 A	
90M5.3	KHD		S 7600 R	S 5400 NR	S 4940 A	
90M5.7	KHD		S 7600 R	S 5400 NR	S 4940 A	
90M5.9	KHD		S 7600 R	S 5400 NR	S 4940 A	
90M6	KHD		S 7600 R	S 5400 NR	S 4940 A	
90M6.6	KHD		S 7600 R	S 5400 NR	S 4940 A	
90M7	KHD		S 7600 R	S 5400 NR	S 4940 A	
some / alcuni	KHD		S 8600 R	S 5400 NR	S 4940 A	
90M7.5	KHD		S 7600 R	S 5400 NR	S 4940 A	
90M8	KHD		S 7600 R	S 5400 NR	S 4940 A	
some / alcuni	KHD		S 8600 R	S 5400 NR	S 4940 A	
90M9	KHD		S 7600 R	S 5400 NR	S 4940 A	
90NC			S 0700 R	S 7111 NC		
with antidraining pipe / con tubo antisvuotamento			S 9610 R	S 7111 NC		
90PC			S 0700 R	S 7111 NC	S 7170 A	
with antidraining pipe / con tubo antisvuotamento			S 9610 R	S 7111 NC	S 7170 A	
90PM	8060.02		S 0700 R	S 7111 NC	S 7170 A	
some / alcuni	8060.02		S 0700 R	S 7111 NC	S 7017 A	
with antidraining pipe / con tubo antisvuotamento	8060.02		S 9610 R	S 7111 NC	S 7170 A	
inner / interno	8060.02				S 7670 A	
A90.13	8060.04		S 0700 R	S 7111 NC		
some / alcuni	8060.04		S 0700 R	S 8500 NR		
with antidraining pipe / con tubo antisvuotamento	8060.04		S 9610 R	S 7111 NC		
OM90			S 9710 R	S 0610 NR		
95 Serie						



kW HP



...IVECO - trucks/autocarri

95.17	8060.24, 8060.25				S 0700 R	S 8500 NR	S 5650 A	
	8060.24, 8060.25				S 3003 DR			
some / alcuni	8060.24, 8060.25					S 8500 NR	S 2450 A	
some / alcuni	8060.24, 8060.25					S 8500 NR	S 2650 A	
some / alcuni	8060.24, 8060.25					S 8500 NR	S 5650 A	
with IVECO 1902134 / con IVECO 1902134	8060.24, 8060.25					S 5400 NR		
with drain / con spurgo	8060.24, 8060.25					S 8500 NR		
with antidraining pipe (- N.334356) / con tubo antisvuotamento (- N.334356)	8060.24, 8060.25				S 9610 R			
assembly DELPHI / montaggio DELPHI	8060.24, 8060.25					S 7111 NC		
Cerbiatto								
20	CO3 (110x120)		01/68 > 12/70		S 9710 R			
	CO3 (110x120)		01/71 >		S 9710 R	S 7200 N		
M			01/68 >		S 9710 R			
M1	CO3 (110x120)		01/68 > 12/70		S 9710 R			
	CO3 (110x120)		01/71 >		S 9710 R	S 7200 N		
N			01/68 >		S 9710 R			
Daino								
40	CO3 var.21				S 9710 R			
45	CO3 var.21				S 9710 R			
45 L			01/68 >		S 9710 R			
45 L1			01/68 >		S 9710 R			
Daino			01/68 >		S 9710 R			
Daino	CO3 var.24		01/68 >		S 9710 R			
L			01/68 >		S 9710 R			
L1			01/68 >		S 9710 R			
Eurocargo I								
100E15	8060.25R/8060.45R	105 143	01/91 > 04/01		S 3003 DR	S 8500 NR	S 7183 A	
dryer filter / filtro essiccatore	8060.25R/8060.45R	105 143	01/91 > 04/01					S 7259 A
prefilter / prefiltra	8060.25R/8060.45R	105 143	01/91 > 04/01			S 0999 NR		
power steering / servosterzo	8060.25R/8060.45R	105 143	01/91 > 04/01					S 3081 PO
100E18	8060.25V	130 177	01/91 > 04/01		S 3003 DR	S 8500 NR	S 7183 A	
dryer filter / filtro essiccatore	8060.25V	130 177	01/91 > 04/01					S 7259 A
prefilter / prefiltra	8060.25V	130 177	01/91 > 04/01			S 0999 NR		
power steering / servosterzo	8060.25V	130 177	01/91 > 04/01					S 3081 PO
100E21	8060.45	152 207	01/91 > 04/01		S 3003 DR	S 8500 NR	S 7183 A	
dryer filter / filtro essiccatore	8060.45	152 207	01/91 > 04/01					S 7259 A
prefilter / prefiltra	8060.45	152 207	01/91 > 04/01			S 0999 NR		
power steering / servosterzo	8060.45	152 207	01/91 > 04/01					S 3081 PO
120E15	8060.25R	105 143	12/91 > 04/01		S 3003 DR	S 8500 NR	S 7183 A	
dryer filter / filtro essiccatore	8060.25R	105 143	12/91 > 04/01					S 7259 A
prefilter / prefiltra	8060.25R	105 143	12/91 > 04/01			S 0999 NR		
power steering / servosterzo	8060.25R	105 143	12/91 > 04/01					S 3081 PO
120E15H	8060.25R	105 143	12/91 > 04/01		S 3003 DR	S 8500 NR	S 7183 A	
dryer filter / filtro essiccatore	8060.25R	105 143	12/91 > 04/01					S 7259 A
prefilter / prefiltra	8060.25R	105 143	12/91 > 04/01			S 0999 NR		
power steering / servosterzo	8060.25R	105 143	12/91 > 04/01					S 3081 PO
120E18	8060 TC	130 177	09/91 > 04/01		S 3003 DR	S 8500 NR	S 7183 A	
dryer filter / filtro essiccatore	8060 TC	130 177	09/91 > 04/01					S 7259 A
prefilter / prefiltra	8060 TC	130 177	09/91 > 04/01			S 0999 NR		
power steering / servosterzo	8060 TC	130 177	09/91 > 04/01					S 3081 PO
120E18	8060.25V	130 177	09/91 > 04/01		S 3003 DR	S 8500 NR	S 7183 A	
dryer filter / filtro essiccatore	8060.25V	130 177	09/91 > 04/01					S 7259 A
prefilter / prefiltra	8060.25V	130 177	09/91 > 04/01			S 0999 NR		
power steering / servosterzo	8060.25V	130 177	09/91 > 04/01					S 3081 PO
120E18	8060.45B	130 177	09/91 > 04/01		S 3003 DR	S 8500 NR	S 7183 A	
dryer filter / filtro essiccatore	8060.45B	130 177	09/91 > 04/01					S 7259 A
prefilter / prefiltra	8060.45B	130 177	09/91 > 04/01			S 0999 NR		
power steering / servosterzo	8060.45B	130 177	09/91 > 04/01					S 3081 PO
120E18H	8060.25V	130 177	09/91 > 04/01		S 3003 DR	S 8500 NR		
dryer filter / filtro essiccatore	8060.25V	130 177	09/91 > 04/01					S 7259 A
prefilter / prefiltra	8060.25V	130 177	09/91 > 04/01			S 0999 NR		
power steering / servosterzo	8060.25V	130 177	09/91 > 04/01					S 3081 PO
120E23	8060.45S/8060.45S E2	167 227	02/92 > 04/01				S 7482 A	
dryer filter / filtro essiccatore	8060.45S/8060.45S E2	167 227	02/92 > 04/01					S 7259 A
assembly BOSCH / montaggio BOSCH	8060.45S/8060.45S E2	167 227	02/92 > 04/01		S 5003 DR	S 5401 NR	S 7187 A	
assembly UFI / montaggio UFI	8060.45S/8060.45S E2	167 227	02/92 > 04/01		S 5003 DR	S 4329 NR	S 7187 A	
or BOSCH / oppure BOSCH	8060.45S/8060.45S E2	167 227	02/92 > 04/01		S 5003 DR	S 5400 NR	S 7187 A	

**KW HP****...IVECO - trucks/autocarri**

prefilter / prefiltrato	8060.45S/8060.45S E2	167	227	02/92	>	04/01		S 0999 NR		
power steering / servosterzo	8060.45S/8060.45S E2	167	227	02/92	>	04/01				S 3081 PO
120E23	8060TCA	167	227	02/92	>	04/01	S 5003 DR	S 4329 NR	S 7187 A	
dryer filter / filtro essiccatore	8060TCA	167	227	02/92	>	04/01				S 7259 A
prefilter / prefiltrato	8060TCA	167	227	02/92	>	04/01		S 0999 NR		
power steering / servosterzo	8060TCA	167	227	02/92	>	04/01				S 3081 PO
120EL15	8060.45B/8060.45R	105	143	12/91	>	04/01	S 3003 DR	S 8500 NR	S 7183 A	
with horizontal air filter / con filtro aria orizzontale	8060.45B/8060.45R	105	143	12/91	>	04/01	S 3003 DR	S 8500 NR	S 2450 A	
dryer filter / filtro essiccatore	8060.45B/8060.45R	105	143	12/91	>	04/01				S 7259 A
prefilter / prefiltrato	8060.45B/8060.45R	105	143	12/91	>	04/01		S 0999 NR		
power steering / servosterzo	8060.45B/8060.45R	105	143	12/91	>	04/01				S 3081 PO
120EL18	8060.45B	130	177	09/91	>	04/01	S 3003 DR	S 8500 NR	S 7183 A	
dryer filter / filtro essiccatore	8060.45B	130	177	09/91	>	04/01				S 7259 A
prefilter / prefiltrato	8060.45B	130	177	09/91	>	04/01		S 0999 NR		
power steering / servosterzo	8060.45B	130	177	09/91	>	04/01				S 3081 PO
120EL21	8060.45 E2	152	207	01/91	>	04/01	S 3003 DR	S 8500 NR	S 7183 A	
dryer filter / filtro essiccatore	8060.45 E2	152	207	01/91	>	04/01				S 7259 A
prefilter / prefiltrato	8060.45 E2	152	207	01/91	>	04/01		S 0999 NR		
power steering / servosterzo	8060.45 E2	152	207	01/91	>	04/01				S 3081 PO
130E15	8060.25R/8060 LTC	105	143	02/92	>	04/01	S 3003 DR	S 8500 NR	S 7183 A	
dryer filter / filtro essiccatore	8060.25R/8060 LTC	105	143	02/92	>	04/01				S 7259 A
prefilter / prefiltrato	8060.25R/8060 LTC	105	143	02/92	>	04/01		S 0999 NR		
power steering / servosterzo	8060.25R/8060 LTC	105	143	02/92	>	04/01				S 3081 PO
130E15	8060.45R	105	143	02/92	>	04/01	S 3003 DR	S 8500 NR	S 7183 A	
dryer filter / filtro essiccatore	8060.45R	105	143	02/92	>	04/01				S 7259 A
prefilter / prefiltrato	8060.45R	105	143	02/92	>	04/01		S 0999 NR		
power steering / servosterzo	8060.45R	105	143	02/92	>	04/01				S 3081 PO
130E18	8060.25V	130	177	01/91	>	04/01	S 3003 DR	S 8500 NR	S 7183 A	
dryer filter / filtro essiccatore	8060.25V	130	177	01/91	>	04/01				S 7259 A
prefilter / prefiltrato	8060.25V	130	177	01/91	>	04/01		S 0999 NR		
power steering / servosterzo	8060.25V	130	177	01/91	>	04/01				S 3081 PO
130E18	8060.45B	130	177	01/91	>	04/01	S 3003 DR	S 8500 NR	S 7183 A	
dryer filter / filtro essiccatore	8060.45B	130	177	01/91	>	04/01				S 7259 A
prefilter / prefiltrato	8060.45B	130	177	01/91	>	04/01		S 0999 NR		
power steering / servosterzo	8060.45B	130	177	01/91	>	04/01				S 3081 PO
130E23	8060.45S E2	167	227	04/92	>	04/01			S 7482 A	
dryer filter / filtro essiccatore	8060.45S E2	167	227	02/92	>	04/01				S 7259 A
assembly BOSCH / montaggio BOSCH	8060.45S E2	167	227	02/92	>	04/01	S 5003 DR	S 5401 NR	S 7187 A	
assembly UFI / montaggio UFI	8060.45S E2	167	227	02/92	>	04/01	S 5003 DR	S 4329 NR	S 7187 A	
or / oppure	8060.45S E2	167	227	02/92	>	04/01	S 5003 DR	S 5400 NR	S 7187 A	
prefilter / prefiltrato	8060.45S E2	167	227	02/92	>	04/01		S 0999 NR		
power steering / servosterzo	8060.45S E2	167	227	02/92	>	04/01				S 3081 PO
130E23	8060.45S/8060.45SS	167	227	04/92	>	04/01	S 5003 DR	S 4329 NR	S 2650 A	
dryer filter / filtro essiccatore	8060.45S/8060.45SS	167	227	04/92	>	04/01				S 7259 A
prefilter / prefiltrato	8060.45S/8060.45SS	167	227	04/92	>	04/01		S 0999 NR		
power steering / servosterzo	8060.45S/8060.45SS	167	227	04/92	>	04/01				S 3081 PO
130E23	8060TCA	167	227	02/92	>	04/01	S 5003 DR	S 4329 NR	S 7187 A	
dryer filter / filtro essiccatore	8060TCA	167	227	02/92	>	04/01				S 7259 A
prefilter / prefiltrato	8060TCA	167	227	02/92	>	04/01		S 0999 NR		
power steering / servosterzo	8060TCA	167	227	02/92	>	04/01				S 3081 PO
135E18	8060.25V	130	177	09/91	>	04/01	S 3003 DR	S 8500 NR	S 7183 A	
dryer filter / filtro essiccatore	8060.25V	130	177	09/91	>	04/01				S 7259 A
prefilter / prefiltrato	8060.25V	130	177	09/91	>	04/01		S 0999 NR		
power steering / servosterzo	8060.25V	130	177	09/91	>	04/01				S 3081 PO
135E18	8060.45B	130	177	09/91	>	04/01	S 3003 DR	S 8500 NR	S 7183 A	
dryer filter / filtro essiccatore	8060.45B	130	177	09/91	>	04/01				S 7259 A
prefilter / prefiltrato	8060.45B	130	177	09/91	>	04/01		S 0999 NR		
power steering / servosterzo	8060.45B	130	177	09/91	>	04/01				S 3081 PO
135E23	8060.45S E2	167	227	02/92	>	04/01	S 5003 DR	S 4329 NR	S 2650 A	
dryer filter / filtro essiccatore	8060.45S E2	167	227	02/92	>	04/01				S 7259 A
prefilter / prefiltrato	8060.45S E2	167	227	02/92	>	04/01		S 0999 NR		
power steering / servosterzo	8060.45S E2	167	227	02/92	>	04/01				S 3081 PO
135E23	8060.45S/8060.45SS	167	227	04/92	>	04/01	S 5003 DR	S 4329 NR	S 2650 A	
dryer filter / filtro essiccatore	8060.45S/8060.45SS	167	227	04/92	>	04/01				S 7259 A
prefilter / prefiltrato	8060.45S/8060.45SS	167	227	04/92	>	04/01		S 0999 NR		
power steering / servosterzo	8060.45S/8060.45SS	167	227	04/92	>	04/01				S 3081 PO
150E15	8060.25R/8060.45R	105	143	12/91	>	04/01	S 3003 DR	S 8500 NR	S 7183 A	



**KW HP****...IVECO - trucks/autocarri**

dryer filter / filtro essiccatore	8060.25R/8060.45R	105	143	12/91	>	04/01			S 7259 A
prefilter / prefiltra	8060.25R/8060.45R	105	143	12/91	>	04/01		S 0999 NR	
power steering / servosterzo	8060.25R/8060.45R	105	143	12/91	>	04/01			S 3081 PO
150E15H	8060.25R	105	143	12/91	>	04/01	S 3003 DR	S 8500 NR	S 7183 A
dryer filter / filtro essiccatore	8060.25R	105	143	12/91	>	04/01			S 7259 A
prefilter / prefiltra	8060.25R	105	143	12/91	>	04/01		S 0999 NR	
power steering / servosterzo	8060.25R	105	143	12/91	>	04/01			S 3081 PO
150E18	8060.25V/8060.45B	130	177	09/91	>	04/01	S 3003 DR	S 8500 NR	S 7183 A
dryer filter / filtro essiccatore	8060.25V/8060.45B	130	177	09/91	>	04/01			S 7259 A
prefilter / prefiltra	8060.25V/8060.45B	130	177	09/91	>	04/01		S 0999 NR	
power steering / servosterzo	8060.25V/8060.45B	130	177	09/91	>	04/01			S 3081 PO
150E18H	8060.25V	130	177	09/91	>	04/01	S 3003 DR		S 7183 A
dryer filter / filtro essiccatore	8060.25V	130	177	09/91	>	04/01			S 7259 A
prefilter / prefiltra	8060.25V	130	177	09/91	>	04/01		S 0999 NR	
power steering / servosterzo	8060.25V	130	177	09/91	>	04/01			S 3081 PO
150E21H	8060.45 E2	130	177	01/91	>	04/01	S 3003 DR	S 8500 NR	S 7183 A
dryer filter / filtro essiccatore	8060.45 E2	130	177	01/91	>	04/01			S 7259 A
prefilter / prefiltra	8060.45 E2	130	177	01/91	>	04/01		S 0999 NR	
power steering / servosterzo	8060.45 E2	130	177	01/91	>	04/01			S 3081 PO
150E23	8060.45S/8060.45S E2	167	227	02/92	>	04/01			S 7259 A
dryer filter / filtro essiccatore	8060.45S/8060.45S E2	167	227	02/92	>	04/01	S 5003 DR	S 5401 NR	S 7187 A
assembly BOSCH / montaggio BOSCH	8060.45S/8060.45S E2	167	227	02/92	>	04/01	S 5003 DR	S 4329 NR	S 7187 A
assembly UFI / montaggio UFI	8060.45S/8060.45S E2	167	227	02/92	>	04/01	S 5003 DR	S 5400 NR	S 7187 A
or / oppure	8060.45S/8060.45S E2	167	227	02/92	>	04/01	S 5003 DR	S 5400 NR	S 7187 A
prefilter / prefiltra	8060.45S/8060.45S E2	167	227	02/92	>	04/01		S 0999 NR	
power steering / servosterzo	8060.45S/8060.45S E2	167	227	02/92	>	04/01			S 3081 PO
150E23H	8060.45S/8060.45S E2	167	227	02/92	>	04/01			S 7259 A
dryer filter / filtro essiccatore	8060.45S/8060.45S E2	167	227	02/92	>	04/01	S 5003 DR	S 5401 NR	S 7187 A
assembly BOSCH / montaggio BOSCH	8060.45S/8060.45S E2	167	227	02/92	>	04/01	S 5003 DR	S 4329 NR	S 7187 A
assembly UFI / montaggio UFI	8060.45S/8060.45S E2	167	227	02/92	>	04/01	S 5003 DR	S 5400 NR	S 7187 A
or / oppure	8060.45S/8060.45S E2	167	227	02/92	>	04/01	S 5003 DR	S 5400 NR	S 7187 A
prefilter / prefiltra	8060.45S/8060.45S E2	167	227	02/92	>	04/01		S 0999 NR	
power steering / servosterzo	8060.45S/8060.45S E2	167	227	02/92	>	04/01			S 3081 PO
150E27	8360.46/8360.46 E2	196	267	09/91	>	04/01	S 5003 DR	S 4329 NR	S 7187 A
some / alcuni	8360.46/8360.46 E2	196	267	09/91	>	04/01	S 5003 DR	S 5401 NR	S 7187 A
dryer filter / filtro essiccatore	8360.46/8360.46 E2	196	267	09/91	>	04/01			S 8410 AR
or / oppure	8360.46/8360.46 E2	196	267	09/91	>	04/01	S 5003 DR	S 5400 NR	S 7187 A
prefilter / prefiltra	8360.46/8360.46 E2	196	267	09/91	>	04/01		S 0999 NR	S 8410 AR
power steering / servosterzo	8360.46/8360.46 E2	196	267	09/91	>	04/01			S 3081 PO
170E15	8060.25R	105	143	12/91	>	04/01	S 3003 DR	S 8500 NR	S 7183 A
dryer filter / filtro essiccatore	8060.25R	105	143	12/91	>	04/01			S 7259 A
prefilter / prefiltra	8060.25R	105	143	12/91	>	04/01		S 0999 NR	
power steering / servosterzo	8060.25R	105	143	12/91	>	04/01			S 3081 PO
170E18	8060.25V	130	177	01/94	>	04/01	S 3003 DR	S 8500 NR	S 7183 A
dryer filter / filtro essiccatore	8060.25V	130	177	01/94	>	04/01			S 7259 A
prefilter / prefiltra	8060.25V	130	177	01/94	>	04/01		S 0999 NR	
power steering / servosterzo	8060.25V	130	177	01/94	>	04/01			S 3081 PO
170E18	8060.45B	130	177	01/94	>	04/01	S 3003 DR	S 8500 NR	S 7183 A
dryer filter / filtro essiccatore	8060.45B	130	177	01/94	>	04/01			S 7259 A
prefilter / prefiltra	8060.45B	130	177	01/94	>	04/01		S 0999 NR	
power steering / servosterzo	8060.45B	130	177	01/94	>	04/01			S 3081 PO
170E23	8060.45S/8060.45S E2	167	227	01/94	>	04/01	S 5003 DR	S 4329 NR	S 7187 A
dryer filter / filtro essiccatore	8060.45S/8060.45S E2	167	227	01/94	>	04/01			S 7259 A
prefilter / prefiltra	8060.45S/8060.45S E2	167	227	01/94	>	04/01		S 0999 NR	
power steering / servosterzo	8060.45S/8060.45S E2	167	227	01/94	>	04/01			S 3081 PO
170E27	8360.46 E2	196	267	09/91	>	04/01	S 5003 DR	S 4329 NR	S 7187 A
dryer filter / filtro essiccatore	8360.46 E2	196	267	09/91	>	04/01			S 7259 A
prefilter / prefiltra	8360.46 E2	196	267	09/91	>	04/01		S 0999 NR	
power steering / servosterzo	8360.46 E2	196	267	09/91	>	04/01			S 3081 PO
180E18	8060.25V/8060.45B	130	177	01/98	>	04/01	S 3003 DR	S 8500 NR	S 7183 A
dryer filter / filtro essiccatore	8060.25V/8060.45B	130	177	01/98	>	04/01			S 7259 A
prefilter / prefiltra	8060.25V/8060.45B	130	177	01/98	>	04/01		S 0999 NR	
power steering / servosterzo	8060.25V/8060.45B	130	177	01/98	>	04/01			S 3081 PO
180E18V	8060.25V	130	177	01/94	>	04/01	S 3003 DR	S 8500 NR	S 7183 A
dryer filter / filtro essiccatore	8060.25V	130	177	01/94	>	04/01			S 7259 A
prefilter / prefiltra	8060.25V	130	177	01/94	>	04/01		S 0999 NR	
power steering / servosterzo	8060.25V	130	177	01/94	>	04/01			S 3081 PO

**KW HP****...IVECO - trucks/autocarri**

180E21	8060.45/8060.45 E2	152	207	04/92	>	04/01	S 3003 DR	S 8500 NR	S 7183 A	
dryer filter / filtro essiccatore	8060.45/8060.45 E2	152	207	04/92	>	04/01				S 7259 A
prefilter / prefiltra	8060.45/8060.45 E2	152	207	04/92	>	04/01		S 0999 NR		
power steering / servosterzo	8060.45/8060.45 E2	152	207	04/92	>	04/01				S 3081 PO
260E23	8060.45S/8060.45S E2	167	227	01/94	>	04/01	S 5003 DR	S 4329 NR	S 7187 A	
dryer filter / filtro essiccatore	8060.45S/8060.45S E2	167	227	01/94	>	04/01				S 7259 A
prefilter / prefiltra	8060.45S/8060.45S E2	167	227	01/94	>	04/01		S 0999 NR		
power steering / servosterzo	8060.45S/8060.45S E2	167	227	01/94	>	04/01				S 3081 PO
260E23	8060TCA	167	227	02/92	>	04/01	S 5003 DR	S 4329 NR	S 7187 A	
dryer filter / filtro essiccatore	8060TCA	167	227	02/92	>	04/01				S 7259 A
prefilter / prefiltra	8060TCA	167	227	02/92	>	04/01		S 0999 NR		
power steering / servosterzo	8060TCA	167	227	02/92	>	04/01				S 3081 PO
260E23KE	8060.45S	167	227	12/91	>	04/01	S 5003 DR	S 4329 NR	S 7187 A	
dryer filter / filtro essiccatore	8060.45S	167	227	12/91	>	04/01				S 7259 A
prefilter / prefiltra	8060.45S	167	227	12/91	>	04/01		S 0999 NR		
power steering / servosterzo	8060.45S	167	227	12/91	>	04/01				S 3081 PO
260E27KE	8360.46/8360.46 E2	196	267	09/91	>	04/01	S 5003 DR	S 4329 NR	S 7187 A	S 8410 AR
some / alcuni	8360.46/8360.46 E2	196	267	09/91	>	04/01	S 5003 DR	S 5401 NR	S 7187 A	S 8410 AR
dryer filter / filtro essiccatore	8360.46/8360.46 E2	196	267	09/91	>	04/01				S 7259 A
or / oppure	8360.46/8360.46 E2	196	267	09/91	>	04/01	S 5003 DR	S 5400 NR	S 7187 A	S 8410 AR
prefilter / prefiltra	8360.46/8360.46 E2	196	267	09/91	>	04/01		S 0999 NR		
power steering / servosterzo	8360.46/8360.46 E2	196	267	09/91	>	04/01				S 3081 PO
280E23	8060.45S/8060.45S E2	167	227	01/94	>	04/01	S 5003 DR	S 4329 NR	S 7187 A	
dryer filter / filtro essiccatore	8060.45S/8060.45S E2	167	227	01/94	>	04/01				S 7259 A
prefilter / prefiltra	8060.45S/8060.45S E2	167	227	01/94	>	04/01		S 0999 NR		
power steering / servosterzo	8060.45S/8060.45S E2	167	227	01/94	>	04/01				S 3081 PO
320E27	8360.46/8360.46 E2	196	267	09/91	>	04/01	S 5003 DR	S 4329 NR	S 7187 A	S 8410 AR
some / alcuni	8360.46/8360.46 E2	196	267	09/91	>	04/01	S 5003 DR	S 5401 NR	S 7187 A	S 8410 AR
dryer filter / filtro essiccatore	8360.46/8360.46 E2	196	267	09/91	>	04/01				S 7259 A
or / oppure	8360.46/8360.46 E2	196	267	09/91	>	04/01	S 5003 DR	S 5400 NR	S 7187 A	S 8410 AR
prefilter / prefiltra	8360.46/8360.46 E2	196	267	09/91	>	04/01		S 0999 NR		
power steering / servosterzo	8360.46/8360.46 E2	196	267	09/91	>	04/01				S 3081 PO
60E10	8040.25B	75	102	01/91	>	04/01	S 3003 DR	S 8500 NR	S 7183 A	
dryer filter / filtro essiccatore	8040.25B	75	102	01/91	>	04/01				S 7259 A
prefilter / prefiltra	8040.25B	75	102	01/91	>	04/01		S 0999 NR		
power steering / servosterzo	8040.25B	75	102	01/91	>	04/01				S 3081 PO
60E12	8040.25X	85	116	01/91	>	04/01	S 3003 DR	S 8500 NR	S 7183 A	
dryer filter / filtro essiccatore	8040.25X	85	116	01/91	>	04/01				S 7259 A
prefilter / prefiltra	8040.25X	85	116	01/91	>	04/01		S 0999 NR		
power steering / servosterzo	8040.25X	85	116	01/91	>	04/01				S 3081 PO
60E14	8040.45	100	136	01/91	>	04/01	S 3003 DR	S 8500 NR	S 7183 A	
dryer filter / filtro essiccatore	8040.45	100	136	01/91	>	04/01				S 7259 A
prefilter / prefiltra	8040.45	100	136	01/91	>	04/01		S 0999 NR		
power steering / servosterzo	8040.45	100	136	01/91	>	04/01				S 3081 PO
65E10	8040.25B	75	102	01/91	>	04/01	S 3003 DR	S 8500 NR	S 7183 A	
dryer filter / filtro essiccatore	8040.25B	75	102	01/91	>	04/01				S 7259 A
prefilter / prefiltra	8040.25B	75	102	01/91	>	04/01		S 0999 NR		
power steering / servosterzo	8040.25B	75	102	01/91	>	04/01				S 3081 PO
65E12	8040.25X	85	116	01/91	>	04/01	S 3003 DR	S 8500 NR	S 7183 A	
dryer filter / filtro essiccatore	8040.25X	85	116	01/91	>	04/01				S 7259 A
prefilter / prefiltra	8040.25X	85	116	01/91	>	04/01		S 0999 NR		
power steering / servosterzo	8040.25X	85	116	01/91	>	04/01				S 3081 PO
65E12H	8040.25X	85	116	01/91	>	04/01	S 3003 DR	S 8500 NR		
dryer filter / filtro essiccatore	8040.25X	85	116	01/91	>	04/01				S 7259 A
prefilter / prefiltra	8040.25X	85	116	01/91	>	04/01		S 0999 NR		
power steering / servosterzo	8040.25X	85	116	01/91	>	04/01				S 3081 PO
65E14	8040.45	100	136	01/91	>	04/01	S 3003 DR	S 8500 NR	S 7183 A	
dryer filter / filtro essiccatore	8040.45	100	136	01/91	>	04/01				S 7259 A
prefilter / prefiltra	8040.45	100	136	01/91	>	04/01		S 0999 NR		
power steering / servosterzo	8040.45	100	136	01/91	>	04/01				S 3081 PO
75E12	8040.25X	85	116	01/91	>	04/01	S 3003 DR	S 8500 NR	S 7183 A	
dryer filter / filtro essiccatore	8040.25X	85	116	01/91	>	04/01				S 7259 A
prefilter / prefiltra	8040.25X	85	116	01/91	>	04/01		S 0999 NR		
power steering / servosterzo	8040.25X	85	116	01/91	>	04/01				S 3081 PO
75E14	8040.45	100	136	01/91	>	04/01	S 3003 DR	S 8500 NR	S 7183 A	
dryer filter / filtro essiccatore	8040.45	100	136	01/91	>	04/01				S 7259 A
prefilter / prefiltra	8040.45	100	136	01/91	>	04/01		S 0999 NR		



**KW HP****...IVECO - trucks/autocarri**

power steering / servosterzo	8040.45	100	136	01/91	>	04/01				S 3081 PO
75E15	8060.25R	105	143	01/91	>	04/01	S 3003 DR	S 8500 NR	S 7183 A	
dryer filter / filtro essiccatore	8060.25R	105	143	01/91	>	04/01				S 7259 A
prefilter / prefiltrato	8060.25R	105	143	01/91	>	04/01		S 0999 NR		
power steering / servosterzo	8060.25R	105	143	01/91	>	04/01				S 3081 PO
80E13		95	130	01/91	>	04/01	S 3003 DR	S 8500 NR	S 7183 A	
dryer filter / filtro essiccatore		95	130	01/91	>	04/01				S 7259 A
prefilter / prefiltrato		95	130	01/91	>	04/01		S 0999 NR		
power steering / servosterzo		95	130	01/91	>	04/01				S 3081 PO
80E15	8060.25R	105	143	01/91	>	04/01	S 3003 DR	S 8500 NR	S 7183 A	
dryer filter / filtro essiccatore	8060.25R	105	143	01/91	>	04/01				S 7259 A
prefilter / prefiltrato	8060.25R	105	143	01/91	>	04/01		S 0999 NR		
power steering / servosterzo	8060.25R	105	143	01/91	>	04/01				S 3081 PO
80E18	8060.25V	130	177	01/91	>	04/01	S 3003 DR	S 8500 NR	S 7183 A	
dryer filter / filtro essiccatore	8060.25V	130	177	01/91	>	04/01				S 7259 A
prefilter / prefiltrato	8060.25V	130	177	01/91	>	04/01		S 0999 NR		
power steering / servosterzo	8060.25V	130	177	01/91	>	04/01				S 3081 PO
80E21	8060.45	152	207	01/91	>	04/01	S 3003 DR	S 8500 NR	S 7183 A	
dryer filter / filtro essiccatore	8060.45	152	207	01/91	>	04/01				S 7259 A
prefilter / prefiltrato	8060.45	152	207	01/91	>	04/01		S 0999 NR		
power steering / servosterzo	8060.45	152	207	01/91	>	04/01				S 3081 PO
85E15	8060.25R/8060.45R	105	143	01/91	>	04/01	S 3003 DR	S 8500 NR	S 7183 A	
dryer filter / filtro essiccatore	8060.25R/8060.45R	105	143	01/91	>	04/01				S 7259 A
prefilter / prefiltrato	8060.25R/8060.45R	105	143	01/91	>	04/01		S 0999 NR		
power steering / servosterzo	8060.25R/8060.45R	105	143	01/91	>	04/01				S 3081 PO
85E15H	8060.25R/8060.45R	105	143	01/91	>	04/01	S 3003 DR	S 8500 NR	S 7183 A	
dryer filter / filtro essiccatore	8060.25R/8060.45R	105	143	01/91	>	04/01				S 7259 A
prefilter / prefiltrato	8060.25R/8060.45R	105	143	01/91	>	04/01		S 0999 NR		
power steering / servosterzo	8060.25R/8060.45R	105	143	01/91	>	04/01				S 3081 PO
85E18H	8060.25V	130	177	01/91	>	04/01	S 3003 DR	S 8500 NR		
dryer filter / filtro essiccatore	8060.25V	130	177	01/91	>	04/01				S 7259 A
prefilter / prefiltrato	8060.25V	130	177	01/91	>	04/01		S 0999 NR		
power steering / servosterzo	8060.25V	130	177	01/91	>	04/01				S 3081 PO
95E15	8060.25	105	143	01/91	>	04/01	S 3003 DR	S 8500 NR	S 7183 A	
dryer filter / filtro essiccatore	8060.25	105	143	01/91	>	04/01				S 7259 A
prefilter / prefiltrato	8060.25	105	143	01/91	>	04/01		S 0999 NR		
power steering / servosterzo	8060.25	105	143	01/91	>	04/01				S 3081 PO
95E21	8060.45	152	207	01/91	>	04/01	S 3003 DR	S 8500 NR	S 2650 A	
dryer filter / filtro essiccatore	8060.45	152	207	01/91	>	04/01				S 7259 A
prefilter / prefiltrato	8060.45	152	207	01/91	>	04/01		S 0999 NR		
power steering / servosterzo	8060.45	152	207	01/91	>	04/01				S 3081 PO

Eurocargo Tector I

100E17	F4AE0481	125	170	09/00	>	09/03	S 0620 R	S 2220 NR	S 7625 A	
with filter BLOW-BY / con filtro BLOW-BY	F4AE0481	125	170	09/00	>	09/03				S 7B11 A
dryer filter / filtro essiccatore	F4AE0481	125	170	09/00	>	09/03				S 7259 A
prefilter / prefiltrato	F4AE0481	125	170	09/00	>	09/03		S 0999 NR		
dusty areas / zone polverose	F4AE0481	125	170	09/00	>	09/03			S 7627 A	
100E18	F4AE0681	134	183	09/00	>	09/03	S 0620 R	S 2220 NR	S 7625 A	
with filter BLOW-BY / con filtro BLOW-BY	F4AE0681	134	183	09/00	>	09/03				S 7B11 A
dryer filter / filtro essiccatore	F4AE0681	134	183	09/00	>	09/03				S 7259 A
prefilter / prefiltrato	F4AE0681	134	183	09/00	>	09/03		S 0999 NR		
dusty areas / zone polverose	F4AE0681	134	183	09/00	>	09/03	S 0620 R	S 2220 NR	S 7627 A	
100E21	F4AE0681	154	210	09/00	>	09/03	S 0620 R	S 2220 NR	S 7625 A	
with filter BLOW-BY / con filtro BLOW-BY	F4AE0681	154	210	09/00	>	09/03				S 7B11 A
dryer filter / filtro essiccatore	F4AE0681	154	210	09/00	>	09/03				S 7259 A
prefilter / prefiltrato	F4AE0681	154	210	09/00	>	09/03		S 0999 NR		
dusty areas / zone polverose	F4AE0681	154	210	09/00	>	09/03	S 0620 R	S 2220 NR	S 7627 A	
110EL17	F4AE0481	125	170	09/00	>	09/03	S 0620 R	S 2220 NR	S 7625 A	
with filter BLOW-BY / con filtro BLOW-BY	F4AE0481	125	170	09/00	>	09/03				S 7B11 A
dryer filter / filtro essiccatore	F4AE0481	125	170	09/00	>	09/03				S 7259 A
prefilter / prefiltrato	F4AE0481	125	170	09/00	>	09/03		S 0999 NR		
110EL21	F4AE0681	154	210	09/00	>	09/03	S 0620 R	S 2220 NR	S 7625 A	
with filter BLOW-BY / con filtro BLOW-BY	F4AE0681	154	210	09/00	>	09/03				S 7B11 A
dryer filter / filtro essiccatore	F4AE0681	154	210	09/00	>	09/03				S 7259 A
prefilter / prefiltrato	F4AE0681	154	210	09/00	>	09/03		S 0999 NR		
120E17	F4AE0481	125	170	09/00	>	09/03	S 0620 R	S 2220 NR	S 7625 A	
with filter BLOW-BY / con filtro BLOW-BY	F4AE0481	125	170	09/00	>	09/03				S 7B11 A



...IVECO - trucks/autocarri

with filter BLOW-BY / con filtro BLOW-BY	F4AE0681	134	183	09/00	>	09/03				S 7B11 A
dryer filter / filtro essiccatore	F4AE0681	134	183	09/00	>	09/03				S 7259 A
prefilter / prefiltrato	F4AE0681	134	183	09/00	>	09/03		S 0999 NR		
90E21	F4AE0681	154	210	09/00	>	09/03	S 0620 R	S 2220 NR	S 7625 A	
with filter BLOW-BY / con filtro BLOW-BY	F4AE0681	154	210	09/00	>	09/03				S 7B11 A
dryer filter / filtro essiccatore	F4AE0681	154	210	09/00	>	09/03				S 7259 A
prefilter / prefiltrato	F4AE0681	154	210	09/00	>	09/03		S 0999 NR		
Eurocargo Tector II										
100E17	F4AE0481A	125	170	06/03	>		S 0620 R	S 2220 NR	S 7625 A	
with filter BLOW-BY / con filtro BLOW-BY	F4AE0481A	125	170	06/03	>	12/06				S 7B11 A
dryer filter / filtro essiccatore	F4AE0481A	125	170	06/03	>					S 7259 A
prefilter / prefiltrato	F4AE0481A	125	170	06/03	>			S 0999 NR		
dusty areas / zone polverose	F4AE0481A	125	170	06/03	>	08/08	S 0620 R	S 2220 NR	S 7627 A	
100E18	F4AE0681E	134	182	06/03	>		S 0620 R	S 2220 NR	S 7625 A	
dryer filter / filtro essiccatore	F4AE0681E	134	182	06/03	>					S 7259 A
prefilter / prefiltrato	F4AE0681E	134	182	06/03	>			S 0999 NR		
dusty areas / zone polverose	F4AE0681E	134	182	06/03	>		S 0620 R	S 2220 NR	S 7627 A	
100E18	F4AE3481BP Euro4/5	130	177	05/06	>		S 0620 R	S 2220 NR		
with filter Urea/Adblue / con filtro Urea/Adblue	F4AE3481BP Euro4/5	130	177	05/06	>					S 4401 U
dryer filter / filtro essiccatore	F4AE3481BP Euro4/5	130	177	05/06	>					S 7259 A
prefilter / prefiltrato	F4AE3481BP Euro4/5	130	177	05/06	>			S 1999 NR		
100E18W 4x4	F4AE3481BP Euro4/5	130	177	05/06	>		S 0620 R	S 2220 NR		
with filter Urea/Adblue / con filtro Urea/Adblue	F4AE3481BP Euro4/5	130	177	05/06	>					S 4401 U
dryer filter / filtro essiccatore	F4AE3481BP Euro4/5	130	177	05/06	>					S 7259 A
prefilter / prefiltrato	F4AE3481BP Euro4/5	130	177	05/06	>			S 1999 NR		
100E21	F4AE0681D	154	209	06/03	>		S 0620 R	S 2220 NR	S 7625 A	
dryer filter / filtro essiccatore	F4AE0681D	154	209	06/03	>					S 7259 A
prefilter / prefiltrato	F4AE0681D	154	209	06/03	>			S 0999 NR		
dusty areas / zone polverose	F4AE0681D	154	209	06/03	>		S 0620 R	S 2220 NR	S 7627 A	
100E22	F4AE3681BP Euro4/5	160	217	05/06	>		S 0620 R	S 2220 NR		
with filter Urea/Adblue / con filtro Urea/Adblue	F4AE3681BP Euro4/5	160	217	05/06	>					S 4401 U
dryer filter / filtro essiccatore	F4AE3681BP Euro4/5	160	217	05/06	>					S 7259 A
prefilter / prefiltrato	F4AE3681BP Euro4/5	160	217	05/06	>			S 1999 NR		
100E22W 4x4	F4AE3681BP Euro4/5	160	217	05/06	>		S 0620 R	S 2220 NR		
with filter Urea/Adblue / con filtro Urea/Adblue	F4AE3681BP Euro4/5	160	217	05/06	>					S 4401 U
dryer filter / filtro essiccatore	F4AE3681BP Euro4/5	160	217	05/06	>					S 7259 A
prefilter / prefiltrato	F4AE3681BP Euro4/5	160	217	05/06	>			S 1999 NR		
110E18	F4AE3481BP Euro4/5	130	177	05/06	>		S 0620 R	S 2220 NR		
with filter Urea/Adblue / con filtro Urea/Adblue	F4AE3481BP Euro4/5	130	177	05/06	>					S 4401 U
dryer filter / filtro essiccatore	F4AE3481BP Euro4/5	130	177	05/06	>					S 7259 A
prefilter / prefiltrato	F4AE3481BP Euro4/5	130	177	05/06	>			S 1999 NR		
110E22	F4AE3681BP Euro4/5	160	217	05/06	>		S 0620 R	S 2220 NR		
with filter Urea/Adblue / con filtro Urea/Adblue	F4AE3681BP Euro4/5	160	217	05/06	>					S 4401 U
dryer filter / filtro essiccatore	F4AE3681BP Euro4/5	160	217	05/06	>					S 7259 A
prefilter / prefiltrato	F4AE3681BP Euro4/5	160	217	05/06	>			S 1999 NR		
110EL17	F4AE0481A	125	170	06/03	>		S 0620 R	S 2220 NR	S 7625 A	
dryer filter / filtro essiccatore	F4AE0481A	125	170	06/03	>					S 7259 A
prefilter / prefiltrato	F4AE0481A	125	170	06/03	>			S 0999 NR		
110EL21	F4AE0681D	154	209	06/03	>		S 0620 R	S 2220 NR	S 7625 A	
dryer filter / filtro essiccatore	F4AE0681D	154	209	06/03	>					S 7259 A
prefilter / prefiltrato	F4AE0681D	154	209	06/03	>			S 0999 NR		
120E18	F4AE0681E	134	182	06/03	>		S 0620 R	S 2220 NR	S 7625 A	
dryer filter / filtro essiccatore	F4AE0681E	134	182	06/03	>					S 7259 A
prefilter / prefiltrato	F4AE0681E	134	182	06/03	>			S 0999 NR		
120E18	F4AE3481BP Euro4/5	130	177	05/06	>		S 0620 R	S 2220 NR		
with filter Urea/Adblue / con filtro Urea/Adblue	F4AE3481BP Euro4/5	130	177	05/06	>					S 4401 U
dryer filter / filtro essiccatore	F4AE3481BP Euro4/5	130	177	05/06	>					S 7259 A
prefilter / prefiltrato	F4AE3481BP Euro4/5	130	177	05/06	>			S 1999 NR		
120E20 CNG	F4BE0611A	147	200	05/06	>	08/08	S 0620 R			
with filter BLOW-BY / con filtro BLOW-BY	F4BE0611A	147	200	05/06	>	12/06				S 7B11 A
dryer filter / filtro essiccatore	F4BE0611A	147	200	05/06	>	08/08				S 7259 A
120E21	F4AE0681D	154	209	06/03	>		S 0620 R	S 2220 NR	S 7625 A	
dryer filter / filtro essiccatore	F4AE0681D	154	209	06/03	>					S 7259 A
prefilter / prefiltrato	F4AE0681D	154	209	06/03	>			S 0999 NR		
120E22	F4AE3681BP Euro4/5	160	217	05/06	>		S 0620 R	S 2220 NR		
with filter Urea/Adblue / con filtro Urea/Adblue	F4AE3681BP Euro4/5	160	217	05/06	>					S 4401 U
dryer filter / filtro essiccatore	F4AE3681BP Euro4/5	160	217	05/06	>					S 7259 A

**kW HP****...IVECO - trucks/autocarri**

prefilter / prefiltrato	F4AE3681BP Euro4/5	160	217	05/06	>		S 1999 NR		
120E24	F4AE0681B	176	239	06/03	>	S 0620 R	S 2220 NR	S 7626 A	
dryer filter / filtro essiccatore	F4AE0681B	176	239	06/03	>				S 7259 A
prefilter / prefiltrato	F4AE0681B	176	239	06/03	>		S 0999 NR		
120E25	F4AE3681DP Euro4/5	185	251	05/06	>	S 0620 R	S 2220 NR		
with filter Urea/Adblue / con filtro Urea/Adblue	F4AE3681DP Euro4/5	185	251	05/06	>				S 4401 U
dryer filter / filtro essiccatore	F4AE3681DP Euro4/5	185	251	05/06	>				S 7259 A
prefilter / prefiltrato	F4AE3681DP Euro4/5	185	251	05/06	>		S 1999 NR		
120E28	F4AE0681A	202	275	06/03	>	S 0620 R	S 2220 NR	S 7626 A	
dryer filter / filtro essiccatore	F4AE0681A	202	275	06/03	>				S 7259 A
prefilter / prefiltrato	F4AE0681A	202	275	06/03	>		S 0999 NR		
120E28	F4AE3681EP Euro4/5	205	279	05/06	>	S 0620 R	S 2220 NR		
with filter Urea/Adblue / con filtro Urea/Adblue	F4AE3681EP Euro4/5	205	279	05/06	>				S 4401 U
dryer filter / filtro essiccatore	F4AE3681EP Euro4/5	205	279	05/06	>				S 7259 A
prefilter / prefiltrato	F4AE3681EP Euro4/5	205	279	05/06	>		S 1999 NR		
120EL21	F4AE0681D	154	209	06/03	>	S 0620 R	S 2220 NR	S 7625 A	
dryer filter / filtro essiccatore	F4AE0681D	154	209	06/03	>				S 7259 A
prefilter / prefiltrato	F4AE0681D	154	209	06/03	>		S 0999 NR		
130E18	F4AE0681E	134	182	06/03	>	S 0620 R	S 2220 NR	S 7625 A	
dryer filter / filtro essiccatore	F4AE0681E	134	182	06/03	>				S 7259 A
prefilter / prefiltrato	F4AE0681E	134	182	06/03	>		S 0999 NR		
dusty areas / zone polverose	F4AE0681E	134	182	06/03	>	S 0620 R	S 2220 NR	S 7627 A	
130E18	F4AE3481BP Euro4/5	130	177	05/06	>	S 0620 R	S 2220 NR		
with filter Urea/Adblue / con filtro Urea/Adblue	F4AE3481BP Euro4/5	130	177	05/06	>				S 4401 U
dryer filter / filtro essiccatore	F4AE3481BP Euro4/5	130	177	05/06	>				S 7259 A
prefilter / prefiltrato	F4AE3481BP Euro4/5	130	177	05/06	>		S 1999 NR		
130E21	F4AE0681D	154	209	06/03	>	S 0620 R	S 2220 NR	S 7625 A	
dryer filter / filtro essiccatore	F4AE0681D	154	209	06/03	>				S 7259 A
prefilter / prefiltrato	F4AE0681D	154	209	06/03	>		S 0999 NR		
dusty areas / zone polverose	F4AE0681D	154	209	06/03	>	S 0620 R	S 2220 NR	S 7627 A	
130E24	F4AE0681B	176	239	06/03	>	S 0620 R	S 2220 NR	S 7626 A	
dryer filter / filtro essiccatore	F4AE0681B	176	239	06/03	>				S 7259 A
prefilter / prefiltrato	F4AE0681B	176	239	06/03	>		S 0999 NR		
130E25	F4AE3681DP Euro4/5	185	251	05/06	>	S 0620 R	S 2220 NR		
with filter Urea/Adblue / con filtro Urea/Adblue	F4AE3681DP Euro4/5	185	251	05/06	>				S 4401 U
dryer filter / filtro essiccatore	F4AE3681DP Euro4/5	185	251	05/06	>				S 7259 A
prefilter / prefiltrato	F4AE3681DP Euro4/5	185	251	05/06	>		S 1999 NR		
130E28	F4AE0681A	202	275	06/03	>	S 0620 R	S 2220 NR	S 7626 A	
dryer filter / filtro essiccatore	F4AE0681A	202	275	06/03	>				S 7259 A
prefilter / prefiltrato	F4AE0681A	202	275	06/03	>		S 0999 NR		
140E18	F4AE3481BP Euro4/5	130	177	05/06	>	S 0620 R	S 2220 NR		
with filter Urea/Adblue / con filtro Urea/Adblue	F4AE3481BP Euro4/5	130	177	05/06	>				S 4401 U
dryer filter / filtro essiccatore	F4AE3481BP Euro4/5	130	177	05/06	>				S 7259 A
prefilter / prefiltrato	F4AE3481BP Euro4/5	130	177	05/06	>		S 1999 NR		
140E22	F4AE3681BP Euro4/5	160	217	05/06	>	S 0620 R	S 2220 NR		
with filter Urea/Adblue / con filtro Urea/Adblue	F4AE3681BP Euro4/5	160	217	05/06	>				S 4401 U
dryer filter / filtro essiccatore	F4AE3681BP Euro4/5	160	217	05/06	>				S 7259 A
prefilter / prefiltrato	F4AE3681BP Euro4/5	160	217	05/06	>		S 1999 NR		
140E24	F4AE0681B	176	239	06/03	>	S 0620 R	S 2220 NR		
dryer filter / filtro essiccatore	F4AE0681B	176	239	06/03	>				S 7259 A
prefilter / prefiltrato	F4AE0681B	176	239	06/03	>		S 0999 NR		
dusty areas / zone polverose	F4AE0681B	176	239	06/03	>	S 0620 R	S 2220 NR	S 7627 A	
140E25	F4AE3681DP Euro4/5	185	251	05/06	>	S 0620 R	S 2220 NR		
with filter Urea/Adblue / con filtro Urea/Adblue	F4AE3681DP Euro4/5	185	251	05/06	>				S 4401 U
dryer filter / filtro essiccatore	F4AE3681DP Euro4/5	185	251	05/06	>				S 7259 A
prefilter / prefiltrato	F4AE3681DP Euro4/5	185	251	05/06	>		S 1999 NR		
140E25W 4x4	F4AE3681DP Euro4/5	185	251	05/06	>	S 0620 R	S 2220 NR		
with filter Urea/Adblue / con filtro Urea/Adblue	F4AE3681DP Euro4/5	185	251	05/06	>				S 4401 U
dryer filter / filtro essiccatore	F4AE3681DP Euro4/5	185	251	05/06	>				S 7259 A
prefilter / prefiltrato	F4AE3681DP Euro4/5	185	251	05/06	>		S 1999 NR		
140E28	F4AE3681EP Euro4/5	205	279	05/06	>	S 0620 R	S 2220 NR		
with filter Urea/Adblue / con filtro Urea/Adblue	F4AE3681EP Euro4/5	205	279	05/06	>				S 4401 U
dryer filter / filtro essiccatore	F4AE3681EP Euro4/5	205	279	05/06	>				S 7259 A
prefilter / prefiltrato	F4AE3681EP Euro4/5	205	279	05/06	>		S 1999 NR		
140E28W 4x4	F4AE3681EP Euro4/5	205	279	05/06	>	S 0620 R	S 2220 NR		
with filter Urea/Adblue / con filtro Urea/Adblue	F4AE3681EP Euro4/5	205	279	05/06	>				S 4401 U
dryer filter / filtro essiccatore	F4AE3681EP Euro4/5	205	279	05/06	>				S 7259 A

**kW HP****...IVECO - trucks/autocarri**

prefilter / prefiltrato	F4AE3481BP Euro4/5	130	177	05/06	>		S 1999 NR		
80E21	F4AE0681D	154	209	06/03	>	S 0620 R	S 2220 NR	S 7625 A	
dryer filter / filtro essiccatore	F4AE0681D	154	209	06/03	>				S 7259 A
prefilter / prefiltrato	F4AE0681D	154	209	06/03	>		S 0999 NR		
80E22	F4AE3681BP Euro4/5	160	217	05/06	>	S 0620 R	S 2220 NR		
with filter Urea/Adblue / con filtro Urea/Adblue	F4AE3681BP Euro4/5	160	217	05/06	>				S 4401 U
dryer filter / filtro essiccatore	F4AE3681BP Euro4/5	160	217	05/06	>				S 7259 A
prefilter / prefiltrato	F4AE3681BP Euro4/5	160	217	05/06	>		S 1999 NR		
80EL15	F4AE0481C	110	150	06/03	>	S 0620 R	S 2220 NR	S 7625 A	
dryer filter / filtro essiccatore	F4AE0481C	110	150	06/03	>				S 7259 A
prefilter / prefiltrato	F4AE0481C	110	150	06/03	>		S 0999 NR		
80EL17	F4AE0481A	125	170	06/03	>	S 0620 R	S 2220 NR	S 7625 A	
dryer filter / filtro essiccatore	F4AE0481A	125	170	06/03	>				S 7259 A
prefilter / prefiltrato	F4AE0481A	125	170	06/03	>		S 0999 NR		
90E17	F4AE0481A	125	170	06/03	>	S 0620 R	S 2220 NR	S 7625 A	
dryer filter / filtro essiccatore	F4AE0481A	125	170	06/03	>				S 7259 A
prefilter / prefiltrato	F4AE0481A	125	170	06/03	>		S 0999 NR		
90E18	F4AE0681E	134	182	06/03	>	S 0620 R	S 2220 NR	S 7625 A	
dryer filter / filtro essiccatore	F4AE0681E	134	182	06/03	>				S 7259 A
prefilter / prefiltrato	F4AE0681E	134	182	06/03	>		S 0999 NR		
90E18	F4AE3481BP Euro4/5	130	177	05/06	>	S 0620 R	S 2220 NR		
with filter Urea/Adblue / con filtro Urea/Adblue	F4AE3481BP Euro4/5	130	177	05/06	>				S 4401 U
dryer filter / filtro essiccatore	F4AE3481BP Euro4/5	130	177	05/06	>				S 7259 A
prefilter / prefiltrato	F4AE3481BP Euro4/5	130	177	05/06	>		S 1999 NR		
90E21	F4AE0681D	154	209	06/03	>	S 0620 R	S 2220 NR	S 7625 A	
dryer filter / filtro essiccatore	F4AE0681D	154	209	06/03	>				S 7259 A
prefilter / prefiltrato	F4AE0681D	154	209	06/03	>		S 0999 NR		
90E22	F4AE3681BP Euro4/5	160	217	05/06	>	S 0620 R	S 2220 NR		
with filter Urea/Adblue / con filtro Urea/Adblue	F4AE3681BP Euro4/5	160	217	05/06	>				S 4401 U
dryer filter / filtro essiccatore	F4AE3681BP Euro4/5	160	217	05/06	>				S 7259 A
prefilter / prefiltrato	F4AE3681BP Euro4/5	160	217	05/06	>		S 1999 NR		
Eurocargo Tector III									
ML100E18	F4AE3481AS Euro5	132	180	06/08	>	S 0620 R	S 2220 NR		
with filter Urea/Adblue SCR Denoxtronic 1 / con filtro Urea/Adblue SCR Denoxtronic 1	F4AE3481AS Euro5	132	180	06/08	>				S 4401 U
with filter Urea/Adblue SCR Denoxtronic 2 / con filtro Urea/Adblue SCR Denoxtronic 2	F4AE3481AS Euro5	132	180	06/08	>				S 4402 U
dryer filter / filtro essiccatore	F4AE3481AS Euro5	132	180	06/08	>				S 7259 A
prefilter / prefiltrato	F4AE3481AS Euro5	132	180	06/08	>		S 1999 NR		
prefilter Urea/Adblue SCR Denoxtronic 2 / prefiltrato Urea/Adblue SCR Denoxtronic 2	F4AE3481AS Euro5	132	180	06/08	>				S 4406 U
ML100E22	F4AE3681BS Euro5	162	220	06/08	>	S 0620 R	S 2220 NR		
with filter Urea/Adblue SCR Denoxtronic 1 / con filtro Urea/Adblue SCR Denoxtronic 1	F4AE3681BS Euro5	162	220	06/08	>				S 4401 U
with filter Urea/Adblue SCR Denoxtronic 2 / con filtro Urea/Adblue SCR Denoxtronic 2	F4AE3681BS Euro5	162	220	06/08	>				S 4402 U
dryer filter / filtro essiccatore	F4AE3681BS Euro5	162	220	06/08	>				S 7259 A
prefilter / prefiltrato	F4AE3681BS Euro5	162	220	06/08	>		S 1999 NR		
prefilter Urea/Adblue SCR Denoxtronic 2 / prefiltrato Urea/Adblue SCR Denoxtronic 2	F4AE3681BS Euro5	162	220	06/08	>				S 4406 U
ML110EL18	F4AE3481AS Euro5	132	180	06/08	>	S 0620 R	S 2220 NR		
with filter Urea/Adblue SCR Denoxtronic 1 / con filtro Urea/Adblue SCR Denoxtronic 1	F4AE3481AS Euro5	132	180	06/08	>				S 4401 U
with filter Urea/Adblue SCR Denoxtronic 2 / con filtro Urea/Adblue SCR Denoxtronic 2	F4AE3481AS Euro5	132	180	06/08	>				S 4402 U
dryer filter / filtro essiccatore	F4AE3481AS Euro5	132	180	06/08	>				S 7259 A
prefilter / prefiltrato	F4AE3481AS Euro5	132	180	06/08	>		S 1999 NR		
prefilter Urea/Adblue SCR Denoxtronic 2 / prefiltrato Urea/Adblue SCR Denoxtronic 2	F4AE3481AS Euro5	132	180	06/08	>				S 4406 U
ML110EL22	F4AE3681BS Euro5	162	220	06/08	>	S 0620 R	S 2220 NR		
with filter Urea/Adblue SCR Denoxtronic 1 / con filtro Urea/Adblue SCR Denoxtronic 1	F4AE3681BS Euro5	162	220	06/08	>				S 4401 U
with filter Urea/Adblue SCR Denoxtronic 2 / con filtro Urea/Adblue SCR Denoxtronic 2	F4AE3681BS Euro5	162	220	06/08	>				S 4402 U
dryer filter / filtro essiccatore	F4AE3681BS Euro5	162	220	06/08	>				S 7259 A
prefilter / prefiltrato	F4AE3681BS Euro5	162	220	06/08	>		S 1999 NR		
prefilter Urea/Adblue SCR Denoxtronic 2 / prefiltrato Urea/Adblue SCR Denoxtronic 2	F4AE3681BS Euro5	162	220	06/08	>				S 4406 U
ML180E28	F4AE3681ES Euro5	206	280	06/08	>	S 0620 R	S 2220 NR		
with filter Urea/Adblue SCR Denoxtronic 1 / con filtro Urea/Adblue SCR Denoxtronic 1	F4AE3681ES Euro5	206	280	06/08	>				S 4401 U
with filter Urea/Adblue SCR Denoxtronic 2 / con filtro Urea/Adblue SCR Denoxtronic 2	F4AE3681ES Euro5	206	280	06/08	>				S 4402 U
dryer filter / filtro essiccatore	F4AE3681ES Euro5	206	280	06/08	>				S 7259 A
prefilter / prefiltrato	F4AE3681ES Euro5	206	280	06/08	>		S 1999 NR		
prefilter Urea/Adblue SCR Denoxtronic 2 / prefiltrato Urea/Adblue SCR Denoxtronic 2	F4AE3681ES Euro5	206	280	06/08	>				S 4406 U
Eurofire I									
130E24	8060.45M	179	240	01/91	> 04/01	S 5003 DR	S 4329 NR	S 7187 A	
some / alcuni	8060.45M	179	240	01/91	> 04/01	S 5003 DR	S 4329 NR	S 2650 A	
dryer filter / filtro essiccatore	8060.45M	179	240	01/91	> 04/01				S 7259 A
prefilter / prefiltrato	8060.45M	179	240	01/91	> 04/01		S 0999 NR		

**KW HP****...IVECO - trucks/autocarri**

power steering / servosterzo	8060.45M	179	240	01/91	>	04/01				S 3081 PO
130E24	8060.45S	179	240	01/91	>	04/01	S 5003 DR	S 4329 NR	S 2650 A	
dryer filter / filtro essiccatore	8060.45S	179	240	01/91	>	04/01				S 7259 A
prefilter / prefiltrro	8060.45S	179	240	01/91	>	04/01		S 0999 NR		
power steering / servosterzo	8060.45S	179	240	01/91	>	04/01				S 3081 PO
135E22W	8060.45L	179	240	01/91	>	04/01	S 3003 DR	S 8500 NR	S 2650 A	
dryer filter / filtro essiccatore	8060.45L	179	240	01/91	>	04/01				S 7259 A
prefilter / prefiltrro	8060.45L	179	240	01/91	>	04/01		S 0999 NR		
power steering / servosterzo	8060.45L	179	240	01/91	>	04/01				S 3081 PO
135E24W	8060.45M	179	240	01/91	>	04/01	S 5003 DR	S 4329 NR	S 2650 A	
dryer filter / filtro essiccatore	8060.45M	179	240	01/91	>	04/01				S 7259 A
prefilter / prefiltrro	8060.45M	179	240	01/91	>	04/01		S 0999 NR		
power steering / servosterzo	8060.45M	179	240	01/91	>	04/01				S 3081 PO
150E27	8360.46	196	267	01/91	>	04/01	S 5003 DR	S 4329 NR	S 7187 A	
some / alcuni	8360.46	196	267	01/91	>	04/01	S 5003 DR	S 4329 NR	S 2650 A	
dryer filter / filtro essiccatore	8360.46	196	267	01/91	>	04/01				S 7259 A
prefilter / prefiltrro	8360.46	196	267	01/91	>	04/01		S 0999 NR		
power steering / servosterzo	8360.46	196	267	01/91	>	04/01				S 3081 PO
150E27	8360.46 E2	196	267	01/91	>	04/01	S 5003 DR	S 4329 NR	S 7187 A	
some / alcuni	8360.46 E2	196	267	01/91	>	04/01	S 5003 DR	S 4329 NR	S 2650 A	
dryer filter / filtro essiccatore	8360.46 E2	196	267	01/91	>	04/01				S 7259 A
prefilter / prefiltrro	8360.46 E2	196	267	01/91	>	04/01		S 0999 NR		
power steering / servosterzo	8360.46 E2	196	267	01/91	>	04/01				S 3081 PO
75E14	8040.45, 8040.45 E2	100	136	01/91	>	04/01	S 3003 DR	S 8500 NR	S 2650 A	
dryer filter / filtro essiccatore	8040.45, 8040.45 E2	100	136	01/91	>	04/01				S 7259 A
prefilter / prefiltrro	8040.45, 8040.45 E2	100	136	01/91	>	04/01		S 0999 NR		
power steering / servosterzo	8040.45, 8040.45 E2	100	136	01/91	>	04/01				S 3081 PO
95E18W	8060.45B	130	177	01/91	>	04/01	S 3003 DR	S 8500 NR	S 2650 A	
dryer filter / filtro essiccatore	8060.45B	130	177	01/91	>	04/01				S 7259 A
prefilter / prefiltrro	8060.45B	130	177	01/91	>	04/01		S 0999 NR		
power steering / servosterzo	8060.45B	130	177	01/91	>	04/01				S 3081 PO
95E18W	8060.45B E1	130	177	01/91	>	04/01	S 3003 DR	S 8500 NR	S 2450 A	
some / alcuni	8060.45B E1	130	177	01/91	>	04/01	S 3003 DR	S 8500 NR	S 2650 A	
dryer filter / filtro essiccatore	8060.45B E1	130	177	01/91	>	04/01				S 7259 A
prefilter / prefiltrro	8060.45B E1	130	177	01/91	>	04/01		S 0999 NR		
power steering / servosterzo	8060.45B E1	130	177	01/91	>	04/01				S 3081 PO
95E18W	8060.45B E2	130	177	01/91	>	04/01	S 3003 DR	S 8500 NR	S 2450 A	
dryer filter / filtro essiccatore	8060.45B E2	130	177	01/91	>	04/01				S 7259 A
prefilter / prefiltrro	8060.45B E2	130	177	01/91	>	04/01		S 0999 NR		
power steering / servosterzo	8060.45B E2	130	177	01/91	>	04/01				S 3081 PO

Eurofire Tector I

100E21	F4AE0681D	154	209	09/00	>		S 0620 R	S 2220 NR	S 7625 A	
dryer filter / filtro essiccatore	F4AE0681D	154	209	09/00	>					S 7259 A
prefilter / prefiltrro	F4AE0681D	154	209	09/00	>			S 0999 NR		
dusty areas / zone polverose	F4AE0681D	154	209	09/00	>		S 0620 R	S 2220 NR	S 7627 A	
130E24	F4AE0681B	176	239	09/00	>		S 0620 R	S 2220 NR	S 7626 A	
dryer filter / filtro essiccatore	F4AE0681B	176	239	09/00	>					S 7259 A
prefilter / prefiltrro	F4AE0681B	176	239	09/00	>			S 0999 NR		
140E24	F4AE0681B	176	239	09/00	>		S 0620 R	S 2220 NR	S 2650 A	
dryer filter / filtro essiccatore	F4AE0681B	176	239	09/00	>					S 7259 A
prefilter / prefiltrro	F4AE0681B	176	239	09/00	>			S 0999 NR		
dusty areas / zone polverose	F4AE0681B	176	239	09/00	>		S 0620 R	S 2220 NR	S 7627 A	
140E28	F4AE0681A	202	275	09/00	>		S 0620 R	S 2220 NR	S 7627 A	
dryer filter / filtro essiccatore	F4AE0681A	202	275	09/00	>					S 7259 A
prefilter / prefiltrro	F4AE0681A	202	275	09/00	>			S 0999 NR		
150E24	F4AE0681B	176	239	09/00	>		S 0620 R	S 2220 NR	S 7626 A	
dryer filter / filtro essiccatore	F4AE0681B	176	239	09/00	>					S 7259 A
prefilter / prefiltrro	F4AE0681B	176	239	09/00	>			S 0999 NR		
150E28	F4AE0681A	202	275	09/00	>		S 0620 R	S 2220 NR	S 7626 A	
dryer filter / filtro essiccatore	F4AE0681A	202	275	09/00	>					S 7259 A
prefilter / prefiltrro	F4AE0681A	202	275	09/00	>			S 0999 NR		

Euromover

190E24 Cursor 8	F2BE0681D	180	245	08/00	>	03/06	S 3288 R	S 4396 NR	S 7546 A	S 3055 C
some BLOW-BY filter (504153481) / alcuni filtro BLOW-BY (504153481)	F2BE0681D	180	245	08/00	>	03/06				S 7266 A
dryer filter / filtro essiccatore	F2BE0681D	180	245	08/00	>	03/06				S 7259 A
VGT filter / filtro VGT	F2BE0681D	180	245	08/00	>	03/06				S 0VGT A
prefilter / prefiltrro	F2BE0681D	180	245	08/00	>	03/06		S 0999 NR		



...IVECO - trucks/autocarri

power steering / servosterzo	F2BE0681D	180	245	08/00	>	03/06				S 8790 PO
260E24 Cursor 8	F2BE0681D	180	245	08/00	>	03/06	S 3288 R	S 4396 NR	S 7546 A	S 3055 C
some BLOW-BY filter (504153481) / alcuni filtro BLOW-BY (504153481)	F2BE0681D	180	245	08/00	>	03/06				S 7266 A
dryer filter / filtro essiccatore	F2BE0681D	180	245	08/00	>	03/06				S 7259 A
VGT filter / filtro VGT	F2BE0681D	180	245	08/00	>	03/06				S 0VGT A
prefilter / prefiltra	F2BE0681D	180	245	08/00	>	03/06		S 0999 NR		
power steering / servosterzo	F2BE0681D	180	245	08/00	>	03/06				S 8790 PO
Eurostar										
180E38	8460.41N	276	375	06/92	>	02/02	S 5003 DR	S 4329 NR	S 7546 A	S 3055 C
water filter / filtro acqua	8460.41N	276	375	06/92	>	02/02				S 8410 AR
dryer filter / filtro essiccatore	8460.41N	276	375	06/92	>	02/02				S 7259 A
prefilter / prefiltra	8460.41N	276	375	06/92	>	02/02		S 0999 NR		
power steering / servosterzo	8460.41N	276	375	06/92	>	02/02				S 3081 PO
180E42	8210.42L	309	420	04/92	>	02/02	S 5003 DR	S 4329 NR	S 7546 A	S 3055 C
water filter / filtro acqua	8210.42L	309	420	04/92	>	02/02				S 8410 AR
dryer filter / filtro essiccatore	8210.42L	309	420	04/92	>	02/02				S 7259 A
prefilter / prefiltra	8210.42L	309	420	04/92	>	02/02		S 0999 NR		
power steering / servosterzo	8210.42L	309	420	04/92	>	02/02				S 3081 PO
190E38	8460.41L	276	375	06/92	>	02/02				S 2234 Z
with automatic gearbox and hydraulic retarder ZF / con cambio automatico e rallentatore idraulico ZF	8460.41L	276	375	06/92	>	02/02				S 8410 AR
water filter / filtro acqua	8460.41L	276	375	06/92	>	02/02				S 7259 A
dryer filter / filtro essiccatore	8460.41L	276	375	06/92	>	02/02	S 5003 DR	S 5401 NR	S 7546 A	S 3055 C
assembly BOSCH / montaggio BOSCH	8460.41L	276	375	06/92	>	02/02	S 5003 DR	S 4329 NR	S 7546 A	S 3055 C
assembly UFI / montaggio UFI	8460.41L	276	375	06/92	>	02/02	S 5003 DR	S 5400 NR	S 7546 A	S 3055 C
or / oppure	8460.41L	276	375	06/92	>	02/02		S 0999 NR		
prefilter / prefiltra	8460.41L	276	375	06/92	>	02/02				S 3081 PO
power steering / servosterzo	8460.41L	276	375	06/92	>	02/02				S 3055 C
190E38	8460.41N	276	375	06/92	>	02/02	S 5003 DR	S 4329 NR	S 7546 A	S 2234 Z
with automatic gearbox and hydraulic retarder ZF / con cambio automatico e rallentatore idraulico ZF	8460.41N	276	375	06/92	>	02/02				S 8410 AR
water filter / filtro acqua	8460.41N	276	375	06/92	>	02/02				S 7259 A
dryer filter / filtro essiccatore	8460.41N	276	375	06/92	>	02/02				S 3081 PO
prefilter / prefiltra	8460.41N	276	375	06/92	>	02/02		S 0999 NR		
power steering / servosterzo	8460.41N	276	375	06/92	>	02/02				S 3055 C
190E39 Cursor 10	F3AE0681E	286	390	01/99	>	02/02		S 4395 NR	S 7544 A	S 2234 Z
with automatic gearbox and hydraulic retarder ZF / con cambio automatico e rallentatore idraulico ZF	F3AE0681E	286	390	01/99	>	02/02				S 7259 A
dryer filter / filtro essiccatore	F3AE0681E	286	390	01/99	>	02/02				S 0VGT A
VGT filter / filtro VGT	F3AE0681E	286	390	01/99	>	02/02				
2 filters / N.2 filtri	F3AE0681E	286	390	01/99	>	02/02	S 3288 R			
prefilter / prefiltra	F3AE0681E	286	390	01/99	>	02/02		S 0999 NR		
power steering / servosterzo	F3AE0681E	286	390	01/99	>	02/02				S 3081 PO
190E42	8210.42L, 8210.42L E2	309	420	04/92	>	02/02	S 5003 DR	S 4329 NR	S 7546 A	S 3055 C
dryer filter / filtro essiccatore	8210.42L, 8210.42L E2	309	420	04/92	>	02/02				S 7259 A
prefilter / prefiltra	8210.42L, 8210.42L E2	309	420	04/92	>	02/02		S 0999 NR		
power steering / servosterzo	8210.42L, 8210.42L E2	309	420	04/92	>	02/02				S 3081 PO
190E43 Cursor 10	F3AE0681D	315	430	01/99	>	02/02		S 4395 NR	S 7544 A	S 3055 C
dryer filter / filtro essiccatore	F3AE0681D	315	430	01/99	>	02/02				S 7259 A
VGT filter / filtro VGT	F3AE0681D	315	430	01/99	>	02/02				S 0VGT A
2 filters / N.2 filtri	F3AE0681D	315	430	01/99	>	02/02	S 3288 R			
prefilter / prefiltra	F3AE0681D	315	430	01/99	>	02/02		S 0999 NR		
power steering / servosterzo	F3AE0681D	315	430	01/99	>	02/02				S 3081 PO
190E47	8210.42M	345	469	04/92	>	02/02	S 5003 DR	S 4329 NR	S 7544 A	S 3055 C
with automatic gearbox and hydraulic retarder ZF / con cambio automatico e rallentatore idraulico ZF	8210.42M	345	469	04/92	>	02/02				S 2234 Z
dryer filter / filtro essiccatore	8210.42M	345	469	04/92	>	02/02				S 7259 A
prefilter / prefiltra	8210.42M	345	469	04/92	>	02/02		S 0999 NR		
power steering / servosterzo	8210.42M	345	469	04/92	>	02/02				S 3081 PO
190E52	8280.42S	378	514	04/92	>	02/02	S 2003 DR	S 4329 NR	S 7544 A	S 3055 C
dryer filter / filtro essiccatore	8280.42S	378	514	04/92	>	02/02				S 7259 A
prefilter / prefiltra	8280.42S	378	514	04/92	>	02/02		S 0999 NR		
power steering / servosterzo	8280.42S	378	514	04/92	>	02/02				S 3081 PO
240E38	8460.41L	276	375	06/92	>	02/02				S 2234 Z
with automatic gearbox and hydraulic retarder ZF / con cambio automatico e rallentatore idraulico ZF	8460.41L	276	375	06/92	>	02/02				S 8410 AR
water filter / filtro acqua	8460.41L	276	375	06/92	>	02/02				S 7259 A
dryer filter / filtro essiccatore	8460.41L	276	375	06/92	>	02/02				S 3055 C
assembly BOSCH / montaggio BOSCH	8460.41L	276	375	06/92	>	02/02	S 5003 DR	S 5401 NR	S 7546 A	S 3055 C
assembly UFI / montaggio UFI	8460.41L	276	375	06/92	>	02/02	S 5003 DR	S 4329 NR	S 7546 A	S 3055 C
or / oppure	8460.41L	276	375	06/92	>	02/02	S 5003 DR	S 5400 NR	S 7546 A	S 3055 C
prefilter / prefiltra	8460.41L	276	375	06/92	>	02/02		S 0999 NR		



...IVECO - trucks/autocarri

power steering / servosterzo	8460.41L	276	375	06/92	>	02/02				S 3081 PO
240E38	8460.41N	276	375	06/92	>	02/02	S 5003 DR	S 4329 NR	S 7546 A	S 3055 C
with automatic gearbox and hydraulic retarder ZF / con cambio automatico e rallentatore idraulico ZF	8460.41N	276	375	06/92	>	02/02				S 2234 Z
water filter / filtro acqua	8460.41N	276	375	06/92	>	02/02				S 8410 AR
dryer filter / filtro essiccatore	8460.41N	276	375	06/92	>	02/02				S 7259 A
prefilter / prefiltrato	8460.41N	276	375	06/92	>	02/02		S 0999 NR		
power steering / servosterzo	8460.41N	276	375	06/92	>	02/02				S 3081 PO
240E42	8210.42L, 8210.42L E2	309	420	04/92	>	02/02	S 5003 DR	S 4329 NR	S 7546 A	S 3055 C
with automatic gearbox and hydraulic retarder ZF / con cambio automatico e rallentatore idraulico ZF	8210.42L, 8210.42L E2	309	420	04/92	>	02/02				S 2234 Z
dryer filter / filtro essiccatore	8210.42L, 8210.42L E2	309	420	04/92	>	02/02				S 7259 A
prefilter / prefiltrato	8210.42L, 8210.42L E2	309	420	04/92	>	02/02		S 0999 NR		
power steering / servosterzo	8210.42L, 8210.42L E2	309	420	04/92	>	02/02				S 3081 PO
240E47	8210.42M	345	470	11/95	>	02/02	S 5003 DR	S 4329 NR	S 7546 A	S 3055 C
some / alcuni	8210.42M	345	470	11/95	>	02/02	S 5003 DR	S 4329 NR	S 7544 A	S 3055 C
dryer filter / filtro essiccatore	8210.42M	345	470	11/95	>	02/02				S 7259 A
prefilter / prefiltrato	8210.42M	345	470	11/95	>	02/02		S 0999 NR		
power steering / servosterzo	8210.42M	345	470	11/95	>	02/02				S 8790 PO
240E52	8280.42S	378	514	04/92	>	02/02	S 2003 DR	S 4329 NR	S 7544 A	S 3055 C
dryer filter / filtro essiccatore	8280.42S	378	514	04/92	>	02/02				S 7259 A
prefilter / prefiltrato	8280.42S	378	514	04/92	>	02/02		S 0999 NR		
power steering / servosterzo	8280.42S	378	514	04/92	>	02/02				S 3081 PO
260E39 Cursor 10	F3AE0681	286	390	01/99	>	02/02		S 4395 NR	S 7544 A	S 3055 C
with automatic gearbox and hydraulic retarder ZF / con cambio automatico e rallentatore idraulico ZF	F3AE0681	286	390	01/99	>	02/02				S 2234 Z
dryer filter / filtro essiccatore	F3AE0681	286	390	01/99	>	02/02				S 7259 A
VGT filter / filtro VGT	F3AE0681	286	390	01/99	>	02/02				S 0VGT A
2 filters / N.2 filtri	F3AE0681	286	390	01/99	>	02/02	S 3288 R			
prefilter / prefiltrato	F3AE0681	286	390	01/99	>	02/02		S 0999 NR		
power steering / servosterzo	F3AE0681	286	390	01/99	>	02/02				S 8790 PO
power steering / servosterzo	F3AE0681	286	390	01/99	>	02/02				S 3081 PO
260E42	8210.42L E2	309	420	06/92	>	02/02	S 5003 DR	S 4329 NR	S 7546 A	S 3055 C
with automatic gearbox and hydraulic retarder ZF / con cambio automatico e rallentatore idraulico ZF	8210.42L E2	309	420	06/92	>	02/02				S 2234 Z
dryer filter / filtro essiccatore	8210.42L E2	309	420	06/92	>	02/02				S 7259 A
prefilter / prefiltrato	8210.42L E2	309	420	06/92	>	02/02		S 0999 NR		
power steering / servosterzo	8210.42L E2	309	420	06/92	>	02/02				S 3081 PO
260E43 Cursor 10	F3AE0681D	315	430	01/99	>	02/02		S 4395 NR	S 7544 A	S 3055 C
dryer filter / filtro essiccatore	F3AE0681D	315	430	01/99	>	02/02				S 7259 A
VGT filter / filtro VGT	F3AE0681D	315	430	01/99	>	02/02				S 0VGT A
2 filters / N.2 filtri	F3AE0681D	315	430	01/99	>	02/02	S 3288 R			
prefilter / prefiltrato	F3AE0681D	315	430	01/99	>	02/02		S 0999 NR		
power steering / servosterzo	F3AE0681D	315	430	01/99	>	02/02				S 3081 PO
260E47	8210.42M	345	470	06/92	>	02/02	S 5003 DR	S 4329 NR	S 7544 A	S 3055 C
with automatic gearbox and hydraulic retarder ZF / con cambio automatico e rallentatore idraulico ZF	8210.42M	345	470	06/92	>	02/02				S 2234 Z
dryer filter / filtro essiccatore	8210.42M	345	470	06/92	>	02/02				S 7259 A
prefilter / prefiltrato	8210.42M	345	470	06/92	>	02/02		S 0999 NR		
power steering / servosterzo	8210.42M	345	470	06/92	>	02/02				S 3081 PO
260E48 Cursor 13	F3AE0681, F3BE0681	353	480	01/01	>	02/02		S 4395 NR	S 7544 A	S 3055 C
dryer filter / filtro essiccatore	F3AE0681, F3BE0681	353	480	01/01	>	02/02				S 7259 A
VGT filter / filtro VGT	F3AE0681, F3BE0681	353	480	01/01	>	02/02				S 0VGT A
2 filters / N.2 filtri	F3AE0681, F3BE0681	353	480	01/01	>	02/02	S 3288 R			
prefilter / prefiltrato	F3AE0681, F3BE0681	353	480	01/01	>	02/02		S 0999 NR		
power steering / servosterzo	F3AE0681, F3BE0681	353	480	01/01	>	02/02				S 3081 PO
power steering / servosterzo	F3AE0681, F3BE0681	353	480	01/01	>	02/02				S 8790 PO
260E52	8280.42S	378	514	04/92	>	02/02	S 2003 DR	S 4329 NR	S 7544 A	S 3055 C
with automatic gearbox and hydraulic retarder ZF / con cambio automatico e rallentatore idraulico ZF	8280.42S	378	514	04/92	>	02/02				S 2234 Z
dryer filter / filtro essiccatore	8280.42S	378	514	04/92	>	02/02				S 7259 A
prefilter / prefiltrato	8280.42S	378	514	04/92	>	02/02		S 0999 NR		
power steering / servosterzo	8280.42S	378	514	04/92	>	02/02				S 3081 PO
400E38	8460.41L	276	375	09/92	>	02/02				S 2234 Z
with automatic gearbox and hydraulic retarder ZF / con cambio automatico e rallentatore idraulico ZF	8460.41L	276	375	09/92	>	02/02				S 8410 AR
water filter / filtro acqua	8460.41L	276	375	09/92	>	02/02				S 7259 A
dryer filter / filtro essiccatore	8460.41L	276	375	09/92	>	02/02				S 7259 A
assembly BOSCH / montaggio BOSCH	8460.41L	276	375	09/92	>	02/02	S 5003 DR	S 5401 NR	S 7546 A	S 3055 C
assembly UFI / montaggio UFI	8460.41L	276	375	09/92	>	02/02	S 5003 DR	S 4329 NR	S 7546 A	S 3055 C
or / oppure	8460.41L	276	375	09/92	>	02/02	S 5003 DR	S 5400 NR	S 7546 A	S 3055 C
prefilter / prefiltrato	8460.41L	276	375	09/92	>	02/02		S 0999 NR		
power steering / servosterzo	8460.41L	276	375	09/92	>	02/02				S 3081 PO
400E38	8460.41N	276	375	09/92	>	02/02	S 5003 DR	S 4329 NR	S 7546 A	S 3055 C

**KW HP****...IVECO - trucks/autocarri**

with automatic gearbox and hydraulic retarder ZF / con cambio automatico e rallentatore idraulico ZF	8460.41N	276	375	09/92	>	02/02				S 2234 Z
water filter / filtro acqua	8460.41N	276	375	09/92	>	02/02				S 8410 AR
dryer filter / filtro essiccatore	8460.41N	276	375	09/92	>	02/02				S 7259 A
prefilter / prefiltra	8460.41N	276	375	09/92	>	02/02		S 0999 NR		
power steering / servosterzo	8460.41N	276	375	09/92	>	02/02				S 3081 PO
440E42	8210.42L, 8210.42L E2	309	420	04/92	>	02/02	S 5003 DR	S 4329 NR	S 7546 A	S 3055 C
with automatic gearbox and hydraulic retarder ZF / con cambio automatico e rallentatore idraulico ZF	8210.42L, 8210.42L E2	309	420	04/92	>	02/02				S 2234 Z
dryer filter / filtro essiccatore	8210.42L, 8210.42L E2	309	420	04/92	>	02/02				S 7259 A
prefilter / prefiltra	8210.42L, 8210.42L E2	309	420	04/92	>	02/02		S 0999 NR		
power steering / servosterzo	8210.42L, 8210.42L E2	309	420	04/92	>	02/02				S 3081 PO
440E47	8210.42M	345	469	04/92	>	02/02	S 5003 DR	S 4329 NR	S 7544 A	S 3055 C
with automatic gearbox and hydraulic retarder ZF / con cambio automatico e rallentatore idraulico ZF	8210.42M	345	469	04/92	>	02/02				S 2234 Z
dryer filter / filtro essiccatore	8210.42M	345	469	04/92	>	02/02				S 7259 A
prefilter / prefiltra	8210.42M	345	469	04/92	>	02/02		S 0999 NR		
power steering / servosterzo	8210.42M	345	469	04/92	>	02/02				S 3081 PO
440E52	8280.42S	378	514	04/92	>	02/02	S 2003 DR	S 4329 NR	S 7544 A	S 3055 C
with automatic gearbox and hydraulic retarder ZF / con cambio automatico e rallentatore idraulico ZF	8280.42S	378	514	04/92	>	02/02				S 2234 Z
dryer filter / filtro essiccatore	8280.42S	378	514	04/92	>	02/02				S 7259 A
prefilter / prefiltra	8280.42S	378	514	04/92	>	02/02		S 0999 NR		
power steering / servosterzo	8280.42S	378	514	04/92	>	02/02				S 3081 PO
440E38	8460.41L	276	375	04/93	>	02/02				S 2234 Z
with automatic gearbox and hydraulic retarder ZF / con cambio automatico e rallentatore idraulico ZF	8460.41L	276	375	04/93	>	02/02				S 8410 AR
water filter / filtro acqua	8460.41L	276	375	04/93	>	02/02				S 7259 A
dryer filter / filtro essiccatore	8460.41L	276	375	04/93	>	02/02	S 5003 DR	S 5401 NR	S 7546 A	S 3055 C
assembly BOSCH / montaggio BOSCH	8460.41L	276	375	04/93	>	02/02	S 5003 DR	S 4329 NR	S 7546 A	S 3055 C
assembly UFI / montaggio UFI	8460.41L	276	375	04/93	>	02/02	S 5003 DR	S 5400 NR	S 7546 A	S 3055 C
or / oppure	8460.41L	276	375	04/93	>	02/02		S 0999 NR		
prefilter / prefiltra	8460.41L	276	375	04/93	>	02/02				S 3081 PO
power steering / servosterzo	8460.41L	276	375	04/93	>	02/02				S 3055 C
440E38	8460.41N	276	375	04/93	>	02/02	S 5003 DR	S 4329 NR	S 7546 A	S 2234 Z
with automatic gearbox and hydraulic retarder ZF / con cambio automatico e rallentatore idraulico ZF	8460.41N	276	375	04/93	>	02/02				S 8410 AR
water filter / filtro acqua	8460.41N	276	375	04/93	>	02/02				S 7259 A
dryer filter / filtro essiccatore	8460.41N	276	375	04/93	>	02/02		S 0999 NR		
prefilter / prefiltra	8460.41N	276	375	04/93	>	02/02				S 3081 PO
power steering / servosterzo	8460.41N	276	375	04/93	>	02/02				S 3055 C
440E39 Cursor 10	F3AE0681, F3AE0681E	286	390	01/99	>	02/02		S 4395 NR	S 7544 A	S 2234 Z
with automatic gearbox and hydraulic retarder ZF / con cambio automatico e rallentatore idraulico ZF	F3AE0681, F3AE0681E	286	390	01/99	>	02/02				S 8410 AR
dryer filter / filtro essiccatore	F3AE0681, F3AE0681E	286	390	01/99	>	02/02				S 7259 A
VGT filter / filtro VGT	F3AE0681, F3AE0681E	286	390	01/99	>	02/02				S 0VGT A
2 filters / N.2 filtri	F3AE0681, F3AE0681E	286	390	01/99	>	02/02	S 3288 R			
prefilter / prefiltra	F3AE0681, F3AE0681E	286	390	01/99	>	02/02		S 0999 NR		
power steering / servosterzo	F3AE0681, F3AE0681E	286	390	01/99	>	02/02				S 3081 PO
440E42	8210.42L, 8210.42L E2	309	420	04/92	>	02/02	S 5003 DR	S 4329 NR	S 7546 A	S 3055 C
with automatic gearbox and hydraulic retarder ZF / con cambio automatico e rallentatore idraulico ZF	8210.42L, 8210.42L E2	309	420	04/92	>	02/02				S 2234 Z
dryer filter / filtro essiccatore	8210.42L, 8210.42L E2	309	420	04/92	>	02/02				S 7259 A
prefilter / prefiltra	8210.42L, 8210.42L E2	309	420	04/92	>	02/02		S 0999 NR		
power steering / servosterzo	8210.42L, 8210.42L E2	309	420	04/92	>	02/02				S 3081 PO
440E43 Cursor 10	F3AE0681D	315	430	01/99	>	02/02		S 4395 NR	S 7544 A	S 3055 C
with automatic gearbox and hydraulic retarder ZF / con cambio automatico e rallentatore idraulico ZF	F3AE0681D	315	430	01/99	>	02/02				S 2234 Z
dryer filter / filtro essiccatore	F3AE0681D	315	430	01/99	>	02/02				S 7259 A
VGT filter / filtro VGT	F3AE0681D	315	430	01/99	>	02/02				S 0VGT A
2 filters / N.2 filtri	F3AE0681D	315	430	01/99	>	02/02	S 3288 R			
prefilter / prefiltra	F3AE0681D	315	430	01/99	>	02/02		S 0999 NR		
power steering / servosterzo	F3AE0681D	315	430	01/99	>	02/02				S 3081 PO
440E46 Cursor 13	F3BE0681	337	460	01/00	>	02/02		S 4395 NR	S 7544 A	S 3055 C
dryer filter / filtro essiccatore	F3BE0681	337	460	01/00	>	02/02				S 7259 A
VGT filter / filtro VGT	F3BE0681	337	460	01/00	>	02/02				S 0VGT A
2 filters / N.2 filtri	F3BE0681	337	460	01/00	>	02/02	S 3288 R			
prefilter / prefiltra	F3BE0681	337	460	01/00	>	02/02		S 0999 NR		
power steering / servosterzo	F3BE0681	337	460	01/00	>	02/02				S 3081 PO
440E47	8210.42M	345	470	04/92	>	02/02	S 5003 DR	S 4329 NR	S 7544 A	S 3055 C
with automatic gearbox and hydraulic retarder ZF / con cambio automatico e rallentatore idraulico ZF	8210.42M	345	470	04/92	>	02/02				S 2234 Z
dryer filter / filtro essiccatore	8210.42M	345	470	04/92	>	02/02				S 7259 A
prefilter / prefiltra	8210.42M	345	470	04/92	>	02/02		S 0999 NR		
power steering / servosterzo	8210.42M	345	470	04/92	>	02/02				S 3081 PO
440E52	8280.42S	378	514	04/92	>	02/02	S 2003 DR	S 4329 NR	S 7544 A	S 3055 C
with automatic gearbox and hydraulic retarder ZF / con cambio automatico e rallentatore idraulico ZF	8280.42S	378	514	04/92	>	02/02				S 2234 Z





...IVECO - trucks/autocarri

dryer filter / filtro essiccatore	8280.42S	378	514	04/92	>	02/02			S 0999 NR		S 7259 A
prefilter / prefiltrato	8280.42S	378	514	04/92	>	02/02					
power steering / servosterzo	8280.42S	378	514	04/92	>	02/02					S 3081 PO
Eurotech											
180E24	8360.46R	176	239	01/92	>	12/96	S 5003 DR	S 4329 NR	S 7546 A		S 3055 C
water filter / filtro acqua	8360.46R	176	239	01/92	>	12/96					S 8410 AR
dryer filter / filtro essiccatore	8360.46R	176	239	01/92	>	12/96					S 7259 A
prefilter / prefiltrato	8360.46R	176	239	01/92	>	12/96		S 0999 NR			
power steering / servosterzo	8360.46R	176	239	01/92	>	12/96					S 3081 PO
180E30											
water filter / filtro acqua	8460.41C, 8460TCA	221	300	07/92	>	06/02					S 8410 AR
dryer filter / filtro essiccatore	8460.41C, 8460TCA	221	300	07/92	>	06/02					S 7259 A
assembly BOSCH / montaggio BOSCH	8460.41C, 8460TCA	221	300	07/92	>	06/02	S 5003 DR	S 5401 NR	S 7546 A		S 3055 C
assembly UFI / montaggio UFI	8460.41C, 8460TCA	221	300	07/92	>	06/02	S 5003 DR	S 4329 NR	S 7546 A		S 3055 C
or / oppure	8460.41C, 8460TCA	221	300	07/92	>	06/02	S 5003 DR	S 5400 NR	S 7546 A		S 3055 C
prefilter / prefiltrato	8460.41C, 8460TCA	221	300	07/92	>	06/02		S 0999 NR			
power steering / servosterzo	8460.41C, 8460TCA	221	300	07/92	>	06/02					S 3081 PO
180E34											
water filter / filtro acqua	8460.41K	254	345	01/92	>	12/93					S 8410 AR
dryer filter / filtro essiccatore	8460.41K	254	345	01/92	>	12/93					S 7259 A
assembly BOSCH / montaggio BOSCH	8460.41K	254	345	01/92	>	12/93	S 5003 DR	S 5401 NR	S 7546 A		S 3055 C
assembly UFI / montaggio UFI	8460.41K	254	345	01/92	>	12/93	S 5003 DR	S 4329 NR	S 7546 A		S 3055 C
or / oppure	8460.41K	254	345	01/92	>	12/93	S 5003 DR	S 5400 NR	S 7546 A		S 3055 C
prefilter / prefiltrato	8460.41K	254	345	01/92	>	12/93		S 0999 NR			
power steering / servosterzo	8460.41K	254	345	01/92	>	12/93					S 3081 PO
180E34											
water filter / filtro acqua	8460.41K E2	254	345	01/92	>	06/02	S 5003 DR	S 4329 NR	S 7546 A		S 3055 C
dryer filter / filtro essiccatore	8460.41K E2	254	345	01/92	>	06/02					S 8410 AR
prefilter / prefiltrato	8460.41K E2	254	345	01/92	>	06/02		S 0999 NR			S 7259 A
power steering / servosterzo	8460.41K E2	254	345	01/92	>	06/02					S 3081 PO
180E38											
water filter / filtro acqua	8460.41L, 8460.41N	276	375	09/92	>	06/02					S 8410 AR
dryer filter / filtro essiccatore	8460.41L, 8460.41N	276	375	09/92	>	06/02					S 7259 A
assembly BOSCH / montaggio BOSCH	8460.41L, 8460.41N	276	375	09/92	>	06/02	S 5003 DR	S 5401 NR	S 7546 A		S 3055 C
assembly UFI / montaggio UFI	8460.41L, 8460.41N	276	375	09/92	>	06/02	S 5003 DR	S 4329 NR	S 7546 A		S 3055 C
or / oppure	8460.41L, 8460.41N	276	375	09/92	>	06/02	S 5003 DR	S 5400 NR	S 7546 A		S 3055 C
prefilter / prefiltrato	8460.41L, 8460.41N	276	375	09/92	>	06/02		S 0999 NR			
power steering / servosterzo	8460.41L, 8460.41N	276	375	09/92	>	06/02					S 3081 PO
180E42											
dryer filter / filtro essiccatore	8210.42L	309	420	04/92	>	06/02	S 5003 DR	S 4329 NR	S 7546 A		S 3055 C
prefilter / prefiltrato	8210.42L	309	420	04/92	>	06/02		S 0999 NR			S 7259 A
power steering / servosterzo	8210.42L	309	420	04/92	>	06/02					S 3081 PO
190E24											
water filter / filtro acqua	8360.46R	176	239	01/97	>	08/98	S 5003 DR	S 4329 NR	S 7546 A		S 3055 C
dryer filter / filtro essiccatore	8360.46R	176	239	01/97	>	08/98					S 8410 AR
prefilter / prefiltrato	8360.46R	176	239	01/97	>	08/98		S 0999 NR			S 7259 A
power steering / servosterzo	8360.46R	176	239	01/97	>	08/98					S 3081 PO
190E24 Cursor 8											
some BLOW-BY filter (504153481) / alcuni filtro BLOW-BY (504153481)	F2BE0681D	180	245	11/98	>	06/02	S 3288 R	S 4396 NR	S 7546 A		S 3055 C
dryer filter / filtro essiccatore	F2BE0681D	180	245	11/98	>	06/02					S 7266 A
VGT filter / filtro VGT	F2BE0681D	180	245	11/98	>	06/02					S 7259 A
prefilter / prefiltrato	F2BE0681D	180	245	11/98	>	06/02		S 0999 NR			S 0VGT A
power steering / servosterzo	F2BE0681D	180	245	11/98	>	06/02					S 3081 PO
190E27											
water filter / filtro acqua	8360.46	196	266	01/97	>	12/98	S 5003 DR	S 4329 NR	S 7546 A		S 3055 C
dryer filter / filtro essiccatore	8360.46	196	266	01/97	>	12/98					S 8410 AR
prefilter / prefiltrato	8360.46	196	266	01/97	>	12/98		S 0999 NR			S 7259 A
power steering / servosterzo	8360.46	196	266	01/97	>	12/98					S 3081 PO
190E27 Cursor 8											
some BLOW-BY filter (504153481) / alcuni filtro BLOW-BY (504153481)	F2BE0681	200	272	11/98	>	06/02	S 3288 R	S 4396 NR	S 7546 A		S 3055 C
dryer filter / filtro essiccatore	F2BE0681	200	272	11/98	>	06/02					S 7266 A
VGT filter / filtro VGT	F2BE0681	200	272	11/98	>	06/02					S 7259 A
prefilter / prefiltrato	F2BE0681	200	272	11/98	>	06/02		S 0999 NR			S 0VGT A
power steering / servosterzo	F2BE0681	200	272	11/98	>	06/02					S 3081 PO
190E30											
water filter / filtro acqua	8460.41C, 8460TCA	221	300	07/92	>	06/02					S 8410 AR
dryer filter / filtro essiccatore	8460.41C, 8460TCA	221	300	07/92	>	06/02					S 7259 A

**KW HP****...IVECO - trucks/autocarri**

assembly BOSCH / montaggio BOSCH	8460.41C, 8460TCA	221	300	07/92	>	06/02	S 5003 DR	S 5401 NR	S 7546 A	S 3055 C
assembly UFI / montaggio UFI	8460.41C, 8460TCA	221	300	07/92	>	06/02	S 5003 DR	S 4329 NR	S 7546 A	S 3055 C
or / oppure	8460.41C, 8460TCA	221	300	07/92	>	06/02	S 5003 DR	S 5400 NR	S 7546 A	S 3055 C
prefilter / prefiltra	8460.41C, 8460TCA	221	300	07/92	>	06/02		S 0999 NR		
power steering / servosterzo	8460.41C, 8460TCA	221	300	07/92	>	06/02				S 3081 PO
190E31 Cursor 8	F2BE0681B	228	311	11/98	>	06/02	S 3288 R	S 4396 NR	S 7546 A	S 3055 C
some BLOW-BY filter (504153481) / alcuni filtro BLOW-BY (504153481)	F2BE0681B	228	311	11/98	>	06/02				S 7266 A
dryer filter / filtro essiccatore	F2BE0681B	228	311	11/98	>	06/02				S 7259 A
VGT filter / filtro VGT	F2BE0681B	228	311	11/98	>	06/02				S 0VGT A
prefilter / prefiltra	F2BE0681B	228	311	11/98	>	06/02		S 0999 NR		
power steering / servosterzo	F2BE0681B	228	311	11/98	>	06/02				S 3081 PO
190E34										
water filter / filtro acqua	8460.41K	254	345	04/92	>	06/02				S 8410 AR
dryer filter / filtro essiccatore	8460.41K	254	345	04/92	>	06/02				S 7259 A
assembly BOSCH / montaggio BOSCH	8460.41K	254	345	04/92	>	06/02	S 5003 DR	S 5401 NR	S 7546 A	S 3055 C
assembly UFI / montaggio UFI	8460.41K	254	345	04/92	>	06/02	S 5003 DR	S 4329 NR	S 7546 A	S 3055 C
or / oppure	8460.41K	254	345	04/92	>	06/02	S 5003 DR	S 5400 NR	S 7546 A	S 3055 C
prefilter / prefiltra	8460.41K	254	345	04/92	>	06/02		S 0999 NR		
power steering / servosterzo	8460.41K	254	345	04/92	>	06/02				S 3081 PO
190E34	8460.41K E2	254	345	04/92	>	06/02	S 5003 DR	S 4329 NR	S 7546 A	S 3055 C
water filter / filtro acqua	8460.41K E2	254	345	04/92	>	06/02				S 8410 AR
dryer filter / filtro essiccatore	8460.41K E2	254	345	04/92	>	06/02				S 7259 A
prefilter / prefiltra	8460.41K E2	254	345	04/92	>	06/02		S 0999 NR		
power steering / servosterzo	8460.41K E2	254	345	04/92	>	06/02				S 3081 PO
190E35 Cursor 8	F2BE0681A	259	353	11/98	>	06/02	S 3288 R	S 4396 NR	S 7546 A	S 3055 C
some BLOW-BY filter (504153481) / alcuni filtro BLOW-BY (504153481)	F2BE0681A	259	353	11/98	>	06/02				S 7266 A
with automatic gearbox and hydraulic retarder ZF / con cambio automatico e rallentatore idraulico ZF	F2BE0681A	259	353	11/98	>	06/02				S 2234 Z
dryer filter / filtro essiccatore	F2BE0681A	259	353	11/98	>	06/02				S 7259 A
VGT filter / filtro VGT	F2BE0681A	259	353	11/98	>	06/02				S 0VGT A
prefilter / prefiltra	F2BE0681A	259	353	11/98	>	06/02		S 0999 NR		
power steering / servosterzo	F2BE0681A	259	353	11/98	>	06/02				S 3081 PO
190E38										
water filter / filtro acqua	8460.41L	276	375	09/92	>	06/02				S 8410 AR
dryer filter / filtro essiccatore	8460.41L	276	375	09/92	>	06/02				S 7259 A
assembly BOSCH / montaggio BOSCH	8460.41L	276	375	09/92	>	06/02	S 5003 DR	S 5401 NR	S 7546 A	S 3055 C
assembly UFI / montaggio UFI	8460.41L	276	375	09/92	>	06/02	S 5003 DR	S 4329 NR	S 7546 A	S 3055 C
or / oppure	8460.41L	276	375	09/92	>	06/02	S 5003 DR	S 5400 NR	S 7546 A	S 3055 C
prefilter / prefiltra	8460.41L	276	375	09/92	>	06/02		S 0999 NR		
power steering / servosterzo	8460.41L	276	375	09/92	>	06/02				S 3081 PO
190E38	8460.41N	276	375	01/93	>	06/02	S 5003 DR	S 4329 NR	S 7546 A	S 3055 C
water filter / filtro acqua	8460.41N	276	375	01/93	>	06/02				S 8410 AR
dryer filter / filtro essiccatore	8460.41N	276	375	01/93	>	06/02				S 7259 A
prefilter / prefiltra	8460.41N	276	375	01/93	>	06/02		S 0999 NR		
power steering / servosterzo	8460.41N	276	375	01/93	>	06/02				S 3081 PO
190E39 Cursor 10	F3AE0681E	286	390	01/99	>	06/02		S 4395 NR	S 7544 A	S 3055 C
some BLOW-BY filter (504153481) / alcuni filtro BLOW-BY (504153481)	F3AE0681E	286	390	01/99	>	06/02				S 7266 A
dryer filter / filtro essiccatore	F3AE0681E	286	390	01/99	>	06/02				S 7259 A
VGT filter / filtro VGT	F3AE0681E	286	390	01/99	>	06/02				S 0VGT A
2 filters / N.2 filtri	F3AE0681E	286	390	01/99	>	06/02	S 3288 R			
prefilter / prefiltra	F3AE0681E	286	390	01/99	>	06/02		S 0999 NR		
power steering / servosterzo	F3AE0681E	286	390	01/99	>	06/02				S 3081 PO
190E40 Cursor 10	F3AE0681B	294	400	09/00	>	06/02		S 4395 NR	S 7546 A	S 3055 C
some / alcuni	F3AE0681B	294	400	09/00	>	06/02	S 3288 R	S 4395 NR	S 7544 A	S 3055 C
some BLOW-BY filter (504153481) / alcuni filtro BLOW-BY (504153481)	F3AE0681B	294	400	09/00	>	06/02				S 7266 A
with gearbox ZF Ecosplit + Intarder / con cambio ZF Ecosplit + Intarder	F3AE0681B	294	400	09/00	>	06/02				S 2234 Z
dryer filter / filtro essiccatore	F3AE0681B	294	400	09/00	>	06/02				S 7259 A
VGT filter / filtro VGT	F3AE0681B	294	400	09/00	>	06/02				S 0VGT A
2 filters / N.2 filtri	F3AE0681B	294	400	09/00	>	06/02	S 3288 R			
prefilter / prefiltra	F3AE0681B	294	400	09/00	>	06/02		S 0999 NR		
power steering / servosterzo	F3AE0681B	294	400	09/00	>	06/02				S 3081 PO
190E42	8210.42L	309	420	04/92	>	06/02	S 5003 DR	S 4329 NR	S 7546 A	S 3055 C
dryer filter / filtro essiccatore	8210.42L	309	420	04/92	>	06/02				S 7259 A
prefilter / prefiltra	8210.42L	309	420	04/92	>	06/02		S 0999 NR		
power steering / servosterzo	8210.42L	309	420	04/92	>	06/02				S 3081 PO
190E42	8210.42L E2	309	420	01/93	>	06/02	S 5003 DR	S 4329 NR	S 7546 A	S 3055 C
dryer filter / filtro essiccatore	8210.42L E2	309	420	01/93	>	06/02				S 7259 A
prefilter / prefiltra	8210.42L E2	309	420	01/93	>	06/02		S 0999 NR		



**KW HP****...IVECO - trucks/autocarri**

power steering / servosterzo	8210.42L E2	309	420	01/93	>	06/02				S 3081 PO
190E42	8210TCA	309	420	04/92	>	06/02	S 5003 DR	S 4329 NR	S 7546 A	S 3055 C
dryer filter / filtro essiccatore	8210TCA	309	420	04/92	>	06/02				S 7259 A
prefilter / prefiltrato	8210TCA	309	420	04/92	>	06/02		S 0999 NR		
power steering / servosterzo	8210TCA	309	420	04/92	>	06/02				S 3081 PO
190E43 Cursor 10	F3AE0681D	315	430	01/99	>	06/02		S 4395 NR	S 7544 A	S 3055 C
some BLOW-BY filter (504153481) / alcuni filtro BLOW-BY (504153481)	F3AE0681D	315	430	01/99	>	06/02				S 7266 A
dryer filter / filtro essiccatore	F3AE0681D	315	430	01/99	>	06/02				S 7259 A
VGT filter / filtro VGT	F3AE0681D	315	430	01/99	>	06/02				S 0VGT A
2 filters / N.2 filtri	F3AE0681D	315	430	01/99	>	06/02	S 3288 R			
prefilter / prefiltrato	F3AE0681D	315	430	01/99	>	06/02		S 0999 NR		
power steering / servosterzo	F3AE0681D	315	430	01/99	>	06/02				S 3081 PO
240E30	8460.41C	221	300	07/92	>	06/02	S 5003 DR	S 4329 NR	S 7546 A	S 3055 C
water filter / filtro acqua	8460.41C	221	300	07/92	>	06/02				S 8410 AR
dryer filter / filtro essiccatore	8460.41C	221	300	07/92	>	06/02				S 7259 A
prefilter / prefiltrato	8460.41C	221	300	07/92	>	06/02		S 0999 NR		
power steering / servosterzo	8460.41C	221	300	07/92	>	06/02				S 3081 PO
240E34										
water filter / filtro acqua	8460.41K	254	345	09/95	>	06/02				S 8410 AR
dryer filter / filtro essiccatore	8460.41K	254	345	09/95	>	06/02				S 7259 A
assembly BOSCH / montaggio BOSCH	8460.41K	254	345	09/95	>	06/02	S 5003 DR	S 5401 NR	S 7546 A	S 3055 C
assembly UFI / montaggio UFI	8460.41K	254	345	09/95	>	06/02	S 5003 DR	S 4329 NR	S 7546 A	S 3055 C
or / oppure	8460.41K	254	345	09/95	>	06/02	S 5003 DR	S 5400 NR	S 7546 A	S 3055 C
prefilter / prefiltrato	8460.41K	254	345	09/95	>	06/02		S 0999 NR		
power steering / servosterzo	8460.41K	254	345	09/95	>	06/02				S 3081 PO
240E34	8460.41K E2	254	345	09/95	>	06/02	S 5003 DR	S 4329 NR	S 7546 A	S 3055 C
water filter / filtro acqua	8460.41K E2	254	345	09/95	>	06/02				S 8410 AR
dryer filter / filtro essiccatore	8460.41K E2	254	345	09/95	>	06/02				S 7259 A
prefilter / prefiltrato	8460.41K E2	254	345	09/95	>	06/02		S 0999 NR		
power steering / servosterzo	8460.41K E2	254	345	09/95	>	06/02				S 3081 PO
240E38	8210.42L	276	375	09/92	>	06/02	S 5003 DR	S 4329 NR	S 7546 A	S 3055 C
water filter / filtro acqua	8210.42L	276	375	09/92	>	06/02				S 8410 AR
dryer filter / filtro essiccatore	8210.42L	276	375	09/92	>	06/02				S 7259 A
prefilter / prefiltrato	8210.42L	276	375	09/92	>	06/02		S 0999 NR		
power steering / servosterzo	8210.42L	276	375	09/92	>	06/02				S 3081 PO
240E38										
water filter / filtro acqua	8460.41L	276	375	09/92	>	06/02				S 8410 AR
dryer filter / filtro essiccatore	8460.41L	276	375	09/92	>	06/02				S 7259 A
assembly BOSCH / montaggio BOSCH	8460.41L	276	375	09/92	>	06/02	S 5003 DR	S 5401 NR	S 7546 A	S 3055 C
assembly UFI / montaggio UFI	8460.41L	276	375	09/92	>	06/02	S 5003 DR	S 4329 NR	S 7546 A	S 3055 C
or / oppure	8460.41L	276	375	09/92	>	06/02	S 5003 DR	S 5400 NR	S 7546 A	S 3055 C
prefilter / prefiltrato	8460.41L	276	375	09/92	>	06/02		S 0999 NR		
power steering / servosterzo	8460.41L	276	375	09/92	>	06/02				S 3081 PO
240E38	8460.41N	276	375	09/92	>	06/02	S 5003 DR	S 4329 NR	S 7546 A	S 3055 C
water filter / filtro acqua	8460.41N	276	375	09/92	>	06/02				S 8410 AR
dryer filter / filtro essiccatore	8460.41N	276	375	09/92	>	06/02				S 7259 A
prefilter / prefiltrato	8460.41N	276	375	09/92	>	06/02		S 0999 NR		
power steering / servosterzo	8460.41N	276	375	09/92	>	06/02				S 3081 PO
240E42	8210.42L, 8210.42L E2	309	420	04/92	>	06/02	S 5003 DR	S 4329 NR	S 7546 A	S 3055 C
dryer filter / filtro essiccatore	8210.42L, 8210.42L E2	309	420	04/92	>	06/02				S 7259 A
prefilter / prefiltrato	8210.42L, 8210.42L E2	309	420	04/92	>	06/02		S 0999 NR		
power steering / servosterzo	8210.42L, 8210.42L E2	309	420	04/92	>	06/02				S 3081 PO
260E24 Cursor 8	F2BE0681D	180	245	11/98	>	06/02	S 3288 R	S 4396 NR	S 7546 A	S 3055 C
some BLOW-BY filter (504153481) / alcuni filtro BLOW-BY (504153481)	F2BE0681D	180	245	11/98	>	06/02				S 7266 A
dryer filter / filtro essiccatore	F2BE0681D	180	245	11/98	>	06/02				S 7259 A
VGT filter / filtro VGT	F2BE0681D	180	245	11/98	>	06/02				S 0VGT A
prefilter / prefiltrato	F2BE0681D	180	245	11/98	>	06/02		S 0999 NR		
power steering / servosterzo	F2BE0681D	180	245	11/98	>	06/02				S 3081 PO
power steering / servosterzo	F2BE0681D	180	245	11/98	>	06/02				S 8790 PO
260E27 Cursor 8	F2BE0681	200	272	11/98	>	06/02	S 3288 R	S 4396 NR	S 7546 A	S 3055 C
some BLOW-BY filter (504153481) / alcuni filtro BLOW-BY (504153481)	F2BE0681	200	272	11/98	>	06/02				S 7266 A
with gearbox ZF Ecosplit + Intarder / con cambio ZF Ecosplit + Intarder	F2BE0681	200	272	11/98	>	06/02				S 2234 Z
dryer filter / filtro essiccatore	F2BE0681	200	272	11/98	>	06/02				S 7259 A
VGT filter / filtro VGT	F2BE0681	200	272	11/98	>	06/02				S 0VGT A
prefilter / prefiltrato	F2BE0681	200	272	11/98	>	06/02		S 0999 NR		
power steering / servosterzo	F2BE0681	200	272	11/98	>	06/02				S 3081 PO
260E31 Cursor 8	F2BE0681, F2BE0681B	228	311	11/98	>	06/02	S 3288 R	S 4396 NR	S 7546 A	S 3055 C

**KW HP****...IVECO - trucks/autocarri**

some BLOW-BY filter (504153481) / alcuni filtro BLOW-BY (504153481)	F2BE0681, F2BE0681B	228	311	11/98	>	06/02				S 7266 A
dryer filter / filtro essiccatore	F2BE0681, F2BE0681B	228	311	11/98	>	06/02				S 7259 A
VGT filter / filtro VGT	F2BE0681, F2BE0681B	228	311	11/98	>	06/02				S 0VGT A
prefilter / prefiltra	F2BE0681, F2BE0681B	228	311	11/98	>	06/02		S 0999 NR		
power steering / servosterzo	F2BE0681, F2BE0681B	228	311	11/98	>	06/02				S 3081 PO
power steering / servosterzo	F2BE0681, F2BE0681B	228	311	11/98	>	06/02				S 8790 PO
260E35 Cursor 8	F2BE0681A	259	352	11/98	>	06/02	S 3288 R	S 4396 NR	S 7546 A	S 3055 C
some BLOW-BY filter (504153481) / alcuni filtro BLOW- (504153481)	F2BE0681A	259	352	11/98	>	06/02				S 7266 A
dryer filter / filtro essiccatore	F2BE0681A	259	352	11/98	>	06/02				S 7259 A
VGT filter / filtro VGT	F2BE0681A	259	352	11/98	>	06/02				S 0VGT A
prefilter / prefiltra	F2BE0681A	259	352	11/98	>	06/02		S 0999 NR		
power steering / servosterzo	F2BE0681A	259	352	11/98	>	06/02				S 3081 PO
power steering / servosterzo	F2BE0681A	259	352	11/98	>	06/02				S 8790 PO
260E38										
water filter / filtro acqua	8460.41L	276	375	06/92	>	06/02				S 8410 AR
dryer filter / filtro essiccatore	8460.41L	276	375	06/92	>	06/02				S 7259 A
assembly BOSCH / montaggio BOSCH	8460.41L	276	375	06/92	>	06/02	S 5003 DR	S 5401 NR	S 7546 A	S 3055 C
assembly UFI / montaggio UFI	8460.41L	276	375	06/92	>	06/02	S 5003 DR	S 4329 NR	S 7546 A	S 3055 C
or / oppure	8460.41L	276	375	06/92	>	06/02	S 5003 DR	S 5400 NR	S 7546 A	S 3055 C
prefilter / prefiltra	8460.41L	276	375	06/92	>	06/02		S 0999 NR		
power steering / servosterzo	8460.41L	276	375	06/92	>	06/02				S 3081 PO
260E38	8460.41N	276	375	06/92	>	06/02	S 5003 DR	S 4329 NR	S 7546 A	S 3055 C
water filter / filtro acqua	8460.41N	276	375	06/92	>	06/02				S 8410 AR
dryer filter / filtro essiccatore	8460.41N	276	375	06/92	>	06/02				S 7259 A
prefilter / prefiltra	8460.41N	276	375	06/92	>	06/02		S 0999 NR		
power steering / servosterzo	8460.41N	276	375	06/92	>	06/02				S 3081 PO
260E39 Cursor 10	F3AE0681, F3AE0681E	286	390	11/99	>	06/02		S 4395 NR	S 7544 A	S 3055 C
some BLOW-BY filter (504153481) / alcuni filtro BLOW-BY (504153481)	F3AE0681, F3AE0681E	286	390	11/99	>	06/02				S 7266 A
dryer filter / filtro essiccatore	F3AE0681, F3AE0681E	286	390	11/99	>	06/02				S 7259 A
VGT filter / filtro VGT	F3AE0681, F3AE0681E	286	390	11/99	>	06/02				S 0VGT A
2 filters / N.2 filtri	F3AE0681, F3AE0681E	286	390	11/99	>	06/02	S 3288 R			
prefilter / prefiltra	F3AE0681, F3AE0681E	286	390	11/99	>	06/02		S 0999 NR		
power steering / servosterzo	F3AE0681, F3AE0681E	286	390	11/99	>	06/02				S 8790 PO
260E40 Cursor 10	F3AE0681B	294	400	08/00	>	06/02		S 4395 NR	S 7546 A	S 3055 C
some BLOW-BY filter (504153481) / alcuni filtro BLOW-BY (504153481)	F3AE0681B	294	400	08/00	>	06/02				S 7266 A
with gearbox ZF Ecosplit + Intarder / con cambio ZF Ecosplit + Intarder	F3AE0681B	294	400	08/00	>	06/02				S 2234 Z
dryer filter / filtro essiccatore	F3AE0681B	294	400	08/00	>	06/02				S 7259 A
VGT filter / filtro VGT	F3AE0681B	294	400	08/00	>	06/02				S 0VGT A
2 filters / N.2 filtri	F3AE0681B	294	400	08/00	>	06/02	S 3288 R			
prefilter / prefiltra	F3AE0681B	294	400	08/00	>	06/02		S 0999 NR		
power steering / servosterzo	F3AE0681B	294	400	08/00	>	06/02				S 3081 PO
260E42	8210.42L, 8210.42L E2	309	420	06/92	>	06/02	S 5003 DR	S 4329 NR	S 7546 A	S 3055 C
dryer filter / filtro essiccatore	8210.42L, 8210.42L E2	309	420	06/92	>	06/02				S 7259 A
prefilter / prefiltra	8210.42L, 8210.42L E2	309	420	06/92	>	06/02		S 0999 NR		
power steering / servosterzo	8210.42L, 8210.42L E2	309	420	06/92	>	06/02				S 3081 PO
260E42	8210TCA	309	420	06/92	>	06/02	S 5003 DR	S 4329 NR	S 7546 A	S 3055 C
dryer filter / filtro essiccatore	8210TCA	309	420	06/92	>	06/02				S 7259 A
prefilter / prefiltra	8210TCA	309	420	06/92	>	06/02		S 0999 NR		
power steering / servosterzo	8210TCA	309	420	06/92	>	06/02				S 3081 PO
260E43 Cursor 10	F3AE0681, F3AE0681D	315	430	11/99	>	06/02		S 4395 NR	S 7544 A	S 3055 C
some BLOW-BY filter (504153481) / alcuni filtro BLOW-BY (504153481)	F3AE0681, F3AE0681D	315	430	11/99	>	06/02				S 7266 A
dryer filter / filtro essiccatore	F3AE0681, F3AE0681D	315	430	11/99	>	06/02				S 7259 A
VGT filter / filtro VGT	F3AE0681, F3AE0681D	315	430	11/99	>	06/02				S 0VGT A
2 filters / N.2 filtri	F3AE0681, F3AE0681D	315	430	11/99	>	06/02	S 3288 R			
prefilter / prefiltra	F3AE0681, F3AE0681D	315	430	11/99	>	06/02		S 0999 NR		
power steering / servosterzo	F3AE0681, F3AE0681D	315	430	11/99	>	06/02				S 8790 PO
325E27	8360.46	200	273	07/92	>	06/02	S 5003 DR	S 4329 NR	S 7546 A	S 3055 C
water filter / filtro acqua	8360.46	200	273	07/92	>	06/02				S 8410 AR
dryer filter / filtro essiccatore	8360.46	200	273	07/92	>	06/02				S 7259 A
prefilter / prefiltra	8360.46	200	273	07/92	>	06/02		S 0999 NR		
power steering / servosterzo	8360.46	200	273	07/92	>	06/02				S 3081 PO
400E30										
water filter / filtro acqua	8460.41C	221	300	04/92	>	06/02				S 8410 AR
dryer filter / filtro essiccatore	8460.41C	221	300	04/92	>	06/02				S 7259 A
assembly BOSCH / montaggio BOSCH	8460.41C	221	300	04/92	>	06/02	S 5003 DR	S 5401 NR	S 7546 A	S 3055 C
assembly UFI / montaggio UFI	8460.41C	221	300	04/92	>	06/02	S 5003 DR	S 4329 NR	S 7546 A	S 3055 C
or / oppure	8460.41C	221	300	04/92	>	06/02	S 5003 DR	S 5400 NR	S 7546 A	S 3055 C





...IVECO - trucks/autocarri

prefilter / prefiltrato	8460.41C	221	300	04/92	>	06/02		S 0999 NR			
power steering / servosterzo	8460.41C	221	300	04/92	>	06/02					S 3081 PO
400E31 Cursor 8	F2BE0681B	228	311	09/98	>	06/02	S 3288 R	S 4396 NR	S 7546 A		S 3055 C
some BLOW-BY filter (504153481) / alcuni filtro BLOW-BY (504153481)	F2BE0681B	228	311	09/98	>	06/02					S 7266 A
dryer filter / filtro essiccatore	F2BE0681B	228	311	09/98	>	06/02					S 7259 A
VGT filter / filtro VGT	F2BE0681B	228	311	09/98	>	06/02					S 0VGT A
prefilter / prefiltrato	F2BE0681B	228	311	09/98	>	06/02		S 0999 NR			
power steering / servosterzo	F2BE0681B	228	311	09/98	>	06/02					S 3081 PO
400E34											
water filter / filtro acqua	8460.41K	254	345	04/92	>	06/02					S 8410 AR
dryer filter / filtro essiccatore	8460.41K	254	345	04/92	>	06/02					S 7259 A
assembly BOSCH / montaggio BOSCH	8460.41K	254	345	04/92	>	06/02	S 5003 DR	S 5401 NR	S 7546 A		S 3055 C
assembly UFI / montaggio UFI	8460.41K	254	345	04/92	>	06/02	S 5003 DR	S 4329 NR	S 7546 A		S 3055 C
or / oppure	8460.41K	254	345	04/92	>	06/02	S 5003 DR	S 5400 NR	S 7546 A		S 3055 C
prefilter / prefiltrato	8460.41K	254	345	04/92	>	06/02		S 0999 NR			
power steering / servosterzo	8460.41K	254	345	04/92	>	06/02					S 3081 PO
400E34	8460.41K E2	254	345	04/92	>	06/02	S 5003 DR	S 4329 NR	S 7546 A		S 3055 C
water filter / filtro acqua	8460.41K E2	254	345	04/92	>	06/02					S 8410 AR
dryer filter / filtro essiccatore	8460.41K E2	254	345	04/92	>	06/02					S 7259 A
prefilter / prefiltrato	8460.41K E2	254	345	04/92	>	06/02		S 0999 NR			
power steering / servosterzo	8460.41K E2	254	345	04/92	>	06/02					S 3081 PO
400E38	8460.41L	276	375	09/92	>	06/02	S 5003 DR	S 5401 NR	S 7546 A		S 3055 C
water filter / filtro acqua	8460.41L	276	375	09/92	>	06/02					S 8410 AR
dryer filter / filtro essiccatore	8460.41L	276	375	09/92	>	06/02					S 7259 A
assembly UFI / montaggio UFI	8460.41L	276	375	09/92	>	06/02	S 5003 DR	S 4329 NR	S 7546 A		S 3055 C
or / oppure	8460.41L	276	375	09/92	>	06/02	S 5003 DR	S 5400 NR	S 7546 A		S 3055 C
prefilter / prefiltrato	8460.41L	276	375	09/92	>	06/02		S 0999 NR			
power steering / servosterzo	8460.41L	276	375	09/92	>	06/02					S 3081 PO
400E38	8460.41N	276	375	09/92	>	06/02	S 5003 DR	S 4329 NR	S 7546 A		S 3055 C
water filter / filtro acqua	8460.41N	276	375	09/92	>	06/02					S 8410 AR
dryer filter / filtro essiccatore	8460.41N	276	375	09/92	>	06/02					S 7259 A
prefilter / prefiltrato	8460.41N	276	375	09/92	>	06/02		S 0999 NR			
power steering / servosterzo	8460.41N	276	375	09/92	>	06/02					S 3081 PO
400E42	8210.42L, 8210.42L E2	309	420	01/92	>	06/02	S 5003 DR	S 4329 NR	S 7546 A		S 3055 C
dryer filter / filtro essiccatore	8210.42L, 8210.42L E2	309	420	01/92	>	06/02					S 7259 A
prefilter / prefiltrato	8210.42L, 8210.42L E2	309	420	01/92	>	06/02		S 0999 NR			
power steering / servosterzo	8210.42L, 8210.42L E2	309	420	01/92	>	06/02					S 3081 PO
440E31 Cursor 8	F2BE0681B	228	311	09/98	>	06/02	S 3288 R	S 4396 NR	S 7546 A		S 3055 C
some BLOW-BY filter (504153481) / alcuni filtro BLOW-BY (504153481)	F2BE0681B	228	311	09/98	>	06/02					S 7266 A
dryer filter / filtro essiccatore	F2BE0681B	228	311	09/98	>	06/02					S 7259 A
VGT filter / filtro VGT	F2BE0681B	228	311	09/98	>	06/02					S 0VGT A
prefilter / prefiltrato	F2BE0681B	228	311	09/98	>	06/02		S 0999 NR			
power steering / servosterzo	F2BE0681B	228	311	09/98	>	06/02					S 3081 PO
440E34											
water filter / filtro acqua	8460.41K	254	345	04/92	>	06/02					S 8410 AR
dryer filter / filtro essiccatore	8460.41K	254	345	04/92	>	06/02					S 7259 A
assembly BOSCH / montaggio BOSCH	8460.41K	254	345	04/92	>	06/02	S 5003 DR	S 5401 NR	S 7546 A		S 3055 C
assembly UFI / montaggio UFI	8460.41K	254	345	04/92	>	06/02	S 5003 DR	S 4329 NR	S 7546 A		S 3055 C
or / oppure	8460.41K	254	345	04/92	>	06/02	S 5003 DR	S 5400 NR	S 7546 A		S 3055 C
prefilter / prefiltrato	8460.41K	254	345	04/92	>	06/02		S 0999 NR			
power steering / servosterzo	8460.41K	254	345	04/92	>	06/02					S 3081 PO
440E34	8460.41K E2	254	345	04/92	>	06/02	S 5003 DR	S 4329 NR	S 7546 A		S 3055 C
water filter / filtro acqua	8460.41K E2	254	345	04/92	>	06/02					S 8410 AR
dryer filter / filtro essiccatore	8460.41K E2	254	345	04/92	>	06/02					S 7259 A
prefilter / prefiltrato	8460.41K E2	254	345	04/92	>	06/02		S 0999 NR			
power steering / servosterzo	8460.41K E2	254	345	04/92	>	06/02					S 3081 PO
440E35 Cursor 8	F2BE0681, F2BE0681A	259	352	09/98	>	06/02	S 3288 R	S 4396 NR	S 7546 A		S 3055 C
some BLOW-BY filter (504153481) / alcuni filtro BLOW-BY (504153481)	F2BE0681, F2BE0681A	259	352	09/98	>	06/02					S 7266 A
with automatic gearbox and hydraulic retarder ZF / con cambio automatico e rallentatore idraulico ZF	F2BE0681, F2BE0681A	259	352	09/98	>	06/02					S 2234 Z
dryer filter / filtro essiccatore	F2BE0681, F2BE0681A	259	352	09/98	>	06/02					S 7259 A
VGT filter / filtro VGT	F2BE0681, F2BE0681A	259	352	09/98	>	06/02					S 0VGT A
prefilter / prefiltrato	F2BE0681, F2BE0681A	259	352	09/98	>	06/02		S 0999 NR			
power steering / servosterzo	F2BE0681, F2BE0681A	259	352	09/98	>	06/02					S 3081 PO
440E38											
water filter / filtro acqua	8460.41L	203	276	04/93	>	06/02					S 8410 AR
dryer filter / filtro essiccatore	8460.41L	203	276	04/93	>	06/02					S 7259 A
assembly BOSCH / montaggio BOSCH	8460.41L	203	276	04/93	>	06/02	S 5003 DR	S 5401 NR	S 7546 A		S 3055 C

**KW HP****...IVECO - trucks/autocarri**

assembly UFI / montaggio UFI	8460.41L	203	276	04/93	>	06/02	S 5003 DR	S 4329 NR	S 7546 A	S 3055 C
or / oppure	8460.41L	203	276	04/93	>	06/02	S 5003 DR	S 5400 NR	S 7546 A	S 3055 C
prefilter / prefiltra	8460.41L	203	276	04/93	>	06/02		S 0999 NR		
power steering / servosterzo	8460.41L	203	276	04/93	>	06/02				S 3081 PO
440E38	8460.41N	203	276	04/93	>	06/02	S 5003 DR	S 4329 NR	S 7546 A	S 3055 C
water filter / filtro acqua	8460.41N	203	276	04/93	>	06/02				S 8410 AR
dryer filter / filtro essiccatore	8460.41N	203	276	04/93	>	06/02				S 7259 A
prefilter / prefiltra	8460.41N	203	276	04/93	>	06/02		S 0999 NR		
power steering / servosterzo	8460.41N	203	276	04/93	>	06/02				S 3081 PO
440E38	8460TCA	203	276	04/93	>	06/02	S 5003 DR	S 4329 NR	S 7546 A	S 3055 C
water filter / filtro acqua	8460TCA	203	276	04/93	>	06/02				S 8410 AR
dryer filter / filtro essiccatore	8460TCA	203	276	04/93	>	06/02				S 7259 A
prefilter / prefiltra	8460TCA	203	276	04/93	>	06/02		S 0999 NR		
power steering / servosterzo	8460TCA	203	276	04/93	>	06/02				S 3081 PO
440E39 Cursor 10	F3AE0681, F3AE0681	286	390	01/99	>	06/02		S 4395 NR	S 7544 A	S 3055 C
some BLOW-BY filter (504153481) / alcuni filtro BLOW-BY (504153481)	F3AE0681, F3AE0681	286	390	01/99	>	06/02				S 7266 A
with automatic gearbox and hydraulic retarder ZF / con cambio automatico e rallentatore idraulico ZF	F3AE0681, F3AE0681	286	390	01/99	>	06/02				S 2234 Z
dryer filter / filtro essiccatore	F3AE0681, F3AE0681	286	390	01/99	>	06/02				S 7259 A
VGT filter / filtro VGT	F3AE0681, F3AE0681	286	390	01/99	>	06/02				S 0VGT A
2 filters / N.2 filtri	F3AE0681, F3AE0681	286	390	01/99	>	06/02	S 3288 R			
prefilter / prefiltra	F3AE0681, F3AE0681	286	390	01/99	>	06/02		S 0999 NR		
power steering / servosterzo	F3AE0681, F3AE0681	286	390	01/99	>	06/02				S 3081 PO
power steering / servosterzo	F3AE0681, F3AE0681	286	390	01/99	>	06/02				S 8790 PO
440E40 Cursor 10	F3AE0681B	294	400	07/00	>	06/02		S 4395 NR	S 7546 A	S 3055 C
some BLOW-BY filter (504153481) / alcuni filtro BLOW-BY (504153481)	F3AE0681B	294	400	07/00	>	06/02				S 7266 A
with gearbox ZF Ecosplit + Intarder / con cambio ZF Ecosplit + Intarder	F3AE0681B	294	400	07/00	>	06/02				S 2234 Z
dryer filter / filtro essiccatore	F3AE0681B	294	400	07/00	>	06/02				S 7259 A
VGT filter / filtro VGT	F3AE0681B	294	400	07/00	>	06/02				S 0VGT A
2 filters / N.2 filtri	F3AE0681B	294	400	07/00	>	06/02	S 3288 R			
prefilter / prefiltra	F3AE0681B	294	400	07/00	>	06/02		S 0999 NR		
power steering / servosterzo	F3AE0681B	294	400	07/00	>	06/02				S 3081 PO
440E42	8210.42L, 8210.42L E2	309	420	04/92	>	06/02	S 5003 DR	S 4329 NR	S 7546 A	S 3055 C
dryer filter / filtro essiccatore	8210.42L, 8210.42L E2	309	420	04/92	>	06/02				S 7259 A
prefilter / prefiltra	8210.42L, 8210.42L E2	309	420	04/92	>	06/02		S 0999 NR		
power steering / servosterzo	8210.42L, 8210.42L E2	309	420	04/92	>	06/02				S 3081 PO
440E43 Cursor 10	F3AE0681D	315	430	11/99	>	06/02		S 4395 NR	S 7544 A	S 3055 C
some BLOW-BY filter (504153481) / alcuni filtro BLOW-BY (504153481)	F3AE0681D	315	430	01/99	>	06/02				S 7266 A
with automatic gearbox and hydraulic retarder ZF / con cambio automatico e rallentatore idraulico ZF	F3AE0681D	315	430	11/99	>	06/02				S 2234 Z
dryer filter / filtro essiccatore	F3AE0681D	315	430	11/99	>	06/02				S 7259 A
VGT filter / filtro VGT	F3AE0681D	315	430	11/99	>	06/02				S 0VGT A
2 filters / N.2 filtri	F3AE0681D	315	430	11/99	>	06/02	S 3288 R			
prefilter / prefiltra	F3AE0681D	315	430	11/99	>	06/02		S 0999 NR		
power steering / servosterzo	F3AE0681D	315	430	11/99	>	06/02				S 3081 PO
Eurotrakker										
180E24 Cursor 8	F2BE0681	180	245	11/99	>	11/04	S 3288 R	S 4396 NR	S 7546 A	S 3055 C
some BLOW-BY filter (504153481) / alcuni filtro BLOW-BY (504153481)	F2BE0681	180	245	11/99	>	11/04				S 7266 A
dryer filter / filtro essiccatore	F2BE0681	180	245	11/99	>	11/04				S 7259 A
VGT filter / filtro VGT	F2BE0681	180	245	11/99	>	11/04				S 0VGT A
prefilter / prefiltra	F2BE0681	180	245	11/99	>	11/04		S 0999 NR		
power steering / servosterzo	F2BE0681	180	245	11/99	>	11/04				S 3081 PO
180E25	8460.41T	185	252	01/98	>	11/04	S 5003 DR	S 4329 NR	S 7546 A	S 3055 C
water filter / filtro acqua	8460.41T	185	252	01/98	>	11/04				S 8410 AR
dryer filter / filtro essiccatore	8460.41T	185	252	01/98	>	11/04				S 7259 A
prefilter / prefiltra	8460.41T	185	252	01/98	>	11/04		S 0999 NR		
power steering / servosterzo	8460.41T	185	252	01/98	>	11/04				S 3081 PO
180E27 Cursor 8	F2BE0681	200	272	11/99	>	11/04	S 3288 R	S 4396 NR	S 7546 A	S 3055 C
some BLOW-BY filter (504153481) / alcuni filtro BLOW-BY (504153481)	F2BE0681	200	272	11/99	>	11/04				S 7266 A
dryer filter / filtro essiccatore	F2BE0681	200	272	11/99	>	11/04				S 7259 A
VGT filter / filtro VGT	F2BE0681	200	272	11/99	>	11/04				S 0VGT A
prefilter / prefiltra	F2BE0681	200	272	11/99	>	11/04		S 0999 NR		
power steering / servosterzo	F2BE0681	200	272	11/99	>	11/04				S 3081 PO
190E24 Cursor 8	F2BE0681	180	245	11/99	>	11/04	S 3288 R	S 4396 NR	S 7546 A	S 3055 C
some BLOW-BY filter (504153481) / alcuni filtro BLOW-BY (504153481)	F2BE0681	180	245	11/99	>	11/04				S 7266 A
dryer filter / filtro essiccatore	F2BE0681	180	245	11/99	>	11/04				S 7259 A
VGT filter / filtro VGT	F2BE0681	180	245	11/99	>	11/04				S 0VGT A
prefilter / prefiltra	F2BE0681	180	245	11/99	>	11/04		S 0999 NR		
power steering / servosterzo	F2BE0681	180	245	11/99	>	11/04				S 3081 PO



**KW HP****...IVECO - trucks/autocarri**

190E27 Cursor 8	F2BE0681	200	273	11/99	>	11/04	S 3288 R	S 4396 NR	S 7546 A	S 3055 C
some BLOW-BY filter (504153481) / alcuni filtro BLOW-BY (504153481)	F2BE0681	200	273	11/99	>	11/04				S 7266 A
dryer filter / filtro essiccatore	F2BE0681	200	273	11/99	>	11/04				S 7259 A
VGT filter / filtro VGT	F2BE0681	200	273	11/99	>	11/04				S 0VGT A
prefilter / prefiltro	F2BE0681	200	273	11/99	>	11/04		S 0999 NR		
power steering / servosterzo	F2BE0681	200	273	11/99	>	11/04				S 3081 PO
190E30										
water filter / filtro acqua	8460.41C	221	301	01/93	>	11/04				S 8410 AR
dryer filter / filtro essiccatore	8460.41C	221	301	01/93	>	11/04				S 7259 A
assembly BOSCH / montaggio BOSCH	8460.41C	221	301	01/93	>	11/04	S 5003 DR	S 5401 NR	S 7546 A	S 3055 C
assembly UFI / montaggio UFI	8460.41C	221	301	01/93	>	11/04	S 5003 DR	S 4329 NR	S 7546 A	S 3055 C
or / oppure	8460.41C	221	301	01/93	>	11/04	S 5003 DR	S 5400 NR	S 7546 A	S 3055 C
prefilter / prefiltro	8460.41C	221	301	01/93	>	11/04		S 0999 NR		
power steering / servosterzo	8460.41C	221	301	01/93	>	11/04				S 3081 PO
190E30	8460.41C E2	221	301	01/93	>	11/04	S 5003 DR	S 4329 NR	S 7546 A	S 3055 C
water filter / filtro acqua	8460.41C E2	221	301	01/93	>	11/04				S 8410 AR
dryer filter / filtro essiccatore	8460.41C E2	221	301	01/93	>	11/04				S 7259 A
prefilter / prefiltro	8460.41C E2	221	301	01/93	>	11/04		S 0999 NR		
power steering / servosterzo	8460.41C E2	221	301	01/93	>	11/04				S 3081 PO
190E31	8210.22V	228	311	09/90	>	11/04	S 5003 DR	S 4329 NR	S 7546 A	S 3055 C
dryer filter / filtro essiccatore	8210.22V	228	311	09/90	>	11/04				S 7259 A
prefilter / prefiltro	8210.22V	228	311	09/90	>	11/04		S 0999 NR		
power steering / servosterzo	8210.22V	228	311	09/90	>	11/04				S 3081 PO
190E31 Cursor 8	F2BE0681	228	311	01/99	>	11/04	S 3288 R	S 4396 NR	S 7546 A	S 3055 C
some BLOW-BY filter (504153481) / alcuni filtro BLOW-BY (504153481)	F2BE0681	228	311	01/99	>	11/04				S 7266 A
dryer filter / filtro essiccatore	F2BE0681	228	311	01/99	>	11/04				S 7259 A
VGT filter / filtro VGT	F2BE0681	228	311	01/99	>	11/04				S 0VGT A
prefilter / prefiltro	F2BE0681	228	311	01/99	>	11/04		S 0999 NR		
power steering / servosterzo	F2BE0681	228	311	01/99	>	11/04				S 3081 PO
190E34	8460.41K, 8460.41K E2	254	345	04/92	>	11/04	S 5003 DR	S 4329 NR	S 7546 A	S 3055 C
water filter / filtro acqua	8460.41K, 8460.41K E2	254	345	04/92	>	11/04				S 8410 AR
dryer filter / filtro essiccatore	8460.41K, 8460.41K E2	254	345	04/92	>	11/04				S 7259 A
prefilter / prefiltro	8460.41K, 8460.41K E2	254	345	04/92	>	11/04		S 0999 NR		
power steering / servosterzo	8460.41K, 8460.41K E2	254	345	04/92	>	11/04				S 3081 PO
190E35 Cursor 8	F2BE0681A	259	353	01/99	>	11/04	S 3288 R	S 4396 NR	S 7546 A	S 3055 C
some BLOW-BY filter (504153481) / alcuni filtro BLOW-BY (504153481)	F2BE0681A	259	353	01/99	>	11/04				S 7266 A
with automatic gearbox and hydraulic retarder ZF / con cambio automatico e rallentatore idraulico ZF	F2BE0681A	259	353	01/99	>	11/04				S 2234 Z
dryer filter / filtro essiccatore	F2BE0681A	259	353	01/99	>	11/04				S 7259 A
VGT filter / filtro VGT	F2BE0681A	259	353	01/99	>	11/04				S 0VGT A
prefilter / prefiltro	F2BE0681A	259	353	01/99	>	11/04		S 0999 NR		
power steering / servosterzo	F2BE0681A	259	353	01/99	>	11/04				S 3081 PO
190E37	8210.42K, 8210.42K E2	272	370	01/93	>	11/04	S 5003 DR	S 4329 NR	S 7546 A	S 3055 C
with automatic gearbox and hydraulic retarder ZF / con cambio automatico e rallentatore idraulico ZF	8210.42K, 8210.42K E2	272	370	01/93	>	11/04				S 2234 Z
dryer filter / filtro essiccatore	8210.42K, 8210.42K E2	272	370	01/93	>	11/04				S 7259 A
prefilter / prefiltro	8210.42K, 8210.42K E2	272	370	01/93	>	11/04		S 0999 NR		
power steering / servosterzo	8210.42K, 8210.42K E2	272	370	01/93	>	11/04				S 3081 PO
190E38 Cursor 13	F3BE0681	280	382	01/00	>	11/04		S 4395 NR	S 7544 A	S 3055 C
some BLOW-BY filter (504153481) / alcuni filtro BLOW-BY (504153481)	F3BE0681	280	382	01/00	>	11/04				S 7266 A
dryer filter / filtro essiccatore	F3BE0681	280	382	01/00	>	11/04				S 7259 A
VGT filter / filtro VGT	F3BE0681	280	382	01/00	>	11/04				S 0VGT A
2 filters / N.2 filtri	F3BE0681	280	382	01/00	>	11/04	S 3288 R			
prefilter / prefiltro	F3BE0681	280	382	01/00	>	11/04		S 0999 NR		
power steering / servosterzo	F3BE0681	280	382	01/00	>	11/04				S 3081 PO
190E42	8210.42L, 8210.42L E2	309	421	01/93	>	11/04	S 5003 DR	S 4329 NR	S 7546 A	S 3055 C
with automatic gearbox and hydraulic retarder ZF / con cambio automatico e rallentatore idraulico ZF	8210.42L, 8210.42L E2	309	421	01/93	>	11/04				S 2234 Z
dryer filter / filtro essiccatore	8210.42L, 8210.42L E2	309	421	01/93	>	11/04				S 7259 A
prefilter / prefiltro	8210.42L, 8210.42L E2	309	421	01/93	>	11/04		S 0999 NR		
power steering / servosterzo	8210.42L, 8210.42L E2	309	421	01/93	>	11/04				S 3081 PO
190E44 Cursor 13	F3BE0681	324	442	01/00	>	11/04		S 4395 NR	S 7544 A	S 3055 C
some BLOW-BY filter (504153481) / alcuni filtro BLOW-BY (504153481)	F3BE0681	324	442	01/00	>	11/04				S 7266 A
dryer filter / filtro essiccatore	F3BE0681	324	442	01/00	>	11/04				S 7259 A
VGT filter / filtro VGT	F3BE0681	324	442	01/00	>	11/04				S 0VGT A
2 filters / N.2 filtri	F3BE0681	324	442	01/00	>	11/04	S 3288 R			
prefilter / prefiltro	F3BE0681	324	442	01/00	>	11/04		S 0999 NR		
power steering / servosterzo	F3BE0681	324	442	01/00	>	11/04				S 3081 PO
260E30	8460.41C, 8460.41C E2	221	301	01/93	>	11/04	S 5003 DR	S 4329 NR	S 7546 A	S 3055 C
water filter / filtro acqua	8460.41C, 8460.41C E2	221	301	01/93	>	11/04				S 8410 AR

**KW HP****...IVECO - trucks/autocarri**

dryer filter / filtro essiccatore	8460.41C, 8460.41C E2	221	301	01/93	>	11/04				S 7259 A
prefilter / prefiltrato	8460.41C, 8460.41C E2	221	301	01/93	>	11/04		S 0999 NR		
power steering / servosterzo	8460.41C, 8460.41C E2	221	301	01/93	>	11/04				S 3081 PO
260E31 Cursor 8	F2BE0681B	228	311	01/99	>	11/04	S 3288 R	S 4396 NR	S 7546 A	S 3055 C
some / alcuni	F2BE0681B	228	311	01/99	>	11/04	S 3288 R	S 4396 NR	S 7563 A	S 3055 C
some BLOW-BY filter (504153481) / alcuni filtro BLOW-BY (504153481)	F2BE0681B	228	311	01/99	>	11/04				S 7266 A
dryer filter / filtro essiccatore	F2BE0681B	228	311	01/99	>	11/04				S 7259 A
VGT filter / filtro VGT	F2BE0681B	228	311	01/99	>	11/04				S 0VGT A
prefilter / prefiltrato	F2BE0681B	228	311	01/99	>	11/04		S 0999 NR		
power steering / servosterzo	F2BE0681B	228	311	01/99	>	11/04				S 3081 PO
260E34										
water filter / filtro acqua	8460.41K, 8460.41K E2	254	345	01/93	>	12/98				S 8410 AR
dryer filter / filtro essiccatore	8460.41K, 8460.41K E2	254	345	01/93	>	12/98				S 7259 A
assembly BOSCH / montaggio BOSCH	8460.41K, 8460.41K E2	254	345	01/93	>	12/98	S 5003 DR	S 5401 NR	S 7546 A	S 3055 C
assembly UFI / montaggio UFI	8460.41K, 8460.41K E2	254	345	01/93	>	12/98	S 5003 DR	S 4329 NR	S 7546 A	S 3055 C
or / oppure	8460.41K, 8460.41K E2	254	345	01/93	>	12/98	S 5003 DR	S 5400 NR	S 7546 A	S 3055 C
prefilter / prefiltrato	8460.41K, 8460.41K E2	254	345	01/93	>	12/98		S 0999 NR		
power steering / servosterzo	8460.41K, 8460.41K E2	254	345	01/93	>	12/98				S 3081 PO
260E35 Cursor 8	F2BE0681, F2BE0681A	259	353	01/99	>	11/04	S 3288 R	S 4396 NR	S 7546 A	S 3055 C
some BLOW-BY filter (504153481) / alcuni filtro BLOW-BY (504153481)	F2BE0681, F2BE0681A	259	353	01/99	>	11/04				S 7266 A
with automatic gearbox and hydraulic retarder ZF / con cambio automatico e rallentatore idraulico ZF	F2BE0681, F2BE0681A	259	353	01/99	>	11/04				S 2234 Z
dryer filter / filtro essiccatore	F2BE0681, F2BE0681A	259	353	01/99	>	11/04				S 7259 A
VGT filter / filtro VGT	F2BE0681, F2BE0681A	259	353	01/99	>	11/04				S 0VGT A
prefilter / prefiltrato	F2BE0681, F2BE0681A	259	353	01/99	>	11/04		S 0999 NR		
power steering / servosterzo	F2BE0681, F2BE0681A	259	353	01/99	>	11/04				S 3081 PO
260E37	8210.42K, 8210.42K E2	272	370	01/93	>	11/04	S 5003 DR	S 4329 NR	S 7546 A	S 3055 C
with automatic gearbox and hydraulic retarder ZF / con cambio automatico e rallentatore idraulico ZF	8210.42K, 8210.42K E2	272	370	01/93	>	11/04				S 2234 Z
dryer filter / filtro essiccatore	8210.42K, 8210.42K E2	272	370	01/93	>	11/04				S 7259 A
prefilter / prefiltrato	8210.42K, 8210.42K E2	272	370	01/93	>	11/04		S 0999 NR		
power steering / servosterzo	8210.42K, 8210.42K E2	272	370	01/93	>	11/04				S 3081 PO
260E38 Cursor 13	F3BE0681	280	382	01/00	>	11/04		S 4395 NR	S 7544 A	S 3055 C
some BLOW-BY filter (504153481) / alcuni filtro BLOW-BY (504153481)	F3BE0681	280	382	01/00	>	11/04				S 7266 A
dryer filter / filtro essiccatore	F3BE0681	280	382	01/00	>	11/04				S 7259 A
VGT filter / filtro VGT	F3BE0681	280	382	01/00	>	11/04				S 0VGT A
2 filters / N.2 filtri	F3BE0681	280	382	01/00	>	11/04	S 3288 R			
prefilter / prefiltrato	F3BE0681	280	382	01/00	>	11/04		S 0999 NR		
power steering / servosterzo	F3BE0681	280	382	01/00	>	11/04				S 3081 PO
260E42	8210.42L, 8210.42L E2	309	421	01/93	>	11/04	S 5003 DR	S 4329 NR	S 7546 A	S 3055 C
with automatic gearbox and hydraulic retarder ZF / con cambio automatico e rallentatore idraulico ZF	8210.42L, 8210.42L E2	309	421	01/93	>	11/04				S 2234 Z
dryer filter / filtro essiccatore	8210.42L, 8210.42L E2	309	421	01/93	>	11/04				S 7259 A
prefilter / prefiltrato	8210.42L, 8210.42L E2	309	421	01/93	>	11/04		S 0999 NR		
power steering / servosterzo	8210.42L, 8210.42L E2	309	421	01/93	>	11/04				S 3081 PO
260E44 Cursor 13	F3BE0681	324	442	01/00	>	11/04		S 4395 NR	S 7544 A	S 3055 C
some BLOW-BY filter (504153481) / alcuni filtro BLOW-BY (504153481)	F3BE0681	324	442	01/00	>	11/04				S 7266 A
dryer filter / filtro essiccatore	F3BE0681	324	442	01/00	>	11/04				S 7259 A
VGT filter / filtro VGT	F3BE0681	324	442	01/00	>	11/04				S 0VGT A
2 filters / N.2 filtri	F3BE0681	324	442	01/00	>	11/04	S 3288 R			
prefilter / prefiltrato	F3BE0681	324	442	01/00	>	11/04		S 0999 NR		
power steering / servosterzo	F3BE0681	324	442	01/00	>	11/04				S 3081 PO
260E47	8210.42M	345	470	01/00	>	11/04	S 5003 DR	S 4329 NR	S 7544 A	S 3055 C
dryer filter / filtro essiccatore	8210.42M	345	470	01/00	>	11/04				S 7259 A
prefilter / prefiltrato	8210.42M	345	470	01/00	>	11/04		S 0999 NR		
power steering / servosterzo	8210.42M	345	470	01/00	>	11/04				S 3081 PO
260E48 Cursor 13	F3BE0681	353	480	01/00	>	11/04		S 4395 NR	S 7544 A	S 3055 C
some BLOW-BY filter (504153481) / alcuni filtro BLOW-BY (504153481)	F3BE0681	353	480	01/00	>	11/04				S 7266 A
dryer filter / filtro essiccatore	F3BE0681	353	480	01/00	>	11/04				S 7259 A
VGT filter / filtro VGT	F3BE0681	353	480	01/00	>	11/04				S 0VGT A
2 filters / N.2 filtri	F3BE0681	353	480	01/00	>	11/04	S 3288 R			
prefilter / prefiltrato	F3BE0681	353	480	01/00	>	11/04		S 0999 NR		
power steering / servosterzo	F3BE0681	353	480	01/00	>	11/04				S 3081 PO
330E37	8210.42K	272	370	01/93	>	11/04	S 5003 DR	S 4329 NR	S 7546 A	S 3055 C
dryer filter / filtro essiccatore	8210.42K	272	370	01/93	>	11/04				S 7259 A
prefilter / prefiltrato	8210.42K	272	370	01/93	>	11/04		S 0999 NR		
power steering / servosterzo	8210.42K	272	370	01/93	>	11/04				S 3081 PO
340E34	8460.41K	254	345	01/94	>	03/99	S 5003 DR	S 4329 NR	S 7546 A	S 3055 C
water filter / filtro acqua	8460.41K	254	345	01/94	>	03/99				S 8410 AR
dryer filter / filtro essiccatore	8460.41K	254	345	01/94	>	03/99				S 7259 A



**KW HP****...IVECO - trucks/autocarri**

prefilter / prefiltrato	8460.41K	254	345	01/94	>	03/99		S 0999 NR			
power steering / servosterzo	8460.41K	254	345	01/94	>	03/99					S 8790 PO
340E34	8460.41K E2	254	345	01/94	>	03/99	S 5003 DR	S 4329 NR	S 7546 A		S 3055 C
some / alcuni	8460.41K E2	254	345	01/94	>	03/99	S 5003 DR	S 4329 NR	S 7546 A		S 3055 C
water filter / filtro acqua	8460.41K E2	254	345	01/94	>	03/99					S 8410 AR
dryer filter / filtro essiccatore	8460.41K E2	254	345	01/94	>	03/99					S 7259 A
prefilter / prefiltrato	8460.41K E2	254	345	01/94	>	03/99		S 0999 NR			
power steering / servosterzo	8460.41K E2	254	345	01/94	>	03/99					S 8790 PO
340E35 Cursor 8	F2BE0681, F2BE0681A	259	353	01/99	>	11/04	S 3288 R	S 4396 NR	S 7562 A		S 3055 C
some BLOW-BY filter (504153481) / alcuni filtro BLOW-BY (504153481)	F2BE0681, F2BE0681A	259	353	01/99	>	11/04					S 7266 A
with automatic gearbox and hydraulic retarder ZF / con cambio automatico e rallentatore idraulico ZF	F2BE0681, F2BE0681A	259	353	01/99	>	11/04					S 2234 Z
dryer filter / filtro essiccatore	F2BE0681, F2BE0681A	259	353	01/99	>	11/04					S 7259 A
VGT filter / filtro VGT	F2BE0681, F2BE0681A	259	353	01/99	>	11/04					S 0VGT A
prefilter / prefiltrato	F2BE0681, F2BE0681A	259	353	01/99	>	11/04		S 0999 NR			
power steering / servosterzo	F2BE0681, F2BE0681A	259	353	01/99	>	11/04					S 3081 PO
340E37	8210.42K	272	370	01/94	>	05/01	S 5003 DR	S 4329 NR	S 7546 A		S 3055 C
dryer filter / filtro essiccatore	8210.42K	272	370	01/94	>	05/01					S 7259 A
prefilter / prefiltrato	8210.42K	272	370	01/94	>	05/01		S 0999 NR			
power steering / servosterzo	8210.42K	272	370	01/94	>	05/01					S 8790 PO
340E37	8210.42K E2	272	370	01/94	>	05/01	S 5003 DR	S 4329 NR	S 7562 A		S 3055 C
dryer filter / filtro essiccatore	8210.42K E2	272	370	01/94	>	05/01					S 7259 A
prefilter / prefiltrato	8210.42K E2	272	370	01/94	>	05/01		S 0999 NR			
power steering / servosterzo	8210.42K E2	272	370	01/94	>	05/01					S 8790 PO
340E38 Cursor 13	F3BE0681	280	382	01/00	>	11/04		S 4395 NR	S 7562 A		S 3055 C
some BLOW-BY filter (504153481) / alcuni filtro BLOW-BY (504153481)	F3BE0681	280	382	01/00	>	11/04					S 7266 A
dryer filter / filtro essiccatore	F3BE0681	280	382	01/00	>	11/04					S 7259 A
VGT filter / filtro VGT	F3BE0681	280	382	01/00	>	11/04					S 0VGT A
2 filters / N.2 filtri	F3BE0681	280	382	01/00	>	11/04	S 3288 R				
prefilter / prefiltrato	F3BE0681	280	382	01/00	>	11/04		S 0999 NR			
power steering / servosterzo	F3BE0681	280	382	01/00	>	11/04					S 8790 PO
340E42	8210 TCA	308	420	01/95	>	11/04	S 5003 DR	S 4329 NR	S 7546 A		S 3055 C
dryer filter / filtro essiccatore	8210 TCA	308	420	01/95	>	11/04					S 7259 A
prefilter / prefiltrato	8210 TCA	308	420	01/95	>	11/04		S 0999 NR			
power steering / servosterzo	8210 TCA	308	420	01/95	>	11/04					S 8790 PO
340E42	8210.42L, 8210.42L E2	308	420	01/95	>	11/04	S 5003 DR	S 4329 NR	S 7546 A		S 3055 C
some / alcuni	8210.42L, 8210.42L E2	308	420	01/95	>	11/04	S 5003 DR	S 4329 NR	S 7562 A		S 3055 C
dryer filter / filtro essiccatore	8210.42L, 8210.42L E2	308	420	01/95	>	11/04					S 7259 A
prefilter / prefiltrato	8210.42L, 8210.42L E2	308	420	01/95	>	11/04		S 0999 NR			
power steering / servosterzo	8210.42L, 8210.42L E2	308	420	01/95	>	11/04					S 8790 PO
340E44 Cursor 13	F3BE0681	324	442	01/00	>	11/04		S 4395 NR	S 7562 A		S 3055 C
some BLOW-BY filter (504153481) / alcuni filtro BLOW-BY (504153481)	F3BE0681	324	442	01/00	>	11/04					S 7266 A
dryer filter / filtro essiccatore	F3BE0681	324	442	01/00	>	11/04					S 7259 A
VGT filter / filtro VGT	F3BE0681	324	442	01/00	>	11/04					S 0VGT A
prefilter / prefiltrato	F3BE0681	324	442	01/00	>	11/04		S 0999 NR			
power steering / servosterzo	F3BE0681	324	442	01/00	>	11/04					S 8790 PO
380E34	8460.41K, 8460.41K E2	254	345	01/93	>	11/04					S 8410 AR
dryer filter / filtro essiccatore	8460.41K, 8460.41K E2	254	345	01/93	>	11/04					S 7259 A
assembly BOSCH / montaggio BOSCH	8460.41K, 8460.41K E2	254	345	01/93	>	11/04	S 5003 DR	S 5401 NR	S 7546 A		S 3055 C
assembly UFI / montaggio UFI	8460.41K, 8460.41K E2	254	345	01/93	>	11/04	S 5003 DR	S 4329 NR	S 7546 A		S 3055 C
or / oppure	8460.41K, 8460.41K E2	254	345	01/93	>	11/04	S 5003 DR	S 5400 NR	S 7546 A		S 3055 C
prefilter / prefiltrato	8460.41K, 8460.41K E2	254	345	01/93	>	11/04		S 0999 NR			
power steering / servosterzo	8460.41K, 8460.41K E2	254	345	01/93	>	11/04					S 3081 PO
power steering / servosterzo	8460.41K, 8460.41K E2	254	345	01/93	>	11/04					S 8790 PO
380E35 Cursor 8	F2BE0681	259	353	01/99	>	11/04	S 3288 R	S 4396 NR	S 7546 A		S 3055 C
some BLOW-BY filter (504153481) / alcuni filtro BLOW-BY (504153481)	F2BE0681	259	353	01/99	>	11/04					S 7266 A
with automatic gearbox and hydraulic retarder ZF / con cambio automatico e rallentatore idraulico ZF	F2BE0681	259	353	01/99	>	11/04					S 2234 Z
dryer filter / filtro essiccatore	F2BE0681	259	353	01/99	>	11/04					S 7259 A
VGT filter / filtro VGT	F2BE0681	259	353	01/99	>	11/04					S 0VGT A
prefilter / prefiltrato	F2BE0681	259	353	01/99	>	11/04		S 0999 NR			
power steering / servosterzo	F2BE0681	259	353	01/99	>	11/04					S 3081 PO
380E37	8210.42K, 8210.42K E2	272	370	01/93	>	05/01	S 5003 DR	S 4329 NR	S 7546 A		S 3055 C
with automatic gearbox and hydraulic retarder ZF / con cambio automatico e rallentatore idraulico ZF	8210.42K, 8210.42K E2	272	370	01/93	>	05/01					S 2234 Z
outer / esterno	8210.42K, 8210.42K E2	272	370	01/93	>	05/01			S 7563 A		
dryer filter / filtro essiccatore	8210.42K, 8210.42K E2	272	370	01/93	>	05/01					S 7259 A
inner / interno	8210.42K, 8210.42K E2	272	370	01/93	>	05/01			S 7390 A		
prefilter / prefiltrato	8210.42K, 8210.42K E2	272	370	01/93	>	05/01		S 0999 NR			



...IVECO - trucks/autocarri

power steering / servosterzo	8210.42K, 8210.42K E2	272	370	01/93	>	05/01				S 3081 PO
power steering / servosterzo	8210.42K, 8210.42K E2	272	370	01/93	>	05/01				S 8790 PO
380E38 Cursor 13	F3BE0681	280	382	01/00	>	11/04				S 3055 C
some BLOW-BY filter (504153481) / alcuni filtro BLOW-BY (504153481)	F3BE0681	280	382	01/00	>	11/04				S 7266 A
dryer filter / filtro essiccatore	F3BE0681	280	382	01/00	>	11/04				S 7259 A
VGT filter / filtro VGT	F3BE0681	280	382	01/00	>	11/04				S 0VGT A
2 filters / N.2 filtri	F3BE0681	280	382	01/00	>	11/04	S 3288 R			
prefilter / prefiltra	F3BE0681	280	382	01/00	>	11/04		S 0999 NR		
power steering / servosterzo	F3BE0681	280	382	01/00	>	11/04				S 3081 PO
380E42	8210.42L, 8210.42L E2	309	421	01/93	>	05/01	S 5003 DR	S 4329 NR	S 7546 A	S 3055 C
dryer filter / filtro essiccatore	8210.42L, 8210.42L E2	309	421	01/93	>	05/01				S 7259 A
prefilter / prefiltra	8210.42L, 8210.42L E2	309	421	01/93	>	05/01		S 0999 NR		
power steering / servosterzo	8210.42L, 8210.42L E2	309	421	01/93	>	05/01				S 3081 PO
380E44 Cursor 13	F3BE0681	324	442	01/00	>	11/04		S 4395 NR	S 7562 A	S 3055 C
some / alcuni	F3BE0681	324	442	01/00	>	11/04		S 4395 NR	S 7544 A	S 3055 C
some / alcuni	F3BE0681	324	442	01/00	>	11/04		S 4395 NR	S 7563 A	S 3055 C
some BLOW-BY filter (504153481) / alcuni filtro BLOW-BY (504153481)	F3BE0681	324	442	01/00	>	11/04				S 7266 A
dryer filter / filtro essiccatore	F3BE0681	324	442	01/00	>	11/04				S 7259 A
VGT filter / filtro VGT	F3BE0681	324	442	01/00	>	11/04				S 0VGT A
2 filters / N.2 filtri	F3BE0681	324	442	01/00	>	11/04	S 3288 R			
prefilter / prefiltra	F3BE0681	324	442	01/00	>	11/04		S 0999 NR		
power steering / servosterzo	F3BE0681	324	442	01/00	>	11/04				S 3081 PO
380E48 Cursor 13	F3BE0681	353	480	01/00	>	11/04		S 4395 NR	S 7544 A	S 3055 C
some BLOW-BY filter (504153481) / alcuni filtro BLOW-BY (504153481)	F3BE0681	353	480	01/00	>	11/04				S 7266 A
dryer filter / filtro essiccatore	F3BE0681	353	480	01/00	>	11/04				S 7259 A
VGT filter / filtro VGT	F3BE0681	353	480	01/00	>	11/04				S 0VGT A
2 filters / N.2 filtri	F3BE0681	353	480	01/00	>	11/04	S 3288 R			
prefilter / prefiltra	F3BE0681	353	480	01/00	>	11/04		S 0999 NR		
power steering / servosterzo	F3BE0681	353	480	01/00	>	11/04				S 3081 PO
400E34										
water filter / filtro acqua	8460.41K	254	345	04/92	>	11/04				S 8410 AR
dryer filter / filtro essiccatore	8460.41K	254	345	04/92	>	11/04				S 7259 A
assembly BOSCH / montaggio BOSCH	8460.41K	254	345	04/92	>	11/04	S 5003 DR	S 5401 NR	S 7546 A	S 3055 C
assembly UFI / montaggio UFI	8460.41K	254	345	04/92	>	11/04	S 5003 DR	S 4329 NR	S 7546 A	S 3055 C
or / oppure	8460.41K	254	345	04/92	>	11/04	S 5003 DR	S 5400 NR	S 7546 A	S 3055 C
prefilter / prefiltra	8460.41K	254	345	04/92	>	11/04		S 0999 NR		
power steering / servosterzo	8460.41K	254	345	04/92	>	11/04				S 3081 PO
400E35 Cursor 8	F2BE0681	259	353	01/99	>	11/04	S 3288 R	S 4396 NR	S 7546 A	S 3055 C
some BLOW-BY filter (504153481) / alcuni filtro BLOW-BY (504153481)	F2BE0681	259	353	01/99	>	11/04				S 7266 A
with automatic gearbox and hydraulic retarder ZF / con cambio automatico e rallentatore idraulico ZF	F2BE0681	259	353	01/99	>	11/04				S 2234 Z
dryer filter / filtro essiccatore	F2BE0681	259	353	01/99	>	11/04				S 7259 A
VGT filter / filtro VGT	F2BE0681	259	353	01/99	>	11/04				S 0VGT A
prefilter / prefiltra	F2BE0681	259	353	01/99	>	11/04		S 0999 NR		
power steering / servosterzo	F2BE0681	259	353	01/99	>	11/04				S 3081 PO
400E37	8210.42K, 8210.42K E2	272	370	01/93	>	11/04	S 5003 DR	S 4329 NR	S 7546 A	S 3055 C
dryer filter / filtro essiccatore	8210.42K, 8210.42K E2	272	370	01/93	>	11/04				S 7259 A
prefilter / prefiltra	8210.42K, 8210.42K E2	272	370	01/93	>	11/04		S 0999 NR		
power steering / servosterzo	8210.42K, 8210.42K E2	272	370	01/93	>	11/04				S 3081 PO
400E38 Cursor 13	F3BE0681	280	382	01/00	>	11/04		S 4395 NR	S 7544 A	S 3055 C
some BLOW-BY filter (504153481) / alcuni filtro BLOW-BY (504153481)	F3BE0681	280	382	01/00	>	11/04				S 7266 A
dryer filter / filtro essiccatore	F3BE0681	280	382	01/00	>	11/04				S 7259 A
VGT filter / filtro VGT	F3BE0681	280	382	01/00	>	11/04				S 0VGT A
2 filters / N.2 filtri	F3BE0681	280	382	01/00	>	11/04	S 3288 R			
prefilter / prefiltra	F3BE0681	280	382	01/00	>	11/04		S 0999 NR		
power steering / servosterzo	F3BE0681	280	382	01/00	>	11/04				S 8790 PO
400E42	8210.42L, 8210.42L E2	309	420	04/92	>	11/04	S 5003 DR	S 4329 NR	S 7546 A	S 3055 C
dryer filter / filtro essiccatore	8210.42L, 8210.42L E2	309	420	04/92	>	11/04				S 7259 A
prefilter / prefiltra	8210.42L, 8210.42L E2	309	420	04/92	>	11/04		S 0999 NR		
power steering / servosterzo	8210.42L, 8210.42L E2	309	420	04/92	>	11/04				S 3081 PO
400E44 Cursor 13	F3BE0681	324	442	01/00	>	11/04		S 4395 NR	S 7544 A	S 3055 C
some BLOW-BY filter (504153481) / alcuni filtro BLOW-BY (504153481)	F3BE0681	324	442	01/00	>	11/04				S 7266 A
dryer filter / filtro essiccatore	F3BE0681	324	442	01/00	>	11/04				S 7259 A
VGT filter / filtro VGT	F3BE0681	324	442	01/00	>	11/04				S 0VGT A
2 filters / N.2 filtri	F3BE0681	324	442	01/00	>	11/04	S 3288 R			
prefilter / prefiltra	F3BE0681	324	442	01/00	>	11/04		S 0999 NR		
power steering / servosterzo	F3BE0681	324	442	01/00	>	11/04				S 3081 PO
410E35 Cursor 8	F2BE0681A	259	353	01/99	>	11/04	S 3288 R	S 4396 NR	S 7562 A	S 3055 C



**KW HP****...IVECO - trucks/autocarri**

some BLOW-BY filter (504153481) / alcuni filtro BLOW-BY (504153481)	F2BE0681A	259	353	01/99	>	11/04				S 7266 A
dryer filter / filtro essiccatore	F2BE0681A	259	353	01/99	>	11/04				S 7259 A
VGT filter / filtro VGT	F2BE0681A	259	353	01/99	>	11/04				S 0VGT A
prefilter / prefiltro	F2BE0681A	259	353	01/99	>	11/04		S 0999 NR		
power steering / servosterzo	F2BE0681A	259	353	01/99	>	11/04				S 8790 PO
410E37	8210.42K, 8210.42K E2	272	370	01/93	>	11/04	S 5003 DR	S 4329 NR	S 7546 A	S 3055 C
some / alcuni	8210.42K, 8210.42K E2	272	370	01/93	>	11/04	S 5003 DR	S 4329 NR	S 7562 A	S 3055 C
dryer filter / filtro essiccatore	8210.42K, 8210.42K E2	272	370	01/93	>	11/04				S 7259 A
prefilter / prefiltro	8210.42K, 8210.42K E2	272	370	01/93	>	11/04		S 0999 NR		
power steering / servosterzo	8210.42K, 8210.42K E2	272	370	01/93	>	11/04				S 8790 PO
410E38 Cursor 13	F3BE0681	280	382	01/00	>	11/04		S 4395 NR	S 7562 A	S 3055 C
some BLOW-BY filter (504153481) / alcuni filtro BLOW-BY (504153481)	F3BE0681	280	382	01/00	>	11/04				S 7266 A
dryer filter / filtro essiccatore	F3BE0681	280	382	01/00	>	11/04				S 7259 A
VGT filter / filtro VGT	F3BE0681	280	382	01/00	>	11/04				S 0VGT A
2 filters / N.2 filtri	F3BE0681	280	382	01/00	>	11/04	S 3288 R			
prefilter / prefiltro	F3BE0681	280	382	01/00	>	11/04		S 0999 NR		
power steering / servosterzo	F3BE0681	280	382	01/00	>	11/04				S 8790 PO
410E42	8210.42L, 8210.42L E2	309	420	04/92	>	11/04	S 5003 DR	S 4329 NR	S 7546 A	S 3055 C
some / alcuni	8210.42L, 8210.42L E2	309	420	04/92	>	11/04	S 5003 DR	S 4329 NR	S 7562 A	S 3055 C
dryer filter / filtro essiccatore	8210.42L, 8210.42L E2	309	420	04/92	>	11/04				S 7259 A
prefilter / prefiltro	8210.42L, 8210.42L E2	309	420	04/92	>	11/04		S 0999 NR		
power steering / servosterzo	8210.42L, 8210.42L E2	309	420	04/92	>	11/04				S 8790 PO
410E44 Cursor 13	F3BE0681	324	442	01/00	>	11/04		S 4395 NR	S 7562 A	S 3055 C
some BLOW-BY filter (504153481) / alcuni filtro BLOW-BY (504153481)	F3BE0681	324	442	01/00	>	11/04				S 7266 A
dryer filter / filtro essiccatore	F3BE0681	324	442	01/00	>	11/04				S 7259 A
VGT filter / filtro VGT	F3BE0681	324	442	01/00	>	11/04				S 0VGT A
2 filters / N.2 filtri	F3BE0681	324	442	01/00	>	11/04	S 3288 R			
prefilter / prefiltro	F3BE0681	324	442	01/00	>	11/04		S 0999 NR		
power steering / servosterzo	F3BE0681	324	442	01/00	>	11/04				S 8790 PO
410E48 Cursor 13	F3BE0681	353	480	01/00	>	11/04		S 4395 NR	S 7562 A	S 3055 C
some BLOW-BY filter (504153481) / alcuni filtro BLOW-BY (504153481)	F3BE0681	353	480	01/00	>	11/04				S 7266 A
dryer filter / filtro essiccatore	F3BE0681	353	480	01/00	>	11/04				S 7259 A
VGT filter / filtro VGT	F3BE0681	353	480	01/00	>	11/04				S 0VGT A
2 filters / N.2 filtri	F3BE0681	353	480	01/00	>	11/04	S 3288 R			
prefilter / prefiltro	F3BE0681	353	480	01/00	>	11/04		S 0999 NR		
power steering / servosterzo	F3BE0681	353	480	01/00	>	11/04				S 8790 PO
440E34	8460.41K	254	345	01/94	>	11/04	S 5003 DR	S 4329 NR	S 7546 A	S 3055 C
dryer filter / filtro essiccatore	8460.41K	254	345	01/94	>	11/04				S 7259 A
prefilter / prefiltro	8460.41K	254	345	01/94	>	11/04		S 0999 NR		
power steering / servosterzo	8460.41K	254	345	01/94	>	11/04				S 3081 PO
440E37	8210.42K, 8210.42K E2	276	376	01/93	>	11/04	S 5003 DR	S 4329 NR	S 7546 A	S 3055 C
dryer filter / filtro essiccatore	8210.42K, 8210.42K E2	276	376	01/93	>	11/04				S 7259 A
prefilter / prefiltro	8210.42K, 8210.42K E2	276	376	01/93	>	10/04		S 0999 NR		
power steering / servosterzo	8210.42K, 8210.42K E2	276	376	01/93	>	11/04				S 3081 PO
440E38 Cursor 13	F3BE0681	280	382	01/00	>	11/04		S 4395 NR	S 7544 A	S 3055 C
some BLOW-BY filter (504153481) / alcuni filtro BLOW-BY (504153481)	F3BE0681	280	382	01/00	>	11/04				S 7266 A
dryer filter / filtro essiccatore	F3BE0681	280	382	01/00	>	11/04				S 7259 A
VGT filter / filtro VGT	F3BE0681	280	382	01/00	>	11/04				S 0VGT A
2 filters / N.2 filtri	F3BE0681	280	382	01/00	>	11/04	S 3288 R			
prefilter / prefiltro	F3BE0681	280	382	01/00	>	11/04		S 0999 NR		
power steering / servosterzo	F3BE0681	280	382	01/00	>	11/04				S 8790 PO
440E42	8210.42L, 8210.42L E2	309	421	04/92	>	11/04	S 5003 DR	S 4329 NR	S 7546 A	S 3055 C
dryer filter / filtro essiccatore	8210.42L, 8210.42L E2	309	421	04/92	>	11/04				S 7259 A
prefilter / prefiltro	8210.42L, 8210.42L E2	309	421	04/92	>	11/04		S 0999 NR		
power steering / servosterzo	8210.42L, 8210.42L E2	309	421	04/92	>	11/04				S 3081 PO
720E37	8210.42K, 8210.42K E2	272	370	01/94	>	11/04	S 5003 DR	S 4329 NR	S 7546 A	S 3055 C
dryer filter / filtro essiccatore	8210.42K, 8210.42K E2	272	370	01/94	>	11/04				S 7259 A
prefilter / prefiltro	8210.42K, 8210.42K E2	272	370	01/94	>	11/04		S 0999 NR		
power steering / servosterzo	8210.42K, 8210.42K E2	272	370	01/94	>	11/04				S 3081 PO
power steering / servosterzo	8210.42K, 8210.42K E2	272	370	01/94	>	11/04				S 8790 PO
720E38 Cursor 13	F3BE0681	280	382	01/00	>	11/04		S 4395 NR	S 7544 A	S 3055 C
some BLOW-BY filter (504153481) / alcuni filtro BLOW-BY (504153481)	F3BE0681	280	382	01/00	>	11/04				S 7266 A
dryer filter / filtro essiccatore	F3BE0681	280	382	01/00	>	11/04				S 7259 A
VGT filter / filtro VGT	F3BE0681	280	382	01/00	>	11/04				S 0VGT A
2 filters / N.2 filtri	F3BE0681	280	382	01/00	>	11/04	S 3288 R			
prefilter / prefiltro	F3BE0681	280	382	01/00	>	11/04		S 0999 NR		
power steering / servosterzo	F3BE0681	280	382	01/00	>	11/04				S 3081 PO



...IVECO - trucks/autocarri

720E42	8210.42L	309 420	09/93 > 11/04	S 5003 DR	S 4329 NR	S 7546 A	S 3055 C
dryer filter / filtro essiccatore	8210.42L	309 420	09/93 > 11/04				S 7259 A
prefilter / prefiltra	8210.42L	309 420	09/93 > 11/04		S 0999 NR		
power steering / servosterzo	8210.42L	309 420	09/93 > 11/04				S 3081 PO
720E42	8210.42L E2	309 420	09/93 > 11/04	S 5003 DR	S 4329 NR	S 7546 A	S 3055 C
with automatic gearbox and hydraulic retarder ZF / con cambio automatico e rallentatore idraulico ZF	8210.42L E2	309 420	09/93 > 11/04				S 2234 Z
dryer filter / filtro essiccatore	8210.42L E2	309 420	09/93 > 11/04				S 7259 A
prefilter / prefiltra	8210.42L E2	309 420	09/93 > 11/04		S 0999 NR		
power steering / servosterzo	8210.42L E2	309 420	09/93 > 11/04				S 3081 PO
720E44 Cursor 13	F3BE0681	324 442	01/00 > 11/04		S 4395 NR	S 7544 A	S 3055 C
some BLOW-BY filter (504153481) / alcuni filtro BLOW-BY (504153481)	F3BE0681	324 442	01/00 > 11/04				S 7266 A
dryer filter / filtro essiccatore	F3BE0681	324 442	01/00 > 11/04				S 7259 A
VGT filter / filtro VGT	F3BE0681	324 442	01/00 > 11/04				S 0VGT A
2 filters / N.2 filtri	F3BE0681	324 442	01/00 > 11/04	S 3288 R			
prefilter / prefiltra	F3BE0681	324 442	01/00 > 11/04		S 0999 NR		
power steering / servosterzo	F3BE0681	324 442	01/00 > 11/04				S 3081 PO
720E47	8210.42M	356 470	01/00 > 11/04	S 5003 DR	S 4329 NR	S 7544 A	S 3055 C
with automatic gearbox and hydraulic retarder ZF / con cambio automatico e rallentatore idraulico ZF	8210.42M	356 470	01/00 > 11/04				S 2234 Z
dryer filter / filtro essiccatore	8210.42M	356 470	01/00 > 11/04				S 7259 A
prefilter / prefiltra	8210.42M	356 470	01/00 > 11/04		S 0999 NR		
power steering / servosterzo	8210.42M	356 470	01/00 > 11/04				S 3081 PO
720E48 Cursor 13	F3BE0681	353 480	01/00 > 11/04		S 4395 NR	S 7544 A	S 3055 C
some BLOW-BY filter (504153481) / alcuni filtro BLOW-BY (504153481)	F3BE0681	353 480	01/00 > 11/04				S 7266 A
dryer filter / filtro essiccatore	F3BE0681	353 480	01/00 > 11/04				S 7259 A
VGT filter / filtro VGT	F3BE0681	353 480	01/00 > 11/04				S 0VGT A
2 filters / N.2 filtri	F3BE0681	353 480	01/00 > 11/04	S 3288 R			
prefilter / prefiltra	F3BE0681	353 480	01/00 > 11/04		S 0999 NR		
power steering / servosterzo	F3BE0681	353 480	01/00 > 11/04				S 3081 PO
Orsetto							
L	804 A			S 9710 R	S 7111 NC	S 8760 A	
N	804 A			S 9710 R	S 7111 NC	S 8760 A	
Orsetto (1^ Serie)				S 0580 PO	S 4211 N	S 8760 A	
some / alcuni				S 0580 PO		S 8760 A	
Stralis							
260S40 Cursor 10	F3AE0681B	294 400	01/02 > 06/03		S 4395 NR	S 7544 A	S 3078 C
some BLOW-BY filter (504153481) / alcuni filtro BLOW-BY (504153481)	F3AE0681B	294 400	01/02 > 06/03				S 7266 A
dryer filter / filtro essiccatore	F3AE0681B	294 400	01/02 > 06/03				S 7259 A
VGT filter / filtro VGT	F3AE0681B	294 400	01/02 > 06/03				S 0VGT A
2 filters / N.2 filtri	F3AE0681B	294 400	01/02 > 06/03	S 3288 R			
prefilter / prefiltra	F3AE0681B	294 400	01/02 > 06/03		S 0999 NR		
power steering / servosterzo	F3AE0681B	294 400	01/02 > 06/03				S 3081 PO
power steering / servosterzo	F3AE0681B	294 400	01/02 > 06/03				S 8790 PO
260S43 Cursor 10	F3AE0681D	316 430	01/02 > 06/03		S 4395 NR	S 7544 A	S 3078 C
some BLOW-BY filter (504153481) / alcuni filtro BLOW-BY (504153481)	F3AE0681D	316 430	01/02 > 06/03				S 7266 A
dryer filter / filtro essiccatore	F3AE0681D	316 430	01/02 > 06/03				S 7259 A
VGT filter / filtro VGT	F3AE0681D	316 430	01/02 > 06/03				S 0VGT A
2 filters / N.2 filtri	F3AE0681D	316 430	01/02 > 06/03	S 3288 R			
prefilter / prefiltra	F3AE0681D	316 430	01/02 > 06/03		S 0999 NR		
power steering / servosterzo	F3AE0681D	316 430	01/02 > 06/03				S 3081 PO
power steering / servosterzo	F3AE0681D	316 430	01/02 > 06/03				S 8790 PO
260S44 Cursor 13	F3BE0681	324 440	01/02 > 06/03		S 4395 NR	S 7544 A	S 3078 C
some BLOW-BY filter (504153481) / alcuni filtro BLOW-BY (504153481)	F3BE0681	324 440	01/02 > 06/03				S 7266 A
dryer filter / filtro essiccatore	F3BE0681	324 440	01/02 > 06/03				S 7259 A
VGT filter / filtro VGT	F3BE0681	324 440	01/02 > 06/03				S 0VGT A
2 filters / N.2 filtri	F3BE0681	324 440	01/02 > 06/03	S 3288 R			
prefilter / prefiltra	F3BE0681	324 440	01/02 > 06/03		S 0999 NR		
power steering / servosterzo	F3BE0681	324 440	01/02 > 06/03				S 3081 PO
power steering / servosterzo	F3BE0681	324 440	01/02 > 06/03				S 8790 PO
260S48 Cursor 13	F3BE0681E	353 480	01/02 > 06/03		S 4395 NR	S 7544 A	S 3078 C
some BLOW-BY filter (504153481) / alcuni filtro BLOW-BY (504153481)	F3BE0681E	353 480	01/02 > 06/03				S 7266 A
dryer filter / filtro essiccatore	F3BE0681E	353 480	01/02 > 06/03				S 7259 A
VGT filter / filtro VGT	F3BE0681E	353 480	01/02 > 06/03				S 0VGT A
2 filters / N.2 filtri	F3BE0681E	353 480	01/02 > 06/03	S 3288 R			
prefilter / prefiltra	F3BE0681E	353 480	01/02 > 06/03		S 0999 NR		
power steering / servosterzo	F3BE0681E	353 480	01/02 > 06/03				S 3081 PO
power steering / servosterzo	F3BE0681E	353 480	01/02 > 06/03				S 8790 PO
260S54 Cursor 13	F3BE0681A	397 540	01/02 > 06/03		S 4395 NR	S 7544 A	S 3078 C



**KW HP****...IVECO - trucks/autocarri**

some BLOW-BY filter (504153481) / alcuni filtro BLOW-BY (504153481)	F3BE0681A	397	540	01/02	>	06/03				S 7266 A
dryer filter / filtro essiccatore	F3BE0681A	397	540	01/02	>	06/03				S 7259 A
VGT filter / filtro VGT	F3BE0681A	397	540	01/02	>	06/03				S 0VGT A
2 filters / N.2 filtri	F3BE0681A	397	540	01/02	>	06/03	S 3288 R			
prefilter / prefiltra	F3BE0681A	397	540	01/02	>	06/03		S 0999 NR		
power steering / servosterzo	F3BE0681A	397	540	01/02	>	06/03				S 8790 PO
440S40 Cursor 10	F3AE0681B	294	400	01/02	>	06/03		S 4395 NR	S 7544 A	S 3078 C
some BLOW-BY filter (504153481) / alcuni filtro BLOW-BY (504153481)	F3AE0681B	294	400	01/02	>	06/03				S 7266 A
dryer filter / filtro essiccatore	F3AE0681B	294	400	01/02	>	06/03				S 7259 A
VGT filter / filtro VGT	F3AE0681B	294	400	01/02	>	06/03				S 0VGT A
2 filters / N.2 filtri	F3AE0681B	294	400	01/02	>	06/03	S 3288 R			
prefilter / prefiltra	F3AE0681B	294	400	01/02	>	06/03		S 0999 NR		
power steering / servosterzo	F3AE0681B	294	400	01/02	>	06/03				S 3081 PO
440S43 Cursor 10	F3AE0681D	316	430	01/02	>	06/03		S 4395 NR	S 7544 A	S 3078 C
some BLOW-BY filter (504153481) / alcuni filtro BLOW-BY (504153481)	F3AE0681D	316	430	01/02	>	06/03				S 7266 A
dryer filter / filtro essiccatore	F3AE0681D	316	430	01/02	>	06/03				S 7259 A
VGT filter / filtro VGT	F3AE0681D	316	430	01/02	>	06/03				S 0VGT A
2 filters / N.2 filtri	F3AE0681D	316	430	01/02	>	06/03	S 3288 R			
prefilter / prefiltra	F3AE0681D	316	430	01/02	>	06/03		S 0999 NR		
power steering / servosterzo	F3AE0681D	316	430	01/02	>	06/03				S 3081 PO
440S48 Cursor 13	F3BE0681E	353	480	01/02	>	06/03		S 4395 NR	S 7544 A	S 3078 C
some BLOW-BY filter (504153481) / alcuni filtro BLOW-BY (504153481)	F3BE0681E	353	480	01/02	>	06/03				S 7266 A
dryer filter / filtro essiccatore	F3BE0681E	353	480	01/02	>	06/03				S 7259 A
VGT filter / filtro VGT	F3BE0681E	353	480	01/02	>	06/03				S 0VGT A
2 filters / N.2 filtri	F3BE0681E	353	480	01/02	>	06/03	S 3288 R			
prefilter / prefiltra	F3BE0681E	353	480	01/02	>	06/03		S 0999 NR		
power steering / servosterzo	F3BE0681E	353	480	01/02	>	06/03				S 3081 PO
440S54 Cursor 13	F3BE0681A	397	540	01/02	>	06/03		S 4395 NR	S 7544 A	S 3078 C
some BLOW-BY filter (504153481) / alcuni filtro BLOW-BY (504153481)	F3BE0681A	397	540	01/02	>	06/03				S 7266 A
dryer filter / filtro essiccatore	F3BE0681A	397	540	01/02	>	06/03				S 7259 A
VGT filter / filtro VGT	F3BE0681A	397	540	01/02	>	06/03				S 0VGT A
2 filters / N.2 filtri	F3BE0681A	397	540	01/02	>	06/03	S 3288 R			
prefilter / prefiltra	F3BE0681A	397	540	01/02	>	06/03		S 0999 NR		
power steering / servosterzo	F3BE0681A	397	540	01/02	>	06/03				S 3081 PO
Stralis AD										
190S27 Cursor 8	F2BE0681/F2BE0681C	200	272	06/03	>	09/04	S 3288 R	S 4396 NR	S 7546 A	S 3078 C
	F2BE0681/F2BE0681C	200	272	10/04	>		S 3288 R	S 4396 NR	S 7600 A	S 3078 C
some BLOW-BY filter (504153481) / alcuni filtro BLOW-BY (504153481)	F2BE0681/F2BE0681C	200	272	06/03	>					S 7266 A
dryer filter / filtro essiccatore	F2BE0681/F2BE0681C	200	272	06/03	>					S 7259 A
VGT filter / filtro VGT	F2BE0681/F2BE0681C	200	272	06/03	>					S 0VGT A
prefilter / prefiltra	F2BE0681/F2BE0681C	200	272	06/03	>	01/04		S 0999 NR		
prefilter / prefiltra	F2BE0681/F2BE0681C	200	272	01/04	>			S 1999 NR		
power steering / servosterzo	F2BE0681/F2BE0681C	200	272	06/03	>					S 3081 PO
190S27 Cursor8 CNG/Metano	F2BE0641G	200	272	04/07	>		S 3288 R	✗	S 7600 A	S 3078 C
some BLOW-BY filter (504153481) / alcuni filtro BLOW-BY (504153481)	F2BE0641G	200	272	04/07	>					S 7266 A
dryer filter / filtro essiccatore	F2BE0641G	200	272	04/07	>					S 7259 A
power steering / servosterzo	F2BE0641G	200	272	04/07	>					S 8790 PO
190S30 Cursor8 CNG/Metano	F2BE0641K	221	300	04/07	>		S 3288 R	✗	S 7600 A	S 3078 C
some BLOW-BY filter (504153481) / alcuni filtro BLOW-BY (504153481)	F2BE0641K	221	300	04/07	>					S 7266 A
dryer filter / filtro essiccatore	F2BE0641K	221	300	04/07	>					S 7259 A
power steering / servosterzo	F2BE0641K	221	300	04/07	>					S 8790 PO
190S31 Cursor 8	F2BE0681/F2BE0681B	228	310	06/03	>	09/04	S 3288 R	S 4396 NR	S 7546 A	S 3078 C
	F2BE0681/F2BE0681B	228	310	10/04	>		S 3288 R	S 4396 NR	S 7600 A	S 3078 C
some BLOW-BY filter (504153481) / alcuni filtro BLOW-BY (504153481)	F2BE0681/F2BE0681B	228	310	06/03	>					S 7266 A
dryer filter / filtro essiccatore	F2BE0681/F2BE0681B	228	310	06/03	>					S 7259 A
VGT filter / filtro VGT	F2BE0681/F2BE0681B	228	310	06/03	>					S 0VGT A
prefilter / prefiltra	F2BE0681/F2BE0681B	228	310	06/03	>	01/04		S 0999 NR		
prefilter / prefiltra	F2BE0681/F2BE0681B	228	310	01/04	>			S 1999 NR		
power steering / servosterzo	F2BE0681/F2BE0681B	228	310	06/03	>					S 3081 PO
190S31 Cursor9 E6	F2CFE611	228	310	01/13	>		S 5102 PE	S 6043 NE		
190S33 Cursor 8	F2BE3681B	243	330	03/06	>		S 3288 R	S 4396 NR	S 7600 A	S 3078 C
some BLOW-BY filter (504153481) / alcuni filtro BLOW-BY (504153481)	F2BE3681B	243	330	03/06	>					S 7266 A
with automatic gearbox and hydraulic retarder ZF Ecosplit + Intarder / con cambio automatico e rallentatore idraulico ZF Ecosplit + Intarder	F2BE3681B	243	330	03/06	>					S 2234 Z
with filter Urea/Adblue / con filtro Urea/Adblue	F2BE3681B	243	330	03/06	>					S 4401 U
dryer filter / filtro essiccatore	F2BE3681B	243	330	03/06	>					S 7259 A
VGT filter / filtro VGT	F2BE3681B	243	330	03/06	>					S 0VGT A
prefilter / prefiltra	F2BE3681B	243	330	03/06	>			S 1999 NR		

**KW HP****...IVECO - trucks/autocarri**

power steering / servosterzo	F2BE3681B	243	330	03/06	>				S 3081 PO
190S33 Cursor8 CNG/Metano	F2BE0641D	243	330	04/07	>	S 3288 R	✗	S 7600 A	S 3078 C
some BLOW-BY filter (504153481) / alcuni filtro BLOW-BY (504153481)	F2BE0641D	243	330	04/07	>				S 7266 A
dryer filter / filtro essiccatore	F2BE0641D	243	330	04/07	>				S 7259 A
power steering / servosterzo	F2BE0641D	243	330	04/07	>				S 8790 PO
190S35 Cursor 8	F2BE0681/F2BE0681A	259	352	06/03	> 09/04	S 3288 R	S 4396 NR	S 7546 A	S 3078 C
	F2BE0681/F2BE0681A	259	352	10/04	>	S 3288 R	S 4396 NR	S 7600 A	S 3078 C
some BLOW-BY filter (504153481) / alcuni filtro BLOW-BY (504153481)	F2BE0681/F2BE0681A	259	352	06/03	>				S 7266 A
dryer filter / filtro essiccatore	F2BE0681/F2BE0681A	259	352	06/03	>				S 7259 A
VGT filter / filtro VGT	F2BE0681/F2BE0681A	259	352	06/03	>				S 0VGT A
prefilter / prefiltra	F2BE0681/F2BE0681A	259	352	06/03	> 01/04		S 0999 NR		
prefilter / prefiltra	F2BE0681/F2BE0681A	259	352	01/04	>		S 1999 NR		
power steering / servosterzo	F2BE0681/F2BE0681A	259	352	06/03	>				S 3081 PO
190S36 Cursor 8	F2BE3681A	265	360	03/06	>	S 3288 R	S 4396 NR	S 7600 A	S 3078 C
some BLOW-BY filter (504153481) / alcuni filtro BLOW-BY (504153481)	F2BE3681A	265	360	03/06	>				S 7266 A
with automatic gearbox and hydraulic retarder ZF Ecosplit + Intarder / con cambio automatico e rallentatore idraulico ZF Ecosplit + Intarder	F2BE3681A	265	360	03/06	>				S 2234 Z
with filter Urea/Adblue / con filtro Urea/Adblue	F2BE3681A	265	360	03/06	>				S 4401 U
dryer filter / filtro essiccatore	F2BE3681A	265	360	03/06	>				S 7259 A
VGT filter / filtro VGT	F2BE3681A	265	360	03/06	>				S 0VGT A
prefilter / prefiltra	F2BE3681A	265	360	03/06	>		S 1999 NR		
power steering / servosterzo	F2BE3681A	265	360	03/06	>				S 3081 PO
190S40 Cursor 10	F3AE0681/F3AE0681B	294	400	06/03	> 09/04		S 4395 NR	S 7544 A	S 3078 C
	F3AE0681/F3AE0681B	294	400	10/04	>		S 4395 NR	S 7600 A	S 3078 C
some BLOW-BY filter (504153481) / alcuni filtro BLOW-BY (504153481)	F3AE0681/F3AE0681B	294	400	06/03	>				S 7266 A
dryer filter / filtro essiccatore	F3AE0681/F3AE0681B	294	400	06/03	>				S 7259 A
VGT filter / filtro VGT	F3AE0681/F3AE0681B	294	400	06/03	>				S 0VGT A
2 filters / N.2 filtri	F3AE0681/F3AE0681B	294	400	06/03	>	S 3288 R			
prefilter / prefiltra	F3AE0681/F3AE0681B	294	400	06/03	> 01/04		S 0999 NR		
prefilter / prefiltra	F3AE0681/F3AE0681B	294	400	01/04	>		S 1999 NR		
power steering / servosterzo	F3AE0681/F3AE0681B	294	400	06/03	>				S 3081 PO
190S42 Cursor 10	F3AE3681D	309	420	03/06	> 05/07		S 1395 NR	S 7600 A	S 3078 C
	F3AE3681D	309	420	06/07	>	S 5087 OC	S 1395 NR	S 7600 A	S 3078 C
some BLOW-BY filter (504153481) / alcuni filtro BLOW-BY (504153481)	F3AE3681D	309	420	03/06	>				S 7266 A
with automatic gearbox and hydraulic retarder ZF Ecosplit + Intarder / con cambio automatico e rallentatore idraulico ZF Ecosplit + Intarder	F3AE3681D	309	420	03/06	>				S 2234 Z
with filter Urea/Adblue / con filtro Urea/Adblue	F3AE3681D	309	420	03/06	>				S 4401 U
dryer filter / filtro essiccatore	F3AE3681D	309	420	03/06	>				S 7259 A
VGT filter / filtro VGT	F3AE3681D	309	420	03/06	>				S 0VGT A
2 filters / N.2 filtri	F3AE3681D	309	420	03/06	> 05/07	S 3288 R			
prefilter / prefiltra	F3AE3681D	309	420	03/06	>		S 1999 NR		
power steering / servosterzo	F3AE3681D	309	420	03/06	>				S 3081 PO
spare part only 150.000 km / solo ricambio 150.000 km	F3AE3681D	309	420	10/11	>	S 5111 PE			
190S43 Cursor 10	F3AE0681D	316	430	06/03	> 09/04		S 4395 NR	S 7544 A	S 3078 C
	F3AE0681D	316	430	10/04	>		S 4395 NR	S 7600 A	S 3078 C
some BLOW-BY filter (504153481) / alcuni filtro BLOW-BY (504153481)	F3AE0681D	316	430	06/03	>				S 7266 A
dryer filter / filtro essiccatore	F3AE0681D	316	430	06/03	>				S 7259 A
VGT filter / filtro VGT	F3AE0681D	316	430	06/03	>				S 0VGT A
2 filters / N.2 filtri	F3AE0681D	316	430	06/03	>	S 3288 R			
prefilter / prefiltra	F3AE0681D	316	430	06/03	> 01/04		S 0999 NR		
prefilter / prefiltra	F3AE0681D	316	430	01/04	>		S 1999 NR		
power steering / servosterzo	F3AE0681D	316	430	06/03	>				S 8790 PO
power steering / servosterzo	F3AE0681D	316	430	06/03	>				S 3081 PO
190S45 Cursor 10	F3AE3681A	331	450	03/06	> 05/07		S 1395 NR	S 7600 A	S 3078 C
	F3AE3681A	331	450	06/07	>	S 5087 OC	S 1395 NR	S 7600 A	S 3078 C
some BLOW-BY filter (504153481) / alcuni filtro BLOW-BY (504153481)	F3AE3681A	331	450	03/06	>				S 7266 A
with automatic gearbox and hydraulic retarder ZF Ecosplit + Intarder / con cambio automatico e rallentatore idraulico ZF Ecosplit + Intarder	F3AE3681A	331	450	03/06	>				S 2234 Z
with filter Urea/Adblue / con filtro Urea/Adblue	F3AE3681A	331	450	03/06	>				S 4401 U
dryer filter / filtro essiccatore	F3AE3681A	331	450	03/06	>				S 7259 A
VGT filter / filtro VGT	F3AE3681A	331	450	03/06	>				S 0VGT A
2 filters / N.2 filtri	F3AE3681A	331	450	03/06	> 05/07	S 3288 R			
prefilter / prefiltra	F3AE3681A	331	450	03/06	>		S 1999 NR		
power steering / servosterzo	F3AE3681A	331	450	03/06	>				S 3081 PO
spare part only 150.000 km / solo ricambio 150.000 km	F3AE3681A	331	450	10/11	>	S 5111 PE			
260S27 Cursor 8	F2BE0681/F2BE0681C	200	272	06/03	> 09/04	S 3288 R	S 4396 NR	S 7546 A	S 3078 C
	F2BE0681/F2BE0681C	200	272	10/04	>	S 3288 R	S 4396 NR	S 7600 A	S 3078 C
some BLOW-BY filter (504153481) / alcuni filtro BLOW-BY (504153481)	F2BE0681/F2BE0681C	200	272	06/03	>				S 7266 A
dryer filter / filtro essiccatore	F2BE0681/F2BE0681C	200	272	06/03	>				S 7259 A
VGT filter / filtro VGT	F2BE0681/F2BE0681C	200	272	06/03	>				S 0VGT A





...IVECO - trucks/autocarri

prefilter / prefiltra	F2BE0681/F2BE0681C	200	272	06/03	>	01/04		S 0999 NR		
prefilter / prefiltra	F2BE0681/F2BE0681C	200	272	01/04	>			S 1999 NR		
power steering / servosterzo	F2BE0681/F2BE0681C	200	272	06/03	>					S 3081 PO
power steering / servosterzo	F2BE0681/F2BE0681C	200	272	06/03	>					S 8790 PO
260S27 Cursor8 CNG/Metano	F2BE0641G	200	272	04/07	>		S 3288 R	✗	S 7600 A	S 3078 C
some BLOW-BY filter (504153481) / alcuni filtro BLOW-BY (504153481)	F2BE0641G	200	272	04/07	>					S 7266 A
dryer filter / filtro essiccatore	F2BE0641G	200	272	04/07	>					S 7259 A
power steering / servosterzo	F2BE0641G	200	272	04/07	>					S 8790 PO
260S30 Cursor8 CNG/Metano	F2BE0641K	221	300	04/07	>		S 3288 R	✗	S 7600 A	S 3078 C
some BLOW-BY filter (504153481) / alcuni filtro BLOW-BY (504153481)	F2BE0641K	221	300	04/07	>					S 7266 A
dryer filter / filtro essiccatore	F2BE0641K	221	300	04/07	>					S 7259 A
power steering / servosterzo	F2BE0641K	221	300	04/07	>					S 8790 PO
260S31 Cursor 8	F2BE0681/F2BE0681B	228	310	06/03	>	09/04	S 3288 R		S 4396 NR	S 7546 A
	F2BE0681/F2BE0681B	228	310	10/04	>		S 3288 R		S 4396 NR	S 7600 A
some BLOW-BY filter (504153481) / alcuni filtro BLOW-BY (504153481)	F2BE0681/F2BE0681B	228	310	06/03	>					S 7266 A
dryer filter / filtro essiccatore	F2BE0681/F2BE0681B	228	310	06/03	>					S 7259 A
VGT filter / filtro VGT	F2BE0681/F2BE0681B	228	310	06/03	>					S 0VGT A
prefilter / prefiltra	F2BE0681/F2BE0681B	228	310	06/03	>	01/04		S 0999 NR		
prefilter / prefiltra	F2BE0681/F2BE0681B	228	310	01/04	>			S 1999 NR		
power steering / servosterzo	F2BE0681/F2BE0681B	228	310	06/03	>					S 3081 PO
power steering / servosterzo	F2BE0681/F2BE0681B	228	310	06/03	>					S 8790 PO
260S33 Cursor 8	F2BE3681B	243	330	03/06	>		S 3288 R		S 4396 NR	S 7600 A
some BLOW-BY filter (504153481) / alcuni filtro BLOW-BY (504153481)	F2BE3681B	243	330	03/06	>					S 7266 A
with automatic gearbox and hydraulic retarder ZF Ecosplit + Intarder / con cambio automatico e rallentatore idraulico ZF Ecosplit + Intarder	F2BE3681B	243	330	03/06	>					S 2234 Z
with filter Urea/Adblue / con filtro Urea/Adblue	F2BE3681B	243	330	03/06	>					S 4401 U
dryer filter / filtro essiccatore	F2BE3681B	243	330	03/06	>					S 7259 A
VGT filter / filtro VGT	F2BE3681B	243	330	03/06	>					S 0VGT A
prefilter / prefiltra	F2BE3681B	243	330	03/06	>			S 1999 NR		
power steering / servosterzo	F2BE3681B	243	330	03/06	>					S 3081 PO
260S33 Cursor8 CNG/Metano	F2BE0641D	243	330	04/07	>		S 3288 R	✗	S 7600 A	S 3078 C
some BLOW-BY filter (504153481) / alcuni filtro BLOW-BY (504153481)	F2BE0641D	243	330	04/07	>					S 7266 A
dryer filter / filtro essiccatore	F2BE0641D	243	330	04/07	>					S 7259 A
power steering / servosterzo	F2BE0641D	243	330	04/07	>					S 8790 PO
260S35 Cursor 8	F2BE0681/F2BE0681A	259	352	06/03	>	09/04	S 3288 R		S 4396 NR	S 7546 A
	F2BE0681/F2BE0681A	259	352	10/04	>		S 3288 R		S 4396 NR	S 7600 A
some BLOW-BY filter (504153481) / alcuni filtro BLOW-BY (504153481)	F2BE0681/F2BE0681A	259	352	06/03	>					S 7266 A
dryer filter / filtro essiccatore	F2BE0681/F2BE0681A	259	352	06/03	>					S 7259 A
VGT filter / filtro VGT	F2BE0681/F2BE0681A	259	352	06/03	>					S 0VGT A
prefilter / prefiltra	F2BE0681/F2BE0681A	259	352	06/03	>	01/04		S 0999 NR		
prefilter / prefiltra	F2BE0681/F2BE0681A	259	352	01/04	>			S 1999 NR		
power steering / servosterzo	F2BE0681/F2BE0681A	259	352	06/03	>					S 8790 PO
power steering / servosterzo	F2BE0681/F2BE0681A	259	352	06/03	>					S 3081 PO
260S36 Cursor 8	F2BE3681A	265	360	03/06	>		S 3288 R		S 4396 NR	S 7600 A
some BLOW-BY filter (504153481) / alcuni filtro BLOW-BY (504153481)	F2BE3681A	265	360	03/06	>					S 7266 A
with automatic gearbox and hydraulic retarder ZF Ecosplit + Intarder / con cambio automatico e rallentatore idraulico ZF Ecosplit + Intarder	F2BE3681A	265	360	03/06	>					S 2234 Z
with filter Urea/Adblue / con filtro Urea/Adblue	F2BE3681A	265	360	03/06	>					S 4401 U
dryer filter / filtro essiccatore	F2BE3681A	265	360	03/06	>					S 7259 A
VGT filter / filtro VGT	F2BE3681A	265	360	03/06	>					S 0VGT A
prefilter / prefiltra	F2BE3681A	265	360	03/06	>			S 1999 NR		
power steering / servosterzo	F2BE3681A	265	360	03/06	>					S 3081 PO
260S40 Cursor 10	F3AE0681/F3AE0681B	294	400	06/03	>	09/04		S 4395 NR	S 7544 A	S 3078 C
	F3AE0681/F3AE0681B	294	400	10/04	>			S 4395 NR	S 7600 A	S 3078 C
some BLOW-BY filter (504153481) / alcuni filtro BLOW-BY (504153481)	F3AE0681/F3AE0681B	294	400	06/03	>					S 7266 A
dryer filter / filtro essiccatore	F3AE0681/F3AE0681B	294	400	06/03	>					S 7259 A
VGT filter / filtro VGT	F3AE0681/F3AE0681B	294	400	06/03	>					S 0VGT A
2 filters / N.2 filtri	F3AE0681/F3AE0681B	294	400	06/03	>		S 3288 R			
prefilter / prefiltra	F3AE0681/F3AE0681B	294	400	06/03	>	01/04		S 0999 NR		
prefilter / prefiltra	F3AE0681/F3AE0681B	294	400	01/04	>			S 1999 NR		
power steering / servosterzo	F3AE0681/F3AE0681B	294	400	06/03	>					S 8790 PO
power steering / servosterzo	F3AE0681/F3AE0681B	294	400	06/03	>					S 3081 PO
260S42 Cursor 10	F3AE3681D	309	420	03/06	>	05/07		S 1395 NR	S 7600 A	S 3078 C
	F3AE3681D	309	420	06/07	>		S 5087 OC	S 1395 NR	S 7600 A	S 3078 C
some BLOW-BY filter (504153481) / alcuni filtro BLOW-BY (504153481)	F3AE3681D	309	420	03/06	>					S 7266 A
with automatic gearbox and hydraulic retarder ZF Ecosplit + Intarder / con cambio automatico e rallentatore idraulico ZF Ecosplit + Intarder	F3AE3681D	309	420	03/06	>					S 2234 Z
with filter Urea/Adblue / con filtro Urea/Adblue	F3AE3681D	309	420	03/06	>					S 4401 U
dryer filter / filtro essiccatore	F3AE3681D	309	420	03/06	>					S 7259 A
VGT filter / filtro VGT	F3AE3681D	309	420	03/06	>					S 0VGT A

**KW HP****...IVECO - trucks/autocarri**

2 filters / N.2 filtri	F3AE3681D	309	420	03/06 >	05/07	S 3288 R			
prefilter / prefiltra	F3AE3681D	309	420	03/06 >			S 1999 NR		
power steering / servosterzo	F3AE3681D	309	420	03/06 >					S 3081 PO
spare part only 150.000 km / solo ricambio 150.000 km	F3AE3681D	309	420	10/11 >		S 5111 PE			
260S43 Cursor 10	F3AE0681D	316	430	06/03 >	09/04		S 4395 NR	S 7544 A	S 3078 C
	F3AE0681D	316	430	10/04 >			S 4395 NR	S 7600 A	S 3078 C
some BLOW-BY filter (504153481) / alcuni filtro BLOW-BY (504153481)	F3AE0681D	316	430	06/03 >					S 7266 A
dryer filter / filtro essiccatore	F3AE0681D	316	430	06/03 >					S 7259 A
VGT filter / filtro VGT	F3AE0681D	316	430	06/03 >					S 0VGT A
2 filters / N.2 filtri	F3AE0681D	316	430	06/03 >		S 3288 R			
prefilter / prefiltra	F3AE0681D	316	430	06/03 >	01/04		S 0999 NR		
prefilter / prefiltra	F3AE0681D	316	430	01/04 >			S 1999 NR		
power steering / servosterzo	F3AE0681D	316	430	06/03 >					S 8790 PO
power steering / servosterzo	F3AE0681D	316	430	06/03 >					S 3081 PO
260S45 Cursor 10	F3AE3681A	331	450	03/06 >	05/07		S 1395 NR	S 7600 A	S 3078 C
	F3AE3681A	331	450	06/07 >		S 5087 OC	S 1395 NR	S 7600 A	S 3078 C
some BLOW-BY filter (504153481) / alcuni filtro BLOW-BY (504153481)	F3AE3681A	331	450	03/06 >					S 7266 A
with automatic gearbox and hydraulic retarder ZF Ecosplit + Intarder / con cambio automatico e rallentatore idraulico ZF Ecosplit + Intarder	F3AE3681A	331	450	03/06 >					S 2234 Z
with filter Urea/Adblue / con filtro Urea/Adblue	F3AE3681A	331	450	03/06 >					S 4401 U
dryer filter / filtro essiccatore	F3AE3681A	331	450	03/06 >					S 7259 A
VGT filter / filtro VGT	F3AE3681A	331	450	03/06 >					S 0VGT A
2 filters / N.2 filtri	F3AE3681A	331	450	03/06 >	05/07	S 3288 R			
prefilter / prefiltra	F3AE3681A	331	450	03/06 >			S 1999 NR		
power steering / servosterzo	F3AE3681A	331	450	03/06 >					S 3081 PO
spare part only 150.000 km / solo ricambio 150.000 km	F3AE3681A	331	450	10/11 >		S 5111 PE			
440S31 Cursor 8	F2BE0681/F2BE0681B	228	310	06/03 >	09/04	S 3288 R	S 4396 NR	S 7546 A	S 3078 C
	F2BE0681/F2BE0681B	228	310	10/04 >		S 3288 R	S 4396 NR	S 7600 A	S 3078 C
some BLOW-BY filter (504153481) / alcuni filtro BLOW-BY (504153481)	F2BE0681/F2BE0681B	228	310	06/03 >					S 7266 A
dryer filter / filtro essiccatore	F2BE0681/F2BE0681B	228	310	06/03 >					S 7259 A
VGT filter / filtro VGT	F2BE0681/F2BE0681B	228	310	06/03 >					S 0VGT A
prefilter / prefiltra	F2BE0681/F2BE0681B	228	310	06/03 >	01/04		S 0999 NR		
prefilter / prefiltra	F2BE0681/F2BE0681B	228	310	01/04 >			S 1999 NR		
power steering / servosterzo	F2BE0681/F2BE0681B	228	310	06/03 >					S 3081 PO
440S33 Cursor 8	F2BE3681B	243	330	03/06 >		S 3288 R	S 4396 NR	S 7600 A	S 3078 C
some BLOW-BY filter (504153481) / alcuni filtro BLOW-BY (504153481)	F2BE3681B	243	330	03/06 >					S 7266 A
with automatic gearbox and hydraulic retarder ZF Ecosplit + Intarder / con cambio automatico e rallentatore idraulico ZF Ecosplit + Intarder	F2BE3681B	243	330	03/06 >					S 2234 Z
with filter Urea/Adblue / con filtro Urea/Adblue	F2BE3681B	243	330	03/06 >					S 4401 U
dryer filter / filtro essiccatore	F2BE3681B	243	330	03/06 >					S 7259 A
VGT filter / filtro VGT	F2BE3681B	243	330	03/06 >					S 0VGT A
prefilter / prefiltra	F2BE3681B	243	330	03/06 >			S 1999 NR		
power steering / servosterzo	F2BE3681B	243	330	03/06 >					S 3081 PO
440S33 Cursor8 CNG/Metano	F2BE0641D	243	330	04/07 >		S 3288 R	✗	S 7600 A	S 3078 C
some BLOW-BY filter (504153481) / alcuni filtro BLOW-BY (504153481)	F2BE0641D	243	330	04/07 >					S 7266 A
dryer filter / filtro essiccatore	F2BE0641D	243	330	04/07 >					S 7259 A
power steering / servosterzo	F2BE0641D	243	330	04/07 >					S 8790 PO
440S35 Cursor 8	F2BE0681/F2BE0681A	259	352	06/03 >	09/04	S 3288 R	S 4396 NR	S 7546 A	S 3078 C
	F2BE0681/F2BE0681A	259	352	10/04 >		S 3288 R	S 4396 NR	S 7600 A	S 3078 C
some BLOW-BY filter (504153481) / alcuni filtro BLOW-BY (504153481)	F2BE0681/F2BE0681A	259	352	06/03 >					S 7266 A
dryer filter / filtro essiccatore	F2BE0681/F2BE0681A	259	352	06/03 >					S 7259 A
VGT filter / filtro VGT	F2BE0681/F2BE0681A	259	352	06/03 >					S 0VGT A
prefilter / prefiltra	F2BE0681/F2BE0681A	259	352	06/03 >	01/04		S 0999 NR		
prefilter / prefiltra	F2BE0681/F2BE0681A	259	352	01/04 >			S 1999 NR		
power steering / servosterzo	F2BE0681/F2BE0681A	259	352	06/03 >					S 3081 PO
440S36 Cursor 8	F2BE3681A	265	360	03/06 >		S 3288 R	S 4396 NR	S 7600 A	S 3078 C
some BLOW-BY filter (504153481) / alcuni filtro BLOW-BY (504153481)	F2BE3681A	265	360	03/06 >					S 7266 A
with automatic gearbox and hydraulic retarder ZF Ecosplit + Intarder / con cambio automatico e rallentatore idraulico ZF Ecosplit + Intarder	F2BE3681A	265	360	03/06 >					S 2234 Z
with filter Urea/Adblue / con filtro Urea/Adblue	F2BE3681A	265	360	03/06 >					S 4401 U
dryer filter / filtro essiccatore	F2BE3681A	265	360	03/06 >					S 7259 A
VGT filter / filtro VGT	F2BE3681A	265	360	03/06 >					S 0VGT A
prefilter / prefiltra	F2BE3681A	265	360	03/06 >			S 1999 NR		
power steering / servosterzo	F2BE3681A	265	360	03/06 >					S 3081 PO
440S40 Cursor 10	F3AE0681/F3AE0681B	294	400	06/03 >	09/04		S 4395 NR	S 7544 A	S 3078 C
	F3AE0681/F3AE0681B	294	400	10/04 >			S 4395 NR	S 7600 A	S 3078 C
some BLOW-BY filter (504153481) / alcuni filtro BLOW-BY (504153481)	F3AE0681/F3AE0681B	294	400	06/03 >					S 7266 A
dryer filter / filtro essiccatore	F3AE0681/F3AE0681B	294	400	06/03 >					S 7259 A
VGT filter / filtro VGT	F3AE0681/F3AE0681B	294	400	06/03 >					S 0VGT A
2 filters / N.2 filtri	F3AE0681/F3AE0681B	294	400	06/03 >		S 3288 R			



**kW HP****...IVECO - trucks/autocarri**

prefilter / prefiltrato	F3AE0681/F3AE0681B	294	400	06/03 >	01/04		S 0999 NR		
prefilter / prefiltrato	F3AE0681/F3AE0681B	294	400	01/04 >			S 1999 NR		
power steering / servosterzo	F3AE0681/F3AE0681B	294	400	06/03 >					S 8790 PO
power steering / servosterzo	F3AE0681/F3AE0681B	294	400	06/03 >					S 3081 PO
440S42 Cursor 10	F3AE3681D	309	420	03/06 >	05/07		S 1395 NR	S 7600 A	S 3078 C
	F3AE3681D	309	420	06/07 >		S 5087 OC	S 1395 NR	S 7600 A	S 3078 C
some BLOW-BY filter (504153481) / alcuni filtro BLOW-BY (504153481)	F3AE3681D	309	420	03/06 >					S 7266 A
with automatic gearbox and hydraulic retarder ZF Ecosplit + Intarder / con cambio automatico e rallentatore idraulico ZF Ecosplit + Intarder	F3AE3681D	309	420	03/06 >					S 2234 Z
with filter Urea/Adblue / con filtro Urea/Adblue	F3AE3681D	309	420	03/06 >					S 4401 U
dryer filter / filtro essiccatore	F3AE3681D	309	420	03/06 >					S 7259 A
VGT filter / filtro VGT	F3AE3681D	309	420	03/06 >					S 0VGT A
2 filters / N.2 filtri	F3AE3681D	309	420	03/06 >	05/07	S 3288 R			
prefilter / prefiltrato	F3AE3681D	309	420	03/06 >			S 1999 NR		
power steering / servosterzo	F3AE3681D	309	420	03/06 >					S 3081 PO
spare part only 150.000 km / solo ricambio 150.000 km	F3AE3681D	309	420	10/11 >		S 5111 PE			
440S43 Cursor 10	F3AE0681D	316	430	06/03 >	09/04		S 4395 NR	S 7544 A	S 3078 C
	F3AE0681D	316	430	10/04 >			S 4395 NR	S 7600 A	S 3078 C
some BLOW-BY filter (504153481) / alcuni filtro BLOW-BY (504153481)	F3AE0681D	316	430	06/03 >					S 7266 A
dryer filter / filtro essiccatore	F3AE0681D	316	430	06/03 >					S 7259 A
VGT filter / filtro VGT	F3AE0681D	316	430	06/03 >					S 0VGT A
2 filters / N.2 filtri	F3AE0681D	316	430	06/03 >		S 3288 R			
prefilter / prefiltrato	F3AE0681D	316	430	06/03 >	01/04		S 0999 NR		
prefilter / prefiltrato	F3AE0681D	316	430	01/04 >			S 1999 NR		
power steering / servosterzo	F3AE0681D	316	430	06/03 >					S 8790 PO
power steering / servosterzo	F3AE0681D	316	430	06/03 >					S 3081 PO
440S45 Cursor 10	F3AE3681A	331	450	03/06 >	05/07		S 1395 NR	S 7600 A	S 3078 C
	F3AE3681A	331	450	06/07 >		S 5087 OC	S 1395 NR	S 7600 A	S 3078 C
some BLOW-BY filter (504153481) / alcuni filtro BLOW-BY (504153481)	F3AE3681A	331	450	03/06 >					S 7266 A
with automatic gearbox and hydraulic retarder ZF Ecosplit + Intarder / con cambio automatico e rallentatore idraulico ZF Ecosplit + Intarder	F3AE3681A	331	450	03/06 >					S 2234 Z
with filter Urea/Adblue / con filtro Urea/Adblue	F3AE3681A	331	450	03/06 >					S 4401 U
dryer filter / filtro essiccatore	F3AE3681A	331	450	03/06 >					S 7259 A
VGT filter / filtro VGT	F3AE3681A	331	450	03/06 >					S 0VGT A
2 filters / N.2 filtri	F3AE3681A	331	450	03/06 >	05/07	S 3288 R			
prefilter / prefiltrato	F3AE3681A	331	450	03/06 >			S 1999 NR		
power steering / servosterzo	F3AE3681A	331	450	03/06 >					S 3081 PO
spare part only 150.000 km / solo ricambio 150.000 km	F3AE3681A	331	450	10/11 >		S 5111 PE			
Stralis AS									
190S40 Cursor 10	F3AE0681B	294	400	06/03 >	09/04		S 4395 NR	S 7544 A	S 3078 C
	F3AE0681B	294	400	10/04 >			S 4395 NR	S 7600 A	S 3078 C
some BLOW-BY filter (504153481) / alcuni filtro BLOW-BY (504153481)	F3AE0681B	294	400	06/03 >					S 7266 A
dryer filter / filtro essiccatore	F3AE0681B	294	400	06/03 >					S 7259 A
VGT filter / filtro VGT	F3AE0681B	294	400	06/03 >					S 0VGT A
2 filters / N.2 filtri	F3AE0681B	294	400	06/03 >		S 3288 R			
prefilter / prefiltrato	F3AE0681B	294	400	06/03 >	01/04		S 0999 NR		
prefilter / prefiltrato	F3AE0681B	294	400	01/04 >			S 1999 NR		
power steering / servosterzo	F3AE0681B	294	400	06/03 >					S 3081 PO
power steering / servosterzo	F3AE0681B	294	400	06/03 >					S 8790 PO
190S42 Cursor 10	F3AE3681D	309	420	03/06 >	05/07		S 1395 NR	S 7600 A	S 3078 C
	F3AE3681D	309	420	06/07 >		S 5087 OC	S 1395 NR	S 7600 A	S 3078 C
some BLOW-BY filter (504153481) / alcuni filtro BLOW-BY (504153481)	F3AE3681D	309	420	03/06 >					S 7266 A
with automatic gearbox and hydraulic retarder ZF Ecosplit + Intarder / con cambio automatico e rallentatore idraulico ZF Ecosplit + Intarder	F3AE3681D	309	420	03/06 >					S 2234 Z
with filter Urea/Adblue / con filtro Urea/Adblue	F3AE3681D	309	420	03/06 >					S 4401 U
dryer filter / filtro essiccatore	F3AE3681D	309	420	03/06 >					S 7259 A
VGT filter / filtro VGT	F3AE3681D	309	420	03/06 >					S 0VGT A
2 filters / N.2 filtri	F3AE3681D	309	420	03/06 >	05/07	S 3288 R			
prefilter / prefiltrato	F3AE3681D	309	420	03/06 >			S 1999 NR		
power steering / servosterzo	F3AE3681D	309	420	03/06 >					S 3081 PO
spare part only 150.000 km / solo ricambio 150.000 km	F3AE3681D	309	420	10/11 >		S 5111 PE			
190S43 Cursor 10	F3AE0681D	316	430	06/03 >	09/04		S 4395 NR	S 7544 A	S 3078 C
	F3AE0681D	316	430	10/04 >			S 4395 NR	S 7600 A	S 3078 C
some BLOW-BY filter (504153481) / alcuni filtro BLOW-BY (504153481)	F3AE0681D	316	430	06/03 >					S 7266 A
dryer filter / filtro essiccatore	F3AE0681D	316	430	06/03 >					S 7259 A
VGT filter / filtro VGT	F3AE0681D	316	430	06/03 >					S 0VGT A
2 filters / N.2 filtri	F3AE0681D	316	430	06/03 >		S 3288 R			
prefilter / prefiltrato	F3AE0681D	316	430	06/03 >	01/04		S 0999 NR		
prefilter / prefiltrato	F3AE0681D	316	430	01/04 >			S 1999 NR		
power steering / servosterzo	F3AE0681D	316	430	06/03 >					S 8790 PO



...IVECO - trucks/autocarri

power steering / servosterzo	F3AE0681D	316	430	06/03	>				S 3081 PO	
190S45 Cursor 10	F3AE3681A	331	450	03/06	>	05/07		S 1395 NR	S 7600 A	S 3078 C
	F3AE3681A	331	450	06/07	>		S 5087 OC	S 1395 NR	S 7600 A	S 3078 C
some BLOW-BY filter (504153481) / alcuni filtro BLOW-BY (504153481)	F3AE3681A	331	450	03/06	>					S 7266 A
with automatic gearbox and hydraulic retarder ZF Ecosplit + Intarder / con cambio automatico e rallentatore idraulico ZF Ecosplit + Intarder	F3AE3681A	331	450	03/06	>					S 2234 Z
with filter Urea/Adblue / con filtro Urea/Adblue	F3AE3681A	331	450	03/06	>					S 4401 U
dryer filter / filtro essiccatore	F3AE3681A	331	450	03/06	>					S 7259 A
VGT filter / filtro VGT	F3AE3681A	331	450	03/06	>					S 0VGT A
2 filters / N.2 filtri	F3AE3681A	331	450	03/06	>	05/07	S 3288 R			
prefilter / prefiltra	F3AE3681A	331	450	03/06	>			S 1999 NR		
power steering / servosterzo	F3AE3681A	331	450	03/06	>					S 3081 PO
spare part only 150.000 km / solo ricambio 150.000 km	F3AE3681A	331	450	10/11	>		S 5111 PE			
190S48 Cursor 13	F3BE0681E	353	480	06/03	>	09/04		S 4395 NR	S 7544 A	S 3078 C
	F3BE0681E	353	480	10/04	>			S 4395 NR	S 7600 A	S 3078 C
some BLOW-BY filter (504153481) / alcuni filtro BLOW-BY (504153481)	F3BE0681E	353	480	06/03	>					S 7266 A
dryer filter / filtro essiccatore	F3BE0681E	353	480	06/03	>					S 7259 A
VGT filter / filtro VGT	F3BE0681E	353	480	06/03	>					S 0VGT A
2 filters / N.2 filtri	F3BE0681E	353	480	06/03	>		S 3288 R			
prefilter / prefiltra	F3BE0681E	353	480	06/03	>	01/04		S 0999 NR		
prefilter / prefiltra	F3BE0681E	353	480	01/04	>			S 1999 NR		
power steering / servosterzo	F3BE0681E	353	480	06/03	>					S 8790 PO
power steering / servosterzo	F3BE0681E	353	480	06/03	>					S 3081 PO
190S50 Cursor 13	F3BE3681B	368	500	03/06	>	05/07		S 1395 NR	S 7600 A	S 3078 C
	F3BE3681B	368	500	06/07	>		S 5087 OC	S 1395 NR	S 7600 A	S 3078 C
some BLOW-BY filter (504153481) / alcuni filtro BLOW-BY (504153481)	F3BE3681B	368	500	03/06	>					S 7266 A
with automatic gearbox and hydraulic retarder ZF Ecosplit + Intarder / con cambio automatico e rallentatore idraulico ZF Ecosplit + Intarder	F3BE3681B	368	500	03/06	>					S 2234 Z
with filter Urea/Adblue / con filtro Urea/Adblue	F3BE3681B	368	500	03/06	>					S 4401 U
dryer filter / filtro essiccatore	F3BE3681B	368	500	03/06	>					S 7259 A
VGT filter / filtro VGT	F3BE3681B	368	500	03/06	>					S 0VGT A
2 filters / N.2 filtri	F3BE3681B	368	500	03/06	>	05/07	S 3288 R			
prefilter / prefiltra	F3BE3681B	368	500	03/06	>			S 1999 NR		
power steering / servosterzo	F3BE3681B	368	500	03/06	>					S 3081 PO
spare part only 150.000 km / solo ricambio 150.000 km	F3BE3681B	368	500	10/11	>		S 5111 PE			
260S40 Cursor 10	F3AE0681B	294	400	06/03	>	09/04		S 4395 NR	S 7544 A	S 3078 C
	F3AE0681B	294	400	10/04	>			S 4395 NR	S 7600 A	S 3078 C
some BLOW-BY filter (504153481) / alcuni filtro BLOW-BY (504153481)	F3AE0681B	294	400	06/03	>					S 7266 A
dryer filter / filtro essiccatore	F3AE0681B	294	400	06/03	>					S 7259 A
VGT filter / filtro VGT	F3AE0681B	294	400	06/03	>					S 0VGT A
2 filters / N.2 filtri	F3AE0681B	294	400	06/03	>		S 3288 R			
prefilter / prefiltra	F3AE0681B	294	400	06/03	>	01/04		S 0999 NR		
prefilter / prefiltra	F3AE0681B	294	400	01/04	>			S 1999 NR		
power steering / servosterzo	F3AE0681B	294	400	06/03	>					S 8790 PO
power steering / servosterzo	F3AE0681B	294	400	06/03	>					S 3081 PO
260S42 Cursor 10	F3AE3681D	309	420	03/06	>	05/07		S 1395 NR	S 7600 A	S 3078 C
	F3AE3681D	309	420	06/07	>		S 5087 OC	S 1395 NR	S 7600 A	S 3078 C
some BLOW-BY filter (504153481) / alcuni filtro BLOW-BY (504153481)	F3AE3681D	309	420	03/06	>					S 7266 A
with automatic gearbox and hydraulic retarder ZF Ecosplit + Intarder / con cambio automatico e rallentatore idraulico ZF Ecosplit + Intarder	F3AE3681D	309	420	03/06	>					S 2234 Z
with filter Urea/Adblue / con filtro Urea/Adblue	F3AE3681D	309	420	03/06	>					S 4401 U
dryer filter / filtro essiccatore	F3AE3681D	309	420	03/06	>					S 7259 A
VGT filter / filtro VGT	F3AE3681D	309	420	03/06	>					S 0VGT A
2 filters / N.2 filtri	F3AE3681D	309	420	03/06	>	05/07	S 3288 R			
prefilter / prefiltra	F3AE3681D	309	420	03/06	>			S 1999 NR		
power steering / servosterzo	F3AE3681D	309	420	03/06	>					S 3081 PO
spare part only 150.000 km / solo ricambio 150.000 km	F3AE3681D	309	420	10/11	>		S 5111 PE			
260S43 Cursor 10	F3AE0681D	316	430	06/03	>	09/04		S 4395 NR	S 7544 A	S 3078 C
	F3AE0681D	316	430	10/04	>			S 4395 NR	S 7600 A	S 3078 C
some BLOW-BY filter (504153481) / alcuni filtro BLOW-BY (504153481)	F3AE0681D	316	430	06/03	>					S 7266 A
dryer filter / filtro essiccatore	F3AE0681D	316	430	06/03	>					S 7259 A
VGT filter / filtro VGT	F3AE0681D	316	430	06/03	>					S 0VGT A
2 filters / N.2 filtri	F3AE0681D	316	430	06/03	>		S 3288 R			
prefilter / prefiltra	F3AE0681D	316	430	06/03	>	01/04		S 0999 NR		
prefilter / prefiltra	F3AE0681D	316	430	01/04	>			S 1999 NR		
power steering / servosterzo	F3AE0681D	316	430	06/03	>					S 8790 PO
power steering / servosterzo	F3AE0681D	316	430	06/03	>					S 3081 PO
260S45 Cursor 10	F3AE3681A	331	450	03/06	>	05/07		S 1395 NR	S 7600 A	S 3078 C
	F3AE3681A	331	450	06/07	>		S 5087 OC	S 1395 NR	S 7600 A	S 3078 C
some BLOW-BY filter (504153481) / alcuni filtro BLOW-BY (504153481)	F3AE3681A	331	450	03/06	>					S 7266 A





...IVECO - trucks/autocarri

with automatic gearbox and hydraulic retarder ZF Ecosplit + Intarder / con cambio automatico e rallentatore idraulico ZF Ecosplit + Intarder	F3AE3681A	331	450	03/06	>				S 2234 Z
with filter Urea/Adblue / con filtro Urea/Adblue	F3AE3681A	331	450	03/06	>				S 4401 U
dryer filter / filtro essiccatore	F3AE3681A	331	450	03/06	>				S 7259 A
VGT filter / filtro VGT	F3AE3681A	331	450	03/06	>				S 0VGT A
2 filters / N.2 filtri	F3AE3681A	331	450	03/06	>	05/07	S 3288 R		
prefilter / prefiltra	F3AE3681A	331	450	03/06	>			S 1999 NR	
power steering / servosterzo	F3AE3681A	331	450	03/06	>				S 3081 PO
spare part only 150.000 km / solo ricambio 150.000 km	F3AE3681A	331	450	10/11	>		S 5111 PE		
260S48 Cursor 13	F3BE0681E	353	480	06/03	>	09/04		S 4395 NR	S 7544 A
	F3BE0681E	353	480	10/04	>			S 4395 NR	S 7600 A
some BLOW-BY filter (504153481) / alcuni filtro BLOW-BY (504153481)	F3BE0681E	353	480	06/03	>				S 7266 A
dryer filter / filtro essiccatore	F3BE0681E	353	480	06/03	>				S 7259 A
VGT filter / filtro VGT	F3BE0681E	353	480	06/03	>				S 0VGT A
2 filters / N.2 filtri	F3BE0681E	353	480	06/03	>		S 3288 R		
prefilter / prefiltra	F3BE0681E	353	480	06/03	>	01/04		S 0999 NR	
prefilter / prefiltra	F3BE0681E	353	480	01/04	>			S 1999 NR	
power steering / servosterzo	F3BE0681E	353	480	06/03	>				S 8790 PO
power steering / servosterzo	F3BE0681E	353	480	06/03	>				S 3081 PO
260S50 Cursor 13	F3BE3681B	368	500	03/06	>	05/07		S 1395 NR	S 7600 A
	F3BE3681B	368	500	06/07	>		S 5087 OC	S 1395 NR	S 7600 A
some BLOW-BY filter (504153481) / alcuni filtro BLOW-BY (504153481)	F3BE3681B	368	500	03/06	>				S 7266 A
with automatic gearbox and hydraulic retarder ZF Ecosplit + Intarder / con cambio automatico e rallentatore idraulico ZF Ecosplit + Intarder	F3BE3681B	368	500	03/06	>				S 2234 Z
with filter Urea/Adblue / con filtro Urea/Adblue	F3BE3681B	368	500	03/06	>				S 4401 U
dryer filter / filtro essiccatore	F3BE3681B	368	500	03/06	>				S 7259 A
VGT filter / filtro VGT	F3BE3681B	368	500	03/06	>				S 0VGT A
2 filters / N.2 filtri	F3BE3681B	368	500	03/06	>	05/07	S 3288 R		
prefilter / prefiltra	F3BE3681B	368	500	03/06	>			S 1999 NR	
power steering / servosterzo	F3BE3681B	368	500	03/06	>				S 3081 PO
spare part only 150.000 km / solo ricambio 150.000 km	F3BE3681B	368	500	10/11	>		S 5111 PE		
260S54 Cursor 13	F3BE0681A	397	540	06/03	>	09/04		S 4395 NR	S 7544 A
	F3BE0681A	397	540	10/04	>			S 4395 NR	S 7600 A
some BLOW-BY filter (504153481) / alcuni filtro BLOW-BY (504153481)	F3BE0681A	397	540	06/03	>				S 7266 A
dryer filter / filtro essiccatore	F3BE0681A	397	540	06/03	>				S 7259 A
VGT filter / filtro VGT	F3BE0681A	397	540	06/03	>				S 0VGT A
2 filters / N.2 filtri	F3BE0681A	397	540	06/03	>		S 3288 R		
prefilter / prefiltra	F3BE0681A	397	540	06/03	>	01/04		S 0999 NR	
prefilter / prefiltra	F3BE0681A	397	540	01/04	>			S 1999 NR	
power steering / servosterzo	F3BE0681A	397	540	06/03	>				S 8790 PO
power steering / servosterzo	F3BE0681A	397	540	06/03	>				S 3081 PO
260S56 Cursor 13	F3BE3681A	412	560	03/06	>	05/07		S 1395 NR	S 7600 A
	F3BE3681A	412	560	06/07	>		S 5087 OC	S 1395 NR	S 7600 A
some BLOW-BY filter (504153481) / alcuni filtro BLOW-BY (504153481)	F3BE3681A	412	560	03/06	>				S 7266 A
with automatic gearbox and hydraulic retarder ZF Ecosplit + Intarder / con cambio automatico e rallentatore idraulico ZF Ecosplit + Intarder	F3BE3681A	412	560	03/06	>				S 2234 Z
with filter Urea/Adblue / con filtro Urea/Adblue	F3BE3681A	412	560	03/06	>				S 4401 U
dryer filter / filtro essiccatore	F3BE3681A	412	560	03/06	>				S 7259 A
VGT filter / filtro VGT	F3BE3681A	412	560	03/06	>				S 0VGT A
2 filters / N.2 filtri	F3BE3681A	412	560	03/06	>	05/07	S 3288 R		
prefilter / prefiltra	F3BE3681A	412	560	03/06	>			S 1999 NR	
power steering / servosterzo	F3BE3681A	412	560	03/06	>				S 3081 PO
spare part only 150.000 km / solo ricambio 150.000 km	F3BE3681A	412	560	10/11	>		S 5111 PE		
440S36 Cursor 8	F2BE3681A	265	360	03/06	>		S 3288 R	S 4396 NR	S 7600 A
some BLOW-BY filter (504153481) / alcuni filtro BLOW-BY (504153481)	F2BE3681A	265	360	03/06	>				S 7266 A
with automatic gearbox and hydraulic retarder ZF Ecosplit + Intarder / con cambio automatico e rallentatore idraulico ZF Ecosplit + Intarder	F2BE3681A	265	360	03/06	>				S 2234 Z
with filter Urea/Adblue / con filtro Urea/Adblue	F2BE3681A	265	360	03/06	>				S 4401 U
dryer filter / filtro essiccatore	F2BE3681A	265	360	03/06	>				S 7259 A
VGT filter / filtro VGT	F2BE3681A	265	360	03/06	>				S 0VGT A
prefilter / prefiltra	F2BE3681A	265	360	03/06	>			S 1999 NR	
power steering / servosterzo	F2BE3681A	265	360	03/06	>				S 3081 PO
440S40 Cursor 10	F3AE0681B	294	400	06/03	>	09/04		S 4395 NR	S 7544 A
	F3AE0681B	294	400	10/04	>			S 4395 NR	S 7600 A
some BLOW-BY filter (504153481) / alcuni filtro BLOW-BY (504153481)	F3AE0681B	294	400	06/03	>				S 7266 A
dryer filter / filtro essiccatore	F3AE0681B	294	400	06/03	>				S 7259 A
VGT filter / filtro VGT	F3AE0681B	294	400	06/03	>				S 0VGT A
2 filters / N.2 filtri	F3AE0681B	294	400	06/03	>		S 3288 R		
prefilter / prefiltra	F3AE0681B	294	400	06/03	>	01/04		S 0999 NR	
prefilter / prefiltra	F3AE0681B	294	400	01/04	>			S 1999 NR	
power steering / servosterzo	F3AE0681B	294	400	06/03	>				S 8790 PO

**kW HP****...IVECO - trucks/autocarri**

power steering / servosterzo	F3AE0681B	294	400	06/03	>				S 3081 PO	
440S42 Cursor 10	F3AE3681D	309	420	03/06	>	05/07		S 1395 NR	S 7600 A	S 3078 C
	F3AE3681D	309	420	06/07	>		S 5087 OC	S 1395 NR	S 7600 A	S 3078 C
some BLOW-BY filter (504153481) / alcuni filtro BLOW-BY (504153481)	F3AE3681D	309	420	03/06	>					S 7266 A
with automatic gearbox and hydraulic retarder ZF Ecosplit + Intarder / con cambio automatico e rallentatore idraulico ZF Ecosplit + Intarder	F3AE3681D	309	420	03/06	>					S 2234 Z
with filter Urea/Adblue / con filtro Urea/Adblue	F3AE3681D	309	420	03/06	>					S 4401 U
dryer filter / filtro essiccatore	F3AE3681D	309	420	03/06	>					S 7259 A
VGT filter / filtro VGT	F3AE3681D	309	420	03/06	>					S 0VGT A
2 filters / N.2 filtri	F3AE3681D	309	420	03/06	>	05/07	S 3288 R			
prefilter / prefiltra	F3AE3681D	309	420	03/06	>			S 1999 NR		
power steering / servosterzo	F3AE3681D	309	420	03/06	>					S 3081 PO
spare part only 150.000 km / solo ricambio 150.000 km	F3AE3681D	309	420	10/11	>		S 5111 PE			
440S43 Cursor 10	F3AE0681D	316	430	06/03	>	09/04		S 4395 NR	S 7544 A	S 3078 C
	F3AE0681D	316	430	10/04	>			S 4395 NR	S 7600 A	S 3078 C
some BLOW-BY filter (504153481) / alcuni filtro BLOW-BY (504153481)	F3AE0681D	316	430	06/03	>					S 7266 A
dryer filter / filtro essiccatore	F3AE0681D	316	430	06/03	>					S 7259 A
VGT filter / filtro VGT	F3AE0681D	316	430	06/03	>					S 0VGT A
2 filters / N.2 filtri	F3AE0681D	316	430	06/03	>		S 3288 R			
prefilter / prefiltra	F3AE0681D	316	430	06/03	>	01/04		S 0999 NR		
prefilter / prefiltra	F3AE0681D	316	430	01/04	>			S 1999 NR		
power steering / servosterzo	F3AE0681D	316	430	06/03	>					S 8790 PO
power steering / servosterzo	F3AE0681D	316	430	06/03	>					S 3081 PO
440S45 Cursor 10	F3AE3681A	331	450	03/06	>	05/07		S 1395 NR	S 7600 A	S 3078 C
	F3AE3681A	331	450	06/07	>		S 5087 OC	S 1395 NR	S 7600 A	S 3078 C
some BLOW-BY filter (504153481) / alcuni filtro BLOW-BY (504153481)	F3AE3681A	331	450	03/06	>					S 7266 A
with automatic gearbox and hydraulic retarder ZF Ecosplit + Intarder / con cambio automatico e rallentatore idraulico ZF Ecosplit + Intarder	F3AE3681A	331	450	03/06	>					S 2234 Z
with filter Urea/Adblue / con filtro Urea/Adblue	F3AE3681A	331	450	03/06	>					S 4401 U
dryer filter / filtro essiccatore	F3AE3681A	331	450	03/06	>					S 7259 A
VGT filter / filtro VGT	F3AE3681A	331	450	03/06	>					S 0VGT A
2 filters / N.2 filtri	F3AE3681A	331	450	03/06	>	05/07	S 3288 R			
prefilter / prefiltra	F3AE3681A	331	450	03/06	>			S 1999 NR		
power steering / servosterzo	F3AE3681A	331	450	03/06	>					S 3081 PO
spare part only 150.000 km / solo ricambio 150.000 km	F3AE3681A	331	450	10/11	>		S 5111 PE			
440S48 Cursor 13	F3BE0681E	353	480	06/03	>	09/04		S 4395 NR	S 7544 A	S 3078 C
	F3BE0681E	353	480	10/04	>	02/06		S 4395 NR	S 7600 A	S 3078 C
	F3BE0681E	353	480	03/06	>	05/07		S 1395 NR	S 7600 A	S 3078 C
	F3BE0681E	353	480	06/07	>		S 5087 OC	S 1395 NR	S 7600 A	S 3078 C
some BLOW-BY filter (504153481) / alcuni filtro BLOW-BY (504153481)	F3BE0681E	353	480	06/03	>					S 7266 A
with filter Urea/Adblue / con filtro Urea/Adblue	F3BE0681E	353	480	05/05	>					S 4401 U
dryer filter / filtro essiccatore	F3BE0681E	353	480	06/03	>					S 7259 A
VGT filter / filtro VGT	F3BE0681E	353	480	06/03	>					S 0VGT A
2 filters / N.2 filtri	F3BE0681E	353	480	06/03	>	05/07	S 3288 R			
prefilter / prefiltra	F3BE0681E	353	480	06/03	>	01/04		S 0999 NR		
prefilter / prefiltra	F3BE0681E	353	480	01/04	>			S 1999 NR		
power steering / servosterzo	F3BE0681E	353	480	06/03	>					S 8790 PO
power steering / servosterzo	F3BE0681E	353	480	06/03	>					S 3081 PO
spare part only 150.000 km / solo ricambio 150.000 km	F3BE0681E	353	480	10/11	>		S 5111 PE			
440S50 Cursor 13	F3BE3681B	368	500	03/06	>	05/07		S 1395 NR	S 7600 A	S 3078 C
	F3BE3681B	368	500	06/07	>		S 5087 OC	S 1395 NR	S 7600 A	S 3078 C
some BLOW-BY filter (504153481) / alcuni filtro BLOW-BY (504153481)	F3BE3681B	368	500	03/06	>					S 7266 A
with automatic gearbox and hydraulic retarder ZF Ecosplit + Intarder / con cambio automatico e rallentatore idraulico ZF Ecosplit + Intarder	F3BE3681B	368	500	03/06	>					S 2234 Z
with filter Urea/Adblue / con filtro Urea/Adblue	F3BE3681B	368	500	03/06	>					S 4401 U
dryer filter / filtro essiccatore	F3BE3681B	368	500	03/06	>					S 7259 A
VGT filter / filtro VGT	F3BE3681B	368	500	03/06	>					S 0VGT A
2 filters / N.2 filtri	F3BE3681B	368	500	03/06	>	05/07	S 3288 R			
prefilter / prefiltra	F3BE3681B	368	500	03/06	>			S 1999 NR		
power steering / servosterzo	F3BE3681B	368	500	03/06	>					S 3081 PO
spare part only 150.000 km / solo ricambio 150.000 km	F3BE3681B	368	500	10/11	>		S 5111 PE			
440S54 Cursor 13	F3BE0681A	397	540	06/03	>	09/04		S 4395 NR	S 7544 A	S 3078 C
	F3BE0681A	397	540	10/04	>			S 4395 NR	S 7600 A	S 3078 C
some BLOW-BY filter (504153481) / alcuni filtro BLOW-BY (504153481)	F3BE0681A	397	540	06/03	>					S 7266 A
dryer filter / filtro essiccatore	F3BE0681A	397	540	06/03	>					S 7259 A
VGT filter / filtro VGT	F3BE0681A	397	540	06/03	>					S 0VGT A
2 filters / N.2 filtri	F3BE0681A	397	540	06/03	>		S 3288 R			
prefilter / prefiltra	F3BE0681A	397	540	06/03	>	01/04		S 0999 NR		
prefilter / prefiltra	F3BE0681A	397	540	01/04	>			S 1999 NR		
power steering / servosterzo	F3BE0681A	397	540	06/03	>					S 3081 PO





...IVECO - trucks/autocarri

440S56 Cursor 13	F3BE3681A	412	560	03/06 >	05/07		S 1395 NR	S 7600 A	S 3078 C
	F3BE3681A	412	560	06/07 >		S 5087 OC	S 1395 NR	S 7600 A	S 3078 C
	F3BE3681A	412	560	03/06 >					S 7266 A
	F3BE3681A	412	560	03/06 >					S 2234 Z
	F3BE3681A	412	560	03/06 >					S 4401 U
	F3BE3681A	412	560	03/06 >					S 7259 A
	F3BE3681A	412	560	03/06 >					S 0VGT A
	F3BE3681A	412	560	03/06 >	05/07	S 3288 R			
	F3BE3681A	412	560	03/06 >			S 1999 NR		
	F3BE3681A	412	560	03/06 >					S 3081 PO
spare part only 150.000 km / solo ricambio 150.000 km									
Stralis AT									
190S27 Cursor 8	F2BE0681	200	272	06/03 >	09/04	S 3288 R	S 4396 NR	S 7546 A	S 3078 C
	F2BE0681	200	272	10/04 >		S 3288 R	S 4396 NR	S 7600 A	S 3078 C
	F2BE0681	200	272	06/03 >					S 7266 A
	F2BE0681	200	272	06/03 >					S 7259 A
	F2BE0681	200	272	06/03 >					S 0VGT A
	F2BE0681	200	272	06/03 >	01/04		S 0999 NR		
	F2BE0681	200	272	01/04 >			S 1999 NR		
F2BE0681	200	272	06/03 >					S 3081 PO	
190S31 Cursor 8	F2BE0681	228	310	06/03 >	09/04	S 3288 R	S 4396 NR	S 7546 A	S 3078 C
	F2BE0681	228	310	10/04 >		S 3288 R	S 4396 NR	S 7600 A	S 3078 C
	F2BE0681	228	310	06/03 >					S 7266 A
	F2BE0681	228	310	06/03 >					S 7259 A
	F2BE0681	228	310	06/03 >					S 0VGT A
	F2BE0681	228	310	06/03 >	01/04		S 0999 NR		
F2BE0681	228	310	01/04 >			S 1999 NR			
F2BE0681	228	310	06/03 >					S 3081 PO	
190S31 Cursor9 E6	F2CFE611	228	310	01/13 >		S 5102 PE	S 6043 NE		
190S33 Cursor 8	F2BE3681B	243	330	03/06 >		S 3288 R	S 4396 NR	S 7600 A	S 3078 C
	F2BE3681B	243	330	03/06 >					S 7266 A
	F2BE3681B	243	330	03/06 >					S 2234 Z
	F2BE3681B	243	330	03/06 >					S 4401 U
	F2BE3681B	243	330	03/06 >					S 7259 A
	F2BE3681B	243	330	03/06 >			S 1999 NR		S 0VGT A
	F2BE3681B	243	330	03/06 >					S 3081 PO
190S33 Cursor9 E6	F2CFE611	243	330	01/13 >		S 5102 PE	S 6043 NE		
190S35 Cursor 8	F2BE0681	259	352	06/03 >	09/04	S 3288 R	S 4396 NR	S 7546 A	S 3078 C
	F2BE0681	259	352	10/04 >		S 3288 R	S 4396 NR	S 7600 A	S 3078 C
	F2BE0681	259	352	06/03 >					S 7266 A
	F2BE0681	259	352	06/03 >					S 7259 A
	F2BE0681	259	352	06/03 >					S 0VGT A
	F2BE0681	259	352	06/03 >	01/04		S 0999 NR		
	F2BE0681	259	352	01/04 >			S 1999 NR		
F2BE0681	259	352	06/03 >					S 3081 PO	
190S36 Cursor 8	F2BE3681A	265	360	03/06 >		S 3288 R	S 4396 NR	S 7600 A	S 3078 C
	F2BE3681A	265	360	03/06 >					S 7266 A
	F2BE3681A	265	360	03/06 >					S 2234 Z
	F2BE3681A	265	360	03/06 >					S 4401 U
	F2BE3681A	265	360	03/06 >					S 7259 A
	F2BE3681A	265	360	03/06 >			S 1999 NR		S 0VGT A
	F2BE3681A	265	360	03/06 >					S 3081 PO
190S40 Cursor 10	F3AE0681	294	400	06/03 >	09/04		S 4395 NR	S 7544 A	S 3078 C
	F3AE0681	294	400	10/04 >			S 4395 NR	S 7600 A	S 3078 C
	F3AE0681	294	400	06/03 >					S 7266 A
	F3AE0681	294	400	06/03 >					S 7259 A
	F3AE0681	294	400	06/03 >					S 0VGT A
	F3AE0681	294	400	06/03 >		S 3288 R			
	F3AE0681	294	400	06/03 >	01/04		S 0999 NR		
	F3AE0681	294	400	01/04 >			S 1999 NR		
F3AE0681	294	400	06/03 >					S 8790 PO	
F3AE0681	294	400	06/03 >					S 3081 PO	
190S42 Cursor 10	F3AE3681D	309	420	03/06 >	05/07		S 1395 NR	S 7600 A	S 3078 C
	F3AE3681D	309	420	06/07 >		S 5087 OC	S 1395 NR	S 7600 A	S 3078 C
	F3AE3681D	309	420	03/06 >					S 7266 A
	F3AE3681D	309	420	03/06 >					

**kW HP****...IVECO - trucks/autocarri**

with automatic gearbox and hydraulic retarder ZF Ecosplit + Intarder / con cambio automatico e rallentatore idraulico ZF Ecosplit + Intarder	F3AE3681D	309	420	03/06	>				S 2234 Z
with filter Urea/Adblue / con filtro Urea/Adblue	F3AE3681D	309	420	03/06	>				S 4401 U
dryer filter / filtro essiccatore	F3AE3681D	309	420	03/06	>				S 7259 A
VGT filter / filtro VGT	F3AE3681D	309	420	03/06	>				S 0VGT A
2 filters / N.2 filtri	F3AE3681D	309	420	03/06	>	05/07	S 3288 R		
prefilter / prefiltra	F3AE3681D	309	420	03/06	>			S 1999 NR	
power steering / servosterzo	F3AE3681D	309	420	03/06	>				S 3081 PO
spare part only 150.000 km / solo ricambio 150.000 km	F3AE3681D	309	420	10/11	>		S 5111 PE		
190S43 Cursor 10	F3AE0681	316	430	06/03	>	09/04		S 4395 NR	S 7544 A
	F3AE0681	316	430	10/04	>			S 4395 NR	S 7600 A
some BLOW-BY filter (504153481) / alcuni filtro BLOW-BY (504153481)	F3AE0681	316	430	06/03	>				S 7266 A
dryer filter / filtro essiccatore	F3AE0681	316	430	06/03	>				S 7259 A
VGT filter / filtro VGT	F3AE0681	316	430	06/03	>				S 0VGT A
2 filters / N.2 filtri	F3AE0681	316	430	06/03	>		S 3288 R		
prefilter / prefiltra	F3AE0681	316	430	06/03	>	01/04		S 0999 NR	
prefilter / prefiltra	F3AE0681	316	430	01/04	>			S 1999 NR	
power steering / servosterzo	F3AE0681	316	430	06/03	>				S 8790 PO
power steering / servosterzo	F3AE0681	316	430	06/03	>				S 3081 PO
190S45 Cursor 10	F3AE3681A	331	450	03/06	>	05/07		S 1395 NR	S 7600 A
	F3AE3681A	331	450	06/07	>		S 5087 OC	S 1395 NR	S 7600 A
some BLOW-BY filter (504153481) / alcuni filtro BLOW-BY (504153481)	F3AE3681A	331	450	03/06	>				S 7266 A
with automatic gearbox and hydraulic retarder ZF Ecosplit + Intarder / con cambio automatico e rallentatore idraulico ZF Ecosplit + Intarder	F3AE3681A	331	450	03/06	>				S 2234 Z
with filter Urea/Adblue / con filtro Urea/Adblue	F3AE3681A	331	450	03/06	>				S 4401 U
dryer filter / filtro essiccatore	F3AE3681A	331	450	03/06	>				S 7259 A
VGT filter / filtro VGT	F3AE3681A	331	450	03/06	>				S 0VGT A
2 filters / N.2 filtri	F3AE3681A	331	450	03/06	>	05/07	S 3288 R		
prefilter / prefiltra	F3AE3681A	331	450	03/06	>			S 1999 NR	
power steering / servosterzo	F3AE3681A	331	450	03/06	>				S 3081 PO
spare part only 150.000 km / solo ricambio 150.000 km	F3AE3681A	331	450	10/11	>		S 5111 PE		
260S27 Cursor 8	F2BE0681	200	272	06/03	>	09/04	S 3288 R	S 4396 NR	S 7546 A
	F2BE0681	200	272	10/04	>		S 3288 R	S 4396 NR	S 7600 A
some BLOW-BY filter (504153481) / alcuni filtro BLOW-BY (504153481)	F2BE0681	200	272	06/03	>				S 7266 A
dryer filter / filtro essiccatore	F2BE0681	200	272	06/03	>				S 7259 A
VGT filter / filtro VGT	F2BE0681	200	272	06/03	>				S 0VGT A
prefilter / prefiltra	F2BE0681	200	272	06/03	>	01/04		S 0999 NR	
prefilter / prefiltra	F2BE0681	200	272	01/04	>			S 1999 NR	
power steering / servosterzo	F2BE0681	200	272	06/03	>				S 8790 PO
power steering / servosterzo	F2BE0681	200	272	06/03	>				S 3081 PO
260S31 Cursor 8	F2BE0681	228	310	06/03	>	09/04	S 3288 R	S 4396 NR	S 7546 A
	F2BE0681	228	310	10/04	>		S 3288 R	S 4396 NR	S 7600 A
some BLOW-BY filter (504153481) / alcuni filtro BLOW-BY (504153481)	F2BE0681	228	310	06/03	>				S 7266 A
dryer filter / filtro essiccatore	F2BE0681	228	310	06/03	>				S 7259 A
VGT filter / filtro VGT	F2BE0681	228	310	06/03	>				S 0VGT A
prefilter / prefiltra	F2BE0681	228	310	06/03	>	01/04		S 0999 NR	
prefilter / prefiltra	F2BE0681	228	310	01/04	>			S 1999 NR	
power steering / servosterzo	F2BE0681	228	310	06/03	>				S 8790 PO
power steering / servosterzo	F2BE0681	228	310	06/03	>				S 3081 PO
260S33 Cursor 8	F2BE3681B	243	330	03/06	>		S 3288 R	S 4396 NR	S 7600 A
some BLOW-BY filter (504153481) / alcuni filtro BLOW-BY (504153481)	F2BE3681B	243	330	03/06	>				S 7266 A
with automatic gearbox and hydraulic retarder ZF Ecosplit + Intarder / con cambio automatico e rallentatore idraulico ZF Ecosplit + Intarder	F2BE3681B	243	330	03/06	>				S 2234 Z
with filter Urea/Adblue / con filtro Urea/Adblue	F2BE3681B	243	330	03/06	>				S 4401 U
dryer filter / filtro essiccatore	F2BE3681B	243	330	03/06	>				S 7259 A
VGT filter / filtro VGT	F2BE3681B	243	330	03/06	>				S 0VGT A
prefilter / prefiltra	F2BE3681B	243	330	03/06	>			S 1999 NR	
power steering / servosterzo	F2BE3681B	243	330	03/06	>				S 3081 PO
260S35 Cursor 8	F2BE0681	259	352	06/03	>	09/04	S 3288 R	S 4396 NR	S 7546 A
	F2BE0681	259	352	10/04	>		S 3288 R	S 4396 NR	S 7600 A
some BLOW-BY filter (504153481) / alcuni filtro BLOW-BY (504153481)	F2BE0681	259	352	06/03	>				S 7266 A
dryer filter / filtro essiccatore	F2BE0681	259	352	06/03	>				S 7259 A
VGT filter / filtro VGT	F2BE0681	259	352	06/03	>				S 0VGT A
prefilter / prefiltra	F2BE0681	259	352	06/03	>	01/04		S 0999 NR	
prefilter / prefiltra	F2BE0681	259	352	01/04	>			S 1999 NR	
power steering / servosterzo	F2BE0681	259	352	06/03	>				S 8790 PO
power steering / servosterzo	F2BE0681	259	352	06/03	>				S 3081 PO
260S36 Cursor 8	F2BE3681A	265	360	03/06	>		S 3288 R	S 4396 NR	S 7600 A
some BLOW-BY filter (504153481) / alcuni filtro BLOW-BY (504153481)	F2BE3681A	265	360	03/06	>				S 7266 A
with automatic gearbox and hydraulic retarder ZF Ecosplit + Intarder / con cambio automatico e rallentatore idraulico ZF Ecosplit + Intarder	F2BE3681A	265	360	03/06	>				S 2234 Z



**KW HP****...IVECO - trucks/autocarri**

with filter Urea/Adblue / con filtro Urea/Adblue	F2BE3681A	265	360	03/06	>				S 4401 U
dryer filter / filtro essiccatore	F2BE3681A	265	360	03/06	>				S 7259 A
VGT filter / filtro VGT	F2BE3681A	265	360	03/06	>				S 0VGT A
prefilter / prefiltra	F2BE3681A	265	360	03/06	>		S 1999 NR		
power steering / servosterzo	F2BE3681A	265	360	03/06	>				S 3081 PO
260S40 Cursor 10	F3AE0681	294	400	06/03	>	09/04		S 4395 NR	S 7544 A
	F3AE0681	294	400	10/04	>			S 4395 NR	S 7600 A
some BLOW-BY filter (504153481) / alcuni filtro BLOW-BY (504153481)	F3AE0681	294	400	06/03	>				S 7266 A
dryer filter / filtro essiccatore	F3AE0681	294	400	06/03	>				S 7259 A
VGT filter / filtro VGT	F3AE0681	294	400	06/03	>				S 0VGT A
2 filters / N.2 filtri	F3AE0681	294	400	06/03	>		S 3288 R		
prefilter / prefiltra	F3AE0681	294	400	06/03	>	01/04		S 0999 NR	
prefilter / prefiltra	F3AE0681	294	400	01/04	>			S 1999 NR	
power steering / servosterzo	F3AE0681	294	400	06/03	>				S 8790 PO
power steering / servosterzo	F3AE0681	294	400	06/03	>				S 3081 PO
260S42 Cursor 10	F3AE3681D	309	420	03/06	>	05/07		S 1395 NR	S 7600 A
	F3AE3681D	309	420	06/07	>		S 5087 OC	S 1395 NR	S 7600 A
some BLOW-BY filter (504153481) / alcuni filtro BLOW-BY (504153481)	F3AE3681D	309	420	03/06	>				S 7266 A
with automatic gearbox and hydraulic retarder ZF Ecosplit + Intarder / con cambio automatico e rallentatore idraulico ZF Ecosplit + Intarder	F3AE3681D	309	420	03/06	>				S 2234 Z
with filter Urea/Adblue / con filtro Urea/Adblue	F3AE3681D	309	420	03/06	>				S 4401 U
dryer filter / filtro essiccatore	F3AE3681D	309	420	03/06	>				S 7259 A
VGT filter / filtro VGT	F3AE3681D	309	420	03/06	>				S 0VGT A
2 filters / N.2 filtri	F3AE3681D	309	420	03/06	>	05/07	S 3288 R		
prefilter / prefiltra	F3AE3681D	309	420	03/06	>			S 1999 NR	
power steering / servosterzo	F3AE3681D	309	420	03/06	>				S 3081 PO
spare part only 150.000 km / solo ricambio 150.000 km	F3AE3681D	309	420	10/11	>		S 5111 PE		
260S43 Cursor 10	F3AE0681	316	430	06/03	>	09/04		S 4395 NR	S 7544 A
	F3AE0681	316	430	10/04	>			S 4395 NR	S 7600 A
some BLOW-BY filter (504153481) / alcuni filtro BLOW-BY (504153481)	F3AE0681	316	430	06/03	>				S 7266 A
dryer filter / filtro essiccatore	F3AE0681	316	430	06/03	>				S 7259 A
VGT filter / filtro VGT	F3AE0681	316	430	06/03	>				S 0VGT A
2 filters / N.2 filtri	F3AE0681	316	430	06/03	>		S 3288 R		
prefilter / prefiltra	F3AE0681	316	430	06/03	>	01/04		S 0999 NR	
prefilter / prefiltra	F3AE0681	316	430	01/04	>			S 1999 NR	
power steering / servosterzo	F3AE0681	316	430	06/03	>				S 8790 PO
power steering / servosterzo	F3AE0681	316	430	06/03	>				S 3081 PO
260S45 Cursor 10	F3AE3681A	331	450	03/06	>	05/07		S 1395 NR	S 7600 A
	F3AE3681A	331	450	06/07	>		S 5087 OC	S 1395 NR	S 7600 A
some BLOW-BY filter (504153481) / alcuni filtro BLOW-BY (504153481)	F3AE3681A	331	450	03/06	>				S 7266 A
with automatic gearbox and hydraulic retarder ZF Ecosplit + Intarder / con cambio automatico e rallentatore idraulico ZF Ecosplit + Intarder	F3AE3681A	331	450	03/06	>				S 2234 Z
with filter Urea/Adblue / con filtro Urea/Adblue	F3AE3681A	331	450	03/06	>				S 4401 U
dryer filter / filtro essiccatore	F3AE3681A	331	450	03/06	>				S 7259 A
VGT filter / filtro VGT	F3AE3681A	331	450	03/06	>				S 0VGT A
2 filters / N.2 filtri	F3AE3681A	331	450	03/06	>	05/07	S 3288 R		
prefilter / prefiltra	F3AE3681A	331	450	03/06	>			S 1999 NR	
power steering / servosterzo	F3AE3681A	331	450	03/06	>				S 3081 PO
spare part only 150.000 km / solo ricambio 150.000 km	F3AE3681A	331	450	10/11	>		S 5111 PE		
440S31 Cursor 8	F2BE0681	228	310	06/03	>	09/04	S 3288 R	S 4396 NR	S 7546 A
	F2BE0681	228	310	10/04	>		S 3288 R	S 4396 NR	S 7600 A
some BLOW-BY filter (504153481) / alcuni filtro BLOW-BY (504153481)	F2BE0681	228	310	06/03	>				S 7266 A
dryer filter / filtro essiccatore	F2BE0681	228	310	06/03	>				S 7259 A
VGT filter / filtro VGT	F2BE0681	228	310	06/03	>				S 0VGT A
prefilter / prefiltra	F2BE0681	228	310	06/03	>	01/04		S 0999 NR	
prefilter / prefiltra	F2BE0681	228	310	01/04	>			S 1999 NR	
power steering / servosterzo	F2BE0681	228	310	06/03	>				S 3081 PO
440S33 Cursor 8	F2BE3681B	243	330	03/06	>		S 3288 R	S 4396 NR	S 7600 A
some BLOW-BY filter (504153481) / alcuni filtro BLOW-BY (504153481)	F2BE3681B	243	330	03/06	>				S 7266 A
with automatic gearbox and hydraulic retarder ZF Ecosplit + Intarder / con cambio automatico e rallentatore idraulico ZF Ecosplit + Intarder	F2BE3681B	243	330	03/06	>				S 2234 Z
with filter Urea/Adblue / con filtro Urea/Adblue	F2BE3681B	243	330	03/06	>				S 4401 U
dryer filter / filtro essiccatore	F2BE3681B	243	330	03/06	>				S 7259 A
VGT filter / filtro VGT	F2BE3681B	243	330	03/06	>				S 0VGT A
prefilter / prefiltra	F2BE3681B	243	330	03/06	>			S 1999 NR	
power steering / servosterzo	F2BE3681B	243	330	03/06	>				S 3081 PO
440S35 Cursor 8	F2BE0681	259	352	06/03	>	09/04	S 3288 R	S 4396 NR	S 7546 A
	F2BE0681	259	352	10/04	>		S 3288 R	S 4396 NR	S 7600 A
some BLOW-BY filter (504153481) / alcuni filtro BLOW-BY (504153481)	F2BE0681	259	352	06/03	>				S 7266 A
dryer filter / filtro essiccatore	F2BE0681	259	352	06/03	>				S 7259 A



...IVECO - trucks/autocarri

VGT filter / filtro VGT	F2BE0681	259	352	06/03	>				S 0VGT A
prefilter / prefiltra	F2BE0681	259	352	06/03	>	01/04		S 0999 NR	
prefilter / prefiltra	F2BE0681	259	352	01/04	>			S 1999 NR	
power steering / servosterzo	F2BE0681	259	352	06/03	>				S 3081 PO
power steering / servosterzo	F2BE0681	259	352	06/03	>				S 8790 PO
440S36 Cursor 8	F2BE3681A	265	360	03/06	>		S 3288 R	S 4396 NR	S 7600 A
some BLOW-BY filter (504153481) / alcuni filtro BLOW-BY (504153481)	F2BE3681A	265	360	03/06	>				S 3078 C
with automatic gearbox and hydraulic retarder ZF Ecosplit + Intarder / con cambio automatico e rallentatore idraulico ZF Ecosplit + Intarder	F2BE3681A	265	360	03/06	>				S 7266 A
with filter Urea/Adblue / con filtro Urea/Adblue	F2BE3681A	265	360	03/06	>				S 2234 Z
dryer filter / filtro essiccatore	F2BE3681A	265	360	03/06	>				S 4401 U
VGT filter / filtro VGT	F2BE3681A	265	360	03/06	>				S 7259 A
prefilter / prefiltra	F2BE3681A	265	360	03/06	>			S 1999 NR	S 0VGT A
power steering / servosterzo	F2BE3681A	265	360	03/06	>				S 3081 PO
440S40 Cursor 10	F3AE0681	294	400	06/03	>	09/04		S 4395 NR	S 7544 A
	F3AE0681	294	400	10/04	>			S 4395 NR	S 7600 A
some BLOW-BY filter (504153481) / alcuni filtro BLOW-BY (504153481)	F3AE0681	294	400	06/03	>				S 3078 C
dryer filter / filtro essiccatore	F3AE0681	294	400	06/03	>				S 7266 A
VGT filter / filtro VGT	F3AE0681	294	400	06/03	>				S 7259 A
2 filters / N.2 filtri	F3AE0681	294	400	06/03	>		S 3288 R		S 0VGT A
prefilter / prefiltra	F3AE0681	294	400	06/03	>	01/04		S 0999 NR	
prefilter / prefiltra	F3AE0681	294	400	01/04	>			S 1999 NR	
power steering / servosterzo	F3AE0681	294	400	06/03	>				S 3081 PO
power steering / servosterzo	F3AE0681	294	400	06/03	>				S 8790 PO
440S42 Cursor 10	F3AE3681D	309	420	03/06	>	05/07		S 1395 NR	S 7600 A
	F3AE3681D	309	420	06/07	>		S 5087 OC	S 1395 NR	S 7600 A
some BLOW-BY filter (504153481) / alcuni filtro BLOW-BY (504153481)	F3AE3681D	309	420	03/06	>				S 3078 C
with automatic gearbox and hydraulic retarder ZF Ecosplit + Intarder / con cambio automatico e rallentatore idraulico ZF Ecosplit + Intarder	F3AE3681D	309	420	03/06	>				S 7266 A
with filter Urea/Adblue / con filtro Urea/Adblue	F3AE3681D	309	420	03/06	>				S 2234 Z
dryer filter / filtro essiccatore	F3AE3681D	309	420	03/06	>				S 4401 U
VGT filter / filtro VGT	F3AE3681D	309	420	03/06	>				S 7259 A
2 filters / N.2 filtri	F3AE3681D	309	420	03/06	>	05/07	S 3288 R		S 0VGT A
prefilter / prefiltra	F3AE3681D	309	420	03/06	>			S 1999 NR	
power steering / servosterzo	F3AE3681D	309	420	03/06	>				S 3081 PO
spare part only 150.000 km / solo ricambio 150.000 km	F3AE3681D	309	420	10/11	>		S 5111 PE		
440S43 Cursor 10	F3AE0681	316	430	06/03	>	09/04		S 4395 NR	S 7544 A
	F3AE0681	316	430	10/04	>			S 4395 NR	S 7600 A
some BLOW-BY filter (504153481) / alcuni filtro BLOW-BY (504153481)	F3AE0681	316	430	06/03	>				S 3078 C
dryer filter / filtro essiccatore	F3AE0681	316	430	06/03	>				S 7266 A
VGT filter / filtro VGT	F3AE0681	316	430	06/03	>				S 7259 A
2 filters / N.2 filtri	F3AE0681	316	430	06/03	>		S 3288 R		S 0VGT A
prefilter / prefiltra	F3AE0681	316	430	06/03	>	01/04		S 0999 NR	
prefilter / prefiltra	F3AE0681	316	430	01/04	>			S 1999 NR	
power steering / servosterzo	F3AE0681	316	430	06/03	>				S 8790 PO
power steering / servosterzo	F3AE0681	316	430	06/03	>				S 3081 PO
440S45 Cursor 10	F3AE3681A	331	450	03/06	>	05/07		S 1395 NR	S 7600 A
	F3AE3681A	331	450	06/07	>		S 5087 OC	S 1395 NR	S 7600 A
some BLOW-BY filter (504153481) / alcuni filtro BLOW-BY (504153481)	F3AE3681A	331	450	03/06	>				S 3078 C
with automatic gearbox and hydraulic retarder ZF Ecosplit + Intarder / con cambio automatico e rallentatore idraulico ZF Ecosplit + Intarder	F3AE3681A	331	450	03/06	>				S 7266 A
with filter Urea/Adblue / con filtro Urea/Adblue	F3AE3681A	331	450	03/06	>				S 2234 Z
dryer filter / filtro essiccatore	F3AE3681A	331	450	03/06	>				S 4401 U
VGT filter / filtro VGT	F3AE3681A	331	450	03/06	>				S 7259 A
2 filters / N.2 filtri	F3AE3681A	331	450	03/06	>	05/07	S 3288 R		S 0VGT A
prefilter / prefiltra	F3AE3681A	331	450	03/06	>			S 1999 NR	
power steering / servosterzo	F3AE3681A	331	450	03/06	>				S 3081 PO
spare part only 150.000 km / solo ricambio 150.000 km	F3AE3681A	331	450	10/11	>		S 5111 PE		
440S50 Cursor 13	F3BE3681B	368	500	03/06	>	05/07		S 1395 NR	S 7600 A
	F3BE3681B	368	500	06/07	>		S 5087 OC	S 1395 NR	S 7600 A
some BLOW-BY filter (504153481) / alcuni filtro BLOW-BY (504153481)	F3BE3681B	368	500	03/06	>				S 3078 C
with automatic gearbox and hydraulic retarder ZF Ecosplit + Intarder / con cambio automatico e rallentatore idraulico ZF Ecosplit + Intarder	F3BE3681B	368	500	03/06	>				S 7266 A
with filter Urea/Adblue / con filtro Urea/Adblue	F3BE3681B	368	500	03/06	>				S 2234 Z
dryer filter / filtro essiccatore	F3BE3681B	368	500	03/06	>				S 4401 U
VGT filter / filtro VGT	F3BE3681B	368	500	03/06	>				S 7259 A
2 filters / N.2 filtri	F3BE3681B	368	500	03/06	>	05/07	S 3288 R		S 0VGT A
prefilter / prefiltra	F3BE3681B	368	500	03/06	>			S 1999 NR	
power steering / servosterzo	F3BE3681B	368	500	03/06	>				S 3081 PO
spare part only 150.000 km / solo ricambio 150.000 km	F3BE3681B	368	500	10/11	>		S 5111 PE		
440S56 Cursor 13	F3BE3681A	412	560	03/06	>	05/07		S 1395 NR	S 7600 A





...IVECO - trucks/autocarri

	F3BE3681A	412	560	06/07	>	S 5087 OC	S 1395 NR	S 7600 A	S 3078 C
some BLOW-BY filter (504153481) / alcuni filtro BLOW-BY (504153481)	F3BE3681A	412	560	03/06	>				S 7266 A
with automatic gearbox and hydraulic retarder ZF Ecosplit + Intarder / con cambio automatico e rallentatore idraulico ZF Ecosplit + Intarder	F3BE3681A	412	560	03/06	>				S 2234 Z
with filter Urea/Adblue / con filtro Urea/Adblue	F3BE3681A	412	560	03/06	>				S 4401 U
dryer filter / filtro essiccatore	F3BE3681A	412	560	03/06	>				S 7259 A
VGT filter / filtro VGT	F3BE3681A	412	560	03/06	>				S 0VGT A
2 filters / N.2 filtri	F3BE3681A	412	560	03/06	>	05/07 S 3288 R			
prefilter / prefiltra	F3BE3681A	412	560	03/06	>		S 1999 NR		
power steering / servosterzo	F3BE3681A	412	560	03/06	>				S 3081 PO
spare part only 150.000 km / solo ricambio 150.000 km	F3BE3681A	412	560	10/11	>	S 5111 PE			

Stralis ES

190S48 Cursor 13		353	480	09/04	>		S 4395 NR	S 7600 A	S 3078 C
some BLOW-BY filter (504153481) / alcuni filtro BLOW-BY (504153481)		353	480	09/04	>				S 7266 A
dryer filter / filtro essiccatore		353	480	09/04	>				S 7259 A
VGT filter / filtro VGT		353	480	09/04	>				S 0VGT A
2 filters / N.2 filtri		353	480	09/04	>	S 3288 R			
prefilter / prefiltra		353	480	09/04	>		S 1999 NR		
power steering / servosterzo		353	480	09/04	>				S 3081 PO
260S48 Cursor 13		353	480	09/04	>		S 4395 NR	S 7600 A	S 3078 C
some BLOW-BY filter (504153481) / alcuni filtro BLOW-BY (504153481)		353	480	09/04	>				S 7266 A
dryer filter / filtro essiccatore		353	480	09/04	>				S 7259 A
VGT filter / filtro VGT		353	480	09/04	>				S 0VGT A
2 filters / N.2 filtri		353	480	09/04	>	S 3288 R			
prefilter / prefiltra		353	480	09/04	>		S 1999 NR		
power steering / servosterzo		353	480	09/04	>				S 3081 PO
260S54 Cursor 13		397	540	09/04	>		S 4395 NR	S 7600 A	S 3078 C
some BLOW-BY filter (504153481) / alcuni filtro BLOW-BY (504153481)		397	540	09/04	>				S 7266 A
dryer filter / filtro essiccatore		397	540	09/04	>				S 7259 A
VGT filter / filtro VGT		397	540	09/04	>				S 0VGT A
2 filters / N.2 filtri		397	540	09/04	>	S 3288 R			
prefilter / prefiltra		397	540	09/04	>		S 1999 NR		
power steering / servosterzo		397	540	09/04	>				S 3081 PO
440S48 Cursor 13		353	480	09/04	>		S 4395 NR	S 7600 A	S 3078 C
some BLOW-BY filter (504153481) / alcuni filtro BLOW-BY (504153481)		353	480	09/04	>				S 7266 A
dryer filter / filtro essiccatore		353	480	09/04	>				S 7259 A
VGT filter / filtro VGT		353	480	09/04	>				S 0VGT A
2 filters / N.2 filtri		353	480	09/04	>	S 3288 R			
prefilter / prefiltra		353	480	09/04	>		S 1999 NR		
power steering / servosterzo		353	480	09/04	>				S 3081 PO
440S54 Cursor 13		397	540	09/04	>		S 4395 NR	S 7600 A	S 3078 C
some BLOW-BY filter (504153481) / alcuni filtro BLOW-BY (504153481)		397	540	09/04	>				S 7266 A
dryer filter / filtro essiccatore		397	540	09/04	>				S 7259 A
VGT filter / filtro VGT		397	540	09/04	>				S 0VGT A
2 filters / N.2 filtri		397	540	09/04	>	S 3288 R			
prefilter / prefiltra		397	540	09/04	>		S 1999 NR		
power steering / servosterzo		397	540	09/04	>				S 3081 PO

Stralis Hi-Road

AT190S31 Cursor9 E6	F2CFE611D	228	310	01/13	>	S 5102 PE	S 6043 NE		S 4402 U
with filter Urea/Adblue SCR Denoxtronic 2 / con filtro Urea/Adblue SCR Denoxtronic 2	F2CFE611D	228	310	01/13	>				
prefilter / prefiltra	F2CFE611D	228	310	01/13	>		S 4474 NR		
prefilter Urea/Adblue SCR Denoxtronic 2 / prefiltra Urea/Adblue SCR Denoxtronic 2	F2CFE611D	228	310	01/13	>				S 4406 U
AT190S33 Cursor9 E6	F2CFE611C	243	330	01/13	>	S 5102 PE	S 6043 NE		
prefilter / prefiltra	F2CFE611C	243	330	01/13	>		S 4474 NR		
AT190S36 Cursor9 E6	F2CFE611B	265	360	01/13	>	S 5102 PE	S 6043 NE		
prefilter / prefiltra	F2CFE611B	265	360	01/13	>		S 4474 NR		
AT190S40 Cursor9 E6	F2CFE611A	294	400	01/13	>	S 5102 PE	S 6043 NE		
prefilter / prefiltra	F2CFE611A	294	400	01/13	>		S 4474 NR		
AT190S42 Cursor11 E6	F3GFE611D	309	420	01/13	>	S 5102 PE	S 6044 NE	S 7600 A	S 3078 C
with activated carbons / ai carboni attivi	F3GFE611D	309	420	01/13	>				S 4346 CA
some dryer filter / alcuni filtro essiccatore	F3GFE611D	309	420	01/13	>				S 7A66 A
with automatic gearbox ZF Ecosplit + Intarder / con cambio automatico ZF Ecosplit + Intarder	F3GFE611D	309	420	01/13	>				S 2234 Z
with filter Urea/Adblue SCR Denoxtronic 2 / con filtro Urea/Adblue SCR Denoxtronic 2	F3GFE611D	309	420	01/13	>				S 4402 U
with filter Urea/Adblue SCR Denoxtronic 2.2 / con filtro Urea/Adblue SCR Denoxtronic 2.2	F3GFE611D	309	420	01/13	>				S 4405 U
dryer filter / filtro essiccatore	F3GFE611D	309	420	01/13	>				S 7259 A
prefilter / prefiltra	F3GFE611D	309	420	01/13	>		S 4474 NR		
prefilter Urea/Adblue SCR Denoxtronic 2 / prefiltra Urea/Adblue SCR Denoxtronic 2	F3GFE611D	309	420	01/13	>				S 4406 U
power steering / servosterzo	F3GFE611D	309	420	01/13	>				S 3081 PO



...IVECO - trucks/autocarri

power steering ZF Servocom RAS-EC / servosterzo ZF Servocom RAS-EC	F3GFE611D	309	420	01/13	>				S 5664 PO
AT190S46 Cursor11 E6	F3GFE611B	338	460	01/13	>	S 5102 PE	S 6044 NE	S 7600 A	S 3078 C
with activated carbons / ai carboni attivi	F3GFE611B	338	460	01/13	>				S 4346 CA
some dryer filter / alcuni filtro essiccatore	F3GFE611B	338	460	01/13	>				S 7A66 A
with automatic gearbox ZF Ecosplit + Intarder / con cambio automatico ZF Ecosplit + Intarder	F3GFE611B	338	460	01/13	>				S 2234 Z
with filter Urea/Adblue SCR Denoxtronic 2 / con filtro Urea/Adblue SCR Denoxtronic 2	F3GFE611B	338	460	01/13	>				S 4402 U
with filter Urea/Adblue SCR Denoxtronic 2.2 / con filtro Urea/Adblue SCR Denoxtronic 2.2	F3GFE611B	338	460	01/13	>				S 4405 U
dryer filter / filtro essiccatore	F3GFE611B	338	460	01/13	>				S 7259 A
prefilter / prefiltra	F3GFE611B	338	460	01/13	>		S 4474 NR		
prefilter Urea/Adblue SCR Denoxtronic 2 / prefiltra Urea/Adblue SCR Denoxtronic 2	F3GFE611B	338	460	01/13	>				S 4406 U
power steering / servosterzo	F3GFE611B	338	460	01/13	>				S 3081 PO
power steering ZF Servocom RAS-EC / servosterzo ZF Servocom RAS-EC	F3GFE611B	338	460	01/13	>				S 5664 PO
AT190S48 Cursor11 E6	F3GFE611A	353	480	01/13	>	S 5102 PE	S 6044 NE	S 7600 A	S 3078 C
with activated carbons / ai carboni attivi	F3GFE611A	353	480	01/13	>				S 4346 CA
some dryer filter / alcuni filtro essiccatore	F3GFE611A	353	480	01/13	>				S 7A66 A
with automatic gearbox ZF Ecosplit + Intarder / con cambio automatico ZF Ecosplit + Intarder	F3GFE611A	353	480	01/13	>				S 2234 Z
with filter Urea/Adblue SCR Denoxtronic 2 / con filtro Urea/Adblue SCR Denoxtronic 2	F3GFE611A	353	480	01/13	>				S 4402 U
with filter Urea/Adblue SCR Denoxtronic 2.2 / con filtro Urea/Adblue SCR Denoxtronic 2.2	F3GFE611A	353	480	01/13	>				S 4405 U
dryer filter / filtro essiccatore	F3GFE611A	353	480	01/13	>				S 7259 A
prefilter / prefiltra	F3GFE611A	353	480	01/13	>		S 4474 NR		
prefilter Urea/Adblue SCR Denoxtronic 2 / prefiltra Urea/Adblue SCR Denoxtronic 2	F3GFE611A	353	480	01/13	>				S 4406 U
power steering / servosterzo	F3GFE611A	353	480	01/13	>				S 3081 PO
power steering ZF Servocom RAS-EC / servosterzo ZF Servocom RAS-EC	F3GFE611A	353	480	01/13	>				S 5664 PO
AT260S31 Cursor9 E6	F2CFE611D	228	310	01/13	>	S 5102 PE	S 6043 NE		
prefilter / prefiltra	F2CFE611D	228	310	01/13	>		S 4474 NR		
AT260S33 Cursor9 E6	F2CFE611C	243	330	01/13	>	S 5102 PE	S 6043 NE		
prefilter / prefiltra	F2CFE611C	243	330	01/13	>		S 4474 NR		
AT260S36 Cursor9 E6	F2CFE611B	265	360	01/13	>	S 5102 PE	S 6043 NE		
prefilter / prefiltra	F2CFE611B	265	360	01/13	>		S 4474 NR		
AT260S40 Cursor9 E6	F2CFE611A	294	400	01/13	>	S 5102 PE	S 6043 NE		
prefilter / prefiltra	F2CFE611A	294	400	01/13	>		S 4474 NR		
AT260S42 Cursor11 E6	F3GFE611D	309	420	01/13	>	S 5102 PE	S 6044 NE	S 7600 A	S 3078 C
with activated carbons / ai carboni attivi	F3GFE611D	309	420	01/13	>				S 4346 CA
some dryer filter / alcuni filtro essiccatore	F3GFE611D	309	420	01/13	>				S 7A66 A
with automatic gearbox ZF Ecosplit + Intarder / con cambio automatico ZF Ecosplit + Intarder	F3GFE611D	309	420	01/13	>				S 2234 Z
with filter Urea/Adblue SCR Denoxtronic 2 / con filtro Urea/Adblue SCR Denoxtronic 2	F3GFE611D	309	420	01/13	>				S 4402 U
with filter Urea/Adblue SCR Denoxtronic 2.2 / con filtro Urea/Adblue SCR Denoxtronic 2.2	F3GFE611D	309	420	01/13	>				S 4405 U
dryer filter / filtro essiccatore	F3GFE611D	309	420	01/13	>				S 7259 A
prefilter / prefiltra	F3GFE611D	309	420	01/13	>		S 4474 NR		
prefilter Urea/Adblue SCR Denoxtronic 2 / prefiltra Urea/Adblue SCR Denoxtronic 2	F3GFE611D	309	420	01/13	>				S 4406 U
power steering / servosterzo	F3GFE611D	309	420	01/13	>				S 3081 PO
power steering ZF Servocom RAS-EC / servosterzo ZF Servocom RAS-EC	F3GFE611D	309	420	01/13	>				S 5664 PO
AT260S46 Cursor11 E6	F3GFE611B	338	460	01/13	>	S 5102 PE	S 6044 NE	S 7600 A	S 3078 C
with activated carbons / ai carboni attivi	F3GFE611B	338	460	01/13	>				S 4346 CA
some dryer filter / alcuni filtro essiccatore	F3GFE611B	338	460	01/13	>				S 7A66 A
with automatic gearbox ZF Ecosplit + Intarder / con cambio automatico ZF Ecosplit + Intarder	F3GFE611B	338	460	01/13	>				S 2234 Z
with filter Urea/Adblue SCR Denoxtronic 2 / con filtro Urea/Adblue SCR Denoxtronic 2	F3GFE611B	338	460	01/13	>				S 4402 U
with filter Urea/Adblue SCR Denoxtronic 2.2 / con filtro Urea/Adblue SCR Denoxtronic 2.2	F3GFE611B	338	460	01/13	>				S 4405 U
dryer filter / filtro essiccatore	F3GFE611B	338	460	01/13	>				S 7259 A
prefilter / prefiltra	F3GFE611B	338	460	01/13	>		S 4474 NR		
prefilter Urea/Adblue SCR Denoxtronic 2 / prefiltra Urea/Adblue SCR Denoxtronic 2	F3GFE611B	338	460	01/13	>				S 4406 U
power steering / servosterzo	F3GFE611B	338	460	01/13	>				S 3081 PO
power steering ZF Servocom RAS-EC / servosterzo ZF Servocom RAS-EC	F3GFE611B	338	460	01/13	>				S 5664 PO
AT260S48 Cursor11 E6	F3GFE611A	353	480	01/13	>	S 5102 PE	S 6044 NE	S 7600 A	S 3078 C
with activated carbons / ai carboni attivi	F3GFE611A	353	480	01/13	>				S 4346 CA
some dryer filter / alcuni filtro essiccatore	F3GFE611A	353	480	01/13	>				S 7A66 A
with automatic gearbox ZF Ecosplit + Intarder / con cambio automatico ZF Ecosplit + Intarder	F3GFE611A	353	480	01/13	>				S 2234 Z
with filter Urea/Adblue SCR Denoxtronic 2 / con filtro Urea/Adblue SCR Denoxtronic 2	F3GFE611A	353	480	01/13	>				S 4402 U
with filter Urea/Adblue SCR Denoxtronic 2.2 / con filtro Urea/Adblue SCR Denoxtronic 2.2	F3GFE611A	353	480	01/13	>				S 4405 U
dryer filter / filtro essiccatore	F3GFE611A	353	480	01/13	>				S 7259 A
prefilter / prefiltra	F3GFE611A	353	480	01/13	>		S 4474 NR		
prefilter Urea/Adblue SCR Denoxtronic 2 / prefiltra Urea/Adblue SCR Denoxtronic 2	F3GFE611A	353	480	01/13	>				S 4406 U
power steering / servosterzo	F3GFE611A	353	480	01/13	>				S 3081 PO
power steering ZF Servocom RAS-EC / servosterzo ZF Servocom RAS-EC	F3GFE611A	353	480	01/13	>				S 5664 PO
AT260S50 Cursor13 E6	F3HFE611B	368	500	01/13	>		S 4474 NR		
prefilter / prefiltra	F3HFE611B	368	500	01/13	>				
AT260S56 Cursor13 E6									





...IVECO - trucks/autocarri

prefilter / prefiltro	F3HFE611A	412	560	01/13	>		S 4474 NR		
AT440S36 Cursor9 E6	F2CFE611B	265	360	01/13	>	S 5102 PE	S 6043 NE		
prefilter / prefiltro	F2CFE611B	265	360	01/13	>		S 4474 NR		
AT440S40 Cursor9 E6	F2CFE611A	294	440	01/13	>	S 5102 PE	S 6043 NE		
prefilter / prefiltro	F2CFE611A	294	440	01/13	>		S 4474 NR		
AT440S42 Cursor11 E6	F3GFE611D	309	420	01/13	>	S 5102 PE	S 6044 NE	S 7600 A	S 3078 C
with activated carbons / ai carboni attivi	F3GFE611D	309	420	01/13	>				S 4346 CA
some dryer filter / alcuni filtro essiccatore	F3GFE611D	309	420	01/13	>				S 7A66 A
with automatic gearbox ZF Ecosplit + Intarder / con cambio automatico ZF Ecosplit + Intarder	F3GFE611D	309	420	01/13	>				S 2234 Z
with filter Urea/Adblue SCR Denoxtronic 2 / con filtro Urea/Adblue SCR Denoxtronic 2	F3GFE611D	309	420	01/13	>				S 4402 U
with filter Urea/Adblue SCR Denoxtronic 2.2 / con filtro Urea/Adblue SCR Denoxtronic 2.2	F3GFE611D	309	420	01/13	>				S 4405 U
dryer filter / filtro essiccatore	F3GFE611D	309	420	01/13	>				S 7259 A
prefilter / prefiltro	F3GFE611D	309	420	01/13	>		S 4474 NR		
prefilter Urea/Adblue SCR Denoxtronic 2 / prefiltro Urea/Adblue SCR Denoxtronic 2	F3GFE611D	309	420	01/13	>				S 4406 U
power steering / servosterzo	F3GFE611D	309	420	01/13	>				S 3081 PO
power steering ZF Servocom RAS-EC / servosterzo ZF Servocom RAS-EC	F3GFE611D	309	420	01/13	>				S 5664 PO
AT440S46 Cursor11 E6	F3GFE611B	338	460	01/13	>	S 5102 PE	S 6044 NE	S 7600 A	S 3078 C
with activated carbons / ai carboni attivi	F3GFE611B	338	460	01/13	>				S 4346 CA
some dryer filter / alcuni filtro essiccatore	F3GFE611B	338	460	01/13	>				S 7A66 A
with automatic gearbox ZF Ecosplit + Intarder / con cambio automatico ZF Ecosplit + Intarder	F3GFE611B	338	460	01/13	>				S 2234 Z
with filter Urea/Adblue SCR Denoxtronic 2 / con filtro Urea/Adblue SCR Denoxtronic 2	F3GFE611B	338	460	01/13	>				S 4402 U
with filter Urea/Adblue SCR Denoxtronic 2.2 / con filtro Urea/Adblue SCR Denoxtronic 2.2	F3GFE611B	338	460	01/13	>				S 4405 U
dryer filter / filtro essiccatore	F3GFE611B	338	460	01/13	>				S 7259 A
prefilter / prefiltro	F3GFE611B	338	460	01/13	>		S 4474 NR		
prefilter Urea/Adblue SCR Denoxtronic 2 / prefiltro Urea/Adblue SCR Denoxtronic 2	F3GFE611B	338	460	01/13	>				S 4406 U
power steering / servosterzo	F3GFE611B	338	460	01/13	>				S 3081 PO
power steering ZF Servocom RAS-EC / servosterzo ZF Servocom RAS-EC	F3GFE611B	338	460	01/13	>				S 5664 PO
AT440S48 Cursor11 E6	F3GFE611A	353	480	01/13	>	S 5102 PE	S 6044 NE	S 7600 A	S 3078 C
with activated carbons / ai carboni attivi	F3GFE611A	353	480	01/13	>				S 4346 CA
some dryer filter / alcuni filtro essiccatore	F3GFE611A	353	480	01/13	>				S 7A66 A
with automatic gearbox ZF Ecosplit + Intarder / con cambio automatico ZF Ecosplit + Intarder	F3GFE611A	353	480	01/13	>				S 2234 Z
with filter Urea/Adblue SCR Denoxtronic 2 / con filtro Urea/Adblue SCR Denoxtronic 2	F3GFE611A	353	480	01/13	>				S 4402 U
with filter Urea/Adblue SCR Denoxtronic 2.2 / con filtro Urea/Adblue SCR Denoxtronic 2.2	F3GFE611A	353	480	01/13	>				S 4405 U
dryer filter / filtro essiccatore	F3GFE611A	353	480	01/13	>				S 7259 A
prefilter / prefiltro	F3GFE611A	353	480	01/13	>		S 4474 NR		
prefilter Urea/Adblue SCR Denoxtronic 2 / prefiltro Urea/Adblue SCR Denoxtronic 2	F3GFE611A	353	480	01/13	>				S 4406 U
power steering / servosterzo	F3GFE611A	353	480	01/13	>				S 3081 PO
power steering ZF Servocom RAS-EC / servosterzo ZF Servocom RAS-EC	F3GFE611A	353	480	01/13	>				S 5664 PO
Stralis Hi-Street									
AD190S31 Cursor9 E6	F2CFE611D	228	310	01/13	>	S 5102 PE	S 6043 NE	S 7600 A	S 3078 C
some dryer filter / alcuni filtro essiccatore	F2CFE611D	228	310	01/13	>				S 7A66 A
with automatic gearbox ZF Ecosplit + Intarder / con cambio automatico ZF Ecosplit + Intarder	F2CFE611D	228	310	01/13	>				S 2234 Z
with activated carbon air-conditioner / con climatizzatore, ai carboni attivi	F2CFE611D	228	310	01/13	>				S 4346 CA
with filter Urea/Adblue SCR Denoxtronic 2 / con filtro Urea/Adblue SCR Denoxtronic 2	F2CFE611D	228	310	01/13	>				S 4402 U
with filter Urea/Adblue SCR Denoxtronic 2.2 / con filtro Urea/Adblue SCR Denoxtronic 2.2	F2CFE611D	228	310	01/13	>				S 4405 U
dryer filter / filtro essiccatore	F2CFE611D	228	310	01/13	>				S 7259 A
prefilter / prefiltro	F2CFE611D	228	310	01/13	>		S 4474 NR		
prefilter Urea/Adblue SCR Denoxtronic 2 / prefiltro Urea/Adblue SCR Denoxtronic 2	F2CFE611D	228	310	01/13	>				S 4406 U
power steering / servosterzo	F2CFE611D	228	310	01/13	>				S 3081 PO
power steering ZF Servocom RAS-EC / servosterzo ZF Servocom RAS-EC	F2CFE611D	228	310	01/13	>				S 5664 PO
AD190S33 Cursor9 E6	F2CFE611C	243	330	01/13	>	S 5102 PE	S 6043 NE	S 7600 A	S 3078 C
some dryer filter / alcuni filtro essiccatore	F2CFE611C	243	330	01/13	>				S 7A66 A
with automatic gearbox ZF Ecosplit + Intarder / con cambio automatico ZF Ecosplit + Intarder	F2CFE611C	243	330	01/13	>				S 2234 Z
with activated carbon air-conditioner / con climatizzatore, ai carboni attivi	F2CFE611C	243	330	01/13	>				S 4346 CA
with filter Urea/Adblue SCR Denoxtronic 2 / con filtro Urea/Adblue SCR Denoxtronic 2	F2CFE611C	243	330	01/13	>				S 4402 U
with filter Urea/Adblue SCR Denoxtronic 2.2 / con filtro Urea/Adblue SCR Denoxtronic 2.2	F2CFE611C	243	330	01/13	>				S 4405 U
dryer filter / filtro essiccatore	F2CFE611C	243	330	01/13	>				S 7259 A
prefilter / prefiltro	F2CFE611C	243	330	01/13	>		S 4474 NR		
prefilter Urea/Adblue SCR Denoxtronic 2 / prefiltro Urea/Adblue SCR Denoxtronic 2	F2CFE611C	243	330	01/13	>				S 4406 U
power steering / servosterzo	F2CFE611C	243	330	01/13	>				S 3081 PO
power steering ZF Servocom RAS-EC / servosterzo ZF Servocom RAS-EC	F2CFE611C	243	330	01/13	>				S 5664 PO
AD190S36 Cursor9 E6	F2CFE611B	265	360	01/13	>	S 5102 PE	S 6043 NE	S 7600 A	S 3078 C
some dryer filter / alcuni filtro essiccatore	F2CFE611B	265	360	01/13	>				S 7A66 A
with automatic gearbox ZF Ecosplit + Intarder / con cambio automatico ZF Ecosplit + Intarder	F2CFE611B	265	360	01/13	>				S 2234 Z
with activated carbon air-conditioner / con climatizzatore, ai carboni attivi	F2CFE611B	265	360	01/13	>				S 4346 CA
with filter Urea/Adblue SCR Denoxtronic 2 / con filtro Urea/Adblue SCR Denoxtronic 2	F2CFE611B	265	360	01/13	>				S 4402 U
with filter Urea/Adblue SCR Denoxtronic 2.2 / con filtro Urea/Adblue SCR Denoxtronic 2.2	F2CFE611B	265	360	01/13	>				S 4405 U



...IVECO - trucks/autocarri

dryer filter / filtro essiccatore	F2CFE611B	265	360	01/13	>				S 7259 A
prefilter / prefiltrato	F2CFE611B	265	360	01/13	>		S 4474 NR		
prefilter Urea/Adblue SCR Denoxtronic 2 / prefiltrato Urea/Adblue SCR Denoxtronic 2	F2CFE611B	265	360	01/13	>				S 4406 U
power steering / servosterzo	F2CFE611B	265	360	01/13	>				S 3081 PO
power steering ZF Servocom RAS-EC / servosterzo ZF Servocom RAS-EC	F2CFE611B	265	360	01/13	>				S 5664 PO
AD190S40 Cursor9 E6	F2CFE611A	294	400	01/13	>	S 5102 PE	S 6043 NE	S 7600 A	S 3078 C
some dryer filter / alcuni filtro essiccatore	F2CFE611A	294	400	01/13	>				S 7A66 A
with automatic gearbox ZF Ecosplit + Intarder / con cambio automatico ZF Ecosplit + Intarder	F2CFE611A	294	400	01/13	>				S 2234 Z
with activated carbon air-conditioner / con climatizzatore, ai carboni attivi	F2CFE611A	294	400	01/13	>				S 4346 CA
with filter Urea/Adblue SCR Denoxtronic 2 / con filtro Urea/Adblue SCR Denoxtronic 2	F2CFE611A	294	400	01/13	>				S 4402 U
with filter Urea/Adblue SCR Denoxtronic 2.2 / con filtro Urea/Adblue SCR Denoxtronic 2.2	F2CFE611A	294	400	01/13	>				S 4405 U
dryer filter / filtro essiccatore	F2CFE611A	294	400	01/13	>				S 7259 A
prefilter / prefiltrato	F2CFE611A	294	400	01/13	>		S 4474 NR		
prefilter Urea/Adblue SCR Denoxtronic 2 / prefiltrato Urea/Adblue SCR Denoxtronic 2	F2CFE611A	294	400	01/13	>				S 4406 U
power steering / servosterzo	F2CFE611A	294	400	01/13	>				S 3081 PO
power steering ZF Servocom RAS-EC / servosterzo ZF Servocom RAS-EC	F2CFE611A	294	400	01/13	>				S 5664 PO
AD190S42 Cursor11 E6	F3GFE611D	309	420	01/13	>	S 5102 PE	S 6044 NE	S 7600 A	S 3078 C
with activated carbons / ai carboni attivi	F3GFE611D	309	420	01/13	>				S 4346 CA
some dryer filter / alcuni filtro essiccatore	F3GFE611D	309	420	01/13	>				S 7A66 A
with automatic gearbox ZF Ecosplit + Intarder / con cambio automatico ZF Ecosplit + Intarder	F3GFE611D	309	420	01/13	>				S 2234 Z
with filter Urea/Adblue SCR Denoxtronic 2 / con filtro Urea/Adblue SCR Denoxtronic 2	F3GFE611D	309	420	01/13	>				S 4402 U
with filter Urea/Adblue SCR Denoxtronic 2.2 / con filtro Urea/Adblue SCR Denoxtronic 2.2	F3GFE611D	309	420	01/13	>				S 4405 U
dryer filter / filtro essiccatore	F3GFE611D	309	420	01/13	>				S 7259 A
prefilter / prefiltrato	F3GFE611D	309	420	01/13	>		S 4474 NR		
prefilter Urea/Adblue SCR Denoxtronic 2 / prefiltrato Urea/Adblue SCR Denoxtronic 2	F3GFE611D	309	420	01/13	>				S 4406 U
power steering / servosterzo	F3GFE611D	309	420	01/13	>				S 3081 PO
power steering ZF Servocom RAS-EC / servosterzo ZF Servocom RAS-EC	F3GFE611D	309	420	01/13	>				S 5664 PO
AD190S46 Cursor11 E6	F3GFE611B	338	460	01/13	>	S 5102 PE	S 6044 NE	S 7600 A	S 3078 C
with activated carbons / ai carboni attivi	F3GFE611B	338	460	01/13	>				S 4346 CA
some dryer filter / alcuni filtro essiccatore	F3GFE611B	338	460	01/13	>				S 7A66 A
with automatic gearbox ZF Ecosplit + Intarder / con cambio automatico ZF Ecosplit + Intarder	F3GFE611B	338	460	01/13	>				S 2234 Z
with filter Urea/Adblue SCR Denoxtronic 2 / con filtro Urea/Adblue SCR Denoxtronic 2	F3GFE611B	338	460	01/13	>				S 4402 U
with filter Urea/Adblue SCR Denoxtronic 2.2 / con filtro Urea/Adblue SCR Denoxtronic 2.2	F3GFE611B	338	460	01/13	>				S 4405 U
dryer filter / filtro essiccatore	F3GFE611B	338	460	01/13	>				S 7259 A
prefilter / prefiltrato	F3GFE611B	338	460	01/13	>		S 4474 NR		
prefilter Urea/Adblue SCR Denoxtronic 2 / prefiltrato Urea/Adblue SCR Denoxtronic 2	F3GFE611B	338	460	01/13	>				S 4406 U
power steering / servosterzo	F3GFE611B	338	460	01/13	>				S 3081 PO
power steering ZF Servocom RAS-EC / servosterzo ZF Servocom RAS-EC	F3GFE611B	338	460	01/13	>				S 5664 PO
AD190S48 Cursor11 E6	F3GFE611A	353	480	01/13	>	S 5102 PE	S 6044 NE	S 7600 A	S 3078 C
with activated carbons / ai carboni attivi	F3GFE611A	353	480	01/13	>				S 4346 CA
some dryer filter / alcuni filtro essiccatore	F3GFE611A	353	480	01/13	>				S 7A66 A
with automatic gearbox ZF Ecosplit + Intarder / con cambio automatico ZF Ecosplit + Intarder	F3GFE611A	353	480	01/13	>				S 2234 Z
with filter Urea/Adblue SCR Denoxtronic 2 / con filtro Urea/Adblue SCR Denoxtronic 2	F3GFE611A	353	480	01/13	>				S 4402 U
with filter Urea/Adblue SCR Denoxtronic 2.2 / con filtro Urea/Adblue SCR Denoxtronic 2.2	F3GFE611A	353	480	01/13	>				S 4405 U
dryer filter / filtro essiccatore	F3GFE611A	353	480	01/13	>				S 7259 A
prefilter / prefiltrato	F3GFE611A	353	480	01/13	>		S 4474 NR		
prefilter Urea/Adblue SCR Denoxtronic 2 / prefiltrato Urea/Adblue SCR Denoxtronic 2	F3GFE611A	353	480	01/13	>				S 4406 U
power steering / servosterzo	F3GFE611A	353	480	01/13	>				S 3081 PO
power steering ZF Servocom RAS-EC / servosterzo ZF Servocom RAS-EC	F3GFE611A	353	480	01/13	>				S 5664 PO
AD260S31 Cursor9 E6	F2CFE611D	228	310	01/13	>	S 5102 PE	S 6043 NE	S 7600 A	S 3078 C
some dryer filter / alcuni filtro essiccatore	F2CFE611D	228	310	01/13	>				S 7A66 A
with automatic gearbox ZF Ecosplit + Intarder / con cambio automatico ZF Ecosplit + Intarder	F2CFE611D	228	310	01/13	>				S 2234 Z
with activated carbon air-conditioner / con climatizzatore, ai carboni attivi	F2CFE611D	228	310	01/13	>				S 4346 CA
with filter Urea/Adblue SCR Denoxtronic 2 / con filtro Urea/Adblue SCR Denoxtronic 2	F2CFE611D	228	310	01/13	>				S 4402 U
with filter Urea/Adblue SCR Denoxtronic 2.2 / con filtro Urea/Adblue SCR Denoxtronic 2.2	F2CFE611D	228	310	01/13	>				S 4405 U
dryer filter / filtro essiccatore	F2CFE611D	228	310	01/13	>				S 7259 A
prefilter / prefiltrato	F2CFE611D	228	310	01/13	>		S 4474 NR		
prefilter Urea/Adblue SCR Denoxtronic 2 / prefiltrato Urea/Adblue SCR Denoxtronic 2	F2CFE611D	228	310	01/13	>				S 4406 U
power steering / servosterzo	F2CFE611D	228	310	01/13	>				S 3081 PO
power steering ZF Servocom RAS-EC / servosterzo ZF Servocom RAS-EC	F2CFE611D	228	310	01/13	>				S 5664 PO
AD260S33 Cursor9 E6	F2CFE611C	243	330	01/13	>	S 5102 PE	S 6043 NE	S 7600 A	S 3078 C
some dryer filter / alcuni filtro essiccatore	F2CFE611C	243	330	01/13	>				S 7A66 A
with automatic gearbox ZF Ecosplit + Intarder / con cambio automatico ZF Ecosplit + Intarder	F2CFE611C	243	330	01/13	>				S 2234 Z
with activated carbon air-conditioner / con climatizzatore, ai carboni attivi	F2CFE611C	243	330	01/13	>				S 4346 CA
with filter Urea/Adblue SCR Denoxtronic 2 / con filtro Urea/Adblue SCR Denoxtronic 2	F2CFE611C	243	330	01/13	>				S 4402 U
with filter Urea/Adblue SCR Denoxtronic 2.2 / con filtro Urea/Adblue SCR Denoxtronic 2.2	F2CFE611C	243	330	01/13	>				S 4405 U
dryer filter / filtro essiccatore	F2CFE611C	243	330	01/13	>				S 7259 A

**KW HP****...IVECO - trucks/autocarri**

prefilter / prefiltrato	F2CFE611C	243	330	01/13	>		S 4474 NR		S 4406 U
prefilter Urea/Adblue SCR Denoxtronic 2 / prefiltrato Urea/Adblue SCR Denoxtronic 2	F2CFE611C	243	330	01/13	>				S 3081 PO
power steering / servosterzo	F2CFE611C	243	330	01/13	>				S 5664 PO
power steering ZF Servocom RAS-EC / servosterzo ZF Servocom RAS-EC	F2CFE611C	243	330	01/13	>				S 5664 PO
AD260S36 Cursor9 E6	F2CFE611B	265	360	01/13	>	S 5102 PE	S 6043 NE	S 7600 A	S 3078 C
some dryer filter / alcuni filtro essiccatore	F2CFE611B	265	360	01/13	>				S 7A66 A
with automatic gearbox ZF Ecosplit + Intarder / con cambio automatico ZF Ecosplit + Intarder	F2CFE611B	265	360	01/13	>				S 2234 Z
with activated carbon air-conditioner / con climatizzatore, ai carboni attivi	F2CFE611B	265	360	01/13	>				S 4346 CA
with filter Urea/Adblue SCR Denoxtronic 2 / con filtro Urea/Adblue SCR Denoxtronic 2	F2CFE611B	265	360	01/13	>				S 4402 U
with filter Urea/Adblue SCR Denoxtronic 2.2 / con filtro Urea/Adblue SCR Denoxtronic 2.2	F2CFE611B	265	360	01/13	>				S 4405 U
dryer filter / filtro essiccatore	F2CFE611B	265	360	01/13	>				S 7259 A
prefilter / prefiltrato	F2CFE611B	265	360	01/13	>		S 4474 NR		
prefilter Urea/Adblue SCR Denoxtronic 2 / prefiltrato Urea/Adblue SCR Denoxtronic 2	F2CFE611B	265	360	01/13	>				S 4406 U
power steering / servosterzo	F2CFE611B	265	360	01/13	>				S 3081 PO
power steering ZF Servocom RAS-EC / servosterzo ZF Servocom RAS-EC	F2CFE611B	265	360	01/13	>				S 5664 PO
AD260S40 Cursor9 E6	F2CFE611A	294	400	01/13	>	S 5102 PE	S 6043 NE	S 7600 A	S 3078 C
some dryer filter / alcuni filtro essiccatore	F2CFE611A	294	400	01/13	>				S 7A66 A
with automatic gearbox ZF Ecosplit + Intarder / con cambio automatico ZF Ecosplit + Intarder	F2CFE611A	294	400	01/13	>				S 2234 Z
with activated carbon air-conditioner / con climatizzatore, ai carboni attivi	F2CFE611A	294	400	01/13	>				S 4346 CA
with filter Urea/Adblue SCR Denoxtronic 2 / con filtro Urea/Adblue SCR Denoxtronic 2	F2CFE611A	294	400	01/13	>				S 4402 U
with filter Urea/Adblue SCR Denoxtronic 2.2 / con filtro Urea/Adblue SCR Denoxtronic 2.2	F2CFE611A	294	400	01/13	>				S 4405 U
dryer filter / filtro essiccatore	F2CFE611A	294	400	01/13	>				S 7259 A
prefilter / prefiltrato	F2CFE611A	294	400	01/13	>		S 4474 NR		
prefilter Urea/Adblue SCR Denoxtronic 2 / prefiltrato Urea/Adblue SCR Denoxtronic 2	F2CFE611A	294	400	01/13	>				S 4406 U
power steering / servosterzo	F2CFE611A	294	400	01/13	>				S 3081 PO
power steering ZF Servocom RAS-EC / servosterzo ZF Servocom RAS-EC	F2CFE611A	294	400	01/13	>				S 5664 PO
AD260S42 Cursor11 E6	F3GFE611D	309	420	01/13	>	S 5102 PE	S 6044 NE	S 7600 A	S 3078 C
with activated carbons / ai carboni attivi	F3GFE611D	309	420	01/13	>				S 4346 CA
some dryer filter / alcuni filtro essiccatore	F3GFE611D	309	420	01/13	>				S 7A66 A
with automatic gearbox ZF Ecosplit + Intarder / con cambio automatico ZF Ecosplit + Intarder	F3GFE611D	309	420	01/13	>				S 2234 Z
with filter Urea/Adblue SCR Denoxtronic 2 / con filtro Urea/Adblue SCR Denoxtronic 2	F3GFE611D	309	420	01/13	>				S 4402 U
with filter Urea/Adblue SCR Denoxtronic 2.2 / con filtro Urea/Adblue SCR Denoxtronic 2.2	F3GFE611D	309	420	01/13	>				S 4405 U
dryer filter / filtro essiccatore	F3GFE611D	309	420	01/13	>				S 7259 A
prefilter / prefiltrato	F3GFE611D	309	420	01/13	>		S 4474 NR		
prefilter Urea/Adblue SCR Denoxtronic 2 / prefiltrato Urea/Adblue SCR Denoxtronic 2	F3GFE611D	309	420	01/13	>				S 4406 U
power steering / servosterzo	F3GFE611D	309	420	01/13	>				S 3081 PO
power steering ZF Servocom RAS-EC / servosterzo ZF Servocom RAS-EC	F3GFE611D	309	420	01/13	>				S 5664 PO
AD260S46 Cursor11 E6	F3GFE611B	338	460	01/13	>	S 5102 PE	S 6044 NE	S 7600 A	S 3078 C
with activated carbons / ai carboni attivi	F3GFE611B	338	460	01/13	>				S 4346 CA
some dryer filter / alcuni filtro essiccatore	F3GFE611B	338	460	01/13	>				S 7A66 A
with automatic gearbox ZF Ecosplit + Intarder / con cambio automatico ZF Ecosplit + Intarder	F3GFE611B	338	460	01/13	>				S 2234 Z
with filter Urea/Adblue SCR Denoxtronic 2 / con filtro Urea/Adblue SCR Denoxtronic 2	F3GFE611B	338	460	01/13	>				S 4402 U
with filter Urea/Adblue SCR Denoxtronic 2.2 / con filtro Urea/Adblue SCR Denoxtronic 2.2	F3GFE611B	338	460	01/13	>				S 4405 U
dryer filter / filtro essiccatore	F3GFE611B	338	460	01/13	>				S 7259 A
prefilter / prefiltrato	F3GFE611B	338	460	01/13	>		S 4474 NR		
prefilter Urea/Adblue SCR Denoxtronic 2 / prefiltrato Urea/Adblue SCR Denoxtronic 2	F3GFE611B	338	460	01/13	>				S 4406 U
power steering / servosterzo	F3GFE611B	338	460	01/13	>				S 3081 PO
power steering ZF Servocom RAS-EC / servosterzo ZF Servocom RAS-EC	F3GFE611B	338	460	01/13	>				S 5664 PO
AD260S48 Cursor11 E6	F3GFE611A	353	480	01/13	>	S 5102 PE	S 6044 NE	S 7600 A	S 3078 C
with activated carbons / ai carboni attivi	F3GFE611A	353	480	01/13	>				S 4346 CA
some dryer filter / alcuni filtro essiccatore	F3GFE611A	353	480	01/13	>				S 7A66 A
with automatic gearbox ZF Ecosplit + Intarder / con cambio automatico ZF Ecosplit + Intarder	F3GFE611A	353	480	01/13	>				S 2234 Z
with filter Urea/Adblue SCR Denoxtronic 2 / con filtro Urea/Adblue SCR Denoxtronic 2	F3GFE611A	353	480	01/13	>				S 4402 U
with filter Urea/Adblue SCR Denoxtronic 2.2 / con filtro Urea/Adblue SCR Denoxtronic 2.2	F3GFE611A	353	480	01/13	>				S 4405 U
dryer filter / filtro essiccatore	F3GFE611A	353	480	01/13	>				S 7259 A
prefilter / prefiltrato	F3GFE611A	353	480	01/13	>		S 4474 NR		
prefilter Urea/Adblue SCR Denoxtronic 2 / prefiltrato Urea/Adblue SCR Denoxtronic 2	F3GFE611A	353	480	01/13	>				S 4406 U
power steering / servosterzo	F3GFE611A	353	480	01/13	>				S 3081 PO
power steering ZF Servocom RAS-EC / servosterzo ZF Servocom RAS-EC	F3GFE611A	353	480	01/13	>				S 5664 PO
AD440S36 Cursor9 E6	F2CFE611B	265	360	01/13	>	S 5102 PE	S 6043 NE	S 7600 A	S 3078 C
some dryer filter / alcuni filtro essiccatore	F2CFE611B	265	360	01/13	>				S 7A66 A
with automatic gearbox ZF Ecosplit + Intarder / con cambio automatico ZF Ecosplit + Intarder	F2CFE611B	265	360	01/13	>				S 2234 Z
with activated carbon air-conditioner / con climatizzatore, ai carboni attivi	F2CFE611B	265	360	01/13	>				S 4346 CA
with filter Urea/Adblue SCR Denoxtronic 2 / con filtro Urea/Adblue SCR Denoxtronic 2	F2CFE611B	265	360	01/13	>				S 4402 U
with filter Urea/Adblue SCR Denoxtronic 2.2 / con filtro Urea/Adblue SCR Denoxtronic 2.2	F2CFE611B	265	360	01/13	>				S 4405 U
dryer filter / filtro essiccatore	F2CFE611B	265	360	01/13	>				S 7259 A
prefilter / prefiltrato	F2CFE611B	265	360	01/13	>		S 4474 NR		



...IVECO - trucks/autocarri

prefilter Urea/Adblue SCR Denoxtronic 2 / prefiltra Urea/Adblue SCR Denoxtronic 2	F2CFE611B	265	360	01/13	>				S 4406 U
power steering / servosterzo	F2CFE611B	265	360	01/13	>				S 3081 PO
power steering ZF Servocom RAS-EC / servosterzo ZF Servocom RAS-EC	F2CFE611B	265	360	01/13	>				S 5664 PO
AD440S40 Cursor9 E6	F2CFE611A	294	400	01/13	>	S 5102 PE	S 6043 NE	S 7600 A	S 3078 C
some dryer filter / alcuni filtro essiccatore	F2CFE611A	294	400	01/13	>				S 7A66 A
with gearbox ZF Ecosplit + Intarder / con cambio ZF Ecosplit + Intarder	F2CFE611A	294	400	01/13	>				S 2234 Z
with activated carbon air-conditioner / con climatizzatore, ai carboni attivi	F2CFE611A	294	400	01/13	>				S 4346 CA
with filter Urea/Adblue SCR Denoxtronic 2 / con filtro Urea/Adblue SCR Denoxtronic 2	F2CFE611A	294	400	01/13	>				S 4402 U
with filter Urea/Adblue SCR Denoxtronic 2.2 / con filtro Urea/Adblue SCR Denoxtronic 2.2	F2CFE611A	294	400	01/13	>				S 4405 U
dryer filter / filtro essiccatore	F2CFE611A	294	400	01/13	>				S 7259 A
prefilter / prefiltra	F2CFE611A	294	400	01/13	>		S 4474 NR		
prefilter Urea/Adblue SCR Denoxtronic 2 / prefiltra Urea/Adblue SCR Denoxtronic 2	F2CFE611A	294	400	01/13	>				S 4406 U
power steering Ø 80 / servosterzo Ø 80	F2CFE611A	294	400	01/13	>				S 8790 PO
power steering ZF Servocom RAS-EC / servosterzo ZF Servocom RAS-EC	F2CFE611A	294	400	01/13	>				S 5664 PO
AD440S42 Cursor11 E6	F3GFE611D	309	420	01/13	>	S 5102 PE	S 6044 NE	S 7600 A	S 3078 C
with activated carbons / ai carboni attivi	F3GFE611D	309	420	01/13	>				S 4346 CA
some dryer filter / alcuni filtro essiccatore	F3GFE611D	309	420	01/13	>				S 7A66 A
with automatic gearbox ZF Ecosplit + Intarder / con cambio automatico ZF Ecosplit + Intarder	F3GFE611D	309	420	01/13	>				S 2234 Z
with filter Urea/Adblue SCR Denoxtronic 2 / con filtro Urea/Adblue SCR Denoxtronic 2	F3GFE611D	309	420	01/13	>				S 4402 U
with filter Urea/Adblue SCR Denoxtronic 2.2 / con filtro Urea/Adblue SCR Denoxtronic 2.2	F3GFE611D	309	420	01/13	>				S 4405 U
dryer filter / filtro essiccatore	F3GFE611D	309	420	01/13	>				S 7259 A
prefilter / prefiltra	F3GFE611D	309	420	01/13	>		S 4474 NR		
prefilter Urea/Adblue SCR Denoxtronic 2 / prefiltra Urea/Adblue SCR Denoxtronic 2	F3GFE611D	309	420	01/13	>				S 4406 U
power steering / servosterzo	F3GFE611D	309	420	01/13	>				S 3081 PO
power steering ZF Servocom RAS-EC / servosterzo ZF Servocom RAS-EC	F3GFE611D	309	420	01/13	>				S 5664 PO
AD440S46 Cursor11 E6	F3GFE611B	338	460	01/13	>	S 5102 PE	S 6044 NE	S 7600 A	S 3078 C
with activated carbons / ai carboni attivi	F3GFE611B	338	460	01/13	>				S 4346 CA
some dryer filter / alcuni filtro essiccatore	F3GFE611B	338	460	01/13	>				S 7A66 A
with automatic gearbox ZF Ecosplit + Intarder / con cambio automatico ZF Ecosplit + Intarder	F3GFE611B	338	460	01/13	>				S 2234 Z
with filter Urea/Adblue SCR Denoxtronic 2 / con filtro Urea/Adblue SCR Denoxtronic 2	F3GFE611B	338	460	01/13	>				S 4402 U
with filter Urea/Adblue SCR Denoxtronic 2.2 / con filtro Urea/Adblue SCR Denoxtronic 2.2	F3GFE611B	338	460	01/13	>				S 4405 U
dryer filter / filtro essiccatore	F3GFE611B	338	460	01/13	>				S 7259 A
prefilter / prefiltra	F3GFE611B	338	460	01/13	>		S 4474 NR		
prefilter Urea/Adblue SCR Denoxtronic 2 / prefiltra Urea/Adblue SCR Denoxtronic 2	F3GFE611B	338	460	01/13	>				S 4406 U
power steering / servosterzo	F3GFE611B	338	460	01/13	>				S 3081 PO
power steering ZF Servocom RAS-EC / servosterzo ZF Servocom RAS-EC	F3GFE611B	338	460	01/13	>				S 5664 PO
AD440S48 Cursor11 E6	F3GFE611A	353	480	01/13	>	S 5102 PE	S 6044 NE	S 7600 A	S 3078 C
with activated carbons / ai carboni attivi	F3GFE611A	353	480	01/13	>				S 4346 CA
some dryer filter / alcuni filtro essiccatore	F3GFE611A	353	480	01/13	>				S 7A66 A
with automatic gearbox ZF Ecosplit + Intarder / con cambio automatico ZF Ecosplit + Intarder	F3GFE611A	353	480	01/13	>				S 2234 Z
with filter Urea/Adblue SCR Denoxtronic 2 / con filtro Urea/Adblue SCR Denoxtronic 2	F3GFE611A	353	480	01/13	>				S 4402 U
with filter Urea/Adblue SCR Denoxtronic 2.2 / con filtro Urea/Adblue SCR Denoxtronic 2.2	F3GFE611A	353	480	01/13	>				S 4405 U
dryer filter / filtro essiccatore	F3GFE611A	353	480	01/13	>				S 7259 A
prefilter / prefiltra	F3GFE611A	353	480	01/13	>		S 4474 NR		
prefilter Urea/Adblue SCR Denoxtronic 2 / prefiltra Urea/Adblue SCR Denoxtronic 2	F3GFE611A	353	480	01/13	>				S 4406 U
power steering / servosterzo	F3GFE611A	353	480	01/13	>				S 3081 PO
power steering ZF Servocom RAS-EC / servosterzo ZF Servocom RAS-EC	F3GFE611A	353	480	01/13	>				S 5664 PO
Stralis Hi-Way									
AS190S42 Cursor11 E6	F3GFE611D	309	420	01/13	>	S 5102 PE	S 6044 NE	S 7C16 A	S 3078 C
with activated carbons / ai carboni attivi	F3GFE611D	309	420	01/13	>				S 4346 CA
some dryer filter / alcuni filtro essiccatore	F3GFE611D	309	420	01/13	>				S 7A66 A
with automatic gearbox ZF Ecosplit + Intarder / con cambio automatico ZF Ecosplit + Intarder	F3GFE611D	309	420	01/13	>				S 2234 Z
with filter Urea/Adblue SCR Denoxtronic 2 / con filtro Urea/Adblue SCR Denoxtronic 2	F3GFE611D	309	420	01/13	>				S 4402 U
with filter Urea/Adblue SCR Denoxtronic 2.2 / con filtro Urea/Adblue SCR Denoxtronic 2.2	F3GFE611D	309	420	01/13	>				S 4405 U
dryer filter / filtro essiccatore	F3GFE611D	309	420	01/13	>				S 7259 A
prefilter / prefiltra	F3GFE611D	309	420	01/13	>		S 4474 NR		
prefilter Urea/Adblue SCR Denoxtronic 2 / prefiltra Urea/Adblue SCR Denoxtronic 2	F3GFE611D	309	420	01/13	>				S 4406 U
power steering / servosterzo	F3GFE611D	309	420	01/13	>				S 3081 PO
power steering ZF Servocom RAS-EC / servosterzo ZF Servocom RAS-EC	F3GFE611D	309	420	01/13	>				S 5664 PO
AS190S46 Cursor11 E6	F3GFE611B	338	460	01/13	>	S 5102 PE	S 6044 NE	S 7C16 A	S 3078 C
with activated carbons / ai carboni attivi	F3GFE611B	338	460	01/13	>				S 4346 CA
some dryer filter / alcuni filtro essiccatore	F3GFE611B	338	460	01/13	>				S 7A66 A
with automatic gearbox ZF Ecosplit + Intarder / con cambio automatico ZF Ecosplit + Intarder	F3GFE611B	338	460	01/13	>				S 2234 Z
with filter Urea/Adblue SCR Denoxtronic 2 / con filtro Urea/Adblue SCR Denoxtronic 2	F3GFE611B	338	460	01/13	>				S 4402 U
with filter Urea/Adblue SCR Denoxtronic 2.2 / con filtro Urea/Adblue SCR Denoxtronic 2.2	F3GFE611B	338	460	01/13	>				S 4405 U
dryer filter / filtro essiccatore	F3GFE611B	338	460	01/13	>				S 7259 A
prefilter / prefiltra	F3GFE611B	338	460	01/13	>		S 4474 NR		



...IVECO - trucks/autocarri

prefilter Urea/Adblue SCR Denoxtronic 2 / prefiltra Urea/Adblue SCR Denoxtronic 2	F3GFE611B	338	460	01/13	>				S 4406 U
power steering / servosterzo	F3GFE611B	338	460	01/13	>				S 3081 PO
power steering ZF Servocom RAS-EC / servosterzo ZF Servocom RAS-EC	F3GFE611B	338	460	01/13	>				S 5664 PO
AS190S48 Cursor11 E6	F3GFE611A	353	480	01/13	>	S 5102 PE	S 6044 NE	S 7C16 A	S 3078 C
with activated carbons / ai carboni attivi	F3GFE611A	353	480	01/13	>				S 4346 CA
some dryer filter / alcuni filtro essiccatore	F3GFE611A	353	480	01/13	>				S 7A66 A
with automatic gearbox ZF Ecosplit + Intarder / con cambio automatico ZF Ecosplit + Intarder	F3GFE611A	353	480	01/13	>				S 2234 Z
with filter Urea/Adblue SCR Denoxtronic 2 / con filtro Urea/Adblue SCR Denoxtronic 2	F3GFE611A	353	480	01/13	>				S 4402 U
with filter Urea/Adblue SCR Denoxtronic 2.2 / con filtro Urea/Adblue SCR Denoxtronic 2.2	F3GFE611A	353	480	01/13	>				S 4405 U
dryer filter / filtro essiccatore	F3GFE611A	353	480	01/13	>				S 7259 A
prefilter / prefiltra	F3GFE611A	353	480	01/13	>		S 4474 NR		
prefilter Urea/Adblue SCR Denoxtronic 2 / prefiltra Urea/Adblue SCR Denoxtronic 2	F3GFE611A	353	480	01/13	>				S 4406 U
power steering / servosterzo	F3GFE611A	353	480	01/13	>				S 3081 PO
power steering ZF Servocom RAS-EC / servosterzo ZF Servocom RAS-EC	F3GFE611A	353	480	01/13	>				S 5664 PO
AS190S50 Cursor13 E6	F3HFE611B	368	500	01/13	>			S 7C16 A	
prefilter / prefiltra	F3HFE611B	368	500	01/13	>		S 4474 NR		
AS260S42 Cursor11 E6	F3GFE611D	309	420	01/13	>	S 5102 PE	S 6044 NE	S 7C16 A	S 3078 C
with activated carbons / ai carboni attivi	F3GFE611D	309	420	01/13	>				S 4346 CA
some dryer filter / alcuni filtro essiccatore	F3GFE611D	309	420	01/13	>				S 7A66 A
with automatic gearbox ZF Ecosplit + Intarder / con cambio automatico ZF Ecosplit + Intarder	F3GFE611D	309	420	01/13	>				S 2234 Z
with filter Urea/Adblue SCR Denoxtronic 2 / con filtro Urea/Adblue SCR Denoxtronic 2	F3GFE611D	309	420	01/13	>				S 4402 U
with filter Urea/Adblue SCR Denoxtronic 2.2 / con filtro Urea/Adblue SCR Denoxtronic 2.2	F3GFE611D	309	420	01/13	>				S 4405 U
dryer filter / filtro essiccatore	F3GFE611D	309	420	01/13	>				S 7259 A
prefilter / prefiltra	F3GFE611D	309	420	01/13	>		S 4474 NR		
prefilter Urea/Adblue SCR Denoxtronic 2 / prefiltra Urea/Adblue SCR Denoxtronic 2	F3GFE611D	309	420	01/13	>				S 4406 U
power steering / servosterzo	F3GFE611D	309	420	01/13	>				S 3081 PO
power steering ZF Servocom RAS-EC / servosterzo ZF Servocom RAS-EC	F3GFE611D	309	420	01/13	>				S 5664 PO
AS260S46 Cursor11 E6	F3GFE611B	338	460	01/13	>	S 5102 PE	S 6044 NE	S 7C16 A	S 3078 C
with activated carbons / ai carboni attivi	F3GFE611B	338	460	01/13	>				S 4346 CA
some dryer filter / alcuni filtro essiccatore	F3GFE611B	338	460	01/13	>				S 7A66 A
with automatic gearbox ZF Ecosplit + Intarder / con cambio automatico ZF Ecosplit + Intarder	F3GFE611B	338	460	01/13	>				S 2234 Z
with filter Urea/Adblue SCR Denoxtronic 2 / con filtro Urea/Adblue SCR Denoxtronic 2	F3GFE611B	338	460	01/13	>				S 4402 U
with filter Urea/Adblue SCR Denoxtronic 2.2 / con filtro Urea/Adblue SCR Denoxtronic 2.2	F3GFE611B	338	460	01/13	>				S 4405 U
dryer filter / filtro essiccatore	F3GFE611B	338	460	01/13	>				S 7259 A
prefilter / prefiltra	F3GFE611B	338	460	01/13	>		S 4474 NR		
prefilter Urea/Adblue SCR Denoxtronic 2 / prefiltra Urea/Adblue SCR Denoxtronic 2	F3GFE611B	338	460	01/13	>				S 4406 U
power steering / servosterzo	F3GFE611B	338	460	01/13	>				S 3081 PO
power steering ZF Servocom RAS-EC / servosterzo ZF Servocom RAS-EC	F3GFE611B	338	460	01/13	>				S 5664 PO
AS260S48 Cursor11 E6	F3GFE611A	353	480	01/13	>	S 5102 PE	S 6044 NE	S 7C16 A	S 3078 C
with activated carbons / ai carboni attivi	F3GFE611A	353	480	01/13	>				S 4346 CA
some dryer filter / alcuni filtro essiccatore	F3GFE611A	353	480	01/13	>				S 7A66 A
with automatic gearbox ZF Ecosplit + Intarder / con cambio automatico ZF Ecosplit + Intarder	F3GFE611A	353	480	01/13	>				S 2234 Z
with filter Urea/Adblue SCR Denoxtronic 2 / con filtro Urea/Adblue SCR Denoxtronic 2	F3GFE611A	353	480	01/13	>				S 4402 U
with filter Urea/Adblue SCR Denoxtronic 2.2 / con filtro Urea/Adblue SCR Denoxtronic 2.2	F3GFE611A	353	480	01/13	>				S 4405 U
dryer filter / filtro essiccatore	F3GFE611A	353	480	01/13	>				S 7259 A
prefilter / prefiltra	F3GFE611A	353	480	01/13	>		S 4474 NR		
prefilter Urea/Adblue SCR Denoxtronic 2 / prefiltra Urea/Adblue SCR Denoxtronic 2	F3GFE611A	353	480	01/13	>				S 4406 U
power steering / servosterzo	F3GFE611A	353	480	01/13	>				S 3081 PO
power steering ZF Servocom RAS-EC / servosterzo ZF Servocom RAS-EC	F3GFE611A	353	480	01/13	>				S 5664 PO
AS260S50 Cursor13 E6	F3HFE611B	368	500	01/13	>			S 7C16 A	
prefilter / prefiltra	F3HFE611B	368	500	01/13	>		S 4474 NR		
AS260S56 Cursor13 E6	F3HFE611A	412	560	01/13	>			S 7C16 A	
prefilter / prefiltra	F3HFE611A	412	560	01/13	>		S 4474 NR		
AS320S50 Cursor13 E6	F3HFE611B	368	500	01/13	>			S 7C16 A	
prefilter / prefiltra	F3HFE611B	368	500	01/13	>		S 4474 NR		
AS320S56 Cursor13 E6	F3HFE611A	412	560	01/13	>			S 7C16 A	
prefilter / prefiltra	F3HFE611A	412	560	01/13	>		S 4474 NR		
AS440S42 Cursor11 E6	F3GFE611D	309	420	01/13	>	S 5102 PE	S 6044 NE	S 7C16 A	S 3078 C
with activated carbons / ai carboni attivi	F3GFE611D	309	420	01/13	>				S 4346 CA
some dryer filter / alcuni filtro essiccatore	F3GFE611D	309	420	01/13	>				S 7A66 A
with automatic gearbox ZF Ecosplit + Intarder / con cambio automatico ZF Ecosplit + Intarder	F3GFE611D	309	420	01/13	>				S 2234 Z
with filter Urea/Adblue SCR Denoxtronic 2 / con filtro Urea/Adblue SCR Denoxtronic 2	F3GFE611D	309	420	01/13	>				S 4402 U
with filter Urea/Adblue SCR Denoxtronic 2.2 / con filtro Urea/Adblue SCR Denoxtronic 2.2	F3GFE611D	309	420	01/13	>				S 4405 U
dryer filter / filtro essiccatore	F3GFE611D	309	420	01/13	>				S 7259 A
prefilter / prefiltra	F3GFE611D	309	420	01/13	>		S 4474 NR		
prefilter Urea/Adblue SCR Denoxtronic 2 / prefiltra Urea/Adblue SCR Denoxtronic 2	F3GFE611D	309	420	01/13	>				S 4406 U
power steering / servosterzo	F3GFE611D	309	420	01/13	>				S 3081 PO

**KW HP**

...IVECO - trucks/autocarri

power steering ZF Servocom RAS-EC / servosterzo ZF Servocom RAS-EC	F3GFE611D	309	420	01/13	>				S 5664 PO
AS440S46 Cursor11 E6	F3GFE611B	338	460	01/13	>	S 5102 PE	S 6044 NE	S 7C16 A	S 3078 C
with activated carbons / ai carboni attivi	F3GFE611B	338	460	01/13	>				S 4346 CA
some dryer filter / alcuni filtro essiccatore	F3GFE611B	338	460	01/13	>				S 7A66 A
with automatic gearbox ZF Ecosplit + Intarder / con cambio automatico ZF Ecosplit + Intarder	F3GFE611B	338	460	01/13	>				S 2234 Z
with filter Urea/Adblue SCR Denoxtronic 2 / con filtro Urea/Adblue SCR Denoxtronic 2	F3GFE611B	338	460	01/13	>				S 4402 U
with filter Urea/Adblue SCR Denoxtronic 2.2 / con filtro Urea/Adblue SCR Denoxtronic 2.2	F3GFE611B	338	460	01/13	>				S 4405 U
dryer filter / filtro essiccatore	F3GFE611B	338	460	01/13	>				S 7259 A
prefilter / prefiltra	F3GFE611B	338	460	01/13	>		S 4474 NR		
prefilter Urea/Adblue SCR Denoxtronic 2 / prefiltra Urea/Adblue SCR Denoxtronic 2	F3GFE611B	338	460	01/13	>				S 4406 U
power steering / servosterzo	F3GFE611B	338	460	01/13	>				S 3081 PO
power steering ZF Servocom RAS-EC / servosterzo ZF Servocom RAS-EC	F3GFE611B	338	460	01/13	>				S 5664 PO
AS440S48 Cursor11 E6	F3GFE611A	353	480	01/13	>	S 5102 PE	S 6044 NE	S 7C16 A	S 3078 C
with activated carbons / ai carboni attivi	F3GFE611A	353	480	01/13	>				S 4346 CA
some dryer filter / alcuni filtro essiccatore	F3GFE611A	353	480	01/13	>				S 7A66 A
with automatic gearbox ZF Ecosplit + Intarder / con cambio automatico ZF Ecosplit + Intarder	F3GFE611A	353	480	01/13	>				S 2234 Z
with filter Urea/Adblue SCR Denoxtronic 2 / con filtro Urea/Adblue SCR Denoxtronic 2	F3GFE611A	353	480	01/13	>				S 4402 U
with filter Urea/Adblue SCR Denoxtronic 2.2 / con filtro Urea/Adblue SCR Denoxtronic 2.2	F3GFE611A	353	480	01/13	>				S 4405 U
dryer filter / filtro essiccatore	F3GFE611A	353	480	01/13	>				S 7259 A
prefilter / prefiltra	F3GFE611A	353	480	01/13	>		S 4474 NR		
prefilter Urea/Adblue SCR Denoxtronic 2 / prefiltra Urea/Adblue SCR Denoxtronic 2	F3GFE611A	353	480	01/13	>				S 4406 U
power steering / servosterzo	F3GFE611A	353	480	01/13	>				S 3081 PO
power steering ZF Servocom RAS-EC / servosterzo ZF Servocom RAS-EC	F3GFE611A	353	480	01/13	>				S 5664 PO
AS440S50 Cursor13 E6	F3HFE611B	368	500	01/13	>			S 7C16 A	
prefilter / prefiltra	F3HFE611B	368	500	01/13	>		S 4474 NR		
AS440S56 Cursor13 E6	F3HFE611A	412	560	01/13	>			S 7C16 A	
prefilter / prefiltra	F3HFE611A	412	560	01/13	>		S 4474 NR		
Stralis NP									
AS440S40 Cursor9 NP		294	400	06/16	>	S 5102 PE		S 7C16 A	S 3078 C
with activated carbons / ai carboni attivi		294	400	06/16	>				S 4346 CA
some dryer filter / alcuni filtro essiccatore		294	400	06/16	>				S 7A66 A
dryer filter / filtro essiccatore		294	400	06/16	>				S 7259 A
power steering / servosterzo		294	400	06/16	>				S 3081 PO
power steering ZF Servocom RAS-EC / servosterzo ZF Servocom RAS-EC		294	400	06/16	>				S 5664 PO
AS440S46 Cursor13 NP		338	460	09/17	>	S 5169 PE		S 7C16 A	S 3078 C
with activated carbons / ai carboni attivi		338	460	09/17	>				S 4346 CA
some dryer filter / alcuni filtro essiccatore		338	460	09/17	>				S 7A66 A
dryer filter / filtro essiccatore		338	460	09/17	>				S 7259 A
power steering / servosterzo		338	460	09/17	>				S 3081 PO
power steering ZF Servocom RAS-EC / servosterzo ZF Servocom RAS-EC		338	460	09/17	>				S 5664 PO
Stralis X-Way									
440X42 Cursor 11 E6	F3GFE611F	309	420	07/17	>	S 5169 PE	S 6044 NE	S 7C16 A	S 3078 C
with activated carbons / ai carboni attivi	F3GFE611F	309	420	07/17	>				S 4346 CA
prefilter / prefiltra	F3GFE611F	309	420	07/17	>		S 4474 NR		
440X46 Cursor 11 E6	F3GFE611E	338	460	07/17	>	S 5169 PE	S 6044 NE	S 7C16 A	S 3078 C
with activated carbons / ai carboni attivi	F3GFE611E	338	460	07/17	>				S 4346 CA
prefilter / prefiltra	F3GFE611E	338	460	07/17	>		S 4474 NR		
440X48 Cursor 11 E6	F3GFE611G	353	480	07/17	>	S 5169 PE	S 6044 NE	S 7C16 A	S 3078 C
with activated carbons / ai carboni attivi	F3GFE611G	353	480	07/17	>				S 4346 CA
prefilter / prefiltra	F3GFE611G	353	480	07/17	>		S 4474 NR		
440X51 Cursor 13 E6	F3HFE611G	375	510	07/17	>	S 5169 PE	S 6044 NE	S 7C16 A	S 3078 C
with activated carbons / ai carboni attivi	F3HFE611G	375	510	07/17	>				S 4346 CA
prefilter / prefiltra	F3HFE611G	375	510	07/17	>		S 4474 NR		
440X57 Cursor 13 E6	F3HFE611F	420	570	07/17	>	S 5169 PE	S 6044 NE	S 7C16 A	S 3078 C
with activated carbons / ai carboni attivi	F3HFE611F	420	570	07/17	>				S 4346 CA
prefilter / prefiltra	F3HFE611F	420	570	07/17	>		S 4474 NR		
Stralis XP									
AD190S42 Cursor11 E6/C	F3GFE611F	309	420	06/16	>		S 6044 NE	S 7C16 A	S 3078 C
to engine No. 52024 / a motore N. 52024	F3GFE611F	309	420			S 5102 PE			
some dryer filter / alcuni filtro essiccatore	F3GFE611F	309	420	06/16	>				S 7A66 A
with activated carbon air-conditioner / con climatizzatore, ai carboni attivi	F3GFE611F	309	420	06/16	>				S 4346 CA
from engine No. 52025 / da motore N. 52025	F3GFE611F	309	420			S 5169 PE			
filter AD-Blue / filtro AD-Blue	F3GFE611F	309	420						S 4405 U
dryer filter / filtro essiccatore	F3GFE611F	309	420	06/06	>				S 7259 A
prefilter / prefiltra	F3GFE611F	309	420	06/06	>		S 4474 NR		
power steering / servosterzo	F3GFE611F	309	420	06/16	>				S 3081 PO
power steering ZF Servocom RAS-EC / servosterzo ZF Servocom RAS-EC	F3GFE611F	309	420	06/16	>				S 5664 PO



kW HP



...IVECO - trucks/autocarri

T.R.U. Serie

190.24 TRU					S 5003 DR	S 0710 NR	S 7546 A	S 8410 AR
190.26 TRU	8460.21				S 5003 DR	S 0710 NR	S 7546 A	S 8410 AR
190.32 TRU			01/89 >		S 5003 DR	S 0710 NR	S 7546 A	S 8410 AR
190.36 TRU					S 5003 DR	S 0710 NR	S 7546 A	
190.38 TRU								
assembly DONALDSON / montaggio DONALDSON			07/80 > 09/86			S 0710 NR	S 4270 A	S 8410 AR
assembly MANN+HUMMEL / montaggio MANN+HUMMEL			09/86 > 12/87			S 0710 NR	S 7546 A	S 8410 AR
1 filter / N.1 filtro			07/80 > 12/87	S 8020 R				
2 filters / N.2 filtri			07/80 > 12/87	S 0120 R				
220.32 TRU			01/89 >		S 5003 DR	S 0710 NR	S 7546 A	S 8410 AR
220.36 TRU					S 5003 DR	S 0710 NR	S 7546 A	
220.38 TRU								
assembly DONALDSON / montaggio DONALDSON			07/80 > 09/86			S 0710 NR	S 4270 A	S 8410 AR
assembly MANN+HUMMEL / montaggio MANN+HUMMEL			09/86 > 12/87			S 0710 NR	S 7546 A	S 8410 AR
1 filter / N.1 filtro			07/80 > 12/87	S 8020 R				
2 filters / N.2 filtri			07/80 > 12/87	S 0120 R				
240.26 TRU					S 5003 DR	S 0710 NR	S 7546 A	S 8410 AR
240.36 TRU					S 5003 DR	S 0710 NR	S 7546 A	
240.38 TRU								
assembly DONALDSON / montaggio DONALDSON			07/80 > 09/86			S 0710 NR	S 4270 A	S 8410 AR
assembly MANN+HUMMEL / montaggio MANN+HUMMEL			09/86 > 12/87			S 0710 NR	S 7546 A	S 8410 AR
1 filter / N.1 filtro			07/80 > 12/87	S 8020 R				
2 filters / N.2 filtri			07/80 > 12/87	S 0120 R				
260.30 TRU			06/84 > 10/91		S 5003 DR	S 0710 NR	S 7546 A	
260.32 TRU			01/89 >		S 5003 DR	S 0710 NR	S 7546 A	S 8410 AR
260.36 TRU			06/84 > 10/91		S 5003 DR	S 0710 NR	S 7546 A	

Tigrotto

65 C					S 9710 R			
-------------	--	--	--	--	----------	--	--	--

Trakker

AD180T27W Cursor 8	F2BE0681C	201 273	09/04 >		S 3288 R	S 4396 NR	S 7600 A	S 3078 C
some BLOW-BY filter (504153481) / alcuni filtro BLOW-BY (504153481)	F2BE0681C	201 273	09/04 >					S 7266 A
dryer filter / filtro essiccatore	F2BE0681C	201 273	09/04 >					S 7259 A
VGT filter / filtro VGT	F2BE0681C	201 273	09/04 >					S 0VGT A
prefilter / prefiltra	F2BE0681C	201 273	09/04 >			S 1999 NR		
power steering / servosterzo	F2BE0681C	201 273	09/04 >					S 3081 PO
AD190T27W Cursor 8	F2BE0681C	201 273	09/04 >		S 3288 R	S 4396 NR	S 7600 A	S 3078 C
some BLOW-BY filter (504153481) / alcuni filtro BLOW-BY (504153481)	F2BE0681C	201 273	09/04 >					S 7266 A
dryer filter / filtro essiccatore	F2BE0681C	201 273	09/04 >					S 7259 A
VGT filter / filtro VGT	F2BE0681C	201 273	09/04 >					S 0VGT A
prefilter / prefiltra	F2BE0681C	201 273	09/04 >			S 1999 NR		
power steering / servosterzo	F2BE0681C	201 273	09/04 >					S 3081 PO
AD190T31 Cursor 8	F2BE0681B	228 310	09/04 >		S 3288 R	S 4396 NR	S 7600 A	S 3078 C
some / alcuni	F2BE0681B	228 310	09/04 >		S 3288 R	S 4396 NR	S 7562 A	S 3078 C
some BLOW-BY filter (504153481) / alcuni filtro BLOW-BY (504153481)	F2BE0681B	228 310	09/04 >					S 7266 A
dryer filter / filtro essiccatore	F2BE0681B	228 310	09/04 >					S 7259 A
VGT filter / filtro VGT	F2BE0681B	228 310	09/04 >					S 0VGT A
prefilter / prefiltra	F2BE0681B	228 310	09/04 >			S 1999 NR		
power steering / servosterzo	F2BE0681B	228 310	09/04 >					S 3081 PO
AD190T31 Cursor 8	F2BE3681C Euro4/5	228 310	04/06 >		S 3288 R	S 4396 NR	S 7600 A	S 3078 C
some BLOW-BY filter (504153481) / alcuni filtro BLOW-BY (504153481)	F2BE3681C Euro4/5	228 310	04/06 >					S 7266 A
with filter Urea/Adblue / con filtro Urea/Adblue	F2BE3681C Euro4/5	228 310	04/06 >					S 4401 U
dryer filter / filtro essiccatore	F2BE3681C Euro4/5	228 310	04/06 >					S 7259 A
VGT filter / filtro VGT	F2BE3681C Euro4/5	228 310	04/06 >					S 0VGT A
prefilter / prefiltra	F2BE3681C Euro4/5	228 310	04/06 >			S 1999 NR		
power steering / servosterzo	F2BE3681C Euro4/5	228 310	04/06 >					S 3081 PO
AD190T31 Cursor9 E6	F2CFE611D	228 310	01/13 >		S 5102 PE	S 6043 NE		
prefilter / prefiltra	F2CFE611D	228 310	01/13 >			S 4474 NR		
AD190T31W Cursor 8	F2BE0681B	228 310	09/04 >		S 3288 R	S 4396 NR	S 7600 A	S 3078 C
some / alcuni	F2BE0681B	228 310	09/04 >		S 3288 R	S 4396 NR	S 7562 A	S 3078 C
some BLOW-BY filter (504153481) / alcuni filtro BLOW-BY (504153481)	F2BE0681B	228 310	09/04 >					S 7266 A
dryer filter / filtro essiccatore	F2BE0681B	228 310	09/04 >					S 7259 A
VGT filter / filtro VGT	F2BE0681B	228 310	09/04 >					S 0VGT A
prefilter / prefiltra	F2BE0681B	228 310	09/04 >			S 1999 NR		
power steering / servosterzo	F2BE0681B	228 310	09/04 >					S 3081 PO
AD190T31W Cursor 8	F2BE3681C Euro4/5	228 310	04/06 >		S 3288 R	S 4396 NR	S 7600 A	S 3078 C
some BLOW-BY filter (504153481) / alcuni filtro BLOW-BY (504153481)	F2BE3681C Euro4/5	228 310	04/06 >					S 7266 A

**KW HP****...IVECO - trucks/autocarri**

with filter Urea/Adblue / con filtro Urea/Adblue	F2BE3681C Euro4/5	228	310	04/06	>				S 4401 U
dryer filter / filtro essiccatore	F2BE3681C Euro4/5	228	310	04/06	>				S 7259 A
VGT filter / filtro VGT	F2BE3681C Euro4/5	228	310	04/06	>				S 0VGT A
prefilter / prefiltrato	F2BE3681C Euro4/5	228	310	04/06	>		S 1999 NR		
power steering / servosterzo	F2BE3681C Euro4/5	228	310	04/06	>				S 3081 PO
AD190T33 Cursor 8	F2BE3681B Euro4/5	243	330	04/06	>	S 3288 R	S 4396 NR	S 7600 A	S 3078 C
some BLOW-BY filter (504153481) / alcuni filtro BLOW-BY (504153481)	F2BE3681B Euro4/5	243	330	04/06	>				S 7266 A
with filter Urea/Adblue / con filtro Urea/Adblue	F2BE3681B Euro4/5	243	330	04/06	>				S 4401 U
dryer filter / filtro essiccatore	F2BE3681B Euro4/5	243	330	04/06	>				S 7259 A
VGT filter / filtro VGT	F2BE3681B Euro4/5	243	330	04/06	>				S 0VGT A
prefilter / prefiltrato	F2BE3681B Euro4/5	243	330	04/06	>		S 1999 NR		
power steering / servosterzo	F2BE3681B Euro4/5	243	330	04/06	>				S 3081 PO
AD190T33 Cursor9 E6	F2CFE611C	243	330	01/13	>	S 5102 PE	S 6043 NE		
prefilter / prefiltrato	F2CFE611C	243	330	01/13	>		S 4474 NR		
AD190T33W Cursor 8	F2BE3681B Euro4/5	243	330	04/06	>	S 3288 R	S 4396 NR	S 7600 A	S 3078 C
some BLOW-BY filter (504153481) / alcuni filtro BLOW-BY (504153481)	F2BE3681B Euro4/5	243	330	04/06	>				S 7266 A
with filter Urea/Adblue / con filtro Urea/Adblue	F2BE3681B Euro4/5	243	330	04/06	>				S 4401 U
dryer filter / filtro essiccatore	F2BE3681B Euro4/5	243	330	04/06	>				S 7259 A
VGT filter / filtro VGT	F2BE3681B Euro4/5	243	330	04/06	>				S 0VGT A
prefilter / prefiltrato	F2BE3681B Euro4/5	243	330	04/06	>		S 1999 NR		
power steering / servosterzo	F2BE3681B Euro4/5	243	330	04/06	>				S 3081 PO
AD190T33W/P Cursor 8	F2BE3681B Euro4/5	243	330	04/06	>	S 3288 R	S 4396 NR	S 7600 A	S 3078 C
some BLOW-BY filter (504153481) / alcuni filtro BLOW-BY (504153481)	F2BE3681B Euro4/5	243	330	04/06	>				S 7266 A
with filter Urea/Adblue / con filtro Urea/Adblue	F2BE3681B Euro4/5	243	330	04/06	>				S 4401 U
dryer filter / filtro essiccatore	F2BE3681B Euro4/5	243	330	04/06	>				S 7259 A
VGT filter / filtro VGT	F2BE3681B Euro4/5	243	330	04/06	>				S 0VGT A
prefilter / prefiltrato	F2BE3681B Euro4/5	243	330	04/06	>		S 1999 NR		
power steering / servosterzo	F2BE3681B Euro4/5	243	330	04/06	>				S 3081 PO
AD190T35 Cursor 8	F2BE0681A	259	352	10/04	>	S 3288 R	S 4396 NR	S 7600 A	S 3078 C
some / alcuni	F2BE0681A	259	352	10/04	>	S 3288 R	S 4396 NR	S 7562 A	S 3078 C
some BLOW-BY filter (504153481) / alcuni filtro BLOW-BY (504153481)	F2BE0681A	259	352	10/04	>				S 7266 A
dryer filter / filtro essiccatore	F2BE0681A	259	352	10/04	>				S 7259 A
VGT filter / filtro VGT	F2BE0681A	259	352	10/04	>				S 0VGT A
prefilter / prefiltrato	F2BE0681A	259	352	10/04	>		S 1999 NR		
power steering / servosterzo	F2BE0681A	259	352	10/04	>				S 3081 PO
AD190T35W Cursor 8	F2BE0681A	259	352	10/04	>	S 3288 R	S 4396 NR	S 7600 A	S 3078 C
some / alcuni	F2BE0681A	259	352	10/04	>	S 3288 R	S 4396 NR	S 7562 A	S 3078 C
some BLOW-BY filter (504153481) / alcuni filtro BLOW-BY (504153481)	F2BE0681A	259	352	10/04	>				S 7266 A
dryer filter / filtro essiccatore	F2BE0681A	259	352	10/04	>				S 7259 A
VGT filter / filtro VGT	F2BE0681A	259	352	10/04	>				S 0VGT A
prefilter / prefiltrato	F2BE0681A	259	352	10/04	>		S 1999 NR		
power steering / servosterzo	F2BE0681A	259	352	10/04	>				S 3081 PO
AD190T36 Cursor9 E6	F2CFE611B	265	360	01/13	>	S 5102 PE	S 6043 NE		
prefilter / prefiltrato	F2CFE611B	265	360	01/13	>		S 4474 NR		
AD190T36W Cursor 8	F2BE3681A Euro4/5	265	360	04/06	>	S 3288 R	S 4396 NR	S 7600 A	S 3078 C
some BLOW-BY filter (504153481) / alcuni filtro BLOW-BY (504153481)	F2BE3681A Euro4/5	265	360	04/06	>				S 7266 A
with filter Urea/Adblue / con filtro Urea/Adblue	F2BE3681A Euro4/5	265	360	04/06	>				S 4401 U
dryer filter / filtro essiccatore	F2BE3681A Euro4/5	265	360	04/06	>				S 7259 A
VGT filter / filtro VGT	F2BE3681A Euro4/5	265	360	04/06	>				S 0VGT A
prefilter / prefiltrato	F2BE3681A Euro4/5	265	360	04/06	>		S 1999 NR		
prefilter PARKER-RACOR / prefiltrato PARKER-RACOR	F2BE3681A Euro4/5	265	360	04/06	>		S 4068 NR		
power steering / servosterzo	F2BE3681A Euro4/5	265	360	04/06	>				S 3081 PO
AD190T38 Cursor 13	F3BE0681G	279	380	10/04	>		S 4395 NR	S 7600 A	S 3078 C
	F3BE0681G	279	380	03/06	>		S 1395 NR	S 7600 A	S 3078 C
	F3BE0681G	279	380	06/07	>	S 5087 OC	S 1395 NR	S 7600 A	S 3078 C
some / alcuni	F3BE0681G	279	380	10/04	>			S 7562 A	
some BLOW-BY filter (504153481) / alcuni filtro BLOW-BY (504153481)	F3BE0681G	279	380	10/04	>				S 7266 A
dryer filter / filtro essiccatore	F3BE0681G	279	380	10/04	>				S 7259 A
VGT filter / filtro VGT	F3BE0681G	279	380	10/04	>				S 0VGT A
2 filters / N.2 filtri	F3BE0681G	279	380	10/04	>	S 3288 R			
prefilter / prefiltrato	F3BE0681G	279	380	10/04	>		S 1999 NR		
power steering / servosterzo	F3BE0681G	279	380	10/04	>				S 3081 PO
spare part only 150.000 km / solo ricambio 150.000 km	F3BE0681G	279	380	10/11	>	S 5111 PE			
AD190T38W Cursor 13	F3BE0681G	279	380	10/04	>		S 4395 NR	S 7600 A	S 3078 C
	F3BE0681G	279	380	03/06	>		S 1395 NR	S 7600 A	S 3078 C
	F3BE0681G	279	380	06/07	>	S 5087 OC	S 1395 NR	S 7600 A	S 3078 C
some / alcuni	F3BE0681G	279	380	10/04	>			S 7562 A	



**KW HP****...IVECO - trucks/autocarri**

some BLOW-BY filter (504153481) / alcuni filtro BLOW-BY (504153481)	F3BE0681G	279	380	10/04	>				S 7266 A
dryer filter / filtro essiccatore	F3BE0681G	279	380	10/04	>				S 7259 A
VGT filter / filtro VGT	F3BE0681G	279	380	10/04	>				S 0VGT A
2 filters / N.2 filtri	F3BE0681G	279	380	10/04	>	05/07	S 3288 R		
prefilter / prefiltra	F3BE0681G	279	380	10/04	>			S 1999 NR	
power steering / servosterzo	F3BE0681G	279	380	10/04	>				S 3081 PO
AD190T41 Cursor 13	F3BE3681D Euro4/5	301	410	04/06	>	05/07		S 1395 NR	S 7600 A
	F3BE3681D Euro4/5	301	410	06/07	>		S 5087 OC	S 1395 NR	S 7600 A
some BLOW-BY filter (504153481) / alcuni filtro BLOW-BY (504153481)	F3BE3681D Euro4/5	301	410	04/06	>				S 7266 A
with filter Urea/Adblue / con filtro Urea/Adblue	F3BE3681D Euro4/5	301	410	04/06	>				S 4401 U
dryer filter / filtro essiccatore	F3BE3681D Euro4/5	301	410	04/06	>				S 7259 A
VGT filter / filtro VGT	F3BE3681D Euro4/5	301	410	04/06	>				S 0VGT A
2 filters / N.2 filtri	F3BE3681D Euro4/5	301	410	04/06	>	05/07	S 3288 R		
prefilter / prefiltra	F3BE3681D Euro4/5	301	410	04/06	>			S 1999 NR	
prefilter PARKER-RACOR / prefiltra PARKER-RACOR	F3BE3681D Euro4/5	301	410	04/06	>			S 4068 NR	
power steering / servosterzo	F3BE3681D Euro4/5	301	410	04/06	>				S 3081 PO
spare part only 150.000 km / solo ricambio 150.000 km	F3BE3681D Euro4/5	301	410	10/11	>		S 5111 PE		
AD190T41 Cursor13 E6	F3GFE611D	302	410	01/13	>		S 5102 PE	S 6044 NE	
prefilter / prefiltra	F3GFE611D	302	410	01/13	>			S 4474 NR	
AD190T44 Cursor 13	F3BE0681C	324	440	10/04	>			S 4395 NR	S 7563 A
some BLOW-BY filter (504153481) / alcuni filtro BLOW-BY (504153481)	F3BE0681C	324	440	10/04	>				S 7266 A
dryer filter / filtro essiccatore	F3BE0681C	324	440	10/04	>				S 7259 A
VGT filter / filtro VGT	F3BE0681C	324	440	10/04	>				S 0VGT A
2 filters / N.2 filtri	F3BE0681C	324	440	10/04	>		S 3288 R		
prefilter / prefiltra	F3BE0681C	324	440	10/04	>			S 1999 NR	
AD190T44W Cursor 13	F3BE0681C	324	440	10/04	>			S 4395 NR	S 7563 A
some BLOW-BY filter (504153481) / alcuni filtro BLOW-BY (504153481)	F3BE0681C	324	440	10/04	>				S 7266 A
dryer filter / filtro essiccatore	F3BE0681C	324	440	10/04	>				S 7259 A
VGT filter / filtro VGT	F3BE0681C	324	440	10/04	>				S 0VGT A
2 filters / N.2 filtri	F3BE0681C	324	440	10/04	>		S 3288 R		
prefilter / prefiltra	F3BE0681C	324	440	10/04	>			S 1999 NR	
AD190T45 Cursor13 E6	F3GFE611B	332	450	01/13	>		S 5102 PE	S 6044 NE	
prefilter / prefiltra	F3GFE611B	332	450	01/13	>			S 4474 NR	
AD260T33 Cursor 8	F2BE3681B Euro4/5	243	330	04/06	>		S 3288 R	S 4396 NR	S 7600 A
some BLOW-BY filter (504153481) / alcuni filtro BLOW-BY (504153481)	F2BE3681B Euro4/5	243	330	04/06	>				S 7266 A
with filter Urea/Adblue / con filtro Urea/Adblue	F2BE3681B Euro4/5	243	330	04/06	>				S 4401 U
dryer filter / filtro essiccatore	F2BE3681B Euro4/5	243	330	04/06	>				S 7259 A
VGT filter / filtro VGT	F2BE3681B Euro4/5	243	330	04/06	>				S 0VGT A
prefilter / prefiltra	F2BE3681B Euro4/5	243	330	04/06	>			S 1999 NR	
power steering / servosterzo	F2BE3681B Euro4/5	243	330	04/06	>				S 3081 PO
AD260T33 Cursor9 E6	F2CFE611C	243	330	01/13	>		S 5102 PE	S 6043 NE	
AD260T33B Cursor 8	F2BE3681B Euro4/5	243	330	04/06	>		S 3288 R	S 4396 NR	S 7600 A
some BLOW-BY filter (504153481) / alcuni filtro BLOW-BY (504153481)	F2BE3681B Euro4/5	243	330	04/06	>				S 7266 A
with filter Urea/Adblue / con filtro Urea/Adblue	F2BE3681B Euro4/5	243	330	04/06	>				S 4401 U
dryer filter / filtro essiccatore	F2BE3681B Euro4/5	243	330	04/06	>				S 7259 A
VGT filter / filtro VGT	F2BE3681B Euro4/5	243	330	04/06	>				S 0VGT A
prefilter / prefiltra	F2BE3681B Euro4/5	243	330	04/06	>			S 1999 NR	
power steering / servosterzo	F2BE3681B Euro4/5	243	330	04/06	>				S 3081 PO
AD260T33B/P Cursor 8	F2BE3681B Euro4/5	243	330	04/06	>		S 3288 R	S 4396 NR	S 7600 A
some BLOW-BY filter (504153481) / alcuni filtro BLOW-BY (504153481)	F2BE3681B Euro4/5	243	330	04/06	>				S 7266 A
with filter Urea/Adblue / con filtro Urea/Adblue	F2BE3681B Euro4/5	243	330	04/06	>				S 4401 U
dryer filter / filtro essiccatore	F2BE3681B Euro4/5	243	330	04/06	>				S 7259 A
VGT filter / filtro VGT	F2BE3681B Euro4/5	243	330	04/06	>				S 0VGT A
prefilter / prefiltra	F2BE3681B Euro4/5	243	330	04/06	>			S 1999 NR	
power steering / servosterzo	F2BE3681B Euro4/5	243	330	04/06	>				S 3081 PO
AD260T36 Cursor9 E6	F2CFE611B	265	360	01/13	>		S 5102 PE	S 6043 NE	
prefilter / prefiltra	F2CFE611B	265	360	01/13	>			S 4474 NR	
AD260T41 Cursor13 E6	F3GFE611D	302	410	01/13	>		S 5102 PE	S 6044 NE	
prefilter / prefiltra	F3GFE611D	302	410	01/13	>			S 4474 NR	
AD260T45 Cursor13 E6	F3GFE611B	332	450	01/13	>		S 5102 PE	S 6044 NE	
prefilter / prefiltra	F3GFE611B	332	450	01/13	>			S 4474 NR	
AD260T50 Cursor 13	F3BE3681B Euro4/5	368	500	04/06	>	05/07		S 1395 NR	S 7600 A
	F3BE3681B Euro4/5	368	500	06/07	>		S 5087 OC	S 1395 NR	S 7600 A
some BLOW-BY filter (504153481) / alcuni filtro BLOW-BY (504153481)	F3BE3681B Euro4/5	368	500	04/06	>				S 7266 A
with filter Urea/Adblue / con filtro Urea/Adblue	F3BE3681B Euro4/5	368	500	04/06	>				S 4401 U
dryer filter / filtro essiccatore	F3BE3681B Euro4/5	368	500	04/06	>				S 7259 A
VGT filter / filtro VGT	F3BE3681B Euro4/5	368	500	04/06	>				S 0VGT A

**KW HP****...IVECO - trucks/autocarri**

2 filters / N.2 filtri	F3BE3681B Euro4/5	368	500	04/06 > 05/07	S 3288 R			
prefilter / prefiltrato	F3BE3681B Euro4/5	368	500	04/06 >		S 1999 NR		
power steering / servosterzo	F3BE3681B Euro4/5	368	500	04/06 >				S 3081 PO
spare part only 150.000 km / solo ricambio 150.000 km	F3BE3681B Euro4/5	368	500	10/11 >	S 5111 PE			
AD260T50 Cursor13 E6	F3HFE611B	368	500	01/13 >	S 5102 PE	S 6044 NE		
prefilter / prefiltrato	F3HFE611B	368	500	01/13 >		S 4474 NR		
AD340T36 Cursor9 E6	F2CFE611B	265	360	01/13 >	S 5102 PE	S 6043 NE		
prefilter / prefiltrato	F2CFE611B	265	360	01/13 >		S 4474 NR		
AD340T41 Cursor13 E6	F3GFE611D	302	410	01/13 >	S 5102 PE	S 6044 NE		
prefilter / prefiltrato	F3GFE611D	302	410	01/13 >		S 4474 NR		
AD340T45 Cursor13 E6	F3GFE611B	332	450	01/13 >	S 5102 PE	S 6044 NE		
prefilter / prefiltrato	F3GFE611B	332	450	01/13 >		S 4474 NR		
AD340T50 Cursor13 E6	F3HFE611B	368	500	01/13 >	S 5102 PE	S 6044 NE		
prefilter / prefiltrato	F3HFE611B	368	500	01/13 >		S 4474 NR		
AD380T35 Cursor 8	F2BE0681A	259	352	10/04 >	S 3288 R	S 4396 NR	S 7600 A	S 3078 C
some / alcuni	F2BE0681A	259	352	10/04 >	S 3288 R	S 4396 NR	S 7562 A	S 3078 C
some BLOW-BY filter (504153481) / alcuni filtro BLOW-BY (504153481)	F2BE0681A	259	352	10/04 >				S 7266 A
dryer filter / filtro essiccatore	F2BE0681A	259	352	10/04 >				S 7259 A
VGT filter / filtro VGT	F2BE0681A	259	352	10/04 >				S 0VGT A
prefilter / prefiltrato	F2BE0681A	259	352	10/04 >		S 1999 NR		
power steering / servosterzo	F2BE0681A	259	352	10/04 >				S 3081 PO
AD380T36 Cursor 8	F2BE3681A Euro4/5	265	360	04/06 >	S 3288 R	S 4396 NR	S 7600 A	S 3078 C
some BLOW-BY filter (504153481) / alcuni filtro BLOW-BY (504153481)	F2BE3681A Euro4/5	265	360	04/06 >				S 7266 A
with filter Urea/Adblue / con filtro Urea/Adblue	F2BE3681A Euro4/5	265	360	04/06 >				S 4401 U
dryer filter / filtro essiccatore	F2BE3681A Euro4/5	265	360	04/06 >				S 7259 A
VGT filter / filtro VGT	F2BE3681A Euro4/5	265	360	04/06 >				S 0VGT A
prefilter / prefiltrato	F2BE3681A Euro4/5	265	360	04/06 >		S 1999 NR		
power steering / servosterzo	F2BE3681A Euro4/5	265	360	04/06 >				S 3081 PO
AD380T36 Cursor9 E6	F2CFE611B	265	360	01/13 >	S 5102 PE	S 6043 NE		
prefilter / prefiltrato	F2CFE611B	265	360	01/13 >		S 4474 NR		
AD380T38 Cursor 13	F3BE0681G	279	380	10/04 > 02/06		S 4395 NR	S 7600 A	S 3078 C
	F3BE0681G	279	380	03/06 > 05/07		S 1395 NR	S 7600 A	S 3078 C
	F3BE0681G	279	380	06/07 >	S 5087 OC	S 1395 NR	S 7600 A	S 3078 C
some / alcuni	F3BE0681G	279	380	10/04 >			S 7562 A	
some BLOW-BY filter (504153481) / alcuni filtro BLOW-BY (504153481)	F3BE0681G	279	380	10/04 >				S 7266 A
dryer filter / filtro essiccatore	F3BE0681G	279	380	10/04 >				S 7259 A
VGT filter / filtro VGT	F3BE0681G	279	380	10/04 >				S 0VGT A
2 filters / N.2 filtri	F3BE0681G	279	380	10/04 > 05/07	S 3288 R			
prefilter / prefiltrato	F3BE0681G	279	380	10/04 >		S 1999 NR		
power steering / servosterzo	F3BE0681G	279	380	10/04 >				S 3081 PO
spare part only 150.000 km / solo ricambio 150.000 km	F3BE0681G	279	380	10/11 >	S 5111 PE			
AD380T41 Cursor 13	F3BE3681D Euro4/5	301	410	04/06 > 05/07		S 1395 NR	S 7600 A	S 3078 C
	F3BE3681D Euro4/5	301	410	06/07 >	S 5087 OC	S 1395 NR	S 7600 A	S 3078 C
some BLOW-BY filter (504153481) / alcuni filtro BLOW-BY (504153481)	F3BE3681D Euro4/5	301	410	04/06 >				S 7266 A
with filter Urea/Adblue / con filtro Urea/Adblue	F3BE3681D Euro4/5	301	410	04/06 >				S 4401 U
dryer filter / filtro essiccatore	F3BE3681D Euro4/5	301	410	04/06 >				S 7259 A
VGT filter / filtro VGT	F3BE3681D Euro4/5	301	410	04/06 >				S 0VGT A
2 filters / N.2 filtri	F3BE3681D Euro4/5	301	410	04/06 > 05/07	S 3288 R			
prefilter / prefiltrato	F3BE3681D Euro4/5	301	410	04/06 >		S 1999 NR		
power steering / servosterzo	F3BE3681D Euro4/5	301	410	04/06 >				S 3081 PO
spare part only 150.000 km / solo ricambio 150.000 km	F3BE3681D Euro4/5	301	410	10/11 >	S 5111 PE			
AD380T41 Cursor13 E6	F3GFE611D	302	410	01/13 >	S 5102 PE	S 6044 NE		
prefilter / prefiltrato	F3GFE611D	302	410	01/13 >		S 4474 NR		
AD380T41W Cursor 13	F3BE3681D Euro4/5	301	410	04/06 > 05/07		S 1395 NR	S 7600 A	S 3078 C
	F3BE3681D Euro4/5	301	410	06/07 >	S 5087 OC	S 1395 NR	S 7600 A	S 3078 C
some BLOW-BY filter (504153481) / alcuni filtro BLOW-BY (504153481)	F3BE3681D Euro4/5	301	410	04/06 >				S 7266 A
with filter Urea/Adblue / con filtro Urea/Adblue	F3BE3681D Euro4/5	301	410	04/06 >				S 4401 U
dryer filter / filtro essiccatore	F3BE3681D Euro4/5	301	410	04/06 >				S 7259 A
VGT filter / filtro VGT	F3BE3681D Euro4/5	301	410	04/06 >				S 0VGT A
2 filters / N.2 filtri	F3BE3681D Euro4/5	301	410	04/06 > 05/07	S 3288 R			
prefilter / prefiltrato	F3BE3681D Euro4/5	301	410	04/06 >		S 1999 NR		
power steering / servosterzo	F3BE3681D Euro4/5	301	410	04/06 >				S 3081 PO
spare part only 150.000 km / solo ricambio 150.000 km	F3BE3681D Euro4/5	301	410	10/11 >	S 5111 PE			
AD380T44 Cursor 13	F3BE0681C	324	440	10/04 >		S 4395 NR	S 7600 A	S 3078 C
some BLOW-BY filter (504153481) / alcuni filtro BLOW-BY (504153481)	F3BE0681C	324	440	10/04 >				S 7266 A
dryer filter / filtro essiccatore	F3BE0681C	324	440	10/04 >				S 7259 A
VGT filter / filtro VGT	F3BE0681C	324	440	10/04 >				S 0VGT A





...IVECO - trucks/autocarri

2 filters / N.2 filtri	F3BE0681C	324	440	10/04	>	S 3288 R			
prefilter / prefiltrato	F3BE0681C	324	440	10/04	>		S 1999 NR		
power steering / servosterzo	F3BE0681C	324	440	10/04	>				S 3081 PO
AD380T45 Cursor 13	F3BE3681C Euro4/5	332	450	04/06	> 05/07		S 1395 NR	S 7600 A	S 3078 C
	F3BE3681C Euro4/5	332	450	06/07	>	S 5087 OC	S 1395 NR	S 7600 A	S 3078 C
some BLOW-BY filter (504153481) / alcuni filtro BLOW-BY (504153481)	F3BE3681C Euro4/5	332	450	04/06	>				S 7266 A
with filter Urea/Adblue / con filtro Urea/Adblue	F3BE3681C Euro4/5	332	450	04/06	>				S 4401 U
dryer filter / filtro essiccatore	F3BE3681C Euro4/5	332	450	04/06	>				S 7259 A
VGT filter / filtro VGT	F3BE3681C Euro4/5	332	450	04/06	>				S 0VGT A
2 filters / N.2 filtri	F3BE3681C Euro4/5	332	450	04/06	> 05/07	S 3288 R			
prefilter / prefiltrato	F3BE3681C Euro4/5	332	450	04/06	>		S 1999 NR		
power steering / servosterzo	F3BE3681C Euro4/5	332	450	04/06	>				S 3081 PO
spare part only 150.000 km / solo ricambio 150.000 km	F3BE3681C Euro4/5	332	450	10/11	>	S 5111 PE			
AD380T45 Cursor13 E6	F3GFE611B	332	450	01/13	>	S 5102 PE	S 6044 NE		
prefilter / prefiltrato	F3GFE611B	332	450	01/13	>		S 4474 NR		
AD380T48 Cursor 13	F3BE0681E	353	480	10/04	>		S 4395 NR	S 7600 A	S 3078 C
some BLOW-BY filter (504153481) / alcuni filtro BLOW-BY (504153481)	F3BE0681E	353	480	10/04	>				S 7266 A
dryer filter / filtro essiccatore	F3BE0681E	353	480	10/04	>				S 7259 A
VGT filter / filtro VGT	F3BE0681E	353	480	10/04	>				S 0VGT A
2 filters / N.2 filtri	F3BE0681E	353	480	10/04	>	S 3288 R			
prefilter / prefiltrato	F3BE0681E	353	480	10/04	>		S 1999 NR		
power steering / servosterzo	F3BE0681E	353	480	10/04	>				S 3081 PO
AD380T50 Cursor 13	F3BE3681B Euro4/5	368	500	04/06	> 05/07		S 1395 NR	S 7600 A	S 3078 C
	F3BE3681B Euro4/5	368	500	06/07	>	S 5087 OC	S 1395 NR	S 7600 A	S 3078 C
some BLOW-BY filter (504153481) / alcuni filtro BLOW-BY (504153481)	F3BE3681B Euro4/5	368	500	04/06	>				S 7266 A
dryer filter / filtro essiccatore	F3BE3681B Euro4/5	368	500	04/06	>				S 7259 A
VGT filter / filtro VGT	F3BE3681B Euro4/5	368	500	04/06	>				S 0VGT A
2 filters / N.2 filtri	F3BE3681B Euro4/5	368	500	04/06	> 05/07	S 3288 R			
prefilter / prefiltrato	F3BE3681B Euro4/5	368	500	04/06	>		S 1999 NR		
power steering / servosterzo	F3BE3681B Euro4/5	368	500	04/06	>				S 3081 PO
spare part only 150.000 km / solo ricambio 150.000 km	F3BE3681B Euro4/5	368	500	10/11	>	S 5111 PE			
AD380T50 Cursor13 E6	F3HFE611B	368	500	01/13	>	S 5102 PE	S 6044 NE		
prefilter / prefiltrato	F3HFE611B	368	500	01/13	>		S 4474 NR		
AD400T41 Cursor13 E6	F3GFE611D	302	410	01/13	>	S 5102 PE	S 6044 NE		
prefilter / prefiltrato	F3GFE611D	302	410	01/13	>		S 4474 NR		
AD400T45 Cursor13 E6	F3GFE611B	332	450	01/13	>	S 5102 PE	S 6044 NE		
prefilter / prefiltrato	F3GFE611B	332	450	01/13	>		S 4474 NR		
AD400T50 Cursor 13	F3BE3681B Euro4/5	368	500	04/06	> 05/07		S 1395 NR	S 7600 A	S 3078 C
	F3BE3681B Euro4/5	368	500	06/07	>	S 5087 OC	S 1395 NR	S 7600 A	S 3078 C
some BLOW-BY filter (504153481) / alcuni filtro BLOW-BY (504153481)	F3BE3681B Euro4/5	368	500	04/06	>				S 7266 A
dryer filter / filtro essiccatore	F3BE3681B Euro4/5	368	500	04/06	>				S 7259 A
VGT filter / filtro VGT	F3BE3681B Euro4/5	368	500	04/06	>				S 0VGT A
2 filters / N.2 filtri	F3BE3681B Euro4/5	368	500	04/06	> 05/07	S 3288 R			
prefilter / prefiltrato	F3BE3681B Euro4/5	368	500	04/06	>		S 1999 NR		
power steering / servosterzo	F3BE3681B Euro4/5	368	500	04/06	>				S 3081 PO
spare part only 150.000 km / solo ricambio 150.000 km	F3BE3681B Euro4/5	368	500	10/11	>	S 5111 PE			
AD410T38 Cursor 13	F3BE0681G	279	380	10/04	> 02/06		S 4395 NR	S 7600 A	S 3078 C
	F3BE0681G	279	380	03/06	> 05/07		S 1395 NR	S 7600 A	S 3078 C
	F3BE0681G	279	380	06/07	>	S 5087 OC	S 1395 NR	S 7600 A	S 3078 C
some / alcuni	F3BE0681G	279	380	10/04	>			S 7562 A	
some BLOW-BY filter (504153481) / alcuni filtro BLOW-BY (504153481)	F3BE0681G	279	380	10/04	>				S 7266 A
dryer filter / filtro essiccatore	F3BE0681G	279	380	10/04	>				S 7259 A
VGT filter / filtro VGT	F3BE0681G	279	380	10/04	>				S 0VGT A
2 filters / N.2 filtri	F3BE0681G	279	380	10/04	> 05/07	S 3288 R			
prefilter / prefiltrato	F3BE0681G	279	380	10/04	>		S 1999 NR		
power steering / servosterzo	F3BE0681G	279	380	10/04	>				S 3081 PO
spare part only 150.000 km / solo ricambio 150.000 km	F3BE0681G	279	380	10/11	>	S 5111 PE			
AD410T41 Cursor13 E6	F3GFE611D	302	410	01/13	>	S 5102 PE	S 6044 NE		
prefilter / prefiltrato	F3GFE611D	302	410	01/13	>		S 4474 NR		
AD410T44 Cursor 13	F3BE0681C	324	440	10/04	>		S 4395 NR	S 7600 A	S 3078 C
some BLOW-BY filter (504153481) / alcuni filtro BLOW-BY (504153481)	F3BE0681C	324	440	10/04	>				S 7266 A
dryer filter / filtro essiccatore	F3BE0681C	324	440	10/04	>				S 7259 A
VGT filter / filtro VGT	F3BE0681C	324	440	10/04	>				S 0VGT A
2 filters / N.2 filtri	F3BE0681C	324	440	10/04	>	S 3288 R			
prefilter / prefiltrato	F3BE0681C	324	440	10/04	>		S 1999 NR		
power steering / servosterzo	F3BE0681C	324	440	10/04	>				S 3081 PO
AD410T44W Cursor 13	F3BE0681C	324	440	10/04	>		S 4395 NR	S 7600 A	S 3078 C



...IVECO - trucks/autocarri

some BLOW-BY filter (504153481) / alcuni filtro BLOW-BY (504153481)	F3BE0681C	324	440	10/04	>				S 7266 A
dryer filter / filtro essiccatore	F3BE0681C	324	440	10/04	>				S 7259 A
VGT filter / filtro VGT	F3BE0681C	324	440	10/04	>				S 0VGT A
2 filters / N.2 filtri	F3BE0681C	324	440	10/04	>	S 3288 R			
prefilter / prefiltra	F3BE0681C	324	440	10/04	>		S 1999 NR		
power steering / servosterzo	F3BE0681C	324	440	10/04	>				S 3081 PO
AD410T45 Cursor13 E6	F3GFE611B	332	450	01/13	>	S 5102 PE	S 6044 NE		
prefilter / prefiltra	F3GFE611B	332	450	01/13	>		S 4474 NR		
AD410T48 Cursor 13	F3BE0681E	353	480	10/04	>		S 4395 NR	S 7600 A	S 3078 C
some BLOW-BY filter (504153481) / alcuni filtro BLOW-BY (504153481)	F3BE0681E	353	480	10/04	>				S 7266 A
dryer filter / filtro essiccatore	F3BE0681E	353	480	10/04	>				S 7259 A
VGT filter / filtro VGT	F3BE0681E	353	480	10/04	>				S 0VGT A
2 filters / N.2 filtri	F3BE0681E	353	480	10/04	>	S 3288 R			
prefilter / prefiltra	F3BE0681E	353	480	10/04	>		S 1999 NR		
power steering / servosterzo	F3BE0681E	353	480	10/04	>				S 3081 PO
AD410T50 Cursor 13	F3BE3681B Euro4/5	368	500	04/06	> 05/07		S 1395 NR	S 7600 A	S 3078 C
	F3BE3681B Euro4/5	368	500	06/07	>	S 5087 OC	S 1395 NR	S 7600 A	S 3078 C
some BLOW-BY filter (504153481) / alcuni filtro BLOW-BY (504153481)	F3BE3681B Euro4/5	368	500	04/06	>				S 7266 A
dryer filter / filtro essiccatore	F3BE3681B Euro4/5	368	500	04/06	>				S 7259 A
VGT filter / filtro VGT	F3BE3681B Euro4/5	368	500	04/06	>				S 0VGT A
2 filters / N.2 filtri	F3BE3681B Euro4/5	368	500	04/06	> 05/07	S 3288 R			
prefilter / prefiltra	F3BE3681B Euro4/5	368	500	04/06	>		S 1999 NR		
power steering / servosterzo	F3BE3681B Euro4/5	368	500	04/06	>				S 3081 PO
spare part only 150.000 km / solo ricambio 150.000 km	F3BE3681B Euro4/5	368	500	10/11	>	S 5111 PE			
AD410T50 Cursor13 E6	F3HFE611B	368	500	01/13	>	S 5102 PE	S 6044 NE		
prefilter / prefiltra	F3HFE611B	368	500	01/13	>		S 4474 NR		
AD440T41 Cursor13 E6	F3GFE611D	302	410	01/13	>	S 5102 PE	S 6044 NE		
prefilter / prefiltra	F3GFE611D	302	410	01/13	>		S 4474 NR		
AD440T45 Cursor13 E6	F3GFE611B	332	450	01/13	>	S 5102 PE	S 6044 NE		
prefilter / prefiltra	F3GFE611B	332	450	01/13	>		S 4474 NR		
AD440T50 Cursor 13	F3BE3681B Euro4/5	368	500	04/06	> 05/07		S 1395 NR	S 7600 A	S 3078 C
	F3BE3681B Euro4/5	368	500	06/07	>	S 5087 OC	S 1395 NR	S 7600 A	S 3078 C
some BLOW-BY filter (504153481) / alcuni filtro BLOW-BY (504153481)	F3BE3681B Euro4/5	368	500	04/06	>				S 7266 A
dryer filter / filtro essiccatore	F3BE3681B Euro4/5	368	500	04/06	>				S 7259 A
VGT filter / filtro VGT	F3BE3681B Euro4/5	368	500	04/06	>				S 0VGT A
2 filters / N.2 filtri	F3BE3681B Euro4/5	368	500	04/06	> 05/07	S 3288 R			
prefilter / prefiltra	F3BE3681B Euro4/5	368	500	04/06	>		S 1999 NR		
prefilter PARKER-RACOR / prefiltra PARKER-RACOR	F3BE3681B Euro4/5	368	500	04/06	>		S 4068 NR		
power steering / servosterzo	F3BE3681B Euro4/5	368	500	04/06	>				S 3081 PO
spare part only 150.000 km / solo ricambio 150.000 km	F3BE3681B Euro4/5	368	500	10/11	>	S 5111 PE			
AD440T50 Cursor13 E6	F3HFE611B	368	500	01/13	>	S 5102 PE	S 6044 NE		
prefilter / prefiltra	F3HFE611B	368	500	01/13	>		S 4474 NR		
AD720T44T Cursor 13	F3BE0681C	324	440	10/04	>		S 4395 NR	S 7600 A	S 3078 C
some BLOW-BY filter (504153481) / alcuni filtro BLOW-BY (504153481)	F3BE0681C	324	440	10/04	>				S 7266 A
dryer filter / filtro essiccatore	F3BE0681C	324	440	10/04	>				S 7259 A
VGT filter / filtro VGT	F3BE0681C	324	440	10/04	>				S 0VGT A
2 filters / N.2 filtri	F3BE0681C	324	440	10/04	>	S 3288 R			
prefilter / prefiltra	F3BE0681C	324	440	10/04	>		S 1999 NR		
power steering / servosterzo	F3BE0681C	324	440	10/04	>				S 3081 PO
AD720T45 Cursor13 E6	F3GFE611B	332	450	01/13	>	S 5102 PE	S 6044 NE		
prefilter / prefiltra	F3GFE611B	332	450	01/13	>		S 4474 NR		
AD720T48T Cursor 13	F3BE0681E	353	480	10/04	>		S 4395 NR	S 7600 A	S 3078 C
some BLOW-BY filter (504153481) / alcuni filtro BLOW-BY (504153481)	F3BE0681E	353	480	10/04	>				S 7266 A
dryer filter / filtro essiccatore	F3BE0681E	353	480	10/04	>				S 7259 A
VGT filter / filtro VGT	F3BE0681E	353	480	10/04	>				S 0VGT A
2 filters / N.2 filtri	F3BE0681E	353	480	10/04	>	S 3288 R			
prefilter / prefiltra	F3BE0681E	353	480	10/04	>		S 1999 NR		
power steering / servosterzo	F3BE0681E	353	480	10/04	>				S 3081 PO
AD720T50 Cursor 13	F3BE3681B Euro4/5	368	500	04/06	> 05/07		S 1395 NR	S 7600 A	S 3078 C
	F3BE3681B Euro4/5	368	500	06/07	>	S 5087 OC	S 1395 NR	S 7600 A	S 3078 C
some BLOW-BY filter (504153481) / alcuni filtro BLOW-BY (504153481)	F3BE3681B Euro4/5	368	500	04/06	>				S 7266 A
dryer filter / filtro essiccatore	F3BE3681B Euro4/5	368	500	04/06	>				S 7259 A
VGT filter / filtro VGT	F3BE3681B Euro4/5	368	500	04/06	>				S 0VGT A
2 filters / N.2 filtri	F3BE3681B Euro4/5	368	500	04/06	> 05/07	S 3288 R			
prefilter / prefiltra	F3BE3681B Euro4/5	368	500	04/06	>		S 1999 NR		
power steering / servosterzo	F3BE3681B Euro4/5	368	500	04/06	>				S 3081 PO
spare part only 150.000 km / solo ricambio 150.000 km	F3BE3681B Euro4/5	368	500	10/11	>	S 5111 PE			



**KW HP****...IVECO - trucks/autocarri**

AD720T50 Cursor13 E6	F3HFE611B	368	500	01/13	>	S 5102 PE	S 6044 NE		
prefilter / prefiltrato	F3HFE611B	368	500	01/13	>		S 4474 NR		
AT190T31 Cursor 8	F2BE0681B	228	310	10/04	>	S 3288 R	S 4396 NR	S 7600 A	S 3078 C
some / alcuni	F2BE0681B	228	310	10/04	>	S 3288 R	S 4396 NR	S 7562 A	S 3078 C
some BLOW-BY filter (504153481) / alcuni filtro BLOW-BY (504153481)	F2BE0681B	228	310	10/04	>				S 7266 A
dryer filter / filtro essiccatore	F2BE0681B	228	310	10/04	>				S 7259 A
VGT filter / filtro VGT	F2BE0681B	228	310	10/04	>				S 0VGT A
prefilter / prefiltrato	F2BE0681B	228	310	10/04	>		S 1999 NR		
power steering / servosterzo	F2BE0681B	228	310	10/04	>				S 3081 PO
AT190T31 Cursor 8	F2BE3681C Euro4/5	228	310	04/06	>	S 3288 R	S 4396 NR	S 7600 A	S 3078 C
some BLOW-BY filter (504153481) / alcuni filtro BLOW-BY (504153481)	F2BE3681C Euro4/5	228	310	04/06	>				S 7266 A
with filter Urea/Adblue / con filtro Urea/Adblue	F2BE3681C Euro4/5	228	310	04/06	>				S 4401 U
dryer filter / filtro essiccatore	F2BE3681C Euro4/5	228	310	04/06	>				S 7259 A
VGT filter / filtro VGT	F2BE3681C Euro4/5	228	310	04/06	>				S 0VGT A
prefilter / prefiltrato	F2BE3681C Euro4/5	228	310	04/06	>		S 1999 NR		
power steering / servosterzo	F2BE3681C Euro4/5	228	310	04/06	>				S 3081 PO
AT190T31W Cursor 8	F2BE0681B	228	310	09/04	>	S 3288 R	S 4396 NR	S 7600 A	S 3078 C
some / alcuni	F2BE0681B	228	310	09/04	>	S 3288 R	S 4396 NR	S 7562 A	S 3078 C
some BLOW-BY filter (504153481) / alcuni filtro BLOW-BY (504153481)	F2BE0681B	228	310	09/04	>				S 7266 A
dryer filter / filtro essiccatore	F2BE0681B	228	310	09/04	>				S 7259 A
VGT filter / filtro VGT	F2BE0681B	228	310	09/04	>				S 0VGT A
prefilter / prefiltrato	F2BE0681B	228	310	09/04	>		S 1999 NR		
power steering / servosterzo	F2BE0681B	228	310	09/04	>				S 3081 PO
AT190T31W Cursor 8	F2BE3681C Euro4/5	228	310	04/06	>	S 3288 R	S 4396 NR	S 7600 A	S 3078 C
some BLOW-BY filter (504153481) / alcuni filtro BLOW-BY (504153481)	F2BE3681C Euro4/5	228	310	04/06	>				S 7266 A
with filter Urea/Adblue / con filtro Urea/Adblue	F2BE3681C Euro4/5	228	310	04/06	>				S 4401 U
dryer filter / filtro essiccatore	F2BE3681C Euro4/5	228	310	04/06	>				S 7259 A
VGT filter / filtro VGT	F2BE3681C Euro4/5	228	310	04/06	>				S 0VGT A
prefilter / prefiltrato	F2BE3681C Euro4/5	228	310	04/06	>		S 1999 NR		
power steering / servosterzo	F2BE3681C Euro4/5	228	310	04/06	>				S 3081 PO
AT190T33 Cursor 8	F2BE3681B Euro4/5	243	330	04/06	>	S 3288 R	S 4396 NR	S 7600 A	S 3078 C
some BLOW-BY filter (504153481) / alcuni filtro BLOW-BY (504153481)	F2BE3681B Euro4/5	243	330	04/06	>				S 7266 A
with filter Urea/Adblue / con filtro Urea/Adblue	F2BE3681B Euro4/5	243	330	04/06	>				S 4401 U
dryer filter / filtro essiccatore	F2BE3681B Euro4/5	243	330	04/06	>				S 7259 A
VGT filter / filtro VGT	F2BE3681B Euro4/5	243	330	04/06	>				S 0VGT A
prefilter / prefiltrato	F2BE3681B Euro4/5	243	330	04/06	>		S 1999 NR		
power steering / servosterzo	F2BE3681B Euro4/5	243	330	04/06	>				S 3081 PO
AT190T33W Cursor 8	F2BE3681B Euro4/5	243	330	04/06	>	S 3288 R	S 4396 NR	S 7600 A	S 3078 C
some BLOW-BY filter (504153481) / alcuni filtro BLOW-BY (504153481)	F2BE3681B Euro4/5	243	330	04/06	>				S 7266 A
with filter Urea/Adblue / con filtro Urea/Adblue	F2BE3681B Euro4/5	243	330	04/06	>				S 4401 U
dryer filter / filtro essiccatore	F2BE3681B Euro4/5	243	330	04/06	>				S 7259 A
VGT filter / filtro VGT	F2BE3681B Euro4/5	243	330	04/06	>				S 0VGT A
prefilter / prefiltrato	F2BE3681B Euro4/5	243	330	04/06	>		S 1999 NR		
power steering / servosterzo	F2BE3681B Euro4/5	243	330	04/06	>				S 3081 PO
AT190T33W/P Cursor 8	F2BE3681B Euro4/5	243	330	04/06	>	S 3288 R	S 4396 NR	S 7600 A	S 3078 C
some BLOW-BY filter (504153481) / alcuni filtro BLOW-BY (504153481)	F2BE3681B Euro4/5	243	330	04/06	>				S 7266 A
with filter Urea/Adblue / con filtro Urea/Adblue	F2BE3681B Euro4/5	243	330	04/06	>				S 4401 U
dryer filter / filtro essiccatore	F2BE3681B Euro4/5	243	330	04/06	>				S 7259 A
VGT filter / filtro VGT	F2BE3681B Euro4/5	243	330	04/06	>				S 0VGT A
prefilter / prefiltrato	F2BE3681B Euro4/5	243	330	04/06	>		S 1999 NR		
power steering / servosterzo	F2BE3681B Euro4/5	243	330	04/06	>				S 3081 PO
AT190T35 Cursor 8	F2BE0681A	259	352	10/04	>	S 3288 R	S 4396 NR	S 7600 A	S 3078 C
some / alcuni	F2BE0681A	259	352	10/04	>	S 3288 R	S 4396 NR	S 7562 A	S 3078 C
some BLOW-BY filter (504153481) / alcuni filtro BLOW-BY (504153481)	F2BE0681A	259	352	10/04	>				S 7266 A
dryer filter / filtro essiccatore	F2BE0681A	259	352	10/04	>				S 7259 A
VGT filter / filtro VGT	F2BE0681A	259	352	10/04	>				S 0VGT A
prefilter / prefiltrato	F2BE0681A	259	352	10/04	>		S 1999 NR		
power steering / servosterzo	F2BE0681A	259	352	10/04	>				S 3081 PO
AT190T35W Cursor 8	F2BE0681A	259	352	10/04	>	S 3288 R	S 4396 NR	S 7600 A	S 3078 C
some / alcuni	F2BE0681A	259	352	10/04	>	S 3288 R	S 4396 NR	S 7562 A	S 3078 C
some BLOW-BY filter (504153481) / alcuni filtro BLOW-BY (504153481)	F2BE0681A	259	352	10/04	>				S 7266 A
dryer filter / filtro essiccatore	F2BE0681A	259	352	10/04	>				S 7259 A
VGT filter / filtro VGT	F2BE0681A	259	352	10/04	>				S 0VGT A
prefilter / prefiltrato	F2BE0681A	259	352	10/04	>		S 1999 NR		
power steering / servosterzo	F2BE0681A	259	352	10/04	>				S 3081 PO
AT190T38 Cursor 13	F3BE0681G	279	380	10/04	>		S 4395 NR	S 7600 A	S 3078 C
some / alcuni	F3BE0681G	279	380	10/04	>			S 7562 A	

**KW HP****...IVECO - trucks/autocarri**

some BLOW-BY filter (504153481) / alcuni filtro BLOW-BY (504153481)	F3BE0681G	279	380	10/04	>				S 7266 A
dryer filter / filtro essiccatore	F3BE0681G	279	380	10/04	>				S 7259 A
VGT filter / filtro VGT	F3BE0681G	279	380	10/04	>				S 0VGT A
2 filters / N.2 filtri	F3BE0681G	279	380	10/04	>		S 3288 R		
power steering / servosterzo	F3BE0681G	279	380	10/04	>				S 3081 PO
AT190T38W Cursor 13	F3BE0681G	279	380	10/04	>			S 4395 NR	S 7600 A
some / alcuni	F3BE0681G	279	380	10/04	>				S 7562 A
some BLOW-BY filter (504153481) / alcuni filtro BLOW-BY (504153481)	F3BE0681G	279	380	10/04	>				S 7266 A
dryer filter / filtro essiccatore	F3BE0681G	279	380	10/04	>				S 7259 A
VGT filter / filtro VGT	F3BE0681G	279	380	10/04	>				S 0VGT A
2 filters / N.2 filtri	F3BE0681G	279	380	10/04	>		S 3288 R		
power steering / servosterzo	F3BE0681G	279	380	10/04	>				S 3081 PO
AT190T41 Cursor 13	F3BE3681D Euro4/5	301	410	04/06	>	05/07		S 1395 NR	S 7600 A
	F3BE3681D Euro4/5	301	410	06/07	>		S 5087 OC	S 1395 NR	S 7600 A
some BLOW-BY filter (504153481) / alcuni filtro BLOW-BY (504153481)	F3BE3681D Euro4/5	301	410	04/06	>				S 7266 A
with filter Urea/Adblue / con filtro Urea/Adblue	F3BE3681D Euro4/5	301	410	04/06	>				S 4401 U
dryer filter / filtro essiccatore	F3BE3681D Euro4/5	301	410	04/06	>				S 7259 A
VGT filter / filtro VGT	F3BE3681D Euro4/5	301	410	04/06	>				S 0VGT A
2 filters / N.2 filtri	F3BE3681D Euro4/5	301	410	04/06	>	05/07	S 3288 R		
prefilter / prefiltra	F3BE3681D Euro4/5	301	410	04/06	>			S 1999 NR	
power steering / servosterzo	F3BE3681D Euro4/5	301	410	04/06	>				S 3081 PO
spare part only 150.000 km / solo ricambio 150.000 km	F3BE3681D Euro4/5	301	410	10/11	>		S 5111 PE		
AT190T41 Cursor13 E6	F3GFE611D	302	410	01/13	>		S 5102 PE	S 6044 NE	
prefilter / prefiltra	F3GFE611D	302	410	01/13	>			S 4474 NR	
AT190T44 Cursor 13	F3BE0681C	324	440	10/04	>			S 4395 NR	S 7563 A
some BLOW-BY filter (504153481) / alcuni filtro BLOW-BY (504153481)	F3BE0681C	324	440	10/04	>				S 7266 A
dryer filter / filtro essiccatore	F3BE0681C	324	440	10/04	>				S 7259 A
VGT filter / filtro VGT	F3BE0681C	324	440	10/04	>				S 0VGT A
2 filters / N.2 filtri	F3BE0681C	324	440	10/04	>		S 3288 R		
prefilter / prefiltra	F3BE0681C	324	440	10/04	>			S 1999 NR	
AT190T44W Cursor 13	F3BE0681C	324	440	10/04	>			S 4395 NR	S 7563 A
some BLOW-BY filter (504153481) / alcuni filtro BLOW-BY (504153481)	F3BE0681C	324	440	10/04	>				S 7266 A
dryer filter / filtro essiccatore	F3BE0681C	324	440	10/04	>				S 7259 A
VGT filter / filtro VGT	F3BE0681C	324	440	10/04	>				S 0VGT A
2 filters / N.2 filtri	F3BE0681C	324	440	10/04	>		S 3288 R		
prefilter / prefiltra	F3BE0681C	324	440	10/04	>			S 1999 NR	
AT190T45 Cursor13 E6	F3GFE611B	332	450	01/13	>		S 5102 PE	S 6044 NE	
prefilter / prefiltra	F3GFE611B	332	450	01/13	>			S 4474 NR	
AT260T33 Cursor 8	F2BE3681B Euro4/5	243	330	04/06	>		S 3288 R	S 4396 NR	S 7600 A
some BLOW-BY filter (504153481) / alcuni filtro BLOW-BY (504153481)	F2BE3681B Euro4/5	243	330	04/06	>				S 7266 A
with filter Urea/Adblue / con filtro Urea/Adblue	F2BE3681B Euro4/5	243	330	04/06	>				S 4401 U
dryer filter / filtro essiccatore	F2BE3681B Euro4/5	243	330	04/06	>				S 7259 A
VGT filter / filtro VGT	F2BE3681B Euro4/5	243	330	04/06	>				S 0VGT A
prefilter / prefiltra	F2BE3681B Euro4/5	243	330	04/06	>			S 1999 NR	
power steering / servosterzo	F2BE3681B Euro4/5	243	330	04/06	>				S 3081 PO
AT260T33B Cursor 8	F2BE3681B Euro4/5	243	330	04/06	>		S 3288 R	S 4396 NR	S 7600 A
some BLOW-BY filter (504153481) / alcuni filtro BLOW-BY (504153481)	F2BE3681B Euro4/5	243	330	04/06	>				S 7266 A
with filter Urea/Adblue / con filtro Urea/Adblue	F2BE3681B Euro4/5	243	330	04/06	>				S 4401 U
dryer filter / filtro essiccatore	F2BE3681B Euro4/5	243	330	04/06	>				S 7259 A
VGT filter / filtro VGT	F2BE3681B Euro4/5	243	330	04/06	>				S 0VGT A
prefilter / prefiltra	F2BE3681B Euro4/5	243	330	04/06	>			S 1999 NR	
power steering / servosterzo	F2BE3681B Euro4/5	243	330	04/06	>				S 3081 PO
AT260T33B/P Cursor 8	F2BE3681B Euro4/5	243	330	04/06	>		S 3288 R	S 4396 NR	S 7600 A
some BLOW-BY filter (504153481) / alcuni filtro BLOW-BY (504153481)	F2BE3681B Euro4/5	243	330	04/06	>				S 7266 A
with filter Urea/Adblue / con filtro Urea/Adblue	F2BE3681B Euro4/5	243	330	04/06	>				S 4401 U
dryer filter / filtro essiccatore	F2BE3681B Euro4/5	243	330	04/06	>				S 7259 A
VGT filter / filtro VGT	F2BE3681B Euro4/5	243	330	04/06	>				S 0VGT A
prefilter / prefiltra	F2BE3681B Euro4/5	243	330	04/06	>			S 1999 NR	
power steering / servosterzo	F2BE3681B Euro4/5	243	330	04/06	>				S 3081 PO
AT260T36 Cursor9 E6	F2CFE611B	265	360	01/13	>		S 5102 PE	S 6043 NE	
prefilter / prefiltra	F2CFE611B	265	360	01/13	>			S 4474 NR	
AT260T36W Cursor9	F2CFE611B Euro6	265	360	01/13	>		S 5102 PE	S 6043 NE	
AT260T41 Cursor13 E6	F3GFE611D	302	410	01/13	>		S 5102 PE	S 6044 NE	
prefilter / prefiltra	F3GFE611D	302	410	01/13	>			S 4474 NR	
AT260T45 Cursor13 E6	F3GFE611B	332	450	01/13	>		S 5102 PE	S 6044 NE	
prefilter / prefiltra	F3GFE611B	332	450	01/13	>			S 4474 NR	
AT260T50 Cursor 13	F3BE3681B Euro4/5	368	500	04/06	>	05/07		S 1395 NR	S 7600 A



**KW HP****...IVECO - trucks/autocarri**

some BLOW-BY filter (504153481) / alcuni filtro BLOW-BY (504153481)	F3BE3681B Euro4/5	368	500	06/07	>	S 5087 OC	S 1395 NR	S 7600 A	S 3078 C
dryer filter / filtro essiccatore	F3BE3681B Euro4/5	368	500	04/06	>				S 7266 A
VGT filter / filtro VGT	F3BE3681B Euro4/5	368	500	04/06	>				S 7259 A
2 filters / N.2 filtri	F3BE3681B Euro4/5	368	500	04/06	>				S 0VGT A
prefilter / prefiltra	F3BE3681B Euro4/5	368	500	04/06	>	S 3288 R			
power steering / servosterzo	F3BE3681B Euro4/5	368	500	04/06	>		S 1999 NR		
spare part only 150.000 km / solo ricambio 150.000 km	F3BE3681B Euro4/5	368	500	10/11	>	S 5111 PE			S 3081 PO
AT260T50 Cursor13 E6	F3HFE611B	368	500	01/13	>	S 5102 PE	S 6044 NE		
prefilter / prefiltra	F3HFE611B	368	500	01/13	>		S 4474 NR		
AT340T41 Cursor13 E6	F3GFE611D	302	410	01/13	>	S 5102 PE	S 6044 NE		
prefilter / prefiltra	F3GFE611D	302	410	01/13	>		S 4474 NR		
AT340T45 Cursor13 E6	F3GFE611B	332	450	01/13	>	S 5102 PE	S 6044 NE		
prefilter / prefiltra	F3GFE611B	332	450	01/13	>		S 4474 NR		
AT340T50 Cursor13 E6	F3HFE611B	368	500	01/13	>	S 5102 PE	S 6044 NE		
prefilter / prefiltra	F3HFE611B	368	500	01/13	>		S 4474 NR		
AT380T35 Cursor 8	F2BE0681A	259	352	10/04	>	S 3288 R	S 4396 NR	S 7600 A	S 3078 C
some / alcuni	F2BE0681A	259	352	10/04	>	S 3288 R	S 4396 NR	S 7562 A	S 3078 C
some BLOW-BY filter (504153481) / alcuni filtro BLOW-BY (504153481)	F2BE0681A	259	352	10/04	>				S 7266 A
dryer filter / filtro essiccatore	F2BE0681A	259	352	10/04	>				S 7259 A
VGT filter / filtro VGT	F2BE0681A	259	352	10/04	>				S 0VGT A
prefilter / prefiltra	F2BE0681A	259	352	10/04	>		S 1999 NR		
power steering / servosterzo	F2BE0681A	259	352	10/04	>				S 3081 PO
AT380T38 Cursor 13	F3BE0681G	279	380	10/04	>	02/06	S 4395 NR	S 7600 A	S 3078 C
	F3BE0681G	279	380	03/06	>	05/07	S 1395 NR	S 7600 A	S 3078 C
	F3BE0681G	279	380	06/07	>	S 5087 OC	S 1395 NR	S 7600 A	S 3078 C
some / alcuni	F3BE0681G	279	380	10/04	>			S 7562 A	
some BLOW-BY filter (504153481) / alcuni filtro BLOW-BY (504153481)	F3BE0681G	279	380	10/04	>				S 7266 A
dryer filter / filtro essiccatore	F3BE0681G	279	380	10/04	>				S 7259 A
VGT filter / filtro VGT	F3BE0681G	279	380	10/04	>				S 0VGT A
2 filters / N.2 filtri	F3BE0681G	279	380	10/04	>	05/07	S 3288 R		
prefilter / prefiltra	F3BE0681G	279	380	10/04	>		S 1999 NR		
power steering / servosterzo	F3BE0681G	279	380	10/04	>				S 3081 PO
spare part only 150.000 km / solo ricambio 150.000 km	F3BE0681G	279	380	10/11	>	S 5111 PE			
AT380T41 Cursor13 E6	F3GFE611D	302	410	01/13	>	S 5102 PE	S 6044 NE		
prefilter / prefiltra	F3GFE611D	302	410	01/13	>		S 4474 NR		
AT380T44 Cursor 13	F3BE0681C	324	440	10/04	>		S 4395 NR	S 7600 A	S 3078 C
some BLOW-BY filter (504153481) / alcuni filtro BLOW-BY (504153481)	F3BE0681C	324	440	10/04	>				S 7266 A
dryer filter / filtro essiccatore	F3BE0681C	324	440	10/04	>				S 7259 A
VGT filter / filtro VGT	F3BE0681C	324	440	10/04	>				S 0VGT A
2 filters / N.2 filtri	F3BE0681C	324	440	10/04	>	S 3288 R			
prefilter / prefiltra	F3BE0681C	324	440	10/04	>		S 1999 NR		
power steering / servosterzo	F3BE0681C	324	440	10/04	>				S 3081 PO
AT380T45 Cursor13 E6	F3GFE611B	332	450	01/13	>	S 5102 PE	S 6044 NE		
prefilter / prefiltra	F3GFE611B	332	450	01/13	>		S 4474 NR		
AT380T48 Cursor 13	F3BE0681E	353	480	10/04	>		S 4395 NR	S 7600 A	S 3078 C
some BLOW-BY filter (504153481) / alcuni filtro BLOW-BY (504153481)	F3BE0681E	353	480	10/04	>				S 7266 A
dryer filter / filtro essiccatore	F3BE0681E	353	480	10/04	>				S 7259 A
VGT filter / filtro VGT	F3BE0681E	353	480	10/04	>				S 0VGT A
2 filters / N.2 filtri	F3BE0681E	353	480	10/04	>	S 3288 R			
prefilter / prefiltra	F3BE0681E	353	480	10/04	>		S 1999 NR		
power steering / servosterzo	F3BE0681E	353	480	10/04	>				S 3081 PO
AT380T50 Cursor 13	F3BE3681B Euro4/5	368	500	04/06	>	05/07	S 1395 NR	S 7600 A	S 3078 C
	F3BE3681B Euro4/5	368	500	06/07	>	S 5087 OC	S 1395 NR	S 7600 A	S 3078 C
some BLOW-BY filter (504153481) / alcuni filtro BLOW-BY (504153481)	F3BE3681B Euro4/5	368	500	04/06	>				S 7266 A
dryer filter / filtro essiccatore	F3BE3681B Euro4/5	368	500	04/06	>				S 7259 A
VGT filter / filtro VGT	F3BE3681B Euro4/5	368	500	04/06	>				S 0VGT A
2 filters / N.2 filtri	F3BE3681B Euro4/5	368	500	04/06	>	05/07	S 3288 R		
prefilter / prefiltra	F3BE3681B Euro4/5	368	500	04/06	>		S 1999 NR		
power steering / servosterzo	F3BE3681B Euro4/5	368	500	04/06	>				S 3081 PO
spare part only 150.000 km / solo ricambio 150.000 km	F3BE3681B Euro4/5	368	500	10/11	>	S 5111 PE			
AT380T50 Cursor13 E6	F3HFE611B	368	500	01/13	>	S 5102 PE	S 6044 NE		
prefilter / prefiltra	F3HFE611B	368	500	01/13	>		S 4474 NR		
AT400T41 Cursor13 E6	F3GFE611D	302	410	01/13	>	S 5102 PE	S 6044 NE		
prefilter / prefiltra	F3GFE611D	302	410	01/13	>		S 4474 NR		
AT400T45 Cursor13 E6	F3GFE611B	332	450	01/13	>	S 5102 PE	S 6044 NE		
prefilter / prefiltra	F3GFE611B	332	450	01/13	>		S 4474 NR		

**KW HP****...IVECO - trucks/autocarri**

AT400T50 Cursor 13	F3BE3681B Euro4/5	368	500	04/06 >	05/07		S 1395 NR	S 7600 A	S 3078 C
some BLOW-BY filter (504153481) / alcuni filtro BLOW-BY (504153481)	F3BE3681B Euro4/5	368	500	06/07 >		S 5087 OC	S 1395 NR	S 7600 A	S 3078 C
dryer filter / filtro essiccatore	F3BE3681B Euro4/5	368	500	04/06 >					S 7266 A
VGT filter / filtro VGT	F3BE3681B Euro4/5	368	500	04/06 >					S 7259 A
2 filters / N.2 filtri	F3BE3681B Euro4/5	368	500	04/06 >	05/07	S 3288 R			S 0VGT A
prefilter / prefiltra	F3BE3681B Euro4/5	368	500	04/06 >			S 1999 NR		
power steering / servosterzo	F3BE3681B Euro4/5	368	500	04/06 >					S 3081 PO
spare part only 150.000 km / solo ricambio 150.000 km	F3BE3681B Euro4/5	368	500	10/11 >		S 5111 PE			
AT410T38 Cursor 13	F3BE0681G	279	380	10/04 >	02/06		S 4395 NR	S 7600 A	S 3078 C
	F3BE0681G	279	380	03/06 >	05/07		S 1395 NR	S 7600 A	S 3078 C
some / alcuni	F3BE0681G	279	380	06/07 >		S 5087 OC	S 1395 NR	S 7600 A	S 3078 C
some BLOW-BY filter (504153481) / alcuni filtro BLOW-BY (504153481)	F3BE0681G	279	380	10/04 >				S 7562 A	
dryer filter / filtro essiccatore	F3BE0681G	279	380	10/04 >					S 7266 A
VGT filter / filtro VGT	F3BE0681G	279	380	10/04 >					S 7259 A
2 filters / N.2 filtri	F3BE0681G	279	380	10/04 >	05/07	S 3288 R			S 0VGT A
prefilter / prefiltra	F3BE0681G	279	380	10/04 >			S 1999 NR		
power steering / servosterzo	F3BE0681G	279	380	10/04 >					S 3081 PO
spare part only 150.000 km / solo ricambio 150.000 km	F3BE0681G	279	380	10/11 >		S 5111 PE			
AT410T41 Cursor13 E6	F3GFE611D	302	410	01/13 >		S 5102 PE	S 6044 NE		
prefilter / prefiltra	F3GFE611D	302	410	01/13 >			S 4474 NR		
AT410T44 Cursor 13	F3BE0681C	324	440	10/04 >			S 4395 NR	S 7600 A	S 3078 C
some BLOW-BY filter (504153481) / alcuni filtro BLOW-BY (504153481)	F3BE0681C	324	440	10/04 >					S 7266 A
dryer filter / filtro essiccatore	F3BE0681C	324	440	10/04 >					S 7259 A
VGT filter / filtro VGT	F3BE0681C	324	440	10/04 >					S 0VGT A
2 filters / N.2 filtri	F3BE0681C	324	440	10/04 >		S 3288 R			
prefilter / prefiltra	F3BE0681C	324	440	10/04 >			S 1999 NR		
power steering / servosterzo	F3BE0681C	324	440	10/04 >					S 3081 PO
AT410T45 Cursor13 E6	F3GFE611B	332	450	01/13 >		S 5102 PE	S 6044 NE		
prefilter / prefiltra	F3GFE611B	332	450	01/13 >			S 4474 NR		
AT410T48 Cursor 13	F3BE0681E	353	480	10/04 >			S 4395 NR	S 7600 A	S 3078 C
some BLOW-BY filter (504153481) / alcuni filtro BLOW-BY (504153481)	F3BE0681E	353	480	10/04 >					S 7266 A
dryer filter / filtro essiccatore	F3BE0681E	353	480	10/04 >					S 7259 A
VGT filter / filtro VGT	F3BE0681E	353	480	10/04 >					S 0VGT A
2 filters / N.2 filtri	F3BE0681E	353	480	10/04 >		S 3288 R			
prefilter / prefiltra	F3BE0681E	353	480	10/04 >			S 1999 NR		
power steering / servosterzo	F3BE0681E	353	480	10/04 >					S 3081 PO
AT410T50 Cursor 13	F3BE3681B Euro4/5	368	500	04/06 >	05/07		S 1395 NR	S 7600 A	S 3078 C
some BLOW-BY filter (504153481) / alcuni filtro BLOW-BY (504153481)	F3BE3681B Euro4/5	368	500	06/07 >		S 5087 OC	S 1395 NR	S 7600 A	S 3078 C
with filter Urea/Adblue / con filtro Urea/Adblue	F3BE3681B Euro4/5	368	500	04/06 >					S 7266 A
dryer filter / filtro essiccatore	F3BE3681B Euro4/5	368	500	04/06 >					S 4401 U
VGT filter / filtro VGT	F3BE3681B Euro4/5	368	500	04/06 >					S 7259 A
2 filters / N.2 filtri	F3BE3681B Euro4/5	368	500	04/06 >	05/07	S 3288 R			S 0VGT A
prefilter / prefiltra	F3BE3681B Euro4/5	368	500	04/06 >			S 1999 NR		
power steering / servosterzo	F3BE3681B Euro4/5	368	500	04/06 >					S 3081 PO
spare part only 150.000 km / solo ricambio 150.000 km	F3BE3681B Euro4/5	368	500	10/11 >		S 5111 PE			
AT410T50 Cursor13 E6	F3HFE611B	368	500	01/13 >		S 5102 PE	S 6044 NE		
prefilter / prefiltra	F3HFE611B	368	500	01/13 >			S 4474 NR		
AT440T50 Cursor 13	F3BE3681B Euro4/5	368	500	04/06 >	05/07		S 1395 NR	S 7600 A	S 3078 C
	F3BE3681B Euro4/5	368	500	06/07 >		S 5087 OC	S 1395 NR	S 7600 A	S 3078 C
some BLOW-BY filter (504153481) / alcuni filtro BLOW-BY (504153481)	F3BE3681B Euro4/5	368	500	04/06 >					S 7266 A
with filter Urea/Adblue / con filtro Urea/Adblue	F3BE3681B Euro4/5	368	500	04/06 >					S 4401 U
dryer filter / filtro essiccatore	F3BE3681B Euro4/5	368	500	04/06 >					S 7259 A
VGT filter / filtro VGT	F3BE3681B Euro4/5	368	500	04/06 >					S 0VGT A
2 filters / N.2 filtri	F3BE3681B Euro4/5	368	500	04/06 >	05/07	S 3288 R			
prefilter / prefiltra	F3BE3681B Euro4/5	368	500	04/06 >			S 1999 NR		
power steering / servosterzo	F3BE3681B Euro4/5	368	500	04/06 >					S 3081 PO
spare part only 150.000 km / solo ricambio 150.000 km	F3BE3681B Euro4/5	368	500	10/11 >		S 5111 PE			
AT720T44T Cursor 13	F3BE0681C	324	440	10/04 >			S 4395 NR	S 7600 A	S 3078 C
some BLOW-BY filter (504153481) / alcuni filtro BLOW-BY (504153481)	F3BE0681C	324	440	10/04 >					S 7266 A
dryer filter / filtro essiccatore	F3BE0681C	324	440	10/04 >					S 7259 A
VGT filter / filtro VGT	F3BE0681C	324	440	10/04 >					S 0VGT A
2 filters / N.2 filtri	F3BE0681C	324	440	10/04 >		S 3288 R			
prefilter / prefiltra	F3BE0681C	324	440	10/04 >			S 1999 NR		
power steering / servosterzo	F3BE0681C	324	440	10/04 >					S 3081 PO





KW HP



...IVECO - trucks/autocarri

AT720T48T Cursor 13	F3BE0681E	353	480	10/04 >		S 4395 NR	S 7600 A	S 3078 C
some BLOW-BY filter (504153481) / alcuni filtro BLOW-BY (504153481)	F3BE0681E	353	480	10/04 >				S 7266 A
dryer filter / filtro essiccatore	F3BE0681E	353	480	10/04 >				S 7259 A
VGT filter / filtro VGT	F3BE0681E	353	480	10/04 >				S 0VGT A
2 filters / N.2 filtri	F3BE0681E	353	480	10/04 >	S 3288 R			
prefilter / prefiltrato	F3BE0681E	353	480	10/04 >		S 1999 NR		
power steering / servosterzo	F3BE0681E	353	480	10/04 >				S 3081 PO
AT720T50 Cursor 13	F3BE3681B Euro4/5	368	500	04/06 > 05/07		S 1395 NR	S 7600 A	S 3078 C
	F3BE3681B Euro4/5	368	500	06/07 >	S 5087 OC	S 1395 NR	S 7600 A	S 3078 C
some BLOW-BY filter (504153481) / alcuni filtro BLOW-BY (504153481)	F3BE3681B Euro4/5	368	500	04/06 >				S 7266 A
with filter Urea/Adblue / con filtro Urea/Adblue	F3BE3681B Euro4/5	368	500	04/06 >				S 4401 U
dryer filter / filtro essiccatore	F3BE3681B Euro4/5	368	500	04/06 >				S 7259 A
VGT filter / filtro VGT	F3BE3681B Euro4/5	368	500	04/06 >				S 0VGT A
2 filters / N.2 filtri	F3BE3681B Euro4/5	368	500	04/06 > 05/07	S 3288 R			
prefilter / prefiltrato	F3BE3681B Euro4/5	368	500	04/06 >		S 1999 NR		
power steering / servosterzo	F3BE3681B Euro4/5	368	500	04/06 >				S 3081 PO
spare part only 150.000 km / solo ricambio 150.000 km	F3BE3681B Euro4/5	368	500	10/11 >	S 5111 PE			
AT720T50 Cursor13 E6	F3HFE611B	368	500	01/13 >	S 5102 PE	S 6044 NE		
prefilter / prefiltrato	F3HFE611B	368	500	01/13 >		S 4474 NR		
Turbostar								
190.33								
assembly DONALDSON / montaggio DONALDSON	8210.22.105	243	330	07/84 > 12/87	S 5003 DR	S 0710 NR	S 4270 A	S 8410 AR
assembly MANN / montaggio MANN	8210.22.105	243	330	07/84 > 12/87	S 5003 DR	S 0710 NR	S 7546 A	S 8410 AR
power steering / servosterzo	8210.22.105	243	330	07/84 > 12/87				S 3081 PO
190.36								
dryer filter / filtro essiccatore	8210.42			07/87 > 12/93				S 7259 A
inner / interno	8210.42			07/87 > 12/93			S 1307 A	
assembly DONALDSON / montaggio DONALDSON	8210.42			07/87 > 12/93	S 5003 DR	S 0710 NR	S 4270 A	S 8410 AR
assembly MANN / montaggio MANN	8210.42			07/87 > 12/93	S 5003 DR	S 0710 NR	S 7546 A	S 8410 AR
power steering / servosterzo	8210.42			07/87 > 12/93				S 3081 PO
190.42								
dryer filter / filtro essiccatore				07/84 > 12/90				S 7259 A
assembly DONALDSON / montaggio DONALDSON				07/84 > 12/90		S 0710 NR	S 4270 A	S 8410 AR
assembly MANN / montaggio MANN				07/84 > 12/90		S 0710 NR	S 7546 A	S 8410 AR
1 filter / N.1 filtro				07/84 > 12/90	S 3260 R			
3 filters / N.3 filtri				07/84 > 12/90	S 8020 R			
power steering / servosterzo				07/84 > 12/90				S 3081 PO
190.48 Intercooler								
dryer filter / filtro essiccatore				03/89 > 12/93	S 2003 DR	S 5401 NR	S 7168 A	S 8410 AR
or / oppure				03/89 > 12/93	S 2003 DR	S 5400 NR	S 7168 A	S 7259 A
power steering / servosterzo				03/89 > 12/93	S 2003 DR	S 5400 NR	S 7168 A	S 8410 AR
				03/89 > 12/93				S 3081 PO
240.36								
dryer filter / filtro essiccatore				07/90 > 12/93				S 7259 A
inner / interno				07/90 > 12/93			S 1307 A	
assembly DONALDSON / montaggio DONALDSON				07/90 > 12/93	S 5003 DR	S 0710 NR	S 4270 A	S 8410 AR
assembly MANN+HUMMEL / montaggio MANN+HUMMEL				07/90 > 12/93	S 5003 DR	S 0710 NR	S 7546 A	S 8410 AR
power steering / servosterzo				07/90 > 12/93				S 3081 PO
240.48 Intercooler								
dryer filter / filtro essiccatore				03/89 > 12/93	S 2003 DR	S 5401 NR	S 7168 A	S 8410 AR
or / oppure				03/89 > 12/93	S 2003 DR	S 5400 NR	S 7168 A	S 7259 A
power steering / servosterzo				03/89 > 12/93	S 2003 DR	S 5400 NR	S 7168 A	S 8410 AR
				03/89 > 12/93				S 3081 PO
260.36								
dryer filter / filtro essiccatore				07/88 > 06/90				S 7259 A
inner / interno				07/88 > 06/90			S 1307 A	
assembly DONALDSON / montaggio DONALDSON				07/88 > 06/90	S 5003 DR	S 0710 NR	S 4270 A	S 8410 AR
assembly MANN+HUMMEL / montaggio MANN+HUMMEL				07/88 > 06/90	S 5003 DR	S 0710 NR	S 7546 A	S 8410 AR
power steering / servosterzo				07/88 > 06/90				S 3081 PO
260.48 Intercooler								
dryer filter / filtro essiccatore				03/89 > 12/93	S 2003 DR	S 5401 NR	S 7168 A	S 8410 AR
or / oppure				03/89 > 12/93	S 2003 DR	S 5400 NR	S 7168 A	S 7259 A
power steering / servosterzo				03/89 > 12/93	S 2003 DR	S 5400 NR	S 7168 A	S 8410 AR
				03/89 > 12/93				S 3081 PO
Turbotech								
190.24								
power steering / servosterzo				01/90 >	S 5003 DR	S 0710 NR	S 7546 A	S 8410 AR
				01/90 >				S 3081 PO
190.26								
dryer filter / filtro essiccatore	8460.21	192	261	01/90 > 12/92				S 7259 A
assembly MANN+HUMMEL / montaggio MANN+HUMMEL	8460.21	192	261	01/90 > 12/92	S 5003 DR	S 0710 NR	S 7546 A	S 8410 AR

**kW HP****...IVECO - trucks/autocarri**

assembly MOTOFIDES / montaggio MOTOFIDES	8460.21	192 261	01/90 > 12/92	S 5003 DR	S 0710 NR	S 4270 A	S 8410 AR
power steering / servosterzo	8460.21	192 261	01/90 > 12/92				S 3081 PO
190.26T							
dryer filter / filtro essiccatore	8460.21	192 261	01/90 > 12/92				S 7259 A
assembly / montaggio	8460.21	192 261	01/90 > 12/92	S 5003 DR	S 0710 NR	S 7546 A	S 8410 AR
assembly / montaggio	8460.21	192 261	01/90 > 12/92	S 5003 DR	S 0710 NR	S 4270 A	S 8410 AR
power steering / servosterzo	8460.21	192 261	01/90 > 12/92				S 3081 PO
190.30			01/90 >	S 5003 DR	S 0710 NR	S 7546 A	
power steering / servosterzo			01/90 >				S 3081 PO
190.32	8460.41	234 318	01/90 > 12/92	S 5003 DR	S 0710 NR	S 7546 A	S 8410 AR
dryer filter / filtro essiccatore	8460.41	234 318	01/90 > 12/92				S 7259 A
power steering / servosterzo	8460.41	234 318	01/90 > 12/92				S 3081 PO
190.32T	8460.41	234 318	01/90 > 12/92	S 5003 DR	S 0710 NR	S 7546 A	S 8410 AR
dryer filter / filtro essiccatore	8460.41	234 318	01/90 > 12/92				S 7259 A
power steering / servosterzo	8460.41	234 318	01/90 > 12/92				S 3081 PO
190.36							
dryer filter / filtro essiccatore	8210.42	277 377	01/90 > 12/92				S 7259 A
inner / interno	8210.42	277 377	01/90 > 12/92			S 1307 A	
assembly DONALDSON / montaggio DONALDSON	8210.42	277 377	01/90 > 12/92	S 5003 DR	S 0710 NR	S 4270 A	
assembly MANN+HUMMEL / montaggio MANN+HUMMEL	8210.42	277 377	01/90 > 12/92	S 5003 DR	S 0710 NR	S 7546 A	
power steering / servosterzo	8210.42	277 377	01/90 > 12/92				S 3081 PO
190.38							
dryer filter / filtro essiccatore	8210.42	277 377	01/90 > 12/92				S 7259 A
assembly DONALDSON / montaggio DONALDSON	8210.42	277 377	01/90 > 12/92	S 5003 DR	S 0710 NR	S 4270 A	
assembly MANN+HUMMEL / montaggio MANN+HUMMEL	8210.42	277 377	01/90 > 12/92	S 5003 DR	S 0710 NR	S 7546 A	
power steering / servosterzo	8210.42	277 377	01/90 > 12/92				S 3081 PO
220.32			01/90 >	S 5003 DR	S 0710 NR	S 7546 A	S 8410 AR
dryer filter / filtro essiccatore			01/90 >				S 7259 A
power steering / servosterzo			01/90 >				S 3081 PO
220.36							
dryer filter / filtro essiccatore	8210.42	277 377	01/90 > 12/92				S 7259 A
assembly DONALDSON / montaggio DONALDSON	8210.42	277 377	01/90 > 12/92	S 5003 DR	S 0710 NR	S 4270 A	
assembly MANN+HUMMEL / montaggio MANN+HUMMEL	8210.42	277 377	01/90 > 12/92	S 5003 DR	S 0710 NR	S 7546 A	
power steering / servosterzo	8210.42	277 377	01/90 > 12/92				S 3081 PO
220.38							
dryer filter / filtro essiccatore	8210.42	277 377	01/90 > 12/92				S 7259 A
assembly DONALDSON / montaggio DONALDSON	8210.42	277 377	01/90 > 12/92	S 5003 DR	S 0710 NR	S 4270 A	
assembly MANN+HUMMEL / montaggio MANN+HUMMEL	8210.42	277 377	01/90 > 12/92	S 5003 DR	S 0710 NR	S 7546 A	
power steering / servosterzo	8210.42	277 377	01/90 > 12/92				S 3081 PO
240.26			01/90 >	S 5003 DR	S 0710 NR	S 7546 A	S 8410 AR
power steering / servosterzo			01/90 >				S 3081 PO
240.36							
dryer filter / filtro essiccatore	8210.42	277 377	01/90 > 12/92				S 7259 A
assembly DONALDSON / montaggio DONALDSON	8210.42	277 377	01/90 > 12/92	S 5003 DR	S 0710 NR	S 4270 A	
assembly MANN+HUMMEL / montaggio MANN+HUMMEL	8210.42	277 377	01/90 > 12/92	S 5003 DR	S 0710 NR	S 7546 A	
power steering / servosterzo	8210.42	277 377	01/90 > 12/92				S 3081 PO
240.38							
dryer filter / filtro essiccatore	8210.42	277 377	01/90 > 12/92				S 7259 A
assembly DONALDSON / montaggio DONALDSON	8210.42	277 377	01/90 > 12/92	S 5003 DR	S 0710 NR	S 4270 A	
assembly MANN+HUMMEL / montaggio MANN+HUMMEL	8210.42	277 377	01/90 > 12/92	S 5003 DR	S 0710 NR	S 7546 A	
power steering / servosterzo	8210.42	277 377	01/90 > 12/92				S 3081 PO
260.32			01/90 >	S 5003 DR	S 0710 NR	S 7546 A	S 8410 AR
dryer filter / filtro essiccatore			01/90 >				S 7259 A
power steering / servosterzo			01/90 >				S 3081 PO
260.36							
dryer filter / filtro essiccatore	8210.42	277 377	01/90 > 12/92				S 7259 A
inner / interno	8210.42	277 377	01/90 > 12/92			S 1307 A	
assembly DONALDSON / montaggio DONALDSON	8210.42	277 377	01/90 > 12/92	S 5003 DR	S 0710 NR	S 4270 A	
assembly MANN+HUMMEL / montaggio MANN+HUMMEL	8210.42	277 377	01/90 > 12/92	S 5003 DR	S 0710 NR	S 7546 A	
power steering / servosterzo	8210.42	277 377	01/90 > 12/92				S 3081 PO
260.38							
dryer filter / filtro essiccatore	8210.42	277 377	01/90 > 12/92				S 7259 A
assembly DONALDSON / montaggio DONALDSON	8210.42	277 377	01/90 > 12/92	S 5003 DR	S 0710 NR	S 4270 A	
assembly MANN+HUMMEL / montaggio MANN+HUMMEL	8210.42	277 377	01/90 > 12/92	S 5003 DR	S 0710 NR	S 7546 A	
power steering / servosterzo	8210.42	277 377	01/90 > 12/92				S 3081 PO
Turbotech G.V.							
190.32			01/90 >	S 5003 DR	S 0710 NR	S 6550 A	S 8410 AR





KW HP



...IVECO - trucks/autocarri

some / alcuni	01/90 >	S 5003 DR	S 0710 NR	S 0450 A	S 8410 AR
dryer filter / filtro essiccatore	01/90 >				S 7259 A
power steering / servosterzo	01/90 >				S 3081 PO
190.36	01/90 >	S 5003 DR	S 0710 NR	S 8570 A	
dryer filter / filtro essiccatore	01/90 >				S 7259 A
power steering / servosterzo	01/90 >				S 3081 PO
190.38	01/90 >	S 5003 DR	S 0710 NR	S 8570 A	
dryer filter / filtro essiccatore	01/90 >				S 7259 A
power steering / servosterzo	01/90 >				S 3081 PO
240.32	01/90 >	S 5003 DR	S 0710 NR	S 6550 A	S 8410 AR
some / alcuni	01/90 >	S 5003 DR	S 0710 NR	S 0450 A	S 8410 AR
dryer filter / filtro essiccatore	01/90 >				S 7259 A
power steering / servosterzo	01/90 >				S 3081 PO
240.36	01/90 >	S 5003 DR	S 0710 NR	S 8570 A	
dryer filter / filtro essiccatore	01/90 >				S 7259 A
power steering / servosterzo	01/90 >				S 3081 PO
240.38	01/90 >	S 5003 DR	S 0710 NR	S 8570 A	
dryer filter / filtro essiccatore	01/90 >				S 7259 A
power steering / servosterzo	01/90 >				S 3081 PO

Turbozeta Serie

60.11	8040.25	01/87 > 05/91	S 3003 DR	S 8500 NR	S 5650 A
60.11 V	8040.25	01/87 > 05/91	S 3003 DR	S 8500 NR	S 5650 A
65.12	8040.25	01/87 > 05/91	S 3003 DR	S 8500 NR	S 5650 A
65.12 H	8040.25	01/87 > 05/91	S 3003 DR	S 8500 NR	S 5650 A
65.12 V	8040.25	01/87 > 05/91	S 3003 DR	S 8500 NR	S 5650 A
79.12	8040.25	01/87 > 05/91	S 3003 DR	S 8500 NR	S 5650 A
79.12 H	8040.25	01/87 > 05/91	S 3003 DR	S 8500 NR	S 5650 A
79.12 V	8040.25	01/87 > 05/91	S 3003 DR	S 8500 NR	S 5650 A

Z Serie

Z110/A	8060.04		S 0700 R	S 7111 NC	
with antidraining pipe / con tubo antisvuotamento	8060.04		S 9610 R	S 7111 NC	
Z120	8060.24/25		S 3003 DR	S 7111 NC	
some / alcuni	8060.24/25		S 3003 DR	S 8500 NR	
Z220	8060.24/25		S 3003 DR	S 7111 NC	
some / alcuni	8060.24/25		S 3003 DR	S 8500 NR	
Z220/A	8060.04		S 0700 R	S 7111 NC	
with antidraining pipe / con tubo antisvuotamento	8060.04		S 9610 R	S 7111 NC	
Z230	8060.24/25		S 3003 DR	S 7111 NC	
some / alcuni	8060.24/25		S 3003 DR	S 8500 NR	
Z340	8060.24/25		S 3003 DR	S 7111 NC	
some / alcuni	8060.24/25		S 3003 DR	S 8500 NR	

Zeta Serie

109.14					
with antidraining pipe / con tubo antisvuotamento	8060.04, 8060.05	06/83 > 03/91	S 9610 R		S 5650 A
assembly BOSCH / montaggio BOSCH	8060.04, 8060.05	11/85 > 03/91	S 0700 R	S 8500 NR	S 5650 A
assembly DELPHI / montaggio DELPHI	8060.04, 8060.05	06/83 > 10/85	S 0700 R	S 7111 NC	S 5650 A
power steering / servosterzo	8060.04, 8060.05	06/83 > 03/91			S 3081 PO
109.14 H					
with antidraining pipe / con tubo antisvuotamento	8060.04, 8060.05	06/83 > 03/91	S 9610 R		S 5650 A
assembly BOSCH / montaggio BOSCH	8060.04, 8060.05	11/85 > 03/91	S 0700 R	S 8500 NR	S 5650 A
assembly DELPHI / montaggio DELPHI	8060.04, 8060.05	06/83 > 10/85	S 0700 R	S 7111 NC	S 5650 A
power steering / servosterzo	8060.04, 8060.05	06/83 > 03/91			S 3081 PO
50.10	8340.04	01/79 > 12/86	S 9710 R	S 0610 NR	
50.10 H	8340.04	01/79 > 12/86	S 9710 R	S 0610 NR	
50.10 V	8340.04	01/79 > 12/86	S 9710 R	S 0610 NR	
50.8	8040.04	04/78 > 12/86	S 9710 R	S 7111 NC	
50.8 H	8040.04	04/78 > 12/86	S 9710 R	S 7111 NC	
50.8 V	8040.04	04/78 > 12/86	S 9710 R	S 7111 NC	
50.9	8040.05	01/87 > 06/91	S 9710 R	S 8500 NR	
50.9 H	8040.05	01/87 > 06/91	S 9710 R	S 8500 NR	
50.9 V	8040.05	01/87 > 06/91	S 9710 R	S 8500 NR	
55.10			S 9710 R	S 0610 NR	
55.8	8040.04	04/78 > 12/86	S 9710 R	S 7111 NC	
55.9			S 9710 R	S 0610 NR	
60.10	8340.04	11/79 > 12/86	S 9710 R	S 0610 NR	
60.10 H	8340.04	11/79 > 12/86	S 9710 R	S 0610 NR	
60.10 V	8340.04	11/79 > 12/86	S 9710 R	S 0610 NR	



kW HP



...IVECO - trucks/autocarri

60.8	8040.04	11/79 > 12/83	S 9710 R	S 7111 NC		
65.10	8340.04	11/79 > 01/87	S 9710 R	S 0610 NR		
65.10 H	8340.04	11/79 > 01/87	S 9710 R	S 0610 NR		
65.10 V	8340.04	11/79 > 01/87	S 9710 R	S 0610 NR		
65.9	8040.05	01/87 > 06/91	S 9710 R	S 8500 NR		
70.10			S 9710 R	S 0610 NR		
75.10			S 9710 R	S 0610 NR		
79.10	8340.04	06/79 > 01/87	S 9710 R	S 0610 NR		
79.10 H	8340.04	06/79 > 01/87	S 9710 R	S 0610 NR		
79.13	8060.04	11/79 > 12/83	S 0700 R	S 7111 NC		
spin-on / avvitabile	8060.04	11/79 > 12/83		S 8500 NR		
with antidraining pipe / con tubo antisvuotamento	8060.04	11/79 > 12/83	S 9610 R	S 7111 NC		
79.14	8060.04	01/83 > 08/83	S 0700 R	S 7111 NC		
	8060.04	09/83 > 11/85	S 0700 R	S 8500 NR		
with antidraining pipe / con tubo antisvuotamento	8060.04	01/83 > 11/85	S 9610 R	S 8500 NR		
79.14	8060.05	12/85 >	S 0700 R	S 8500 NR	S 5650 A	
with antidraining pipe / con tubo antisvuotamento	8060.05	12/85 >	S 9610 R	S 8500 NR	S 5650 A	
79.14 H	8060.04	01/83 > 08/83	S 0700 R	S 7111 NC		
	8060.04	09/83 > 11/85	S 0700 R	S 8500 NR		
with antidraining pipe / con tubo antisvuotamento	8060.04	01/83 > 11/85	S 9610 R	S 8500 NR		
79.14 V	8060.04	01/83 > 08/83	S 0700 R	S 7111 NC		
	8060.04	09/83 > 11/85	S 0700 R	S 8500 NR		
with antidraining pipe / con tubo antisvuotamento	8060.04	01/83 > 11/85	S 9610 R	S 8500 NR		
95.14						
with antidraining pipe / con tubo antisvuotamento	8060.04, 8060.05	07/83 > 03/91	S 9610 R		S 5650 A	
assembly BOSCH / montaggio BOSCH	8060.04, 8060.05	11/85 > 03/91	S 0700 R	S 8500 NR	S 5650 A	
assembly DELPHI / montaggio DELPHI	8060.04, 8060.05	07/83 > 10/85	S 0700 R	S 7111 NC	S 5650 A	
power steering / servosterzo	8060.04, 8060.05	07/83 > 03/91				S 3081 PO
95.14 H						
with antidraining pipe / con tubo antisvuotamento	8060.04, 8060.05	07/83 > 03/91	S 9610 R		S 5650 A	
assembly BOSCH / montaggio BOSCH	8060.04, 8060.05	11/85 > 03/91	S 0700 R	S 8500 NR	S 5650 A	
assembly DELPHI / montaggio DELPHI	8060.04, 8060.05	07/83 > 10/85	S 0700 R	S 7111 NC	S 5650 A	
power steering / servosterzo	8060.04, 8060.05	07/83 > 03/91				S 3081 PO
95.14 V						
with antidraining pipe / con tubo antisvuotamento	8060.04, 8060.05	07/83 > 03/91	S 9610 R		S 5650 A	
assembly BOSCH / montaggio BOSCH	8060.04, 8060.05	11/85 > 03/91	S 0700 R	S 8500 NR	S 5650 A	
assembly DELPHI / montaggio DELPHI	8060.04, 8060.05	07/83 > 10/85	S 0700 R	S 7111 NC	S 5650 A	
power steering / servosterzo	8060.04, 8060.05	07/83 > 03/91				S 3081 PO
A55.10			S 9710 R	S 0610 NR		
A60.10			S 9710 R	S 0610 NR		
A70.12			S 9710 R	S 0610 NR		

IVECO

buses/autobus

110 Serie

110A1	8060.02		S 0700 R	S 7111 NC		
some / alcuni	8060.02		S 0700 R	S 8500 NR		
with antidraining pipe / con tubo antisvuotamento	8060.02		S 9610 R	S 7111 NC		
110AI	8060.02		S 0700 R	S 7111 NC		
some / alcuni	8060.02		S 0700 R	S 8500 NR		
with antidraining pipe / con tubo antisvuotamento	8060.02		S 9610 R	S 7111 NC		

120 Serie

120L80	KHD		S 8600 R	S 5400 NR	S 2450 A	
120R80	KHD		S 8600 R	S 5400 NR	S 2450 A	

130 Serie

130A1			S 9710 R			
to engine No. 006980 / a motore N. 006980			S 0230 R			
from engine No. 006981 / da motore N. 006981						
130AI			S 9710 R			
to engine No. 006980 / a motore N. 006980			S 0230 R			
from engine No. 006981 / da motore N. 006981						
130R81	KHD		S 8600 R	S 5400 NR	S 2450 A	

135 Serie

A135.14	8060.05		S 0700 R	S 8500 NR		
with antidraining pipe / con tubo antisvuotamento	8060.05		S 9610 R	S 8500 NR		
A135.17 Turbo	8060.25		S 3003 DR	S 8500 NR		
some / alcuni	8060.25		S 3003 DR	S 8500 NR	S 2650 A	

150 Serie



kW HP



...IVECO - buses/autobus

150L10 2nd passage / 2.passaggio some / alcuni power steering / servosterzo	KHD F6L312, F6L413 KHD F6L312, F6L413 KHD F6L312, F6L413 KHD F6L312, F6L413		S 7600 R S 8600 R	S 0201 N S 1411 N S 0201 N		S 8790 PO
150L10	KHD F6L714			S 1411 N		
150R10 2nd passage / 2.passaggio some / alcuni power steering / servosterzo	KHD F6L312, F6L413 KHD F6L312, F6L413 KHD F6L312, F6L413 KHD F6L312, F6L413		S 7600 R S 8600 R	S 0201 N S 1411 N S 0201 N		S 8790 PO
150R10	KHD F6L714			S 1411 N		
150S10 2nd passage / 2.passaggio some / alcuni power steering / servosterzo	KHD F6L312, F6L413 KHD F6L312, F6L413 KHD F6L312, F6L413 KHD F6L312, F6L413		S 7600 R S 8600 R	S 0201 N S 1411 N S 0201 N		S 8790 PO
150S11 2nd passage / 2.passaggio some / alcuni power steering / servosterzo	KHD F6L312, F6L413 KHD F6L312, F6L413 KHD F6L312, F6L413 KHD F6L312, F6L413		S 7600 R S 8600 R	S 0201 N S 1411 N S 0201 N		S 8790 PO
150S11N	KHD F6L714			S 1411 N		
150S12 2nd passage / 2.passaggio some / alcuni power steering / servosterzo	KHD F6L312, F6L413 KHD F6L312, F6L413 KHD F6L312, F6L413		S 7600 R S 8600 R	S 0201 N S 1411 N S 0201 N		S 8790 PO
160 Serie						
160R81 power steering / servosterzo	KHD BF6L913 KHD BF6L913		S 8600 R	S 5400 NR S 2450 A		S 3081 PO
AP160.12.26	8210.02		S 0230 R	S 0710 NR		
AP160.24	8210.02		S 0230 R	S 0710 NR		
AP160.26	8210.02		S 0230 R	S 0710 NR		
170 Serie						
170L100 2nd passage / 2.passaggio or / oppure			S 7600 R S 8600 R	S 0201 N S 1411 N S 0201 N	S 2450 A S 2450 A	
170S11H VOEV 2nd passage / 2.passaggio some / alcuni power steering / servosterzo	KHD F6L312, F6L413 KHD F6L312, F6L413 KHD F6L312, F6L413 KHD F6L312, F6L413		S 7600 R S 8600 R	S 0201 N S 1411 N S 0201 N		S 8790 PO
170S11M 2nd passage / 2.passaggio some / alcuni power steering / servosterzo	KHD F6L312, F6L413 KHD F6L312, F6L413 KHD F6L312, F6L413		S 7600 R S 8600 R	S 0201 N S 1411 N S 0201 N		S 8790 PO
SH170	KHD F8L413F		S 8600 R	S 5400 NR S 0270 A		
175 Serie						
A175.24 Turbo			S 5003 DR	S 0710 NR S 2650 A		S 8410 AR
200 Serie						
200L100 2nd passage / 2.passaggio or / oppure			S 7600 R S 8600 R	S 0201 N S 1411 N S 0201 N	S 2450 A S 2450 A	
200L120 2nd passage / 2.passaggio or / oppure			S 7600 R S 8600 R	S 0201 N S 1411 N S 0201 N	S 2450 A S 2450 A	
200LS12 2nd passage / 2.passaggio			S 8600 R	S 0201 N S 1411 N	S 2450 A	
200R120 2nd passage / 2.passaggio			S 8600 R	S 0201 N S 1411 N	S 2450 A	
200RS12 2nd passage / 2.passaggio			S 8600 R	S 0201 N S 1411 N	S 2450 A	
210 Serie						
SH210	KHD F8L413F		S 8600 R	S 5400 NR S 0270 A		
230 Serie						
230L117 2nd passage / 2.passaggio			S 8600 R	S 0201 N S 1411 N	S 2450 A	
230L120 2nd passage / 2.passaggio or / oppure			S 7600 R S 8600 R	S 0201 N S 1411 N S 0201 N	S 2450 A S 2450 A	
260 Serie						
260L117P	KHD		S 8600 R	S 5400 NR S 2450 A		



kW HP



...IVECO - buses/autobus

306 Serie							
306							
1st passage (felt spare part) (- N.0063808) / 1.passaggio (ricambio in feltro) (- N.0063808)				S 5911 N			
1st passage (felt spare part) (N.0063809 -) / 1.passaggio (ricambio in feltro) (N.0063809 -)				S 2163 N			
2nd passage (- N.0063808) / 2.passaggio (- N.0063808)				S 6911 N			
2nd passage (N.0063809 -) / 2.passaggio (N.0063809 -)				S 0710 NR			
from engine No. 0063809 / da motore N. 0063809				S 4311 N			
308 Serie							
308							
to engine No. 018108 / a motore N. 018108			S 3300 PO	S 0710 NR			
from engine No. 018109 / da motore N. 018109			S 0230 R	S 0710 NR			
308L							
to engine No. 018108 / a motore N. 018108			S 3300 PO	S 0710 NR			
from engine No. 018109 / da motore N. 018109			S 0230 R	S 0710 NR			
309 Serie							
309							
to engine No. 018108 / a motore N. 018108			S 3300 PO	S 0710 NR			
from engine No. 018109 / da motore N. 018109			S 0230 R	S 0710 NR			
314 Serie							
314/2							
with antidraining pipe / con tubo antisvuotamento			S 0700 R	S 7111 NC			
			S 9610 R	S 7111 NC			
314/3							
with antidraining pipe / con tubo antisvuotamento			S 0700 R	S 7111 NC			
			S 9610 R	S 7111 NC			
315 Serie							
315 Turbo							
to engine No. 334356 / a motore N. 334356		8060.24/.25	S 0700 R	S 7111 NC	S 2450 A		
with antidraining pipe (- N.334356) / con tubo antisvuotamento (- N.334356)		8060.24/.25	S 9610 R	S 7111 NC	S 2450 A		
from engine No. 334357 / da motore N. 334357		8060.24/.25	S 3003 DR	S 7111 NC	S 2450 A		
315.13							
with antidraining pipe / con tubo antisvuotamento			S 0700 R	S 7111 NC	S 2450 A		
			S 9610 R	S 7111 NC	S 2450 A		
315.17							
to engine No. 334356 / a motore N. 334356		8060.24/.25	S 0700 R	S 7111 NC	S 2450 A		
with antidraining pipe (- N.334356) / con tubo antisvuotamento (- N.334356)		8060.24/.25	S 9610 R	S 7111 NC	S 2450 A		
from engine No. 334357 / da motore N. 334357		8060.24/.25	S 3003 DR	S 7111 NC	S 2450 A		
315.8.13							
with antidraining pipe / con tubo antisvuotamento			S 0700 R	S 7111 NC	S 2450 A		
			S 9610 R	S 7111 NC	S 2450 A		
315.8.17 Turbo							
to engine No. 334356 / a motore N. 334356		8060.24/.25	S 0700 R	S 7111 NC	S 2450 A		
with antidraining pipe (- N.334356) / con tubo antisvuotamento (- N.334356)		8060.24/.25	S 9610 R	S 7111 NC	S 2450 A		
from engine No. 334357 / da motore N. 334357		8060.24/.25	S 3003 DR	S 7111 NC	S 2450 A		
316 Serie							
316.13							
with antidraining pipe / con tubo antisvuotamento			S 0700 R	S 7111 NC	S 2450 A		
			S 9610 R	S 7111 NC	S 2450 A		
316.8.13							
with antidraining pipe / con tubo antisvuotamento			S 0700 R	S 7111 NC	S 2450 A		
			S 9610 R	S 7111 NC	S 2450 A		
329 Serie							
329							
			S 9710 R	S 7200 N	S 8760 A		
329 var. 836							
2nd passage / 2.passaggio			S 9710 R	S 0201 N	S 4940 A		
				S 1411 N			
331 Serie							
331							
to engine No. 018178 / a motore N. 018178			S 3300 PO	S 0710 NR			
from engine No. 018179 / da motore N. 018179			S 0230 R	S 0710 NR			
331A							
to engine No. 018178 / a motore N. 018178			S 3300 PO	S 0710 NR			
from engine No. 018179 / da motore N. 018179			S 0230 R	S 0710 NR			
343 Serie							
343							
to engine No. 018108 / a motore N. 018108			S 3300 PO	S 0710 NR	S 0150 A		
from engine No. 018109 / da motore N. 018109			S 0230 R	S 0710 NR	S 0150 A		
3470 Serie							
3470.18.24							
8220.32.701		01/82 > 12/86	S 7600 R	S 0710 NR	S 0450 A	S 8410 AR	
with automatic gearbox ZF HP500/590 / con cambio automatico ZF HP500/590		8220.32.701	01/82 > 12/86			S 2234 Z	
3471 Serie							
3471.18.24							
8220.32.721		01/85 > 12/88	S 7600 R	S 0710 NR	S 0450 A	S 8410 AR	
with automatic gearbox ZF HP500/590 / con cambio automatico ZF HP500/590		8220.32.721	01/85 > 12/88			S 2234 Z	
370 Serie							



kW HP



...IVECO - buses/autobus

370 Turbo with automatic gearbox ZF HP500/590 / con cambio automatico ZF HP500/590		S 0230 R	S 0710 NR	S 8570 A	S 2234 Z
370 Turbo var. 2836 1st passage (felt spare part) / 1.passaggio (ricambio in feltro) 2nd passage / 2.passaggio with automatic gearbox ZF HP500/590 / con cambio automatico ZF HP500/590		S 0230 R S 0230 R	S 4311 N S 2163 N S 0710 NR	S 8570 A S 8570 A	S 2234 Z
370.10.20		S 8600 R	S 0710 NR	S 0150 A	S 8410 AR
370.10.24		S 8600 R	S 0710 NR	S 0450 A	S 8410 AR
370.10.25 to frame No. 005037 / a telaio N. 005037 from frame No. 005038 / da telaio N. 005038		S 0230 R S 0230 R	S 0710 NR S 0710 NR	S 6550 A S 2650 A	S 8410 AR S 8410 AR
370.11.25 to frame No. 005037 / a telaio N. 005037 from frame No. 005038 / da telaio N. 005038		S 0230 R S 0230 R	S 0710 NR S 0710 NR	S 6550 A S 2650 A	S 8410 AR S 8410 AR
370.12.24		S 8600 R	S 0710 NR	S 0450 A	S 8410 AR
370.12.25 to frame No. 005037 / a telaio N. 005037 from frame No. 005038 / da telaio N. 005038		S 0230 R S 0230 R	S 0710 NR S 0710 NR	S 6550 A S 2650 A	S 8410 AR S 8410 AR
370.12.25L with automatic gearbox ZF HP500/590 / con cambio automatico ZF HP500/590		S 0230 R	S 0710 NR	S 8570 A	S 2234 Z
370.12.25L var. 2836 1st passage (felt spare part) / 1.passaggio (ricambio in feltro) 2nd passage / 2.passaggio with automatic gearbox ZF HP500/590 / con cambio automatico ZF HP500/590		S 0230 R S 0230 R	S 4311 N S 2163 N S 0710 NR	S 8570 A S 8570 A	S 2234 Z
370.12.26 with automatic gearbox ZF HP500/590 / con cambio automatico ZF HP500/590		S 0230 R	S 0710 NR	S 6550 A	S 2234 Z
370.12.30 with automatic gearbox ZF HP500/590 / con cambio automatico ZF HP500/590	> 12/85 01/86 >	S 0230 R S 5003 DR	S 0710 NR S 0710 NR	S 8570 A S 8570 A	S 2234 Z
370.12.30 Turbo with automatic gearbox ZF HP500/590 / con cambio automatico ZF HP500/590		S 0230 R	S 4311 N	S 8570 A	S 2234 Z
370.12.30 Turbo var. 2836 1st passage (felt spare part) / 1.passaggio (ricambio in feltro) 2nd passage / 2.passaggio with automatic gearbox ZF HP500/590 / con cambio automatico ZF HP500/590		S 0230 R S 0230 R	S 4311 N S 2163 N S 0710 NR	S 8570 A S 8570 A	S 2234 Z
370.12.35 to frame No. 005136 / a telaio N. 005136 with automatic gearbox ZF HP500/590 / con cambio automatico ZF HP500/590 from frame No. 005137 / da telaio N. 005137		S 0230 R	S 0710 NR	S 6550 A	S 8410 AR S 2234 Z
370.20		S 8600 R	S 0710 NR	S 0150 A	S 8410 AR
370.24		S 8600 R	S 0710 NR	S 0450 A	S 8410 AR
370.25 to frame No. 005037 / a telaio N. 005037 from frame No. 005038 / da telaio N. 005038		S 0230 R S 0230 R	S 0710 NR S 0710 NR	S 6550 A S 2650 A	S 8410 AR S 8410 AR
370.25L with automatic gearbox ZF HP500/590 / con cambio automatico ZF HP500/590		S 0230 R	S 0710 NR	S 8570 A	S 2234 Z
370.25L var. 2836 1st passage (felt spare part) / 1.passaggio (ricambio in feltro) 2nd passage / 2.passaggio with automatic gearbox ZF HP500/590 / con cambio automatico ZF HP500/590		S 0230 R S 0230 R	S 4311 N S 2163 N S 0710 NR	S 8570 A S 8570 A	S 2234 Z
370.26 with automatic gearbox ZF HP500/590 / con cambio automatico ZF HP500/590		S 0230 R	S 0710 NR	S 6550 A	S 2234 Z
370.26 var.3836 1st passage (felt spare part) / 1.passaggio (ricambio in feltro) 2nd passage / 2.passaggio with automatic gearbox ZF HP500/590 / con cambio automatico ZF HP500/590		S 0230 R S 0230 R	S 4311 N S 2163 N S 0710 NR		S 2234 Z
370.30 with automatic gearbox ZF HP500/590 / con cambio automatico ZF HP500/590	> 12/85 01/86 >	S 0230 R S 5003 DR	S 0710 NR S 0710 NR	S 8570 A S 8570 A	S 2234 Z
370.35 to frame No. 005136 / a telaio N. 005136 with automatic gearbox ZF HP500/590 / con cambio automatico ZF HP500/590 from frame No. 005137 / da telaio N. 005137		S 0230 R	S 0710 NR	S 6550 A	S 2234 Z S 8410 AR
370S10.24 Turbo		S 5003 DR	S 0710 NR	S 0450 A	S 8410 AR
370S12L25		S 0230 R	S 0710 NR	S 8570 A	
370S35 to frame No. 005136 / a telaio N. 005136		S 0230 R	S 0710 NR	S 6550 A	S 8410 AR



kW HP



...IVECO - buses/autobus

with automatic gearbox ZF HP500/590 / con cambio automatico ZF HP500/590 from frame No. 005137 / da telaio N. 005137			S 0230 R	S 0710 NR	S 0450 A	S 2234 Z S 8410 AR
370SE2.27	8360.46V	01/00 >	S 5003 DR	S 4329 NR	S 0450 A	S 8410 AR S 7259 A
dryer filter / filtro essiccatore	8360.46V	01/00 >				S 7259 A
370SE27	8360.46	01/98 >	S 5003 DR	S 4329 NR	S 0450 A	S 8410 AR S 7259 A
dryer filter / filtro essiccatore	8360.46	01/98 >				S 7259 A
409 Serie						
409			S 3300 PO	S 0710 NR	S 0150 A	
to engine No. 018178 / a motore N. 018178 from engine No. 018179 / da motore N. 018179			S 0230 R	S 0710 NR	S 0150 A	
418 Serie						
418 AC/AL			S 3300 PO	S 0710 NR		
to engine No. 018108 / a motore N. 018108 from engine No. 018109 / da motore N. 018109			S 0230 R	S 0710 NR		
421 Serie						
421			S 9710 R	S 0710 NR		
470 Serie						
470.10.20	8220.12	09/83 > 06/89	S 7600 R	S 0710 NR	S 0150 A	S 8410 AR S 2234 Z
with automatic gearbox ZF HP500/590 / con cambio automatico ZF HP500/590	8220.12	09/83 > 06/89				S 2234 Z
470.12.20	8220.12	09/83 > 06/89	S 7600 R	S 0710 NR	S 0150 A	S 8410 AR S 2234 Z
with automatic gearbox ZF HP500/590 / con cambio automatico ZF HP500/590	8220.12	09/83 > 06/89				S 2234 Z
470.20	8220.12	09/83 > 06/89	S 7600 R	S 0710 NR	S 0150 A	S 8410 AR S 2234 Z
with automatic gearbox ZF HP500/590 / con cambio automatico ZF HP500/590	8220.12	09/83 > 06/89				S 2234 Z
471 Serie						
471.10.20	8220.12	09/83 > 06/89	S 7600 R	S 0710 NR	S 0150 A	S 8410 AR S 2234 Z
with automatic gearbox ZF HP500/590 / con cambio automatico ZF HP500/590	8220.12	09/83 > 06/89				S 2234 Z
471.12.20	8220.12	09/83 > 06/89	S 7600 R	S 0710 NR	S 0150 A	S 8410 AR S 2234 Z
with automatic gearbox ZF HP500/590 / con cambio automatico ZF HP500/590	8220.12	09/83 > 06/89				S 2234 Z
471.12.24	8220.32		S 7600 R	S 0710 NR	S 0450 A	S 8410 AR S 2234 Z
with automatic gearbox ZF HP500/590 / con cambio automatico ZF HP500/590	8220.32					S 2234 Z
471.18.24	8220.32		S 7600 R	S 0710 NR	S 0450 A	S 8410 AR S 2234 Z
with automatic gearbox ZF HP500/590 / con cambio automatico ZF HP500/590	8220.32					S 2234 Z
471.20	8220.12	09/83 > 06/89	S 7600 R	S 0710 NR	S 0150 A	S 8410 AR S 2234 Z
with automatic gearbox ZF HP500/590 / con cambio automatico ZF HP500/590	8220.12	09/83 > 06/89				S 2234 Z
490 Serie						
490.12.22	8460 TCA	01/93 > 12/97		S 4311 N	S 7546 A	S 8410 AR
1st passage (felt spare part) / 1.passaggio (ricambio in feltro)	8460 TCA	01/93 > 12/97		S 2163 N		
2nd passage / 2.passaggio	8460 TCA	01/93 > 12/97		S 0710 NR		
2 filters / N.2 filtri	8460 TCA	01/93 > 12/97	S 5003 DR			
prefilter / prefiltra	8460 TCA	01/93 > 12/97		S 0999 NR		
power steering / servosterzo	8460 TCA	01/93 > 12/97				S 8790 PO
490.18.29	8460 TCA	01/93 > 12/97		S 4311 N	S 7546 A	S 8410 AR
1st passage (felt spare part) / 1.passaggio (ricambio in feltro)	8460 TCA	01/93 > 12/97		S 2163 N		
2nd passage / 2.passaggio	8460 TCA	01/93 > 12/97		S 0710 NR		
2 filters / N.2 filtri	8460 TCA	01/93 > 12/97	S 5003 DR			
prefilter / prefiltra	8460 TCA	01/93 > 12/97		S 0999 NR		
power steering / servosterzo	8460 TCA	01/93 > 12/97				S 8790 PO
490.18.29	8460.41R	01/93 > 12/97		S 4311 N	S 7546 A	S 8410 AR
1st passage (felt spare part) / 1.passaggio (ricambio in feltro)	8460.41R	01/93 > 12/97		S 2163 N		
2nd passage / 2.passaggio	8460.41R	01/93 > 12/97		S 0710 NR		
with automatic gearbox ZF 4HP600 / con cambio automatico ZF 4HP600	8460.41R	01/93 > 12/97				S 2234 Z
2 filters / N.2 filtri	8460.41R	01/93 > 12/97	S 5003 DR			
prefilter / prefiltra	8460.41R	01/93 > 12/97		S 0999 NR		
power steering / servosterzo	8460.41R	01/93 > 12/97				S 8790 PO
490.18.29 E2	8460.41 TCA	01/93 > 12/97		S 4311 N	S 7546 A	S 8410 AR
1st passage (felt spare part) / 1.passaggio (ricambio in feltro)	8460.41 TCA	01/93 > 12/97		S 2163 N		
2nd passage / 2.passaggio	8460.41 TCA	01/93 > 12/97		S 0710 NR		
2 filters / N.2 filtri	8460.41 TCA	01/93 > 12/97	S 5003 DR			
prefilter / prefiltra	8460.41 TCA	01/93 > 12/97		S 0999 NR		
power steering / servosterzo	8460.41 TCA	01/93 > 12/97				S 8790 PO
490.18.29 E2	8460.41R	01/93 > 12/97		S 4311 N	S 7546 A	S 8410 AR
1st passage (felt spare part) / 1.passaggio (ricambio in feltro)	8460.41R	01/93 > 12/97		S 2163 N		
2nd passage / 2.passaggio	8460.41R	01/93 > 12/97		S 0710 NR		
2 filters / N.2 filtri	8460.41R	01/93 > 12/97	S 5003 DR			
prefilter / prefiltra	8460.41R	01/93 > 12/97		S 0999 NR		
power steering / servosterzo	8460.41R	01/93 > 12/97				S 8790 PO
490.18.29 E2	8460.41R E2	01/93 > 12/97		S 4311 N	S 7546 A	S 8410 AR



kW HP



...IVECO - buses/autobus

1st passage (felt spare part) / 1.passaggio (ricambio in feltro)	8460.41R E2	01/93 > 12/97		S 2163 N		
2nd passage / 2.passaggio	8460.41R E2	01/93 > 12/97		S 0710 NR		
2 filters / N.2 filtri	8460.41R E2	01/93 > 12/97	S 5003 DR			
prefilter / prefiltrò	8460.41R E2	01/93 > 12/97		S 0999 NR		
power steering / servosterzo	8460.41R E2	01/93 > 12/97				S 3081 PO
power steering / servosterzo	8460.41R E2	01/93 > 12/97				S 8790 PO
490E2	8360.46B	01/93 > 12/97	S 5003 DR	S 4329 NR	S 0450 A	S 8410 AR
2 filters / N.2 filtri	8360.46B	01/93 > 12/97	S 5003 DR	S 4329 NR		
power steering / servosterzo	8360.46B	01/93 > 12/97				S 3081 PO
50 Serie						
50.9			S 9710 R	S 0610 NR		
50AI			S 9710 R	S 7111 NC	S 8760 A	
55 Serie						
55.10			S 9710 R	S 0610 NR		
55.9			S 9710 R	S 0610 NR		
A55.10	8340.04, 8340.05		S 9710 R	S 0610 NR		
A55.13	8060.04		S 0700 R	S 7111 NC		
some / alcuni	8060.04		S 0700 R	S 8500 NR		
with antidraining pipe / con tubo antisvuotamento	8060.04		S 9610 R	S 7111 NC		
5522 Serie						
5522	8460.SI/8460.21	01/94 > 12/01		S 4311 N	S 0450 A	S 8410 AR
1st passage (felt spare part) / 1.passaggio (ricambio in feltro)	8460.SI/8460.21	01/94 > 12/01		S 2163 N		
2nd passage / 2.passaggio	8460.SI/8460.21	01/94 > 12/01		S 0710 NR		
2 filters / N.2 filtri	8460.SI/8460.21	01/94 > 12/01	S 5003 DR			
prefilter / prefiltrò	8460.SI/8460.21	01/94 > 12/01		S 0999 NR		
power steering / servosterzo	8460.SI/8460.21	01/94 > 12/01				S 8790 PO
5522 GNC	8469SG10	01/94 > 12/01			S 0450 A	S 8410 AR
2 filters / N.2 filtri	8469SG10	01/94 > 12/01	S 5003 DR			
power steering / servosterzo	8469SG10	01/94 > 12/01				S 8790 PO
570 Serie						
570.10.20			S 7600 R	S 0710 NR	S 0150 A	S 8410 AR
with automatic gearbox ZF HP500/590 / con cambio automatico ZF HP500/590						S 2234 Z
570.12.20			S 7600 R	S 0710 NR	S 0150 A	S 8410 AR
with automatic gearbox ZF HP500/590 / con cambio automatico ZF HP500/590						S 2234 Z
570.20			S 7600 R	S 0710 NR	S 0150 A	S 8410 AR
with automatic gearbox ZF HP500/590 / con cambio automatico ZF HP500/590						S 2234 Z
571 Serie						
571.10.20			S 7600 R	S 0710 NR	S 0150 A	S 8410 AR
with automatic gearbox ZF HP500/590 / con cambio automatico ZF HP500/590						S 2234 Z
571.12.20			S 7600 R	S 0710 NR	S 0150 A	S 8410 AR
with automatic gearbox ZF HP500/590 / con cambio automatico ZF HP500/590						S 2234 Z
571.20			S 7600 R	S 0710 NR	S 0150 A	S 8410 AR
with automatic gearbox ZF HP500/590 / con cambio automatico ZF HP500/590						S 2234 Z
590 Serie						
590E2	8360.46B				S 0450 A	S 8410 AR
2 filters / N.2 filtri	8360.46B		S 5003 DR	S 4329 NR		
power steering / servosterzo	8360.46B					S 3081 PO
590E22	8460.21B			S 4311 N	S 0450 A	S 8410 AR
1st passage (felt spare part) / 1.passaggio (ricambio in feltro)	8460.21B			S 2163 N	S 0450 A	S 8410 AR
2nd passage / 2.passaggio	8460.21B			S 0710 NR		
with automatic gearbox ZF 4HP500 / con cambio automatico ZF 4HP500	8460.21B					S 2234 Z
2 filters / N.2 filtri	8460.21B		S 5003 DR			
power steering / servosterzo	8460.21B					S 8790 PO
60 Serie						
A60.10	8340.04, 8340.05		S 9710 R	S 0610 NR		
A60.9	8040.05		S 9710 R	S 8500 NR		
623 Serie						
623E2	8360.46				S 0450 A	
with automatic gearbox ZF / con cambio automatico ZF	8360.46					S 2234 Z
dryer filter / filtro essiccatore	8360.46					S 7259 A
assembly BOSCH / montaggio BOSCH	8360.46		S 5003 DR	S 5401 NR		
assembly UFI / montaggio UFI	8360.46		S 5003 DR	S 4329 NR		
or / oppure	8360.46		S 5003 DR	S 5400 NR		
power steering / servosterzo	8360.46					S 8790 PO
623E2CNG	8469SG10				S 0450 A	S 8410 AR
dryer filter / filtro essiccatore	8469SG10					S 7259 A
2 filters / N.2 filtri	8469SG10		S 5003 DR			



kW HP



...IVECO - buses/autobus

power steering / servosterzo	8469SG10							S 8790 PO	
670 Serie									
670.12.20						S 7600 R	S 0710 NR	S 0150 A	S 8410 AR
with automatic gearbox ZF HP500/590 / con cambio automatico ZF HP500/590									S 2234 Z
670.20						S 7600 R	S 0710 NR	S 0150 A	S 8410 AR
with automatic gearbox ZF HP500/590 / con cambio automatico ZF HP500/590									S 2234 Z
671 Serie									
671.12.24	8220.32					S 7600 R	S 0710 NR	S 0450 A	S 8410 AR
671.24	8220.32					S 7600 R	S 0710 NR	S 0450 A	S 8410 AR
70 Serie									
70.10						S 9710 R	S 0610 NR		
A70.12	8340.04, 8340.05					S 9710 R	S 0610 NR		
A70.14	8060.05					S 0700 R	S 8500 NR		
with antidraining pipe / con tubo antisvuotamento	8060.05					S 9610 R	S 8500 NR		
A79.14	8060.05					S 0700 R	S 8500 NR		
with antidraining pipe / con tubo antisvuotamento	8060.05					S 9610 R	S 8500 NR		
75 Serie									
75.10						S 9710 R	S 0610 NR		
90 Serie									
A90.13	8060.04					S 0700 R	S 7111 NC		
some / alcuni	8060.04					S 0700 R	S 8500 NR		
with antidraining pipe / con tubo antisvuotamento	8060.04					S 9610 R	S 7111 NC		
A90.14	8060.04					S 0700 R	S 7111 NC		
some / alcuni	8060.04					S 0700 R	S 8500 NR		
with antidraining pipe / con tubo antisvuotamento	8060.04					S 9610 R	S 7111 NC		
A90.14.1	8060.05					S 0700 R	S 8500 NR		
with antidraining pipe / con tubo antisvuotamento	8060.05					S 9610 R	S 8500 NR		
Cityclass									
491.12.22	Cursor 8	162 220	02/00 >			S 3288 R	S 4396 NR	S 7637 A	
with automatic gearbox ZF HP592 / con cambio automatico ZF HP592	Cursor 8	162 220	02/00 >						S 2234 Z
with air-conditioner WEBASTO Aerosphere / con climatizzatore WEBASTO Aerosphere	Cursor 8	162 220	02/00 >						S 3081 C
dryer filter / filtro essiccatore	Cursor 8	162 220	02/00 >						S 7259 A
dryer filter WABCO, right-hand thread / filtro essiccatore WABCO, filetto destro	Cursor 8	162 220	02/00 >						S 7A66 A
filter VGT / filtro VGT	Cursor 8	162 220	02/00 >						S 0VGT A
hydrostatic steering / guida idrostatica	Cursor 8	162 220	02/00 >						S 8137 RH
inner / interno	Cursor 8	162 220	02/00 >					S 7649 A	
prefilter / prefiltro	Cursor 8	162 220	02/00 >				S 0999 NR		
power steering / servosterzo	Cursor 8	162 220	02/00 >						S 3081 PO
491.12.27	Cursor 8	199 270	02/00 >			S 3288 R	S 4396 NR	S 7637 A	
with automatic gearbox ZF HP592 / con cambio automatico ZF HP592	Cursor 8	199 270	02/00 >						S 2234 Z
with air-conditioner WEBASTO Aerosphere / con climatizzatore WEBASTO Aerosphere	Cursor 8	199 270	02/00 >						S 3081 C
dryer filter / filtro essiccatore	Cursor 8	199 270	02/00 >						S 7259 A
dryer filter WABCO, right-hand thread / filtro essiccatore WABCO, filetto destro	Cursor 8	199 270	02/00 >						S 7A66 A
filter VGT / filtro VGT	Cursor 8	199 270	02/00 >						S 0VGT A
hydrostatic steering / guida idrostatica	Cursor 8	199 270	02/00 >						S 8137 RH
inner / interno	Cursor 8	199 270	02/00 >					S 7649 A	
prefilter / prefiltro	Cursor 8	199 270	02/00 >				S 0999 NR		
power steering / servosterzo	Cursor 8	199 270	02/00 >						S 3081 PO
491.24 CNG	8469.21S							S 0450 A	S 8410 AR
some / alcuni	8469.21S							S 7627 A	S 8410 AR
2 filters / N.2 filtri	8469.21S					S 5003 DR			
power steering / servosterzo	8469.21S								S 3081 PO
591.22 CN	8469.21							S 0450 A	S 8410 AR
2 filters / N.2 filtri	8469.21					S 5003 DR			
591.24 CNG	8469.21S							S 0450 A	S 8410 AR
some / alcuni	8469.21S							S 7627 A	S 8410 AR
2 filters / N.2 filtri	8469.21S					S 5003 DR			
power steering / servosterzo	8469.21S								S 3081 PO
Cityclass.29	F2BE0681					S 3288 R		S 0450 A	
some / alcuni	F2BE0681							S 7627 A	
filter VGT / filtro VGT	F2BE0681								S 0VGT A
prefilter / prefiltro	F2BE0681						S 0999 NR		
power steering / servosterzo	F2BE0681								S 3081 PO
Cityclass.31	8469.41S							S 7627 A	S 8410 AR
2 filters / N.2 filtri	8469.41S					S 5003 DR			
power steering / servosterzo	8469.41S								S 3081 PO
Cityclass.35	F2BE0682					S 3288 R		S 0450 A	

**KW HP****...IVECO - buses/autobus**

some / alcuni	F2BE0682						S 7627 A	
filter VGT / filtro VGT	F2BE0682							S 0VGT A
prefilter / prefiltro	F2BE0682					S 0999 NR		
power steering / servosterzo	F2BE0682							S 3081 PO
Crossway								
10.8 m	Cursor 9 Euro 6	294	400	09/13	>	S 5102 PE	S 6043 NE	
prefilter / prefiltro	Cursor 9 Euro 6	294	400	09/13	>		S 4474 NR	
power steering / servosterzo	Cursor 9 Euro 6	294	400	09/13	>			S 3081 PO
10.8 m	F2CPE612B Cursor 9 Euro 6	265	360	09/13	>	S 5102 PE	S 6043 NE	
prefilter / prefiltro	F2CPE612B Cursor 9 Euro 6	265	360	09/13	>		S 4474 NR	
power steering / servosterzo	F2CPE612B Cursor 9 Euro 6	265	360	09/13	>			S 3081 PO
12 m	Cursor 9 Euro 6	294	400	09/13	>	S 5102 PE	S 6043 NE	
spheros aeroshere world SPHEROS / con climatizzatore sul tetto SPHEROS	Cursor 9 Euro 6	294	400	09/13	>			S 3457 C
spheros aeroshere world WEBASTO / con climatizzatore sul tetto WEBASTO	Cursor 9 Euro 6	294	400	09/13	>			S 3444 C
prefilter / prefiltro	Cursor 9 Euro 6	294	400	09/13	>		S 4474 NR	
power steering / servosterzo	Cursor 9 Euro 6	294	400	09/13	>			S 3081 PO
12 m	F2CPE612B Cursor 9 Euro 6	265	360	09/13	>	S 5102 PE	S 6043 NE	
spheros aeroshere world WEBASTO / con climatizzatore sul tetto WEBASTO	F2CPE612B Cursor 9 Euro 6	265	360	09/13	>			S 3444 C
prefilter / prefiltro	F2CPE612B Cursor 9 Euro 6	265	360	09/13	>		S 4474 NR	
power steering / servosterzo	F2CPE612B Cursor 9 Euro 6	265	360	09/13	>			S 3081 PO
13 m	Cursor 9 Euro 6	294	400	09/13	>	S 5102 PE	S 6043 NE	
spheros aeroshere world SPHEROS / con climatizzatore sul tetto SPHEROS	Cursor 9 Euro 6	294	400	09/13	>			S 3457 C
spheros aeroshere world WEBASTO / con climatizzatore sul tetto WEBASTO	Cursor 9 Euro 6	294	400	09/13	>			S 3444 C
prefilter / prefiltro	Cursor 9 Euro 6	294	400	09/13	>		S 4474 NR	
power steering / servosterzo	Cursor 9 Euro 6	294	400	09/13	>			S 3081 PO
13 m	F2CPE612B Cursor 9 Euro 6	265	360	09/13	>	S 5102 PE	S 6043 NE	
spheros aeroshere world WEBASTO / con climatizzatore sul tetto WEBASTO	F2CPE612B Cursor 9 Euro 6	265	360	09/13	>			S 3444 C
prefilter / prefiltro	F2CPE612B Cursor 9 Euro 6	265	360	09/13	>		S 4474 NR	
power steering / servosterzo	F2CPE612B Cursor 9 Euro 6	265	360	09/13	>			S 3081 PO
Daily (MY06)								
40C15 Bus								
with air-conditioner / con climatizzatore	F1CE0481F Euro4	107	146	07/06	>	S 0920 R	S 1071 B	S 7356 A
filter BLOW-BY / filtro BLOW-BY	F1CE0481F Euro4	107	146	07/06	>			S 3161 C
								S 7689 A
40C18 Bus								
with air-conditioner / con climatizzatore	F1CE0481H Euro4	130	176	07/06	>	S 0920 R	S 1071 B	S 7356 A
filter BLOW-BY / filtro BLOW-BY	F1CE0481H Euro4	130	176	07/06	>			S 3161 C
								S 7689 A
50C15 Bus								
with air-conditioner / con climatizzatore	F1CE0481F Euro4	107	146	07/06	>	S 0920 R	S 1071 B	S 7356 A
filter BLOW-BY / filtro BLOW-BY	F1CE0481F Euro4	107	146	07/06	>			S 3161 C
								S 7689 A
50C18 Bus								
with air-conditioner / con climatizzatore	F1CE0481H Euro4	130	176	07/06	>	S 0920 R	S 1071 B	S 7356 A
filter BLOW-BY / filtro BLOW-BY	F1CE0481H Euro4	130	176	07/06	>			S 3161 C
								S 7689 A
Daily S2000								
35S13 Bus								
with IVECO 1908556 / con IVECO 1908556	8140.43S	92	125	01/99	> 06/01	S 3003 DR	S 4394 NR	S 7356 A
with IVECO 2992300 / con IVECO 2992300	8140.43S	92	125	06/01	> 07/06	S 3003 DR	S 1H2O NR	S 7356 A
prefilter / prefiltro	8140.43S	92	125	01/99	> 07/06		S 1028 B	
power steering / servosterzo	8140.43S	92	125	01/99	> 07/06			S 3081 PO
40C13 Bus								
with IVECO 1908556 / con IVECO 1908556	8140.43S	92	125	01/99	> 06/01	S 3003 DR	S 4394 NR	S 7356 A
with IVECO 2992300 / con IVECO 2992300	8140.43S	92	125	06/01	> 07/06	S 3003 DR	S 1H2O NR	S 7356 A
prefilter / prefiltro	8140.43S	92	125	01/99	> 07/06		S 1028 B	
power steering / servosterzo	8140.43S	92	125	06/01	> 07/06			S 3081 PO
40C15 Bus								
prefilter / prefiltro	8140.43N	107	146	06/01	> 07/06	S 3003 DR	S 1H2O NR	S 7356 A
power steering / servosterzo	8140.43N	107	146	06/01	> 07/06		S 1028 B	
	8140.43N	107	146	06/01	> 07/06			S 3081 PO
50C11 Bus								
with IVECO 1908556 / con IVECO 1908556	8140.43C	78	105	01/99	> 06/01	S 3003 DR	S 4394 NR	S 7356 A
with IVECO 2992300 / con IVECO 2992300	8140.43C	78	105	06/01	> 07/06	S 3003 DR	S 1H2O NR	S 7356 A
prefilter / prefiltro	8140.43C	78	105	01/99	> 07/06		S 1028 B	
power steering / servosterzo	8140.43C	78	105	01/99	> 07/06			S 3081 PO
50C13 Bus								
with IVECO 1908556 / con IVECO 1908556	8140.43S	92	125	01/99	> 06/01	S 3003 DR	S 4394 NR	S 7356 A
with IVECO 2992300 / con IVECO 2992300	8140.43S	92	125	06/01	> 07/06	S 3003 DR	S 1H2O NR	S 7356 A
prefilter / prefiltro	8140.43S	92	125	01/99	> 07/06		S 1028 B	
power steering / servosterzo	8140.43S	92	125	01/99	> 07/06			S 3081 PO
50C15 Bus								
	8140.43N	107	146	06/01	> 07/06	S 3003 DR	S 1H2O NR	S 7356 A



kW HP



...IVECO - buses/autobus

prefilter / prefiltrato	8140.43N	107	146	06/01 >	07/06		S 1028 B		
power steering / servosterzo	8140.43N	107	146	06/01 >	07/06				S 3081 PO
Down-Town									
291E.7.12	8140.43						S 3003 DR	S 8500 NR	S 7356 A
power steering / servosterzo	8140.43								S 3081 PO
EcoDaily									
50C14 Metano/CNG EEV/Euro6	F1CFA401A	100	136	10/15 >			S 5820 R		S 6303 A S 3315 C
50C15 Euro4	F1CE0481FA	107	146	09/09 >	09/11		S 0920 R	S 1071 B	S 7356 A S 3161 C
	F1CE0481FA	107	146	10/11 >	04/14		S 0920 R	S 6034 NE	S 6303 A S 3161 C
	F1CE0481FA	107	146	05/14 >			S 0920 R	S 6034 NE	S 6303 A S 3315 C
with activated carbons / ai carboni attivi	F1CE0481FA	107	146	09/09 >	04/14				S 4348 CA
assembly PURFLUX / montaggio PURFLUX	F1CE0481FA	107	146	09/09 >	09/11			S 6072 NE	
50C15 Euro6	F1CGFL411E	100	136	04/16 >			S 0920 R	S 6080 NE	S 6303 A S 3315 C
50C17 Euro6	F1CGFL411F	125	170	04/16 >			S 0920 R	S 6080 NE	S 6303 A S 3315 C
50C18 Euro4	F1CE0481HA	129	176	09/09 >	09/11		S 0920 R	S 1071 B	S 7356 A S 3161 C
	F1CE0481HA	129	176	10/11 >	04/14		S 0920 R	S 6034 NE	S 6303 A S 3161 C
	F1CE0481HA	129	176	05/14 >			S 0920 R	S 6034 NE	S 6303 A S 3315 C
with activated carbons / ai carboni attivi	F1CE0481HA	129	176	09/09 >	04/14				S 4348 CA
assembly PURFLUX / montaggio PURFLUX	F1CE0481HA	129	176	09/09 >	09/11			S 6072 NE	
70C17 Euro5	F1CGFL411H	125	170	06/14 >			S 0920 R	S 6034 NE	S 6303 A S 3315 C
assembly PURFLUX / montaggio PURFLUX	F1CGFL411H	125	170	06/14 >				S 6072 NE	
70C17 Euro6	F1CGFL411F	125	170	04/16 >			S 0920 R	S 6080 NE	S 6303 A S 3315 C
Eurocargo I									
100.9E15 (RHD)	8060.25R	105	143	04/91 >	09/00				S 7183 A
dryer filter / filtro essiccatore	8060.25R	105	143	04/91 >	09/00				S 7259 A
2 filters / N.2 filtri	8060.25R	105	143	04/91 >	09/00	S 3003 DR	S 8500 NR		
prefilter / prefiltrato	8060.25R	105	143	04/91 >	09/00		S 0999 NR		
power steering / servosterzo	8060.25R	105	143	04/91 >	09/00				S 3081 PO
85E15	8060.25R.4200	105	143	04/91 >	09/01				S 7183 A
dryer filter / filtro essiccatore	8060.25R.4200	105	143	04/91 >	09/01				S 7259 A
2 filters / N.2 filtri	8060.25R.4200	105	143	04/91 >	09/01	S 3003 DR	S 8500 NR		
prefilter / prefiltrato	8060.25R.4200	105	143	04/91 >	09/01		S 0999 NR		
power steering / servosterzo	8060.25R.4200	105	143	04/91 >	09/01				S 3081 PO
85E18	8060.45B, 8060.45B E1	130	177	01/91 >	04/99				S 7183 A
dryer filter / filtro essiccatore	8060.45B, 8060.45B E1	130	177	01/91 >	04/99				S 7259 A
2 filters / N.2 filtri	8060.45B, 8060.45B E1	130	177	01/91 >	04/99	S 3003 DR	S 8500 NR		
prefilter / prefiltrato	8060.45B, 8060.45B E1	130	177	01/91 >	04/99		S 0999 NR		
power steering / servosterzo	8060.45B, 8060.45B E1	130	177	01/91 >	04/99				S 3081 PO
95E18	8060.45B, 8060.45B E1	130	177	01/91 >	04/99				S 7183 A
dryer filter / filtro essiccatore	8060.45B, 8060.45B E1	130	177	01/91 >	04/99				S 7259 A
2 filters / N.2 filtri	8060.45B, 8060.45B E1	130	177	01/91 >	04/99	S 3003 DR	S 8500 NR		
prefilter / prefiltrato	8060.45B, 8060.45B E1	130	177	01/91 >	04/99		S 0999 NR		
power steering / servosterzo	8060.45B, 8060.45B E1	130	177	01/91 >	04/99				S 3081 PO
EuroClass									
380.10.29	8460 TCA			01/92 >				S 0710 NR	S 7546 A S 8410 AR
with automatic gearbox ZF HP500/590 / con cambio automatico ZF HP500/590	8460 TCA			01/92 >					S 2234 Z
2 filters / N.2 filtri	8460 TCA			01/92 >		S 5003 DR			
power steering / servosterzo	8460 TCA			01/92 >					S 8790 PO
380.10.35	8460 TCA							S 0710 NR	S 7546 A S 8410 AR
2 filters / N.2 filtri	8460 TCA					S 5003 DR			
power steering / servosterzo	8460 TCA								S 8790 PO
380.12.29	8460 TCA			01/92 >				S 0710 NR	S 7546 A S 8410 AR
with automatic gearbox ZF HP500/590 / con cambio automatico ZF HP500/590	8460 TCA			01/92 >					S 2234 Z
2 filters / N.2 filtri	8460 TCA			01/92 >		S 5003 DR			
power steering / servosterzo	8460 TCA			01/92 >					S 8790 PO
380.29	8460 TCA			01/92 >				S 0710 NR	S 7546 A S 8410 AR
with automatic gearbox ZF HP500/590 / con cambio automatico ZF HP500/590	8460 TCA			01/92 >					S 2234 Z
2 filters / N.2 filtri	8460 TCA			01/92 >		S 5003 DR			
power steering / servosterzo	8460 TCA			01/92 >					S 8790 PO
380.35	8460 TCA							S 0710 NR	S 7546 A S 8410 AR
2 filters / N.2 filtri	8460 TCA					S 5003 DR			
power steering / servosterzo	8460 TCA								S 8790 PO
389.10.31	Cursor 8	230	313	09/02 >			S 0900 R	S 4396 NR	S 7637 A
with automatic gearbox ZF HP592 / con cambio automatico ZF HP592	Cursor 8	230	313	09/02 >					S 2234 Z
with air-conditioner WEBASTO Aerosphere / con climatizzatore WEBASTO Aerosphere	Cursor 8	230	313	09/02 >					S 3081 C
dryer filter / filtro essiccatore	Cursor 8	230	313	09/02 >					S 7259 A
dryer filter WABCO, right-hand thread / filtro essiccatore WABCO, filetto destro	Cursor 8	230	313	09/02 >					S 7A66 A

**KW HP****...IVECO - buses/autobus**

VGT filter / filtro VGT	Cursor 8	230	313	09/02	>				S 0VGT A
inner / interno	Cursor 8	230	313	09/02	>				
prefilter / prefiltro	Cursor 8	230	313	09/02	>			S 0999 NR	S 7649 A
power steering / servosterzo	Cursor 8	230	313	09/02	>				S 3081 PO
389.10.31	Renault 11 DCI	230	313	09/02	>				S 7637 A
with automatic gearbox ZF HP590 / con cambio automatico ZF HP590	Renault 11 DCI	230	313	09/02	>				S 2234 Z
with air-conditioner WEBASTO Aerosphere / con climatizzatore WEBASTO Aerosphere	Renault 11 DCI	230	313	09/02	>				S 3081 C
dryer filter / filtro essiccatore	Renault 11 DCI	230	313	09/02	>				S 7259 A
dryer filter WABCO, right-hand thread / filtro essiccatore WABCO, filetto destro	Renault 11 DCI	230	313	09/02	>				S 7A66 A
inner / interno	Renault 11 DCI	230	313	09/02	>				S 7649 A
2 filters / N.2 filtri	Renault 11 DCI	230	313	09/02	>	S 0900 R	S 0712 NR		
power steering / servosterzo	Renault 11 DCI	230	313	09/02	>				S 3081 PO
389.10.36	Cursor 8	265	362	09/02	>	S 0900 R	S 4396 NR		S 7637 A
with automatic gearbox ZF HP592 / con cambio automatico ZF HP592	Cursor 8	265	362	09/02	>				S 2234 Z
with air-conditioner WEBASTO Aerosphere / con climatizzatore WEBASTO Aerosphere	Cursor 8	265	362	09/02	>				S 3081 C
dryer filter / filtro essiccatore	Cursor 8	265	362	09/02	>				S 7259 A
dryer filter WABCO, right-hand thread / filtro essiccatore WABCO, filetto destro	Cursor 8	265	362	09/02	>				S 7A66 A
VGT filter / filtro VGT	Cursor 8	265	362	09/02	>				S 0VGT A
inner / interno	Cursor 8	265	362	09/02	>				S 7649 A
prefilter / prefiltro	Cursor 8	265	362	09/02	>			S 0999 NR	
power steering / servosterzo	Cursor 8	265	362	09/02	>				S 3081 PO
389.10.36	Renault 11 DCI	265	362	09/02	>				S 7637 A
with automatic gearbox ZF HP590 / con cambio automatico ZF HP590	Renault 11 DCI	265	362	09/02	>				S 2234 Z
with air-conditioner WEBASTO Aerosphere / con climatizzatore WEBASTO Aerosphere	Renault 11 DCI	265	362	09/02	>				S 3081 C
dryer filter / filtro essiccatore	Renault 11 DCI	265	362	09/02	>				S 7259 A
dryer filter WABCO, filetto destro / filtro essiccatore WABCO, filetto destro	Renault 11 DCI	265	362	09/02	>				S 7A66 A
inner / interno	Renault 11 DCI	265	362	09/02	>				S 7649 A
2 filters / N.2 filtri	Renault 11 DCI	265	362	09/02	>	S 0900 R	S 0712 NR		
power steering / servosterzo	Renault 11 DCI	265	362	09/02	>				S 3081 PO
389.12.31	Cursor 8	230	313	09/02	>	S 0900 R	S 4396 NR		S 7637 A
with automatic gearbox ZF HP592 / con cambio automatico ZF HP592	Cursor 8	230	313	09/02	>				S 2234 Z
with air-conditioner WEBASTO Aerosphere / con climatizzatore WEBASTO Aerosphere	Cursor 8	230	313	09/02	>				S 3081 C
dryer filter / filtro essiccatore	Cursor 8	230	313	09/02	>				S 7259 A
dryer filter WABCO, right-hand thread / filtro essiccatore WABCO, filetto destro	Cursor 8	230	313	09/02	>				S 7A66 A
VGT filter / filtro VGT	Cursor 8	230	313	09/02	>				S 0VGT A
inner / interno	Cursor 8	230	313	09/02	>				S 7649 A
prefilter / prefiltro	Cursor 8	230	313	09/02	>			S 0999 NR	
power steering / servosterzo	Cursor 8	230	313	09/02	>				S 3081 PO
389.12.31	Renault 11 DCI	230	313	09/02	>				S 7637 A
with automatic gearbox ZF HP590 / con cambio automatico ZF HP590	Renault 11 DCI	230	313	09/02	>				S 2234 Z
with air-conditioner WEBASTO Aerosphere / con climatizzatore WEBASTO Aerosphere	Renault 11 DCI	230	313	09/02	>				S 3081 C
dryer filter / filtro essiccatore	Renault 11 DCI	230	313	09/02	>				S 7259 A
dryer filter WABCO, filetto destro / filtro essiccatore WABCO, filetto destro	Renault 11 DCI	230	313	09/02	>				S 7A66 A
inner / interno	Renault 11 DCI	230	313	09/02	>				S 7649 A
2 filters / N.2 filtri	Renault 11 DCI	230	313	09/02	>	S 0900 R	S 0712 NR		
power steering / servosterzo	Renault 11 DCI	230	313	09/02	>				S 3081 PO
389.12.36	Cursor 8	265	362	09/02	>	S 0900 R	S 4396 NR		S 7637 A
with automatic gearbox ZF HP592 / con cambio automatico ZF HP592	Cursor 8	265	362	09/02	>				S 2234 Z
with air-conditioner WEBASTO Aerosphere / con climatizzatore WEBASTO Aerosphere	Cursor 8	265	362	09/02	>				S 3081 C
dryer filter / filtro essiccatore	Cursor 8	265	362	09/02	>				S 7259 A
dryer filter WABCO, right-hand thread / filtro essiccatore WABCO, filetto destro	Cursor 8	265	362	09/02	>				S 7A66 A
VGT filter / filtro VGT	Cursor 8	265	362	09/02	>				S 0VGT A
inner / interno	Cursor 8	265	362	09/02	>				S 7649 A
prefilter / prefiltro	Cursor 8	265	362	09/02	>			S 0999 NR	
power steering / servosterzo	Cursor 8	265	362	09/02	>				S 3081 PO
389.12.36	Renault 11 DCI	265	362	09/02	>				S 7637 A
with automatic gearbox ZF HP590 / con cambio automatico ZF HP590	Renault 11 DCI	265	362	09/02	>				S 2234 Z
with air-conditioner WEBASTO Aerosphere / con climatizzatore WEBASTO Aerosphere	Renault 11 DCI	265	362	09/02	>				S 3081 C
dryer filter / filtro essiccatore	Renault 11 DCI	265	362	09/02	>				S 7259 A
dryer filter WABCO, right-hand thread / filtro essiccatore WABCO, filetto destro	Renault 11 DCI	265	362	09/02	>				S 7A66 A
inner / interno	Renault 11 DCI	265	362	09/02	>				S 7649 A
2 filters / N.2 filtri	Renault 11 DCI	265	362	09/02	>	S 0900 R	S 0712 NR		
power steering / servosterzo	Renault 11 DCI	265	362	09/02	>				S 3081 PO
389.12.43	Renault 11 DCI	316	431	09/02	>				S 7637 A
with automatic gearbox ZF HP590 / con cambio automatico ZF HP590	Renault 11 DCI	316	431	09/02	>				S 2234 Z
with air-conditioner WEBASTO Aerosphere / con climatizzatore WEBASTO Aerosphere	Renault 11 DCI	316	431	09/02	>				S 3081 C
dryer filter / filtro essiccatore	Renault 11 DCI	316	431	09/02	>				S 7259 A



kW HP



...IVECO - buses/autobus

dryer filter WABCO, right-hand thread / filtro essiccatore WABCO, filetto destro	Renault 11 DCI	316	431	09/02	>				S 7A66 A
inner / interno	Renault 11 DCI	316	431	09/02	>			S 7649 A	
2 filters / N.2 filtri	Renault 11 DCI	316	431	09/02	>	S 0900 R	S 0712 NR		
power steering / servosterzo	Renault 11 DCI	316	431	09/02	>				S 3081 PO
Europolis									
200E.10.20	8360.46V								S 8410 AR
2 filters / N.2 filtri	8360.46V					S 5003 DR	S 4329 NR		
200E.10.20	8360SRC22								S 8410 AR
2 filters / N.2 filtri	8360SRC22					S 5003 DR	S 4329 NR		
EuroRider									
397E.12.35	F2BE0682A	259	352	09/02	>	S 3288 R	S 4396 NR	S 7637 A	
some BLOW-BY filter (504153481) / alcuni filtro BLOW-BY (504153481)	F2BE0682A	259	352	09/02	>				S 7266 A
with automatic gearbox ZF HP592 / con cambio automatico ZF HP592	F2BE0682A	259	352	09/02	>				S 2234 Z
with air-conditioner WEBASTO Aerosphere / con climatizzatore WEBASTO Aerosphere	F2BE0682A	259	352	09/02	>				S 3081 C
dryer filter / filtro essiccatore	F2BE0682A	259	352	09/02	>				S 7259 A
dryer filter WABCO, right-hand thread / filtro essiccatore WABCO, filetto destro	F2BE0682A	259	352	09/02	>				S 7A66 A
VGT filter / filtro VGT	F2BE0682A	259	352	09/02	>				S 0VGT A
inner / interno	F2BE0682A	259	352	09/02	>			S 7649 A	
prefilter / prefiltra	F2BE0682A	259	352	09/02	>		S 0999 NR		
power steering / servosterzo	F2BE0682A	259	352	09/02	>				S 3081 PO
397E.12.43	F3AE0681D	316	430	09/02	>		S 4395 NR		
some BLOW-BY filter (504153481) / alcuni filtro BLOW-BY (504153481)	F3AE0681D	316	430	09/02	>				S 7266 A
dryer filter / filtro essiccatore	F3AE0681D	316	430	09/02	>				S 7259 A
VGT filter / filtro VGT	F3AE0681D	316	430	09/02	>				S 0VGT A
2 filters / N.2 filtri	F3AE0681D	316	430	09/02	>	S 3288 R			
prefilter / prefiltra	F3AE0681D	316	430	09/02	>		S 0999 NR		
power steering / servosterzo	F3AE0681D	316	430	09/02	>				S 3081 PO
I Effeuno Turbo									
I Effeuno Turbo						S 7600 R	S 0710 NR	S 0450 A	S 8410 AR
with automatic gearbox ZF HP500/590 / con cambio automatico ZF HP500/590									S 2234 Z
Leoncino									
A15						S 9710 R	S 7200 N		
Lupetto									
A15						S 9710 R	S 7200 N		
M2000 Serie									
M2000R106	KHD					S 8600 R	S 5400 NR	S 2450 A	
M2000R113	KHD					S 8600 R	S 5400 NR	S 2450 A	
M2000R119	KHD					S 8600 R	S 5400 NR	S 2450 A	
Magelys									
12.2 m	Cursor 9 Euro 6	294	400	09/13	>	S 5102 PE	S 6043 NE		
spheros aeroshere world SPHEROS / con climatizzatore sul tetto SPHEROS	Cursor 9 Euro 6	294	400	09/13	>				S 3457 C
power steering / servosterzo	Cursor 9 Euro 6	294	400	09/13	>				S 3081 PO
12.8 m	Cursor 9 Euro 6			09/13	>	S 5102 PE	S 6043 NE		
power steering / servosterzo	Cursor 9 Euro 6			09/13	>				S 3081 PO
MyWay									
393.12.29	8460.41R/8460.41R E2	213	290	01/99	> 12/01			S 7546 A	S 8410 AR
some / alcuni	8460.41R/8460.41R E2	213	290	01/99	> 12/01			S 7546 A	
dryer filter / filtro essiccatore	8460.41R/8460.41R E2	213	290	01/99	> 12/01				S 7259 A
2 filters / N.2 filtri	8460.41R/8460.41R E2	213	290	01/99	> 12/01	S 5003 DR	S 5401 NR		
or / oppure	8460.41R/8460.41R E2	213	290	01/99	> 12/01	S 5003 DR	S 5400 NR		S 8410 AR
prefilter / prefiltra	8460.41R/8460.41R E2	213	290	01/99	> 12/01		S 0999 NR		
power steering / servosterzo	8460.41R/8460.41R E2	213	290	01/99	> 12/01				S 3081 PO
393.12.35	8460.41S/8460.41S E2	254	346	01/99	> 12/01			S 7546 A	S 8410 AR
some / alcuni	8460.41S/8460.41S E2	254	346	01/99	> 12/01			S 7546 A	
dryer filter / filtro essiccatore	8460.41S/8460.41S E2	254	346	01/99	> 12/01				S 7259 A
2 filters / N.2 filtri	8460.41S/8460.41S E2	254	346	01/99	> 12/01	S 5003 DR	S 5401 NR		
or / oppure	8460.41S/8460.41S E2	254	346	01/99	> 12/01	S 5003 DR	S 5400 NR		S 8410 AR
prefilter / prefiltra	8460.41S/8460.41S E2	254	346	01/99	> 12/01		S 0999 NR		
power steering / servosterzo	8460.41S/8460.41S E2	254	346	01/99	> 12/01				S 3081 PO
Saturn II									
Saturn II	KHD F6L714						S 1411 N		
Tigrotto									
A15						S 9710 R	S 7200 N		
Turbo City S									
Turbo City S						S 5003 DR	S 0710 NR	S 0450 A	S 8410 AR
with automatic gearbox ZF HP500/590 / con cambio automatico ZF HP500/590									S 2234 Z
Turbo City U									





kW HP



...IVECO - buses/autobus

Turbo City U with automatic gearbox ZF HP500/590 / con cambio automatico ZF HP500/590				S 5003 DR	S 0710 NR	S 0450 A	S 8410 AR S 2234 Z
Turbocity							
480	8460.21		04/88 > 12/92		S 0710 NR	S 0450 A	S 8410 AR S 2234 Z
with automatic gearbox ZF 4HP500 / con cambio automatico ZF 4HP500	8460.21		04/88 > 12/92				
2 filters / N.2 filtri	8460.21		04/88 > 12/92	S 5003 DR			
power steering / servosterzo	8460.21		04/88 > 12/92				S 8790 PO
480	8460.21B		04/88 > 12/92		S 0710 NR	S 0450 A	S 8410 AR S 2234 Z
with automatic gearbox ZF 4HP500 / con cambio automatico ZF 4HP500	8460.21B		04/88 > 12/92				
2 filters / N.2 filtri	8460.21B		04/88 > 12/92	S 5003 DR			
power steering / servosterzo	8460.21B		04/88 > 12/92				S 8790 PO
480 RHD	8460.41D		04/88 > 12/92		S 0710 NR	S 0450 A	S 8410 AR S 2234 Z
with automatic gearbox ZF 5HP590 / con cambio automatico ZF 5HP590	8460.41D		04/88 > 12/92				
2 filters / N.2 filtri	8460.41D		04/88 > 12/92	S 5003 DR			
power steering / servosterzo	8460.41D		04/88 > 12/92				S 8790 PO
680	8460.21				S 0710 NR	S 0450 A	S 8410 AR S 2234 Z
with automatic gearbox ZF 5HP500 / con cambio automatico ZF 5HP500	8460.21						
2 filters / N.2 filtri	8460.21			S 5003 DR			
power steering / servosterzo	8460.21						S 8790 PO

U Effeuno Turbo

U Effeuno Turbo with automatic gearbox ZF HP500/590 / con cambio automatico ZF HP500/590				S 7600 R	S 0710 NR		S 8410 AR S 2234 Z
--	--	--	--	----------	-----------	--	-----------------------

Urbanway

12 m	Cursor 9 Euro 6	228 310	09/13 >	S 5102 PE	S 6043 NE		S 3457 C
spheros aeroshere world SPHEROS / con climatizzatore sul tetto SPHEROS	Cursor 9 Euro 6	228 310	09/13 >		S 4474 NR		
prefilter / prefiltro	Cursor 9 Euro 6	228 310	09/13 >				S 3081 PO
power steering / servosterzo	Cursor 9 Euro 6	228 310	09/13 >				
12 m	Cursor 9 Euro 6	265 360	09/13 >	S 5102 PE	S 6043 NE		S 3457 C
spheros aeroshere world SPHEROS / con climatizzatore sul tetto SPHEROS	Cursor 9 Euro 6	265 360	05/13 >		S 4474 NR		
prefilter / prefiltro	Cursor 9 Euro 6	265 360	09/13 >				S 3081 PO
power steering / servosterzo	Cursor 9 Euro 6	265 360	09/13 >				
12 m	Cursor 9 Euro 6	294 400	09/13 >	S 5102 PE	S 6043 NE		S 3457 C
spheros aeroshere world SPHEROS / con climatizzatore sul tetto SPHEROS	Cursor 9 Euro 6	294 400	09/13 >		S 4474 NR		
prefilter / prefiltro	Cursor 9 Euro 6	294 400	09/13 >				S 3081 PO
power steering / servosterzo	Cursor 9 Euro 6	294 400	09/13 >				
18 m	Cursor 9 Euro 6	265 360	09/13 >	S 5102 PE	S 6043 NE		S 3457 C
spheros aeroshere world SPHEROS / con climatizzatore sul tetto SPHEROS	Cursor 9 Euro 6	265 360	09/13 >		S 4474 NR		
prefilter / prefiltro	Cursor 9 Euro 6	265 360	09/13 >				S 3081 PO
power steering / servosterzo	Cursor 9 Euro 6	265 360	09/13 >				
18 m	Cursor 9 Euro 6	294 400	09/13 >	S 5102 PE	S 6043 NE		S 3457 C
spheros aeroshere world SPHEROS / con climatizzatore sul tetto SPHEROS	Cursor 9 Euro 6	294 400	09/13 >		S 4474 NR		
prefilter / prefiltro	Cursor 9 Euro 6	294 400	09/13 >				S 3081 PO
power steering / servosterzo	Cursor 9 Euro 6	294 400	09/13 >				

JONCKHEERE (VDL GROUP)

buses/autobus

JSD

70	DAF MX340S Euro5	340 462	09/06 >	S 5081 PE	S 6024 NE		S 4401 U
with filter Urea/Adblue / con filtro Urea/Adblue	DAF MX340S Euro5	340 462	09/06 >		S 4143 NR		
prefilter RACOR 490R / prefiltro RACOR 490R	DAF MX340S Euro5	340 462	02/06 >				
rotor for oil centrifuge / rotore per filtro olio centrifugo	DAF MX340S Euro5	340 462	09/06 >	S 5904 PO			
power steering / servosterzo	DAF MX340S Euro5	340 462	09/06 >				S 3081 PO

SHD

122	DAF MX300S	300 410	09/06 >	S 5081 PE	S 6024 NE		S 3081 PO
power steering / servosterzo	DAF MX300S	300 410	09/06 >				
122	DAF MX340S	340 462	09/06 >	S 5081 PE	S 6024 NE		S 3081 PO
power steering / servosterzo	DAF MX340S	340 462	09/06 >				
122	DAF XE280C1	280 381	02/06 >	S 5234 PE	S 6146 NE	S 7641 A S 0768 A	
inner / interno	DAF XE280C1	280 381	02/06 >		S 4143 NR		
prefilter RACOR 490R / prefiltro RACOR 490R	DAF XE280C1	280 381	02/06 >				
rotor for oil centrifuge / rotore per filtro olio centrifugo	DAF XE280C1	280 381	02/06 >	S 5902 PO			
power steering / servosterzo	DAF XE280C1	280 381	02/06 >				S 3081 PO
122	DAF XE315C	315 428	02/06 >	S 5234 PE	S 6146 NE	S 7641 A S 0768 A	
inner / interno	DAF XE315C	315 428	02/06 >		S 4143 NR		
prefilter RACOR 490R / prefiltro RACOR 490R	DAF XE315C	315 428	02/06 >				
rotor for oil centrifuge / rotore per filtro olio centrifugo	DAF XE315C	315 428	02/06 >	S 5902 PO			
power steering / servosterzo	DAF XE315C	315 428	02/06 >				S 3081 PO
134	DAF MX300S	300 410	09/06 >	S 5081 PE	S 6024 NE		



kW HP



...JONCKHEERE (VDL GROUP) - buses/autobus

power steering / servosterzo	DAF MX300S	300	410	09/06	>				S 3081 PO
134	DAF MX340S	340	462	09/06	>	S 5081 PE	S 6024 NE		
power steering / servosterzo	DAF MX340S	340	462	09/06	>				S 3081 PO
134	DAF XE355C	355	483	02/06	>	S 5234 PE	S 6146 NE	S 7641 A	
inner / interno	DAF XE355C	355	483	02/06	>			S 0768 A	
prefilter RACOR 490R / prefiltro RACOR 490R	DAF XE355C	355	483	02/06	>		S 4143 NR		
rotor for oil centrifuge / rotore per filtro olio centrifugo	DAF XE355C	355	483	02/06	>	S 5902 PO			
power steering / servosterzo	DAF XE355C	355	483	02/06	>				S 3081 PO
140	DAF MX300S	300	410	09/06	>	S 5081 PE	S 6024 NE		
power steering / servosterzo	DAF MX300S	300	410	09/06	>				S 3081 PO
140	DAF MX340S Euro5	340	462	09/06	>	S 5081 PE	S 6024 NE		
with filter Urea/Adblue / con filtro Urea/Adblue	DAF MX340S Euro5	340	462	09/06	>				S 4401 U
prefilter RACOR 490R / prefiltro RACOR 490R	DAF MX340S Euro5	340	462	09/06	>		S 4143 NR		
rotor for oil centrifuge / rotore per filtro olio centrifugo	DAF MX340S Euro5	340	462	09/06	>	S 5904 PO			
power steering / servosterzo	DAF MX340S Euro5	340	462	09/06	>				S 3081 PO
140	DAF XE355C	355	483	02/06	>	S 5234 PE	S 6146 NE	S 7641 A	
inner / interno	DAF XE355C	355	483	02/06	>			S 0768 A	
prefilter RACOR 490R / prefiltro RACOR 490R	DAF XE355C	355	483	02/06	>		S 4143 NR		
rotor for oil centrifuge / rotore per filtro olio centrifugo	DAF XE355C	355	483	02/06	>	S 5902 PO			
power steering / servosterzo	DAF XE355C	355	483	02/06	>				S 3081 PO
70	DAF MX340S Euro5	340	462	09/06	>	S 5081 PE	S 6024 NE		
with filter Urea/Adblue / con filtro Urea/Adblue	DAF MX340S Euro5	340	462	09/06	>				S 4401 U
prefilter RACOR 490R / prefiltro RACOR 490R	DAF MX340S Euro5	340	462	02/06	>		S 4143 NR		
rotor for oil centrifuge / rotore per filtro olio centrifugo	DAF MX340S Euro5	340	462	09/06	>	S 5904 PO			
power steering / servosterzo	DAF MX340S Euro5	340	462	09/06	>				S 3081 PO

KAELEBLE

special trucks/autocarri speciali

K Serie

20							S 0201 N		
2nd passage / 2.passaggio							S 1411 N		
power steering / servosterzo									S 8790 PO
20B	Mercedes Benz OM355					S 0300 O	S 0201 N	S 0940 A	
2nd passage / 2.passaggio	Mercedes Benz OM355						S 1411 N		
410							S 1411 N		
paper / in carta							S 1411 N		
415K							S 1411 N		
paper / in carta							S 1411 N		
415Z							S 1411 N		
paper / in carta							S 1411 N		
610							S 1411 N		
paper / in carta							S 1411 N		
612							S 1411 N		
paper / in carta							S 1411 N		
631K							S 0201 N		
2nd passage / 2.passaggio							S 1411 N		
paper / in carta							S 0201 N		
631L							S 0201 N		
2nd passage / 2.passaggio							S 1411 N		
paper / in carta							S 0201 N		
631Z							S 0201 N		
2nd passage / 2.passaggio							S 1411 N		
paper / in carta							S 0201 N		
635K						S 0530 PO	S 1411 N		
645L						S 0530 PO	S 1411 N		
645LF						S 0530 PO	S 1411 N		
645SF						S 0530 PO	S 1411 N		
645Z						S 0530 PO	S 1411 N		
650K									
1st passage / 1.passaggio							S 0201 N		
2nd passage / 2.passaggio							S 1411 N		
650LF									
1st passage / 1.passaggio							S 0201 N		
2nd passage / 2.passaggio							S 1411 N		
652LF									
1st passage / 1.passaggio							S 0201 N		
2nd passage / 2.passaggio							S 1411 N		
680					> 12/66		S 1411 N		

K





kW HP



...KAELBLE - special trucks/autocarri speciali

K



paper / in carta		> 12/66		S 1411 N		
680K		> 12/66		S 1411 N		
paper / in carta		> 12/66		S 1411 N		
680L		> 12/66		S 1411 N		
paper / in carta		> 12/66		S 1411 N		
680Z		> 12/66		S 1411 N		
paper / in carta		> 12/66		S 1411 N		
KDV Serie						
22E6T				S 0201 N		
1st passage / 1.passaggio				S 1411 N		
2nd passage / 2.passaggio						
power steering / servosterzo						S 8790 PO
24				S 0201 N		
1st passage / 1.passaggio				S 1411 N		
2nd passage / 2.passaggio						
power steering / servosterzo						S 8790 PO
400			S 0300 O	S 0201 N		
2nd passage / 2.passaggio				S 1411 N		
power steering / servosterzo						S 8790 PO
680		> 12/66		S 1411 N		
paper / in carta		> 12/66		S 1411 N		
832K				S 0201 N		
1st passage / 1.passaggio				S 1411 N		
2nd passage / 2.passaggio						
KDVW 400			S 0300 O	S 0201 N		
2nd passage / 2.passaggio				S 1411 N		
power steering / servosterzo						S 8790 PO
KK Serie						
25	MAN D 2566 MTE		S 7260 PO	S 0201 N	S 0450 A	
2nd passage / 2.passaggio	MAN D 2566 MTE			S 1411 N		
inner / interno	MAN D 2566 MTE				S 1450 A	
35	MAN D 2566 MTE		S 7260 PO	S 0201 N	S 0450 A	
2nd passage / 2.passaggio	MAN D 2566 MTE			S 1411 N		
inner / interno	MAN D 2566 MTE				S 1450 A	
50	Mercedes Benz OM404		S 7261 PO	S 0201 N	S 2650 A	
2nd passage / 2.passaggio	Mercedes Benz OM404			S 1411 N		
inner / interno	Mercedes Benz OM404		S 7261 PO	S 1411 N	S 7129 A	
50	Mercedes Benz OM404A		S 7261 PO	S 0201 N	S 0450 A	
2nd passage / 2.passaggio	Mercedes Benz OM404A			S 1411 N		
inner / interno	Mercedes Benz OM404A				S 1450 A	
KV Serie						
18 N			S 8600 R	S 6710 NR	S 2450 A	
inner / interno					S 3940 A	
20					S 0940 A	
21E6				S 0201 N		
1st passage / 1.passaggio				S 1411 N		
2nd passage / 2.passaggio						
power steering / servosterzo						S 8790 PO
21E6T				S 0201 N		
1st passage / 1.passaggio				S 1411 N		
2nd passage / 2.passaggio						
power steering / servosterzo						S 8790 PO
21E8				S 0201 N		
1st passage / 1.passaggio				S 1411 N		
2nd passage / 2.passaggio						
22E6T				S 0201 N		
1st passage / 1.passaggio				S 1411 N		
2nd passage / 2.passaggio						
power steering / servosterzo						S 8790 PO
24E6T				S 0201 N		
1st passage / 1.passaggio				S 1411 N		
2nd passage / 2.passaggio						
power steering / servosterzo						S 8790 PO
24E8				S 0201 N		
1st passage / 1.passaggio				S 1411 N		
2nd passage / 2.passaggio						
25B	Mercedes Benz OM403		S 7261 PO	S 0101 N	S 6550 A	

**KW HP**

...KAELBLE - special trucks/autocarri speciali

2nd passage / 2.passaggio inner / interno	Mercedes Benz OM403 Mercedes Benz OM403			S 7411 N	S 2840 A	
25B 2nd passage / 2.passaggio inner / interno	Mercedes Benz OM403.905 Mercedes Benz OM403.905			S 0101 N S 7411 N	S 6550 A	
25N 2nd passage / 2.passaggio inner / interno	KHD F10L413FW KHD F10L413FW KHD F10L413FW		S 8600 R	S 0201 N S 1411 N	S 2840 A S 2650 A	
27 1st passage / 1.passaggio 2nd passage / 2.passaggio power steering / servosterzo				S 0201 N S 1411 N		S 8790 PO
33 inner / interno power steering / servosterzo	Mercedes Benz OM423 Mercedes Benz OM423 Mercedes Benz OM423		S 7261 PO	S 2162 N	S 0450 A S 1450 A	S 8790 PO
34 2nd passage / 2.passaggio power steering / servosterzo			S 0300 O	S 0201 N S 1411 N		S 8790 PO
631 2nd passage / 2.passaggio power steering / servosterzo			S 0300 O	S 0201 N S 1411 N		S 8790 PO
632 2nd passage / 2.passaggio power steering / servosterzo			S 0300 O	S 0201 N S 1411 N		S 8790 PO
632ZB 1st passage / 1.passaggio 2nd passage / 2.passaggio				S 0201 N S 1411 N		
650K 2nd passage / 2.passaggio			S 4000 O	S 0201 N S 1411 N		
650LF 2nd passage / 2.passaggio			S 4000 O	S 0201 N S 1411 N		
650V 1st passage / 1.passaggio 2nd passage / 2.passaggio				S 0201 N S 1411 N		
KVD Serie						
22E8 1st passage / 1.passaggio 2nd passage / 2.passaggio				S 0201 N S 1411 N		
24E8 1st passage / 1.passaggio 2nd passage / 2.passaggio				S 0201 N S 1411 N		
32 2nd passage / 2.passaggio power steering / servosterzo			S 0300 O	S 0201 N S 1411 N		S 8790 PO
631 832E 1st passage / 1.passaggio 2nd passage / 2.passaggio				S 1411 N S 0201 N S 1411 N		
833E 1st passage / 1.passaggio 2nd passage / 2.passaggio				S 0201 N S 1411 N		
835E 1st passage / 1.passaggio 2nd passage / 2.passaggio				S 0201 N S 1411 N		
836 1st passage / 1.passaggio 2nd passage / 2.passaggio power steering / servosterzo				S 0201 N S 1411 N		S 8790 PO
836E 1st passage / 1.passaggio 2nd passage / 2.passaggio				S 0201 N S 1411 N		
KVW Serie						
20N 2nd passage / 2.passaggio inner / interno	KHD F10L413FW KHD F10L413FW KHD F10L413FW		S 8600 R	S 0201 N S 1411 N	S 2650 A	S 7129 A
27 2nd passage / 2.passaggio	Mercedes Benz OM403 Mercedes Benz OM403		S 7261 PO	S 0101 N S 7411 N		





KW HP



...KAELBLE - special trucks/autocarri speciali

K

34 2nd passage / 2.passaggio power steering / servosterzo			S 0300 O	S 0201 N S 1411 N		S 8790 PO
35			S 2530 PO		S 0940 A	

SK Serie

16 BD 2nd passage / 2.passaggio inner / interno	KHD F8L714 KHD F8L714 KHD F8L714			S 0201 N S 1411 N	S 2450 A S 3940 A	
--	--	--	--	----------------------	----------------------	--

KAESSBOHRER

buses/autobus

S 10 Serie

S 10 2nd passage / 2.passaggio			S 0530 PO	S 0201 N S 1411 N		
S 103 S	Mercedes Benz OM407H	03/77 > 12/80	S 7261 PO	S 2162 N	S 2650 A	
S 11 2nd passage / 2.passaggio			S 0530 PO	S 0201 N S 1411 N		
S 12 2nd passage / 2.passaggio			S 0530 PO	S 0201 N S 1411 N		
S 14 2nd passage / 2.passaggio			S 0530 PO	S 0201 N S 1411 N		

S 100 Serie

S 100 some / alcuni power steering / servosterzo	Henschel 6R1112-16K Henschel 6R1112-16K Henschel 6R1112-16K	07/67 > 03/70 07/67 > 03/70 07/67 > 03/70	S 8600 R S 8600 R	S 5400 NR S 5400 NR	S 7839 A S 0060 A	S 8790 PO
S 100 A some / alcuni power steering / servosterzo	Henschel 6R1112-16K Henschel 6R1112-16K Henschel 6R1112-16K	07/67 > 03/70 07/67 > 03/70 07/67 > 03/70	S 8600 R S 8600 R	S 5400 NR S 5400 NR	S 7839 A S 0060 A	S 8790 PO
S 110 some / alcuni power steering / servosterzo	Henschel 562-6R1112-18K Henschel 562-6R1112-18K Henschel 562-6R1112-18K	04/70 > 12/73 04/70 > 12/73 04/70 > 12/73	S 8600 R S 8600 R	S 5400 NR S 5400 NR	S 7839 A S 0060 A	S 8790 PO
S 110 A some / alcuni power steering / servosterzo	Henschel 562-6R1112-18K Henschel 562-6R1112-18K Henschel 562-6R1112-18K	04/70 > 12/73 04/70 > 12/73 04/70 > 12/73	S 8600 R S 8600 R	S 5400 NR S 5400 NR	S 7839 A S 0060 A	S 8790 PO
S 110 P some / alcuni power steering / servosterzo	Henschel 562-6R1112-18K Henschel 562-6R1112-18K Henschel 562-6R1112-18K	04/70 > 12/73 04/70 > 12/73 04/70 > 12/73	S 8600 R S 8600 R	S 5400 NR S 5400 NR	S 7839 A S 0060 A	S 8790 PO
S 120 some / alcuni	Henschel (561/562) Henschel (561/562)		S 8600 R	S 5400 NR	S 7839 A	S 8790 PO
S 120 some / alcuni power steering / servosterzo	Henschel 524-6R1315-20K Henschel 524-6R1315-20K Henschel 524-6R1315-20K	04/70 > 12/73 04/70 > 12/73 04/70 > 12/73	S 8600 R S 8600 R	S 5400 NR S 5400 NR	S 0940 A S 5270 A	S 8790 PO
S 120 some / alcuni power steering / servosterzo	Henschel 6R1113-18K Henschel 6R1113-18K Henschel 6R1113-18K	10/67 > 05/69 10/67 > 05/69 10/67 > 05/69	S 8600 R S 8600 R	S 5400 NR S 5400 NR	S 7839 A S 0060 A	S 8790 PO
S 120 2nd passage / 2.passaggio power steering / servosterzo	MAN D2566 MAN D2566 MAN D2566		S 7260 PO	S 0101 N S 7411 N	S 2650 A	S 8790 PO
S 120 A some / alcuni power steering / servosterzo	Henschel 524-6R1315-20K Henschel 524-6R1315-20K Henschel 524-6R1315-20K	04/70 > 12/73 04/70 > 12/73 04/70 > 12/73	S 8600 R S 8600 R	S 5400 NR S 5400 NR	S 5270 A S 0940 A	S 8790 PO
S 120 E some / alcuni power steering / servosterzo	Henschel 6R1113-18K Henschel 6R1113-18K Henschel 6R1113-18K	10/67 > 05/69 10/67 > 05/69 10/67 > 05/69	S 8600 R S 8600 R	S 5400 NR S 5400 NR	S 7839 A S 0060 A	S 8790 PO
S 120 P some / alcuni power steering / servosterzo	Henschel 6R1113-18K Henschel 6R1113-18K Henschel 6R1113-18K	10/67 > 05/69 10/67 > 05/69 10/67 > 05/69	S 8600 R S 8600 R	S 5400 NR S 5400 NR	S 7839 A S 0060 A	S 8790 PO
S 130 some / alcuni			S 8600 R S 8600 R	S 5400 NR S 5400 NR	S 0060 A S 7839 A	
S 130 some / alcuni	Henschel (561/562) Henschel (561/562)		S 8600 R S 8600 R	S 5400 NR S 5400 NR	S 7839 A S 0060 A	
S 130 some / alcuni power steering / servosterzo	Henschel 6R1315 Henschel 6R1315 Henschel 6R1315	04/70 > 12/73 04/70 > 12/73 04/70 > 12/73	S 8600 R S 8600 R	S 5400 NR S 5400 NR	S 0940 A S 5270 A	S 8790 PO
S 130 2nd passage / 2.passaggio power steering / servosterzo	MAN D2566 MAN D2566 MAN D2566		S 7260 PO	S 0101 N S 7411 N	S 2650 A	S 8790 PO
S 130 E			S 8600 R	S 5400 NR	S 0060 A	



KW HP



...KAESSBOHRER - buses/autobus

some / alcuni			S 8600 R	S 5400 NR	S 7839 A	
S 130 P			S 8600 R	S 5400 NR	S 0060 A	
some / alcuni			S 8600 R	S 5400 NR	S 7839 A	
S 140	Henschel	01/77 > 12/84	S 8600 R	S 5400 NR	S 2650 A	
some / alcuni	Henschel	01/77 > 12/84	S 8600 R	S 5400 NR	S 5270 A	
power steering / servosterzo	Henschel	01/77 > 12/84				S 8790 PO
S 140	MAN D2566	09/77 > 12/84	S 7260 PO	S 0101 N	S 2650 A	
2nd passage / 2.passaggio	MAN D2566	09/77 > 12/84		S 7411 N		
power steering / servosterzo	MAN D2566	09/77 > 12/84				S 8790 PO
S 140	MAN D2566 MUH	09/77 > 12/84	S 7260 PO	S 0101 N	S 2650 A	
2nd passage / 2.passaggio	MAN D2566 MUH	09/77 > 12/84		S 7411 N		
power steering / servosterzo	MAN D2566 MUH	09/77 > 12/84				S 8790 PO
S 140 ES	Henschel	01/77 > 12/84	S 8600 R	S 5400 NR	S 2650 A	
some / alcuni	Henschel	01/77 > 12/84	S 8600 R	S 5400 NR	S 5270 A	
power steering / servosterzo	Henschel	01/77 > 12/84				S 8790 PO
S 140 ES	MAN D2566	09/77 > 12/84	S 7260 PO	S 0101 N	S 2650 A	
2nd passage / 2.passaggio	MAN D2566	09/77 > 12/84		S 7411 N		
power steering / servosterzo	MAN D2566	09/77 > 12/84				S 8790 PO
S 140 ES	MAN D2566 MUH	09/77 > 12/84	S 7260 PO	S 0101 N	S 2650 A	
2nd passage / 2.passaggio	MAN D2566 MUH	09/77 > 12/84		S 7411 N		
power steering / servosterzo	MAN D2566 MUH	09/77 > 12/84				S 8790 PO
S 150			S 8600 R	S 5400 NR	S 0060 A	
some / alcuni			S 8600 R	S 5400 NR	S 7839 A	
S 150	Henschel (561/562)		S 8600 R	S 5400 NR	S 7839 A	
some / alcuni	Henschel (561/562)		S 8600 R	S 5400 NR	S 0060 A	
S 150	Henschel 6R1315	04/70 > 12/73	S 8600 R	S 5400 NR	S 0940 A	
some / alcuni	Henschel 6R1315	04/70 > 12/73	S 8600 R	S 5400 NR	S 5270 A	
power steering / servosterzo	Henschel 6R1315	04/70 > 12/73				S 8790 PO
S 150	MAN D2566		S 7260 PO	S 0101 N	S 2650 A	
2nd passage / 2.passaggio	MAN D2566			S 7411 N		
power steering / servosterzo	MAN D2566					S 8790 PO
S 150 E			S 8600 R	S 5400 NR	S 0060 A	
some / alcuni			S 8600 R	S 5400 NR	S 7839 A	
S 150 P			S 8600 R	S 5400 NR	S 0060 A	
some / alcuni			S 8600 R	S 5400 NR	S 7839 A	
S 200 Serie						
S 200	Mercedes Benz OM403	08/76 > 12/81	S 7261 PO	S 0201 N	S 0450 A	
2nd passage / 2.passaggio	Mercedes Benz OM403	08/76 > 12/81		S 1411 N		
power steering / servosterzo	Mercedes Benz OM403	08/76 > 12/81				S 8790 PO
S 208	Mercedes Benz OM352.90	09/79 > 10/83	S 2530 PO	S 2161 N	S 2450 A	
S 208	Mercedes Benz OM352A	09/79 > 10/83	S 2530 PO	S 2161 N	S 2450 A	
S 208	Mercedes Benz OM401	08/76 > 01/80	S 8260 PO	S 0101 N	S 2450 A	
2nd passage / 2.passaggio	Mercedes Benz OM401	08/76 > 01/80		S 7411 N		
S 208 H	Mercedes Benz OM352.90	09/79 > 10/83	S 2530 PO	S 2161 N	S 2450 A	
S 208 H	Mercedes Benz OM352A	09/79 > 10/83	S 2530 PO	S 2161 N	S 2450 A	
S 209	Mercedes Benz OM401	08/76 > 01/80	S 8260 PO	S 0101 N	S 2450 A	
2nd passage / 2.passaggio	Mercedes Benz OM401	08/76 > 01/80		S 7411 N		
S 209	Mercedes Benz OM421	01/80 > 10/83	S 8260 PO	S 2161 N	S 2650 A	
some / alcuni	Mercedes Benz OM421	01/80 > 10/83	S 8260 PO	S 2162 N	S 2650 A	
S 209 H	Mercedes Benz OM421	01/80 > 10/83	S 8260 PO	S 2161 N	S 2650 A	
some / alcuni	Mercedes Benz OM421	01/80 > 10/83	S 8260 PO	S 2162 N	S 2650 A	
S 210						
to engine No. 019113 / a motore N. 019113	Mercedes Benz OM421	10/83 >	S 8260 PO	S 2162 N	S 2650 A	
some / alcuni	Mercedes Benz OM421	10/83 > 06/96	S 8260 PO	S 2161 N	S 2650 A	
from engine No. 019114 / da motore N. 019114	Mercedes Benz OM421	> 06/96	S 7261 PO	S 2162 N	S 2650 A	
S 210	Mercedes Benz OM421A	09/85 > 06/96	S 7261 PO	S 2162 N	S 2650 A	
some / alcuni	Mercedes Benz OM421A	09/85 > 06/96	S 7261 PO	S 2162 N	S 0450 A	
S 210	Mercedes Benz OM441A	03/89 > 06/96	S 5124 PE	S 2161 N	S 0450 A	
power steering / servosterzo	Mercedes Benz OM441A	03/89 > 06/96				S 3081 PO
S 210 H						
to engine No. 019113 / a motore N. 019113	Mercedes Benz OM421	10/83 >	S 8260 PO	S 2162 N	S 2650 A	
some / alcuni	Mercedes Benz OM421	03/89 > 06/96	S 8260 PO	S 2161 N	S 2650 A	
from engine No. 019114 / da motore N. 019114	Mercedes Benz OM421	> 06/96	S 7261 PO	S 2162 N	S 2650 A	
S 210 H	Mercedes Benz OM421A	09/85 > 06/96	S 7261 PO	S 2162 N	S 2650 A	
some / alcuni	Mercedes Benz OM421A	09/85 > 06/96	S 7261 PO	S 2162 N	S 0450 A	
S 210 H	Mercedes Benz OM441A	03/89 > 06/96	S 5124 PE	S 2161 N	S 0450 A	
power steering / servosterzo	Mercedes Benz OM441A	03/89 > 06/96				S 3081 PO

K



**KW HP****...KAESSBOHRER - buses/autobus****K**

S 211 2nd passage / 2.passaggio	Mercedes Benz OM401 Mercedes Benz OM401	08/76 > 01/80 08/76 > 01/80	S 8260 PO S 7411 N	S 0101 N S 2450 A	
S 211 some / alcuni	Mercedes Benz OM421 Mercedes Benz OM421	01/80 > 10/83 01/80 > 10/83	S 8260 PO S 8260 PO	S 2161 N S 2162 N	S 2650 A S 2650 A
S 211 H 2nd passage / 2.passaggio	Mercedes Benz OM401 Mercedes Benz OM401	08/76 > 01/80 08/76 > 01/80	S 8260 PO	S 0101 N S 7411 N	S 2450 A
S 211 H some / alcuni	Mercedes Benz OM421A Mercedes Benz OM421A	09/85 > 06/96 09/85 > 06/96	S 7261 PO S 7261 PO	S 2162 N S 2161 N	S 2650 A S 0450 A
S 211 H power steering / servosterzo	Mercedes Benz OM422.900 Mercedes Benz OM422.900	01/80 > 06/96 01/80 > 06/96	S 7261 PO	S 2162 N	S 2650 A S 3081 PO
S 212 2nd passage / 2.passaggio	MAN D2566 MAN D2566	06/79 > 05/83 06/79 > 05/83	S 7260 PO S 7260 PO	S 0101 N S 7411 N	S 2650 A S 2650 A
S 212 2nd passage / 2.passaggio some / alcuni	Mercedes Benz OM402 Mercedes Benz OM402 Mercedes Benz OM402	08/76 > 01/80 08/76 > 01/80 08/76 > 01/80	S 8260 PO S 7261 PO	S 0101 N S 0101 N	S 2650 A S 2650 A
S 212 2nd passage / 2.passaggio	Mercedes Benz OM403 Mercedes Benz OM403		S 7261 PO	S 0101 N S 7411 N	S 0450 A
S 212 some / alcuni	Mercedes Benz OM421.900 Mercedes Benz OM421.900	01/80 > 05/83 01/80 > 05/83	S 8260 PO S 7261 PO	S 2161 N S 2162 N	S 2650 A S 0450 A
S 212 some / alcuni	Mercedes Benz OM422.900 Mercedes Benz OM422.900	01/80 > 05/83 01/80 > 05/83	S 7261 PO S 7261 PO	S 2162 N S 2161 N	S 0450 A S 0450 A
S 212 H 2nd passage / 2.passaggio	MAN D2566 MAN D2566	06/79 > 05/83 06/79 > 05/83	S 7260 PO	S 0101 N S 7411 N	S 2650 A
S 212 H 2nd passage / 2.passaggio some / alcuni	Mercedes Benz OM402 Mercedes Benz OM402 Mercedes Benz OM402	08/76 > 01/80 08/76 > 01/80 08/76 > 01/80	S 8260 PO S 7261 PO	S 0101 N S 0101 N	S 2650 A S 2650 A
S 212 H some / alcuni	Mercedes Benz OM421.900 Mercedes Benz OM421.900	01/80 > 05/83 01/80 > 08/83	S 8260 PO S 7261 PO	S 2161 N S 2162 N	S 2650 A S 0450 A
S 212 H some / alcuni	Mercedes Benz OM422.900 Mercedes Benz OM422.900	01/80 > 05/83 01/80 > 05/83	S 7261 PO S 7261 PO	S 2162 N S 2161 N	S 0450 A S 0450 A
S 213 2nd passage / 2.passaggio	MAN D2566 MAN D2566		S 7260 PO	S 0101 N S 7411 N	S 2650 A
S 213 2nd passage / 2.passaggio power steering / servosterzo	MAN D2566 MH MAN D2566 MH MAN D2566 MH	06/79 > 01/94 06/79 > 01/94 06/79 > 01/94	S 7260 PO	S 0101 N S 7411 N	S 2650 A S 3081 PO
S 213 2nd passage / 2.passaggio some / alcuni	Mercedes Benz OM402 Mercedes Benz OM402 Mercedes Benz OM402		S 8260 PO S 7261 PO	S 0101 N S 0101 N	S 2650 A S 2650 A
S 213 2nd passage / 2.passaggio	Mercedes Benz OM403 Mercedes Benz OM403		S 7261 PO	S 0101 N S 7411 N	S 0450 A
S 213 power steering / servosterzo	Mercedes Benz OM422.900 Mercedes Benz OM422.900	01/80 > 06/96 01/80 > 06/96	S 7261 PO	S 2162 N	S 1050 A S 3081 PO
S 213 H 2nd passage / 2.passaggio	MAN D2566 MH MAN D2566 MH	06/79 > 01/94 06/79 > 01/94	S 7260 PO	S 0101 N S 7411 N	S 2650 A
S 213 H 2nd passage / 2.passaggio some / alcuni	Mercedes Benz OM402 Mercedes Benz OM402 Mercedes Benz OM402	08/76 > 01/80 08/76 > 01/80 08/76 > 01/80	S 8260 PO S 7261 PO	S 0101 N S 0101 N	S 2650 A S 2650 A
S 213 H 2nd passage / 2.passaggio	Mercedes Benz OM403 Mercedes Benz OM403	08/76 > 12/81 08/76 > 12/81	S 7261 PO	S 0101 N S 7411 N	S 0450 A
S 213 H power steering / servosterzo	Mercedes Benz OM422.900 Mercedes Benz OM422.900	01/80 > 06/96 01/80 > 06/96	S 7261 PO	S 2162 N	S 1050 A S 3081 PO
S 213 H power steering / servosterzo	Mercedes Benz OM422.901 A Mercedes Benz OM422.901 A	09/83 > 06/96 09/83 > 06/96	S 7261 PO	S 2162 N	S 1050 A S 3081 PO
S 213 HR power steering / servosterzo	Mercedes Benz OM422.900 Mercedes Benz OM422.900	01/80 > 06/96 01/80 > 06/96	S 7261 PO	S 2162 N	S 1050 A S 3081 PO
S 214 2nd passage / 2.passaggio power steering / servosterzo	MAN D2866 KOH/LOH MAN D2866 KOH/LOH MAN D2866 KOH/LOH		S 7260 PO	S 0201 N S 1411 N	S 1050 A S 3081 PO
S 214 some / alcuni	Mercedes Benz OM422.900 Mercedes Benz OM422.900	09/83 > 06/96 09/83 > 06/96	S 7261 PO S 7261 PO	S 2162 N S 2162 N	S 1050 A S 0450 A
S 214 some / alcuni	Mercedes Benz OM422A Mercedes Benz OM422A		S 7261 PO S 7261 PO	S 2162 N S 2162 N	S 1050 A S 7213 A
S 214 some / alcuni	Mercedes Benz OM422LA Mercedes Benz OM422LA		S 7261 PO S 7261 PO	S 2162 N S 2162 N	S 1050 A S 7213 A
S 214 some / alcuni	Mercedes Benz OM442 Mercedes Benz OM442LA		S 7261 PO S 7261 PO	S 2162 N S 2162 N	S 0450 A S 1050 A
S 214 some / alcuni	Mercedes Benz OM442LA Mercedes Benz OM442LA		S 7261 PO	S 2162 N	S 1050 A S 7213 A

**KW HP****...KAESSBOHRER - buses/autobus**

S 214 H power steering / servosterzo	MAN D2866 KOH	08/87 > 01/95	S 7260 PO	S 1411 N	S 1050 A	S 3081 PO
S 214 HD some / alcuni power steering / servosterzo	MAN D2866 KOH Mercedes Benz OM422.900 Mercedes Benz OM422.900 Mercedes Benz OM422.900	08/87 > 01/95 09/83 > 06/96 09/83 > 06/96 09/83 > 06/96	S 7261 PO S 7261 PO	S 2162 N S 2162 N	S 1050 A S 0450 A	S 3081 PO
S 214 HD power steering / servosterzo	Mercedes Benz OM422.901 A Mercedes Benz OM422.901 A	09/83 > 06/96 09/83 > 06/96	S 7261 PO	S 2162 N	S 1050 A	S 3081 PO
S 215 2nd passage / 2.passaggio	MAN D2566 MAN D2566		S 7260 PO	S 0101 N S 7411 N	S 2650 A	
S 215 2nd passage / 2.passaggio	MAN D2866 KOH/LOH MAN D2866 KOH/LOH		S 7260 PO	S 0201 N S 1411 N	S 1050 A	
S 215 2nd passage / 2.passaggio	Mercedes Benz OM401 Mercedes Benz OM401	08/76 > 01/80 08/76 > 01/80	S 8260 PO	S 0101 N S 7411 N	S 2450 A	
S 215 2nd passage / 2.passaggio some / alcuni	Mercedes Benz OM402 Mercedes Benz OM402 Mercedes Benz OM402		S 8260 PO S 7261 PO	S 0101 N S 0101 N	S 2650 A S 2650 A	
S 215 2nd passage / 2.passaggio	Mercedes Benz OM403 Mercedes Benz OM403		S 7261 PO	S 0101 N S 7411 N	S 0450 A	
S 215 power steering / servosterzo	Mercedes Benz OM422.900 Mercedes Benz OM422.900	09/83 > 06/96 09/83 > 06/96	S 7261 PO	S 2162 N	S 0450 A	S 3081 PO
S 215 some / alcuni	Mercedes Benz OM422A Mercedes Benz OM422A	10/93 >	S 7261 PO S 7261 PO	S 2162 N S 2162 N	S 1050 A S 7213 A	
S 215 some / alcuni	Mercedes Benz OM422LA Mercedes Benz OM422LA	10/93 >	S 7261 PO S 7261 PO	S 2162 N S 2162 N	S 1050 A S 7213 A	
S 215	Mercedes Benz OM442		S 7261 PO	S 2162 N	S 0450 A	
S 215 H power steering / servosterzo	MAN D2866 KOH MAN D2866 KOH	08/87 > 01/95 08/87 > 01/95	S 7260 PO	S 1411 N	S 1050 A	S 3081 PO
S 215 H 2nd passage / 2.passaggio some / alcuni	Mercedes Benz OM402 Mercedes Benz OM402 Mercedes Benz OM402	08/76 > 01/80 08/76 > 01/80 08/76 > 01/80	S 8260 PO S 7261 PO	S 0101 N S 0101 N	S 2650 A S 2650 A	
S 215 H 2nd passage / 2.passaggio	Mercedes Benz OM403 Mercedes Benz OM403	08/76 > 12/81 08/76 > 12/81	S 7261 PO	S 0101 N S 7411 N	S 0450 A	
S 215 H power steering / servosterzo	Mercedes Benz OM422.900 Mercedes Benz OM422.900	01/80 > 01/80 >	S 7261 PO	S 2162 N	S 0450 A	S 3081 PO
S 215 H power steering / servosterzo	Mercedes Benz OM422.901A Mercedes Benz OM422.901A	09/83 > 09/83 >	S 7261 PO	S 2162 N	S 1050 A	S 3081 PO
S 215 H power steering / servosterzo	Mercedes Benz OM442A Mercedes Benz OM442A	07/88 > 07/88 >	S 7261 PO	S 2162 N	S 1050 A	S 3081 PO
S 215 HDH-3 dryer filter / filtro essiccatore	Detroit Diesel 60DDEC	03/99 >				S 7259 A
S 215 HDS some / alcuni	Mercedes Benz OM422.901A Mercedes Benz OM422.901A	07/80 > 09/83 07/80 > 09/83	S 7261 PO S 7261 PO	S 2162 N S 2161 N	S 1050 A S 1050 A	
S 215 HR power steering / servosterzo	Mercedes Benz OM422.900 Mercedes Benz OM422.900	09/83 > 09/83 >	S 7261 PO	S 2162 N	S 0450 A	S 3081 PO
S 215 NR power steering / servosterzo	Mercedes Benz OM447HA Mercedes Benz OM447HA	07/92 > 07/92 >	S 7261 PO	S 4378 NR	S 0450 A	S 3081 PO
S 215 NR/UL power steering / servosterzo	Mercedes Benz OM447HA Mercedes Benz OM447HA		S 7261 PO	S 2162 N	S 0450 A	S 3081 PO
S 215 RL power steering / servosterzo	Mercedes Benz OM422.900 Mercedes Benz OM422.900	09/83 > 06/96 09/83 > 06/96	S 7261 PO	S 2162 N	S 0450 A	S 3081 PO
S 215 SL	MAN D2566 MTH	06/79 > 09/85	S 7260 PO	S 1411 N	S 2650 A	
S 215 SL power steering / servosterzo	MAN D2866 TUH MAN D2866 TUH	09/85 > 01/95 09/85 > 01/95	S 7260 PO	S 1411 N	S 1050 A	S 3081 PO
S 215 SL power steering / servosterzo	Mercedes Benz OM407H Mercedes Benz OM407H	09/83 > 09/85 09/83 > 09/85	S 7261 PO	S 2162 N	S 0450 A	S 3081 PO
S 215 SL power steering / servosterzo	Mercedes Benz OM407HA Mercedes Benz OM407HA	09/83 > 09/85 09/83 > 09/85	S 7261 PO	S 2162 N	S 0450 A	S 3081 PO
S 215 SL spin-on / avvitabile power steering / servosterzo	Mercedes Benz OM427H Mercedes Benz OM427H	09/85 > 09/85 >	S 7261 PO	S 2162 N S 4378 NR	S 0450 A	S 3081 PO
S 215 SL spin-on / avvitabile power steering / servosterzo	Mercedes Benz OM427HA Mercedes Benz OM427HA	09/85 > 09/85 >	S 7261 PO	S 2162 N S 4378 NR	S 0450 A	S 3081 PO
S 215 SL spin-on / avvitabile power steering / servosterzo	Mercedes Benz OM447H II Mercedes Benz OM447H II	09/85 > 09/85 >	S 7261 PO	S 2162 N S 4378 NR	S 0450 A	S 3081 PO
S 215 UL	MAN D2566 MTH	06/79 > 09/85	S 7260 PO	S 1411 N	S 2650 A	





KW HP



...KAESSBOHRER - buses/autobus

S 215 UL	MAN D2866 TUH			09/85 > 01/95	S 7260 PO	S 1411 N	S 1050 A	
power steering / servosterzo	MAN D2866 TUH			09/85 > 01/95				S 3081 PO
S 215 UL	Mercedes Benz OM407H			09/83 > 09/85	S 7261 PO	S 2162 N	S 0450 A	
power steering / servosterzo	Mercedes Benz OM407H			09/83 > 09/85				S 3081 PO
S 215 UL	Mercedes Benz OM407HA			09/83 > 09/85	S 7261 PO	S 2162 N	S 0450 A	
power steering / servosterzo	Mercedes Benz OM407HA			09/83 > 09/85				S 3081 PO
S 215 UL	Mercedes Benz OM427H			09/85 >	S 7261 PO	S 2162 N	S 0450 A	
spin-on / avvitabile	Mercedes Benz OM427H			09/85 >		S 4378 NR		
power steering / servosterzo	Mercedes Benz OM427H			09/85 >				S 3081 PO
S 215 UL	Mercedes Benz OM427HA			09/85 >	S 7261 PO	S 2162 N	S 0450 A	
spin-on / avvitabile	Mercedes Benz OM427HA			09/85 >		S 4378 NR		
power steering / servosterzo	Mercedes Benz OM427HA			09/85 >				S 3081 PO
S 216	MAN D2866 KOH/LOH				S 7260 PO	S 0201 N	S 1050 A	
2nd passage / 2.passaggio	MAN D2866 KOH/LOH					S 1411 N		
S 216	Mercedes Benz OM422A				S 7261 PO	S 2162 N	S 1050 A	
some / alcuni	Mercedes Benz OM422A		10/93 >		S 7261 PO	S 2162 N	S 7213 A	
S 216	Mercedes Benz OM422LA				S 7261 PO	S 2162 N	S 1050 A	
some / alcuni	Mercedes Benz OM422LA		10/93 >		S 7261 PO	S 2162 N	S 7213 A	
S 216	Mercedes Benz OM442LA				S 7261 PO	S 2162 N	S 1050 A	
some / alcuni	Mercedes Benz OM442LA		10/93 >		S 7261 PO	S 2162 N	S 7213 A	
S 216 HDS	MAN D2866 KOH			09/86 > 01/95	S 7260 PO	S 1411 N	S 1050 A	
power steering / servosterzo	MAN D2866 KOH			09/86 > 01/95				S 3081 PO
S 216 HDS	Mercedes Benz OM422.901A			07/80 >	S 7261 PO	S 2162 N	S 1050 A	
power steering / servosterzo	Mercedes Benz OM422.901A			07/80 >				S 3081 PO
S 216 HDS	Mercedes Benz OM422LA			09/85 >	S 7261 PO	S 2162 N	S 1050 A	
power steering / servosterzo	Mercedes Benz OM422LA			09/85 >				S 3081 PO
S 217 HDH-3								
dryer filter / filtro essiccatore	Detroit Diesel 60DDECIII			01/96 >				S 7259 A
S 221	Mercedes Benz OM407H			09/84 > 09/85	S 7261 PO	S 2162 N	S 0450 A	
power steering / servosterzo	Mercedes Benz OM407H			09/84 > 09/85				S 3081 PO
S 228	Mercedes Benz OM422A			01/89 >	S 7261 PO	S 2162 N	S 1050 A	
power steering / servosterzo	Mercedes Benz OM422A			01/89 >				S 3081 PO
S 228	Mercedes Benz OM422LA			03/82 >	S 7261 PO	S 2162 N	S 1050 A	
power steering / servosterzo	Mercedes Benz OM422LA			03/82 >				S 3081 PO
S 228	Mercedes Benz OM442LA			01/89 >	S 7261 PO	S 2162 N	S 1050 A	
some / alcuni	Mercedes Benz OM442LA			10/83 >	S 7261 PO	S 2162 N	S 7213 A	
power steering / servosterzo	Mercedes Benz OM442LA			01/89 >				S 3081 PO
S 228 DT	Mercedes Benz OM422A			01/89 >	S 7261 PO	S 2162 N	S 1050 A	
power steering / servosterzo	Mercedes Benz OM422A			01/89 >				S 3081 PO
S 228 DT	Mercedes Benz OM422LA			03/82 >	S 7261 PO	S 2162 N	S 1050 A	
power steering / servosterzo	Mercedes Benz OM422LA			03/82 >				S 3081 PO
S 228 DT	Mercedes Benz OM442LA			01/89 >	S 7261 PO	S 2162 N	S 1050 A	
some / alcuni	Mercedes Benz OM442LA			10/93 >	S 7261 PO	S 2162 N	S 7213 A	
power steering / servosterzo	Mercedes Benz OM442LA			01/89 >				S 3081 PO
S 250 Special	MAN D2866 LOH 22			07/94 >	S 7260 PO	S 1411 N	S 1050 A	
spin-on / avvitabile	MAN D2866 LOH 22			07/94 >	S 7260 PO	S 4378 NR	S 1050 A	
power steering / servosterzo	MAN D2866 LOH 22			07/94 >				S 3081 PO
S 250 Spezial	MAN D2866 LOH 22			07/94 >	S 7260 PO	S 1411 N	S 1050 A	
spin-on / avvitabile	MAN D2866 LOH 22			07/94 >	S 7260 PO	S 4378 NR	S 1050 A	
power steering / servosterzo	MAN D2866 LOH 22			07/94 >				S 3081 PO
S 300 Serie								
S 300 N	MAN D2866	177 240		03/92 >	S 7260 PO	S 0201 N	S 2650 A	
2nd passage / 2.passaggio	MAN D2866	177 240		03/92 >		S 1411 N		
spin-on / avvitabile	MAN D2866	177 240		03/92 >		S 4378 NR		
with automatic gearbox ZF HP500/590 / con cambio automatico ZF HP500/590	MAN D2866	177 240		03/92 >				S 2234 Z
dryer filter / filtro essiccatore	MAN D2866	177 240		03/92 >				S 7259 A
power steering / servosterzo	MAN D2866	177 240		03/92 >				S 3081 PO
S 300 N	MAN D2866 OH	177 240		03/92 >	S 7260 PO	S 0201 N	S 2650 A	
2nd passage / 2.passaggio	MAN D2866 OH	177 240		03/92 >		S 1411 N		
spin-on / avvitabile	MAN D2866 OH	177 240		03/92 >		S 4378 NR		
with automatic gearbox ZF HP500/590 / con cambio automatico ZF HP500/590	MAN D2866 OH	177 240		03/92 >				S 2234 Z
dryer filter / filtro essiccatore	MAN D2866 OH	177 240		03/92 >				S 7259 A
power steering / servosterzo	MAN D2866 OH	177 240		03/92 >				S 3081 PO
S 309 HD	Mercedes Benz OM401LA	213 290		09/91 > 02/02	S 7261 PO	S 2162 N	S 0450 A	
dryer filter / filtro essiccatore	Mercedes Benz OM401LA	213 290		09/91 > 02/02				S 7259 A
power steering / servosterzo	Mercedes Benz OM401LA	213 290		09/91 > 02/02				S 3081 PO
S 309 HD	Mercedes Benz OM441LA	213 290		09/92 > 09/95	S 5133 PE		S 1670 A	

**KW HP****...KAESSBOHRER - buses/autobus**

dryer filter / filtro essiccatore	Mercedes Benz OM441LA	213	290	09/92	>	09/95			S 7259 A
2 filters / N.2 filtri	Mercedes Benz OM441LA	213	290	09/92	>	09/95		S 2162 N	
power steering / servosterzo	Mercedes Benz OM441LA	213	290	09/92	>	09/95			S 3081 PO
S 312 HD	Mercedes Benz OM441LA	250	340	09/91	>	02/02	S 5133 PE		S 1670 A
dryer filter / filtro essiccatore	Mercedes Benz OM441LA	250	340	09/91	>	02/02		S 2162 N	S 7259 A
2 filters / N.2 filtri	Mercedes Benz OM441LA	250	340	09/91	>	02/02			S 3081 PO
power steering / servosterzo	Mercedes Benz OM441LA	250	340	09/91	>	02/02			
S 313 UL	MAN D2866 LUH	228	311	04/95	>	09/98	S 7260 PO		S 7546 A
with automatic gearbox ZF HP500 / con cambio automatico ZF HP500	MAN D2866 LUH	228	311	04/95	>	09/98			S 2234 Z
dryer filter / filtro essiccatore	MAN D2866 LUH	228	311	04/95	>	09/98			S 7259 A
2 filters / N.2 filtri	MAN D2866 LUH	228	311	04/95	>	09/98		S 4378 NR	
power steering / servosterzo	MAN D2866 LUH	228	311	04/95	>	09/98			S 3081 PO
S 313 UL	MAN D2866 LUH	257	350	04/95	>	09/98	S 7260 PO		S 7546 A
with automatic gearbox ZF HP500 / con cambio automatico ZF HP500	MAN D2866 LUH	257	350	04/95	>	09/98			S 2234 Z
dryer filter / filtro essiccatore	MAN D2866 LUH	257	350	04/95	>	09/98			S 7259 A
2 filters / N.2 filtri	MAN D2866 LUH	257	350	04/95	>	09/98		S 4378 NR	
power steering / servosterzo	MAN D2866 LUH	257	350	04/95	>	09/98			S 3081 PO
S 313 UL	Mercedes Benz OM447HLA	184	250	05/95	>		S 7261 PO	S 2162 N	
with automatic gearbox ZF HP500 / con cambio automatico ZF HP500	Mercedes Benz OM447HLA	184	250	05/95	>				S 2234 Z
dryer filter / filtro essiccatore	Mercedes Benz OM447HLA	184	250	05/95	>				S 7259 A
power steering / servosterzo	Mercedes Benz OM447HLA	184	250	05/95	>				S 3081 PO
S 313 UL	Mercedes Benz OM447HLA	220	300	03/95	>	02/02	S 7261 PO		S 7546 A
some / alcuni	Mercedes Benz OM447HLA	220	300	03/95	>	02/02			S 7575 A
with automatic gearbox ZF HP500 / con cambio automatico ZF HP500	Mercedes Benz OM447HLA	220	300	03/95	>	02/02			S 2234 Z
dryer filter / filtro essiccatore	Mercedes Benz OM447HLA	220	300	03/95	>	02/02			S 7259 A
2 filters spin-on / N.2 filtri avvitabile	Mercedes Benz OM447HLA	220	300	03/95	>	02/02		S 4378 NR	
2 filters cartridge / N.2 filtri immersione	Mercedes Benz OM447HLA	220	300	03/95	>	02/02		S 2162 N	
power steering / servosterzo	Mercedes Benz OM447HLA	220	300	03/95	>	02/02			S 3081 PO
S 313 UL	Mercedes Benz OM447HLA	257	350	04/95	>	12/96	S 7261 PO		S 7431 A
	Mercedes Benz OM447HLA	257	350	01/97	>		S 7261 PO		S 7575 A
with automatic gearbox ZF HP500 / con cambio automatico ZF HP500	Mercedes Benz OM447HLA	257	350	04/95	>				S 2234 Z
dryer filter / filtro essiccatore	Mercedes Benz OM447HLA	257	350	04/95	>				S 7259 A
2 filters some / N.2 filtri alcuni	Mercedes Benz OM447HLA	257	350	04/95	>		S 5036 PE		
2 filters spin-on / N.2 filtri avvitabile	Mercedes Benz OM447HLA	257	350	04/95	>			S 4378 NR	
2 filters cartridge / N.2 filtri immersione	Mercedes Benz OM447HLA	257	350	04/95	>			S 2162 N	
power steering / servosterzo	Mercedes Benz OM447HLA	257	350	04/95	>				S 3081 PO
S 313 UL	Mercedes Benz OM457HLA	185	252	09/00	>		S 5036 PE	S 6001 NE	
dryer filter / filtro essiccatore	Mercedes Benz OM457HLA	185	252	09/00	>				S 7259 A
power steering / servosterzo	Mercedes Benz OM457HLA	185	252	09/00	>				S 3081 PO
S 315 GT	Mercedes Benz OM441LA	250	340	09/91	>		S 5133 PE		
dryer filter / filtro essiccatore	Mercedes Benz OM441LA	250	340	09/91	>				S 7259 A
assembly DONALDSON / montaggio DONALDSON	Mercedes Benz OM441LA	250	340	01/97	>				S 7608 A
assembly MANN+HUMMEL / montaggio MANN+HUMMEL	Mercedes Benz OM441LA	250	340	09/91	>				S 1670 A
2 filters / N.2 filtri	Mercedes Benz OM441LA	250	340	09/91	>			S 2162 N	
power steering / servosterzo	Mercedes Benz OM441LA	250	340	09/91	>				S 3081 PO
S 315 GT	Mercedes Benz OM457HLA	220	299	09/00	>			S 6001 NE	
dryer filter / filtro essiccatore	Mercedes Benz OM457HLA	220	299	09/00	>				S 7259 A
assembly DONALDSON / montaggio DONALDSON	Mercedes Benz OM457HLA	220	299	09/00	>	10/01			S 7608 A
assembly MANN+HUMMEL / montaggio MANN+HUMMEL	Mercedes Benz OM457HLA	220	299	09/00	>				S 7573 A
2 filters / N.2 filtri	Mercedes Benz OM457HLA	220	299	09/00	>		S 5036 PE		
prefilter PARKER-RACOR / prefiltra PARKER-RACOR	Mercedes Benz OM457HLA	220	299	09/00	>			S 4121 NR	
prefilter PARKER-RACOR R90P / prefiltra PARKER-RACOR R90P	Mercedes Benz OM457HLA	220	299	09/00	>			S 4143 NR	
power steering / servosterzo	Mercedes Benz OM457HLA	220	299	09/00	>				S 3081 PO
S 315 GT-HD	MAN D2866 LOH	294	401	01/92	>		S 7260 PO		
dryer filter / filtro essiccatore	MAN D2866 LOH	294	401	01/92	>				S 7259 A
assembly MANN+HUMMEL / montaggio MANN+HUMMEL	MAN D2866 LOH	294	401	01/92	>			S 7546 A	
2 filters / N.2 filtri	MAN D2866 LOH	294	401	01/92	>			S 4378 NR	
power steering / servosterzo	MAN D2866 LOH	294	401	01/92	>				S 3081 PO
S 315 GT-HD	Mercedes Benz OM441LA	250	340	09/91	>		S 5133 PE		
dryer filter / filtro essiccatore	Mercedes Benz OM441LA	250	340	09/91	>				S 7259 A
assembly DONALDSON / montaggio DONALDSON	Mercedes Benz OM441LA	250	340	09/91	>				S 7608 A
assembly MANN+HUMMEL / montaggio MANN+HUMMEL	Mercedes Benz OM441LA	250	340	09/91	>				S 1670 A
2 filters / N.2 filtri	Mercedes Benz OM441LA	250	340	09/91	>			S 2162 N	
power steering / servosterzo	Mercedes Benz OM441LA	250	340	09/91	>				S 3081 PO
S 315 GT-HD	Mercedes Benz OM457LA	260	354	09/00	>		S 5036 PE	S 6001 NE	
dryer filter / filtro essiccatore	Mercedes Benz OM457LA	260	354	09/00	>				S 7259 A
power steering / servosterzo	Mercedes Benz OM457LA	260	354	09/00	>				S 3081 PO



**KW HP****...KAESSBOHRER - buses/autobus****K**

S 315 H	Mercedes Benz OM441LA	213	290	03/95	>	S 5133 PE		S 7608 A	
some 2 filters / alcuni N.2 filtri	Mercedes Benz OM441LA	213	290	03/95	>		S 4378 NR		
dryer filter / filtro essiccatore	Mercedes Benz OM441LA	213	290	03/95	>				S 7259 A
2 filters / N.2 filtri	Mercedes Benz OM441LA	213	290	03/95	>		S 2162 N		
power steering / servosterzo	Mercedes Benz OM441LA	213	290	03/95	>				S 3081 PO
S 315 H	Mercedes Benz OM441LA	280	382	01/90	> 12/96	S 5133 PE		S 7546 A	
	Mercedes Benz OM441LA	280	382	01/97	>	S 5133 PE		S 7608 A	
some 2 filters / alcuni N.2 filtri	Mercedes Benz OM441LA	280	382	01/90	>		S 4378 NR		
dryer filter / filtro essiccatore	Mercedes Benz OM441LA	280	382	01/90	>				S 7259 A
2 filters / N.2 filtri	Mercedes Benz OM441LA	280	382	01/90	>		S 2162 N		
power steering / servosterzo	Mercedes Benz OM441LA	280	382	01/90	>				S 3081 PO
S 315 H	Mercedes Benz OM457LA	220	299	09/00	>	S 5036 PE	S 6001 NE		
dryer filter / filtro essiccatore	Mercedes Benz OM457LA	220	299	09/00	>				S 7259 A
power steering / servosterzo	Mercedes Benz OM457LA	220	299	09/00	>				S 3081 PO
S 315 HD	Mercedes Benz OM441LA	250	340	09/91	>	S 5133 PE			
dryer filter / filtro essiccatore	Mercedes Benz OM441LA	250	340	09/91	>				S 7259 A
assembly DONALDSON / montaggio DONALDSON	Mercedes Benz OM441LA	250	340	01/97	>			S 7608 A	
assembly MANN+HUMMEL / montaggio MANN+HUMMEL	Mercedes Benz OM441LA	250	340	09/91	>			S 1670 A	
2 filters / N.2 filtri	Mercedes Benz OM441LA	250	340	09/91	>		S 2162 N		
2 filters spin-on / N.2 filtri avvitabile	Mercedes Benz OM441LA	250	340	09/91	>		S 4378 NR		
power steering / servosterzo	Mercedes Benz OM441LA	250	340	09/91	>				S 3081 PO
S 315 HD	Mercedes Benz OM442			09/91	>	S 7261 PO	S 2162 N	S 0450 A	
dryer filter / filtro essiccatore	Mercedes Benz OM442			09/91	>				S 7259 A
power steering / servosterzo	Mercedes Benz OM442			09/91	>				S 3081 PO
S 315 HD	Mercedes Benz OM442A			09/91	>	S 7261 PO	S 2162 N	S 1050 A	
dryer filter / filtro essiccatore	Mercedes Benz OM442A			09/91	>				S 7259 A
power steering / servosterzo	Mercedes Benz OM442A			09/91	>				S 3081 PO
S 315 HD	Scania DS/DSC 11.22			09/91	>		S 4378 NR	S 0450 A	
some / alcuni	Scania DS/DSC 11.22			09/91	>		S 4323 NR	S 1050 A	
dryer filter / filtro essiccatore	Scania DS/DSC 11.22			09/91	>				S 7259 A
power steering / servosterzo	Scania DS/DSC 11.22			09/91	>				S 3081 PO
turbocompressor / turbocompressore	Scania DS/DSC 11.22			09/91	>	S 2329 R			
S 315 HDH	Mercedes Benz OM441LA	250	340	09/91	>	S 5133 PE			
some power steering / alcuni servosterzo	Mercedes Benz OM441LA	250	340	09/91	>				S 8790 PO
dryer filter / filtro essiccatore	Mercedes Benz OM441LA	250	340	09/91	>				S 7259 A
assembly DONALDSON / montaggio DONALDSON	Mercedes Benz OM441LA	250	340	01/97	>			S 7608 A	
assembly MANN+HUMMEL / montaggio MANN+HUMMEL	Mercedes Benz OM441LA	250	340	09/91	>			S 1670 A	
2 filters / N.2 filtri	Mercedes Benz OM441LA	250	340	09/91	>		S 2162 N		
2 filters spin-on / N.2 filtri avvitabile	Mercedes Benz OM441LA	250	340	09/91	>		S 4378 NR		
power steering / servosterzo	Mercedes Benz OM441LA	250	340	09/91	>				S 3081 PO
S 315 HDH	Mercedes Benz OM442			09/91	>	S 7261 PO	S 2162 N	S 0450 A	
dryer filter / filtro essiccatore	Mercedes Benz OM442			09/91	>				S 7259 A
power steering / servosterzo	Mercedes Benz OM442			09/91	>				S 3081 PO
S 315 HDH	Mercedes Benz OM442A			09/91	>	S 7261 PO	S 2162 N	S 1050 A	
dryer filter / filtro essiccatore	Mercedes Benz OM442A			09/91	>				S 7259 A
power steering / servosterzo	Mercedes Benz OM442A			09/91	>				S 3081 PO
S 315 HDH	Scania DS/DSC 11.22			09/91	>		S 4378 NR	S 0450 A	
some / alcuni	Scania DS/DSC 11.22			09/91	>		S 4323 NR	S 1050 A	
dryer filter / filtro essiccatore	Scania DS/DSC 11.22			09/91	>				S 7259 A
power steering / servosterzo	Scania DS/DSC 11.22			09/91	>				S 3081 PO
turbocompressor / turbocompressore	Scania DS/DSC 11.22			09/91	>	S 2329 R			
S 315 NF	Mercedes Benz OM447HLA			03/96	>	S 7261 PO	S 2162 N	S 0450 A	
spin-on / avvitabile	Mercedes Benz OM447HLA			03/96	>		S 4378 NR		
with automatic gearbox ZF HP500/590 / con cambio automatico ZF HP500/590	Mercedes Benz OM447HLA			03/96	>				S 2234 Z
dryer filter / filtro essiccatore	Mercedes Benz OM447HLA			03/96	>				S 7259 A
power steering / servosterzo	Mercedes Benz OM447HLA			03/96	>				S 3081 PO
S 315 NF	Mercedes Benz OM447HLA	220	300	05/96	>	S 7261 PO	S 2162 N		
spin-on / avvitabile	Mercedes Benz OM447HLA	220	300	05/96	>		S 4378 NR		
with automatic gearbox ZF HP500 / con cambio automatico ZF HP500	Mercedes Benz OM447HLA	220	300	05/96	>				S 2234 Z
dryer filter / filtro essiccatore	Mercedes Benz OM447HLA	220	300	05/96	>				S 7259 A
power steering / servosterzo	Mercedes Benz OM447HLA	220	300	05/96	>				S 3081 PO
S 315 NF	Mercedes Benz OM457HLA	185	252	09/00	>	S 5036 PE	S 6001 NE		
dryer filter / filtro essiccatore	Mercedes Benz OM457HLA	185	252	09/00	>				S 7259 A
power steering / servosterzo	Mercedes Benz OM457HLA	185	252	09/00	>				S 3081 PO
S 315 UL	MAN D2866 LUH			04/95	> 12/96	S 7260 PO	S 4378 NR	S 0450 A	
	MAN D2866 LUH			01/97	>	S 7260 PO	S 4378 NR		
with automatic gearbox ZF HP500 / con cambio automatico ZF HP500	MAN D2866 LUH			04/95	>				S 2234 Z

**KW HP****...KAESSBOHRER - buses/autobus**

dryer filter / filtro essiccatore	MAN D2866 LUH			04/95 >				S 7259 A
power steering / servosterzo	MAN D2866 LUH			04/95 >				S 3081 PO
S 315 UL	Mercedes Benz OM447HLA	257	350	03/95 >	S 7261 PO	S 2162 N	S 0450 A	
some / alcuni	Mercedes Benz OM447HLA	257	350	03/95 >			S 7431 A	
with automatic gearbox ZF HP500 / con cambio automatico ZF HP500	Mercedes Benz OM447HLA	257	350	03/95 >				S 2234 Z
dryer filter / filtro essiccatore	Mercedes Benz OM447HLA	257	350	03/95 >				S 7259 A
2 filters spin-on / N.2 filtri avvitabile	Mercedes Benz OM447HLA	257	350	03/95 >		S 4378 NR		
power steering / servosterzo	Mercedes Benz OM447HLA	257	350	03/95 >				S 3081 PO
S 315 UL	Mercedes Benz OM457HLA	185	252	09/00 >	S 5036 PE	S 6001 NE		
dryer filter / filtro essiccatore	Mercedes Benz OM457HLA	185	252	09/00 >				S 7259 A
power steering / servosterzo	Mercedes Benz OM457HLA	185	252	09/00 >				S 3081 PO
S 315 UL	Mercedes Benz OM457HLA	202	300	09/00 >	S 5036 PE	S 6001 NE		
dryer filter / filtro essiccatore	Mercedes Benz OM457HLA	202	300	09/00 >				S 7259 A
power steering / servosterzo	Mercedes Benz OM457HLA	202	300	09/00 >				S 3081 PO
S 316 HDS	Mercedes Benz OM442LA			01/90 >	S 7261 PO	S 2162 N	S 1050 A	
dryer filter / filtro essiccatore	Mercedes Benz OM442LA			01/90 >				S 7259 A
power steering / servosterzo	Mercedes Benz OM442LA			01/90 >				S 3081 PO
S 316 UL	Mercedes Benz OM457HLA	185	252	09/01 >	S 5036 PE	S 6001 NE		
dryer filter / filtro essiccatore	Mercedes Benz OM457HLA	185	252	09/01 >				S 7259 A
power steering / servosterzo	Mercedes Benz OM457HLA	185	252	09/01 >				S 3081 PO
S 317 GT-HD	Mercedes Benz OM442LA	280	381	09/99 >	S 5133 PE			
some power steering / alcuni servosterzo	Mercedes Benz OM442LA	280	381	09/99 >				S 8790 PO
dryer filter / filtro essiccatore	Mercedes Benz OM442LA	280	381	09/99 >				S 7259 A
2 filters / N.2 filtri	Mercedes Benz OM442LA	280	381	09/99 >		S 4378 NR		
power steering / servosterzo	Mercedes Benz OM442LA	280	381	09/99 >				S 3081 PO
S 317 GT-HD	Mercedes Benz OM442LA	319	435	07/00 >	S 5133 PE		S 7213 A	
some power steering / alcuni servosterzo	Mercedes Benz OM442LA	319	435	07/00 >				S 8790 PO
dryer filter / filtro essiccatore	Mercedes Benz OM442LA	319	435	07/00 >				S 7259 A
2 filters / N.2 filtri	Mercedes Benz OM442LA	319	435	07/00 >		S 4378 NR		
power steering / servosterzo	Mercedes Benz OM442LA	319	435	07/00 >				S 3081 PO
S 317 GT-HD	Mercedes Benz OM457HLA	185	252	09/01 >	S 5036 PE	S 6001 NE		
dryer filter / filtro essiccatore	Mercedes Benz OM457HLA	185	252	09/01 >				S 7259 A
power steering / servosterzo	Mercedes Benz OM457HLA	185	252	09/01 >				S 3081 PO
S 317 GT-HD	Mercedes Benz OM457LA	310	422	09/00 >	S 5036 PE	S 6001 NE		
dryer filter / filtro essiccatore	Mercedes Benz OM457LA	310	422	09/00 >				S 7259 A
power steering / servosterzo	Mercedes Benz OM457LA	310	422	09/00 >				S 3081 PO
S 317 HD-H3	Mercedes Benz OM502LA	349	476	07/00 >	S 5006 PE	S 6001 NE	S 7213 A	
dryer filter / filtro essiccatore	Mercedes Benz OM502LA	349	476	07/00 >				S 7259 A
power steering / servosterzo	Mercedes Benz OM502LA	349	476	07/00 >				S 3081 PO
S 317 HDH	Mercedes Benz OM442LA	320	436	01/90 >	S 7261 PO	S 2162 N	S 1050 A	
dryer filter / filtro essiccatore	Mercedes Benz OM442LA	320	436	01/90 >				S 7259 A
power steering / servosterzo	Mercedes Benz OM442LA	320	436	01/90 >				S 3081 PO
S 319 GT-HD	Mercedes Benz OM442A	280	382	09/98 >	S 7261 PO	S 2162 N	S 7608 A	
dryer filter / filtro essiccatore	Mercedes Benz OM442A	280	382	09/98 >				S 7259 A
power steering / servosterzo	Mercedes Benz OM442A	280	382	09/98 >				S 3081 PO
S 319 GT-HD	Mercedes Benz OM442LA	320	436	09/98 >	S 7261 PO	S 2162 N	S 7608 A	
dryer filter / filtro essiccatore	Mercedes Benz OM442LA	320	436	09/98 >				S 7259 A
power steering / servosterzo	Mercedes Benz OM442LA	320	436	09/98 >				S 3081 PO
S 319 GT-HD	Mercedes Benz OM457LA	310	422	09/00 >	S 5036 PE	S 6001 NE		
dryer filter / filtro essiccatore	Mercedes Benz OM457LA	310	422	09/00 >				S 7259 A
power steering / servosterzo	Mercedes Benz OM457LA	310	422	09/00 >				S 3081 PO
S 319 NF	Mercedes Benz OM447HLA	184	251	04/96 >	S 7261 PO	S 2162 N		
dryer filter / filtro essiccatore	Mercedes Benz OM447HLA	184	251	04/96 >				S 7259 A
power steering / servosterzo	Mercedes Benz OM447HLA	184	251	04/96 >				S 3081 PO
S 319 NF	Mercedes Benz OM447HLA	220	300	04/96 >	S 7261 PO	S 2162 N		
dryer filter / filtro essiccatore	Mercedes Benz OM447HLA	220	300	04/96 >				S 7259 A
power steering / servosterzo	Mercedes Benz OM447HLA	220	300	04/96 >				S 3081 PO
S 319 NF	Mercedes Benz OM457HLA	185	252	09/00 >	S 5036 PE	S 6001 NE		
dryer filter / filtro essiccatore	Mercedes Benz OM457HLA	185	252	09/00 >				S 7259 A
power steering / servosterzo	Mercedes Benz OM457HLA	185	252	09/00 >				S 3081 PO
S 319 UL	MAN D2866 LUH	228	311	04/95 >	S 7260 PO	S 4378 NR	S 0450 A	
	MAN D2866 LUH	228	311	01/97 >	S 7260 PO	S 4378 NR		
dryer filter / filtro essiccatore	MAN D2866 LUH	228	311	04/95 >				S 7259 A
power steering / servosterzo	MAN D2866 LUH	228	311	04/95 >				S 3081 PO
S 319 UL	MAN D2866 LUH	257	350	04/95 >	S 7260 PO	S 4378 NR	S 0450 A	
	MAN D2866 LUH	257	350	01/97 >	S 7260 PO	S 4378 NR		
dryer filter / filtro essiccatore	MAN D2866 LUH	257	350	04/95 >				S 7259 A

K

**KW HP****...KAESSBOHRER - buses/autobus**

power steering / servosterzo	MAN D2866 LUH	257	350	04/95	>				S 3081 PO
S 319 UL	Mercedes Benz OM447HLA	184	251	04/95	>	S 7261 PO		S 7575 A	
some power steering / alcuni servosterzo	Mercedes Benz OM447HLA	184	251	04/95	>				S 8790 PO
dryer filter / filtro essiccatore	Mercedes Benz OM447HLA	184	251	04/95	>				S 7259 A
2 filters / N.2 filtri	Mercedes Benz OM447HLA	184	251	04/95	>		S 2162 N		
2 filters spin-on / N.2 filtri avvitabile	Mercedes Benz OM447HLA	184	251	04/95	>		S 4378 NR		
power steering / servosterzo	Mercedes Benz OM447HLA	184	251	04/95	>				S 3081 PO
S 319 UL	Mercedes Benz OM447HLA	220	300	04/95	>	S 7261 PO		S 7575 A	
some power steering / alcuni servosterzo	Mercedes Benz OM447HLA	220	300	04/95	>				S 8790 PO
dryer filter / filtro essiccatore	Mercedes Benz OM447HLA	220	300	04/95	>				S 7259 A
2 filters / N.2 filtri	Mercedes Benz OM447HLA	220	300	04/95	>		S 2162 N		
2 filters spin-on / N.2 filtri avvitabile	Mercedes Benz OM447HLA	220	300	04/95	>		S 4378 NR		
power steering / servosterzo	Mercedes Benz OM447HLA	220	300	04/95	>				S 3081 PO
S 319 UL	Mercedes Benz OM457HLA	185	252	09/00	>	S 5036 PE	S 6001 NE		
dryer filter / filtro essiccatore	Mercedes Benz OM457HLA	185	252	09/00	>				S 7259 A
power steering / servosterzo	Mercedes Benz OM457HLA	185	252	09/00	>				S 3081 PO
S 328 DT	Mercedes Benz OM442A	280	382	01/90	>	S 7261 PO	S 2162 N	S 1050 A	
dryer filter / filtro essiccatore	Mercedes Benz OM442A	280	382	01/90	>				S 7259 A
power steering / servosterzo	Mercedes Benz OM442A	280	382	01/90	>				S 3081 PO
S 328 DT	Mercedes Benz OM442LA	320	436	01/90	> 09/02	S 7261 PO		S 7213 A	
some power steering / alcuni servosterzo	Mercedes Benz OM442LA	320	436	01/90	> 09/02				S 8790 PO
dryer filter / filtro essiccatore	Mercedes Benz OM442LA	320	436	01/90	> 09/02				S 7259 A
2 filters / N.2 filtri	Mercedes Benz OM442LA	320	436	01/90	> 09/02		S 2162 N		
2 filters spin-on / N.2 filtri avvitabile	Mercedes Benz OM442LA	320	436	01/90	> 09/02		S 4378 NR		
power steering / servosterzo	Mercedes Benz OM442LA	320	436	01/90	> 09/02				S 3081 PO
S 328 DT	Mercedes Benz OM442LA	385	525	01/92	> 09/02	S 7261 PO		S 7213 A	
some power steering / alcuni servosterzo	Mercedes Benz OM442LA	385	525	01/92	> 09/02				S 8790 PO
dryer filter / filtro essiccatore	Mercedes Benz OM442LA	385	525	01/92	> 09/02				S 7259 A
2 filters / N.2 filtri	Mercedes Benz OM442LA	385	525	01/92	> 09/02		S 2162 N		
power steering / servosterzo	Mercedes Benz OM442LA	385	525	01/92	> 09/02				S 3081 PO
S 400 Serie									
S 407 TC (Comfort Class EPA10)									
with automatic gearbox VOITH DIWA 864.3E / con cambio automatico VOITH DIWA 864.3E	Mercedes Benz OM471LA	306	416	03/11	>				S 5663 PO
additional filter compressor filter / filtro supplementare filtro compressore	Mercedes Benz OM471LA	306	416	03/11	>			S 7A14 A	
power steering / servosterzo	Mercedes Benz OM471LA	306	416	03/11	>				S 3081 PO
S 407 TC (Comfort Class EPA10)									
with automatic gearbox VOITH DIWA 864.3E / con cambio automatico VOITH DIWA 864.3E	Mercedes Benz OM471LA	336	457	03/11	>				S 5663 PO
additional filter compressor filter / filtro supplementare filtro compressore	Mercedes Benz OM471LA	336	457	03/11	>			S 7A14 A	
power steering / servosterzo	Mercedes Benz OM471LA	336	457	03/11	>				S 3081 PO
S 411 HD (Top Class)									
additional WEBASTO / addizionale WEBASTO	Mercedes Benz OM501LA	260	354	09/01	> 12/07	S 5006 PE	S 6001 NE		
dryer filter / filtro essiccatore	Mercedes Benz OM501LA	260	354	09/01	> 12/07		S 4378 NR		S 7259 A
additional filter compressor filter / filtro supplementare filtro compressore	Mercedes Benz OM501LA	260	354	09/04	> 12/07			S 7A14 A	
power steering / servosterzo	Mercedes Benz OM501LA	260	354	09/01	> 12/07				S 3081 PO
S 411 HD (Top Class)									
additional WEBASTO / addizionale WEBASTO	Mercedes Benz OM501LA	300	408	11/07	>	S 5006 PE	S 6001 NE		
with air-conditioner WEBASTO Aerosphere World NCI, N.4 PCS / con climatizzatore WEBASTO Aerosphere World NCI, N.4 PZ	Mercedes Benz OM501LA	300	408	11/07	>		S 4378 NR		S 3283 C
dryer filter / filtro essiccatore	Mercedes Benz OM501LA	300	408	11/07	>				S 7A66 A
5 filters / N.5 filtri	Mercedes Benz OM501LA	300	408	11/07	> 08/08			S 7695 A	
5 filters / N.5 filtri	Mercedes Benz OM501LA	300	408	09/08	>			S 7F31 A	
prefilter PARKER-RACOR / prefiltro PARKER-RACOR	Mercedes Benz OM501LA	300	408	11/07	>		S 4121 NR		
power steering ZF 766.387 / servosterzo ZF 766.387	Mercedes Benz OM501LA	300	408	11/07	>				S 3081 PO
power steering ZF 766.388 / servosterzo ZF 766.388	Mercedes Benz OM501LA	300	408	11/07	>				S 8790 PO
S 412 HD (Multi Class)									
additional Webasto Thermo 300/350 / addizionale Webasto Thermo 300/350	Mercedes Benz OM457HLA Euro6/EEV	220	299	03/10	>		S 6001 NE	S 7573 A	
with automatic gearbox VOITH DIWA 864.3E / con cambio automatico VOITH DIWA 864.3E	Mercedes Benz OM457HLA Euro6/EEV	220	299	03/10	>		S 4378 NR		
with air-conditioner KONVEKTA P600/800, N. 8 pcs / con climatizzatore KONVEKTA P600/800, N. 8 PZ	Mercedes Benz OM457HLA Euro6/EEV	220	299	03/10	>				S 5663 PO
with air-conditioner WEBASTO Aerosphere World NCI, N. 4 pcs / con climatizzatore WEBASTO Aerosphere World NCI, N.4 PZ	Mercedes Benz OM457HLA Euro6/EEV	220	299	03/10	>				S 3279 C
dryer filter / filtro essiccatore	Mercedes Benz OM457HLA Euro6/EEV	220	299	03/10	>				S 3283 C
2 filters / N.2 filtri	Mercedes Benz OM457HLA Euro6/EEV	220	299	03/10	>	S 5036 PE			S 7A66 A
prefilter PARKER-RACOR / prefiltro PARKER-RACOR	Mercedes Benz OM457HLA Euro6/EEV	220	299	03/10	>		S 4121 NR		
power steering / servosterzo	Mercedes Benz OM457HLA Euro6/EEV	220	299	03/10	>				S 3081 PO
S 412 UL (Multi Class)									
additional WEBASTO / addizionale WEBASTO	Mercedes Benz OM457HLA Euro4	220	299	01/06	>		S 6001 NE		
2 filters / N.2 filtri	Mercedes Benz OM457HLA Euro4	220	299	01/06	>		S 4378 NR		
power steering / servosterzo	Mercedes Benz OM457HLA Euro4	220	299	01/06	>	S 5036 PE			S 3081 PO
S 412 UL (Multi Class)									
	Mercedes Benz OM457HLA Euro4	260	354	01/06	>		S 6001 NE		



...KAESSBOHRER - buses/autobus

additional WEBASTO / addizionale WEBASTO	Mercedes Benz OM457HLA Euro4	260	354	01/06	>		S 4378 NR		
2 filters / N.2 filtri	Mercedes Benz OM457HLA Euro4	260	354	01/06	>	S 5036 PE			
power steering / servosterzo	Mercedes Benz OM457HLA Euro4	260	354	01/06	>				S 3081 PO
S 415 GT (Comfort Class)	Mercedes Benz OM457HLA Euro4/5/EEV	220	299	10/03	>		S 6001 NE	S 7573 A	
additional WEBASTO / addizionale WEBASTO	Mercedes Benz OM457HLA Euro4/5/EEV	220	299	10/03	>		S 4378 NR		
additional filter compressor filter / filtro supplementare filtro compressore	Mercedes Benz OM457HLA Euro4/5/EEV	220	299	10/03	>			S 7A14 A	
2 filters / N.2 filtri	Mercedes Benz OM457HLA Euro4/5/EEV	220	299	10/03	>	S 5036 PE			
power steering / servosterzo	Mercedes Benz OM457HLA Euro4/5/EEV	220	299	10/03	>				S 3081 PO
S 415 GT-HD (Comfort Class)	Mercedes Benz OM457LA Euro4/5/EEV	260	354	10/03	>	S 5062 PE	S 6001 NE		
additional WEBASTO / addizionale WEBASTO	Mercedes Benz OM457LA Euro4/5/EEV	260	354	10/03	>		S 4378 NR		
dryer filter / filtro essiccatore	Mercedes Benz OM457LA Euro4/5/EEV	260	354	10/03	>				S 7259 A
additional filter compressor filter / filtro supplementare filtro compressore	Mercedes Benz OM457LA Euro4/5/EEV	260	354	10/03	>			S 7A14 A	
5 filters / N.5 filtri	Mercedes Benz OM457LA Euro4/5/EEV	260	354	10/03	>			S 7695 A	
power steering / servosterzo	Mercedes Benz OM457LA Euro4/5/EEV	260	354	10/03	>				S 3081 PO
S 415 GT-HD (Comfort Class)	Mercedes Benz OM457LA Euro4/5/EEV	310	420	10/03	>	S 5062 PE	S 6001 NE		
additional WEBASTO / addizionale WEBASTO	Mercedes Benz OM457LA Euro4/5/EEV	310	420	10/03	>		S 4378 NR		
dryer filter / filtro essiccatore	Mercedes Benz OM457LA Euro4/5/EEV	310	420	10/03	>				S 7259 A
additional filter compressor filter / filtro supplementare filtro compressore	Mercedes Benz OM457LA Euro4/5/EEV	310	420	10/03	>			S 7A14 A	
5 filters / N.5 filtri	Mercedes Benz OM457LA Euro4/5/EEV	310	420	10/03	>			S 7695 A	
power steering / servosterzo	Mercedes Benz OM457LA Euro4/5/EEV	310	420	10/03	>				S 3081 PO
S 415 GT-HD (Comfort Class)	Mercedes Benz OM457LA Euro6/EEV	335	455	04/10	>	S 5062 PE	S 6001 NE		
additional WEBASTO / addizionale WEBASTO	Mercedes Benz OM457LA Euro6/EEV	335	455	04/10	>		S 4378 NR		
with automatic gearbox VOITH DIWA 864.3E / con cambio automatico VOITH DIWA 864.3E	Mercedes Benz OM457LA Euro6/EEV	335	455	04/10	>				S 5663 PO
additional filter compressor filter / filtro supplementare filtro compressore	Mercedes Benz OM457LA Euro6/EEV	335	455	04/10	>			S 7A14 A	
prefilter PARKER-RACOR / prefiltro PARKER-RACOR	Mercedes Benz OM457LA Euro6/EEV	335	455	04/10	>		S 4121 NR		
power steering / servosterzo	Mercedes Benz OM457LA Euro6/EEV	335	455	04/10	>				S 3081 PO
S 415 H (Multi Class)	Mercedes Benz OM470LA	265	360	09/13	>		S 4378 NR		
additional Webasto Thermo 300/350 / addizionale Webasto Thermo 300/350	Mercedes Benz OM470LA	265	360	09/13	>				S 5663 PO
with automatic gearbox VOITH DIWA 864.3E / con cambio automatico VOITH DIWA 864.3E	Mercedes Benz OM470LA	265	360	09/13	>				
additional filter compressor filter / filtro supplementare filtro compressore	Mercedes Benz OM470LA	265	360	09/13	>			S 7A14 A	
power steering / servosterzo	Mercedes Benz OM470LA	265	360	09/13	>				S 3081 PO
S 415 H (Multi Class)	Mercedes Benz OM470LA	290	394	09/13	>		S 4378 NR		
additional Webasto Thermo 300/350 / addizionale Webasto Thermo 300/350	Mercedes Benz OM470LA	290	394	09/13	>				S 5663 PO
with automatic gearbox VOITH DIWA 864.3E / con cambio automatico VOITH DIWA 864.3E	Mercedes Benz OM470LA	290	394	09/13	>				
additional filter compressor filter / filtro supplementare filtro compressore	Mercedes Benz OM470LA	290	394	09/13	>			S 7A14 A	
power steering / servosterzo	Mercedes Benz OM470LA	290	394	09/13	>				S 3081 PO
S 415 HD (Top Class)	Mercedes Benz OM457LA	260	354	03/01	>	S 5062 PE	S 6001 NE		
additional WEBASTO / addizionale WEBASTO	Mercedes Benz OM457LA	260	354	03/01	>		S 4378 NR		
dryer filter / filtro essiccatore	Mercedes Benz OM457LA	260	354	03/01	>				S 7259 A
power steering / servosterzo	Mercedes Benz OM457LA	260	354	03/01	>				S 3081 PO
S 415 HD (Top Class)	Mercedes Benz OM502LA	350	477	09/01	>	S 5006 PE	S 6001 NE		
additional WEBASTO / addizionale WEBASTO	Mercedes Benz OM502LA	350	477	09/01	>		S 4378 NR		
dryer filter / filtro essiccatore	Mercedes Benz OM502LA	350	477	09/01	>				S 7259 A
power steering / servosterzo	Mercedes Benz OM502LA	350	477	09/01	>				S 3081 PO
S 415 HDH (Top Class)	Mercedes Benz OM457LA	310	422	03/01	>	S 5062 PE	S 6001 NE		
additional WEBASTO / addizionale WEBASTO	Mercedes Benz OM457LA	310	422	03/01	>		S 4378 NR		
dryer filter / filtro essiccatore	Mercedes Benz OM457LA	310	422	03/01	>				S 7259 A
power steering / servosterzo	Mercedes Benz OM457LA	310	422	03/01	>				S 3081 PO
S 415 HDH (Top Class)	Mercedes Benz OM502LA	350	477	09/01	>	S 5006 PE	S 6001 NE		
additional WEBASTO / addizionale WEBASTO	Mercedes Benz OM502LA	350	477	09/01	>		S 4378 NR		
dryer filter / filtro essiccatore	Mercedes Benz OM502LA	350	477	09/01	>				S 7259 A
power steering / servosterzo	Mercedes Benz OM502LA	350	477	09/01	>				S 3081 PO
S 415 NF (Multi Class)	Mercedes Benz OM457LA Euro4/5/EEV	220	299	09/06	>		S 6001 NE		
additional WEBASTO / addizionale WEBASTO	Mercedes Benz OM457LA Euro4/5/EEV	220	299	09/06	>		S 4378 NR		
with automatic gearbox VOITH DIWA 864.3E / con cambio automatico VOITH DIWA 864.3E	Mercedes Benz OM457LA Euro4/5/EEV	220	299	09/06	>				S 5663 PO
with air-conditioner WEBASTO Atmosphere, N.6 PCS / con climatizzatore WEBASTO Atmosphere, N.6 PZ	Mercedes Benz OM457LA Euro4/5/EEV	220	299	09/06	>				S 3081 C
with manual pump prefilter / con pompa manuale prefiltro	Mercedes Benz OM457LA Euro4/5/EEV	220	299	09/06	>		S 6089 NE		
dryer filter / filtro essiccatore	Mercedes Benz OM457LA Euro4/5/EEV	220	299	09/06	>				S 7A66 A
2 filters / N.2 filtri	Mercedes Benz OM457LA Euro4/5/EEV	220	299	09/06	>	S 5036 PE			
prefilter PARKER-RACOR / prefiltro PARKER-RACOR	Mercedes Benz OM457LA Euro4/5/EEV	220	299	09/06	>		S 4472 NR		
power steering / servosterzo	Mercedes Benz OM457LA Euro4/5/EEV	220	299	09/06	>				S 3081 PO
S 415 UL (Multi Class)	Mercedes Benz OM457HLA Euro4	220	299	01/06	>		S 6001 NE		
additional WEBASTO / addizionale WEBASTO	Mercedes Benz OM457HLA Euro4	220	299	01/06	>		S 4378 NR		
2 filters / N.2 filtri	Mercedes Benz OM457HLA Euro4	220	299	01/06	>	S 5036 PE			
power steering / servosterzo	Mercedes Benz OM457HLA Euro4	220	299	01/06	>				S 3081 PO
S 415 UL (Multi Class)	Mercedes Benz OM457HLA Euro4	260	354	01/06	>		S 6001 NE		
additional WEBASTO / addizionale WEBASTO	Mercedes Benz OM457HLA Euro4	260	354	01/06	>		S 4378 NR		





...KAESSBOHRER - buses/autobus

K



2 filters / N.2 filtri	Mercedes Benz OMA57HLA Euro4	260	354	01/06	>	S 5036 PE			
power steering / servosterzo	Mercedes Benz OMA57HLA Euro4	260	354	01/06	>				S 3081 PO
S 416 GT (Comfort Class)	Mercedes Benz OMA57HLA Euro4/5/EEV	220	299	10/03	>		S 6001 NE	S 7573 A	
additional WEBASTO / addizionale WEBASTO	Mercedes Benz OMA57HLA Euro4/5/EEV	220	299	10/03	>		S 4378 NR		
additional filter compressor filter / filtro supplementare filtro compressore	Mercedes Benz OMA57HLA Euro4/5/EEV	220	299	10/03	>			S 7A14 A	
2 filters / N.2 filtri	Mercedes Benz OMA57HLA Euro4/5/EEV	220	299	10/03	>	S 5036 PE			
prefilter PARKER-RACOR / prefiltro PARKER-RACOR	Mercedes Benz OMA57HLA Euro4/5/EEV	220	299	10/03	>		S 4121 NR		
power steering / servosterzo	Mercedes Benz OMA57HLA Euro4/5/EEV	220	299	10/03	>				S 3081 PO
S 416 GT-HD (Comfort Class)	Mercedes Benz OMA57LA Euro4/5/EEV	310	422	10/03	>	S 5062 PE	S 6001 NE		
additional WEBASTO / addizionale WEBASTO	Mercedes Benz OMA57LA Euro4/5/EEV	310	422	10/03	>		S 4378 NR		
dryer filter / filtro essiccatore	Mercedes Benz OMA57LA Euro4/5/EEV	310	422	10/03	>				S 7259 A
additional filter compressor filter / filtro supplementare filtro compressore	Mercedes Benz OMA57LA Euro4/5/EEV	310	422	10/03	>			S 7A14 A	
5 filters / N.5 filtri	Mercedes Benz OMA57LA Euro4/5/EEV	310	422	10/03	>			S 7695 A	
prefilter PARKER-RACOR / prefiltro PARKER-RACOR	Mercedes Benz OMA57LA Euro4/5/EEV	310	422	10/03	>		S 4121 NR		
power steering / servosterzo	Mercedes Benz OMA57LA Euro4/5/EEV	310	422	10/03	>				S 8790 PO
S 416 GT-HD (Comfort Class)	Mercedes Benz OMA57LA Euro6/EEV	335	455	04/10	>	S 5062 PE	S 6001 NE		
additional WEBASTO / addizionale WEBASTO	Mercedes Benz OMA57LA Euro6/EEV	335	455	04/10	>		S 4378 NR		
with automatic gearbox VOITH DIWA 864.3E / con cambio automatico VOITH DIWA 864.3E	Mercedes Benz OMA57LA Euro6/EEV	335	455	04/10	>			S 7A14 A	S 5663 PO
additional filter compressor filter / filtro supplementare filtro compressore	Mercedes Benz OMA57LA Euro6/EEV	335	455	04/10	>		S 4121 NR		
prefilter PARKER-RACOR / prefiltro PARKER-RACOR	Mercedes Benz OMA57LA Euro6/EEV	335	455	04/10	>				S 8790 PO
power steering / servosterzo	Mercedes Benz OMA57LA Euro6/EEV	335	455	04/10	>				
S 416 GT-HD2 (Comfort Class)	Mercedes Benz OMA57LA Euro4/5/EEV	315	428	10/03	>	S 5062 PE	S 6001 NE		
additional WEBASTO / addizionale WEBASTO	Mercedes Benz OMA57LA Euro4/5/EEV	315	428	10/03	>		S 4378 NR		
dryer filter / filtro essiccatore	Mercedes Benz OMA57LA Euro4/5/EEV	315	428	10/03	>				S 7259 A
additional filter compressor filter / filtro supplementare filtro compressore	Mercedes Benz OMA57LA Euro4/5/EEV	315	428	10/03	>			S 7A14 A	
5 filters / N.5 filtri	Mercedes Benz OMA57LA Euro4/5/EEV	315	428	10/03	>			S 7695 A	
prefilter PARKER-RACOR / prefiltro PARKER-RACOR	Mercedes Benz OMA57LA Euro4/5/EEV	315	428	10/03	>		S 4121 NR		
power steering / servosterzo	Mercedes Benz OMA57LA Euro4/5/EEV	315	428	10/03	>				S 3081 PO
S 416 GT-HD2 (Comfort Class)	Mercedes Benz OMA57LA Euro6/EEV	335	455	04/10	>	S 5062 PE	S 6001 NE		
additional WEBASTO / addizionale WEBASTO	Mercedes Benz OMA57LA Euro6/EEV	335	455	04/10	>		S 4378 NR		
with automatic gearbox VOITH DIWA 864.3E / con cambio automatico VOITH DIWA 864.3E	Mercedes Benz OMA57LA Euro6/EEV	335	455	04/10	>				S 5663 PO
additional filter compressor filter / filtro supplementare filtro compressore	Mercedes Benz OMA57LA Euro6/EEV	335	455	04/10	>			S 7A14 A	
prefilter PARKER-RACOR / prefiltro PARKER-RACOR	Mercedes Benz OMA57LA Euro6/EEV	335	455	04/10	>		S 4121 NR		
power steering / servosterzo	Mercedes Benz OMA57LA Euro6/EEV	335	455	04/10	>				S 8790 PO
S 416 H (Multi Class)									
additional Webasto Thermo 300/350 / addizionale Webasto Thermo 300/350	Mercedes Benz OM470LA	265	360	09/13	>		S 4378 NR		
with automatic gearbox VOITH DIWA 864.3E / con cambio automatico VOITH DIWA 864.3E	Mercedes Benz OM470LA	265	360	09/13	>				S 5663 PO
additional filter compressor filter / filtro supplementare filtro compressore	Mercedes Benz OM470LA	265	360	09/13	>			S 7A14 A	
power steering / servosterzo	Mercedes Benz OM470LA	265	360	09/13	>				S 3081 PO
S 416 H (Multi Class)									
additional Webasto Thermo 300/350 / addizionale Webasto Thermo 300/350	Mercedes Benz OM470LA	290	394	09/13	>		S 4378 NR		
with automatic gearbox VOITH DIWA 864.3E / con cambio automatico VOITH DIWA 864.3E	Mercedes Benz OM470LA	290	394	09/13	>				S 5663 PO
additional filter compressor filter / filtro supplementare filtro compressore	Mercedes Benz OM470LA	290	394	09/13	>			S 7A14 A	
power steering / servosterzo	Mercedes Benz OM470LA	290	394	09/13	>				S 3081 PO
S 416 HDH (Top Class)	Mercedes Benz OM502LA	320	435	10/03	>	S 5006 PE	S 6001 NE		
additional WEBASTO / addizionale WEBASTO	Mercedes Benz OM502LA	320	435	10/03	>		S 4378 NR		
dryer filter / filtro essiccatore	Mercedes Benz OM502LA	320	435	10/03	>				S 7259 A
power steering / servosterzo	Mercedes Benz OM502LA	320	435	10/03	>				S 3081 PO
S 416 HDH (Top Class)	Mercedes Benz OM502LA	350	477	10/04	>	S 5006 PE	S 6001 NE		
additional WEBASTO / addizionale WEBASTO	Mercedes Benz OM502LA	350	477	10/04	>		S 4378 NR		
dryer filter / filtro essiccatore	Mercedes Benz OM502LA	350	477	10/04	>				S 7259 A
power steering / servosterzo	Mercedes Benz OM502LA	350	477	10/04	>				S 3081 PO
S 416 NF (Multi Class)	Mercedes Benz OMA57HLA Euro4/5/EEV	220	299	09/06	>		S 6001 NE		
additional WEBASTO / addizionale WEBASTO	Mercedes Benz OMA57HLA Euro4/5/EEV	220	299	09/06	>		S 4378 NR		
with automatic gearbox VOITH DIWA 864.3E / con cambio automatico VOITH DIWA 864.3E	Mercedes Benz OMA57HLA Euro4/5/EEV	220	299	09/06	>				S 5663 PO
with air-conditioner WEBASTO Atmosphere, N.6 PCS / con climatizzatore WEBASTO Atmosphere, N.6 PZ	Mercedes Benz OMA57HLA Euro4/5/EEV	220	299	09/06	>				S 3081 C
with manual pump prefilter / con pompa manuale prefiltro	Mercedes Benz OMA57HLA Euro4/5/EEV	220	299	09/06	>		S 6089 NE		
dryer filter / filtro essiccatore	Mercedes Benz OMA57HLA Euro4/5/EEV	220	299	09/06	>				S 7A66 A
2 filters / N.2 filtri	Mercedes Benz OMA57HLA Euro4/5/EEV	220	299	09/06	>	S 5036 PE			
prefilter PARKER-RACOR / prefiltro PARKER-RACOR	Mercedes Benz OMA57HLA Euro4/5/EEV	220	299	09/06	>		S 4472 NR		
power steering / servosterzo	Mercedes Benz OMA57HLA Euro4/5/EEV	220	299	09/06	>				S 3081 PO
S 417 GT-HD (Comfort Class)	Mercedes Benz OMA57LA Euro4/5/EEV	315	428	10/03	>	S 5062 PE	S 6001 NE		
additional WEBASTO / addizionale WEBASTO	Mercedes Benz OMA57LA Euro4/5/EEV	315	428	10/03	>		S 4378 NR		
dryer filter / filtro essiccatore	Mercedes Benz OMA57LA Euro4/5/EEV	315	428	10/03	>				S 7259 A
additional filter compressor filter / filtro supplementare filtro compressore	Mercedes Benz OMA57LA Euro4/5/EEV	315	428	10/03	>			S 7A14 A	
5 filters / N.5 filtri	Mercedes Benz OMA57LA Euro4/5/EEV	315	428	10/03	>			S 7695 A	
prefilter PARKER-RACOR / prefiltro PARKER-RACOR	Mercedes Benz OMA57LA Euro4/5/EEV	315	428	10/03	>		S 4121 NR		



...KAESSBOHRER - buses/autobus

power steering / servosterzo	Mercedes Benz OM457LA Euro4/5/EEV	315	428	10/03	>				S 8790 PO
S 417 GT-HD (Comfort Class)	Mercedes Benz OM457LA Euro6/EEV	335	455	04/10	>	S 5062 PE	S 6001 NE		
additional WEBASTO / addizionale WEBASTO	Mercedes Benz OM457LA Euro6/EEV	335	455	04/10	>		S 4378 NR		
with automatic gearbox VOITH DIWA 864.3E / con cambio automatico VOITH DIWA 864.3E	Mercedes Benz OM457LA Euro6/EEV	335	455	04/10	>			S 7A14 A	S 5663 PO
additional filter compressor filter / filtro supplementare filtro compressore	Mercedes Benz OM457LA Euro6/EEV	335	455	04/10	>				
prefilter PARKER-RACOR / prefiltro PARKER-RACOR	Mercedes Benz OM457LA Euro6/EEV	335	455	04/10	>		S 4121 NR		
power steering / servosterzo	Mercedes Benz OM457LA Euro6/EEV	335	455	04/10	>				S 8790 PO
S 417 HDH (Top Class)	Mercedes Benz OM502LA	320	435	03/01	>	S 5006 PE	S 6001 NE		
dryer filter / filtro essiccatore	Mercedes Benz OM502LA	320	435	03/01	>				S 7259 A
power steering / servosterzo	Mercedes Benz OM502LA	320	435	03/01	>	S 3081 PO	S 6001 NE		
S 417 HDH (Top Class)	Mercedes Benz OM502LA	350	477	09/01	>	S 5006 PE	S 6001 NE		
dryer filter / filtro essiccatore	Mercedes Benz OM502LA	350	477	09/01	>				S 7259 A
power steering / servosterzo	Mercedes Benz OM502LA	350	477	09/01	>	S 3081 PO	S 6001 NE		
S 417 TC (Top Class EPA10)									
with automatic gearbox VOITH DIWA 864.3E / con cambio automatico VOITH DIWA 864.3E	Mercedes Benz OM471LA	336	457	04/10	>			S 7A14 A	S 5663 PO
additional filter compressor filter / filtro supplementare filtro compressore	Mercedes Benz OM471LA	336	457	04/10	>				
power steering / servosterzo	Mercedes Benz OM471LA	336	457	04/10	>				S 3081 PO
S 417 UL (Multi Class)	Mercedes Benz OM457HLA Euro4	220	299	01/06	>		S 6001 NE		
additional WEBASTO / addizionale WEBASTO	Mercedes Benz OM457HLA Euro4	220	299	01/06	>		S 4378 NR		
2 filters / N.2 filtri	Mercedes Benz OM457HLA Euro4	220	299	01/06	>	S 5036 PE			
power steering / servosterzo	Mercedes Benz OM457HLA Euro4	220	299	01/06	>				S 3081 PO
S 417 UL (Multi Class)	Mercedes Benz OM457HLA Euro4	260	354	01/06	>		S 6001 NE		
additional WEBASTO / addizionale WEBASTO	Mercedes Benz OM457HLA Euro4	260	354	01/06	>		S 4378 NR		
2 filters / N.2 filtri	Mercedes Benz OM457HLA Euro4	260	354	01/06	>	S 5036 PE			
power steering / servosterzo	Mercedes Benz OM457HLA Euro4	260	354	01/06	>				S 3081 PO
S 417 UL (Multi Class)	Mercedes Benz OM457HLA Euro4	300	408	01/06	>		S 6001 NE		
additional WEBASTO / addizionale WEBASTO	Mercedes Benz OM457HLA Euro4	300	408	01/06	>		S 4378 NR		
2 filters / N.2 filtri	Mercedes Benz OM457HLA Euro4	300	408	01/06	>	S 5036 PE			
power steering / servosterzo	Mercedes Benz OM457HLA Euro4	300	408	01/06	>				S 3081 PO
S 417 UL (Multi Class)									
additional Webasto Thermo 300/350 / addizionale Webasto Thermo 300/350	Mercedes Benz OM470LA	265	360	09/13	>		S 4378 NR		
with automatic gearbox VOITH DIWA 864.3E / con cambio automatico VOITH DIWA 864.3E	Mercedes Benz OM470LA	265	360	09/13	>			S 7A14 A	S 5663 PO
additional filter compressor filter / filtro supplementare filtro compressore	Mercedes Benz OM470LA	265	360	09/13	>				
power steering / servosterzo	Mercedes Benz OM470LA	265	360	09/13	>				S 3081 PO
S 417 UL (Multi Class)									
additional Webasto Thermo 300/350 / addizionale Webasto Thermo 300/350	Mercedes Benz OM470LA	290	394	09/13	>		S 4378 NR		
with automatic gearbox VOITH DIWA 864.3E / con cambio automatico VOITH DIWA 864.3E	Mercedes Benz OM470LA	290	394	09/13	>			S 7A14 A	S 5663 PO
additional filter compressor filter / filtro supplementare filtro compressore	Mercedes Benz OM470LA	290	394	09/13	>				
power steering / servosterzo	Mercedes Benz OM470LA	290	394	09/13	>				S 3081 PO
S 419 GT-HD (Comfort Class)	Mercedes Benz OM502LA Euro6/EEV	350	476	09/08	>	S 5006 PE	S 6001 NE		
additional WEBASTO / addizionale WEBASTO	Mercedes Benz OM502LA Euro6/EEV	350	476	09/08	>		S 4378 NR		
dryer filter / filtro essiccatore	Mercedes Benz OM502LA Euro6/EEV	350	476	09/08	>				S 7A66 A
additional filter compressor filter / filtro supplementare filtro compressore	Mercedes Benz OM502LA Euro6/EEV	350	476	09/08	>			S 7A14 A	
5 filters / N.5 filtri	Mercedes Benz OM502LA Euro6/EEV	350	476	09/08	>			S 7F31 A	
prefilter PARKER-RACOR / prefiltro PARKER-RACOR	Mercedes Benz OM502LA Euro6/EEV	350	476	09/08	>		S 4121 NR		
S 419 UL (Multi Class)	Mercedes Benz OM457HLA Euro4	260	354	01/06	>		S 6001 NE		
additional WEBASTO / addizionale WEBASTO	Mercedes Benz OM457HLA Euro4	260	354	01/06	>		S 4378 NR		
2 filters / N.2 filtri	Mercedes Benz OM457HLA Euro4	260	354	01/06	>	S 5036 PE			
power steering / servosterzo	Mercedes Benz OM457HLA Euro4	260	354	01/06	>				S 3081 PO
S 419 UL (Multi Class)	Mercedes Benz OM457HLA Euro4	300	408	01/06	>		S 6001 NE		
additional WEBASTO / addizionale WEBASTO	Mercedes Benz OM457HLA Euro4	300	408	01/06	>		S 4378 NR		
2 filters / N.2 filtri	Mercedes Benz OM457HLA Euro4	300	408	01/06	>	S 5036 PE			
power steering / servosterzo	Mercedes Benz OM457HLA Euro4	300	408	01/06	>				S 3081 PO
S 419 UL (Multi Class)									
additional Webasto Thermo 300/350 / addizionale Webasto Thermo 300/350	Mercedes Benz OM470LA	290	394	09/13	>		S 4378 NR		
with automatic gearbox VOITH DIWA 864.3E / con cambio automatico VOITH DIWA 864.3E	Mercedes Benz OM470LA	290	394	09/13	>			S 7A14 A	S 5663 PO
additional filter compressor filter / filtro supplementare filtro compressore	Mercedes Benz OM470LA	290	394	09/13	>				
power steering / servosterzo	Mercedes Benz OM470LA	290	394	09/13	>				S 3081 PO
S 431 DT (Top Class)	Mercedes Benz OM502LA	320	435	06/02	>	S 5006 PE	S 6001 NE		
additional WEBASTO / addizionale WEBASTO	Mercedes Benz OM502LA	320	435	06/02	>		S 4378 NR		
dryer filter / filtro essiccatore	Mercedes Benz OM502LA	320	435	06/02	>				S 7259 A
5 filters / N.5 filtri	Mercedes Benz OM502LA	320	435	06/02	>	08/08		S 7695 A	
5 filters / N.5 filtri	Mercedes Benz OM502LA	320	435	09/08	>			S 7F31 A	
prefilter PARKER-RACOR / prefiltro PARKER-RACOR	Mercedes Benz OM502LA	320	435	06/02	>		S 4121 NR		
power steering ZF 766.387 / servosterzo ZF 766.387	Mercedes Benz OM502LA	320	435	06/02	>				S 3081 PO
power steering ZF 766.388 / servosterzo ZF 766.388	Mercedes Benz OM502LA	320	435	06/02	>				S 8790 PO
S 431 DT (Top Class)	Mercedes Benz OM502LA	350	475	06/02	>	S 5006 PE	S 6001 NE		





kW HP



...KAESSBOHRER - buses/autobus

additional WEBASTO / addizionale WEBASTO	Mercedes Benz OM502LA	350	475	06/02	>		S 4378 NR		S 7259 A
dryer filter / filtro essiccatore	Mercedes Benz OM502LA	350	475	06/02	>				
5 filters / N.5 filtri	Mercedes Benz OM502LA	350	475	06/02	>	08/08		S 7695 A	
5 filters / N.5 filtri	Mercedes Benz OM502LA	350	475	09/08	>			S 7F31 A	
prefilter PARKER-RACOR / prefiltro PARKER-RACOR	Mercedes Benz OM502LA	350	475	06/02	>		S 4121 NR		
power steering ZF 766.387 / servosterzo ZF 766.387	Mercedes Benz OM502LA	350	475	06/02	>				S 3081 PO
power steering ZF 766.388 / servosterzo ZF 766.388	Mercedes Benz OM502LA	350	475	06/02	>				S 8790 PO
S 431 DT (Top Class)									
additional WEBASTO / addizionale WEBASTO	Mercedes Benz OM502LA	370	503	06/02	>		S 5006 PE	S 6001 NE	
dryer filter / filtro essiccatore	Mercedes Benz OM502LA	370	503	06/02	>			S 4378 NR	S 7259 A
5 filters / N.5 filtri	Mercedes Benz OM502LA	370	503	06/02	>	08/08		S 7695 A	
5 filters / N.5 filtri	Mercedes Benz OM502LA	370	503	09/08	>			S 7F31 A	
prefilter PARKER-RACOR / prefiltro PARKER-RACOR	Mercedes Benz OM502LA	370	503	06/02	>		S 4121 NR		
power steering ZF 766.387 / servosterzo ZF 766.387	Mercedes Benz OM502LA	370	503	06/02	>				S 3081 PO
power steering ZF 766.388 / servosterzo ZF 766.388	Mercedes Benz OM502LA	370	503	06/02	>				S 8790 PO
S 500 Serie									
S 515 HD (Comfort Class)									
additional filter compressor filter / filtro supplementare filtro compressore	Mercedes Benz OM470LA	315	428	09/12	>			S 7A14 A	
additional filter Spheros Thermo / filtro supplementare Spheros Thermo	Mercedes Benz OM470LA	315	428	09/12	>		S 4378 NR		
S 515 HDH (Top Class)									
additional filter Spheros Thermo / filtro supplementare Spheros Thermo	Mercedes Benz OM471LA	350	476	09/13	>		S 4378 NR		
S 515 HDH (Top Class)									
additional filter Spheros Thermo / filtro supplementare Spheros Thermo	Mercedes Benz OM471LA	375	510	09/13	>		S 4378 NR		
S 516 HD (Comfort Class)									
additional filter compressor filter / filtro supplementare filtro compressore	Mercedes Benz OM470LA	315	428	09/12	>			S 7A14 A	
additional filter Spheros Thermo / filtro supplementare Spheros Thermo	Mercedes Benz OM470LA	315	428	09/12	>		S 4378 NR		
power steering Serie 410.240 / servosterzo Serie 410.240	Mercedes Benz OM470LA	315	428	09/12	>				S 3081 PO
S 516 HD2 (Comfort Class)									
additional filter compressor filter / filtro supplementare filtro compressore	Mercedes Benz OM470LA	315	428	09/12	>			S 7A14 A	
additional filter Spheros Thermo / filtro supplementare Spheros Thermo	Mercedes Benz OM470LA	315	428	09/12	>		S 4378 NR		
power steering Serie 410.240 / servosterzo Serie 410.240	Mercedes Benz OM470LA	315	428	09/12	>				S 3081 PO
S 516 HD3 (Comfort Class)									
additional filter compressor filter / filtro supplementare filtro compressore	Mercedes Benz OM470LA	315	428	09/12	>			S 7A14 A	
additional filter Spheros Thermo / filtro supplementare Spheros Thermo	Mercedes Benz OM470LA	315	428	09/12	>		S 4378 NR		
power steering Serie 410.240 / servosterzo Serie 410.240	Mercedes Benz OM470LA	315	428	09/12	>				S 3081 PO
S 516 HDH (Top Class)									
additional filter Spheros Thermo / filtro supplementare Spheros Thermo	Mercedes Benz OM471LA	350	476	09/13	>		S 4378 NR		
S 516 HDH (Top Class)									
additional filter Spheros Thermo / filtro supplementare Spheros Thermo	Mercedes Benz OM471LA	375	510	09/13	>		S 4378 NR		
S 517 HD (Comfort Class)									
additional filter compressor filter / filtro supplementare filtro compressore	Mercedes Benz OM470LA	315	428	09/12	>			S 7A14 A	
additional filter Spheros Thermo / filtro supplementare Spheros Thermo	Mercedes Benz OM470LA	315	428	09/12	>		S 4378 NR		
power steering / servosterzo	Mercedes Benz OM470LA	315	428	09/12	>				S 3081 PO
S 517 HDH (Top Class)									
additional filter Spheros Thermo / filtro supplementare Spheros Thermo	Mercedes Benz OM471LA	350	476	09/13	>		S 4378 NR		
S 517 HDH (Top Class)									
additional filter Spheros Thermo / filtro supplementare Spheros Thermo	Mercedes Benz OM471LA	375	510	09/13	>		S 4378 NR		
S 6 Serie									
S 6									
2nd passage / 2.passaggio							S 0530 PO	S 0201 N	S 1411 N
S 7 Serie									
S 7									
1st passage / 1.passaggio	Henschel 6R1013							S 0201 N	
2nd passage / 2.passaggio	Henschel 6R1013							S 1411 N	
S 80 Serie									
S 80									
some / alcuni	Henschel 552-5R1112-14K			04/70	>	12/73	S 7600 R	S 5400 NR	S 0060 A
	Henschel 552-5R1112-14K			04/70	>	12/73	S 7600 R	S 5400 NR	S 7839 A
S 80									
some / alcuni	Henschel 5R1112-13K			04/70	>	12/73	S 7600 R	S 5400 NR	S 0060 A
	Henschel 5R1112-13K			04/70	>	12/73	S 7600 R	S 5400 NR	S 7839 A
S 80									
2nd passage / 2.passaggio	MAN D2566						S 7260 PO	S 0101 N	
	MAN D2566							S 7411 N	
S 80 E									
some / alcuni	Henschel 5R1112-13K			04/70	>	12/73	S 7600 R	S 5400 NR	S 0060 A
	Henschel 5R1112-13K			04/70	>	12/73	S 7600 R	S 5400 NR	S 7839 A
S 9 Serie									
S 9									
2nd passage / 2.passaggio							S 0530 PO	S 0201 N	S 1411 N
SG 100 Serie									



KW HP



...KAESSBOHRER - buses/autobus

SG 175	Buessing U11			01/69 > 06/76		S 0201 N		
2nd passage / 2.passaggio	Buessing U11			01/69 > 06/76		S 1411 N		
paper / in carta	Buessing U11			01/69 > 06/76		S 0201 N		
power steering / servosterzo	Buessing U11			01/69 > 06/76				S 8790 PO
SG 175	Buessing U11D			01/69 > 06/76		S 0201 N		
2nd passage / 2.passaggio	Buessing U11D			01/69 > 06/76		S 1411 N		
power steering / servosterzo	Buessing U11D			01/69 > 06/76				S 8790 PO
SG 175	Henschel 6U1215			01/69 > 06/76	S 0530 PO	S 0201 N		
2nd passage / 2.passaggio	Henschel 6U1215			01/69 > 06/76		S 1411 N		
power steering / servosterzo	Henschel 6U1215			01/69 > 06/76				S 8790 PO
SG 175 L	Buessing U11			01/69 > 06/76		S 0201 N		
2nd passage / 2.passaggio	Buessing U11			01/69 > 06/76		S 1411 N		
paper / in carta	Buessing U11			01/69 > 06/76		S 0201 N		
power steering / servosterzo	Buessing U11			01/69 > 06/76				S 8790 PO
SG 175 L	Buessing U11D			01/69 > 06/76		S 0201 N		
2nd passage / 2.passaggio	Buessing U11D			01/69 > 06/76		S 1411 N		
power steering / servosterzo	Buessing U11D			01/69 > 06/76				S 8790 PO
SG 175 L	Henschel 6U1215			01/69 > 06/76	S 0530 PO	S 0201 N		
2nd passage / 2.passaggio	Henschel 6U1215			01/69 > 06/76		S 1411 N		
power steering / servosterzo	Henschel 6U1215			01/69 > 06/76				S 8790 PO
SG 180	Buessing U12D			01/73 > 04/75		S 0201 N	S 7028 A	
2nd passage / 2.passaggio	Buessing U12D			01/73 > 04/75		S 1411 N		
SG 180	MAN D2566			07/76 > 12/85	S 7260 PO	S 0101 N		
2nd passage / 2.passaggio	MAN D2566			07/76 > 12/85		S 7411 N		
SG 180	MAN D2566 MUM			07/76 > 12/85	S 7260 PO	S 0101 N		
2nd passage / 2.passaggio	MAN D2566 MUM			07/76 > 12/85		S 7411 N		
SG 180	Mercedes Benz OM407H			01/69 > 12/85	S 7261 PO	S 2162 N	S 2650 A	
power steering / servosterzo	Mercedes Benz OM407H			01/69 > 12/85				S 8790 PO
SG 180 UE	Buessing U12D			01/73 > 04/75		S 0201 N	S 7028 A	
2nd passage / 2.passaggio	Buessing U12D			01/73 > 04/75		S 1411 N		
SG 200 Serie								
SG 219 SL	MAN D2566 MUH			09/84 > 09/85	S 7260 PO	S 1411 N	S 2650 A	
power steering / servosterzo	MAN D2566 MUH			09/84 > 09/85				S 3081 PO
SG 219 SL	MAN D2866 TUH			09/85 >	S 7260 PO	S 1411 N	S 1050 A	
power steering / servosterzo	MAN D2866 TUH			09/85 >				S 3081 PO
SG 219 SL	Mercedes Benz OM407H			09/84 > 09/85	S 7261 PO	S 2162 N	S 0450 A	
power steering / servosterzo	Mercedes Benz OM407H			09/84 > 09/85				S 3081 PO
SG 219 SL	Mercedes Benz OM407HA			09/84 > 09/85	S 7261 PO	S 2162 N	S 0450 A	
power steering / servosterzo	Mercedes Benz OM407HA			09/84 > 09/85				S 3081 PO
SG 219 SL	Mercedes Benz OM427H			09/85 >	S 7261 PO	S 2162 N	S 0450 A	
power steering / servosterzo	Mercedes Benz OM427H			09/85 >				S 3081 PO
SG 219 SL	Mercedes Benz OM427HA			09/85 >	S 7261 PO	S 2162 N	S 1050 A	
power steering / servosterzo	Mercedes Benz OM427HA			09/85 >				S 3081 PO
SG 221	Mercedes Benz OM407H			09/84 > 09/85	S 7261 PO	S 2162 N	S 0450 A	
power steering / servosterzo	Mercedes Benz OM407H			09/84 > 09/85				S 3081 PO
SG 221 UL	MAN D2566 MUH			09/84 > 09/85	S 7260 PO	S 1411 N	S 2650 A	
some / alcuni	MAN D2566 MUH			09/84 > 09/85	S 7260 PO	S 1411 N	S 0450 A	
power steering / servosterzo	MAN D2566 MUH			09/84 > 09/85				S 3081 PO
SG 221 UL	MAN D2866 TUH			09/85 >	S 7260 PO	S 1411 N	S 1050 A	
power steering / servosterzo	MAN D2866 TUH			09/85 >				S 3081 PO
SG 221 UL	Mercedes Benz OM407H			09/84 > 09/85	S 7261 PO	S 2162 N	S 0450 A	
power steering / servosterzo	Mercedes Benz OM407H			09/84 > 09/85				S 3081 PO
SG 221 UL	Mercedes Benz OM407HA			09/84 > 09/85	S 7261 PO	S 2162 N	S 0450 A	
power steering / servosterzo	Mercedes Benz OM407HA			09/84 > 09/85				S 3081 PO
SG 221 UL	Mercedes Benz OM422.901A			09/85 >	S 7261 PO	S 2162 N	S 1050 A	
power steering / servosterzo	Mercedes Benz OM422.901A			09/85 >				S 3081 PO
SG 221 UL	Mercedes Benz OM427H			09/85 >	S 7261 PO	S 2162 N	S 0450 A	
power steering / servosterzo	Mercedes Benz OM427H			09/85 >				S 3081 PO
SG 221 UL	Mercedes Benz OM427HA			09/85 >	S 7261 PO	S 2162 N	S 0450 A	
power steering / servosterzo	Mercedes Benz OM427HA			09/85 >				S 3081 PO
SG 300 Serie								
SG 321 UL	MAN D2866	228	311	03/95 > 12/96	S 7260 PO		S 0450 A	
	MAN D2866	228	311	01/97 > 09/01	S 7260 PO		S 7575 A	
some power steering / alcuni servosterzo	MAN D2866	228	311	03/95 > 09/01				S 8790 PO
with automatic gearbox ZF HP500 / con cambio automatico ZF HP500	MAN D2866	228	311	03/95 > 09/01				S 2234 Z
dryer filter / filtro essiccatore	MAN D2866	228	311	03/95 > 09/01				S 7259 A
2 filters / N.2 filtri	MAN D2866	228	311	03/95 > 09/01		S 4378 NR		





KW HP



...KAESSBOHRER - buses/autobus

K



power steering / servosterzo	MAN D2866	228	311	03/95	>	09/01			S 3081 PO
SG 321 UL	MAN D2866 LUH	257	350	03/95	>	12/96	S 7260 PO	S 0450 A	
	MAN D2866 LUH	257	350	01/97	>	09/01	S 7260 PO	S 7575 A	
some power steering / alcuni servosterzo	MAN D2866 LUH	257	350	03/95	>	09/01			S 8790 PO
with automatic gearbox ZF HP500 / con cambio automatico ZF HP500	MAN D2866 LUH	257	350	03/95	>	09/01			S 2234 Z
dryer filter / filtro essiccatore	MAN D2866 LUH	257	350	03/95	>	09/01			S 7259 A
2 filters / N.2 filtri	MAN D2866 LUH	257	350	03/95	>	09/01	S 4378 NR		
power steering / servosterzo	MAN D2866 LUH	257	350	03/95	>	09/01			S 3081 PO
SG 321 UL	Mercedes Benz OM447HLA	184	250	03/95	>		S 7261 PO	S 2162 N	
with automatic gearbox ZF HP500/590 / con cambio automatico ZF HP500/590	Mercedes Benz OM447HLA	184	250	03/95	>				S 2234 Z
dryer filter / filtro essiccatore	Mercedes Benz OM447HLA	184	250	03/95	>				S 7259 A
power steering / servosterzo	Mercedes Benz OM447HLA	184	250	03/95	>				S 3081 PO
SG 321 UL	Mercedes Benz OM447HLA	220	300	03/95	>	12/96	S 7261 PO	S 7431 A	
	Mercedes Benz OM447HLA	220	300	01/97	>	09/01	S 7261 PO	S 7575 A	
with automatic gearbox ZF HP500 / con cambio automatico ZF HP500	Mercedes Benz OM447HLA	220	300	03/95	>	09/01			S 2234 Z
dryer filter / filtro essiccatore	Mercedes Benz OM447HLA	220	300	03/95	>	09/01			S 7259 A
2 filters / N.2 filtri	Mercedes Benz OM447HLA	220	300	03/95	>	09/01	S 2162 N		
2 filters spin-on / N.2 filtri avvitabile	Mercedes Benz OM447HLA	220	300	03/95	>	09/01	S 4378 NR		
power steering / servosterzo	Mercedes Benz OM447HLA	220	300	03/95	>	09/01			S 3081 PO
SG 321 UL	Mercedes Benz OM447HLA	257	350	03/95	>	12/96	S 7261 PO	S 7431 A	
	Mercedes Benz OM447HLA	257	350	01/97	>	09/01	S 7261 PO	S 7575 A	
some power steering / alcuni servosterzo	Mercedes Benz OM447HLA	257	350	03/95	>	09/01			S 8790 PO
with automatic gearbox ZF HP500 / con cambio automatico ZF HP500	Mercedes Benz OM447HLA	257	350	03/95	>	09/01			S 2234 Z
dryer filter / filtro essiccatore	Mercedes Benz OM447HLA	257	350	03/95	>	09/01			S 7259 A
2 filters / N.2 filtri	Mercedes Benz OM447HLA	257	350	03/95	>	09/01	S 2162 N		
2 filters spin-on / N.2 filtri avvitabile	Mercedes Benz OM447HLA	257	350	03/95	>	09/01	S 4378 NR		
power steering / servosterzo	Mercedes Benz OM447HLA	257	350	03/95	>	09/01			S 3081 PO
SG 321 UL	Mercedes Benz OM457HLA	220	300	09/00	>			S 6001 NE	S 7573 A
some power steering / alcuni servosterzo	Mercedes Benz OM457HLA	220	300	09/00	>				S 8790 PO
dryer filter / filtro essiccatore	Mercedes Benz OM457HLA	220	300	09/00	>				S 7259 A
2 filters / N.2 filtri	Mercedes Benz OM457HLA	220	300	09/00	>		S 5036 PE		
power steering / servosterzo	Mercedes Benz OM457HLA	220	300	09/00	>				S 3081 PO

KAMAZ

trucks/autocarri

4000 Serie

4307	Cummins ISBe	103	140	09/03	>		S 0620 R	S 2220 NR		✗
dryer filter / filtro essiccatore	Cummins ISBe	103	140	09/03	>					S 7259 A
4307.1	Cummins ISBe	103	140	09/04	>		S 0620 R	S 2220 NR		✗
dryer filter / filtro essiccatore	Cummins ISBe	103	140	09/04	>					S 7259 A
4308	Cummins B5.9-180	134	182	09/03	>		S 3497 R	S 4323 NR	S 2650 A	✗
dryer filter / filtro essiccatore	Cummins B5.9-180	134	182	09/03	>					S 7259 A
prefilter UFI FILTERS / prefiltra UFI FILTERS	Cummins B5.9-180	134	182	09/03	>			S 4021 NR		
4308	Cummins ISBe	123	167	09/03	>		S 0620 R	S 2220 NR		✗
dryer filter / filtro essiccatore	Cummins ISBe	123	167	09/03	>					S 7259 A
prefilter UFI FILTERS / prefiltra UFI FILTERS	Cummins ISBe	123	167	09/03	>			S 4021 NR		
4308.1	Cummins ISBe	123	167	09/04	>		S 0620 R	S 2220 NR		✗
dryer filter / filtro essiccatore	Cummins ISBe	123	167	09/04	>					S 7259 A
prefilter UFI FILTERS / prefiltra UFI FILTERS	Cummins ISBe	123	167	09/04	>			S 4021 NR		
43114	740.11-240	176	240	01/90	>					✗
dryer filter / filtro essiccatore	740.11-240	176	240	01/90	>					S 7259 A
prefilter / prefiltra	740.11-240	176	240	05/08	>			S 4021 NR		
43114	740.13-260	191	260	01/90	>					✗
dryer filter / filtro essiccatore	740.13-260	191	260	01/90	>					S 7259 A
prefilter / prefiltra	740.13-260	191	260	05/08	>			S 4021 NR		
43114	740.31-240	176	240	01/90	>					✗
dryer filter / filtro essiccatore	740.31-240	176	240	01/90	>					S 7259 A
prefilter / prefiltra	740.31-240	176	240	05/08	>			S 4021 NR		
43118	740.13-260	191	260	01/90	>					✗
dryer filter / filtro essiccatore	740.13-260	191	260	01/90	>					S 7259 A
prefilter / prefiltra	740.13-260	191	260	05/08	>			S 4021 NR		
43118	740.30-245	180	245	01/90	>					✗
dryer filter / filtro essiccatore	740.30-245	180	245	01/90	>					S 7259 A
prefilter / prefiltra	740.30-245	180	245	05/08	>			S 4021 NR		
43118	740.30-260	191	260	01/90	>					✗
dryer filter / filtro essiccatore	740.30-260	191	260	01/90	>					S 7259 A
prefilter / prefiltra	740.30-260	191	260	05/08	>			S 4021 NR		
43253	740.31-240	176	240	01/90	>					✗

**KW HP****...KAMAZ - trucks/autocarri**

dryer filter / filtro essiccatore	740.31-240	176	240	01/90	>				S 7259 A
prefilter / prefiltrro	740.31-240	176	240	05/08	>		S 4021 NR		
43255	740.31-240	176	240	01/90	>				✗
dryer filter / filtro essiccatore	740.31-240	176	240	01/90	>				S 7259 A
prefilter / prefiltrro	740.31-240	176	240	05/08	>		S 4021 NR		
43255	Cummins B5.9-180	134	182	09/03	>	S 3497 R	S 4323 NR		✗
dryer filter / filtro essiccatore	Cummins B5.9-180	134	182	09/03	>				S 7259 A
4326	740.31-240	176	240	01/90	>				✗
dryer filter / filtro essiccatore	740.31-240	176	240	01/90	>				S 7259 A
prefilter / prefiltrro	740.31-240	176	240	05/08	>		S 4021 NR		
43261	740.11-240	176	240	01/90	>				✗
dryer filter / filtro essiccatore	740.11-240	176	240	01/90	>				S 7259 A
prefilter / prefiltrro	740.11-240	176	240	05/08	>		S 4021 NR		
43261	740.31-240	176	240	01/90	>				✗
dryer filter / filtro essiccatore	740.31-240	176	240	01/90	>				S 7259 A
prefilter / prefiltrro	740.31-240	176	240	05/08	>		S 4021 NR		
44108	740.13-260	191	260	01/90	>				✗
dryer filter / filtro essiccatore	740.13-260	191	260	01/90	>				S 7259 A
prefilter / prefiltrro	740.13-260	191	260	05/08	>		S 4021 NR		
44108	740.30-260	191	260	01/90	>				✗
dryer filter / filtro essiccatore	740.30-260	191	260	01/90	>				S 7259 A
prefilter / prefiltrro	740.30-260	191	260	05/08	>		S 4021 NR		
44108	740.51-260	191	260	01/90	>				✗
dryer filter / filtro essiccatore	740.51-260	191	260	01/90	>				S 7259 A
prefilter / prefiltrro	740.51-260	191	260	05/08	>		S 4021 NR		
44108	740.51-320	235	320	01/90	>				✗
dryer filter / filtro essiccatore	740.51-320	235	320	01/90	>				S 7259 A
prefilter / prefiltrro	740.51-320	235	320	05/08	>		S 4021 NR		
45141	740.13-260	191	260	01/90	>				✗
dryer filter / filtro essiccatore	740.13-260	191	260	01/90	>				S 7259 A
prefilter / prefiltrro	740.13-260	191	260	05/08	>		S 4021 NR		
45141	740.30-260	191	260	01/90	>				✗
dryer filter / filtro essiccatore	740.30-260	191	260	01/90	>				S 7259 A
prefilter / prefiltrro	740.30-260	191	260	05/08	>		S 4021 NR		
4911									
dryer filter / filtro essiccatore	YMZ-7B846	538	731	05/96	>				S 7259 A
prefilter / prefiltrro	YMZ-7B846	538	731	05/96	>		S 4021 NR		
5000 Serie									
5308	Cummins ISBe4-300	220	300	09/06	> 08/13	S 0620 R	S 2220 NR	S 7423 A	✗
	Cummins ISBe4-300	220	300	09/13	>	S 0620 R	S 2220 NR	S 7423 A	
dryer filter / filtro essiccatore	Cummins ISBe4-300	220	300	09/06	>				S 7259 A
inner / interno	Cummins ISBe4-300	220	300	09/06	>			S 7408 A	
5320	740.1000-300	154	210	01/76	>				✗
53205	740.11-240	176	240	01/90	> 08/13				✗
prefilter / prefiltrro	740.11-240	176	240	05/08	>		S 4021 NR		
53205	740.31-240	176	240	01/90	> 08/13				✗
prefilter / prefiltrro	740.31-240	176	240	05/08	>		S 4021 NR		
53205	740.51-320	235	320	01/90	> 08/13				✗
prefilter / prefiltrro	740.51-320	235	320	05/08	>		S 4021 NR		
53212	740.1000-310	191	260	01/80	>				✗
53215	740.11-240	176	240	01/90	>				✗
prefilter / prefiltrro	740.11-240	176	240	05/08	>		S 4021 NR		
53215	740.31-240	176	240	01/90	>				✗
prefilter / prefiltrro	740.31-240	176	240	05/08	>		S 4021 NR		
53228	740.31-240	176	240	01/90	>				✗
prefilter / prefiltrro	740.31-240	176	240	05/08	>		S 4021 NR		
53228	740.51-320	235	320	01/90	>				✗
prefilter / prefiltrro	740.51-320	235	320	05/08	>		S 4021 NR		
53229	740.31-240	176	240	01/90	>				✗
prefilter / prefiltrro	740.31-240	176	240	05/08	>		S 4021 NR		
53229	740.51-320	235	320	01/90	>				✗
prefilter / prefiltrro	740.51-320	235	320	05/08	>		S 4021 NR		
5360	740.30-260	191	260	01/90	>				✗
prefilter / prefiltrro	740.30-260	191	260	05/08	>		S 4021 NR		
5360	740.50-360	265	360	01/90	>				✗
prefilter / prefiltrro	740.50-360	265	360	05/08	>		S 4021 NR		
53605	740.30-260	191	260	01/90	>				✗



**KW HP****...KAMAZ - trucks/autocarri****K**

prefilter / prefiltrato	740.30-260	191 260	05/08 >		S 4021 NR			
53605	740.31-240	176 240	01/90 >					✗
prefilter / prefiltrato	740.31-240	176 240	05/08 >		S 4021 NR			
5410	740.1000-450	154 210	01/76 >					✗
54115	740.11-240	176 240	01/90 >					✗
prefilter / prefiltrato	740.11-240	176 240	05/08 >		S 4021 NR			
54115	740.31-240	176 240	01/90 >					✗
prefilter / prefiltrato	740.31-240	176 240	05/08 >		S 4021 NR			
54115	740.51-240	176 240	01/90 >					✗
prefilter / prefiltrato	740.51-240	176 240	05/08 >		S 4021 NR			
54115	740.51-320	235 320	01/90 >					✗
prefilter / prefiltrato	740.51-320	235 320	05/08 >		S 4021 NR			
54212	740.1000-310	191 260	01/80 >					✗
5460	740.37-400	294 400	01/90 >					✗
prefilter / prefiltrato	740.37-400	294 400	05/08 >		S 4021 NR			
5460	740.50-360	265 360	01/90 >					✗
prefilter UFI FILTERS / prefiltrato UFI FILTERS	740.50-360	265 360	05/08 >		S 4021 NR			
5460	740.63-400 Euro3	294 400	01/10 >			S 1050 A		
	740.63-400 Euro3	294 400	01/10 > 08/13					✗
some dryer filter / alcuni filtro essiccatore	740.63-400 Euro3	294 400	01/10 >				S 7A66 A	
outer DONALDSON FRG15-0112 / esterno DONALDSON FRG15-0112	740.63-400 Euro3	294 400	01/10 >			S 7421 A		
dryer filter / filtro essiccatore	740.63-400 Euro3	294 400	01/10 >					S 7259 A
inner DONALDSON FRG15-0112 / interno DONALDSON FRG15-0112	740.63-400 Euro3	294 400	01/10 >			S 7422 A		
prefilter / prefiltrato	740.63-400 Euro3	294 400	01/10 >		S 4021 NR			
power steering / servosterzo	740.63-400 Euro3	294 400	09/13 >					S 3081 PO
5460	740.64-420 Euro3	309 420	01/10 >			S 1050 A		
	740.64-420 Euro3	309 420	01/10 > 08/13					✗
some dryer filter / alcuni filtro essiccatore	740.64-420 Euro3	309 420	01/10 >				S 7A66 A	
outer DONALDSON FRG15-0112 / esterno DONALDSON FRG15-0112	740.64-420 Euro3	309 420	01/10 >			S 7421 A		
dryer filter / filtro essiccatore	740.64-420 Euro3	309 420	01/10 >					S 7259 A
inner DONALDSON FRG15-0112 / interno DONALDSON FRG15-0112	740.64-420 Euro3	309 420	01/10 >			S 7422 A		
prefilter / prefiltrato	740.64-420 Euro3	309 420	01/10 >		S 4021 NR			
power steering / servosterzo	740.64-420 Euro3	309 420	09/13 >					S 3081 PO
5480	740.63-400	294 400	01/90 >					✗
prefilter / prefiltrato	740.63-400	294 400	05/08 >		S 4021 NR			
5480	740.80-420	309 420	01/90 >					✗
prefilter / prefiltrato	740.80-420	309 420	05/08 >		S 4021 NR			
5490 (M1842)	Mercedes Benz OM457LA	315 428	09/13 >	S 5062 PE	S 6001 NE			
some dryer filter / alcuni filtro essiccatore	Mercedes Benz OM457LA	315 428	09/13 >				S 7A66 A	
outer LIWNY / esterno LIWNY	Mercedes Benz OM457LA	315 428	09/13 >			S 7421 A		
dryer filter / filtro essiccatore	Mercedes Benz OM457LA	315 428	09/13 >					S 7259 A
inner LIWNY / interno LIWNY	Mercedes Benz OM457LA	315 428	09/13 >			S 7422 A		
power steering / servosterzo	Mercedes Benz OM457LA	315 428	09/13 >					S 3081 PO
55111	740.11-240	176 240	01/90 >					✗
prefilter / prefiltrato	740.11-240	176 240	05/08 >		S 4021 NR			
55111	740.51-240	176 240	01/90 >					✗
prefilter / prefiltrato	740.51-240	176 240	05/08 >		S 4021 NR			
55111	740.51-320	235 320	01/90 >					✗
prefilter / prefiltrato	740.51-320	235 320	05/08 >		S 4021 NR			
6000 Serie								
63501	740.50-360	265 360	01/90 > 01/14					✗
dryer filter / filtro essiccatore	740.50-360	265 360	01/04 >				S 7259 A	
2 filters UFI FILTERS / N.2 filtri UFI FILTERS	740.50-360	265 360	01/04 >		S 4064 NR			
prefilter / prefiltrato	740.50-360	265 360	05/08 >		S 4021 NR			
6450	740.50-360	265 360	01/90 > 01/14					✗
dryer filter / filtro essiccatore	740.50-360	265 360	01/90 >					S 7259 A
prefilter / prefiltrato	740.50-360	265 360	05/08 >		S 4021 NR			
6460	740.50-360	265 360	01/90 > 01/14					✗
	740.50-360	265 360	02/14 >			S 1050 A		
dryer filter / filtro essiccatore	740.50-360	265 360	01/90 >			S 1050 A		S 7259 A
prefilter / prefiltrato	740.50-360	265 360	05/08 >		S 4021 NR			
6460	740.63-400 Euro3	294 400	01/90 > 01/14					✗
	740.63-400 Euro3	294 400	02/14 >			S 1050 A		
outer DONALDSON FRG15-0112 / esterno DONALDSON FRG15-0112	740.63-400 Euro3	294 400	01/10 >			S 1050 A		
dryer filter / filtro essiccatore	740.63-400 Euro3	294 400	01/90 >			S 7421 A		S 7259 A
inner DONALDSON FRG15-0112 / interno DONALDSON FRG15-0112	740.63-400 Euro3	294 400	01/10 >			S 7422 A		
prefilter / prefiltrato	740.63-400 Euro3	294 400	01/10 >		S 4021 NR			

**KW HP****...KAMAZ - trucks/autocarri**

6480	dryer filter / filtro essiccatore	740.35-400	294 400	01/90 > 01/14				
	prefilter / prefiltrato	740.35-400	294 400	05/08 >		S 4021 NR		S 7259 A
6480	dryer filter / filtro essiccatore	740.63-400	294 400	01/90 > 01/14				
	prefilter / prefiltrato	740.63-400	294 400	05/08 >		S 4021 NR		S 7259 A
65111	dryer filter / filtro essiccatore	740.13-260	191 260	01/90 > 01/14				
	prefilter / prefiltrato	740.13-260	191 260	05/08 >		S 4021 NR		S 7259 A
65111	dryer filter / filtro essiccatore	740.51-260	191 260	01/90 > 02/14				
	prefilter / prefiltrato	740.51-260	191 260	05/08 >		S 4021 NR		S 7259 A
65111	dryer filter / filtro essiccatore	740.51-320	235 320	01/90 > 01/14				
	prefilter / prefiltrato	740.51-320	235 320	05/08 >		S 4021 NR		S 7259 A
65115	dryer filter / filtro essiccatore	740.30-260	191 260	01/90 > 01/14				
	prefilter / prefiltrato	740.30-260	191 260	05/08 >		S 4021 NR		S 7259 A
65115	dryer filter / filtro essiccatore	740.51-260	191 260	01/90 > 01/14				
	prefilter / prefiltrato	740.51-260	191 260	05/08 >		S 4021 NR		S 7259 A
65115	dryer filter / filtro essiccatore	740.51-320	235 320	01/90 > 01/14				
	prefilter / prefiltrato	740.51-320	235 320	05/08 >		S 4021 NR		S 7259 A
65116	dryer filter / filtro essiccatore	740.30-260	191 260	01/90 > 01/14				
	prefilter / prefiltrato	740.30-260	191 260	05/08 >		S 4021 NR		S 7259 A
65116	dryer filter / filtro essiccatore	740.51-260	191 260	01/90 > 01/14				
	prefilter / prefiltrato	740.51-260	191 260	05/08 >		S 4021 NR		S 7259 A
65116	dryer filter / filtro essiccatore	740.51-320	235 320	01/90 > 01/14				
	prefilter / prefiltrato	740.51-320	235 320	05/08 >		S 4021 NR		S 7259 A
65117	dryer filter / filtro essiccatore	740.13-260	191 260	01/90 > 01/14				
	prefilter / prefiltrato	740.13-260	191 260	05/08 >		S 4021 NR		S 7259 A
65117	dryer filter / filtro essiccatore	740.30-260	191 260	01/90 > 01/14				
	prefilter / prefiltrato	740.30-260	191 260	05/08 >		S 4021 NR		S 7259 A
6520	dryer filter / filtro essiccatore	740.50-360	265 360	01/90 > 01/14				
	prefilter / prefiltrato	740.50-360	265 360	05/08 >		S 4021 NR		S 7259 A
6520	dryer filter / filtro essiccatore	740.51-320	235 320	01/90 > 01/14				
	prefilter / prefiltrato	740.51-320	235 320	05/08 >		S 4021 NR		S 7259 A
6520	outer DONALDSON FRG15-0112 / esterno DONALDSON FRG15-0112	740.60-360 Euro3	265 360	01/10 > 01/14			S 1050 A	
	inner DONALDSON FRG15-0112 / interno DONALDSON FRG15-0112	740.60-360 Euro3	265 360	01/10 >			S 1050 A	
	prefilter / prefiltrato	740.60-360 Euro3	265 360	01/10 >			S 7421 A	
		740.60-360 Euro3	265 360	01/10 >			S 7422 A	
6520	outer DONALDSON FRG15-0112 / esterno DONALDSON FRG15-0112	740.61-320 Euro3	235 320	01/10 > 01/14			S 1050 A	
	inner DONALDSON FRG15-0112 / interno DONALDSON FRG15-0112	740.61-320 Euro3	235 320	02/14 >			S 1050 A	
	prefilter / prefiltrato	740.61-320 Euro3	235 320	01/10 >			S 7421 A	
		740.61-320 Euro3	235 320	01/10 >			S 7422 A	
6520	dryer filter / filtro essiccatore	Cummins ISLe 350.30	257 320	09/03 > 01/14			S 1050 A	
	prefilter UFI FILTERS / prefiltrato UFI FILTERS	Cummins ISLe 350.30	257 320	02/14 >			S 1050 A	
		Cummins ISLe 350.30	257 320	09/03 >				S 7259 A
65201	dryer filter / filtro essiccatore	740.50-360	265 360	01/90 > 01/14				
	prefilter / prefiltrato	740.50-360	265 360	05/08 >		S 4021 NR		S 7259 A
65201	outer DONALDSON FRG15-0112 / esterno DONALDSON FRG15-0112	740.60-360 Euro3	265 360	01/10 > 01/14			S 1050 A	
	inner DONALDSON FRG15-0112 / interno DONALDSON FRG15-0112	740.60-360 Euro3	265 360	02/14 >			S 1050 A	
	prefilter / prefiltrato	740.60-360 Euro3	265 360	01/10 >			S 7421 A	
		740.60-360 Euro3	265 360	01/10 >			S 7422 A	
		740.60-360 Euro3	265 360	01/10 >				S 7259 A

K



KW HP



...KAMAZ - trucks/autocarri

K

65201	740.63-400 Euro3	291	400	01/10 >	01/14			S 1050 A	✗
	740.63-400 Euro3	291	400	02/14 >				S 1050 A	
	outer DONALDSON FRG15-0112 / esterno DONALDSON FRG15-0112	740.63-400 Euro3	291	400	01/10 >			S 7421 A	
	inner DONALDSON FRG15-0112 / interno DONALDSON FRG15-0112	740.63-400 Euro3	291	400	01/10 >			S 7422 A	
prefilter / prefiltrò	740.63-400 Euro3	291	400	01/10 >			S 4021 NR		
65206 (T2642)	Mercedes Benz OM457LA	315	428	02/14 >		S 5062 PE	S 6001 NE		
	some dryer filter / alcuni filtro essiccatore	Mercedes Benz OM457LA	315	428	02/14 >				S 7A66 A
	outer LIWNY / esterno LIWNY	Mercedes Benz OM457LA	315	428	02/14 >			S 7421 A	
	dryer filter / filtro essiccatore	Mercedes Benz OM457LA	315	428	02/14 >				S 7259 A
	inner LIWNY / interno LIWNY	Mercedes Benz OM457LA	315	428	02/14 >			S 7422 A	
power steering / servosterzo	Mercedes Benz OM457LA	315	428	02/14 >				S 3081 PO	
65207 (T2640)	Mercedes Benz OM457LA	315	428	02/14 >		S 5062 PE	S 6001 NE		
	some dryer filter / alcuni filtro essiccatore	Mercedes Benz OM457LA	315	428	02/14 >				S 7A66 A
	outer LIWNY / esterno LIWNY	Mercedes Benz OM457LA	315	428	02/14 >			S 7421 A	
	dryer filter / filtro essiccatore	Mercedes Benz OM457LA	315	428	02/14 >				S 7259 A
	inner LIWNY / interno LIWNY	Mercedes Benz OM457LA	315	428	02/14 >			S 7422 A	
power steering / servosterzo	Mercedes Benz OM457LA	315	428	02/14 >				S 3081 PO	
6522	740.51-320	235	320	01/90 >	01/14				✗
	dryer filter / filtro essiccatore	740.51-320	235	320	01/90 >				S 7259 A
	prefilter / prefiltrò	740.51-320	235	320	05/08 >		S 4021 NR		
6522	740.61-320 Euro3	235	320	01/10 >	01/14			S 1050 A	✗
	outer DONALDSON FRG15-0112 / esterno DONALDSON FRG15-0112	740.61-320 Euro3	235	320	02/14 >			S 1050 A	
	inner DONALDSON FRG15-0112 / interno DONALDSON FRG15-0112	740.61-320 Euro3	235	320	01/10 >			S 7421 A	
	prefilter / prefiltrò	740.61-320 Euro3	235	320	01/10 >			S 7422 A	
65221	dryer filter / filtro essiccatore	740.632-400 Euro4	294	400	02/13 >				S 7259 A
	2 filters assembly UFI FILTERS / N.2 filtri montaggio UFI FILTERS	740.632-400 Euro4	294	400	02/13 >		S 4059 NR		
65222	dryer filter / filtro essiccatore	740.632-400 Euro4	294	400	02/13 >				S 7259 A
	2 filters assembly UFI FILTERS / N.2 filtri montaggio UFI FILTERS	740.632-400 Euro4	294	400	02/13 >		S 4059 NR		
65224	740.50-360	265	360	01/90 >	01/14				✗
	dryer filter / filtro essiccatore	740.50-360	265	360	01/90 >				S 7259 A
	prefilter / prefiltrò	740.50-360	265	360	05/08 >		S 4021 NR		
65224	740.63-400 Euro3	294	400	01/10 >	01/14			S 1050 A	✗
	outer DONALDSON FRG15-0112 / esterno DONALDSON FRG15-0112	740.63-400 Euro3	294	400	02/14 >			S 1050 A	
	inner DONALDSON FRG15-0112 / interno DONALDSON FRG15-0112	740.63-400 Euro3	294	400	01/10 >			S 7421 A	
	prefilter / prefiltrò	740.63-400 Euro3	294	400	01/10 >			S 7422 A	
	740.63-400 Euro3	294	400	01/10 >			S 4021 NR		
65225	740.35-400	294	400	01/90 >	01/14				✗
	dryer filter / filtro essiccatore	740.35-400	294	400	01/90 >				S 7259 A
	prefilter / prefiltrò	740.35-400	294	400	05/08 >		S 4021 NR		
65225	740.50-360	265	360	01/90 >	01/14				✗
	dryer filter / filtro essiccatore	740.50-360	265	360	01/90 >				S 7259 A
	prefilter / prefiltrò	740.50-360	265	360	05/08 >		S 4021 NR		
65225	740.60-360 Euro3	265	360	01/10 >	01/14			S 1050 A	✗
	outer DONALDSON FRG15-0112 / esterno DONALDSON FRG15-0112	740.60-360 Euro3	265	360	02/14 >			S 1050 A	
	inner DONALDSON FRG15-0112 / interno DONALDSON FRG15-0112	740.60-360 Euro3	265	360	01/10 >			S 7421 A	
	prefilter / prefiltrò	740.60-360 Euro3	265	360	01/10 >			S 7422 A	
	740.60-360 Euro3	265	360	01/10 >			S 4021 NR		
65225	740.63-400	294	400	01/90 >	01/14				✗
	dryer filter / filtro essiccatore	740.63-400	294	400	01/90 >				S 7259 A
	prefilter / prefiltrò	740.63-400	294	400	05/08 >		S 4021 NR		
65225	740.63-400 Euro3	294	400	01/10 >	01/14			S 1050 A	✗
	outer DONALDSON FRG15-0112 / esterno DONALDSON FRG15-0112	740.63-400 Euro3	294	400	02/14 >			S 1050 A	
	inner DONALDSON FRG15-0112 / interno DONALDSON FRG15-0112	740.63-400 Euro3	294	400	01/10 >			S 7421 A	
	prefilter / prefiltrò	740.63-400 Euro3	294	400	01/10 >			S 7422 A	
	740.63-400 Euro3	294	400	01/10 >			S 4021 NR		
65225	dryer filter / filtro essiccatore	740.632-400 Euro4	294	400	12/12 >				S 7259 A
	2 filters assembly UFI FILTERS / N.2 filtri montaggio UFI FILTERS	740.632-400 Euro4	294	400	12/12 >		S 4059 NR		
65226	KHD BF8M1015C	400	544	01/94 >	01/14	S 9030 R	S 4323 NR		✗
	dryer filter / filtro essiccatore	KHD BF8M1015C	400	544	02/14 >	S 9030 R			S 7259 A
	2 filters / N.2 filtri	KHD BF8M1015C	400	544	01/94 >				
	prefilter / prefiltrò	KHD BF8M1015C	400	544	01/94 >		S 4323 NR		
	740.63-400 Euro3	294	400	05/08 >			S 4021 NR		
65228	Cummins ISX 530	395	537	01/95 >	01/14				✗



kW HP



...KAMAZ - trucks/autocarri

dryer filter / filtro essiccatore	Cummins ISX 530	395	537	01/95 >			S 7259 A
6540	740.13-260	191	260	01/90 > 01/14			✗
dryer filter / filtro essiccatore	740.13-260	191	260	01/90 >			S 7259 A
prefilter / prefiltrato	740.13-260	191	260	05/08 >		S 4021 NR	
6540	740.51-260	191	260	01/90 > 01/14			✗
dryer filter / filtro essiccatore	740.51-260	191	260	01/90 >			S 7259 A
prefilter / prefiltrato	740.51-260	191	260	05/08 >		S 4021 NR	
6540	740.51-320	235	320	01/90 > 01/14			✗
dryer filter / filtro essiccatore	740.51-320	235	320	01/90 >			S 7259 A
prefilter / prefiltrato	740.51-320	235	320	05/08 >		S 4021 NR	

KAROSA

buses/autobus

C Serie

C 734.1340

spin-on / avvitabile	Liaz			08/93 >		S 9030 R	S 1050 A
cartridge / immersione	Liaz			08/93 >		S 0530 PO	S 1050 A

LC Serie

LC 735	Liaz			01/91 > 12/91		S 0530 PO	S 1050 A
LC 735.1031							
spin-on / avvitabile	Liaz			03/93 >		S 9030 R	S 1050 A
cartridge / immersione	Liaz			03/93 >		S 0530 PO	S 1050 A
LC 736	Liaz			01/91 > 12/91		S 0530 PO	S 1050 A
LC 736.1022							
spin-on / avvitabile	Liaz			12/91 >		S 9030 R	S 1050 A
cartridge / immersione	Liaz			12/91 >		S 0530 PO	S 1050 A
LC 736.1024							
spin-on / avvitabile	Liaz			12/91 >		S 9030 R	S 1050 A
cartridge / immersione	Liaz			12/91 >		S 0530 PO	S 1050 A
LC 736.1030							
spin-on / avvitabile	Liaz			06/92 >		S 9030 R	S 1050 A
cartridge / immersione	Liaz			06/92 >		S 0530 PO	S 1050 A
LC 757.1060	Cummins			06/92 >			S 1050 A
LC 956	Iveco Cursor 8 F2BE1682G	228	310	09/02 >		S 3288 R	S 4396 NR
with air-conditioner WEBASTO Aerosphere / con climatizzatore WEBASTO Aerosphere	Iveco Cursor 8 F2BE1682G	228	310	09/02 >			S 7575 A
dryer filter / filtro essiccatore	Iveco Cursor 8 F2BE1682G	228	310	09/02 >			S 3081 C
dryer filter WABCO, right-hand thread / filtro essiccatore WABCO, filetto destro	Iveco Cursor 8 F2BE1682G	228	310	09/02 >			S 7259 A
VGT filter / filtro VGT	Iveco Cursor 8 F2BE1682G	228	310	09/02 >			S 7A66 A
prefilter / prefiltrato	Iveco Cursor 8 F2BE1682G	228	310	09/02 >		S 0999 NR	S 0VGT A
prefilter RACOR / prefiltrato RACOR	Iveco Cursor 8 F2BE1682G	228	310	09/02 >			S 4470 NR
power steering / servosterzo	Iveco Cursor 8 F2BE1682G	228	310	09/02 >			S 3081 PO

KARSAN

buses/autobus

J10

2.3 Turbodiesel E4	Iveco	72	96	01/10 >		S 1H20 NR	
---------------------------	-------	----	----	---------	--	-----------	--

KING LONG

buses/autobus

KLQ Serie

KLQ 6110 S	Cummins C300.20			01/08 >			S 7B80 A
inner / interno	Cummins C300.20			01/08 >			S 7B81 A

XMQ Serie

XMQ 6120							
with air-conditioner KONVEKTA P600/P800 (N. 8 pcs) / con climatizzatore KONVEKTA P600/P800 (N. 8 pezzi)	Cummins ISLe5	250	340	01/07 >			S 3279 C
with filter SCR-System / con filtro SCR-System	Cummins ISLe5	250	340	01/07 >			S 7A86 A
with filter Urea/Adblue / con filtro Urea/Adblue	Cummins ISLe5	250	340	01/07 >			S 4401 U
dryer filter / filtro essiccatore	Cummins ISLe5	250	340	01/07 >			S 7259 A
dryer filter WABCO, right-hand thread / filtro essiccatore WABCO, filetto destro	Cummins ISLe5	250	340	01/07 >			S 7A66 A
prefilter RACOR R120T / prefiltrato RACOR R120T	Cummins ISLe5	250	340	01/07 >		S 4159 NR	
prefilter RACOR R90T / prefiltrato RACOR R90T	Cummins ISLe5	250	340	01/07 >		S 4138 NR	
power steering / servosterzo	Cummins ISLe5	250	340	01/07 >			S 3081 PO
XMQ 6120 Y							
with air-conditioner KONVEKTA P600/P800 (N. 8 pcs) / con climatizzatore KONVEKTA P600/P800 (N. 8 pezzi)	Cummins ISLe5	250	340	01/07 >			S 3279 C
with filter SCR-System / con filtro SCR-System	Cummins ISLe5	250	340	01/07 >			S 7A86 A
with filter Urea/Adblue / con filtro Urea/Adblue	Cummins ISLe5	250	340	01/07 >			S 4401 U
dryer filter / filtro essiccatore	Cummins ISLe5	250	340	01/07 >			S 7259 A
dryer filter WABCO, right-hand thread / filtro essiccatore WABCO, filetto destro	Cummins ISLe5	250	340	01/07 >			S 7A66 A
prefilter RACOR R120T / prefiltrato RACOR R120T	Cummins ISLe5	250	340	01/07 >		S 4159 NR	
prefilter RACOR R90T / prefiltrato RACOR R90T	Cummins ISLe5	250	340	01/07 >		S 4138 NR	

**KW HP****...KING LONG - buses/autobus****K**

power steering / servosterzo	Cummins ISLe5	250	340	01/07	>				S 3081 PO
XMQ 6121 G									
with air-conditioner KONVEKTA P600/P800 (N. 8 pcs) / con climatizzatore KONVEKTA P600/P800 (N. 8 pezzi)	Cummins ISLe4	206	280	01/07	>				S 3279 C
with filter SCR-System / con filtro SCR-System	Cummins ISLe4	206	280	01/07	>				S 7A86 A
with filter Urea/Adblue / con filtro Urea/Adblue	Cummins ISLe4	206	280	01/07	>				S 4401 U
dryer filter / filtro essiccatore	Cummins ISLe4	206	280	01/07	>				S 7259 A
dryer filter WABCO, right-hand thread / filtro essiccatore WABCO, filetto destro	Cummins ISLe4	206	280	01/07	>				S 7A66 A
prefilter RACOR R120T / prefiltro RACOR R120T	Cummins ISLe4	206	280	01/07	>		S 4159 NR		
prefilter RACOR R90T / prefiltro RACOR R90T	Cummins ISLe4	206	280	01/07	>		S 4138 NR		
power steering / servosterzo	Cummins ISLe4	206	280	01/07	>				S 3081 PO
XMQ 6127									
with air-conditioner KONVEKTA P600/P800 (N. 8 pcs) / con climatizzatore KONVEKTA P600/P800 (N. 8 pezzi)	Cummins ISLe4/5	294	400	01/07	>				S 3279 C
with filter SCR-System / con filtro SCR-System	Cummins ISLe4/5	294	400	01/07	>				S 7A86 A
with filter Urea/Adblue / con filtro Urea/Adblue	Cummins ISLe4/5	294	400	01/07	>				S 4401 U
dryer filter / filtro essiccatore	Cummins ISLe4/5	294	400	01/07	>				S 7259 A
dryer filter WABCO, right-hand thread / filtro essiccatore WABCO, filetto destro	Cummins ISLe4/5	294	400	01/07	>				S 7A66 A
prefilter RACOR R120T / prefiltro RACOR R120T	Cummins ISLe4/5	294	400	01/07	>		S 4159 NR		
power steering / servosterzo	Cummins ISLe4/5	294	400	01/07	>				S 3081 PO
XMQ 6127 J									
with air-conditioner KONVEKTA P600/P800 (N. 8 pcs) / con climatizzatore KONVEKTA P600/P800 (N. 8 pezzi)	Cummins ISLe4/5	207	281	08/10	>				S 3279 C
with filter SCR-System / con filtro SCR-System	Cummins ISLe4/5	207	281	08/10	>				S 7A86 A
with filter Urea/Adblue / con filtro Urea/Adblue	Cummins ISLe4/5	207	281	08/10	>				S 4401 U
dryer filter / filtro essiccatore	Cummins ISLe4/5	207	281	08/10	>				S 7259 A
dryer filter WABCO, right-hand thread / filtro essiccatore WABCO, filetto destro	Cummins ISLe4/5	207	281	08/10	>				S 7A66 A
prefilter RACOR R120T / prefiltro RACOR R120T	Cummins ISLe4/5	207	281	08/10	>		S 4159 NR		
prefilter RACOR R90T / prefiltro RACOR R90T	Cummins ISLe4/5	207	281	08/10	>		S 4138 NR		
power steering / servosterzo	Cummins ISLe4/5	207	281	08/10	>				S 3081 PO
XMQ 6129									
with air-conditioner KONVEKTA P600/P800 (N. 8 pcs) / con climatizzatore KONVEKTA P600/P800 (N. 8 pezzi)	Cummins ISLe5	294	400	01/10	>				S 3279 C
with filter SCR-System / con filtro SCR-System	Cummins ISLe5	294	400	01/10	>				S 7A86 A
with filter Urea/Adblue / con filtro Urea/Adblue	Cummins ISLe5	294	400	01/10	>				S 4401 U
dryer filter / filtro essiccatore	Cummins ISLe5	294	400	01/10	>				S 7259 A
dryer filter WABCO, right-hand thread / filtro essiccatore WABCO, filetto destro	Cummins ISLe5	294	400	01/10	>				S 7A66 A
prefilter RACOR R120T / prefiltro RACOR R120T	Cummins ISLe5	294	400	01/10	>		S 4159 NR		
prefilter RACOR R90T / prefiltro RACOR R90T	Cummins ISLe5	294	400	01/10	>		S 4138 NR		
power steering / servosterzo	Cummins ISLe5	294	400	01/10	>				S 3081 PO
XMQ 6130									
with air-conditioner KONVEKTA P600/P800 (N. 8 pcs) / con climatizzatore KONVEKTA P600/P800 (N. 8 pezzi)	Cummins ISLe5	294	400	01/10	>				S 3279 C
with filter SCR-System / con filtro SCR-System	Cummins ISLe5	294	400	01/10	>				S 7A86 A
with filter Urea/Adblue / con filtro Urea/Adblue	Cummins ISLe5	294	400	01/10	>				S 4401 U
dryer filter / filtro essiccatore	Cummins ISLe5	294	400	01/10	>				S 7259 A
dryer filter WABCO, right-hand thread / filtro essiccatore WABCO, filetto destro	Cummins ISLe5	294	400	01/10	>				S 7A66 A
power steering / servosterzo	Cummins ISLe5	294	400	01/10	>				S 3081 PO
XMQ 6800	Cummins ISB4.5E5-207	152	207	08/10	>	S 0620 R		S 7F16 A	
with air-conditioner Spheros Aerosphere (N. 6 pcs) / con climatizzatore Spheros Aerosphere (N. 6 pezzi)	Cummins ISB4.5E5-207	152	207	08/10	>				S 3081 C
with filter SCR-System / con filtro SCR-System	Cummins ISB4.5E5-207	152	207	08/10	>				S 7A86 A
with filter Urea/Adblue / con filtro Urea/Adblue	Cummins ISB4.5E5-207	152	207	08/10	>				S 4401 U
dryer filter / filtro essiccatore	Cummins ISB4.5E5-207	152	207	08/10	>				S 7259 A
dryer filter WABCO, right-hand thread / filtro essiccatore WABCO, filetto destro	Cummins ISB4.5E5-207	152	207	08/10	>				S 7A66 A
prefilter RACOR R90T / prefiltro RACOR R90T	Cummins ISB4.5E5-207	152	207	08/10	>		S 4138 NR		
power steering / servosterzo	Cummins ISB4.5E5-207	152	207	08/10	>				S 3081 PO
XMQ 6800 ADG	Cummins ISB6.7E5-225B	166	225	01/07	>	S 0620 R		S 7F16 A	
with air-conditioner Spheros Aerosphere (N. 6 pcs) / con climatizzatore Spheros Aerosphere (N. 6 pezzi)	Cummins ISB6.7E5-225B	166	225	01/07	>				S 3081 C
with filter SCR-System / con filtro SCR-System	Cummins ISB6.7E5-225B	166	225	01/07	>				S 7A86 A
with filter Urea/Adblue / con filtro Urea/Adblue	Cummins ISB6.7E5-225B	166	225	01/07	>				S 4401 U
dryer filter / filtro essiccatore	Cummins ISB6.7E5-225B	166	225	01/07	>				S 7259 A
dryer filter WABCO, right-hand thread / filtro essiccatore WABCO, filetto destro	Cummins ISB6.7E5-225B	166	225	01/07	>				S 7A66 A
prefilter RACOR R90T / prefiltro RACOR R90T	Cummins ISB6.7E5-225B	166	225	01/07	>		S 4138 NR		
power steering / servosterzo	Cummins ISB6.7E5-225B	166	225	01/07	>				S 3081 PO
XMQ 6900	Cummins ISL E4	184	250	01/07	>	S 0620 R	S 2220 NR	S 7F16 A	
with air-conditioner KONVEKTA P600/P800 (N. 8 pcs) / con climatizzatore KONVEKTA P600/P800 (N. 8 pezzi)	Cummins ISL E4	184	250	01/07	>				S 3279 C
with filter SCR-System / con filtro SCR-System	Cummins ISL E4	184	250	01/07	>				S 7A86 A
with filter Urea/Adblue / con filtro Urea/Adblue	Cummins ISL E4	184	250	01/07	>				S 4401 U
dryer filter / filtro essiccatore	Cummins ISL E4	184	250	01/07	>				S 7259 A
dryer filter WABCO, right-hand thread / filtro essiccatore WABCO, filetto destro	Cummins ISL E4	184	250	01/07	>				S 7A66 A
prefilter RACOR R90T / prefiltro RACOR R90T	Cummins ISL E4	184	250	01/07	>		S 4138 NR		
power steering / servosterzo	Cummins ISL E4	184	250	01/07	>				S 3081 PO



KW HP



...KING LONG - buses/autobus

XMQ 6900	Cummins ISL E5 184 250	01/07 >	S 0620 R	S 7F16 A	S 3279 C
with air-conditioner KONVEKTA P600/P800 (N. 8 pcs) / con climatizzatore KONVEKTA P600/P800 (N. 8 pezzi)	Cummins ISL E5 184 250	01/07 >			S 7A86 A
with filter SCR-System / con filtro SCR-System	Cummins ISL E5 184 250	01/07 >			S 4401 U
with filter Urea/Adblue / con filtro Urea/Adblue	Cummins ISL E5 184 250	01/07 >			S 7259 A
dryer filter / filtro essiccatore	Cummins ISL E5 184 250	01/07 >			S 7A66 A
dryer filter WABCO, right-hand thread / filtro essiccatore WABCO, filetto destro	Cummins ISL E5 184 250	01/07 >			
prefilter RACOR R90T / prefiltro RACOR R90T	Cummins ISL E5 184 250	01/07 >	S 4138 NR		
power steering / servosterzo	Cummins ISL E5 184 250	01/07 >			S 3081 PO
XMQ 6996 Y	Cummins ISB6.7E5-300B 221 300	08/10 >	S 0620 R	S 7F16 A	S 3081 C
with air-conditioner Spheros Aerosphere (N. 6 pcs) / con climatizzatore Spheros Aerosphere (N. 6 pezzi)	Cummins ISB6.7E5-300B 221 300	08/10 >			S 7A86 A
with filter SCR-System / con filtro SCR-System	Cummins ISB6.7E5-300B 221 300	08/10 >			S 4401 U
with filter Urea/Adblue / con filtro Urea/Adblue	Cummins ISB6.7E5-300B 221 300	08/10 >			S 7259 A
dryer filter / filtro essiccatore	Cummins ISB6.7E5-300B 221 300	08/10 >			S 7A66 A
dryer filter WABCO, right-hand thread / filtro essiccatore WABCO, filetto destro	Cummins ISB6.7E5-300B 221 300	08/10 >			
prefilter RACOR R90T / prefiltro RACOR R90T	Cummins ISB6.7E5-300B 221 300	08/10 >	S 4138 NR		
power steering / servosterzo	Cummins ISB6.7E5-300B 221 300	08/10 >			S 3081 PO

KOCKUM

dump trucks/autocarri ribaltabili

400 Serie					
411 B	Ford 2704 E		S 4380 PO	S 7112 NC	
some / alcuni	Ford 2704 E		S 4380 PO	S 6481 N	
or DELPHI / oppure DELPHI	Ford 2704 E		S 4380 PO	S 7111 NC	
412					
2nd passage / 2.passaggio	Scania D8			S 1411 N	
some / alcuni	Scania D8			S 0201 N	S 6550 A
some / alcuni	Scania D8			S 0201 N	S 0940 A
spin-on / avvitabile	Scania D8			S 4323 NR	
412					
2nd passage / 2.passaggio	Scania DS8			S 1411 N	
some / alcuni	Scania DS8			S 0201 N	S 6550 A
some / alcuni	Scania DS8			S 0201 N	S 0940 A
spin-on / avvitabile	Scania DS8			S 4323 NR	
turbocompressor / turbocompressore	Scania DS8		S 2329 R		
412 T					
2nd passage / 2.passaggio	Scania D8			S 1411 N	
some / alcuni	Scania D8			S 0201 N	S 0940 A
some / alcuni	Scania D8			S 0201 N	S 6550 A
spin-on / avvitabile	Scania D8			S 4323 NR	
412 T					
2nd passage / 2.passaggio	Scania DS8			S 1411 N	
some / alcuni	Scania DS8			S 0201 N	S 0940 A
some / alcuni	Scania DS8			S 0201 N	S 6550 A
spin-on / avvitabile	Scania DS8			S 4323 NR	
turbocompressor / turbocompressore	Scania DS8		S 2329 R		
420					
1st passage / 1.passaggio	Scania DS11			S 0201 N	
2nd passage / 2.passaggio	Scania DS11			S 1411 N	
spin-on / avvitabile	Scania DS11			S 4323 NR	
turbocompressor / turbocompressore	Scania DS11		S 2329 R		
424					
1st passage / 1.passaggio	Scania DS11			S 0201 N	
2nd passage / 2.passaggio	Scania DS11			S 1411 N	
spin-on / avvitabile	Scania DS11			S 4323 NR	
turbocompressor / turbocompressore	Scania DS11		S 2329 R		
425					
1st passage / 1.passaggio	Scania DS11			S 0201 N	
2nd passage / 2.passaggio	Scania DS11			S 1411 N	
spin-on / avvitabile	Scania DS11			S 4323 NR	
turbocompressor / turbocompressore	Scania DS11		S 2329 R		
425B					
1st passage / 1.passaggio	Scania DS11			S 0201 N	
2nd passage / 2.passaggio	Scania DS11			S 1411 N	
spin-on / avvitabile	Scania DS11			S 4323 NR	
turbocompressor / turbocompressore	Scania DS11		S 2329 R		
435					
some / alcuni	Cummins KT 1150			S 4510 NR	
440	Cummins NT 855			S 4510 NR	

K





KW HP



...KOCKUM - dump trucks/autocarri ribaltabili

441	turbocompressor / turbocompressore	Scania DS14		S 2329 R	S 4323 NR	
442	turbocompressor / turbocompressore	Scania DS14		S 2329 R	S 4323 NR	
442B	turbocompressor / turbocompressore	Scania DS14		S 2329 R	S 4323 NR	
443	turbocompressor / turbocompressore	Scania DS14		S 2329 R	S 4323 NR	
445		Detroit Diesel 12V-71T		S 3301 PO		
K 445		Detroit Diesel 12V-71T		S 3301 PO		

KOMATSU

dump trucks/autocarri ribaltabili

HA Serie

HA250 (s.N. 60636 -)	inner / interno				S 6550 A	
HA270 (s.N. 65226 -)	inner / interno				S 2840 A	
					S 6550 A	
					S 2840 A	

HD Serie

HD1200M (s.N.1501 -)	inner / interno	Cummins			S 7315 A	
		Cummins			S 7314 A	
HD1200M-1	inner / interno	SA12V170-1			S 7315 A	
		SA12V170-1			S 7314 A	
HD1200M-1 (s.N.1501 -)	inner / interno	Cummins KTA2300			S 7315 A	
		Cummins KTA2300			S 7314 A	
HD1600M-1 (s.N. 1005 -)	inner / interno	Cummins KTA3067			S 7315 A	
		Cummins KTA3067			S 7314 A	
HD180-4 (s.N. 13588 - 14862)	inner / interno	Cummins NTO6			S 6550 A	
		Cummins NTO6			S 2840 A	
HD180-4 (s.N. 14863 -)	inner / interno	Cummins NTO6			S 6550 A	
		Cummins NTO6			S 2840 A	
HD180-4 (s.N. 956 -)	inner / interno	Cummins NTO6B			S 6550 A	
		Cummins NTO6B			S 2840 A	
HD200-2 (s.N. 125628 - 147773)	inner / interno	Cummins NTC743			S 6550 A	
		Cummins NTC743			S 2840 A	
HD200-2 (s.N. 147774 -)	inner / interno	Cummins NTC743			S 6550 A	
		Cummins NTC743			S 2840 A	
HD200-2 (s.N. 1774 -)	inner / interno	Cummins NTC743			S 6550 A	
		Cummins NTC743			S 2840 A	
HD200D-3 (s.N. 1001 -)	inner / interno	S6D125-1			S 6550 A	
		S6D125-1			S 2840 A	
HD205-3 (s.N. 1003 -)	inner / interno	S6D125-1			S 6550 A	
		S6D125-1			S 2840 A	
HD320-2	inner / interno	Cummins NTA855			S 6550 A	
		Cummins NTA855			S 2840 A	
HD325-2	inner / interno	Cummins KT1150		S 3409 R	S 6550 A	
		Cummins KT1150			S 2840 A	
HD325-3	inner / interno	Cummins KT1150		S 3409 R	S 6550 A	
		Cummins KT1150			S 2840 A	
HD325-5 (s.N. 2001 -)	inner / interno	SA6D140-1			S 6550 A	
		SA6D140-1			S 2840 A	
HD460-1		Cummins VT1710		S 3409 R		
HD465-2		Cummins VTA1710		S 3409 R		
HD465-7		SA6D170E-3 524 715			S 7615 A	
HD680-2 (s.N. 689062 -)		Cummins VTA1710		S 3409 R		
HD780-1		Cummins VTA1710		S 3409 R		

LEYLAND

trucks/autocarri

18TF						
18TF	some / alcuni				S 8950 A	
19TF						
19TF	some / alcuni				S 8950 A	
20TF						
20TF	some / alcuni				S 8950 A	
75 Serie						



kW HP



...LEYLAND - trucks/autocarri

Serie 75	Daf RS 222 L	01/92 >	S 3408 R	S 8110 NR		
85 Serie						
Serie 85	Daf WS 242, WS 268	01/92 >	S 3275 R	S 8110 NR		
95 Serie						
Serie 95	Daf WS 225, WS 268	04/90 >	S 3275 R	S 8110 NR	S 8570 A	
Badger						
Badger	600	01/62 >		S 8381 NC		
Badger	680	01/62 >		S 7111 NC		
Bear						
Bear	401	01/71 >		S 7111 NC		
Bear	410	01/71 >		S 7111 NC		
Bear	600	01/61 >		S 7111 NC		
Bear	680	01/61 >		S 7111 NC		
Beaver						
Beaver	600	01/61 >		S 8381 NC		
Beaver	680	01/61 >		S 7111 NC		
Beaver	690	01/71 >		S 7111 NC	S 6550 A	
Bison						
Bison	510	01/71 > 10/78			S 0150 A	
Bison	L12	01/76 > 12/80		S 7111 NC		
Boxer						
Boxer	5.1, 5.7	01/63 > 12/82	S 4380 PO	S 7111 NC		
from frame No. 349624 - 423640 / da telaio N. 349624 - 423640	5.1, 5.7		S 4380 PO	S 7111 NC	S 0850 A	
Boxer	6.98 DV, 6.98 NV	01/71 > 12/82	S 4380 PO	S 8111 NC	S 0850 A	
Boxer	6.98 TV	01/76 > 12/82	S 4380 PO	S 8111 NC		
Boxer	Perkins 6.354	> 10/74	S 4380 PO	S 7111 NC		
Boxer	Perkins 6.354	11/74 >	S 0420 R	S 7111 NC		
Buffalo						
Buffalo	510	01/71 > 12/76			S 0150 A	
Buffalo	L12	01/76 > 12/79		S 7111 NC		
BX1425						
BX1425					S 0850 A	
some / alcuni					S 8950 A	
some / alcuni						
BX1450						
BX1450					S 8950 A	
some / alcuni						
BX1600						
BX1600					S 8950 A	
some / alcuni						
Cheetah						
Cheetah	690			S 7111 NC	S 6550 A	
Chieftain						
Chieftain	401,402			S 7111 NC		
Chieftain	410	> 12/79		S 7111 NC		
Clydesdale						
Clydesdale	401,402			S 7111 NC		
Clydesdale	410	> 11/79		S 7111 NC		
Comet						
Comet	400, 400S, 401	01/72 > 12/74		S 7111 NC		
Constructor						
2420	Daf 825	01/85 >	S 5802 R	S 8110 NR		
T45	Gardner 6LXC				S 6550 A	
T45	Gardner 6LXCT Turbo	01/83 >			S 6550 A	
T45	Rolls Royce Eagle 220, 265L				S 6550 A	
T45						
some / alcuni	TL11				S 6550 A	
EA Van						
EA Van	2.52	01/69 >	S 0280 PO		S 2950 A	
EA Van	2.52 Diesel	01/69 >	S 0280 PO	S 7111 NC	S 2950 A	
FG						
FG	2.52 Diesel	01/60 >	S 0280 PO	S 7111 NC		
FG	3.8	01/59 > 12/76	S 0280 PO	S 7111 NC		
FG	4.98 NV	01/59 >	S 0280 PO	S 7111 NC	S 7045 A	
FG	5.1 Diesel	01/59 >	S 4380 PO	S 7111 NC		
FJ						
FJ	5.1, 5.7 Diesel		S 4380 PO	S 7111 NC	S 8950 A	



kW HP



...LEYLAND - trucks/autocarri

FJ	6.98 DV, 6.98 NVI		S 4380 PO	S 8111 NC	S 2950 A	
	6.98 DV, 6.98 NVI		S 4380 PO	S 8111 NC	S 8950 A	
Freighter						
Freighter	402			S 7111 NC		
Freighter	spin-on / avvitabile	6.98 NV, Turbo	S 5600 R	S 8111 NC		
	cartridge / immersione	6.98 NV, Turbo	S 4380 PO	S 8111 NC		
Hippo						
Hippo	600	01/61 >		S 8381 NC		
Hippo	680	01/61 >		S 7111 NC		
Laird						
Laird	5.1, 5.7	> 12/71	S 4380 PO	S 7111 NC	S 8950 A	
Laird	6.98 DV, 6.98 NV	> 12/71	S 4380 PO	S 8111 NC	S 8950 A	
Landtrain						
Landtrain	Cummins NHC250, NTE290	01/80 >		S 0810 NR		
Landtrain	L12, TL12	01/80 >		S 7111 NC		
Lynx						
Lynx	510	01/71 > 10/78			S 0150 A	
Marathon						
Marathon	Cummins NHC250	01/76 >		S 0810 NR	S 6550 A	
some / alcuni	Cummins NHC250			S 0810 NR	S 0150 A	
some / alcuni	Cummins NHC250			S 0810 NR	S 7945 A	
Marathon	Cummins NTE290	01/78 >		S 0810 NR	S 7945 A	
Marathon	Rolls Royce Eagle 220	01/76 >			S 0150 A	
Marathon	Rolls Royce Eagle 250, 265L	01/78 >			S 6550 A	
Marathon	TL12	01/73 >		S 7111 NC	S 6550 A	
Mastiff						
Mastiff	Perkins V8.510	> 10/74	S 4380 PO			
	Perkins V8.510	11/74 > 12/75	S 0420 R			
Mastiff	Perkins V8.540	01/75 >	S 0420 R			
to frame No. 506149 / a telaio N. 506149	Perkins V8.540	> 12/76	S 0420 R		S 8950 A	
Octopus						
Octopus	L12			S 7111 NC		
Octopus OT 68/26	680			S 7111 NC		
Reiver						
Reiver	401	> 08/73		S 7111 NC		
Reiver	410	08/73 > 11/79		S 7111 NC		
Roadrunner						
10.12	6.98 DV, 6.98 NV	10/84 >	S 5600 R	S 7111 NC		
6.10	6.98 DV, 6.98 NV	10/84 >	S 5600 R	S 7111 NC		
6.12	6.98 DV, 6.98 NV	10/84 >	S 5600 R	S 7111 NC		
8.10	6.98 DV, 6.98 NV	10/84 >	S 5600 R	S 7111 NC		
8.12	6.98 DV, 6.98 NV	10/84 >	S 5600 R	S 7111 NC		
Roadtrain						
Roadtrain	Cummins NT/NTE290	01/80 >		S 0810 NR		
Roadtrain	Cummins NT240	01/80 >		S 0810 NR		
Roadtrain	Cummins NTE320			S 0810 NR		
Roadtrain	some / alcuni				S 7945 A	
Roadtrain T45 16.25	Cummins Turbo 250	01/80 >		S 0810 NR		
Roadtrain T45 16.28	TL12	01/80 >		S 7111 NC		
to frame No. 8000822 / a telaio N. 8000822	TL12			S 7111 NC	S 7945 A	
Steer						
Steer	600	> 12/60		S 8381 NC		
Steer	680	> 12/60		S 7111 NC		
Super Beaver						
Super Beaver	690	01/71 >		S 7111 NC	S 6550 A	
Super Buffalo						
Super Buffalo	510	01/71 > 12/76			S 0150 A	
Super Comet						
Super Comet	400, 400S, 401	01/61 > 12/71		S 7111 NC		
	400, 400S, 401	01/72 > 12/74		S 7111 NC		
Super Comet	410	01/71 > 12/74		S 7111 NC		
Super Hippo						
Super Hippo	690			S 7111 NC		
Super Mastiff						
Super Mastiff	Perkins V8.510	> 10/74	S 4380 PO			



kW HP



...LEYLAND - trucks/autocarri

	Perkins V8.510	11/74 > 12/75	S 0420 R			
Super Mastiff	Perkins V8.540	01/75 >	S 0420 R			
to frame No. 506149 / a telaio N. 506149	Perkins V8.540	> 12/76	S 0420 R		S 8950 A	
Terrier						
Terrier	3.8, 4.98 NV	01/70 >	S 0280 PO	S 7111 NC	S 7045 A	
Terrier	5.1, 5.7	01/70 >	S 4380 PO	S 7111 NC		
Terrier	6.98 DV, 6.98 NV		S 4380 PO	S 8111 NC		
spin-on / avvitabile	6.98 DV, 6.98 NV		S 5600 R	S 8111 NC		
Terrier	6.98 Turbo	01/79 >	S 4380 PO	S 8111 NC		
WF						
2.2		01/63 >	S 4080 PO			
2.2 Diesel		01/63 >	S 4080 PO	S 6181 N		
2nd passage / 2.passaggio				S 7111 NC		
3.8 Diesel		01/63 >	S 0280 PO			
4.0		01/63 >	S 5446 PO			
5.1 Diesel		01/63 >	S 4380 PO	S 7111 NC		
5.7 Diesel		01/63 >	S 4380 PO	S 7111 NC		
LEYLAND buses/autobus						
Atlantean						
Atlantean	680 Serie 4000			S 7111 NC		
Atlantean AN68	680			S 7111 NC		
Fleetline						
Fleetline						S 0280 PO
hydraulic / idraulico						S 5446 PO
power steering / servosterzo						
Fleetline	680, 690			S 7111 NC		
Hercules						
Hercules						S 0280 PO
hydraulic / idraulico						S 5446 PO
power steering / servosterzo						
Leopard						
PSU3	680			S 7111 NC	S 0940 A	
PSU4	680			S 7111 NC	S 0940 A	
PSU5	680			S 7111 NC	S 0150 A	
National						
National	500, 501, 510	06/79 >			S 7299 A	
National	Gardner 6HLXB			S 8111 NC		
National MK2	680	01/80 >		S 7111 NC	S 0150 A	
National MK2	680 Serie 4000			S 7111 NC	S 0150 A	
Olympian						
Olympian	Gardner 6LXB				S 6550 A	
some / alcuni	Gardner 6LXB				S 2570 A	
Olympian	TL11				S 2570 A	
some / alcuni						
Reliance						
Reliance	AH505, AH691, AH760		S 5446 PO	S 8381 NC		
some / alcuni	AH505, AH691, AH760		S 5446 PO	S 7111 NC		
Royal Tiger						
Royal Tiger	TL11	01/84 >			S 6550 A	
some / alcuni						
Tiger						
Tiger	TL11, TL14				S 6550 A	
some / alcuni						
Tiger	TL31, TL57	01/84 >			S 6550 A	
some / alcuni						
Worldmaster						
Worldmaster	680			S 7111 NC	S 0940 A	
LIEBHERR articulated dump trucks/ribaltabili articolati						
TA Serie						
TA 230 (Type 1156)	Liebherr D936LA46 Tier 3	270 367		S 3592 R	S 4154 NR	S 7A23 A
inner / interno	Liebherr D936LA46 Tier 3	270 367				S 7616 A
prefilter / prefiltro	Liebherr D936LA46 Tier 3	270 367			S 4138 NR	

L





kW HP



MACK

trucks/autocarri

CM Serie

CM400	MIDR06.02.12			01/87 > 12/90					✗
with cone-shaped filter without cover / con filtro conico senza coperchio	MIDR06.02.12			01/87 > 12/90				S 7607 A	
2 filters / N.2 filtri	MIDR06.02.12			01/87 > 12/90	S 0900 R				
CM400	MIDR06.20.30/MIDS06.20.30			01/87 > 12/90					✗
with cone-shaped filter without cover / con filtro conico senza coperchio	MIDR06.20.30/MIDS06.20.30			01/87 > 12/90				S 7607 A	
2 filters / N.2 filtri	MIDR06.20.30/MIDS06.20.30			01/87 > 12/90	S 0900 R				
CM400	MIDR06.20.45	176	240	01/88 > 12/88					✗
with cone-shaped filter without cover / con filtro conico senza coperchio	MIDR06.20.45	176	240	01/88 > 12/88				S 7607 A	
2 filters / N.2 filtri	MIDR06.20.45	176	240	01/88 > 12/88	S 0900 R				

CS Serie

CS200P	E3-190			01/99 >	S 0900 R				
with cone-shaped filter without cover / con filtro conico senza coperchio	E3-190			01/99 >				S 7607 A	
CS250P	E3-180/E3-210			01/99 >	S 0900 R				
with cone-shaped filter without cover / con filtro conico senza coperchio	E3-180/E3-210			01/99 >				S 7607 A	
CS300P	E3-180/E3-210			01/99 >	S 0900 R				
with cone-shaped filter without cover / con filtro conico senza coperchio	E3-180/E3-210			01/99 >				S 7607 A	

MS Serie

MS200 Midliner	MIDR06.02.12	133	181	11/79 > 12/89					✗
with cone-shaped filter without cover / con filtro conico senza coperchio	MIDR06.02.12	133	181	11/79 > 12/89				S 7607 A	
2 filters / N.2 filtri	MIDR06.02.12	133	181	11/79 > 12/89	S 0900 R				
MS200 Midliner	MIDR06.02.26/30	133	181	06/88 >					✗
with cone-shaped filter without cover / con filtro conico senza coperchio	MIDR06.02.26/30	133	181	06/88 >				S 7607 A	
2 filters / N.2 filtri	MIDR06.02.26/30	133	181	06/88 >	S 0900 R				
MS250 Midliner	MIDR06.02.12	133	181	07/84 > 12/89					✗
with cone-shaped filter without cover / con filtro conico senza coperchio	MIDR06.02.12	133	181	07/84 > 12/89				S 7607 A	
2 filters / N.2 filtri	MIDR06.02.12	133	181	07/84 > 12/89	S 0900 R				
MS300 Midliner	MIDR06.20.12/30	158	215	06/84 > 12/89					✗
with cone-shaped filter without cover / con filtro conico senza coperchio	MIDR06.20.12/30	158	215	06/84 > 12/89				S 7607 A	
2 filters / N.2 filtri	MIDR06.20.12/30	158	215	06/84 > 12/89	S 0900 R				

MAN

trucks/autocarri

10 t Serie

10.126	Saviem 597.04			01/70 > 12/70	S 3241 R	S 1411 N			
other assembly / altro montaggio	Saviem 597.04			01/70 > 12/70	S 3241 R				
assembly DELPHI / montaggio DELPHI	Saviem 597.04			01/70 > 12/70	S 3241 R	S 7111 NC			
power steering / servosterzo	Saviem 597.04			01/70 > 12/70					S 8790 PO
10.126 F	Saviem 597.04			01/70 > 12/70	S 3241 R	S 1411 N			
other assembly / altro montaggio	Saviem 597.04			01/70 > 12/70	S 3241 R				
assembly DELPHI / montaggio DELPHI	Saviem 597.04			01/70 > 12/70	S 3241 R	S 7111 NC			
power steering / servosterzo	Saviem 597.04			01/70 > 12/70					S 8790 PO
10.136	D 0226 MF			09/81 > 09/87	S 5536 PO	S 4323 NR	S 0950 A		
2nd passage / 2.passaggio	D 0226 MF			09/81 > 09/87		S 4378 NR			
10.136 F	D 0226 MF			09/81 > 09/87	S 5536 PO	S 4323 NR	S 0950 A		
2nd passage / 2.passaggio	D 0226 MF			09/81 > 09/87		S 4378 NR			
10.180	D 0826 TOH			01/88 > 05/92	S 3292 R	S 4378 NR	S 2650 A		
10.180 HOCL	D 0826 TOH			01/88 > 05/92	S 3292 R	S 4378 NR	S 2650 A		

11 t Serie

11.136	D 0216 MXUL			08/72 > 07/81	S 3241 R	S 7111 NC	S 7839 A		
11.136	Saviem 797.03			01/71 > 07/81	S 3241 R	S 1411 N			
other assembly / altro montaggio	Saviem 797.03			01/71 > 07/81	S 3241 R				
assembly DELPHI / montaggio DELPHI	Saviem 797.03			01/71 > 07/81	S 3241 R	S 7111 NC			
power steering / servosterzo	Saviem 797.03			01/71 > 07/81					S 8790 PO
11.136 H	Saviem 797.03			01/71 > 07/81	S 3241 R	S 1411 N			
other assembly / altro montaggio	Saviem 797.03			01/71 > 07/81	S 3241 R				
assembly DELPHI / montaggio DELPHI	Saviem 797.03			01/71 > 07/81	S 3241 R	S 7111 NC			
power steering / servosterzo	Saviem 797.03			01/71 > 07/81					S 8790 PO
11.136 HK	Saviem 797.03			01/71 > 07/81	S 3241 R	S 1411 N			
other assembly / altro montaggio	Saviem 797.03			01/71 > 07/81	S 3241 R				
assembly DELPHI / montaggio DELPHI	Saviem 797.03			01/71 > 07/81	S 3241 R	S 7111 NC			
power steering / servosterzo	Saviem 797.03			01/71 > 07/81					S 8790 PO
11.136 U	D 0216 MXUL			08/72 > 07/81	S 3241 R	S 7111 NC	S 7839 A		
11.150 HOCL	D 0826 OH 02			05/92 > 02/93	S 3292 R	S 4378 NR	S 2450 A		
11.190 HOCL	D 0826 LOH 02			04/92 > 02/93	S 3292 R	S 4378 NR	S 2650 A		
11.230	D 0826 LOH			04/93 >	S 3292 R	S 4378 NR	S 2650 A		
11.230 HOCL	D 0826 LOH			04/93 >	S 3292 R	S 4378 NR	S 2650 A		

12 t Serie



KW HP



...MAN - trucks/autocarri

12.136	D 0226 MF	09/83 > 01/88	S 5536 PO	S 4323 NR	S 0950 A	
2nd passage / 2.passaggio	D 0226 MF	09/83 > 01/88		S 4378 NR		
12.136 F	D 0226 MF	09/83 > 01/88	S 5536 PO	S 4323 NR	S 0950 A	
2nd passage / 2.passaggio	D 0226 MF	09/83 > 01/88		S 4378 NR		
12.152	D 0824 LF 01	05/94 > 06/96	S 3292 R	S 4378 NR	S 2450 A	
12.152 F	D 0824 LF 01	05/94 > 06/96	S 3292 R	S 4378 NR	S 2450 A	
12.162	D 0824 LF 02	08/95 > 06/96	S 3292 R	S 4378 NR		
some / alcuni	D 0824 LF 02	08/95 > 06/96	S 3292 R	S 4378 NR	S 2450 A	
12.162 F	D 0824 LF 02	08/95 > 06/96	S 3292 R	S 4378 NR		
some / alcuni	D 0824 LF 02	08/95 > 06/96	S 3292 R	S 4378 NR	S 2450 A	
12.170	D 0226 MKF 170	04/83 > 02/89	S 5536 PO	S 4323 NR	S 2650 A	
2nd passage / 2.passaggio	D 0226 MKF 170	04/83 > 02/89		S 4378 NR		
12.170 F	D 0226 MKF 170	04/83 > 02/89	S 5536 PO	S 4323 NR	S 2650 A	
2nd passage / 2.passaggio	D 0226 MKF 170	04/83 > 02/89		S 4378 NR		
12.186	D 2146	01/70 > 06/71	S 0530 PO	S 1411 N		
power steering / servosterzo	D 2146	01/70 > 06/71				S 8790 PO
12.186 F	D 2146	01/70 > 06/71	S 0530 PO	S 1411 N		
power steering / servosterzo	D 2146	01/70 > 06/71				S 8790 PO
12.192	D 0226 MKF	09/83 > 02/89	S 5536 PO	S 4323 NR	S 2650 A	
2nd passage / 2.passaggio	D 0226 MKF	09/83 > 02/89		S 4378 NR		
12.192	D 2156 MY 30	07/71 > 12/73	S 0530 PO	S 1411 N		
power steering / servosterzo	D 2156 MY 30	07/71 > 12/73				S 8790 PO
12.192	D 2156 MYN 31	07/71 > 12/73	S 0530 PO	S 1411 N		
power steering / servosterzo	D 2156 MYN 31	07/71 > 12/73				S 8790 PO
12.192	D 2855 BYUL	01/72 > 12/76		S 1411 N	S 7987 A	
power steering / servosterzo	D 2855 BYUL	01/72 > 12/76				S 8790 PO
12.192 F	D 0226 MKF	09/83 > 02/89	S 5536 PO	S 4323 NR	S 2650 A	
2nd passage / 2.passaggio	D 0226 MKF	09/83 > 02/89		S 4378 NR		
12.192 F	D 2156 MYN 31	07/71 > 12/73	S 0530 PO	S 1411 N		
power steering / servosterzo	D 2156 MYN 31	07/71 > 12/73				S 8790 PO
12.192 H	D 2156 MY 30	07/71 > 12/73	S 0530 PO	S 1411 N		
power steering / servosterzo	D 2156 MY 30	07/71 > 12/73				S 8790 PO
12.192 HA	D 2156 MY 30	07/71 > 12/73	S 0530 PO	S 1411 N		
power steering / servosterzo	D 2156 MY 30	07/71 > 12/73				S 8790 PO
12.192 U	D 2855 BYUL	01/72 > 12/76		S 1411 N	S 7987 A	
power steering / servosterzo	D 2855 BYUL	01/72 > 12/76				S 8790 PO
12.215	D 2156 HMN 1	09/67 > 12/69	S 0530 PO	S 1411 N		
power steering / servosterzo	D 2156 HMN 1	09/67 > 12/69				S 8790 PO
12.215 F	D 2156 HMN 1	09/67 > 12/69	S 0530 PO	S 1411 N		
power steering / servosterzo	D 2156 HMN 1	09/67 > 12/69				S 8790 PO
12.215 FK	D 2156 HMN 1	09/67 > 12/69	S 0530 PO	S 1411 N		
power steering / servosterzo	D 2156 HMN 1	09/67 > 12/69				S 8790 PO
12.215 FS	D 2156 HMN 1	09/67 > 12/69	S 0530 PO	S 1411 N		
power steering / servosterzo	D 2156 HMN 1	09/67 > 12/69				S 8790 PO
12.216	D 2156 HMX 032	05/71 > 12/73	S 0530 PO	S 1411 N		
power steering / servosterzo	D 2156 HMX 032	05/71 > 12/73				S 8790 PO
12.216 H	D 2156 HMX 032	05/71 > 12/73	S 0530 PO	S 1411 N		
power steering / servosterzo	D 2156 HMX 032	05/71 > 12/73				S 8790 PO
12.262	D 0826 LF 13	08/95 > 06/96	S 3292 R	S 1378 NR		
2nd passage / 2.passaggio	D 0826 LF 13	08/95 > 06/96		S 4378 NR		
12.262 F	D 0826 LF 13	08/95 > 06/96	S 3292 R	S 1378 NR		
2nd passage / 2.passaggio	D 0826 LF 13	08/95 > 06/96		S 4378 NR		
12.272	D 2865 LF 02	09/91 > 10/92	S 7260 PO	S 1411 N	S 1050 A	
spin-on / avvitabile	D 2865 LF 02	09/91 > 10/92	S 7260 PO	S 4378 NR	S 1050 A	
12.272 F	D 2865 LF 02	09/91 > 10/92	S 7260 PO	S 1411 N	S 1050 A	
spin-on / avvitabile	D 2865 LF 02	09/91 > 10/92	S 7260 PO	S 4378 NR	S 1050 A	
13 t Serie						
13.136	D 0216 MXJL	08/72 > 12/81	S 3241 R	S 7111 NC	S 7839 A	
13.136 U	D 0216 MXJL	08/72 > 12/81	S 3241 R	S 7111 NC	S 7839 A	
13.168	D 0846 HMYN 014	05/71 > 12/73		S 7411 N	S 7987 A	
13.168	D 2555 MF	10/73 > 11/76		S 7411 N	S 2650 A	
some / alcuni	D 2555 MF	10/73 > 11/76		S 1411 N	S 2650 A	
power steering / servosterzo	D 2555 MF	10/73 > 11/76				S 8790 PO
13.168	D 2565 MF 168	12/76 > 12/84		S 1411 N	S 2650 A	
power steering / servosterzo	D 2565 MF 168	12/76 > 12/84				S 8790 PO
13.168 F	D 0846 HMYN 014	05/71 > 12/73		S 7411 N	S 7987 A	
13.168 F	D 2555 MF	10/73 > 11/76		S 7411 N	S 2650 A	

M





KW HP



...MAN - trucks/autocarri

M



some / alcuni	D 2555 MF	10/73 > 11/76		S 1411 N	S 2650 A	
power steering / servosterzo	D 2555 MF	10/73 > 11/76				S 8790 PO
13.168 F	D 2565 MF 168	12/76 > 12/84		S 1411 N	S 2650 A	
power steering / servosterzo	D 2565 MF 168	12/76 > 12/84				S 8790 PO
13.192	D 2555 MF	01/77 > 12/84		S 1411 N	S 2650 A	
power steering / servosterzo	D 2555 MF	01/77 > 12/84				S 8790 PO
13.192	D 2555 MXF	05/74 > 12/76		S 1411 N	S 2650 A	
power steering / servosterzo	D 2555 MXF	05/74 > 12/76				S 8790 PO
13.192	D 2555 MXUL	09/75 > 12/76		S 1411 N		
some / alcuni	D 2555 MXUL	09/75 > 12/76		S 1411 N	S 7987 A	
power steering / servosterzo	D 2555 MXUL	09/75 > 12/76				S 8790 PO
13.192	D 2855 BYUL (U 10 D)	01/72 > 12/76		S 1411 N	S 7987 A	
power steering / servosterzo	D 2855 BYUL (U 10 D)	01/72 > 12/76				S 8790 PO
13.192 F	D 2555 MF	01/77 > 12/84		S 1411 N	S 2650 A	
power steering / servosterzo	D 2555 MF	01/77 > 12/84				S 8790 PO
13.192 F	D 2555 MXF	05/74 > 12/76		S 1411 N	S 2650 A	
power steering / servosterzo	D 2555 MXF	05/74 > 12/76				S 8790 PO
13.192 U	D 2555 MXUL	09/75 > 12/76		S 1411 N		
some / alcuni	D 2555 MXUL	09/75 > 12/76		S 1411 N	S 7987 A	
power steering / servosterzo	D 2555 MXUL	09/75 > 12/76				S 8790 PO
13.192 U	D 2855 BYUL (U 10 D)	01/72 > 12/76		S 1411 N	S 7987 A	
power steering / servosterzo	D 2855 BYUL (U 10 D)	01/72 > 12/76				S 8790 PO
13.216	D 2156 HMX 032	05/71 > 12/73	S 0530 PO	S 1411 N		
power steering / servosterzo	D 2156 HMX 032	05/71 > 12/73				S 8790 PO
13.216 H	D 2156 HMX 032	05/71 > 12/73	S 0530 PO	S 1411 N		
power steering / servosterzo	D 2156 HMX 032	05/71 > 12/73				S 8790 PO
13.230	D 2356 HMN 2	09/67 > 04/71	S 0530 PO	S 1411 N		
power steering / servosterzo	D 2356 HMN 2	09/67 > 04/71				S 8790 PO
13.230 F	D 2356 HMN 2	09/67 > 04/71	S 0530 PO	S 1411 N		
power steering / servosterzo	D 2356 HMN 2	09/67 > 04/71				S 8790 PO
13.256	D 2156 MTN 1	01/70 > 04/71	S 0530 PO	S 1411 N		
power steering / servosterzo	D 2156 MTN 1	01/70 > 04/71				S 8790 PO
13.256 F	D 2156 MTN 1	01/70 > 04/71	S 0530 PO	S 1411 N		
power steering / servosterzo	D 2156 MTN 1	01/70 > 04/71				S 8790 PO
14 t Serie						
14.136	D 0226 MF	09/83 > 02/89	S 5536 PO	S 4323 NR	S 0950 A	
2nd passage / 2.passaggio	D 0226 MF	09/83 > 02/89		S 4378 NR		
14.136 F	D 0226 MF	09/83 > 02/89	S 5536 PO	S 4323 NR	S 0950 A	
2nd passage / 2.passaggio	D 0226 MF	09/83 > 02/89		S 4378 NR		
14.168	D 2565 MF 168	12/76 > 12/84		S 1411 N	S 2650 A	
power steering / servosterzo	D 2565 MF 168	12/76 > 12/84				S 8790 PO
14.168 F	D 2565 MF 168	12/76 > 12/84		S 1411 N	S 2650 A	
power steering / servosterzo	D 2565 MF 168	12/76 > 12/84				S 8790 PO
14.170	D 0226 MKF 170	04/83 > 02/89	S 5536 PO	S 4323 NR	S 2650 A	
2nd passage / 2.passaggio	D 0226 MKF 170	04/83 > 02/89		S 4378 NR		
14.170 F	D 0226 MKF 170	04/83 > 02/89	S 5536 PO	S 4323 NR	S 2650 A	
2nd passage / 2.passaggio	D 0226 MKF 170	04/83 > 02/89		S 4378 NR		
14.192	D 0226 MKF	09/83 > 02/89	S 5536 PO	S 4323 NR	S 2650 A	
2nd passage / 2.passaggio	D 0226 MKF	09/83 > 02/89		S 4378 NR		
14.192	D 2565 MF	04/77 > 12/84		S 1411 N	S 2650 A	
power steering / servosterzo	D 2565 MF	04/77 > 12/84				S 8790 PO
14.192	D 2565 MUL	06/75 > 07/89		S 1411 N		
power steering / servosterzo	D 2565 MUL	06/75 > 07/89				S 8790 PO
14.192	D 2855 BYUL (U 10 D)	01/72 > 12/76		S 1411 N	S 7987 A	
power steering / servosterzo	D 2855 BYUL (U 10 D)	01/72 > 12/76				S 8790 PO
14.192 F	D 0226 MKF	09/83 > 02/89	S 5536 PO	S 4323 NR	S 2650 A	
2nd passage / 2.passaggio	D 0226 MKF	09/83 > 02/89		S 4378 NR		
14.192 F	D 2565 MF	04/77 > 12/84		S 1411 N	S 2650 A	
power steering / servosterzo	D 2565 MF	04/77 > 12/84				S 8790 PO
14.192 U	D 2565 MUL	06/75 > 07/89		S 1411 N		
power steering / servosterzo	D 2565 MUL	06/75 > 07/89				S 8790 PO
14.192 U	D 2855 BYUL (U 10 D)	01/72 > 12/76		S 1411 N	S 7987 A	
power steering / servosterzo	D 2855 BYUL (U 10 D)	01/72 > 12/76				S 8790 PO
14.220	D 2566 MF 220	10/83 > 02/89	S 7260 PO	S 1411 N	S 2650 A	
14.220 F	D 2566 MF 220	10/83 > 02/89	S 7260 PO	S 1411 N	S 2650 A	
14.272	D 2865 LF 02	09/91 > 10/92	S 7260 PO	S 1411 N	S 1050 A	
spin-on / avvvitabile	D 2865 LF 02	09/91 > 10/92	S 7260 PO	S 4378 NR	S 1050 A	



KW HP



...MAN - trucks/autocarri

14.272 F	D 2865 LF 02	09/91 > 10/92	S 7260 PO	S 1411 N	S 1050 A	
spin-on / avvitabile	D 2865 LF 02	09/91 > 10/92	S 7260 PO	S 4378 NR	S 1050 A	
15 t Serie						
15.136	Saviem 797.04	01/71 > 12/74	S 3241 R	S 1411 N		
other assembly / altro montaggio	Saviem 797.04	01/71 > 12/74	S 3241 R			
assembly DELPHI / montaggio DELPHI	Saviem 797.04	01/71 > 12/74	S 3241 R	S 7111 NC		
power steering / servosterzo	Saviem 797.04	01/71 > 12/74				S 8790 PO
15.136 F	Saviem 797.04	01/71 > 12/74	S 3241 R	S 1411 N		
other assembly / altro montaggio	Saviem 797.04	01/71 > 12/74	S 3241 R			
assembly DELPHI / montaggio DELPHI	Saviem 797.04	01/71 > 12/74	S 3241 R	S 7111 NC		
power steering / servosterzo	Saviem 797.04	01/71 > 12/74				S 8790 PO
15.168	D 0846 HMYN 014	05/71 > 12/73		S 7411 N	S 7987 A	
15.168	D 2555 MF	10/73 > 11/76		S 1411 N	S 2650 A	
power steering / servosterzo	D 2555 MF	10/73 > 11/76				S 8790 PO
15.168	D 2565 MF 168	12/76 > 12/84		S 1411 N	S 2650 A	
power steering / servosterzo	D 2565 MF 168	12/76 > 12/84				S 8790 PO
15.168 F	D 0846 HMYN 014	05/71 > 12/73		S 7411 N	S 7987 A	
15.168 F	D 2555 MF	10/73 > 11/76		S 1411 N	S 2650 A	
power steering / servosterzo	D 2555 MF	10/73 > 11/76				S 8790 PO
15.168 F	D 2565 MF 168	12/76 > 12/84		S 1411 N	S 2650 A	
power steering / servosterzo	D 2565 MF 168	12/76 > 12/84				S 8790 PO
15.168 FK	D 0846 HMYN 014	05/71 > 12/73		S 7411 N	S 7987 A	
15.168 FK	D 2555 MF	10/73 > 11/76		S 1411 N	S 2650 A	
power steering / servosterzo	D 2555 MF	10/73 > 11/76				S 8790 PO
15.168 FK	D 2565 MF 168	12/76 > 12/84		S 1411 N	S 2650 A	
power steering / servosterzo	D 2565 MF 168	12/76 > 12/84				S 8790 PO
15.168 FS	D 2565 MF 168	12/76 > 12/84		S 1411 N	S 2650 A	
power steering / servosterzo	D 2565 MF 168	12/76 > 12/84				S 8790 PO
15.192	D 2156 MYN 31	07/71 > 12/73	S 0530 PO	S 1411 N		
power steering / servosterzo	D 2156 MYN 31	07/71 > 12/73				S 8790 PO
15.192	D 2565 MF	04/77 > 12/84		S 1411 N	S 2650 A	
power steering / servosterzo	D 2565 MF	04/77 > 12/84				S 8790 PO
15.192	D 2855 BYUL (U 10 D)	01/72 > 12/76		S 1411 N	S 7987 A	
power steering / servosterzo	D 2855 BYUL (U 10 D)	01/72 > 12/76				S 8790 PO
15.192 F	D 2156 MYN 31	07/71 > 12/73	S 0530 PO	S 1411 N		
power steering / servosterzo	D 2156 MYN 31	07/71 > 12/73				S 8790 PO
15.192 F	D 2565 MF	04/77 > 12/84		S 1411 N	S 2650 A	
power steering / servosterzo	D 2565 MF	04/77 > 12/84				S 8790 PO
15.192 FK	D 2565 MF	04/77 > 12/84		S 1411 N	S 2650 A	
power steering / servosterzo	D 2565 MF	04/77 > 12/84				S 8790 PO
15.192 FS	D 2565 MF	04/77 > 12/84		S 1411 N	S 2650 A	
power steering / servosterzo	D 2565 MF	04/77 > 12/84				S 8790 PO
15.192 U	D 2855 BYUL (U 10 D)	01/72 > 12/76		S 1411 N	S 7987 A	
power steering / servosterzo	D 2855 BYUL (U 10 D)	01/72 > 12/76				S 8790 PO
15.200	D 2556 MF	09/73 > 03/77	S 7260 PO	S 1411 N	S 2650 A	
power steering / servosterzo	D 2556 MF	09/73 > 03/77				S 8790 PO
15.200 F	D 2556 MF	09/73 > 03/77	S 7260 PO	S 1411 N	S 2650 A	
power steering / servosterzo	D 2556 MF	09/73 > 03/77				S 8790 PO
15.216	D 2156 HMX 032	05/71 > 12/73	S 0530 PO	S 1411 N		
power steering / servosterzo	D 2156 HMX 032	05/71 > 12/73				S 8790 PO
15.216 DH	D 2156 HMX 032	05/71 > 12/73	S 0530 PO	S 1411 N		
power steering / servosterzo	D 2156 HMX 032	05/71 > 12/73				S 8790 PO
15.220	D 2566 MF 220	10/83 > 02/89	S 7260 PO	S 1411 N	S 2650 A	
15.220 F	D 2566 MF 220	10/83 > 02/89	S 7260 PO	S 1411 N	S 2650 A	
15.240	D 2556 MXF	09/73 > 10/76	S 7260 PO	S 1411 N	S 2650 A	
power steering / servosterzo	D 2556 MXF	09/73 > 10/76				S 8790 PO
15.240	D 2566 MF	11/76 > 08/88	S 7260 PO	S 1411 N	S 2650 A	
export models / modelli di esportazione	D 2566 MF	11/76 > 08/88	S 7260 PO	S 1411 N	S 6550 A	
power steering / servosterzo	D 2566 MF	11/76 > 08/88				S 8790 PO
15.240 F	D 2556 MXF	09/73 > 10/76	S 7260 PO	S 1411 N	S 2650 A	
power steering / servosterzo	D 2556 MXF	09/73 > 10/76				S 8790 PO
15.240 F	D 2566 MF	11/76 > 08/88	S 7260 PO	S 1411 N	S 2650 A	
export models / modelli di esportazione	D 2566 MF	11/76 > 08/88	S 7260 PO	S 1411 N	S 6550 A	
power steering / servosterzo	D 2566 MF	11/76 > 08/88				S 8790 PO
16 t Serie						
16.136	D 0226 MF	04/84 > 11/86	S 5536 PO	S 4323 NR	S 0950 A	
2nd passage / 2.passaggio	D 0226 MF	04/84 > 11/86		S 4378 NR		

M



**KW HP****...MAN - trucks/autocarri****M**

16.136 F 2nd passage / 2.passaggio	D 0226 MF D 0226 MF	04/84 > 11/86 04/84 > 11/86	S 5536 PO	S 4323 NR S 4378 NR	S 0950 A	
16.168	D 0846 HMY 011	05/71 > 12/73		S 7411 N	S 7987 A	
16.168 power steering / servosterzo	D 2555 MF D 2555 MF	01/74 > 11/76 01/74 > 11/76		S 1411 N	S 2650 A	S 8790 PO
16.168 power steering / servosterzo	D 2565 MF 168 D 2565 MF 168	04/77 > 12/86 04/77 > 12/86		S 1411 N	S 2650 A	S 8790 PO
16.168 F power steering / servosterzo	D 2555 MF D 2555 MF	01/74 > 11/76 01/74 > 11/76		S 1411 N	S 2650 A	S 8790 PO
16.168 FL power steering / servosterzo	D 2565 MF 168 D 2565 MF 168	04/77 > 12/86 04/77 > 12/86		S 1411 N	S 2650 A	S 8790 PO
16.168 H	D 0846 HMY 011	05/71 > 12/73		S 7411 N	S 7987 A	
16.168 HA	D 0846 HMY 011	05/71 > 12/73		S 7411 N	S 7987 A	
16.170 2nd passage / 2.passaggio	D 0226 MKF 170 D 0226 MKF 170	03/84 > 11/86 03/84 > 11/86	S 5536 PO	S 4323 NR S 4378 NR	S 2650 A	
16.170 F 2nd passage / 2.passaggio	D 0226 MKF 170 D 0226 MKF 170	03/84 > 11/86 03/84 > 11/86	S 5536 PO	S 4323 NR S 4378 NR	S 2650 A	
16.186 power steering / servosterzo	D 2146 D 2146	01/70 > 06/71 01/70 > 06/71	S 0530 PO	S 1411 N		S 8790 PO
16.186 FN power steering / servosterzo	D 2146 D 2146	01/70 > 06/71 01/70 > 06/71	S 0530 PO	S 1411 N		S 8790 PO
16.192 2nd passage / 2.passaggio	D 0226 MKF D 0226 MKF	03/84 > 11/86 03/84 > 11/86	S 5536 PO	S 4323 NR S 4378 NR	S 2650 A	
16.192 power steering / servosterzo	D 2565 MF D 2565 MF	04/77 > 12/86 04/77 > 12/86		S 1411 N	S 2650 A	S 8790 PO
16.192 F 2nd passage / 2.passaggio	D 0226 MKF D 0226 MKF	03/84 > 11/86 03/84 > 11/86	S 5536 PO	S 4323 NR S 4378 NR	S 2650 A	
16.192 F power steering / servosterzo	D 2565 MF D 2565 MF	04/77 > 12/86 04/77 > 12/86		S 1411 N	S 2650 A	S 8790 PO
16.200 some / alcuni power steering / servosterzo	D 2556 MF D 2556 MF D 2556 MF	09/73 > 03/77 09/73 > 03/77 09/73 > 03/77	S 7260 PO S 7260 PO	S 1411 N S 1411 N	S 2650 A	S 8790 PO
16.200 F some / alcuni power steering / servosterzo	D 2556 MF D 2556 MF D 2556 MF	09/73 > 03/77 09/73 > 03/77 09/73 > 03/77	S 7260 PO S 7260 PO S 7260 PO	S 1411 N S 1411 N	S 2650 A	S 8790 PO
16.216 power steering / servosterzo	D 2156 HMX 032 D 2156 HMX 032	05/71 > 12/73 05/71 > 12/73	S 0530 PO	S 1411 N		S 8790 PO
16.216 H power steering / servosterzo	D 2156 HMX 032 D 2156 HMX 032	05/71 > 12/73 05/71 > 12/73	S 0530 PO	S 1411 N		S 8790 PO
16.220	D 2566 MF 220	10/83 > 11/86	S 5536 PO	S 1411 N	S 2650 A	
16.220 F	D 2566 MF 220	10/83 > 11/86	S 5536 PO	S 1411 N	S 2650 A	
16.230 power steering / servosterzo	D 2356 HMXN 061 D 2356 HMXN 061	05/71 > 12/73 05/71 > 12/73	S 0530 PO	S 1411 N		S 8790 PO
16.230 FN power steering / servosterzo	D 2356 HMXN 061 D 2356 HMXN 061	05/71 > 12/73 05/71 > 12/73	S 0530 PO	S 1411 N		S 8790 PO
16.232 power steering / servosterzo	D 2556 MXF D 2556 MXF	01/74 > 02/78 01/74 > 02/78	S 7260 PO	S 1411 N	S 2650 A	S 8790 PO
16.232 FD power steering / servosterzo	D 2556 MXF D 2556 MXF	01/74 > 02/78 01/74 > 02/78	S 7260 PO	S 1411 N	S 2650 A	S 8790 PO
16.240 power steering / servosterzo	D 2556 MXF D 2556 MXF	09/73 > 10/76 09/73 > 10/76	S 7260 PO	S 1411 N	S 2650 A	S 8790 PO
16.240 F power steering / servosterzo	D 2556 MXF D 2556 MXF	09/73 > 10/76 09/73 > 10/76	S 7260 PO	S 1411 N	S 2650 A	S 8790 PO
16.256 power steering / servosterzo	D 2156 MTXN 035 D 2156 MTXN 035	05/71 > 12/73 05/71 > 12/73	S 0530 PO	S 1411 N		S 8790 PO
16.256 power steering / servosterzo	D 2538 MF D 2538 MF	08/72 > 10/77 08/72 > 10/77		S 1411 N	S 0450 A	S 8790 PO
16.256 F power steering / servosterzo	D 2156 MTXN 035 D 2156 MTXN 035	05/71 > 12/73 05/71 > 12/73	S 0530 PO	S 1411 N		S 8790 PO
16.256 F power steering / servosterzo	D 2538 MF D 2538 MF	08/72 > 10/77 08/72 > 10/77		S 1411 N	S 0450 A	S 8790 PO
16.280 some / alcuni power steering / servosterzo	D 2566 MTF D 2566 MTF D 2566 MTF	01/77 > 12/86 01/77 > 12/86 01/77 > 12/86	S 7260 PO S 7260 PO	S 1411 N S 1411 N	S 0450 A S 1050 A	S 8790 PO
16.280 FT some / alcuni power steering / servosterzo	D 2566 MTF D 2566 MTF D 2566 MTF	01/77 > 12/86 01/77 > 12/86 01/77 > 12/86	S 7260 PO S 7260 PO	S 1411 N S 1411 N	S 0450 A S 1050 A	S 8790 PO



KW HP



...MAN - trucks/autocarri

16.290	D 2866 TOH	04/87 > 03/93	S 7260 PO	S 1411 N	S 1050 A	
16.290 HOC	D 2866 TOH	04/87 > 03/93	S 7260 PO	S 1411 N	S 1050 A	
16.304	D 2858 MX 090	05/71 > 12/73	S 2530 PO	S 1411 N		
power steering / servosterzo	D 2858 MX 090	05/71 > 12/73				S 8790 PO
16.304 F	D 2858 MX 090	05/71 > 12/73	S 2530 PO	S 1411 N		
power steering / servosterzo	D 2858 MX 090	05/71 > 12/73				S 8790 PO
16.320	D 2530 MF, D 2530 MXF	07/72 > 10/81		S 1411 N	S 0450 A	
power steering / servosterzo	D 2530 MF, D 2530 MXF	07/72 > 10/81				S 8790 PO
16.320	D 2538 MT	02/73 > 10/77		S 1411 N	S 0450 A	
power steering / servosterzo	D 2538 MT	02/73 > 10/77				S 8790 PO
16.320	D 3256 BTXUL	11/73 > 05/77		S 1411 N	S 7028 A	
power steering / servosterzo	D 3256 BTXUL	11/73 > 05/77				S 8790 PO
16.320 F	D 2530 MF, D 2530 MXF	07/72 > 10/81		S 1411 N	S 0450 A	
power steering / servosterzo	D 2530 MF, D 2530 MXF	07/72 > 10/81				S 8790 PO
16.320 H	D 2538 MT	02/73 > 10/77		S 1411 N	S 0450 A	
power steering / servosterzo	D 2538 MT	02/73 > 10/77				S 8790 PO
16.320 U	D 3256 BTXUL	11/73 > 05/77		S 1411 N	S 7028 A	
power steering / servosterzo	D 3256 BTXUL	11/73 > 05/77				S 8790 PO
16.320 UK	D 3256 BTXUL	11/73 > 05/77		S 1411 N	S 7028 A	
power steering / servosterzo	D 3256 BTXUL	11/73 > 05/77				S 8790 PO
16.360	D 2866 LOH 07	02/93 > 04/94	S 7260 PO	S 4378 NR	S 1050 A	
16.360 HOCL	D 2866 LOH 07	02/93 > 04/94	S 7260 PO	S 4378 NR	S 1050 A	
16.370	D 2866 LOH	11/95 >	S 7260 PO	S 4378 NR	S 1050 A	
16.370 HOCL	D 2866 LOH	11/95 >	S 7260 PO	S 4378 NR	S 1050 A	
17 t Serie						
17.136	D 0226 MF	11/86 > 08/88	S 5536 PO	S 4323 NR	S 0950 A	
2nd passage / 2.passaggio	D 0226 MF	11/86 > 08/88		S 4378 NR		
17.136 F	D 0226 MF	11/86 > 08/88	S 5536 PO	S 4323 NR	S 0950 A	
2nd passage / 2.passaggio	D 0226 MF	11/86 > 08/88		S 4378 NR		
17.170	D 0226 MKF 170	11/86 > 08/88	S 5536 PO	S 4323 NR	S 2650 A	
2nd passage / 2.passaggio	D 0226 MKF 170	11/86 > 08/88		S 4378 NR		
17.170 F	D 0226 MKF 170	11/86 > 08/88	S 5536 PO	S 4323 NR	S 2650 A	
2nd passage / 2.passaggio	D 0226 MKF 170	11/86 > 08/88		S 4378 NR		
17.192	D 0226 MKF	11/86 > 08/88	S 5536 PO	S 4323 NR	S 2650 A	
2nd passage / 2.passaggio	D 0226 MKF	11/86 > 08/88		S 4378 NR		
17.192 F	D 0226 MKF	11/86 > 08/88	S 5536 PO	S 4323 NR	S 2650 A	
2nd passage / 2.passaggio	D 0226 MKF	11/86 > 08/88		S 4378 NR		
17.220	D 2566 MF 220	11/86 > 08/88	S 7260 PO	S 1411 N	S 2650 A	
17.220 F	D 2566 MF 220	11/86 > 08/88	S 7260 PO	S 1411 N	S 2650 A	
17.240	D 2566 MF	11/86 > 08/88	S 7260 PO	S 1411 N	S 2650 A	
export models / modelli di esportazione	D 2566 MF	11/86 > 08/88	S 7260 PO	S 1411 N	S 6550 A	
power steering / servosterzo	D 2566 MF	11/86 > 08/88				S 8790 PO
17.240 F	D 2566 MF	11/86 > 08/88	S 7260 PO	S 1411 N	S 2650 A	
export models / modelli di esportazione	D 2566 MF	11/86 > 08/88	S 7260 PO	S 1411 N	S 6550 A	
power steering / servosterzo	D 2566 MF	11/86 > 08/88				S 8790 PO
17.241	D 2566 M	05/90 > 06/91	S 7260 PO	S 1411 N	S 2650 A	
spin-on / avvitabile	D 2566 M	05/90 > 06/91	S 7260 PO	S 4378 NR	S 2650 A	
17.241 HA	D 2566 M	05/90 > 06/91	S 7260 PO	S 1411 N	S 2650 A	
spin-on / avvitabile	D 2566 M	05/90 > 06/91	S 7260 PO	S 4378 NR	S 2650 A	
17.272	D 0826 LF 04	10/92 > 05/95	S 3292 R	S 4378 NR	S 2650 A	
dryer filter / filtro essiccatore	D 0826 LF 04	10/92 > 05/95				S 7259 A
17.272	D 2865 LF 02	09/91 > 05/95	S 7260 PO	S 4378 NR	S 1050 A	
dryer filter / filtro essiccatore	D 2865 LF 02	09/91 > 05/95				S 7259 A
17.272 FLS	D 0826 LF 04	10/92 > 05/95	S 3292 R	S 4378 NR	S 2650 A	
dryer filter / filtro essiccatore	D 0826 LF 04	10/92 > 05/95				S 7259 A
17.272 FLS	D 2865 LF 02	09/91 > 05/95	S 7260 PO	S 4378 NR	S 1050 A	
dryer filter / filtro essiccatore	D 2865 LF 02	09/91 > 05/95				S 7259 A
18 t Serie						
18.241	D 2566 M	09/90 > 10/93	S 7260 PO	S 1411 N	S 2650 A	
spin-on / avvitabile	D 2566 M	09/90 > 10/93	S 7260 PO	S 4378 NR	S 2650 A	
18.241 HA	D 2566 M	09/90 > 10/93	S 7260 PO	S 1411 N	S 2650 A	
spin-on / avvitabile	D 2566 M	09/90 > 10/93	S 7260 PO	S 4378 NR	S 2650 A	
18.272	D 2865 LF 02	09/91 > 05/94	S 7260 PO	S 1411 N	S 1050 A	
spin-on / avvitabile	D 2865 LF 02	09/91 > 05/94	S 7260 PO	S 4378 NR	S 1050 A	
18.272 F	D 2865 LF 02	09/91 > 05/94	S 7260 PO	S 1411 N	S 1050 A	
spin-on / avvitabile	D 2865 LF 02	09/91 > 05/94	S 7260 PO	S 4378 NR	S 1050 A	
18.310	D 2866 LOH 24	03/95 >	S 7260 PO	S 4378 NR	S 1050 A	

M





KW HP



...MAN - trucks/autocarri

M



18.310 HOCL	D 2866 LOH 24	03/95 >	S 7260 PO	S 4378 NR	S 1050 A	
18.320	D 2865 LOH 02	02/94 > 02/95	S 7260 PO	S 4378 NR	S 1050 A	
18.320 HOCL	D 2865 LOH 02	02/94 > 02/95	S 7260 PO	S 4378 NR	S 1050 A	
18.370	D 2866 LOH 07	04/93 >	S 7260 PO	S 4378 NR	S 1050 A	
18.370 HOCL	D 2866 LOH 07	04/93 >	S 7260 PO	S 4378 NR	S 1050 A	
18.420	D 2866 LOH 06	04/93 >	S 7260 PO	S 4378 NR	S 1050 A	
18.420 HOCL	D 2866 LOH 06	04/93 >	S 7260 PO	S 4378 NR	S 1050 A	
19 t Serie						
19.168	D 2555 M	01/74 > 02/77		S 1411 N		
some / alcuni	D 2555 M	01/74 > 02/77		S 1411 N	S 7987 A	
power steering / servosterzo	D 2555 M	01/74 > 02/77				S 8790 PO
19.168 HA	D 2555 M	01/74 > 02/77		S 1411 N		
some / alcuni	D 2555 M	01/74 > 02/77		S 1411 N	S 7987 A	
power steering / servosterzo	D 2555 M	01/74 > 02/77				S 8790 PO
19.192	D 2156 MY 30	07/71 > 12/73	S 0530 PO	S 1411 N		
power steering / servosterzo	D 2156 MY 30	07/71 > 12/73				S 8790 PO
19.192 DH-TM	D 2156 MY 30	07/71 > 12/73	S 0530 PO	S 1411 N		
power steering / servosterzo	D 2156 MY 30	07/71 > 12/73				S 8790 PO
19.192 DHA-TM	D 2156 MY 30	07/71 > 12/73	S 0530 PO	S 1411 N		
power steering / servosterzo	D 2156 MY 30	07/71 > 12/73				S 8790 PO
19.216	D 2156 HMX 032	05/71 > 12/73	S 0530 PO	S 1411 N		
power steering / servosterzo	D 2156 HMX 032	05/71 > 12/73				S 8790 PO
19.216 DH-TM	D 2156 HMX 032	05/71 > 12/73	S 0530 PO	S 1411 N		
power steering / servosterzo	D 2156 HMX 032	05/71 > 12/73				S 8790 PO
19.216 DHA-TM	D 2156 HMX 032	05/71 > 12/73	S 0530 PO	S 1411 N		
power steering / servosterzo	D 2156 HMX 032	05/71 > 12/73				S 8790 PO
19.230	D 2356 HMN 2	09/67 > 04/71	S 0530 PO	S 1411 N		
power steering / servosterzo	D 2356 HMN 2	09/67 > 04/71				S 8790 PO
19.230 DF	D 2356 HMN 2	09/67 > 04/71	S 0530 PO	S 1411 N		
power steering / servosterzo	D 2356 HMN 2	09/67 > 04/71				S 8790 PO
19.240	D 2566 MF	11/76 > 08/88	S 7260 PO	S 1411 N	S 2650 A	
export models / modelli di esportazione	D 2566 MF	11/76 > 08/88	S 7260 PO	S 1411 N	S 6550 A	
power steering / servosterzo	D 2566 MF	11/76 > 08/88				S 8790 PO
19.240	D 3256 BYUL	03/77 > 12/79		S 1411 N	S 7028 A	
power steering / servosterzo	D 3256 BYUL	03/77 > 12/79				S 8790 PO
19.240 F	D 2566 MF	11/76 > 08/88	S 7260 PO	S 1411 N	S 2650 A	
export models / modelli di esportazione	D 2566 MF	11/76 > 08/88	S 7260 PO	S 1411 N	S 6550 A	
power steering / servosterzo	D 2566 MF	11/76 > 08/88				S 8790 PO
19.240 U	D 3256 BYUL	03/77 > 12/79		S 1411 N	S 7028 A	
power steering / servosterzo	D 3256 BYUL	03/77 > 12/79				S 8790 PO
19.241	D 2566 MUL	08/79 > 12/80	S 7260 PO	S 1411 N	S 0450 A	
19.241 U	D 2566 MUL	08/79 > 12/80	S 7260 PO	S 1411 N	S 0450 A	
19.242	D 2866 F 240	01/88 > 02/89	S 7260 PO	S 1411 N	S 1050 A	
spin-on / avvitabile	D 2866 F 240	01/88 > 02/89	S 7260 PO	S 4378 NR	S 1050 A	
19.242 F	D 2866 F 240	01/88 > 02/89	S 7260 PO	S 1411 N	S 1050 A	
spin-on / avvitabile	D 2866 F 240	01/88 > 02/89	S 7260 PO	S 4378 NR	S 1050 A	
19.256	D 2156 MTN 1	01/70 > 04/71	S 0530 PO	S 1411 N		
power steering / servosterzo	D 2156 MTN 1	01/70 > 04/71				S 8790 PO
19.256	D 2538 MF	08/72 > 10/77		S 1411 N	S 0450 A	
power steering / servosterzo	D 2538 MF	08/72 > 10/77				S 8790 PO
19.256 DH	D 2156 MTN 1	01/70 > 04/71	S 0530 PO	S 1411 N		
power steering / servosterzo	D 2156 MTN 1	01/70 > 04/71				S 8790 PO
19.256 DHA	D 2156 MTN 1	01/70 > 04/71	S 0530 PO	S 1411 N		
power steering / servosterzo	D 2156 MTN 1	01/70 > 04/71				S 8790 PO
19.256 F	D 2538 MF	08/72 > 10/77		S 1411 N	S 0450 A	
power steering / servosterzo	D 2538 MF	08/72 > 10/77				S 8790 PO
19.262	D 2865 LF 260	01/88 > 02/90		S 1411 N	S 1050 A	
some / alcuni	D 2865 LF 260	01/88 > 02/90	S 7260 PO	S 1411 N	S 1050 A	
power steering / servosterzo	D 2865 LF 260	01/88 > 02/90				S 8790 PO
19.262 F	D 2865 LF 260	01/88 > 02/90		S 1411 N	S 1050 A	
some / alcuni	D 2865 LF 260	01/88 > 02/90	S 7260 PO	S 1411 N	S 1050 A	
power steering / servosterzo	D 2865 LF 260	01/88 > 02/90				S 8790 PO
19.272	D 2865 LF 02	02/90 > 10/92	S 7260 PO	S 1411 N	S 1050 A	
spin-on / avvitabile	D 2865 LF 02	02/90 > 10/92	S 7260 PO	S 4378 NR	S 1050 A	
19.272 F	D 2865 LF 02	02/90 > 10/92	S 7260 PO	S 1411 N	S 1050 A	
spin-on / avvitabile	D 2865 LF 02	02/90 > 10/92	S 7260 PO	S 4378 NR	S 1050 A	
19.273	D 2865 LF 22	01/94 > 12/95	S 7260 PO	S 4378 NR	S 1050 A	

**KW HP****...MAN - trucks/autocarri**

19.273 F	D 2865 LF 22	198	270	01/94	>	12/95	S 7260 PO	S 4378 NR	S 1050 A	
19.275	D 2658 M 2			12/68	>	12/69	S 2530 PO	S 1411 N		
power steering / servosterzo	D 2658 M 2			12/68	>	12/69				S 8790 PO
19.275 DF	D 2658 M 2			12/68	>	12/69	S 2530 PO	S 1411 N		
power steering / servosterzo	D 2658 M 2			12/68	>	12/69				S 8790 PO
19.280	D 2566 MTF			11/76	>	12/81	S 7260 PO	S 1411 N	S 0450 A	
some / alcuni	D 2566 MTF			11/76	>	12/81	S 7260 PO	S 1411 N	S 1050 A	
power steering / servosterzo	D 2566 MTF			11/76	>	12/81				S 8790 PO
19.280 F	D 2566 MTF			11/76	>	12/81	S 7260 PO	S 1411 N	S 0450 A	
some / alcuni	D 2566 MTF			11/76	>	12/81	S 7260 PO	S 1411 N	S 1050 A	
power steering / servosterzo	D 2566 MTF			11/76	>	12/81				S 8790 PO
19.281	D 2566 MKF 280			01/80	>	11/85	S 7260 PO	S 1411 N	S 1050 A	
19.281 F	D 2566 MKF 280			01/80	>	11/85	S 7260 PO	S 1411 N	S 1050 A	
19.291	D 2866 LFZ 290			09/85	>	07/87	S 7260 PO	S 1411 N	S 1050 A	
19.291 F	D 2866 LFZ 290			09/85	>	07/87	S 7260 PO	S 1411 N	S 1050 A	
19.292	D 2866 LF 290			07/86	>	02/90	S 7260 PO	S 1411 N	S 1050 A	
spin-on / avvitabile	D 2866 LF 290			07/86	>	02/90	S 7260 PO	S 4378 NR	S 1050 A	
19.292 F	D 2866 LF 290			07/86	>	02/90	S 7260 PO	S 1411 N	S 1050 A	
spin-on / avvitabile	D 2866 LF 290			07/86	>	02/90	S 7260 PO	S 4378 NR	S 1050 A	
19.302	D 2866 LF 04			05/90	>	09/91	S 7260 PO	S 1411 N	S 1050 A	
spin-on / avvitabile	D 2866 LF 04			05/90	>	09/91	S 7260 PO	S 4378 NR	S 1050 A	
19.302 F	D 2866 LF 04			05/90	>	09/91	S 7260 PO	S 1411 N	S 1050 A	
spin-on / avvitabile	D 2866 LF 04			05/90	>	09/91	S 7260 PO	S 4378 NR	S 1050 A	
19.320	D 2530 MF			07/72	>	12/76		S 1411 N	S 0450 A	
power steering / servosterzo	D 2530 MF			07/72	>	12/76				S 8790 PO
19.320	D 3256 BTXUL (U 12 D)			06/77	>	12/79		S 1411 N	S 7028 A	
power steering / servosterzo	D 3256 BTXUL (U 12 D)			06/77	>	12/79				S 8790 PO
19.320 F	D 2530 MF			07/72	>	12/76		S 1411 N	S 0450 A	
power steering / servosterzo	D 2530 MF			07/72	>	12/76				S 8790 PO
19.320 U	D 3256 BTXUL (U 12 D)			06/77	>	12/79		S 1411 N	S 7028 A	
power steering / servosterzo	D 3256 BTXUL (U 12 D)			06/77	>	12/79				S 8790 PO
19.321	D 2566 MKF			01/80	>	11/85	S 7260 PO	S 1411 N	S 1050 A	
19.321 F	D 2566 MKF			01/80	>	11/85	S 7260 PO	S 1411 N	S 1050 A	
19.322	D 2865 LF 03			02/90	>	10/92	S 7260 PO	S 1411 N	S 1050 A	
spin-on / avvitabile	D 2865 LF 03			02/90	>	10/92	S 7260 PO	S 4378 NR	S 1050 A	
19.322 F	D 2865 LF 03			02/90	>	10/92	S 7260 PO	S 1411 N	S 1050 A	
spin-on / avvitabile	D 2865 LF 03			02/90	>	10/92	S 7260 PO	S 4378 NR	S 1050 A	
19.323	D 2865 LF 23	235	320	01/94	>	12/95			S 1970 A	S 3053 C
with gearbox ZF Ecosplit and Intarder / con cambio ZF Ecosplit e Intarder	D 2865 LF 23	235	320	01/94	>	12/95				S 2234 Z
dryer filter / filtro essiccatore	D 2865 LF 23	235	320	01/94	>	12/95				S 7259 A
inner / interno	D 2865 LF 23	235	320	01/94	>	12/95			S 7405 A	
2 filters / N.2 filtri	D 2865 LF 23	235	320	01/94	>	01/95	S 5132 PE	S 4378 NR		
2 filters / N.2 filtri	D 2865 LF 23	235	320	02/95	>	12/95	S 5005 PE	S 4378 NR		
prefilter with fuel oil heater / prefiltra con riscaldatore nafta	D 2865 LF 23	235	320	01/94	>	12/95		S 6059 NE		
prefilter without fuel oil heater / prefiltra senza riscaldatore nafta	D 2865 LF 23	235	320	01/94	>	12/95		S 6062 NE		
19.323 F	D 2865 LF 23	235	320	01/94	>	12/95			S 1970 A	S 3053 C
with gearbox ZF Ecosplit and Intarder / con cambio ZF Ecosplit e Intarder	D 2865 LF 23	235	320	01/94	>	12/95				S 2234 Z
dryer filter / filtro essiccatore	D 2865 LF 23	235	320	01/94	>	12/95				S 7259 A
inner / interno	D 2865 LF 23	235	320	01/94	>	12/95			S 7405 A	
2 filters / N.2 filtri	D 2865 LF 23	235	320	01/94	>	01/95	S 5132 PE	S 4378 NR		
2 filters / N.2 filtri	D 2865 LF 23	235	320	02/95	>	12/95	S 5005 PE	S 4378 NR		
prefilter with fuel oil heater / prefiltra con riscaldatore nafta	D 2865 LF 23	235	320	01/94	>	12/95		S 6059 NE		
prefilter without fuel oil heater / prefiltra senza riscaldatore nafta	D 2865 LF 23	235	320	01/94	>	12/95		S 6062 NE		
power steering / servosterzo	D 2865 LF 23	235	320	01/94	>	12/95				S 3081 PO
19.330	D 2530 MF			01/75	>	04/83		S 1411 N	S 1050 A	
19.330 FT	D 2530 MF			01/75	>	04/83		S 1411 N	S 1050 A	
19.331	D 2866 LFZ 330			09/85	>	07/87	S 7260 PO	S 1411 N	S 1050 A	
19.331 F	D 2866 LFZ 330			09/85	>	07/87	S 7260 PO	S 1411 N	S 1050 A	
19.332	D 2866 LF 330			07/86	>	02/90	S 7260 PO	S 1411 N	S 1050 A	
spin-on / avvitabile	D 2866 LF 330			07/86	>	02/90	S 7260 PO	S 4378 NR	S 1050 A	
19.332 F	D 2866 LF 330			07/86	>	02/90	S 7260 PO	S 1411 N	S 1050 A	
spin-on / avvitabile	D 2866 LF 330			07/86	>	02/90	S 7260 PO	S 4378 NR	S 1050 A	
19.360	D 2530 MTXF 360			05/78	>	12/82		S 1411 N	S 1050 A	
19.360 F	D 2530 MTXF 360			05/78	>	12/82		S 1411 N	S 1050 A	
19.361	D 2866 KFZ			09/83	>	03/87	S 7260 PO	S 1411 N	S 1050 A	
19.361 F	D 2866 KFZ			09/83	>	03/87	S 7260 PO	S 1411 N	S 1050 A	
19.362	D 2866 KF, D 2866 LXF			07/86	>	02/90	S 7260 PO	S 1411 N	S 1050 A	





KW HP



...MAN - trucks/autocarri

M



spin-on / avvitabile	D 2866 KF, D 2866 LXF	07/86 > 02/90	S 7260 PO	S 4378 NR	S 1050 A	
19.362 F	D 2866 KF, D 2866 LXF	07/86 > 02/90	S 7260 PO	S 1411 N	S 1050 A	
spin-on / avvitabile	D 2866 KF, D 2866 LXF	07/86 > 02/90	S 7260 PO	S 4378 NR	S 1050 A	
19.372	D 2866 LF 03	02/90 > 06/96	S 7260 PO	S 1411 N	S 1050 A	S 3053 C
spin-on / avvitabile	D 2866 LF 03	02/90 > 06/96	S 7260 PO	S 4378 NR	S 1050 A	S 3053 C
dryer filter / filtro essiccatore	D 2866 LF 03	02/90 > 06/96				S 7259 A
19.372 F	D 2866 LF 03	02/90 > 06/96	S 7260 PO	S 1411 N	S 1050 A	S 3053 C
spin-on / avvitabile	D 2866 LF 03	02/90 > 06/96	S 7260 PO	S 4378 NR	S 1050 A	S 3053 C
dryer filter / filtro essiccatore	D 2866 LF 03	02/90 > 06/96				S 7259 A
19.390	D 2540 MTF 390	12/82 > 12/87		S 1411 N	S 1050 A	
19.390 F	D 2540 MTF 390	12/82 > 12/87		S 1411 N	S 1050 A	
19.422	D 2866 LF 06	02/90 > 06/96	S 7260 PO	S 1411 N	S 1050 A	
spin-on / avvitabile	D 2866 LF 06	02/90 > 06/96	S 7260 PO	S 4378 NR	S 1050 A	
19.422 F	D 2866 LF 06	02/90 > 06/96	S 7260 PO	S 1411 N	S 1050 A	
spin-on / avvitabile	D 2866 LF 06	02/90 > 06/96	S 7260 PO	S 4378 NR	S 1050 A	
19.462	D 2840 LF 460	05/87 > 02/90	S 7260 PO	S 1411 N	S 0450 A	
spin-on / avvitabile	D 2840 LF 460	05/87 > 02/90	S 7260 PO	S 4378 NR	S 0450 A	
19.462 F	D 2840 LF 460	05/87 > 02/90	S 7260 PO	S 1411 N	S 0450 A	
spin-on / avvitabile	D 2840 LF 460	05/87 > 02/90	S 7260 PO	S 4378 NR	S 0450 A	
19.502	D 2840 LF 01	02/90 > 10/92	S 7260 PO	S 1411 N	S 0450 A	
spin-on / avvitabile	D 2840 LF 01	02/90 > 10/92	S 7260 PO	S 4378 NR	S 0450 A	
19.502 F	D 2840 LF 01	02/90 > 10/92	S 7260 PO	S 1411 N	S 0450 A	
spin-on / avvitabile	D 2840 LF 01	02/90 > 10/92	S 7260 PO	S 4378 NR	S 0450 A	
20 t Serie						
20.192	D 2555 MX	09/75 > 04/77		S 1411 N		
power steering / servosterzo	D 2555 MX	09/75 > 04/77				S 8790 PO
20.192 DH	D 2555 MX	09/75 > 04/77		S 1411 N		
power steering / servosterzo	D 2555 MX	09/75 > 04/77				S 8790 PO
20.280	D 2566 MTFG	05/78 > 06/90	S 7260 PO	S 1411 N	S 0450 A	
some / alcuni	D 2566 MTFG	05/78 > 06/90	S 7260 PO	S 1411 N	S 1050 A	
power steering / servosterzo	D 2566 MTFG	05/78 > 06/90				S 8790 PO
20.280 DFAEG	D 2566 MTFG	05/78 > 06/90	S 7260 PO	S 1411 N	S 0450 A	
some / alcuni	D 2566 MTFG	05/78 > 06/90	S 7260 PO	S 1411 N	S 1050 A	
power steering / servosterzo	D 2566 MTFG	05/78 > 06/90				S 8790 PO
20.281	D 2566 MKF 280	04/80 > 11/85	S 7260 PO	S 1411 N	S 1050 A	
20.281 FVLS	D 2566 MKF 280	04/80 > 11/85	S 7260 PO	S 1411 N	S 1050 A	
20.291	D 2866 LFZ 290	09/85 > 11/86	S 7260 PO	S 1411 N	S 1050 A	
20.291 FVLS	D 2866 LFZ 290	09/85 > 11/86	S 7260 PO	S 1411 N	S 1050 A	
20.320	Buessing S 12 DA	01/72 > 12/73		S 1411 N	S 7028 A	
power steering / servosterzo	Buessing S 12 DA	01/72 > 12/73				S 8790 PO
20.320	D 2530 MF	01/73 > 12/76		S 1411 N	S 0450 A	
power steering / servosterzo	D 2530 MF	01/72 > 12/73				S 8790 PO
20.320 FVLS	D 2530 MF	01/73 > 12/76		S 1411 N	S 0450 A	
power steering / servosterzo	D 2530 MF	01/73 > 12/76				S 8790 PO
20.320 FVS	Buessing S 12 DA	01/72 > 12/73		S 1411 N	S 7028 A	
power steering / servosterzo	Buessing S 12 DA	01/72 > 12/73				S 8790 PO
20.321	D 2566 MKF	04/80 > 11/85	S 7260 PO	S 1411 N	S 1050 A	
20.321 FVLS	D 2566 MKF	04/80 > 11/85	S 7260 PO	S 1411 N	S 1050 A	
20.331	D 2866 LFZ 330	09/85 > 11/86	S 7260 PO	S 1411 N	S 1050 A	
20.331 FVLS	D 2866 LFZ 330	09/85 > 11/86	S 7260 PO	S 1411 N	S 1050 A	
20.361	D 2866 KF	09/83 > 11/86	S 7260 PO	S 1411 N	S 1050 A	
20.361 FVLS	D 2866 KF	09/83 > 11/86	S 7260 PO	S 1411 N	S 1050 A	
22 t Serie						
22.192	D 2156 MYN 31	07/71 > 12/73	S 0530 PO	S 1411 N		
power steering / servosterzo	D 2156 MYN 31	07/71 > 12/73				S 8790 PO
22.192	D 2556 MF	10/72 > 12/73	S 7260 PO	S 1411 N		
power steering / servosterzo	D 2556 MF	10/72 > 12/73				S 8790 PO
22.192	D 2565 M	05/77 > 11/82		S 1411 N	S 2650 A	
power steering / servosterzo	D 2565 M	05/77 > 11/82				S 8790 PO
22.192 DH	D 2565 M	05/77 > 11/82		S 1411 N	S 2650 A	
power steering / servosterzo	D 2565 M	05/77 > 11/82				S 8790 PO
22.192 FN	D 2156 MYN 31	07/71 > 12/73	S 0530 PO	S 1411 N		
power steering / servosterzo	D 2156 MYN 31	07/71 > 12/73				S 8790 PO
22.192 FNL	D 2556 MF	10/72 > 12/73	S 7260 PO	S 1411 N		
power steering / servosterzo	D 2556 MF	10/72 > 12/73				S 8790 PO
22.200	D 2556 MF	10/74 > 03/78	S 7260 PO	S 1411 N		
some / alcuni	D 2556 MF	10/74 > 03/78	S 7260 PO	S 1411 N	S 2650 A	

**KW HP****...MAN - trucks/autocarri**

22.200 FNL-M	D 2556 MF	10/74 > 03/78	S 7260 PO	S 1411 N		
some / alcuni	D 2556 MF	10/74 > 03/78	S 7260 PO	S 1411 N	S 2650 A	
22.216	D 2156 HMX 032	05/71 > 12/73	S 0530 PO	S 1411 N		
power steering / servosterzo	D 2156 HMX 032	05/71 > 12/73				S 8790 PO
22.216 DH	D 2156 HMX 032	05/71 > 12/73	S 0530 PO	S 1411 N		
power steering / servosterzo	D 2156 HMX 032	05/71 > 12/73				S 8790 PO
22.216 DHK	D 2156 HMX 032	05/71 > 12/73	S 0530 PO	S 1411 N		
power steering / servosterzo	D 2156 HMX 032	05/71 > 12/73				S 8790 PO
22.216 DHKA	D 2156 HMX 032	05/71 > 12/73	S 0530 PO	S 1411 N		
power steering / servosterzo	D 2156 HMX 032	05/71 > 12/73				S 8790 PO
22.216 DHS	D 2156 HMX 032	05/71 > 12/73	S 0530 PO	S 1411 N		
power steering / servosterzo	D 2156 HMX 032	05/71 > 12/73				S 8790 PO
22.220	D 2566 MF 220	10/83 > 11/86	S 7260 PO	S 1411 N	S 2650 A	
22.220 FNL	D 2566 MF 220	10/83 > 11/86	S 7260 PO	S 1411 N	S 2650 A	
22.240	D 2556 MXF	09/73 > 10/76	S 7260 PO	S 1411 N	S 2650 A	
export models / modelli di esportazione	D 2556 MXF	09/73 > 10/76	S 7260 PO	S 1411 N	S 6550 A	
power steering / servosterzo	D 2556 MXF	09/73 > 10/76				S 8790 PO
22.240	D 3256 BYUL	11/77 > 12/79		S 1411 N	S 7028 A	
power steering / servosterzo	D 3256 BYUL	11/77 > 12/79				S 8790 PO
22.240 FNL	D 2556 MXF	09/73 > 10/76	S 7260 PO	S 1411 N	S 2650 A	
export models / modelli di esportazione	D 2556 MXF	09/73 > 10/76	S 7260 PO	S 1411 N	S 6550 A	
power steering / servosterzo	D 2556 MXF	09/73 > 10/76				S 8790 PO
22.240 UNL	D 3256 BYUL	11/77 > 12/79		S 1411 N	S 7028 A	
power steering / servosterzo	D 3256 BYUL	11/77 > 12/79				S 8790 PO
22.256	D 2156 MTN 1	01/70 > 04/71	S 0530 PO	S 1411 N		
power steering / servosterzo	D 2156 MTN 1	01/70 > 04/71				S 8790 PO
22.256 DH	D 2156 MTN 1	01/70 > 04/71	S 0530 PO	S 1411 N		
power steering / servosterzo	D 2156 MTN 1	01/70 > 04/71				S 8790 PO
22.256 DHA	D 2156 MTN 1	01/70 > 04/71	S 0530 PO	S 1411 N		
power steering / servosterzo	D 2156 MTN 1	01/70 > 04/71				S 8790 PO
22.280	D 2566 MTF	01/77 > 12/80	S 7260 PO	S 1411 N	S 0450 A	
some / alcuni	D 2566 MTF	01/77 > 12/80	S 7260 PO	S 1411 N	S 1050 A	
power steering / servosterzo	D 2566 MTF	01/77 > 12/80				S 8790 PO
22.280 FNL	D 2566 MTF	01/77 > 12/80	S 7260 PO	S 1411 N	S 0450 A	
some / alcuni	D 2566 MTF	01/77 > 12/80	S 7260 PO	S 1411 N	S 1050 A	
power steering / servosterzo	D 2566 MTF	01/77 > 12/80				S 8790 PO
22.291	D 2866 LFZ 290	09/85 > 11/86	S 7260 PO	S 1411 N	S 1050 A	
22.291 FNL	D 2866 LFZ 290	09/85 > 11/86	S 7260 PO	S 1411 N	S 1050 A	
22.292	D 2866 LF 290	07/86 > 10/86	S 7260 PO	S 1411 N	S 1050 A	
spin-on / avvitabile	D 2866 LF 290	07/86 > 10/86	S 7260 PO	S 4378 NR	S 1050 A	
22.292 FNL	D 2866 LF 290	07/86 > 10/86	S 7260 PO	S 1411 N	S 1050 A	
spin-on / avvitabile	D 2866 LF 290	07/86 > 10/86	S 7260 PO	S 4378 NR	S 1050 A	
22.304	D 2858 M 1	01/70 > 04/71	S 2530 PO	S 1411 N		
power steering / servosterzo	D 2858 M 1	01/70 > 04/71				S 8790 PO
22.304 DFSA	D 2858 M 1	01/70 > 04/71	S 2530 PO	S 1411 N		
power steering / servosterzo	D 2858 M 1	01/70 > 04/71				S 8790 PO
22.320	D 2530 MF	01/73 > 12/80		S 1411 N	S 0450 A	
power steering / servosterzo	D 2530 MF	01/73 > 12/80				S 8790 PO
22.320	D 3256 BTXUL	01/72 > 10/73		S 1411 N	S 7028 A	
power steering / servosterzo	D 3256 BTXUL	01/72 > 10/73				S 8790 PO
22.320 FNL	D 2530 MF	01/73 > 12/80		S 1411 N	S 0450 A	
power steering / servosterzo	D 2530 MF	01/73 > 12/80				S 8790 PO
22.320 UNL	D 3256 BTXUL	01/72 > 10/73		S 1411 N	S 7028 A	
power steering / servosterzo	D 3256 BTXUL	01/72 > 10/73				S 8790 PO
22.321	D 2566 MKF	04/80 > 11/85	S 7260 PO	S 1411 N	S 1050 A	
22.321 FNL	D 2566 MKF	04/80 > 11/85	S 7260 PO	S 1411 N	S 1050 A	
22.330	D 2866 LOH	05/85 > 09/89	S 7260 PO	S 1411 N	S 1050 A	
22.330 HOCLN	D 2866 LOH	05/85 > 09/89	S 7260 PO	S 1411 N	S 1050 A	
22.331	D 2866 LFZ 330	09/85 > 11/86	S 7260 PO	S 1411 N	S 1050 A	
22.331 FNL	D 2866 LFZ 330	09/85 > 11/86	S 7260 PO	S 1411 N	S 1050 A	
22.332	D 2866 LF 330	07/86 > 10/86	S 7260 PO	S 1411 N	S 1050 A	
spin-on / avvitabile	D 2866 LF 330	07/86 > 10/86	S 7260 PO	S 4378 NR	S 1050 A	
22.332 FNL	D 2866 LF 330	07/86 > 10/86	S 7260 PO	S 1411 N	S 1050 A	
spin-on / avvitabile	D 2866 LF 330	07/86 > 10/86	S 7260 PO	S 4378 NR	S 1050 A	
22.360	D 2866 KOH	06/86 > 09/89	S 7260 PO	S 1411 N	S 1050 A	
spin-on / avvitabile	D 2866 KOH	06/86 > 09/89	S 7260 PO	S 4378 NR	S 1050 A	
22.360 HOCLN	D 2866 KOH	06/86 > 09/89	S 7260 PO	S 1411 N	S 1050 A	

M



KW HP



...MAN - trucks/autocarri

M

spin-on / avvitabile	D 2866 KOH			06/86 > 09/89	S 7260 PO	S 4378 NR	S 1050 A	
22.361	D 2866 KF			09/83 > 11/86	S 7260 PO	S 1411 N	S 1050 A	
22.361 FNL	D 2866 KF			09/83 > 11/86	S 7260 PO	S 1411 N	S 1050 A	
22.362	D 2866 KF			07/86 > 10/86	S 7260 PO	S 1411 N	S 1050 A	
spin-on / avvitabile	D 2866 KF			07/86 > 10/86	S 7260 PO	S 4378 NR	S 1050 A	
22.362 FNL	D 2866 KF			07/86 > 10/86	S 7260 PO	S 1411 N	S 1050 A	
spin-on / avvitabile	D 2866 KF			07/86 > 10/86	S 7260 PO	S 4378 NR	S 1050 A	
22.370	D 2866 LOH 07			04/93 >	S 7260 PO	S 4378 NR	S 1050 A	
22.370 HOCLN	D 2866 LOH 07			04/93 >	S 7260 PO	S 4378 NR	S 1050 A	
23 t Serie								
23.272	D 2865 LF 05			10/92 > 05/95	S 7260 PO	S 4378 NR	S 1050 A	
23.272 FNL	D 2865 LF 05			10/92 > 05/95	S 7260 PO	S 4378 NR	S 1050 A	
23.322	D 2865 LF 06			10/92 > 05/95	S 7260 PO	S 4378 NR	S 1050 A	
23.322 FNL	D 2865 LF 06			10/92 > 05/95	S 7260 PO	S 4378 NR	S 1050 A	
23.342	D 2865 LF 09			05/94 > 05/95	S 7260 PO	S 4378 NR	S 1050 A	
23.342 FNL	D 2865 LF 09			05/94 > 05/95	S 7260 PO	S 4378 NR	S 1050 A	
23.372	D 2866 LF 05			10/92 > 05/94	S 7260 PO	S 1411 N	S 1050 A	
spin-on / avvitabile	D 2866 LF 05			10/92 > 05/94	S 7260 PO	S 4378 NR	S 1050 A	
23.372 FNL	D 2866 LF 05			10/92 > 05/94	S 7260 PO	S 1411 N	S 1050 A	
spin-on / avvitabile	D 2866 LF 05			10/92 > 05/94	S 7260 PO	S 4378 NR	S 1050 A	
23.402	D 2866 LF 16	294 400		05/94 > 05/95			S 1970 A	
with gearbox ZF Ecosplit e Intarder / con cambio ZF Ecosplit e Intarder	D 2866 LF 16	294 400		05/94 > 05/95				S 2234 Z
with air-conditioner / con climatizzatore	D 2866 LF 16	294 400		05/94 > 05/95				S 3053 C
dryer filter / filtro essiccatore	D 2866 LF 16	294 400		05/94 > 05/95				S 7259 A
inner / interno	D 2866 LF 16	294 400		05/94 > 05/95			S 7405 A	
2 filters / N.2 filtri	D 2866 LF 16	294 400		05/94 > 01/95	S 5132 PE	S 4378 NR		
2 filters / N.2 filtri	D 2866 LF 16	294 400		02/95 > 05/95	S 5005 PE	S 4378 NR		
23.402 FNL	D 2866 LF 16	294 400		05/94 > 05/95			S 1970 A	
with gearbox ZF Ecosplit e Intarder / con cambio ZF Ecosplit e Intarder	D 2866 LF 16	294 400		05/94 > 05/95				S 2234 Z
with air-conditioner / con climatizzatore	D 2866 LF 16	294 400		05/94 > 05/95				S 3053 C
dryer filter / filtro essiccatore	D 2866 LF 16	294 400		05/94 > 05/95				S 7259 A
inner / interno	D 2866 LF 16	294 400		05/94 > 05/95			S 7405 A	
2 filters / N.2 filtri	D 2866 LF 16	294 400		05/94 > 01/95	S 5132 PE	S 4378 NR		
2 filters / N.2 filtri	D 2866 LF 16	294 400		02/95 > 05/95	S 5005 PE	S 4378 NR		
23.422	D 2866 LF 09			10/92 > 05/95	S 7260 PO	S 1411 N	S 1050 A	
spin-on / avvitabile	D 2866 LF 09			10/92 > 05/95	S 7260 PO	S 4378 NR	S 1050 A	
23.422 FNL	D 2866 LF 09			10/92 > 05/95	S 7260 PO	S 1411 N	S 1050 A	
spin-on / avvitabile	D 2866 LF 09			10/92 > 05/95	S 7260 PO	S 4378 NR	S 1050 A	
24 t Serie								
24.192	D 0226 MKF			05/87 > 08/88	S 5536 PO	S 4378 NR	S 2650 A	
24.192	D 2565 MF			11/86 > 12/87		S 1411 N	S 2650 A	
power steering / servosterzo	D 2565 MF			11/86 > 12/87				S 8790 PO
24.192 FVL	D 0226 MKF			05/87 > 08/88	S 5536 PO	S 4378 NR	S 2650 A	
24.192 FVL	D 2565 MF			11/86 > 12/87		S 1411 N	S 2650 A	
power steering / servosterzo	D 2565 MF			11/86 > 12/87				S 8790 PO
24.220	D 2566 MF 220			11/86 > 08/88	S 7260 PO	S 1411 N	S 2650 A	
24.220 FNL	D 2566 MF 220			11/86 > 08/88	S 7260 PO	S 1411 N	S 2650 A	
24.240	D 2566 MF			11/86 > 08/88	S 7260 PO	S 1411 N	S 2650 A	
export models / modelli di esportazione	D 2566 MF			11/86 > 08/88	S 7260 PO	S 1411 N	S 6550 A	
power steering / servosterzo	D 2566 MF			11/86 > 08/88				S 8790 PO
24.240 FNL	D 2566 MF			11/86 > 08/88	S 7260 PO	S 1411 N	S 2650 A	
export models / modelli di esportazione	D 2566 MF			11/86 > 08/88	S 7260 PO	S 1411 N	S 6550 A	
power steering / servosterzo	D 2566 MF			11/86 > 08/88				S 8790 PO
24.242	D 2866 F 240			01/88 > 07/89	S 7260 PO	S 1411 N	S 1050 A	
spin-on / avvitabile	D 2866 F 240			01/88 > 07/89	S 7260 PO	S 4378 NR	S 1050 A	
24.242 DF	D 2866 F 240			01/88 > 07/89	S 7260 PO	S 1411 N	S 1050 A	
spin-on / avvitabile	D 2866 F 240			01/88 > 07/89	S 7260 PO	S 4378 NR	S 1050 A	
24.262	D 28665 LF 260			01/88 > 02/90	S 7260 PO	S 1411 N	S 1050 A	
spin-on / avvitabile	D 28665 LF 260			01/88 > 02/90	S 7260 PO	S 4378 NR	S 1050 A	
24.262 DF	D 28665 LF 260			01/88 > 02/90	S 7260 PO	S 1411 N	S 1050 A	
spin-on / avvitabile	D 28665 LF 260			01/88 > 02/90	S 7260 PO	S 4378 NR	S 1050 A	
24.272	D 0826 LF 04			10/92 > 06/96	S 3292 R	S 1378 NR	S 7187 A	
2nd passage / 2.passaggio	D 0826 LF 04			10/92 > 06/96		S 4378 NR		
some / alcuni	D 0826 LF 04			10/92 > 06/96	S 3292 R	S 1378 NR	S 8502 A	
24.272	D 2865 LF 02			02/90 > 12/90	S 7260 PO	S 1411 N	S 1050 A	
spin-on / avvitabile	D 2865 LF 02			02/90 > 12/90	S 7260 PO	S 4378 NR	S 1050 A	
24.272 DF	D 2865 LF 02			02/90 > 12/90	S 7260 PO	S 1411 N	S 1050 A	



kW HP



...MAN - trucks/autocarri

spin-on / avvitabile	D 2865 LF 02	02/90 > 12/90	S 7260 PO	S 4378 NR	S 1050 A	
24.272 FNL	D 0826 LF 04	10/92 > 06/96	S 3292 R	S 1378 NR	S 7187 A	
2nd passage / 2.passaggio	D 0826 LF 04	10/92 > 06/96		S 4378 NR		
some / alcuni	D 0826 LF 04	10/92 > 06/96	S 3292 R	S 1378 NR	S 8502 A	
24.273	D 2865 LF 22	01/94 > 12/95	S 7260 PO	S 4378 NR	S 1050 A	
24.273 FNL	D 2865 LF 22	01/94 > 12/95	S 7260 PO	S 4378 NR	S 1050 A	
24.291	D 2866 LFZ 290	11/86 > 07/87	S 7260 PO	S 1411 N	S 1050 A	
24.291 FNL	D 2866 LFZ 290	11/86 > 07/87	S 7260 PO	S 1411 N	S 1050 A	
24.292	D 2866 LF 290	04/87 > 02/90	S 7260 PO	S 1411 N	S 1050 A	
spin-on / avvitabile	D 2866 LF 290	04/87 > 02/90	S 7260 PO	S 4378 NR	S 1050 A	
24.292 DF	D 2866 LF 290	04/87 > 02/90	S 7260 PO	S 1411 N	S 1050 A	
spin-on / avvitabile	D 2866 LF 290	04/87 > 02/90	S 7260 PO	S 4378 NR	S 1050 A	
24.293	D 2865 LF 24	01/94 > 08/96		S 4378 NR	S 1970 A	S 3053 C
	D 2865 LF 24	09/96 >	S 5016 PE	S 4378 NR	S 1970 A	S 3053 C
with gearbox ZF Ecosplit and Intarder / con cambio ZF Ecosplit e Intarder	D 2865 LF 24	01/94 >				S 2234 Z
dryer filter / filtro essiccatore	D 2865 LF 24	01/94 >				S 7259 A
inner / interno	D 2865 LF 24	01/94 >			S 7405 A	
2 filters / N.2 filtri	D 2865 LF 24	02/95 > 08/96	S 5005 PE			
24.293 FNL	D 2865 LF 24	01/94 > 08/96		S 4378 NR	S 1970 A	S 3053 C
	D 2865 LF 24	09/96 >	S 5016 PE	S 4378 NR	S 1970 A	S 3053 C
with gearbox ZF Ecosplit and Intarder / con cambio ZF Ecosplit e Intarder	D 2865 LF 24	01/94 >				S 2234 Z
dryer filter / filtro essiccatore	D 2865 LF 24	01/94 >				S 7259 A
inner / interno	D 2865 LF 24	01/94 >			S 7405 A	
2 filters / N.2 filtri	D 2865 LF 24	02/95 > 08/96	S 5005 PE			
24.302	D 2866 LF 04	05/90 > 12/90	S 7260 PO	S 4378 NR	S 1050 A	
24.302 DF	D 2866 LF 04	05/90 > 12/90	S 7260 PO	S 4378 NR	S 1050 A	
24.322	D 2865 LF 03	02/90 > 12/90	S 7260 PO	S 4378 NR	S 1050 A	
24.322 DF	D 2865 LF 03	02/90 > 12/90	S 7260 PO	S 4378 NR	S 1050 A	
24.331	D 2866 LFZ 330	11/86 > 07/87	S 7260 PO	S 1411 N	S 1050 A	
24.331 FNL	D 2866 LFZ 330	11/86 > 07/87	S 7260 PO	S 1411 N	S 1050 A	
24.332	D 2866 LF 330	07/87 > 02/90	S 7260 PO	S 1411 N	S 1050 A	
spin-on / avvitabile	D 2866 LF 330	07/87 > 02/90	S 7260 PO	S 4378 NR	S 1050 A	
24.332 DF	D 2866 LF 330	07/87 > 02/90	S 7260 PO	S 1411 N	S 1050 A	
spin-on / avvitabile	D 2866 LF 330	07/87 > 02/90	S 7260 PO	S 4378 NR	S 1050 A	
24.361	D 2866 KFZ	11/86 > 09/87	S 7260 PO	S 1411 N	S 1050 A	
24.361 FNL	D 2866 KFZ	11/86 > 09/87	S 7260 PO	S 1411 N	S 1050 A	
24.362	D 2866 KF, D 2866 LXF	04/87 > 02/90	S 7260 PO	S 1411 N	S 1050 A	
spin-on / avvitabile	D 2866 KF, D 2866 LXF	04/87 > 02/90	S 7260 PO	S 4378 NR	S 1050 A	
24.362 DF	D 2866 KF, D 2866 LXF	04/87 > 02/90	S 7260 PO	S 1411 N	S 1050 A	
spin-on / avvitabile	D 2866 KF, D 2866 LXF	04/87 > 02/90	S 7260 PO	S 4378 NR	S 1050 A	
24.422	D 2866 LF 06	02/90 > 12/90	S 7260 PO	S 1411 N	S 1050 A	
spin-on / avvitabile	D 2866 LF 06	02/90 > 12/90	S 7260 PO	S 4378 NR	S 1050 A	
24.422 DF	D 2866 LF 06	02/90 > 12/90	S 7260 PO	S 1411 N	S 1050 A	
spin-on / avvitabile	D 2866 LF 06	02/90 > 12/90	S 7260 PO	S 4378 NR	S 1050 A	
24.462	D 2840 LF 460	02/89 > 02/90	S 7260 PO	S 1411 N	S 0450 A	
spin-on / avvitabile	D 2840 LF 460	02/89 > 02/90	S 7260 PO	S 4378 NR	S 0450 A	
24.462 DF	D 2840 LF 460	02/89 > 02/90	S 7260 PO	S 1411 N	S 0450 A	
spin-on / avvitabile	D 2840 LF 460	02/89 > 02/90	S 7260 PO	S 4378 NR	S 0450 A	
24.502	D 2840 LF 01	02/90 > 12/90	S 7260 PO	S 1411 N	S 0450 A	
spin-on / avvitabile	D 2840 LF 01	02/90 > 12/90	S 7260 PO	S 4378 NR	S 0450 A	
24.502 DF	D 2840 LF 01	02/90 > 12/90	S 7260 PO	S 1411 N	S 0450 A	
spin-on / avvitabile	D 2840 LF 01	02/90 > 12/90	S 7260 PO	S 4378 NR	S 0450 A	
240						
240	Saviem		S 6290 PO	S 9091 N		
25 t Serie						
25.272	D 2865 LF 02	09/90 > 10/92	S 7260 PO	S 1411 N	S 1050 A	
spin-on / avvitabile	D 2865 LF 02	09/90 > 10/92	S 7260 PO	S 4378 NR	S 1050 A	
25.272 DF	D 2865 LF 02	09/90 > 10/92	S 7260 PO	S 1411 N	S 1050 A	
spin-on / avvitabile	D 2865 LF 02	09/90 > 10/92	S 7260 PO	S 4378 NR	S 1050 A	
25.302	D 2866 LF 04	09/90 > 12/91	S 7260 PO	S 4378 NR	S 1050 A	
25.302 DF	D 2866 LF 04	09/90 > 12/91	S 7260 PO	S 4378 NR	S 1050 A	
25.322	D 2865 LF 03	09/90 > 10/92	S 7260 PO	S 1411 N	S 1050 A	
spin-on / avvitabile	D 2865 LF 03	09/90 > 10/92	S 7260 PO	S 4378 NR	S 1050 A	
25.322 DF	D 2865 LF 03	09/90 > 10/92	S 7260 PO	S 1411 N	S 1050 A	
spin-on / avvitabile	D 2865 LF 03	09/90 > 10/92	S 7260 PO	S 4378 NR	S 1050 A	
25.372	D 2866 LF 03	09/90 > 10/92	S 7260 PO	S 1411 N	S 1050 A	
spin-on / avvitabile	D 2866 LF 03	09/90 > 10/92	S 7260 PO	S 4378 NR	S 1050 A	





KW HP



...MAN - trucks/autocarri

M



25.372 DF	D 2866 LF 03	09/90 > 10/92	S 7260 PO	S 1411 N	S 1050 A	
spin-on / avvitabile	D 2866 LF 03	09/90 > 10/92	S 7260 PO	S 4378 NR	S 1050 A	
25.422	D 2866 LF 06	09/90 > 10/92	S 7260 PO	S 1411 N	S 1050 A	
spin-on / avvitabile	D 2866 LF 06	09/90 > 10/92	S 7260 PO	S 4378 NR	S 1050 A	
25.422 DF	D 2866 LF 06	09/90 > 10/92	S 7260 PO	S 1411 N	S 1050 A	
spin-on / avvitabile	D 2866 LF 06	09/90 > 10/92	S 7260 PO	S 4378 NR	S 1050 A	
25.502	D 2840 LF 01	09/90 > 11/92	S 7260 PO	S 1411 N	S 0450 A	
spin-on / avvitabile	D 2840 LF 01	09/90 > 11/92	S 7260 PO	S 4378 NR	S 0450 A	
25.502 DF	D 2840 LF 01	09/90 > 11/92	S 7260 PO	S 1411 N	S 0450 A	
spin-on / avvitabile	D 2840 LF 01	09/90 > 11/92	S 7260 PO	S 4378 NR	S 0450 A	
26 t Serie						
26.230	D 2356 HMX 060	05/71 > 12/73	S 0530 PO	S 1411 N		S 8790 PO
power steering / servosterzo	D 2356 HMX 060	05/71 > 12/73				S 8790 PO
26.230 DH-TM	D 2356 HMX 060	05/71 > 12/73	S 0530 PO	S 1411 N		S 8790 PO
power steering / servosterzo	D 2356 HMX 060	05/71 > 12/73				S 8790 PO
26.240	Buessing S 12 D	01/72 > 12/73		S 1411 N		S 8790 PO
power steering / servosterzo	Buessing S 12 D	01/72 > 12/73				S 8790 PO
26.240	D 2556 MF	01/77 > 08/88	S 7260 PO	S 1411 N	S 2650 A	
export models / modelli di esportazione	D 2556 MF	01/77 > 08/88	S 7260 PO	S 1411 N	S 6550 A	
power steering / servosterzo	D 2556 MF	01/77 > 08/88				S 8790 PO
26.240	D 2556 MXF	03/74 > 12/76	S 7260 PO	S 1411 N		
some / alcuni	D 2556 MXF	03/74 > 12/76	S 7260 PO	S 1411 N	S 2650 A	
26.240 DF	D 2556 MF	01/77 > 08/88	S 7260 PO	S 1411 N	S 2650 A	
export models / modelli di esportazione	D 2556 MF	01/77 > 08/88	S 7260 PO	S 1411 N	S 6550 A	
power steering / servosterzo	D 2556 MF	01/77 > 08/88				S 8790 PO
26.240 DF	D 2556 MXF	03/74 > 12/76	S 7260 PO	S 1411 N		
some / alcuni	D 2556 MXF	03/74 > 12/76	S 7260 PO	S 1411 N	S 2650 A	
26.240 DFK	Buessing S 12 D	01/72 > 12/73		S 1411 N		S 8790 PO
power steering / servosterzo	Buessing S 12 D	01/72 > 12/73				S 8790 PO
26.242	D 2866 F 240	01/88 > 07/89	S 7260 PO	S 1411 N	S 1050 A	
spin-on / avvitabile	D 2866 F 240	01/88 > 07/89	S 7260 PO	S 4378 NR	S 1050 A	
26.242 DF	D 2866 F 240	01/88 > 07/89	S 7260 PO	S 1411 N	S 1050 A	
spin-on / avvitabile	D 2866 F 240	01/88 > 07/89	S 7260 PO	S 4378 NR	S 1050 A	
26.256	D 2156 MTX 034	05/71 > 12/73	S 0530 PO	S 1411 N		S 8790 PO
power steering / servosterzo	D 2156 MTX 034	05/71 > 12/73				S 8790 PO
26.256	D 2538 MF	08/72 > 12/74		S 1411 N	S 0450 A	S 8790 PO
power steering / servosterzo	D 2538 MF	08/72 > 12/74				S 8790 PO
26.256 DF-TM	D 2538 MF	08/72 > 12/74		S 1411 N	S 0450 A	S 8790 PO
power steering / servosterzo	D 2538 MF	08/72 > 12/74				S 8790 PO
26.256 DFK	D 2538 MF	08/72 > 12/74		S 1411 N	S 0450 A	S 8790 PO
power steering / servosterzo	D 2538 MF	08/72 > 12/74				S 8790 PO
26.256 DFS	D 2538 MF	08/72 > 12/74		S 1411 N	S 0450 A	S 8790 PO
power steering / servosterzo	D 2538 MF	08/72 > 12/74				S 8790 PO
26.256 DH	D 2156 MTX 034	05/71 > 12/73	S 0530 PO	S 1411 N		S 8790 PO
power steering / servosterzo	D 2156 MTX 034	05/71 > 12/73				S 8790 PO
26.256 DHA	D 2156 MTX 034	05/71 > 12/73	S 0530 PO	S 1411 N		S 8790 PO
power steering / servosterzo	D 2156 MTX 034	05/71 > 12/73				S 8790 PO
26.262	D 2865 LF 260	01/88 > 02/90	S 7260 PO	S 1411 N	S 1050 A	
spin-on / avvitabile	D 2865 LF 260	01/88 > 02/90	S 7260 PO	S 4378 NR	S 1050 A	
26.262 DF	D 2865 LF 260	01/88 > 02/90	S 7260 PO	S 1411 N	S 1050 A	
spin-on / avvitabile	D 2865 LF 260	01/88 > 02/90	S 7260 PO	S 4378 NR	S 1050 A	
26.272	D 2865 LF 02	02/90 > 10/92	S 7260 PO	S 4378 NR	S 1050 A	
26.272 DF	D 2865 LF 02	02/90 > 10/92	S 7260 PO	S 4378 NR	S 1050 A	
26.280	D 2566 MTF	11/76 > 12/81	S 7260 PO	S 1411 N	S 0450 A	
some / alcuni	D 2566 MTF	11/76 > 12/81	S 7260 PO	S 1411 N	S 1050 A	S 8790 PO
power steering / servosterzo	D 2566 MTF	11/76 > 12/81				S 8790 PO
26.280 DF	D 2566 MTF	11/76 > 12/81	S 7260 PO	S 1411 N	S 0450 A	
some / alcuni	D 2566 MTF	11/76 > 12/81	S 7260 PO	S 1411 N	S 1050 A	
power steering / servosterzo	D 2566 MTF	11/76 > 12/81				S 8790 PO
26.280 DFK	D 2566 MTF	11/76 > 12/81	S 7260 PO	S 1411 N	S 0450 A	
some / alcuni	D 2566 MTF	11/76 > 12/81	S 7260 PO	S 1411 N	S 1050 A	
power steering / servosterzo	D 2566 MTF	11/76 > 12/81				S 8790 PO
26.280 DFS	D 2566 MTF	11/76 > 12/81	S 7260 PO	S 1411 N	S 0450 A	
some / alcuni	D 2566 MTF	11/76 > 12/81	S 7260 PO	S 1411 N	S 1050 A	
power steering / servosterzo	D 2566 MTF	11/76 > 12/81				S 8790 PO
26.281	D 2566 MFK 280	02/80 > 11/85	S 7260 PO	S 1411 N	S 1050 A	
26.281 DF	D 2566 MFK 280	02/80 > 11/85	S 7260 PO	S 1411 N	S 1050 A	

**KW HP****...MAN - trucks/autocarri**

26.281 DFK	D 2566 MFK 280	02/80 > 11/85	S 7260 PO	S 1411 N	S 1050 A	
26.281 DFS	D 2566 MFK 280	02/80 > 11/85	S 7260 PO	S 1411 N	S 1050 A	
26.291	D 2866 LFZ 290	09/85 > 08/88	S 7260 PO	S 1411 N	S 1050 A	
26.291 DF	D 2866 LFZ 290	09/85 > 08/88	S 7260 PO	S 1411 N	S 1050 A	
26.292	D 2866 LF 290	09/87 > 02/90	S 7260 PO	S 1411 N	S 1050 A	
spin-on / avvitabile	D 2866 LF 290	09/87 > 02/90	S 7260 PO	S 4378 NR	S 1050 A	
26.292 DF	D 2866 LF 290	09/87 > 02/90	S 7260 PO	S 1411 N	S 1050 A	
spin-on / avvitabile	D 2866 LF 290	09/87 > 02/90	S 7260 PO	S 4378 NR	S 1050 A	
26.302	D 2866 LF 04	05/90 > 12/91	S 7260 PO	S 4378 NR	S 1050 A	
26.302 DF	D 2866 LF 04	05/90 > 12/91	S 7260 PO	S 4378 NR	S 1050 A	
26.304	D 2858 MX 090	05/71 > 12/73	S 2530 PO	S 1411 N		
power steering / servosterzo	D 2858 MX 090	05/71 > 12/73				S 8790 PO
26.304 DF	D 2858 MX 090	05/71 > 12/73	S 2530 PO	S 1411 N		
power steering / servosterzo	D 2858 MX 090	05/71 > 12/73				S 8790 PO
26.304 DFK	D 2858 MX 090	05/71 > 12/73	S 2530 PO	S 1411 N		
power steering / servosterzo	D 2858 MX 090	05/71 > 12/73				S 8790 PO
26.304 DFKA	D 2858 MX 090	05/71 > 12/73	S 2530 PO	S 1411 N		
power steering / servosterzo	D 2858 MX 090	05/71 > 12/73				S 8790 PO
26.304 DFS	D 2858 MX 090	05/71 > 12/73	S 2530 PO	S 1411 N		
power steering / servosterzo	D 2858 MX 090	05/71 > 12/73				S 8790 PO
26.320	D 2538 MT	03/73 > 10/77		S 1411 N	S 0450 A	
power steering / servosterzo	D 2538 MT	03/73 > 10/77				S 8790 PO
26.320 DH	D 2538 MT	03/73 > 10/77		S 1411 N	S 0450 A	
power steering / servosterzo	D 2538 MT	03/73 > 10/77				S 8790 PO
26.320 DHK	D 2538 MT	03/73 > 10/77		S 1411 N	S 0450 A	
power steering / servosterzo	D 2538 MT	03/73 > 10/77				S 8790 PO
26.321	D 2566 MKF	02/80 > 11/85	S 7260 PO	S 1411 N	S 1050 A	
26.321 DF	D 2566 MKF	02/80 > 11/85	S 7260 PO	S 1411 N	S 1050 A	
26.321 DFK	D 2566 MKF	02/80 > 11/85	S 7260 PO	S 1411 N	S 1050 A	
26.321 DFS	D 2566 MKF	02/80 > 11/85	S 7260 PO	S 1411 N	S 1050 A	
26.322	D 2865 LF 03	02/90 > 10/92	S 7260 PO	S 1411 N	S 1050 A	
spin-on / avvitabile	D 2865 LF 03	02/90 > 10/92	S 7260 PO	S 4378 NR	S 1050 A	
26.322 DF	D 2865 LF 03	02/90 > 10/92	S 7260 PO	S 1411 N	S 1050 A	
spin-on / avvitabile	D 2865 LF 03	02/90 > 10/92	S 7260 PO	S 4378 NR	S 1050 A	
26.331	D 2866 LFZ 330	09/85 > 08/88	S 7260 PO	S 1411 N	S 1050 A	
26.331 DF	D 2866 LFZ 330	09/85 > 08/88	S 7260 PO	S 1411 N	S 1050 A	
26.332	D 2866 LF 330	09/87 > 02/90	S 7260 PO	S 1411 N	S 1050 A	
spin-on / avvitabile	D 2866 LF 330	09/87 > 02/90	S 7260 PO	S 4378 NR	S 1050 A	
26.332 DF	D 2866 LF 330	09/87 > 02/90	S 7260 PO	S 1411 N	S 1050 A	
spin-on / avvitabile	D 2866 LF 330	09/87 > 02/90	S 7260 PO	S 4378 NR	S 1050 A	
26.361	D 2866 KFZ	09/83 > 08/88	S 7260 PO	S 1411 N	S 1050 A	
26.361 DF	D 2866 KFZ	09/83 > 08/88	S 7260 PO	S 1411 N	S 1050 A	
26.365	D 2840 MF	05/83 > 08/88	S 7260 PO	S 1411 N	S 1050 A	
some / alcuni	D 2840 MF	05/83 > 08/88	S 7260 PO	S 1411 N	S 7361 A	
26.365 DF	D 2840 MF	05/83 > 08/88	S 7260 PO	S 1411 N	S 1050 A	
some / alcuni	D 2840 MF	05/83 > 08/88	S 7260 PO	S 1411 N	S 7361 A	
26.372	D 2866 LF 03	02/90 > 10/92	S 7260 PO	S 1411 N	S 1050 A	
spin-on / avvitabile	D 2866 LF 03	02/90 > 10/92	S 7260 PO	S 4378 NR	S 1050 A	
26.372 DF	D 2866 LF 03	02/90 > 10/92	S 7260 PO	S 1411 N	S 1050 A	
spin-on / avvitabile	D 2866 LF 03	02/90 > 10/92	S 7260 PO	S 4378 NR	S 1050 A	
26.402	D 2866 LF 16	05/94 > 06/96		S 4378 NR	S 1970 A	
with gearbox ZF Ecosplit and Intarder / con cambio ZF Ecosplit e Intarder	D 2866 LF 16	05/94 > 06/96				S 2234 Z
dryer filter / filtro essiccatore	D 2866 LF 16	05/94 > 06/96				S 7259 A
inner / interno	D 2866 LF 16	05/94 > 06/96			S 7405 A	
2 filters / N.2 filtri	D 2866 LF 16	02/95 > 06/96	S 5005 PE			
26.402 DF	D 2866 LF 16	05/94 > 06/96		S 4378 NR	S 1970 A	
with gearbox ZF Ecosplit and Intarder / con cambio ZF Ecosplit e Intarder	D 2866 LF 16	05/94 > 06/96				S 2234 Z
dryer filter / filtro essiccatore	D 2866 LF 16	05/94 > 06/96				S 7259 A
inner / interno	D 2866 LF 16	05/94 > 06/96			S 7405 A	
2 filters / N.2 filtri	D 2866 LF 16	02/95 > 06/96	S 5005 PE			
26.422	D 2866 LF 06	02/90 > 06/92	S 7260 PO	S 1411 N	S 1050 A	
spin-on / avvitabile	D 2866 LF 06	02/90 > 06/92	S 7260 PO	S 4378 NR	S 1050 A	
26.422 DF	D 2866 LF 06	02/90 > 06/92	S 7260 PO	S 1411 N	S 1050 A	
spin-on / avvitabile	D 2866 LF 06	02/90 > 06/92	S 7260 PO	S 4378 NR	S 1050 A	
26.442 DFAK	D 2866 LF	02/90 > 06/92		S 4378 NR		
26.462	D 2840 LF 460	02/89 > 02/90	S 7260 PO	S 1411 N	S 0450 A	
spin-on / avvitabile	D 2840 LF 460	02/89 > 02/90	S 7260 PO	S 4378 NR	S 0450 A	

M



KW HP



...MAN - trucks/autocarri

M

26.462 DF	D 2840 LF 460	02/89 > 02/90	S 7260 PO	S 1411 N	S 0450 A	
spin-on / avvvitabile	D 2840 LF 460	02/89 > 02/90	S 7260 PO	S 4378 NR	S 0450 A	
26.502	D 2840 LF 01	02/90 > 10/92	S 7260 PO	S 1411 N	S 0450 A	
spin-on / avvvitabile	D 2840 LF 01	02/80 > 10/92	S 7260 PO	S 4378 NR	S 0450 A	
26.502 DF	D 2840 LF 01	02/90 > 10/92	S 7260 PO	S 1411 N	S 0450 A	
spin-on / avvvitabile	D 2840 LF 01	02/80 > 10/92	S 7260 PO	S 4378 NR	S 0450 A	
27 t Serie						
27.272	D 2865 LF 05	01/93 > 06/96	S 7260 PO	S 4378 NR	S 1050 A	
27.272 DF	D 2865 LF 05	01/93 > 06/96	S 7260 PO	S 4378 NR	S 1050 A	
27.322	D 2865 LF 06	01/93 > 06/96	S 7260 PO	S 4378 NR	S 1050 A	
27.322 DF	D 2865 LF 06	01/93 > 06/96	S 7260 PO	S 4378 NR	S 1050 A	
27.342	D 2865 LF 09	05/94 > 06/96		S 4378 NR	S 1970 A	
with gearbox ZF Ecosplit and Intarder / con cambio ZF Ecosplit e Intarder	D 2865 LF 09	05/94 > 06/96				S 2234 Z
dryer filter / filtro essiccatore	D 2865 LF 09	05/94 > 06/96				S 7259 A
inner / interno	D 2865 LF 09	05/94 > 06/96			S 7405 A	
2 filters / N.2 filtri	D 2865 LF 09	02/95 > 06/96	S 5005 PE			
27.342 DF	D 2865 LF 09	05/94 > 06/96		S 4378 NR	S 1970 A	
with gearbox ZF Ecosplit and Intarder / con cambio ZF Ecosplit e Intarder	D 2865 LF 09	05/94 > 06/96				S 2234 Z
dryer filter / filtro essiccatore	D 2865 LF 09	05/94 > 06/96				S 7259 A
inner / interno	D 2865 LF 09	05/94 > 06/96			S 7405 A	
2 filters / N.2 filtri	D 2865 LF 09	02/95 > 06/96	S 5005 PE			
27.365	D 2840 MFG	11/82 > 12/90	S 7260 PO	S 1411 N	S 1050 A	
some / alcuni	D 2840 MFG	11/82 > 12/90	S 7260 PO	S 1411 N	S 7361 A	
27.365 VFAEG	D 2840 MFG	11/82 > 12/90	S 7260 PO	S 1411 N	S 1050 A	
some / alcuni	D 2840 MFG	11/82 > 12/90	S 7260 PO	S 1411 N	S 7361 A	
27.372	D 2866 LF 05	01/93 > 05/94	S 7260 PO	S 4378 NR	S 1050 A	
27.372 DF	D 2866 LF 05	01/93 > 05/94	S 7260 PO	S 4378 NR	S 1050 A	
27.402	D 2866 LF 16	05/94 > 06/96		S 4378 NR	S 1970 A	
with gearbox ZF Ecosplit and Intarder / con cambio ZF Ecosplit e Intarder	D 2866 LF 16	05/94 > 06/96				S 2234 Z
dryer filter / filtro essiccatore	D 2866 LF 16	05/94 > 06/96				S 7259 A
inner / interno	D 2866 LF 16	05/94 > 06/96			S 7405 A	
2 filters / N.2 filtri	D 2866 LF 16	01/95 > 06/96	S 5005 PE			
27.402 DF	D 2866 LF 16	05/94 > 06/96		S 4378 NR	S 1970 A	
with gearbox ZF Ecosplit and Intarder / con cambio ZF Ecosplit e Intarder	D 2866 LF 16	05/94 > 06/96				S 2234 Z
dryer filter / filtro essiccatore	D 2866 LF 16	05/94 > 06/96				S 7259 A
2 filters / N.2 filtri	D 2866 LF 16	01/95 > 06/96	S 5005 PE			
27.422	D 2866 LF 09	01/93 > 06/96	S 7260 PO	S 4378 NR	S 1050 A	
27.422 DF	D 2866 LF 09	01/93 > 06/96	S 7260 PO	S 4378 NR	S 1050 A	
27.502	D 2840 LF 04	01/93 > 06/96		S 4378 NR	S 0450 A	
some / alcuni	D 2840 LF 04	01/93 > 06/96	S 7260 PO	S 4378 NR	S 0450 A	
27.502 DF	D 2840 LF 04	01/93 > 06/96		S 4378 NR	S 0450 A	
some / alcuni	D 2840 LF 04	01/93 > 06/96	S 7260 PO	S 4378 NR	S 0450 A	
270						
270	Saviem		S 6290 PO	S 9091 N		
30 t Serie						
30.230	D 2356 HMX 060	05/71 > 12/73	S 0530 PO	S 1411 N		
power steering / servosterzo	D 2356 HMX 060	05/71 > 12/73				S 8790 PO
30.230 DH	D 2356 HMX 060	05/71 > 12/73	S 0530 PO	S 1411 N		
power steering / servosterzo	D 2356 HMX 060	05/71 > 12/73				S 8790 PO
30.230 DHA	D 2356 HMX 060	05/71 > 12/73	S 0530 PO	S 1411 N		
power steering / servosterzo	D 2356 HMX 060	05/71 > 12/73				S 8790 PO
30.232	D 2556 MXF	01/74 > 02/78	S 7260 PO	S 1411 N	S 2650 A	
power steering / servosterzo	D 2556 MXF	01/74 > 02/78				S 8790 PO
30.232	D 2566 MF	03/78 > 06/83	S 7260 PO	S 1411 N	S 2650 A	
30.232 VF	D 2556 MXF	01/74 > 02/78	S 7260 PO	S 1411 N	S 2650 A	
power steering / servosterzo	D 2556 MXF	01/74 > 02/78				S 8790 PO
30.232 VF	D 2566 MF	03/78 > 06/83	S 7260 PO	S 1411 N	S 2650 A	
30.240	D 2556 MXF	03/74 > 12/74	S 7260 PO	S 1411 N	S 2650 A	
power steering / servosterzo	D 2556 MXF	03/74 > 12/74				S 8790 PO
30.240	D 2566 MF	12/76 > 12/84	S 7260 PO	S 1411 N	S 2650 A	
export models / modelli di esportazione	D 2566 MF	12/76 > 12/84	S 7260 PO	S 1411 N	S 6550 A	
power steering / servosterzo	D 2566 MF	12/76 > 12/84				S 8790 PO
30.240 DF	D 2556 MXF	03/74 > 12/74	S 7260 PO	S 1411 N	S 2650 A	
power steering / servosterzo	D 2556 MXF	03/74 > 12/74				S 8790 PO
30.240 DF-TM	D 2556 MXF	03/74 > 12/74	S 7260 PO	S 1411 N	S 2650 A	
power steering / servosterzo	D 2556 MXF	03/74 > 12/74				S 8790 PO
30.240 VF	D 2566 MF	12/76 > 12/84	S 7260 PO	S 1411 N	S 2650 A	

**KW HP****...MAN - trucks/autocarri**

export models / modelli di esportazione	D 2566 MF	12/76 > 12/84	S 7260 PO	S 1411 N	S 6550 A	
power steering / servosterzo	D 2566 MF	12/76 > 12/84				S 8790 PO
30.256	D 2156 MTX 034	05/71 > 12/73	S 0530 PO	S 1411 N		
power steering / servosterzo	D 2156 MTX 034	05/71 > 12/73				S 8790 PO
30.256 DH	D 2156 MTX 034	05/71 > 12/73	S 0530 PO	S 1411 N		
power steering / servosterzo	D 2156 MTX 034	05/71 > 12/73				S 8790 PO
30.256 DHA	D 2156 MTX 034	05/71 > 12/73	S 0530 PO	S 1411 N		
power steering / servosterzo	D 2156 MTX 034	05/71 > 12/73				S 8790 PO
30.281	D 2566 MKF 280	06/80 > 11/85	S 7260 PO	S 1411 N	S 1050 A	
30.281 VF	D 2566 MKF 280	06/80 > 11/85	S 7260 PO	S 1411 N	S 1050 A	
30.291	D 2866 LFZ 290	09/85 > 11/86	S 7260 PO	S 1411 N	S 1050 A	
30.291 VF	D 2866 LFZ 290	09/85 > 11/86	S 7260 PO	S 1411 N	S 1050 A	
30.291 VF-TM	D 2866 LFZ 290	09/85 > 11/86	S 7260 PO	S 1411 N	S 1050 A	
30.304	D 2858 MX 090	05/71 > 12/73	S 2530 PO	S 1411 N		
power steering / servosterzo	D 2858 MX 090	05/71 > 12/73				S 8790 PO
30.304 DFSA	D 2858 MX 090	05/71 > 12/73	S 2530 PO	S 1411 N		
power steering / servosterzo	D 2858 MX 090	05/71 > 12/73				S 8790 PO
30.320	D 2538 MT	03/73 > 10/77		S 1411 N	S 0450 A	
power steering / servosterzo	D 2538 MT	03/73 > 10/77				S 8790 PO
30.320 DH	D 2538 MT	03/73 > 10/77		S 1411 N	S 0450 A	
power steering / servosterzo	D 2538 MT	03/73 > 10/77				S 8790 PO
30.321	D 2566 MKF	06/80 > 11/85	S 7260 PO	S 1411 N	S 1050 A	
30.321 VF	D 2566 MKF	06/80 > 11/85	S 7260 PO	S 1411 N	S 1050 A	
30.331	D 2866 LFZ 330	09/85 > 11/86	S 7260 PO	S 1411 N	S 1050 A	
30.331 VF	D 2866 LFZ 330	09/85 > 11/86	S 7260 PO	S 1411 N	S 1050 A	
30.361	D 2866 KFZ	09/85 > 11/86	S 7260 PO	S 1411 N	S 1050 A	
30.361 VF	D 2866 KFZ	09/85 > 11/86	S 7260 PO	S 1411 N	S 1050 A	
32 t Serie						
32.232	D 2566 M	06/76 > 06/83	S 7260 PO	S 1411 N	S 2650 A	
32.232 DHK	D 2566 M	06/76 > 06/83	S 7260 PO	S 1411 N	S 2650 A	
32.240	D 2566 MF	01/77 > 08/88	S 7260 PO	S 1411 N	S 2650 A	
inner / interno	D 2566 MF	01/77 > 08/88			S 2840 A	
export models / modelli di esportazione	D 2566 MF	01/77 > 08/88	S 7260 PO	S 1411 N	S 6550 A	
power steering / servosterzo	D 2566 MF	01/77 > 08/88				S 8790 PO
32.240 DF	D 2566 MF	01/77 > 08/88	S 7260 PO	S 1411 N	S 2650 A	
inner / interno	D 2566 MF	01/77 > 08/88			S 2840 A	
export models / modelli di esportazione	D 2566 MF	01/77 > 08/88	S 7260 PO	S 1411 N	S 6550 A	
power steering / servosterzo	D 2566 MF	01/77 > 08/88				S 8790 PO
32.262	D 2865 LF 260	02/89 > 02/90	S 7260 PO	S 1411 N	S 1050 A	
spin-on / avvitabile	D 2865 LF 260	02/89 > 02/90	S 7260 PO	S 4378 NR	S 1050 A	
32.262 VF	D 2865 LF 260	02/89 > 02/90	S 7260 PO	S 1411 N	S 1050 A	
spin-on / avvitabile	D 2865 LF 260	02/89 > 02/90	S 7260 PO	S 4378 NR	S 1050 A	
32.272	D 2865 LF 02	02/90 > 05/94	S 7260 PO	S 1411 N	S 1050 A	
spin-on / avvitabile	D 2865 LF 02	02/90 > 05/94	S 7260 PO	S 4378 NR	S 1050 A	
32.272 VF	D 2865 LF 02	02/90 > 05/94	S 7260 PO	S 1411 N	S 1050 A	
spin-on / avvitabile	D 2865 LF 02	02/90 > 05/94	S 7260 PO	S 4378 NR	S 1050 A	
32.280	D 2566 MT	11/77 > 12/81	S 7260 PO	S 1411 N	S 0450 A	
some / alcuni	D 2566 MT	11/77 > 12/81	S 7260 PO	S 1411 N	S 1050 A	
power steering / servosterzo	D 2566 MT	11/77 > 12/81				S 8790 PO
32.280 DH	D 2566 MT	11/77 > 12/81	S 7260 PO	S 1411 N	S 0450 A	
some / alcuni	D 2566 MT	11/77 > 12/81	S 7260 PO	S 1411 N	S 1050 A	
power steering / servosterzo	D 2566 MT	11/77 > 12/81				S 8790 PO
32.280 DHK	D 2566 MT	11/77 > 12/81	S 7260 PO	S 1411 N	S 0450 A	
some / alcuni	D 2566 MT	11/77 > 12/81	S 7260 PO	S 1411 N	S 1050 A	
power steering / servosterzo	D 2566 MT	11/77 > 12/81				S 8790 PO
32.280 DHS	D 2566 MT	11/77 > 12/81	S 7260 PO	S 1411 N	S 0450 A	
some / alcuni	D 2566 MT	11/77 > 12/81	S 7260 PO	S 1411 N	S 1050 A	
power steering / servosterzo	D 2566 MT	11/77 > 12/81				S 8790 PO
32.281	D 2566 MKF 280	02/80 > 11/85	S 7260 PO	S 1411 N	S 1050 A	
32.281 DF	D 2566 MKF 280	02/80 > 11/85	S 7260 PO	S 1411 N	S 1050 A	
32.281 DFK	D 2566 MKF 280	02/80 > 11/85	S 7260 PO	S 1411 N	S 1050 A	
32.281 DFS	D 2566 MKF 280	02/80 > 11/85	S 7260 PO	S 1411 N	S 1050 A	
32.291	D 2866 LFZ 290	09/85 > 08/88	S 7260 PO	S 1411 N	S 1050 A	
32.291 DF	D 2866 LFZ 290	09/85 > 08/88	S 7260 PO	S 1411 N	S 1050 A	
32.292	D 2866 LF 290	03/88 > 02/90	S 7260 PO	S 1411 N	S 1050 A	
spin-on / avvitabile	D 2866 LF 290	03/88 > 02/90	S 7260 PO	S 4378 NR	S 1050 A	
32.292 VF	D 2866 LF 290	03/88 > 02/90	S 7260 PO	S 1411 N	S 1050 A	

M

**KW HP****...MAN - trucks/autocarri**

spin-on / avvitabile	D 2866 LF 290	03/88 > 02/90	S 7260 PO	S 4378 NR	S 1050 A	
32.302	D 2866 LF 04	05/90 > 09/91	S 7260 PO	S 4378 NR	S 1050 A	
32.302 VF	D 2866 LF 04	05/90 > 09/91	S 7260 PO	S 4378 NR	S 1050 A	
32.320	D 2530 MF, D 2530 MXF	01/73 > 12/81		S 1411 N	S 0450 A	
power steering / servosterzo	D 2530 MF, D 2530 MXF	01/73 > 12/81				S 8790 PO
32.320 DFA	D 2530 MF, D 2530 MXF	01/73 > 12/81		S 1411 N	S 0450 A	
power steering / servosterzo	D 2530 MF, D 2530 MXF	01/73 > 12/81				S 8790 PO
32.321	D 2566 MKF	02/80 > 11/85	S 7260 PO	S 1411 N	S 1050 A	
32.321 DF	D 2566 MKF	02/80 > 11/85	S 7260 PO	S 1411 N	S 1050 A	
32.321 DFK	D 2566 MKF	02/80 > 11/85	S 7260 PO	S 1411 N	S 1050 A	
32.321 DFS	D 2566 MKF	02/80 > 11/85	S 7260 PO	S 1411 N	S 1050 A	
32.322	D 2865 LF 03	02/90 > 05/94	S 7260 PO	S 1411 N	S 1050 A	
spin-on / avvitabile	D 2865 LF 03	02/90 > 05/94	S 7260 PO	S 4378 NR	S 1050 A	
32.322 VF	D 2865 LF 03	02/90 > 05/94	S 7260 PO	S 1411 N	S 1050 A	
spin-on / avvitabile	D 2865 LF 03	02/90 > 05/94	S 7260 PO	S 4378 NR	S 1050 A	
32.331	D 2866 LFZ 330	09/85 > 08/88	S 7260 PO	S 1411 N	S 1050 A	
32.331 DF	D 2866 LFZ 330	09/85 > 08/88	S 7260 PO	S 1411 N	S 1050 A	
32.332	D 2866 LF 330	03/88 > 02/90	S 7260 PO	S 1411 N	S 1050 A	
spin-on / avvitabile	D 2866 LF 330	03/88 > 02/90	S 7260 PO	S 4378 NR	S 1050 A	
32.332 VF	D 2866 LF 330	03/88 > 02/90	S 7260 PO	S 1411 N	S 1050 A	
spin-on / avvitabile	D 2866 LF 330	03/88 > 02/90	S 7260 PO	S 4378 NR	S 1050 A	
32.361	D 2866 KFZ	09/83 > 08/88	S 7260 PO	S 1411 N	S 1050 A	
32.361 DF	D 2866 KFZ	09/83 > 08/88	S 7260 PO	S 1411 N	S 1050 A	
32.365	D 2840 MF	06/83 > 08/88	S 7260 PO	S 1411 N	S 1050 A	
some / alcuni	D 2840 MF	06/83 > 08/88	S 7260 PO	S 1411 N	S 7361 A	
32.365 DF	D 2840 MF	06/83 > 08/88	S 7260 PO	S 1411 N	S 1050 A	
some / alcuni	D 2840 MF	06/83 > 08/88	S 7260 PO	S 1411 N	S 7361 A	
32.372	D 2866 LF 03	02/90 > 05/94	S 7260 PO	S 1411 N	S 1050 A	
spin-on / avvitabile	D 2866 LF 03	02/90 > 05/94	S 7260 PO	S 4378 NR	S 1050 A	
32.372 VF	D 2866 LF 03	02/90 > 05/94	S 7260 PO	S 1411 N	S 1050 A	
spin-on / avvitabile	D 2866 LF 03	02/90 > 05/94	S 7260 PO	S 4378 NR	S 1050 A	
32.422	D 2866 LF 06	02/90 > 05/94	S 7260 PO	S 1411 N	S 1050 A	
spin-on / avvitabile	D 2866 LF 06	02/90 > 05/94	S 7260 PO	S 4378 NR	S 1050 A	
32.422 VF	D 2866 LF 06	02/90 > 05/94	S 7260 PO	S 1411 N	S 1050 A	
spin-on / avvitabile	D 2866 LF 06	02/90 > 05/94	S 7260 PO	S 4378 NR	S 1050 A	
33 t Serie						
33.242	D 2866 F 240	01/88 > 08/88	S 7260 PO	S 1411 N	S 1050 A	
spin-on / avvitabile	D 2866 F 240	01/88 > 08/88	S 7260 PO	S 4378 NR	S 1050 A	
33.242 DF	D 2866 F 240	01/88 > 08/88	S 7260 PO	S 1411 N	S 1050 A	
spin-on / avvitabile	D 2866 F 240	01/88 > 08/88	S 7260 PO	S 4378 NR	S 1050 A	
33.262	D 2865 LF 260	01/88 > 02/90	S 7260 PO	S 1411 N	S 1050 A	
spin-on / avvitabile	D 2865 LF 260	01/88 > 02/90	S 7260 PO	S 4378 NR	S 1050 A	
33.262 DF	D 2865 LF 260	01/88 > 02/90	S 7260 PO	S 1411 N	S 1050 A	
spin-on / avvitabile	D 2865 LF 260	01/88 > 02/90	S 7260 PO	S 4378 NR	S 1050 A	
33.272	D 2865 LF 05	10/92 > 04/95	S 7260 PO	S 1411 N	S 1050 A	
spin-on / avvitabile	D 2865 LF 05	10/92 > 04/95	S 7260 PO	S 4378 NR	S 1050 A	
33.272 DF	D 2865 LF 05	10/92 > 04/95	S 7260 PO	S 1411 N	S 1050 A	
spin-on / avvitabile	D 2865 LF 05	10/92 > 04/95	S 7260 PO	S 4378 NR	S 1050 A	
33.292	D 2866 LF 290	09/87 > 02/90	S 7260 PO	S 1411 N	S 1050 A	
spin-on / avvitabile	D 2866 LF 290	09/87 > 02/90	S 7260 PO	S 4378 NR	S 1050 A	
33.292 DF	D 2866 LF 290	09/87 > 02/90	S 7260 PO	S 1411 N	S 1050 A	
spin-on / avvitabile	D 2866 LF 290	09/87 > 02/90	S 7260 PO	S 4378 NR	S 1050 A	
33.321	D 2566 MKF	12/80 > 11/85	S 7260 PO	S 1411 N	S 1050 A	
33.321 VF	D 2566 MKF	12/80 > 11/85	S 7260 PO	S 1411 N	S 1050 A	
33.322	D 2865 LF 03	09/91 > 10/92	S 7260 PO	S 1411 N	S 1050 A	
spin-on / avvitabile	D 2865 LF 03	09/91 > 10/92	S 7260 PO	S 4378 NR	S 1050 A	
33.322 DF	D 2865 LF 03	09/91 > 10/92	S 7260 PO	S 1411 N	S 1050 A	
spin-on / avvitabile	D 2865 LF 03	09/91 > 10/92	S 7260 PO	S 4378 NR	S 1050 A	
33.331	D 2866 LFZ 330	09/85 > 02/90	S 7260 PO	S 1411 N	S 1050 A	
33.331 VF	D 2866 LFZ 330	09/85 > 02/90	S 7260 PO	S 1411 N	S 1050 A	
33.332	D 2866 LF 330	09/87 > 02/90	S 7260 PO	S 1411 N	S 1050 A	
spin-on / avvitabile	D 2866 LF 330	09/87 > 02/90	S 7260 PO	S 4378 NR	S 1050 A	
33.332 DF	D 2866 LF 330	09/87 > 02/90	S 7260 PO	S 1411 N	S 1050 A	
spin-on / avvitabile	D 2866 LF 330	09/87 > 02/90	S 7260 PO	S 4378 NR	S 1050 A	
33.365	D 2840 MF	08/80 > 12/83	S 7260 PO	S 1411 N	S 1050 A	
some / alcuni	D 2840 MF	08/80 > 12/83	S 7260 PO	S 1411 N	S 7361 A	
33.365 DF	D 2840 MF	08/80 > 12/83	S 7260 PO	S 1411 N	S 1050 A	



KW HP



...MAN - trucks/autocarri

some / alcuni	D 2840 MF	08/80 > 12/83	S 7260 PO	S 1411 N	S 7361 A	
33.372	D 2866 LF 03	09/91 > 10/92	S 7260 PO	S 1411 N	S 1050 A	
spin-on / avvitabile	D 2866 LF 03	09/91 > 10/92	S 7260 PO	S 4378 NR	S 1050 A	
33.372 DF	D 2866 LF 03	09/91 > 10/92	S 7260 PO	S 1411 N	S 1050 A	
spin-on / avvitabile	D 2866 LF 03	09/91 > 10/92	S 7260 PO	S 4378 NR	S 1050 A	
33.422	D 2866 LF 06	09/91 > 05/94	S 7260 PO	S 1411 N	S 1050 A	
spin-on / avvitabile	D 2866 LF 06	09/91 > 05/94	S 7260 PO	S 4378 NR	S 1050 A	
33.422 DF	D 2866 LF 06	09/91 > 05/94	S 7260 PO	S 1411 N	S 1050 A	
spin-on / avvitabile	D 2866 LF 06	09/91 > 05/94	S 7260 PO	S 4378 NR	S 1050 A	
33.462	D 2840 LF 460	07/89 > 02/90	S 7260 PO	S 1411 N	S 0450 A	
spin-on / avvitabile	D 2840 LF 460	07/89 > 02/90	S 7260 PO	S 4378 NR	S 0450 A	
33.462 DF	D 2840 LF 460	07/89 > 02/90	S 7260 PO	S 1411 N	S 0450 A	
spin-on / avvitabile	D 2840 LF 460	07/89 > 02/90	S 7260 PO	S 4378 NR	S 0450 A	
33.502	D 2840 LF 01	09/91 > 10/92	S 7260 PO	S 1411 N	S 0450 A	
spin-on / avvitabile	D 2840 LF 01	09/91 > 10/92	S 7260 PO	S 4378 NR	S 0450 A	
33.502 DF	D 2840 LF 01	09/91 > 10/92	S 7260 PO	S 1411 N	S 0450 A	
spin-on / avvitabile	D 2840 LF 01	09/91 > 10/92	S 7260 PO	S 4378 NR	S 0450 A	
35 t Serie						
35.262	D 2865 LF 260	02/89 > 02/90	S 7260 PO	S 1411 N	S 1050 A	
spin-on / avvitabile	D 2865 LF 260	02/89 > 02/90	S 7260 PO	S 4378 NR	S 1050 A	
35.262 VF	D 2865 LF 260	02/89 > 02/90	S 7260 PO	S 1411 N	S 1050 A	
spin-on / avvitabile	D 2865 LF 260	02/89 > 02/90	S 7260 PO	S 4378 NR	S 1050 A	
35.272	D 2865 LF 02	02/90 > 12/91	S 7260 PO	S 1411 N	S 1050 A	
spin-on / avvitabile	D 2865 LF 02	02/90 > 12/91	S 7260 PO	S 4378 NR	S 1050 A	
35.272 VF	D 2865 LF 02	02/90 > 12/91	S 7260 PO	S 1411 N	S 1050 A	
spin-on / avvitabile	D 2865 LF 02	02/90 > 12/91	S 7260 PO	S 4378 NR	S 1050 A	
35.292	D 2866 LFZ 290	10/88 > 04/95	S 7260 PO	S 1411 N	S 1050 A	
spin-on / avvitabile	D 2866 LFZ 290	10/88 > 04/95	S 7260 PO	S 4378 NR	S 1050 A	
35.292 VF	D 2866 LFZ 290	10/88 > 04/95	S 7260 PO	S 1411 N	S 1050 A	
spin-on / avvitabile	D 2866 LFZ 290	10/88 > 04/95	S 7260 PO	S 4378 NR	S 1050 A	
35.302	D 2866 LF 04	05/90 > 09/91	S 7260 PO	S 1411 N	S 1050 A	
spin-on / avvitabile	D 2866 LF 04	05/90 > 09/91	S 7260 PO	S 4378 NR	S 1050 A	
35.302 VF	D 2866 LF 04	05/90 > 09/91	S 7260 PO	S 1411 N	S 1050 A	
spin-on / avvitabile	D 2866 LF 04	05/90 > 09/91	S 7260 PO	S 4378 NR	S 1050 A	
35.322	D 2865 LF 03	02/90 > 05/94	S 7260 PO	S 1411 N	S 1050 A	
spin-on / avvitabile	D 2865 LF 03	02/90 > 05/94	S 7260 PO	S 4378 NR	S 1050 A	
35.322 VF	D 2865 LF 03	02/90 > 05/94	S 7260 PO	S 1411 N	S 1050 A	
spin-on / avvitabile	D 2865 LF 03	02/90 > 05/94	S 7260 PO	S 4378 NR	S 1050 A	
35.332	D 2866 LFZ 330	10/88 > 04/95	S 7260 PO	S 1411 N	S 1050 A	
spin-on / avvitabile	D 2866 LFZ 330	10/88 > 04/95	S 7260 PO	S 4378 NR	S 1050 A	
35.332 VF	D 2866 LFZ 330	10/88 > 04/95	S 7260 PO	S 1411 N	S 1050 A	
spin-on / avvitabile	D 2866 LFZ 330	10/88 > 04/95	S 7260 PO	S 4378 NR	S 1050 A	
35.362	D 2866 LXF	10/88 > 02/90	S 7260 PO	S 1411 N	S 1050 A	
spin-on / avvitabile	D 2866 LXF	10/88 > 02/90	S 7260 PO	S 4378 NR	S 1050 A	
35.362 VF	D 2866 LXF	10/88 > 02/90	S 7260 PO	S 1411 N	S 1050 A	
spin-on / avvitabile	D 2866 LXF	10/88 > 02/90	S 7260 PO	S 4378 NR	S 1050 A	
35.372	D 2866 LF 03	02/90 > 05/94	S 7260 PO	S 1411 N	S 1050 A	
spin-on / avvitabile	D 2866 LF 03	02/90 > 05/94	S 7260 PO	S 4378 NR	S 1050 A	
35.372 VF	D 2866 LF 03	02/90 > 05/94	S 7260 PO	S 1411 N	S 1050 A	
spin-on / avvitabile	D 2866 LF 03	02/90 > 05/94	S 7260 PO	S 4378 NR	S 1050 A	
35.422	D 2866 LF 06	02/90 > 05/94	S 7260 PO	S 1411 N	S 1050 A	
spin-on / avvitabile	D 2866 LF 06	02/90 > 05/94	S 7260 PO	S 4378 NR	S 1050 A	
35.422 VF	D 2866 LF 06	02/90 > 05/94	S 7260 PO	S 1411 N	S 1050 A	
spin-on / avvitabile	D 2866 LF 06	02/90 > 05/94	S 7260 PO	S 4378 NR	S 1050 A	
38 t Serie						
38.320	D 2530 MF, D 2530 MXF	05/76 > 01/83		S 1411 N	S 0450 A	
38.320 DFAK	D 2530 MF, D 2530 MXF	05/76 > 01/83		S 1411 N	S 0450 A	
4 t Serie						
4.70	Saviem 712.03	01/73 > 09/77	S 6290 PO	S 9091 N		
4.70 F	Saviem 712.03	01/73 > 09/77	S 6290 PO	S 9091 N		
4.70 FK	Saviem 712.03	01/73 > 09/77	S 6290 PO	S 9091 N		
4.85	Saviem		S 6290 PO	S 9091 N		
40 t Serie						
40.362	D 2866 LXF	10/88 > 02/90	S 7260 PO	S 1411 N	S 1050 A	
spin-on / avvitabile	D 2866 LXF	10/88 > 02/90	S 7260 PO	S 4378 NR	S 1050 A	
40.362 VF	D 2866 LXF	10/88 > 02/90	S 7260 PO	S 1411 N	S 1050 A	
spin-on / avvitabile	D 2866 LXF	10/88 > 02/90	S 7260 PO	S 4378 NR	S 1050 A	

M





kW HP



...MAN - trucks/autocarri

M

40.365	D 2840 MF	04/83 > 11/87	S 7260 PO	S 1411 N	S 1050 A	
some / alcuni	D 2840 MF	04/83 > 11/87	S 7260 PO	S 1411 N	S 7361 A	
40.365 DF	D 2840 MF	04/83 > 11/87	S 7260 PO	S 1411 N	S 1050 A	
some / alcuni	D 2840 MF	04/83 > 11/87	S 7260 PO	S 1411 N	S 7361 A	
40.372	D 2866 LF 03	12/91 > 10/92	S 7260 PO	S 1411 N	S 1050 A	
spin-on / avvitabile	D 2866 LF 03	12/91 > 10/92	S 7260 PO	S 4378 NR	S 1050 A	
40.372 DF	D 2866 LF 03	12/91 > 10/92	S 7260 PO	S 1411 N	S 1050 A	
spin-on / avvitabile	D 2866 LF 03	12/91 > 10/92	S 7260 PO	S 4378 NR	S 1050 A	
40.400	D 2530 MTXF	06/79 > 12/82		S 1411 N	S 0450 A	
outer / esterno	D 2530 MTXF	06/79 > 12/82		S 1411 N	S 7361 A	
40.400	D 2540	10/81 > 06/90		S 1411 N	S 7361 A	
40.400 DF	D 2530 MTXF	06/79 > 12/82		S 1411 N	S 0450 A	
outer / esterno	D 2530 MTXF	06/79 > 12/82		S 1411 N	S 7361 A	
40.422	D 2866 LF 06	12/91 > 10/92	S 7260 PO	S 1411 N	S 1050 A	
spin-on / avvitabile	D 2866 LF 06	12/91 > 10/92	S 7260 PO	S 4378 NR	S 1050 A	
40.422 DF	D 2866 LF 06	12/91 > 10/92	S 7260 PO	S 1411 N	S 1050 A	
spin-on / avvitabile	D 2866 LF 06	12/91 > 10/92	S 7260 PO	S 4378 NR	S 1050 A	
40.440	D 2540 MTF	10/81 > 06/90		S 1411 N	S 7361 A	
40.440 DF	D 2540 MTF	10/81 > 06/90		S 1411 N	S 7361 A	
40.462	D 2840 LF 460	07/89 > 02/90	S 7260 PO	S 1411 N	S 0450 A	
spin-on / avvitabile	D 2840 LF 460	07/89 > 02/90	S 7260 PO	S 4378 NR	S 0450 A	
40.462 DFA	D 2840 LF 460	07/89 > 02/90	S 7260 PO	S 1411 N	S 0450 A	
spin-on / avvitabile	D 2840 LF 460	07/89 > 02/90	S 7260 PO	S 4378 NR	S 0450 A	
40.502	D 2840 LF 01	02/90 > 10/92	S 7260 PO	S 1411 N	S 0450 A	
spin-on / avvitabile	D 2840 LF 01	02/90 > 10/92	S 7260 PO	S 4378 NR	S 0450 A	
40.502 DFA	D 2840 LF 01	02/90 > 10/92	S 7260 PO	S 1411 N	S 0450 A	
spin-on / avvitabile	D 2840 LF 01	02/90 > 10/92	S 7260 PO	S 4378 NR	S 0450 A	
400						
400	D 0026 (N.100473/1 -)		S 0530 PO	S 7411 N		
41 t Serie						
41.262	D 2865 LF 260	07/89 > 02/90	S 7260 PO	S 1411 N	S 1050 A	
spin-on / avvitabile	D 2865 LF 260	07/89 > 02/90	S 7260 PO	S 4378 NR	S 1050 A	
41.262 VF	D 2865 LF 260	07/89 > 02/90	S 7260 PO	S 1411 N	S 1050 A	
spin-on / avvitabile	D 2865 LF 260	07/89 > 02/90	S 7260 PO	S 4378 NR	S 1050 A	
41.272	D 2865 LF 02	02/90 > 12/91	S 7260 PO	S 1411 N	S 1050 A	
spin-on / avvitabile	D 2865 LF 02	02/90 > 12/91	S 7260 PO	S 4378 NR	S 1050 A	
41.272 VF	D 2865 LF 02	02/90 > 12/91	S 7260 PO	S 1411 N	S 1050 A	
spin-on / avvitabile	D 2865 LF 02	02/90 > 12/91	S 7260 PO	S 4378 NR	S 1050 A	
41.292	D 2866 LF 290	10/88 > 02/90	S 7260 PO	S 1411 N	S 1050 A	
spin-on / avvitabile	D 2866 LF 290	10/88 > 02/90	S 7260 PO	S 4378 NR	S 1050 A	
41.292 VF	D 2866 LF 290	10/88 > 02/90	S 7260 PO	S 1411 N	S 1050 A	
spin-on / avvitabile	D 2866 LF 290	10/88 > 02/90	S 7260 PO	S 4378 NR	S 1050 A	
41.322	D 2865 LF 03	02/90 > 05/94	S 7260 PO	S 1411 N	S 1050 A	
spin-on / avvitabile	D 2865 LF 03	02/90 > 05/94	S 7260 PO	S 4378 NR	S 1050 A	
41.322 VF	D 2865 LF 03	02/90 > 05/94	S 7260 PO	S 1411 N	S 1050 A	
spin-on / avvitabile	D 2865 LF 03	02/90 > 05/94	S 7260 PO	S 4378 NR	S 1050 A	
41.332	D 2866 LF 330	10/88 > 02/90	S 7260 PO	S 1411 N	S 1050 A	
spin-on / avvitabile	D 2866 LF 330	10/88 > 02/90	S 7260 PO	S 4378 NR	S 1050 A	
41.332 VF	D 2866 LF 330	10/88 > 02/90	S 7260 PO	S 1411 N	S 1050 A	
spin-on / avvitabile	D 2866 LF 330	10/88 > 02/90	S 7260 PO	S 4378 NR	S 1050 A	
41.361	D 2866 KFZ	01/85 > 09/90	S 7260 PO	S 1411 N	S 1050 A	
41.361 VFS	D 2866 KFZ	01/85 > 09/90	S 7260 PO	S 1411 N	S 1050 A	
41.372	D 2866 LF 03	02/90 > 05/94	S 7260 PO	S 1411 N	S 1050 A	
spin-on / avvitabile	D 2866 LF 03	02/90 > 05/94	S 7260 PO	S 4378 NR	S 1050 A	
41.372 VF	D 2866 LF 03	02/90 > 05/94	S 7260 PO	S 1411 N	S 1050 A	
spin-on / avvitabile	D 2866 LF 03	02/90 > 05/94	S 7260 PO	S 4378 NR	S 1050 A	
41.422	D 2866 LF 06	02/90 > 05/94	S 7260 PO	S 1411 N	S 1050 A	
spin-on / avvitabile	D 2866 LF 06	02/90 > 05/94	S 7260 PO	S 4378 NR	S 1050 A	
41.422 VF	D 2866 LF 06	02/90 > 05/94	S 7260 PO	S 1411 N	S 1050 A	
spin-on / avvitabile	D 2866 LF 06	02/90 > 05/94	S 7260 PO	S 4378 NR	S 1050 A	
415						
415	D 0026 (N.100473/1 -)		S 0530 PO	S 7411 N		
475						
475	Saviem		S 6290 PO	S 9091 N		
48 t Serie						
48.292	D 2866 LF 290	07/89 > 02/90	S 7260 PO	S 1411 N	S 1050 A	
spin-on / avvitabile	D 2866 LF 290	07/89 > 02/90	S 7260 PO	S 4378 NR	S 1050 A	



kW HP



...MAN - trucks/autocarri

48.292 VF	D 2866 LF 290	07/89 > 02/90	S 7260 PO	S 1411 N	S 1050 A	
spin-on / avvitabile	D 2866 LF 290	07/89 > 02/90	S 7260 PO	S 4378 NR	S 1050 A	
48.321	D 2566 MK/MKF	04/83 > 11/85	S 7260 PO	S 1411 N	S 1050 A	
48.321 VFAK	D 2566 MK/MKF	04/83 > 11/85	S 7260 PO	S 1411 N	S 1050 A	
48.322	D 2865 LF 03	02/90 > 05/94	S 7260 PO	S 1411 N	S 1050 A	
spin-on / avvitabile	D 2865 LF 03	02/90 > 05/94	S 7260 PO	S 4378 NR	S 1050 A	
48.322 VF	D 2865 LF 03	02/90 > 05/94	S 7260 PO	S 1411 N	S 1050 A	
spin-on / avvitabile	D 2865 LF 03	02/90 > 05/94	S 7260 PO	S 4378 NR	S 1050 A	
48.331	D 2866 LFZ 330	09/85 > 06/90	S 7260 PO	S 1411 N	S 1050 A	
spin-on / avvitabile	D 2866 LFZ 330	09/85 > 06/90	S 7260 PO	S 4378 NR	S 1050 A	
48.331 VFAK	D 2866 LFZ 330	09/85 > 06/90	S 7260 PO	S 1411 N	S 1050 A	
spin-on / avvitabile	D 2866 LFZ 330	09/85 > 06/90	S 7260 PO	S 4378 NR	S 1050 A	
48.332	D 2866 LF 330	07/89 > 02/90	S 7260 PO	S 1411 N	S 1050 A	
spin-on / avvitabile	D 2866 LF 330	07/89 > 02/90	S 7260 PO	S 4378 NR	S 1050 A	
48.332 VF	D 2866 LF 330	07/89 > 02/90	S 7260 PO	S 1411 N	S 1050 A	
spin-on / avvitabile	D 2866 LF 330	07/89 > 02/90	S 7260 PO	S 4378 NR	S 1050 A	
48.372	D 2866 LF 03	02/90 > 05/94	S 7260 PO	S 1411 N	S 1050 A	
spin-on / avvitabile	D 2866 LF 03	02/90 > 05/94	S 7260 PO	S 4378 NR	S 1050 A	
48.372 VF	D 2866 LF 03	02/90 > 05/94	S 7260 PO	S 1411 N	S 1050 A	
spin-on / avvitabile	D 2866 LF 03	02/90 > 05/94	S 7260 PO	S 4378 NR	S 1050 A	
48.422	D 2866 LF 06	02/90 > 05/94	S 7260 PO	S 1411 N	S 1050 A	
spin-on / avvitabile	D 2866 LF 06	02/90 > 05/94	S 7260 PO	S 4378 NR	S 1050 A	
48.422 VF	D 2866 LF 06	02/90 > 05/94	S 7260 PO	S 1411 N	S 1050 A	
spin-on / avvitabile	D 2866 LF 06	02/90 > 05/94	S 7260 PO	S 4378 NR	S 1050 A	
48.462	D 2840 LF 460	07/89 > 02/90	S 7260 PO	S 1411 N	S 0450 A	
spin-on / avvitabile	D 2840 LF 460	07/89 > 02/90	S 7260 PO	S 4378 NR	S 0450 A	
48.462 VF	D 2840 LF 460	07/89 > 02/90	S 7260 PO	S 1411 N	S 0450 A	
spin-on / avvitabile	D 2840 LF 460	07/89 > 02/90	S 7260 PO	S 4378 NR	S 0450 A	
48.502	D 2840 LF 01	02/90 > 10/92	S 7260 PO	S 1411 N	S 0450 A	
spin-on / avvitabile	D 2840 LF 01	02/90 > 12/92	S 7260 PO	S 4378 NR	S 0450 A	
48.502 DFA	D 2840 LF 01	02/90 > 10/92	S 7260 PO	S 1411 N	S 0450 A	
spin-on / avvitabile	D 2840 LF 01	02/90 > 12/92	S 7260 PO	S 4378 NR	S 0450 A	
48.700	D 2842			S 1411 N	S 1050 A	
some / alcuni	D 2842		S 7260 PO	S 1411 N	S 1050 A	
5 t Serie						
5.126	Saviem 597.02	09/67 > 10/69	S 3241 R	S 1411 N		
other assembly / altro montaggio	Saviem 597.02	09/67 > 10/69	S 3241 R			
assembly DELPHI / montaggio DELPHI	Saviem 597.02	09/67 > 10/69	S 3241 R	S 7111 NC		
power steering / servosterzo	Saviem 597.02	09/67 > 10/69				S 8790 PO
5.126 F	Saviem 597.02	09/67 > 10/69	S 3241 R	S 1411 N		
other assembly / altro montaggio	Saviem 597.02	09/67 > 10/69	S 3241 R			
assembly DELPHI / montaggio DELPHI	Saviem 597.02	09/67 > 10/69	S 3241 R	S 7111 NC		
power steering / servosterzo	Saviem 597.02	09/67 > 10/69				S 8790 PO
5.126 FK	Saviem 597.02	09/67 > 10/69	S 3241 R	S 1411 N		
other assembly / altro montaggio	Saviem 597.02	09/67 > 10/69	S 3241 R			
assembly DELPHI / montaggio DELPHI	Saviem 597.02	09/67 > 10/69	S 3241 R	S 7111 NC		
power steering / servosterzo	Saviem 597.02	09/67 > 10/69				S 8790 PO
5.70	Saviem 712.04	01/73 > 03/77	S 6290 PO	S 9091 N		
5.70 F	Saviem 712.04	01/73 > 03/77	S 6290 PO	S 9091 N		
5.85	Saviem		S 6290 PO	S 9091 N		
520						
520	D 0026 (N.100473/1 -)		S 0530 PO	S 7411 N		
6 t Serie						
6.115	D 0026		S 0530 PO	S 7411 N		
6.126	Saviem 597.02	09/67 > 10/69	S 3241 R	S 1411 N		
other assembly / altro montaggio	Saviem 597.02	09/67 > 10/69	S 3241 R			
assembly DELPHI / montaggio DELPHI	Saviem 597.02	09/67 > 10/69	S 3241 R	S 7111 NC		
power steering / servosterzo	Saviem 597.02	09/67 > 10/69				S 8790 PO
6.126 F	Saviem 597.02	09/67 > 10/69	S 3241 R	S 1411 N		
other assembly / altro montaggio	Saviem 597.02	09/67 > 10/69	S 3241 R			
assembly DELPHI / montaggio DELPHI	Saviem 597.02	09/67 > 10/69	S 3241 R	S 7111 NC		
power steering / servosterzo	Saviem 597.02	09/67 > 10/69				S 8790 PO
6.90	D 0224 MF	10/79 > 09/87	S 5536 PO	S 4323 NR	S 0950 A	
2nd passage / 2.passaggio	D 0224 MF	10/79 > 09/87		S 4378 NR		
6.90	Saviem 720	04/73 > 03/77	S 6290 PO	S 7111 NC		
6.90 F	D 0224 MF	10/79 > 09/87	S 5536 PO	S 4323 NR	S 0950 A	
2nd passage / 2.passaggio	D 0224 MF	10/79 > 09/87		S 4378 NR		

M





kW HP



...MAN - trucks/autocarri

M

6.90 F	Saviem 720	04/73 > 03/77	S 6290 PO	S 7111 NC		
7 t Serie						
7.126	Saviem 597.03	03/70 > 12/70	S 3241 R	S 1411 N		
other assembly / altro montaggio	Saviem 597.03	03/70 > 12/70	S 3241 R			
assembly DELPHI / montaggio DELPHI	Saviem 597.03	03/70 > 12/70	S 3241 R	S 7111 NC		
power steering / servosterzo	Saviem 597.03	03/70 > 12/70				S 8790 PO
7.126 H	Saviem 597.03	03/70 > 12/70	S 3241 R	S 1411 N		
other assembly / altro montaggio	Saviem 597.03	03/70 > 12/70	S 3241 R			
assembly DELPHI / montaggio DELPHI	Saviem 597.03	03/70 > 12/70	S 3241 R	S 7111 NC		
power steering / servosterzo	Saviem 597.03	03/70 > 12/70				S 8790 PO
7.136	Saviem 797.02	04/71 > 12/74	S 3241 R	S 1411 N		
other assembly / altro montaggio	Saviem 797.02	04/71 > 12/74	S 3241 R			
assembly DELPHI / montaggio DELPHI	Saviem 797.02	04/71 > 12/74	S 3241 R	S 7111 NC		
power steering / servosterzo	Saviem 797.02	04/71 > 12/74				S 8790 PO
7.136 F	Saviem 797.02	04/71 > 12/74	S 3241 R	S 1411 N		
other assembly / altro montaggio	Saviem 797.02	04/71 > 12/74	S 3241 R			
assembly DELPHI / montaggio DELPHI	Saviem 797.02	04/71 > 12/74	S 3241 R	S 7111 NC		
power steering / servosterzo	Saviem 797.02	04/71 > 12/74				S 8790 PO
7.136 FK	Saviem 797.02	04/71 > 12/74	S 3241 R	S 1411 N		
other assembly / altro montaggio	Saviem 797.02	04/71 > 12/74	S 3241 R			
assembly DELPHI / montaggio DELPHI	Saviem 797.02	04/71 > 12/74	S 3241 R	S 7111 NC		
power steering / servosterzo	Saviem 797.02	04/71 > 12/74				S 8790 PO
7.85	Saviem		S 6290 PO	S 9091 N		
7.90	Saviem 720	04/73 > 09/77	S 6290 PO	S 7111 NC		
7.90 F	Saviem 720	04/73 > 09/77	S 6290 PO	S 7111 NC		
7.90 FK	Saviem 720	04/73 > 09/77	S 6290 PO	S 7111 NC		
8 t Serie						
8.104	D 0824	11/94 >	S 3292 R	S 4378 NR	S 2450 A	
8.136	D 0226 MF	10/79 > 09/87	S 5536 PO	S 4323 NR	S 0950 A	
2nd passage / 2.passaggio	D 0226 MF	10/79 > 09/87		S 4378 NR		
8.136 F	D 0226 MF	10/79 > 09/87	S 5536 PO	S 4323 NR	S 0950 A	
2nd passage / 2.passaggio	D 0226 MF	10/79 > 09/87		S 4378 NR		
8.160						
1st passage / 1.passaggio	D 0846 HMN	01/70 > 04/71		S 0101 N		
2nd passage / 2.passaggio	D 0846 HMN	01/70 > 04/71		S 7411 N		
8.160 F						
1st passage / 1.passaggio	D 0846 HMN	01/70 > 04/71		S 0101 N		
2nd passage / 2.passaggio	D 0846 HMN	01/70 > 04/71		S 7411 N		
8.170	D 0226 MCGO 170	09/85 > 09/89	S 5536 PO	S 4323 NR		
2nd passage / 2.passaggio	D 0226 MCGO 170	09/85 > 09/89		S 4378 NR		
8.170	D 0826	10/92 > 10/93	S 3292 R	S 4378 NR	S 2650 A	
8.170 FOC	D 0226 MCGO 170	09/85 > 09/89	S 5536 PO	S 4323 NR		
2nd passage / 2.passaggio	D 0226 MCGO 170	09/85 > 09/89		S 4378 NR		
8.170 FOC	D 0826	10/92 > 10/93	S 3292 R	S 4378 NR	S 2650 A	
8.90	D 0224 MF	10/79 > 09/87	S 5536 PO	S 4323 NR	S 0950 A	
2nd passage / 2.passaggio	D 0224 MF	10/79 > 09/87		S 4378 NR		
8.90 F	D 0224 MF	10/79 > 09/87	S 5536 PO	S 4323 NR	S 0950 A	
2nd passage / 2.passaggio	D 0224 MF	10/79 > 09/87		S 4378 NR		
9 t Serie						
9.126	Saviem 597.03	03/70 > 12/70	S 3241 R	S 1411 N		
other assembly / altro montaggio	Saviem 597.03	03/70 > 12/70	S 3241 R			
assembly DELPHI / montaggio DELPHI	Saviem 597.03	03/70 > 12/70	S 3241 R	S 7111 NC		
power steering / servosterzo	Saviem 597.03	03/70 > 12/70				S 8790 PO
9.126 H	Saviem 597.03	03/70 > 12/70	S 3241 R	S 1411 N		
other assembly / altro montaggio	Saviem 597.03	03/70 > 12/70	S 3241 R			
assembly DELPHI / montaggio DELPHI	Saviem 597.03	03/70 > 12/70	S 3241 R	S 7111 NC		
power steering / servosterzo	Saviem 597.03	03/70 > 12/70				S 8790 PO
9.126 HA	Saviem 597.03	03/70 > 12/70	S 3241 R	S 1411 N		
other assembly / altro montaggio	Saviem 597.03	03/70 > 12/70	S 3241 R			
assembly DELPHI / montaggio DELPHI	Saviem 597.03	03/70 > 12/70	S 3241 R	S 7111 NC		
power steering / servosterzo	Saviem 597.03	03/70 > 12/70				S 8790 PO
9.126 HK	Saviem 597.03	03/70 > 12/70	S 3241 R	S 1411 N		
other assembly / altro montaggio	Saviem 597.03	03/70 > 12/70	S 3241 R			
assembly DELPHI / montaggio DELPHI	Saviem 597.03	03/70 > 12/70	S 3241 R	S 7111 NC		
power steering / servosterzo	Saviem 597.03	03/70 > 12/70				S 8790 PO
9.126 HKA	Saviem 597.03	03/70 > 12/70	S 3241 R	S 1411 N		
other assembly / altro montaggio	Saviem 597.03	03/70 > 12/70	S 3241 R			



KW HP



...MAN - trucks/autocarri

assembly DELPHI / montaggio DELPHI	Saviem 597.03	03/70 > 12/70	S 3241 R	S 7111 NC		
power steering / servosterzo	Saviem 597.03	03/70 > 12/70				S 8790 PO
9.126 HS	Saviem 597.03	03/70 > 12/70	S 3241 R	S 1411 N		
other assembly / altro montaggio	Saviem 597.03	03/70 > 12/70	S 3241 R			
assembly DELPHI / montaggio DELPHI	Saviem 597.03	03/70 > 12/70	S 3241 R	S 7111 NC		
power steering / servosterzo	Saviem 597.03	03/70 > 12/70				S 8790 PO
9.126 HSA	Saviem 597.03	03/70 > 12/70	S 3241 R	S 1411 N		
other assembly / altro montaggio	Saviem 597.03	03/70 > 12/70	S 3241 R			
assembly DELPHI / montaggio DELPHI	Saviem 597.03	03/70 > 12/70	S 3241 R	S 7111 NC		
power steering / servosterzo	Saviem 597.03	03/70 > 12/70				S 8790 PO
9.136	D 0226 MF	10/79 > 09/87	S 5536 PO	S 1411 N	S 0950 A	
spin-on / avvitabile	D 0226 MF	10/79 > 09/87	S 5536 PO	S 4378 NR	S 0950 A	
9.136	Saviem 797.02	04/71 > 12/74	S 3241 R	S 1411 N		
other assembly / altro montaggio	Saviem 797.02	04/71 > 12/74	S 3241 R			
assembly DELPHI / montaggio DELPHI	Saviem 797.02	04/71 > 12/74	S 3241 R	S 7111 NC		
power steering / servosterzo	Saviem 797.02	04/71 > 12/74				S 8790 PO
9.136 F	D 0226 MF	10/79 > 09/87	S 5536 PO	S 1411 N	S 0950 A	
spin-on / avvitabile	D 0226 MF	10/79 > 09/87	S 5536 PO	S 4378 NR	S 0950 A	
9.136 F	Saviem 797.02	04/71 > 12/74	S 3241 R	S 1411 N		
other assembly / altro montaggio	Saviem 797.02	04/71 > 12/74	S 3241 R			
assembly DELPHI / montaggio DELPHI	Saviem 797.02	04/71 > 12/74	S 3241 R	S 7111 NC		
power steering / servosterzo	Saviem 797.02	04/71 > 12/74				S 8790 PO
9.170	D 0226 MCFO 170	09/85 > 09/89	S 5536 PO	S 4323 NR	S 2650 A	
2nd passage / 2.passaggio	D 0226 MCFO 170	09/85 > 09/89		S 4378 NR		
9.170 FOC	D 0226 MCFO 170	09/85 > 09/89	S 5536 PO	S 4323 NR	S 2650 A	
2nd passage / 2.passaggio	D 0226 MCFO 170	09/85 > 09/89		S 4378 NR		
9.186	D 2146	01/70 > 06/71	S 0530 PO	S 1411 N		
power steering / servosterzo	D 2146	01/70 > 06/71				S 8790 PO
9.186 F	D 2146	01/70 > 06/71	S 0530 PO	S 1411 N		
power steering / servosterzo	D 2146	01/70 > 06/71				S 8790 PO
E2000 Serie						
28.293 FNL	D 2865 LF 24	09/96 >	S 5016 PE	S 4378 NR	S 1970 A	S 3053 C
with gearbox ZF Ecosplit and Intarder / con cambio ZF Ecosplit e Intarder	D 2865 LF 24	09/96 >				S 2234 Z
dryer filter / filtro essiccatore	D 2865 LF 24	09/96 >				S 7259 A
inner / interno	D 2865 LF 24	09/96 >			S 7405 A	
prefilter with fuel oil heater / prefiltra con riscaldatore nafta	D 2865 LF 24	09/96 >		S 6059 NE		
prefilter without fuel oil heater / prefiltra senza riscaldatore nafta	D 2865 LF 24	09/96 >		S 6062 NE		
power steering / servosterzo	D 2865 LF 24	09/96 >				S 3081 PO
28.314 FNLC	D 2866 LF 34	07/99 >	S 5016 PE	S 4378 NR	S 1970 A	S 3053 C
with gearbox ZF Ecosplit and Intarder / con cambio ZF Ecosplit e Intarder	D 2866 LF 34	07/99 >				S 2234 Z
dryer filter / filtro essiccatore	D 2866 LF 34	07/99 >				S 7259 A
inner / interno	D 2866 LF 34	07/99 >			S 7405 A	
prefilter with fuel oil heater / prefiltra con riscaldatore nafta	D 2866 LF 34	07/99 >		S 6059 NE		
prefilter without fuel oil heater / prefiltra senza riscaldatore nafta	D 2866 LF 34	07/99 >		S 6062 NE		
power steering / servosterzo	D 2866 LF 34	07/99 >				S 3081 PO
28.343 FA	D 2865 LF 21	09/96 >	S 5016 PE	S 4378 NR	S 1970 A	S 3053 C
with gearbox ZF Ecosplit and Intarder / con cambio ZF Ecosplit e Intarder	D 2865 LF 21	09/96 >				S 2234 Z
dryer filter / filtro essiccatore	D 2865 LF 21	09/96 >				S 7259 A
inner / interno	D 2865 LF 21	09/96 >			S 7405 A	
prefilter with fuel oil heater / prefiltra con riscaldatore nafta	D 2865 LF 21	09/96 >		S 6059 NE		
prefilter without fuel oil heater / prefiltra senza riscaldatore nafta	D 2865 LF 21	09/96 >		S 6062 NE		
power steering / servosterzo	D 2865 LF 21	09/96 >				S 3081 PO
28.343 FN	D 2865 LF 21	09/96 >	S 5016 PE	S 4378 NR	S 1970 A	S 3053 C
with gearbox ZF Ecosplit and Intarder / con cambio ZF Ecosplit e Intarder	D 2865 LF 21	09/96 >				S 2234 Z
dryer filter / filtro essiccatore	D 2865 LF 21	09/96 >				S 7259 A
inner / interno	D 2865 LF 21	09/96 >			S 7405 A	
prefilter with fuel oil heater / prefiltra con riscaldatore nafta	D 2865 LF 21	09/96 >		S 6059 NE		
prefilter without fuel oil heater / prefiltra senza riscaldatore nafta	D 2865 LF 21	09/96 >		S 6062 NE		
power steering / servosterzo	D 2865 LF 21	09/96 >				S 3081 PO
28.403 FA	D 2866 LF 20	09/96 >	S 5016 PE	S 4378 NR	S 1970 A	S 3053 C
with gearbox ZF Ecosplit and Intarder / con cambio ZF Ecosplit e Intarder	D 2866 LF 20	09/96 >				S 2234 Z
dryer filter / filtro essiccatore	D 2866 LF 20	09/96 >				S 7259 A
inner / interno	D 2866 LF 20	09/96 >			S 7405 A	
prefilter with fuel oil heater / prefiltra con riscaldatore nafta	D 2866 LF 20	09/96 >		S 6059 NE		
prefilter without fuel oil heater / prefiltra senza riscaldatore nafta	D 2866 LF 20	09/96 >		S 6062 NE		
power steering / servosterzo	D 2866 LF 20	09/96 >				S 3081 PO
28.403 FN	D 2866 LF 20	09/96 >	S 5016 PE	S 4378 NR	S 1970 A	S 3053 C

M





KW HP



...MAN - trucks/autocarri

M



with gearbox ZF Ecosplit and Intarder / con cambio ZF Ecosplit e Intarder	D 2866 LF 20	09/96 >				S 2234 Z
dryer filter / filtro essiccatore	D 2866 LF 20	09/96 >				S 7259 A
inner / interno	D 2866 LF 20	09/96 >			S 7405 A	
prefilter with fuel oil heater / prefiltra con riscaldatore nafta	D 2866 LF 20	09/96 >		S 6059 NE		
prefilter without fuel oil heater / prefiltra senza riscaldatore nafta	D 2866 LF 20	09/96 >		S 6062 NE		
power steering / servosterzo	D 2866 LF 20	09/96 >				S 3081 PO
28.463 FA	D 2876 LF 02	09/96 >	S 5016 PE	S 4378 NR	S 1970 A	S 3053 C
with gearbox ZF Ecosplit and Intarder / con cambio ZF Ecosplit e Intarder	D 2876 LF 02	09/96 >				S 2234 Z
dryer filter / filtro essiccatore	D 2876 LF 02	09/96 >				S 7259 A
inner / interno	D 2876 LF 02	09/96 >			S 7405 A	
prefilter with fuel oil heater / prefiltra con riscaldatore nafta	D 2876 LF 02	09/96 >		S 6059 NE		
prefilter without fuel oil heater / prefiltra senza riscaldatore nafta	D 2876 LF 02	09/96 >		S 6062 NE		
power steering / servosterzo	D 2876 LF 02	09/96 >				S 3081 PO
28.463 FN	D 2876 LF 02	09/96 >	S 5016 PE	S 4378 NR	S 1970 A	S 3053 C
with gearbox ZF Ecosplit and Intarder / con cambio ZF Ecosplit e Intarder	D 2876 LF 02	09/96 >				S 2234 Z
dryer filter / filtro essiccatore	D 2876 LF 02	09/96 >				S 7259 A
inner / interno	D 2876 LF 02	09/96 >			S 7405 A	
prefilter with fuel oil heater / prefiltra con riscaldatore nafta	D 2876 LF 02	09/96 >		S 6059 NE		
prefilter without fuel oil heater / prefiltra senza riscaldatore nafta	D 2876 LF 02	09/96 >		S 6062 NE		
power steering / servosterzo	D 2876 LF 02	09/96 >				S 3081 PO
28.464 F	D 2876 LF 06	07/99 >	S 5016 PE	S 4378 NR	S 1970 A	S 3053 C
with gearbox ZF Ecosplit and Intarder / con cambio ZF Ecosplit e Intarder	D 2876 LF 06	07/99 >				S 2234 Z
dryer filter / filtro essiccatore	D 2876 LF 06	07/99 >				S 7259 A
inner / interno	D 2876 LF 06	07/99 >			S 7405 A	
prefilter with fuel oil heater / prefiltra con riscaldatore nafta	D 2876 LF 06	07/99 >		S 6059 NE		
prefilter without fuel oil heater / prefiltra senza riscaldatore nafta	D 2876 LF 06	07/99 >		S 6062 NE		
power steering / servosterzo	D 2876 LF 06	07/99 >				S 3081 PO
28.464 FL	D 2876 LF 06	07/99 >	S 5016 PE	S 4378 NR	S 1970 A	S 3053 C
with gearbox ZF Ecosplit and Intarder / con cambio ZF Ecosplit e Intarder	D 2876 LF 06	07/99 >				S 2234 Z
dryer filter / filtro essiccatore	D 2876 LF 06	07/99 >				S 7259 A
inner / interno	D 2876 LF 06	07/99 >			S 7405 A	
prefilter with fuel oil heater / prefiltra con riscaldatore nafta	D 2876 LF 06	07/99 >		S 6059 NE		
prefilter without fuel oil heater / prefiltra senza riscaldatore nafta	D 2876 LF 06	07/99 >		S 6062 NE		
power steering / servosterzo	D 2876 LF 06	07/99 >				S 3081 PO
29.414 FV	D 2866 LF 31	07/99 >	S 5016 PE	S 4378 NR	S 1970 A	S 3053 C
with gearbox ZF Ecosplit and Intarder / con cambio ZF Ecosplit e Intarder	D 2866 LF 31	07/99 >				S 2234 Z
dryer filter / filtro essiccatore	D 2866 LF 31	07/99 >				S 7259 A
inner / interno	D 2866 LF 31	07/99 >			S 7405 A	
prefilter with fuel oil heater / prefiltra con riscaldatore nafta	D 2866 LF 31	07/99 >		S 6059 NE		
prefilter without fuel oil heater / prefiltra senza riscaldatore nafta	D 2866 LF 31	07/99 >		S 6062 NE		
power steering / servosterzo	D 2866 LF 31	07/99 >				S 3081 PO
29.464 FV	D 2876 LF 06	07/99 >	S 5016 PE	S 4378 NR	S 1970 A	S 3053 C
with gearbox ZF Ecosplit and Intarder / con cambio ZF Ecosplit e Intarder	D 2876 LF 06	07/99 >				S 2234 Z
dryer filter / filtro essiccatore	D 2876 LF 06	07/99 >				S 7259 A
inner / interno	D 2876 LF 06	07/99 >			S 7405 A	
prefilter with fuel oil heater / prefiltra con riscaldatore nafta	D 2876 LF 06	07/99 >		S 6059 NE		
prefilter without fuel oil heater / prefiltra senza riscaldatore nafta	D 2876 LF 06	07/99 >		S 6062 NE		
power steering / servosterzo	D 2876 LF 06	07/99 >				S 3081 PO
30.293 FNL	D 2865 LF 24	03/97 >	S 5016 PE	S 4378 NR	S 1970 A	S 3053 C
with gearbox ZF Ecosplit and Intarder / con cambio ZF Ecosplit e Intarder	D 2865 LF 24	03/97 >				S 2234 Z
dryer filter / filtro essiccatore	D 2865 LF 24	03/97 >				S 7259 A
inner / interno	D 2865 LF 24	03/97 >			S 7405 A	
prefilter with fuel oil heater / prefiltra con riscaldatore nafta	D 2865 LF 24	03/97 >		S 6059 NE		
prefilter without fuel oil heater / prefiltra senza riscaldatore nafta	D 2865 LF 24	03/97 >		S 6062 NE		
power steering / servosterzo	D 2865 LF 24	03/97 >				S 3081 PO
30.314 FN	D 2866 LF 34	07/98 >	S 5016 PE	S 4378 NR	S 1970 A	S 3053 C
with gearbox ZF Ecosplit and Intarder / con cambio ZF Ecosplit e Intarder	D 2866 LF 34	07/98 >				S 2234 Z
dryer filter / filtro essiccatore	D 2866 LF 34	07/98 >				S 7259 A
inner / interno	D 2866 LF 34	07/98 >			S 7405 A	
prefilter with fuel oil heater / prefiltra con riscaldatore nafta	D 2866 LF 34	07/98 >		S 6059 NE		
prefilter without fuel oil heater / prefiltra senza riscaldatore nafta	D 2866 LF 34	07/98 >		S 6062 NE		
power steering / servosterzo	D 2866 LF 34	07/98 >				S 3081 PO
30.343 FA	D 2866 LF 35	03/97 >	S 5016 PE	S 4378 NR	S 1970 A	S 3053 C
with gearbox ZF Ecosplit and Intarder / con cambio ZF Ecosplit e Intarder	D 2866 LF 35	03/97 >				S 2234 Z
dryer filter / filtro essiccatore	D 2866 LF 35	03/97 >				S 7259 A
inner / interno	D 2866 LF 35	03/97 >			S 7405 A	
prefilter with fuel oil heater / prefiltra con riscaldatore nafta	D 2866 LF 35	03/97 >		S 6059 NE		



KW HP



...MAN - trucks/autocarri

M

dryer filter / filtro essiccatore	D 2866 LF 35	09/97 >				S 7405 A	S 7259 A
inner / interno	D 2866 LF 35	09/97 >					
prefilter without fuel oil heater / prefiltro senza riscaldatore nafta	D 2866 LF 35	09/97 >			S 6062 NE		
33.464 DF	D 2876 LF 02/06	09/98 >	S 5016 PE	S 4378 NR		S 1970 A	S 3053 C
with gearbox ZF Ecosplit and Intarder / con cambio ZF Ecosplit e Intarder	D 2876 LF 02/06	09/98 >					S 2234 Z
dryer filter / filtro essiccatore	D 2876 LF 02/06	09/98 >					S 7259 A
inner / interno	D 2876 LF 02/06	09/98 >				S 7405 A	
prefilter with fuel oil heater / prefiltro con riscaldatore nafta	D 2876 LF 02/06	09/98 >			S 6059 NE		
prefilter without fuel oil heater / prefiltro senza riscaldatore nafta	D 2876 LF 02/06	09/98 >			S 6062 NE		
33.604 DF	D 2840 LF 21	08/97 >			S 4378 NR	S 1970 A	S 3053 C
with gearbox ZF Ecosplit and Intarder / con cambio ZF Ecosplit e Intarder	D 2840 LF 21	08/97 >					S 2234 Z
dryer filter / filtro essiccatore	D 2840 LF 21	08/97 >					S 7259 A
inner / interno	D 2840 LF 21	08/97 >				S 7405 A	
2 filters / N.2 filtri	D 2840 LF 21	08/97 >	S 5005 PE				
prefilter with fuel oil heater / prefiltro con riscaldatore nafta	D 2840 LF 21	08/97 >			S 6059 NE		
prefilter without fuel oil heater / prefiltro senza riscaldatore nafta	D 2840 LF 21	08/97 >			S 6062 NE		
36.604 DF	D 2840 LF 21	08/98 >			S 4378 NR	S 1970 A	S 3053 C
with gearbox ZF Ecosplit and Intarder / con cambio ZF Ecosplit e Intarder	D 2840 LF 21	08/98 >					S 2234 Z
dryer filter / filtro essiccatore	D 2840 LF 21	08/98 >					S 7259 A
inner / interno	D 2840 LF 21	08/98 >				S 7405 A	
2 filters / N.2 filtri	D 2840 LF 21	08/98 >	S 5005 PE				
prefilter with fuel oil heater / prefiltro con riscaldatore nafta	D 2840 LF 21	08/98 >			S 6059 NE		
prefilter without fuel oil heater / prefiltro senza riscaldatore nafta	D 2840 LF 21	08/98 >			S 6062 NE		
40.403 DF	D 2866 LF 20	08/99 >	S 5016 PE	S 4378 NR		S 1970 A	S 3053 C
with gearbox ZF Ecosplit and Intarder / con cambio ZF Ecosplit e Intarder	D 2866 LF 20	08/99 >					S 2234 Z
dryer filter / filtro essiccatore	D 2866 LF 20	08/99 >					S 7259 A
inner / interno	D 2866 LF 20	08/99 >				S 7405 A	
prefilter with fuel oil heater / prefiltro con riscaldatore nafta	D 2866 LF 20	08/99 >			S 6059 NE		
prefilter without fuel oil heater / prefiltro senza riscaldatore nafta	D 2866 LF 20	08/99 >			S 6062 NE		
40.414 DF	D 2866 LF 31	08/99 >	S 5016 PE	S 4378 NR		S 1970 A	S 3053 C
with gearbox ZF Ecosplit and Intarder / con cambio ZF Ecosplit e Intarder	D 2866 LF 31	08/99 >					S 2234 Z
dryer filter / filtro essiccatore	D 2866 LF 31	08/99 >					S 7259 A
inner / interno	D 2866 LF 31	08/99 >				S 7405 A	
prefilter with fuel oil heater / prefiltro con riscaldatore nafta	D 2866 LF 31	08/99 >			S 6059 NE		
prefilter without fuel oil heater / prefiltro senza riscaldatore nafta	D 2866 LF 31	08/99 >			S 6062 NE		
40.464 DF	D 2876 LF 06	08/99 >	S 5016 PE	S 4378 NR		S 1970 A	S 3053 C
with gearbox ZF Ecosplit and Intarder / con cambio ZF Ecosplit e Intarder	D 2876 LF 06	08/99 >					S 2234 Z
dryer filter / filtro essiccatore	D 2876 LF 06	08/99 >					S 7259 A
inner / interno	D 2876 LF 06	08/99 >				S 7405 A	
prefilter with fuel oil heater / prefiltro con riscaldatore nafta	D 2876 LF 06	08/99 >			S 6059 NE		
prefilter without fuel oil heater / prefiltro senza riscaldatore nafta	D 2876 LF 06	09/99 >			S 6062 NE		
40.604 DF	D 2840 LF 21	08/97 >			S 4378 NR	S 1970 A	S 3053 C
with gearbox ZF Ecosplit and Intarder / con cambio ZF Ecosplit e Intarder	D 2840 LF 21	08/97 >					S 2234 Z
dryer filter / filtro essiccatore	D 2840 LF 21	08/97 >					S 7259 A
inner / interno	D 2840 LF 21	08/97 >				S 7405 A	
2 filters / N.2 filtri	D 2840 LF 21	08/97 >	S 5005 PE				
prefilter with fuel oil heater / prefiltro con riscaldatore nafta	D 2840 LF 21	08/97 >			S 6059 NE		
prefilter without fuel oil heater / prefiltro senza riscaldatore nafta	D 2840 LF 21	08/97 >			S 6062 NE		
41.364 VF	D 2866 LF 35	07/98 >	S 5016 PE	S 4378 NR		S 1970 A	S 3053 C
with gearbox ZF Ecosplit and Intarder / con cambio ZF Ecosplit e Intarder	D 2866 LF 35	07/98 >					S 2234 Z
dryer filter / filtro essiccatore	D 2866 LF 35	07/98 >					S 7259 A
inner / interno	D 2866 LF 35	07/98 >				S 7405 A	
prefilter with fuel oil heater / prefiltro con riscaldatore nafta	D 2866 LF 35	07/98 >			S 6059 NE		
prefilter without fuel oil heater / prefiltro senza riscaldatore nafta	D 2866 LF 35	07/98 >			S 6062 NE		
41.414 VF	D 2866 LF 31	07/98 >	S 5016 PE	S 4378 NR		S 1970 A	S 3053 C
with gearbox ZF Ecosplit and Intarder / con cambio ZF Ecosplit e Intarder	D 2866 LF 31	07/98 >					S 2234 Z
dryer filter / filtro essiccatore	D 2866 LF 31	07/98 >					S 7259 A
inner / interno	D 2866 LF 31	07/98 >				S 7405 A	
prefilter with fuel oil heater / prefiltro con riscaldatore nafta	D 2866 LF 31	07/98 >			S 6059 NE		
prefilter without fuel oil heater / prefiltro senza riscaldatore nafta	D 2866 LF 31	07/98 >			S 6062 NE		
41.604 DF	D 2840 LF 21	02/97 >			S 4378 NR	S 1970 A	S 3053 C
with gearbox ZF Ecosplit and Intarder / con cambio ZF Ecosplit e Intarder	D 2840 LF 21	02/97 >					S 2234 Z
dryer filter / filtro essiccatore	D 2840 LF 21	02/97 >					S 7259 A
inner / interno	D 2840 LF 21	02/97 >				S 7405 A	
2 filters / N.2 filtri	D 2840 LF 21	02/97 >	S 5005 PE				
prefilter with fuel oil heater / prefiltro con riscaldatore nafta	D 2840 LF 21	02/97 >			S 6059 NE		
prefilter without fuel oil heater / prefiltro senza riscaldatore nafta	D 2840 LF 21	02/97 >			S 6062 NE		



KW HP



...MAN - trucks/autocarri

42.414 VF/AK	D 2866 LF 31	07/98 >	S 5016 PE	S 4378 NR	S 1970 A	S 3053 C
with gearbox ZF Ecosplit and Intarder / con cambio ZF Ecosplit e Intarder	D 2866 LF 31	07/98 >				S 2234 Z
dryer filter / filtro essiccatore	D 2866 LF 31	07/98 >				S 7259 A
inner / interno	D 2866 LF 31	07/98 >			S 7405 A	
prefilter with fuel oil heater / prefiltra con riscaldatore nafta	D 2866 LF 31	07/98 >		S 6059 NE		
prefilter without fuel oil heater / prefiltra senza riscaldatore nafta	D 2866 LF 31	07/98 >		S 6062 NE		
42.464 VFK/AK	D 2876 LF 06	07/98 >	S 5016 PE	S 4378 NR	S 1970 A	S 3053 C
with gearbox ZF Ecosplit and Intarder / con cambio ZF Ecosplit e Intarder	D 2876 LF 06	07/98 >				S 2234 Z
dryer filter / filtro essiccatore	D 2876 LF 06	07/98 >				S 7259 A
inner / interno	D 2876 LF 06	07/98 >			S 7405 A	
prefilter with fuel oil heater / prefiltra con riscaldatore nafta	D 2876 LF 06	07/98 >		S 6059 NE		
prefilter without fuel oil heater / prefiltra senza riscaldatore nafta	D 2876 LF 06	07/98 >		S 6062 NE		
50.373 VFK	D 2866 LF	06/98 >	S 5016 PE	S 4378 NR	S 1970 A	S 3053 C
with gearbox ZF Ecosplit and Intarder / con cambio ZF Ecosplit e Intarder	D 2866 LF	06/98 >				S 2234 Z
dryer filter / filtro essiccatore	D 2866 LF	06/98 >				S 7259 A
inner / interno	D 2866 LF	06/98 >			S 7405 A	
prefilter with fuel oil heater / prefiltra con riscaldatore nafta	D 2866 LF	06/98 >		S 6059 NE		
prefilter without fuel oil heater / prefiltra senza riscaldatore nafta	D 2866 LF	06/98 >		S 6062 NE		
50.403 VF	D 2866 LF 20	06/98 >	S 5016 PE	S 4378 NR	S 1970 A	S 3053 C
with gearbox ZF Ecosplit and Intarder / con cambio ZF Ecosplit e Intarder	D 2866 LF 20	06/98 >				S 2234 Z
dryer filter / filtro essiccatore	D 2866 LF 20	06/98 >				S 7259 A
inner / interno	D 2866 LF 20	06/98 >			S 7405 A	
prefilter with fuel oil heater / prefiltra con riscaldatore nafta	D 2866 LF 20	06/98 >		S 6059 NE		
prefilter without fuel oil heater / prefiltra senza riscaldatore nafta	D 2866 LF 20	06/98 >		S 6062 NE		
50.414 VF	D 2866 LF 31	07/98 >	S 5016 PE	S 4378 NR	S 1970 A	S 3053 C
with gearbox ZF Ecosplit and Intarder / con cambio ZF Ecosplit e Intarder	D 2866 LF 31	07/98 >				S 2234 Z
dryer filter / filtro essiccatore	D 2866 LF 31	07/98 >				S 7259 A
inner / interno	D 2866 LF 31	07/98 >			S 7405 A	
prefilter with fuel oil heater / prefiltra con riscaldatore nafta	D 2866 LF 31	07/98 >		S 6059 NE		
prefilter without fuel oil heater / prefiltra senza riscaldatore nafta	D 2866 LF 31	07/98 >		S 6062 NE		
50.414 VFA	D 2866 LF 31	07/98 >	S 5016 PE	S 4378 NR	S 1970 A	S 3053 C
with gearbox ZF Ecosplit and Intarder / con cambio ZF Ecosplit e Intarder	D 2866 LF 31	07/98 >				S 2234 Z
dryer filter / filtro essiccatore	D 2866 LF 31	07/98 >				S 7259 A
inner / interno	D 2866 LF 31	07/98 >			S 7405 A	
prefilter with fuel oil heater / prefiltra con riscaldatore nafta	D 2866 LF 31	07/98 >		S 6059 NE		
prefilter without fuel oil heater / prefiltra senza riscaldatore nafta	D 2866 LF 31	07/98 >		S 6062 NE		
50.463 VF	D 2876 LF 02	06/97 >	S 5016 PE	S 4378 NR	S 1970 A	S 3053 C
with gearbox ZF Ecosplit and Intarder / con cambio ZF Ecosplit e Intarder	D 2876 LF 02	06/97 >				S 2234 Z
dryer filter / filtro essiccatore	D 2876 LF 02	06/97 >				S 7259 A
inner / interno	D 2876 LF 02	06/97 >			S 7405 A	
prefilter with fuel oil heater / prefiltra con riscaldatore nafta	D 2876 LF 02	06/97 >		S 6059 NE		
prefilter without fuel oil heater / prefiltra senza riscaldatore nafta	D 2876 LF 02	06/97 >		S 6062 NE		
50.463 VFA	D 2876 LF 02	06/97 >	S 5016 PE	S 4378 NR	S 1970 A	S 3053 C
with gearbox ZF Ecosplit and Intarder / con cambio ZF Ecosplit e Intarder	D 2876 LF 02	06/97 >				S 2234 Z
dryer filter / filtro essiccatore	D 2876 LF 02	06/97 >				S 7259 A
inner / interno	D 2876 LF 02	06/97 >			S 7405 A	
prefilter with fuel oil heater / prefiltra con riscaldatore nafta	D 2876 LF 02	06/97 >		S 6059 NE		
prefilter without fuel oil heater / prefiltra senza riscaldatore nafta	D 2876 LF 02	06/97 >		S 6062 NE		
50.464 VF	D 2876 LF 06	07/98 >	S 5016 PE	S 4378 NR	S 1970 A	S 3053 C
with gearbox ZF Ecosplit and Intarder / con cambio ZF Ecosplit e Intarder	D 2876 LF 06	07/98 >				S 2234 Z
dryer filter / filtro essiccatore	D 2876 LF 06	07/98 >				S 7259 A
inner / interno	D 2876 LF 06	07/98 >			S 7405 A	
prefilter with fuel oil heater / prefiltra con riscaldatore nafta	D 2876 LF 06	07/98 >		S 6059 NE		
prefilter without fuel oil heater / prefiltra senza riscaldatore nafta	D 2876 LF 06	07/98 >		S 6062 NE		
50.603	D 2840 LF 20	09/97 >		S 4378 NR	S 1970 A	S 3053 C
with gearbox ZF Ecosplit and Intarder / con cambio ZF Ecosplit e Intarder	D 2840 LF 20	09/97 >				S 2234 Z
dryer filter / filtro essiccatore	D 2840 LF 20	09/97 >				S 7259 A
inner / interno	D 2840 LF 20	09/97 >			S 7405 A	
2 filters / N.2 filtri	D 2840 LF 20	09/97 >	S 5005 PE			
prefilter with fuel oil heater / prefiltra con riscaldatore nafta	D 2840 LF 20	09/97 >		S 6059 NE		
prefilter without fuel oil heater / prefiltra senza riscaldatore nafta	D 2840 LF 20	09/97 >		S 6062 NE		
50.604 VF	D 2840 LF 20	02/99 >		S 4378 NR	S 1970 A	S 3053 C
with gearbox ZF Ecosplit and Intarder / con cambio ZF Ecosplit e Intarder	D 2840 LF 20	02/99 >				S 2234 Z
dryer filter / filtro essiccatore	D 2840 LF 20	02/99 >				S 7259 A
inner / interno	D 2840 LF 20	02/99 >			S 7405 A	
2 filters / N.2 filtri	D 2840 LF 20	02/99 >	S 5005 PE			
prefilter with fuel oil heater / prefiltra con riscaldatore nafta	D 2840 LF 20	02/99 >		S 6059 NE		

M





KW HP



...MAN - trucks/autocarri

M



prefilter without fuel oil heater / prefiltro senza riscaldatore nafta	D 2840 LF 20			02/99 >			S 6062 NE	
F2000 Evolution Serie								
FE 310 A	D 2866			09/00 >		S 5016 PE	S 4378 NR	S 1970 A
with gearbox ZF Ecosplit and Intarder / con cambio ZF Ecosplit e Intarder	D 2866			09/00 >				S 3053 C
dryer filter / filtro essiccatore	D 2866			09/00 >				S 2234 Z
inner / interno	D 2866			09/00 >			S 7405 A	S 7259 A
power steering / servosterzo	D 2866			09/00 >				S 3081 PO
FE 360 A	D 2866			09/00 >		S 5016 PE	S 4378 NR	S 1970 A
with gearbox ZF Ecosplit and Intarder / con cambio ZF Ecosplit e Intarder	D 2866			09/00 >				S 3053 C
dryer filter / filtro essiccatore	D 2866			09/00 >				S 2234 Z
inner / interno	D 2866			09/00 >			S 7405 A	S 7259 A
power steering / servosterzo	D 2866			09/00 >				S 3081 PO
FE 410 A	D 2866			09/00 >		S 5016 PE	S 4378 NR	S 1970 A
with gearbox ZF Ecosplit and Intarder / con cambio ZF Ecosplit e Intarder	D 2866			09/00 >				S 3053 C
dryer filter / filtro essiccatore	D 2866			09/00 >				S 2234 Z
inner / interno	D 2866			09/00 >			S 7405 A	S 7259 A
power steering / servosterzo	D 2866			09/00 >				S 3081 PO
FE 460 A	D 2876			09/00 >		S 5016 PE	S 4378 NR	S 1970 A
with gearbox ZF Ecosplit and Intarder / con cambio ZF Ecosplit e Intarder	D 2876			09/00 >				S 3053 C
dryer filter / filtro essiccatore	D 2876			09/00 >				S 2234 Z
inner / interno	D 2876			09/00 >			S 7405 A	S 7259 A
power steering / servosterzo	D 2876			09/00 >				S 3081 PO
F2000 Serie								
18.273 F	D 2865 LF 22	198 270		06/94 > 12/95				S 1970 A
with gearbox ZF Ecosplit and Intarder / con cambio ZF Ecosplit e Intarder	D 2865 LF 22	198 270		06/94 > 12/95				S 3053 C
dryer filter / filtro essiccatore	D 2865 LF 22	198 270		06/94 > 12/95				S 2234 Z
inner / interno	D 2865 LF 22	198 270		06/94 > 12/95			S 7405 A	S 7259 A
2 filters / N.2 filtri	D 2865 LF 22	198 270		06/94 > 01/95	S 5132 PE	S 4378 NR		
2 filters / N.2 filtri	D 2865 LF 22	198 270		02/95 > 12/95	S 5005 PE	S 4378 NR		
prefilter with fuel oil heater / prefiltro con riscaldatore nafta	D 2865 LF 22	198 270		06/94 > 12/95		S 6059 NE		
prefilter without fuel oil heater / prefiltro senza riscaldatore nafta	D 2865 LF 22	198 270		06/94 > 12/95		S 6062 NE		
19.233 F	E 2866 (CNG-Metano)	170 232		09/96 > 01/98	S 5005 PE			S 1970 A
	E 2866 (CNG-Metano)	170 232		02/98 >	S 5016 PE			S 3053 C
with gearbox ZF Ecosplit and Intarder / con cambio ZF Ecosplit e Intarder	E 2866 (CNG-Metano)	170 232		09/96 >				S 1970 A
dryer filter / filtro essiccatore	E 2866 (CNG-Metano)	170 232		09/96 >				S 2234 Z
inner / interno	E 2866 (CNG-Metano)	170 232		09/96 >			S 7405 A	S 7259 A
19.273 F	D 2865 LF 22	198 270		01/94 > 12/95				S 1970 A
with gearbox ZF Ecosplit and Intarder / con cambio ZF Ecosplit e Intarder	D 2865 LF 22	198 270		01/94 > 12/95				S 3053 C
dryer filter / filtro essiccatore	D 2865 LF 22	198 270		01/94 > 12/95				S 2234 Z
inner / interno	D 2865 LF 22	198 270		01/94 > 12/95			S 7405 A	S 7259 A
2 filters / N.2 filtri	D 2865 LF 22	198 270		01/94 > 01/95	S 5132 PE	S 4378 NR		
2 filters / N.2 filtri	D 2865 LF 22	198 270		02/95 > 12/95	S 5005 PE	S 4378 NR		
prefilter with fuel oil heater / prefiltro con riscaldatore nafta	D 2865 LF 22	198 270		01/94 > 12/95		S 6059 NE		
prefilter without fuel oil heater / prefiltro senza riscaldatore nafta	D 2865 LF 22	198 270		01/94 > 12/95		S 6062 NE		
19.293	D 2865 LF 20	213 290		01/94 > 08/96				S 1970 A
	D 2865 LF 20	213 290		09/96 >	S 5016 PE			S 3053 C
with gearbox ZF Ecosplit and Intarder / con cambio ZF Ecosplit e Intarder	D 2865 LF 20	213 290		01/94 >				S 1970 A
dryer filter / filtro essiccatore	D 2865 LF 20	213 290		01/94 >				S 3053 C
inner / interno	D 2865 LF 20	213 290		01/94 >			S 7405 A	S 2234 Z
2 filters / N.2 filtri	D 2865 LF 20	213 290		01/94 > 01/95	S 5132 PE	S 4378 NR		S 7259 A
2 filters / N.2 filtri	D 2865 LF 20	213 290		02/95 > 08/96	S 5005 PE	S 4378 NR		
2 filters / N.2 filtri	D 2865 LF 20	213 290		09/96 >		S 4378 NR		
prefilter with fuel oil heater / prefiltro con riscaldatore nafta	D 2865 LF 20	213 290		01/94 >		S 6059 NE		
19.293 F	D 2865 LF 20	213 290		01/94 > 08/96				S 1970 A
	D 2865 LF 20	213 290		09/96 >	S 5016 PE			S 3053 C
with gearbox ZF Ecosplit and Intarder / con cambio ZF Ecosplit e Intarder	D 2865 LF 20	213 290		01/94 >				S 1970 A
dryer filter / filtro essiccatore	D 2865 LF 20	213 290		01/94 >				S 3053 C
inner / interno	D 2865 LF 20	213 290		01/94 >			S 7405 A	S 2234 Z
2 filters / N.2 filtri	D 2865 LF 20	213 290		01/94 > 01/95	S 5132 PE	S 4378 NR		S 7259 A
2 filters / N.2 filtri	D 2865 LF 20	213 290		02/95 > 08/96	S 5005 PE	S 4378 NR		
2 filters / N.2 filtri	D 2865 LF 20	213 290		09/96 >		S 4378 NR		
prefilter with fuel oil heater / prefiltro con riscaldatore nafta	D 2865 LF 20	213 290		01/94 >		S 6059 NE		
prefilter without fuel oil heater / prefiltro senza riscaldatore nafta	D 2865 LF 20	213 290		01/94 >		S 6062 NE		
19.314	D 2866 LF 34	228 310		09/98 >	S 5016 PE			S 1970 A
with gearbox ZF Ecosplit and Intarder / con cambio ZF Ecosplit e Intarder	D 2866 LF 34	228 310		09/98 >				S 3053 C
dryer filter / filtro essiccatore	D 2866 LF 34	228 310		09/98 >				S 2234 Z
inner / interno	D 2866 LF 34	228 310		09/98 >			S 7405 A	S 7259 A

**KW HP****...MAN - trucks/autocarri**

2 filters / N.2 filtri	D 2866 LF 34	228	310	09/98	>		S 4378 NR		
prefilter with fuel oil heater / prefiltra con riscaldatore nafta	D 2866 LF 34	228	310	09/98	>		S 6059 NE		
prefilter without fuel oil heater / prefiltra senza riscaldatore nafta	D 2866 LF 34	228	310	09/98	>		S 6062 NE		
19.314 F	D 2866 LF 34	228	310	09/98	>	S 5016 PE		S 1970 A	S 3053 C
with gearbox ZF Ecosplit and Intarder / con cambio ZF Ecosplit e Intarder	D 2866 LF 34	228	310	09/98	>				S 2234 Z
dryer filter / filtro essiccatore	D 2866 LF 34	228	310	09/98	>				S 7259 A
inner / interno	D 2866 LF 34	228	310	09/98	>			S 7405 A	
2 filters / N.2 filtri	D 2866 LF 34	228	310	09/98	>		S 4378 NR		
prefilter with fuel oil heater / prefiltra con riscaldatore nafta	D 2866 LF 34	228	310	09/98	>		S 6059 NE		
prefilter without fuel oil heater / prefiltra senza riscaldatore nafta	D 2866 LF 34	228	310	09/98	>		S 6062 NE		
19.323	D 2865 LF 23	235	320	01/94	> 12/95			S 1970 A	S 3053 C
with gearbox ZF Ecosplit and Intarder / con cambio ZF Ecosplit e Intarder	D 2865 LF 23	235	320	01/94	> 12/95				S 2234 Z
dryer filter / filtro essiccatore	D 2865 LF 23	235	320	01/94	> 12/95				S 7259 A
inner / interno	D 2865 LF 23	235	320	01/94	> 12/95			S 7405 A	
2 filters / N.2 filtri	D 2865 LF 23	235	320	01/94	> 01/95	S 5132 PE	S 4378 NR		
2 filters / N.2 filtri	D 2865 LF 23	235	320	02/95	> 12/95	S 5005 PE	S 4378 NR		
prefilter with fuel oil heater / prefiltra con riscaldatore nafta	D 2865 LF 23	235	320	01/94	> 12/95		S 6059 NE		
prefilter without fuel oil heater / prefiltra senza riscaldatore nafta	D 2865 LF 23	235	320	01/94	> 12/95		S 6062 NE		
19.323 F	D 2865 LF 23	235	320	01/94	> 12/95			S 1970 A	S 3053 C
with gearbox ZF Ecosplit and Intarder / con cambio ZF Ecosplit e Intarder	D 2865 LF 23	235	320	01/94	> 12/95				S 2234 Z
dryer filter / filtro essiccatore	D 2865 LF 23	235	320	01/94	> 12/95				S 7259 A
inner / interno	D 2865 LF 23	235	320	01/94	> 12/95			S 7405 A	
2 filters / N.2 filtri	D 2865 LF 23	235	320	01/94	> 01/95	S 5132 PE	S 4378 NR		
2 filters / N.2 filtri	D 2865 LF 23	235	320	02/95	> 12/95	S 5005 PE	S 4378 NR		
prefilter with fuel oil heater / prefiltra con riscaldatore nafta	D 2865 LF 23	235	320	01/94	> 12/95		S 6059 NE		
prefilter without fuel oil heater / prefiltra senza riscaldatore nafta	D 2865 LF 23	235	320	01/94	> 12/95		S 6062 NE		
19.343	D 2865 LF 21	250	340	01/94	> 08/96			S 1970 A	S 3053 C
	D 2865 LF 21	250	340	09/96	>	S 5016 PE		S 1970 A	S 3053 C
with gearbox ZF Ecosplit and Intarder / con cambio ZF Ecosplit e Intarder	D 2865 LF 21	250	340	01/94	>				S 2234 Z
dryer filter / filtro essiccatore	D 2865 LF 21	250	340	01/94	>				S 7259 A
inner / interno	D 2865 LF 21	250	340	01/94	>			S 7405 A	
2 filters / N.2 filtri	D 2865 LF 21	250	340	01/94	> 01/95	S 5132 PE	S 4378 NR		
2 filters / N.2 filtri	D 2865 LF 21	250	340	02/95	> 08/96	S 5005 PE	S 4378 NR		
2 filters / N.2 filtri	D 2865 LF 21	250	340	09/96	>		S 4378 NR		
prefilter with fuel oil heater / prefiltra con riscaldatore nafta	D 2865 LF 21	250	340	01/94	>		S 6059 NE		
prefilter without fuel oil heater / prefiltra senza riscaldatore nafta	D 2865 LF 21	250	340	01/94	>		S 6062 NE		
19.343	E 2866 (CNG-Metano)	170	232	01/94	> 01/95	S 5132 PE		S 1970 A	S 3053 C
	E 2866 (CNG-Metano)	170	232	02/95	> 08/96	S 5005 PE		S 1970 A	S 3053 C
	E 2866 (CNG-Metano)	170	232	09/96	>	S 5016 PE		S 1970 A	S 3053 C
with gearbox ZF Ecosplit and Intarder / con cambio ZF Ecosplit e Intarder	E 2866 (CNG-Metano)	170	232	01/94	>				S 2234 Z
dryer filter / filtro essiccatore	E 2866 (CNG-Metano)	170	232	01/94	>				S 7259 A
inner / interno	E 2866 (CNG-Metano)	170	232	01/94	>			S 7405 A	
19.343 F	D 2865 LF 21	250	340	01/94	> 08/96			S 1970 A	S 3053 C
	D 2865 LF 21	250	340	09/96	>	S 5016 PE		S 1970 A	S 3053 C
with gearbox ZF Ecosplit and Intarder / con cambio ZF Ecosplit e Intarder	D 2865 LF 21	250	340	01/94	>				S 2234 Z
dryer filter / filtro essiccatore	D 2865 LF 21	250	340	01/94	>				S 7259 A
inner / interno	D 2865 LF 21	250	340	01/94	>			S 7405 A	
2 filters / N.2 filtri	D 2865 LF 21	250	340	01/94	> 01/95	S 5132 PE	S 4378 NR		
2 filters / N.2 filtri	D 2865 LF 21	250	340	02/95	> 08/96	S 5005 PE	S 4378 NR		
2 filters / N.2 filtri	D 2865 LF 21	250	340	09/96	>		S 4378 NR		
prefilter with fuel oil heater / prefiltra con riscaldatore nafta	D 2865 LF 21	250	340	01/94	>		S 6059 NE		
prefilter without fuel oil heater / prefiltra senza riscaldatore nafta	D 2865 LF 21	250	340	01/94	>		S 6062 NE		
19.364	D 2866 LF 35	265	360	09/98	>	S 5016 PE		S 1970 A	S 3053 C
with gearbox ZF Ecosplit and Intarder / con cambio ZF Ecosplit e Intarder	D 2866 LF 35	265	360	09/98	>				S 2234 Z
dryer filter / filtro essiccatore	D 2866 LF 35	265	360	09/98	>				S 7259 A
inner / interno	D 2866 LF 35	265	360	09/98	>			S 7405 A	
2 filters / N.2 filtri	D 2866 LF 35	265	360	09/98	>		S 4378 NR		
prefilter with fuel oil heater / prefiltra con riscaldatore nafta	D 2866 LF 35	265	360	09/98	>		S 6059 NE		
prefilter without fuel oil heater / prefiltra senza riscaldatore nafta	D 2866 LF 35	265	360	09/98	>		S 6062 NE		
19.364 F	D 2866 LF 35	265	360	09/98	>	S 5016 PE		S 1970 A	S 3053 C
with gearbox ZF Ecosplit and Intarder / con cambio ZF Ecosplit e Intarder	D 2866 LF 35	265	360	09/98	>				S 2234 Z
dryer filter / filtro essiccatore	D 2866 LF 35	265	360	09/98	>				S 7259 A
inner / interno	D 2866 LF 35	265	360	09/98	>			S 7405 A	
2 filters / N.2 filtri	D 2866 LF 35	265	360	09/98	>		S 4378 NR		
prefilter with fuel oil heater / prefiltra con riscaldatore nafta	D 2866 LF 35	265	360	09/98	>		S 6059 NE		
prefilter without fuel oil heater / prefiltra senza riscaldatore nafta	D 2866 LF 35	265	360	09/98	>		S 6062 NE		
19.373	D 2866 LF 21	272	370	01/94	> 12/95			S 1970 A	S 3053 C

M

**KW HP****...MAN - trucks/autocarri**

with gearbox ZF Ecosplit and Intarder / con cambio ZF Ecosplit e Intarder	D 2866 LF 21	272	370	01/94	>	12/95				S 2234 Z
dryer filter / filtro essiccatore	D 2866 LF 21	272	370	01/94	>	12/95				S 7259 A
inner / interno	D 2866 LF 21	272	370	01/94	>	12/95			S 7405 A	
2 filters / N.2 filtri	D 2866 LF 21	272	370	01/94	>	01/95	S 5132 PE	S 4378 NR		
2 filters / N.2 filtri	D 2866 LF 21	272	370	02/95	>	12/95	S 5005 PE	S 4378 NR		
prefilter with fuel oil heater / prefiltro con riscaldatore nafta	D 2866 LF 21	272	370	01/94	>	12/95		S 6059 NE		
19.373 F	D 2866 LF 21	272	370	01/94	>	12/95			S 1970 A	S 3053 C
with gearbox ZF Ecosplit and Intarder / con cambio ZF Ecosplit e Intarder	D 2866 LF 21	272	370	01/94	>	12/95				S 2234 Z
dryer filter / filtro essiccatore	D 2866 LF 21	272	370	01/94	>	12/95				S 7259 A
inner / interno	D 2866 LF 21	272	370	01/94	>	12/95			S 7405 A	
2 filters / N.2 filtri	D 2866 LF 21	272	370	01/94	>	01/95	S 5132 PE	S 4378 NR		
2 filters / N.2 filtri	D 2866 LF 21	272	370	02/95	>	12/95	S 5005 PE	S 4378 NR		
prefilter with fuel oil heater / prefiltro con riscaldatore nafta	D 2866 LF 21	272	370	01/94	>	12/95		S 6059 NE		
prefilter without fuel oil heater / prefiltro senza riscaldatore nafta	D 2866 LF 21	272	370	01/94	>	12/95		S 6062 NE		
19.403	D 2866 LF 20	294	400	01/94	>	08/96			S 1970 A	S 3053 C
	D 2866 LF 20	294	400	09/96	>		S 5016 PE		S 1970 A	S 3053 C
with gearbox ZF Ecosplit and Intarder / con cambio ZF Ecosplit e Intarder	D 2866 LF 20	294	400	01/94	>					S 2234 Z
dryer filter / filtro essiccatore	D 2866 LF 20	294	400	01/94	>					S 7259 A
inner / interno	D 2866 LF 20	294	400	01/94	>				S 7405 A	
2 filters / N.2 filtri	D 2866 LF 20	294	400	01/94	>	01/95	S 5132 PE	S 4378 NR		
2 filters / N.2 filtri	D 2866 LF 20	294	400	02/95	>	08/96	S 5005 PE	S 4378 NR		
2 filters / N.2 filtri	D 2866 LF 20	294	400	09/96	>			S 4378 NR		
prefilter with fuel oil heater / prefiltro con riscaldatore nafta	D 2866 LF 20	294	400	01/94	>			S 6059 NE		
prefilter without fuel oil heater / prefiltro senza riscaldatore nafta	D 2866 LF 20	294	400	01/94	>			S 6062 NE		
19.403 F	D 2866 LF 20	294	400	01/94	>	08/96			S 1970 A	S 3053 C
	D 2866 LF 20	294	400	09/96	>		S 5016 PE		S 1970 A	S 3053 C
with gearbox ZF Ecosplit and Intarder / con cambio ZF Ecosplit e Intarder	D 2866 LF 20	294	400	01/94	>					S 2234 Z
dryer filter / filtro essiccatore	D 2866 LF 20	294	400	01/94	>					S 7259 A
inner / interno	D 2866 LF 20	294	400	01/94	>				S 7405 A	
2 filters / N.2 filtri	D 2866 LF 20	294	400	01/94	>	01/95	S 5132 PE	S 4378 NR		
2 filters / N.2 filtri	D 2866 LF 20	294	400	02/95	>	08/96	S 5005 PE	S 4378 NR		
2 filters / N.2 filtri	D 2866 LF 20	294	400	09/96	>			S 4378 NR		
prefilter with fuel oil heater / prefiltro con riscaldatore nafta	D 2866 LF 20	294	400	01/94	>			S 6059 NE		
prefilter without fuel oil heater / prefiltro senza riscaldatore nafta	D 2866 LF 20	294	400	01/94	>			S 6062 NE		
19.414	D 2866 LF 21	301	410	09/98	>		S 5016 PE		S 1970 A	S 3053 C
with gearbox ZF Ecosplit and Intarder / con cambio ZF Ecosplit e Intarder	D 2866 LF 21	301	410	09/98	>					S 2234 Z
dryer filter / filtro essiccatore	D 2866 LF 21	301	410	09/98	>					S 7259 A
inner / interno	D 2866 LF 21	301	410	09/98	>				S 7405 A	
2 filters / N.2 filtri	D 2866 LF 21	301	410	09/98	>			S 4378 NR		
prefilter with fuel oil heater / prefiltro con riscaldatore nafta	D 2866 LF 21	301	410	09/98	>			S 6059 NE		
prefilter without fuel oil heater / prefiltro senza riscaldatore nafta	D 2866 LF 21	301	410	09/98	>			S 6062 NE		
19.414 F	D 2866 LF 21	301	410	09/98	>		S 5016 PE		S 1970 A	S 3053 C
with gearbox ZF Ecosplit and Intarder / con cambio ZF Ecosplit e Intarder	D 2866 LF 21	301	410	09/98	>					S 2234 Z
dryer filter / filtro essiccatore	D 2866 LF 21	301	410	09/98	>					S 7259 A
inner / interno	D 2866 LF 21	301	410	09/98	>				S 7405 A	
2 filters / N.2 filtri	D 2866 LF 21	301	410	09/98	>			S 4378 NR		
prefilter with fuel oil heater / prefiltro con riscaldatore nafta	D 2866 LF 21	301	410	09/98	>			S 6059 NE		
prefilter without fuel oil heater / prefiltro senza riscaldatore nafta	D 2866 LF 21	301	410	09/98	>			S 6062 NE		
19.423	D 2866 LF 22			01/94	>	12/95		S 4378 NR	S 1970 A	S 3053 C
with gearbox ZF Ecosplit and Intarder / con cambio ZF Ecosplit e Intarder	D 2866 LF 22			01/94	>	12/95				S 2234 Z
dryer filter / filtro essiccatore	D 2866 LF 22			01/94	>	12/95				S 7259 A
inner / interno	D 2866 LF 22			01/94	>	12/95			S 7405 A	
2 filters / N.2 filtri	D 2866 LF 22			02/95	>	12/95	S 5005 PE			
prefilter with fuel oil heater / prefiltro con riscaldatore nafta	D 2866 LF 22			01/94	>	12/95		S 6059 NE		
prefilter without fuel oil heater / prefiltro senza riscaldatore nafta	D 2866 LF 22			01/94	>	12/95		S 6062 NE		
19.423 F	D 2866 LF 22			01/94	>	12/95		S 4378 NR	S 1970 A	S 3053 C
with gearbox ZF Ecosplit and Intarder / con cambio ZF Ecosplit e Intarder	D 2866 LF 22			01/94	>	12/95				S 2234 Z
dryer filter / filtro essiccatore	D 2866 LF 22			01/94	>	12/95				S 7259 A
inner / interno	D 2866 LF 22			01/94	>	12/95			S 7405 A	
2 filters / N.2 filtri	D 2866 LF 22			02/95	>	12/95	S 5005 PE			
prefilter with fuel oil heater / prefiltro con riscaldatore nafta	D 2866 LF 22			01/94	>	12/95		S 6059 NE		
prefilter without fuel oil heater / prefiltro senza riscaldatore nafta	D 2866 LF 22			01/94	>	12/95		S 6062 NE		
19.463	D 2876 LF 02			01/94	>	08/96		S 4378 NR	S 1970 A	S 3053 C
	D 2876 LF 02			09/96	>		S 5016 PE	S 4378 NR	S 1970 A	S 3053 C
with gearbox ZF Ecosplit and Intarder / con cambio ZF Ecosplit e Intarder	D 2876 LF 02			01/94	>					S 2234 Z
dryer filter / filtro essiccatore	D 2876 LF 02			01/94	>					S 7259 A
inner / interno	D 2876 LF 02			01/94	>				S 7405 A	



KW HP



...MAN - trucks/autocarri

2 filters / N.2 filtri	D 2876 LF 02	02/95 > 08/96	S 5005 PE	S 6059 NE		
prefilter with fuel oil heater / prefiltra con riscaldatore nafta	D 2876 LF 02	01/94 >		S 6062 NE		
prefilter without fuel oil heater / prefiltra senza riscaldatore nafta	D 2876 LF 02	01/94 >				
19.463 F	D 2876 LF 02	01/94 > 08/96		S 4378 NR	S 1970 A	S 3053 C
	D 2876 LF 02	09/96 >	S 5016 PE	S 4378 NR	S 1970 A	S 3053 C
with gearbox ZF Ecosplit and Intarder / con cambio ZF Ecosplit e Intarder	D 2876 LF 02	01/94 >				S 2234 Z
dryer filter / filtro essiccatore	D 2876 LF 02	01/94 >				S 7259 A
inner / interno	D 2876 LF 02	01/94 >			S 7405 A	
2 filters / N.2 filtri	D 2876 LF 02	02/95 > 08/96	S 5005 PE			
prefilter with fuel oil heater / prefiltra con riscaldatore nafta	D 2876 LF 02	01/94 >		S 6059 NE		
prefilter without fuel oil heater / prefiltra senza riscaldatore nafta	D 2876 LF 02	01/94 >		S 6062 NE		
19.464	D 2876 LF 06	09/98 >	S 5016 PE	S 4378 NR	S 1970 A	S 3053 C
with gearbox ZF Ecosplit and Intarder / con cambio ZF Ecosplit e Intarder	D 2876 LF 06	09/98 >				S 2234 Z
dryer filter / filtro essiccatore	D 2876 LF 06	09/98 >				S 7259 A
inner / interno	D 2876 LF 06	09/98 >			S 7405 A	
prefilter with fuel oil heater / prefiltra con riscaldatore nafta	D 2876 LF 06	09/98 >		S 6059 NE		
prefilter without fuel oil heater / prefiltra senza riscaldatore nafta	D 2876 LF 06	09/98 >		S 6062 NE		
19.464 F	D 2876 LF 06	09/98 >	S 5016 PE	S 4378 NR	S 1970 A	S 3053 C
with gearbox ZF Ecosplit and Intarder / con cambio ZF Ecosplit e Intarder	D 2876 LF 06	09/98 >				S 2234 Z
dryer filter / filtro essiccatore	D 2876 LF 06	09/98 >				S 7259 A
inner / interno	D 2876 LF 06	09/98 >			S 7405 A	
prefilter with fuel oil heater / prefiltra con riscaldatore nafta	D 2876 LF 06	09/98 >		S 6059 NE		
prefilter without fuel oil heater / prefiltra senza riscaldatore nafta	D 2876 LF 06	09/98 >		S 6062 NE		
19.603	D 2840 LF 20	04/96 >		S 4378 NR	S 1970 A	S 3053 C
with gearbox ZF Ecosplit and Intarder / con cambio ZF Ecosplit e Intarder	D 2840 LF 20	04/96 >				S 2234 Z
dryer filter / filtro essiccatore	D 2840 LF 20	04/96 >				S 7259 A
inner / interno	D 2840 LF 20	04/96 >			S 7405 A	
2 filters / N.2 filtri	D 2840 LF 20	04/96 >	S 5005 PE			
prefilter with fuel oil heater / prefiltra con riscaldatore nafta	D 2840 LF 20	04/96 >		S 6059 NE		
prefilter without fuel oil heater / prefiltra senza riscaldatore nafta	D 2840 LF 20	04/96 >		S 6062 NE		
19.603 FL	D 2840 LF 20	04/96 >		S 4378 NR	S 1970 A	S 3053 C
with gearbox ZF Ecosplit and Intarder / con cambio ZF Ecosplit e Intarder	D 2840 LF 20	04/96 >				S 2234 Z
dryer filter / filtro essiccatore	D 2840 LF 20	04/96 >				S 7259 A
inner / interno	D 2840 LF 20	04/96 >			S 7405 A	
2 filters / N.2 filtri	D 2840 LF 20	04/96 >	S 5005 PE			
prefilter with fuel oil heater / prefiltra con riscaldatore nafta	D 2840 LF 20	04/96 >		S 6059 NE		
prefilter without fuel oil heater / prefiltra senza riscaldatore nafta	D 2840 LF 20	04/96 >		S 6062 NE		
19.603 FLS	D 2840 LF 20	04/96 >		S 4378 NR	S 1970 A	S 3053 C
with gearbox ZF Ecosplit and Intarder / con cambio ZF Ecosplit e Intarder	D 2840 LF 20	04/96 >				S 2234 Z
dryer filter / filtro essiccatore	D 2840 LF 20	04/96 >				S 7259 A
inner / interno	D 2840 LF 20	04/96 >			S 7405 A	
2 filters / N.2 filtri	D 2840 LF 20	04/96 >	S 5005 PE			
prefilter with fuel oil heater / prefiltra con riscaldatore nafta	D 2840 LF 20	04/96 >		S 6059 NE		
prefilter without fuel oil heater / prefiltra senza riscaldatore nafta	D 2840 LF 20	04/96 >		S 6062 NE		
19.604 FLS	D 2840 LF21	07/99 >		S 4378 NR	S 1970 A	S 3053 C
with gearbox ZF Ecosplit and Intarder / con cambio ZF Ecosplit e Intarder	D 2840 LF21	07/99 >				S 2234 Z
dryer filter / filtro essiccatore	D 2840 LF21	07/99 >				S 7259 A
inner / interno	D 2840 LF21	07/99 >			S 7405 A	
2 filters / N.2 filtri	D 2840 LF21	07/99 >	S 5005 PE			
prefilter with fuel oil heater / prefiltra con riscaldatore nafta	D 2840 LF21	07/99 >		S 6059 NE		
prefilter without fuel oil heater / prefiltra senza riscaldatore nafta	D 2840 LF21	07/99 >		S 6062 NE		
23.293	D 2865 LF 20	01/94 > 04/95		S 4378 NR	S 1970 A	S 3053 C
with gearbox ZF Ecosplit and Intarder / con cambio ZF Ecosplit e Intarder	D 2865 LF 20	01/94 > 04/95				S 2234 Z
dryer filter / filtro essiccatore	D 2865 LF 20	01/94 > 04/95				S 7259 A
inner / interno	D 2865 LF 20	01/94 > 04/95			S 7405 A	
2 filters / N.2 filtri	D 2865 LF 20	02/95 > 04/95	S 5005 PE			
prefilter with fuel oil heater / prefiltra con riscaldatore nafta	D 2865 LF 20	01/94 > 04/95		S 6059 NE		
23.293 FNL	D 2865 LF 20	01/94 > 04/95		S 4378 NR	S 1970 A	S 3053 C
with gearbox ZF Ecosplit and Intarder / con cambio ZF Ecosplit e Intarder	D 2865 LF 20	01/94 > 04/95				S 2234 Z
dryer filter / filtro essiccatore	D 2865 LF 20	01/94 > 04/95				S 7259 A
inner / interno	D 2865 LF 20	01/94 > 04/95			S 7405 A	
2 filters / N.2 filtri	D 2865 LF 20	02/95 > 04/95	S 5005 PE			
prefilter with fuel oil heater / prefiltra con riscaldatore nafta	D 2865 LF 20	01/94 > 04/95		S 6059 NE		
23.314	D 2866 LF 34	09/98 >	S 5016 PE	S 4378 NR	S 1970 A	S 3053 C
with gearbox ZF Ecosplit and Intarder / con cambio ZF Ecosplit e Intarder	D 2866 LF 34	09/98 >				S 2234 Z
dryer filter / filtro essiccatore	D 2866 LF 34	09/98 >				S 7259 A
inner / interno	D 2866 LF 34	09/98 >			S 7405 A	

M





kW HP



...MAN - trucks/autocarri

dryer filter / filtro essiccatore	D 2876 LF 02	01/94 >				S 7259 A
inner / interno	D 2876 LF 02	01/94 >				
2 filters / N.2 filtri	D 2876 LF 02	02/95 > 08/96	S 5005 PE		S 7405 A	
prefilter with fuel oil heater / prefiltra con riscaldatore nafta	D 2876 LF 02	01/94 >		S 6059 NE		
prefilter without fuel oil heater / prefiltra senza riscaldatore nafta	D 2876 LF 02	01/94 >		S 6062 NE		
23.463 FNL	D 2876 LF 02	01/94 > 08/96		S 4378 NR	S 1970 A	S 3053 C
	D 2876 LF 02	09/96 >	S 5016 PE	S 4378 NR	S 1970 A	S 3053 C
with gearbox ZF Ecosplit and Intarder / con cambio ZF Ecosplit e Intarder	D 2876 LF 02	01/94 >				S 2234 Z
dryer filter / filtro essiccatore	D 2876 LF 02	01/94 >				S 7259 A
inner / interno	D 2876 LF 02	01/94 >			S 7405 A	
2 filters / N.2 filtri	D 2876 LF 02	02/95 > 08/96	S 5005 PE			
prefilter with fuel oil heater / prefiltra con riscaldatore nafta	D 2876 LF 02	01/94 >		S 6059 NE		
prefilter without fuel oil heater / prefiltra senza riscaldatore nafta	D 2876 LF 02	01/94 >		S 6062 NE		
23.464	D 2876 LF 06	09/98 >	S 5016 PE	S 4378 NR	S 1970 A	S 3053 C
with gearbox ZF Ecosplit and Intarder / con cambio ZF Ecosplit e Intarder	D 2876 LF 06	09/98 >				S 2234 Z
dryer filter / filtro essiccatore	D 2876 LF 06	09/98 >				S 7259 A
inner / interno	D 2876 LF 06	09/98 >			S 7405 A	
prefilter with fuel oil heater / prefiltra con riscaldatore nafta	D 2876 LF 06	09/98 >		S 6059 NE		
prefilter without fuel oil heater / prefiltra senza riscaldatore nafta	D 2876 LF 06	09/98 >		S 6062 NE		
23.464 F	D 2876 LF 06	09/98 >	S 5016 PE	S 4378 NR	S 1970 A	S 3053 C
with gearbox ZF Ecosplit and Intarder / con cambio ZF Ecosplit e Intarder	D 2876 LF 06	09/98 >				S 2234 Z
dryer filter / filtro essiccatore	D 2876 LF 06	09/98 >				S 7259 A
inner / interno	D 2876 LF 06	09/98 >			S 7405 A	
prefilter with fuel oil heater / prefiltra con riscaldatore nafta	D 2876 LF 06	09/98 >		S 6059 NE		
prefilter without fuel oil heater / prefiltra senza riscaldatore nafta	D 2876 LF 06	09/98 >		S 6062 NE		
24.314	D 2866 LF 34	09/98 >	S 5016 PE	S 4378 NR	S 1970 A	S 3053 C
with gearbox ZF Ecosplit and Intarder / con cambio ZF Ecosplit e Intarder	D 2866 LF 34	09/98 >				S 2234 Z
dryer filter / filtro essiccatore	D 2866 LF 34	09/98 >				S 7259 A
inner / interno	D 2866 LF 34	09/98 >			S 7405 A	
prefilter with fuel oil heater / prefiltra con riscaldatore nafta	D 2866 LF 34	09/98 >		S 6059 NE		
prefilter without fuel oil heater / prefiltra senza riscaldatore nafta	D 2866 LF 34	09/98 >		S 6062 NE		
24.314 F	D 2866 LF 34	09/98 >	S 5016 PE	S 4378 NR	S 1970 A	S 3053 C
with gearbox ZF Ecosplit and Intarder / con cambio ZF Ecosplit e Intarder	D 2866 LF 34	09/98 >				S 2234 Z
dryer filter / filtro essiccatore	D 2866 LF 34	09/98 >				S 7259 A
inner / interno	D 2866 LF 34	09/98 >			S 7405 A	
prefilter with fuel oil heater / prefiltra con riscaldatore nafta	D 2866 LF 34	09/98 >		S 6059 NE		
prefilter without fuel oil heater / prefiltra senza riscaldatore nafta	D 2866 LF 34	09/98 >		S 6062 NE		
24.323	D 2865 LF 23	01/94 > 12/95		S 4378 NR	S 1970 A	S 3053 C
with gearbox ZF Ecosplit and Intarder / con cambio ZF Ecosplit e Intarder	D 2865 LF 23	01/94 > 12/95				S 2234 Z
dryer filter / filtro essiccatore	D 2865 LF 23	01/94 > 12/95				S 7259 A
inner / interno	D 2865 LF 23	01/94 > 12/95			S 7405 A	
2 filters / N.2 filtri	D 2865 LF 23	02/95 > 12/95	S 5005 PE			
prefilter with fuel oil heater / prefiltra con riscaldatore nafta	D 2865 LF 23	01/94 > 12/95		S 6059 NE		
prefilter without fuel oil heater / prefiltra senza riscaldatore nafta	D 2865 LF 23	01/94 > 12/95		S 6062 NE		
24.323 FNL	D 2865 LF 23	01/94 > 12/95		S 4378 NR	S 1970 A	S 3053 C
with gearbox ZF Ecosplit and Intarder / con cambio ZF Ecosplit e Intarder	D 2865 LF 23	01/94 > 12/95				S 2234 Z
dryer filter / filtro essiccatore	D 2865 LF 23	01/94 > 12/95				S 7259 A
inner / interno	D 2865 LF 23	01/94 > 12/95			S 7405 A	
2 filters / N.2 filtri	D 2865 LF 23	02/95 > 12/95	S 5005 PE			
prefilter with fuel oil heater / prefiltra con riscaldatore nafta	D 2865 LF 23	01/94 > 12/95		S 6059 NE		
prefilter without fuel oil heater / prefiltra senza riscaldatore nafta	D 2865 LF 23	01/94 > 12/95		S 6062 NE		
24.343	D 2865 LF 21	01/94 > 08/96		S 4378 NR	S 1970 A	S 3053 C
	D 2865 LF 21	09/96 >	S 5016 PE	S 4378 NR	S 1970 A	S 3053 C
with gearbox ZF Ecosplit and Intarder / con cambio ZF Ecosplit e Intarder	D 2865 LF 21	01/94 >				S 2234 Z
dryer filter / filtro essiccatore	D 2865 LF 21	01/94 >				S 7259 A
inner / interno	D 2865 LF 21	01/94 >			S 7405 A	
2 filters / N.2 filtri	D 2865 LF 21	02/95 > 08/96	S 5005 PE			
prefilter with fuel oil heater / prefiltra con riscaldatore nafta	D 2865 LF 21	01/94 >		S 6059 NE		
prefilter without fuel oil heater / prefiltra senza riscaldatore nafta	D 2865 LF 21	01/94 >		S 6062 NE		
24.343 FNL	D 2865 LF 21	01/94 > 08/96		S 4378 NR	S 1970 A	S 3053 C
	D 2865 LF 21	09/96 >	S 5016 PE	S 4378 NR	S 1970 A	S 3053 C
with gearbox ZF Ecosplit and Intarder / con cambio ZF Ecosplit e Intarder	D 2865 LF 21	01/94 >				S 2234 Z
dryer filter / filtro essiccatore	D 2865 LF 21	01/94 >				S 7259 A
inner / interno	D 2865 LF 21	01/94 >			S 7405 A	
2 filters / N.2 filtri	D 2865 LF 21	02/95 > 08/96	S 5005 PE			
prefilter with fuel oil heater / prefiltra con riscaldatore nafta	D 2865 LF 21	01/94 >		S 6059 NE		
prefilter without fuel oil heater / prefiltra senza riscaldatore nafta	D 2865 LF 21	01/94 >		S 6062 NE		

M





KW HP



...MAN - trucks/autocarri

M



prefilter without fuel oil heater / prefiltra senza riscaldatore nafta	D 2866 LF 34	09/98 >		S 6062 NE		
26.323	D 2865 LF 23	01/94 > 12/95		S 4378 NR	S 1970 A	S 3053 C
with gearbox ZF Ecosplit and Intarder / con cambio ZF Ecosplit e Intarder	D 2865 LF 23	01/94 > 12/95				S 2234 Z
dryer filter / filtro essiccatore	D 2865 LF 23	01/94 > 12/95				S 7259 A
inner / interno	D 2865 LF 23	01/94 > 12/95			S 7405 A	
2 filters / N.2 filtri	D 2865 LF 23	02/95 > 12/95	S 5005 PE			
prefilter with fuel oil heater / prefiltra con riscaldatore nafta	D 2865 LF 23	01/94 > 12/95		S 6059 NE		
prefilter without fuel oil heater / prefiltra senza riscaldatore nafta	D 2865 LF 23	01/94 > 12/95		S 6062 NE		
26.323 DF	D 2865 LF 23	01/94 > 12/95		S 4378 NR	S 1970 A	S 3053 C
with gearbox ZF Ecosplit and Intarder / con cambio ZF Ecosplit e Intarder	D 2865 LF 23	01/94 > 12/95				S 2234 Z
dryer filter / filtro essiccatore	D 2865 LF 23	01/94 > 12/95				S 7259 A
inner / interno	D 2865 LF 23	01/94 > 12/95			S 7405 A	
2 filters / N.2 filtri	D 2865 LF 23	02/95 > 12/95	S 5005 PE			
prefilter with fuel oil heater / prefiltra con riscaldatore nafta	D 2865 LF 23	01/94 > 12/95		S 6059 NE		
prefilter without fuel oil heater / prefiltra senza riscaldatore nafta	D 2865 LF 23	01/94 > 12/95		S 6062 NE		
26.343	D 2865 LF 21	01/94 > 08/96		S 4378 NR	S 1970 A	S 3053 C
	D 2865 LF 21	09/96 >	S 5016 PE	S 4378 NR	S 1970 A	S 3053 C
with gearbox ZF Ecosplit and Intarder / con cambio ZF Ecosplit e Intarder	D 2865 LF 21	01/94 >				S 2234 Z
dryer filter / filtro essiccatore	D 2865 LF 21	01/94 >				S 7259 A
inner / interno	D 2865 LF 21	01/94 >			S 7405 A	
2 filters / N.2 filtri	D 2865 LF 21	02/95 > 08/96	S 5005 PE			
prefilter with fuel oil heater / prefiltra con riscaldatore nafta	D 2865 LF 21	01/94 >		S 6059 NE		
prefilter without fuel oil heater / prefiltra senza riscaldatore nafta	D 2865 LF 21	01/94 >		S 6062 NE		
26.343 DF	D 2865 LF 21	01/94 > 08/96		S 4378 NR	S 1970 A	S 3053 C
	D 2865 LF 21	09/96 >	S 5016 PE	S 4378 NR	S 1970 A	S 3053 C
with gearbox ZF Ecosplit and Intarder / con cambio ZF Ecosplit e Intarder	D 2865 LF 21	01/94 >				S 2234 Z
dryer filter / filtro essiccatore	D 2865 LF 21	01/94 >				S 7259 A
inner / interno	D 2865 LF 21	01/94 >			S 7405 A	
2 filters / N.2 filtri	D 2865 LF 21	02/95 > 08/96	S 5005 PE			
prefilter with fuel oil heater / prefiltra con riscaldatore nafta	D 2865 LF 21	01/94 >		S 6059 NE		
prefilter without fuel oil heater / prefiltra senza riscaldatore nafta	D 2865 LF 21	01/94 >		S 6062 NE		
26.364	D 2866 LF 35	09/98 >	S 5016 PE	S 4378 NR	S 1970 A	S 3053 C
with gearbox ZF Ecosplit and Intarder / con cambio ZF Ecosplit e Intarder	D 2866 LF 35	09/98 >				S 2234 Z
dryer filter / filtro essiccatore	D 2866 LF 35	09/98 >				S 7259 A
inner / interno	D 2866 LF 35	09/98 >			S 7405 A	
prefilter with fuel oil heater / prefiltra con riscaldatore nafta	D 2866 LF 35	09/98 >		S 6059 NE		
prefilter without fuel oil heater / prefiltra senza riscaldatore nafta	D 2866 LF 35	09/98 >		S 6062 NE		
26.364 F	D 2866 LF 35	09/98 >	S 5016 PE	S 4378 NR	S 1970 A	S 3053 C
with gearbox ZF Ecosplit and Intarder / con cambio ZF Ecosplit e Intarder	D 2866 LF 35	09/98 >				S 2234 Z
dryer filter / filtro essiccatore	D 2866 LF 35	09/98 >				S 7259 A
inner / interno	D 2866 LF 35	09/98 >			S 7405 A	
prefilter with fuel oil heater / prefiltra con riscaldatore nafta	D 2866 LF 35	09/98 >		S 6059 NE		
prefilter without fuel oil heater / prefiltra senza riscaldatore nafta	D 2866 LF 35	09/98 >		S 6062 NE		
26.373	D 2866 LF 21	01/94 > 12/95		S 4378 NR	S 1970 A	S 3053 C
with gearbox ZF Ecosplit and Intarder / con cambio ZF Ecosplit e Intarder	D 2866 LF 21	01/94 > 12/95				S 2234 Z
dryer filter / filtro essiccatore	D 2866 LF 21	01/94 > 12/95				S 7259 A
inner / interno	D 2866 LF 21	01/94 > 12/95			S 7405 A	
2 filters / N.2 filtri	D 2866 LF 21	02/95 > 12/95	S 5005 PE			
prefilter with fuel oil heater / prefiltra con riscaldatore nafta	D 2866 LF 21	01/94 > 12/95		S 6059 NE		
prefilter without fuel oil heater / prefiltra senza riscaldatore nafta	D 2866 LF 21	01/94 > 12/95		S 6062 NE		
26.373 DF	D 2866 LF 21	01/94 > 12/95		S 4378 NR	S 1970 A	S 3053 C
with gearbox ZF Ecosplit and Intarder / con cambio ZF Ecosplit e Intarder	D 2866 LF 21	01/94 > 12/95				S 2234 Z
dryer filter / filtro essiccatore	D 2866 LF 21	01/94 > 12/95				S 7259 A
inner / interno	D 2866 LF 21	01/94 > 12/95			S 7405 A	
2 filters / N.2 filtri	D 2866 LF 21	02/95 > 12/95	S 5005 PE			
prefilter with fuel oil heater / prefiltra con riscaldatore nafta	D 2866 LF 21	01/94 > 12/95		S 6059 NE		
26.403	D 2866 LF 20	01/94 > 08/96		S 4378 NR	S 1970 A	S 3053 C
	D 2866 LF 20	09/96 >	S 5016 PE	S 4378 NR	S 1970 A	S 3053 C
with gearbox ZF Ecosplit and Intarder / con cambio ZF Ecosplit e Intarder	D 2866 LF 20	01/94 >				S 2234 Z
dryer filter / filtro essiccatore	D 2866 LF 20	01/94 >				S 7259 A
inner / interno	D 2866 LF 20	01/94 >			S 7405 A	
2 filters / N.2 filtri	D 2866 LF 20	02/95 > 08/96	S 5005 PE			
prefilter with fuel oil heater / prefiltra con riscaldatore nafta	D 2866 LF 20	01/94 >		S 6059 NE		
prefilter without fuel oil heater / prefiltra senza riscaldatore nafta	D 2866 LF 20	01/94 >		S 6062 NE		
26.403 DF	D 2866 LF 20	01/94 > 08/96		S 4378 NR	S 1970 A	S 3053 C
	D 2866 LF 20	09/96 >	S 5016 PE	S 4378 NR	S 1970 A	S 3053 C
with gearbox ZF Ecosplit and Intarder / con cambio ZF Ecosplit e Intarder	D 2866 LF 20	01/94 >				S 2234 Z

**KW HP****...MAN - trucks/autocarri**

with gearbox ZF Ecosplit and Intarder / con cambio ZF Ecosplit e Intarder	D 2865 LF 23	01/94 > 12/95			S 2234 Z
dryer filter / filtro essiccatore	D 2865 LF 23	01/94 > 12/95			S 7259 A
inner / interno	D 2865 LF 23	01/94 > 12/95			
2 filters / N.2 filtri	D 2865 LF 23	02/95 > 12/95	S 5005 PE		S 7405 A
prefilter with fuel oil heater / prefiltra con riscaldatore nafta	D 2865 LF 23	01/94 > 12/95		S 6059 NE	
27.323 DF	D 2865 LF 23	01/94 > 12/95		S 4378 NR	S 1970 A S 3053 C
with gearbox ZF Ecosplit and Intarder / con cambio ZF Ecosplit e Intarder	D 2865 LF 23	01/94 > 12/95			S 2234 Z
dryer filter / filtro essiccatore	D 2865 LF 23	01/94 > 12/95			S 7259 A
inner / interno	D 2865 LF 23	01/94 > 12/95			
2 filters / N.2 filtri	D 2865 LF 23	02/95 > 12/95	S 5005 PE		S 7405 A
prefilter with fuel oil heater / prefiltra con riscaldatore nafta	D 2865 LF 23	01/94 > 12/95		S 6059 NE	
27.343	D 2865 LF 21	01/94 > 08/96		S 4378 NR	S 1970 A S 3053 C
	D 2865 LF 21	09/96 >	S 5016 PE	S 4378 NR	S 1970 A S 3053 C
with gearbox ZF Ecosplit and Intarder / con cambio ZF Ecosplit e Intarder	D 2865 LF 21	01/94 >			S 2234 Z
dryer filter / filtro essiccatore	D 2865 LF 21	01/94 >			S 7259 A
inner / interno	D 2865 LF 21	01/94 >			
2 filters / N.2 filtri	D 2865 LF 21	02/95 > 08/96	S 5005 PE		S 7405 A
prefilter with fuel oil heater / prefiltra con riscaldatore nafta	D 2865 LF 21	01/94 >		S 6059 NE	
prefilter without fuel oil heater / prefiltra senza riscaldatore nafta	D 2865 LF 21	01/94 >		S 6062 NE	
27.343 DF	D 2865 LF 21	01/94 > 08/96		S 4378 NR	S 1970 A S 3053 C
	D 2865 LF 21	09/96 >	S 5016 PE	S 4378 NR	S 1970 A S 3053 C
with gearbox ZF Ecosplit and Intarder / con cambio ZF Ecosplit e Intarder	D 2865 LF 21	01/94 >			S 2234 Z
dryer filter / filtro essiccatore	D 2865 LF 21	01/94 >			S 7259 A
inner / interno	D 2865 LF 21	01/94 >			
2 filters / N.2 filtri	D 2865 LF 21	02/95 > 08/96	S 5005 PE		S 7405 A
prefilter with fuel oil heater / prefiltra con riscaldatore nafta	D 2865 LF 21	01/94 >		S 6059 NE	
prefilter without fuel oil heater / prefiltra senza riscaldatore nafta	D 2865 LF 21	01/94 >		S 6062 NE	
27.364	D 2866 LF 35	09/98 >	S 5016 PE	S 4378 NR	S 1970 A S 3053 C
with gearbox ZF Ecosplit and Intarder / con cambio ZF Ecosplit e Intarder	D 2866 LF 35	09/98 >			S 2234 Z
dryer filter / filtro essiccatore	D 2866 LF 35	09/98 >			S 7259 A
inner / interno	D 2866 LF 35	09/98 >			
prefilter with fuel oil heater / prefiltra con riscaldatore nafta	D 2866 LF 35	09/98 >		S 6059 NE	
prefilter without fuel oil heater / prefiltra senza riscaldatore nafta	D 2866 LF 35	09/98 >		S 6062 NE	
27.364 F	D 2866 LF 35	09/98 >	S 5016 PE	S 4378 NR	S 1970 A S 3053 C
with gearbox ZF Ecosplit and Intarder / con cambio ZF Ecosplit e Intarder	D 2866 LF 35	09/98 >			S 2234 Z
dryer filter / filtro essiccatore	D 2866 LF 35	09/98 >			S 7259 A
inner / interno	D 2866 LF 35	09/98 >			
prefilter with fuel oil heater / prefiltra con riscaldatore nafta	D 2866 LF 35	09/98 >		S 6059 NE	
prefilter without fuel oil heater / prefiltra senza riscaldatore nafta	D 2866 LF 35	09/98 >		S 6062 NE	
27.373	D 2866 LF 21	01/94 > 12/95		S 4378 NR	S 1970 A S 3053 C
with gearbox ZF Ecosplit and Intarder / con cambio ZF Ecosplit e Intarder	D 2866 LF 21	01/94 > 12/95			S 2234 Z
dryer filter / filtro essiccatore	D 2866 LF 21	01/94 > 12/95			S 7259 A
inner / interno	D 2866 LF 21	01/94 >			
2 filters / N.2 filtri	D 2866 LF 21	01/95 > 12/95	S 5005 PE		S 7405 A
prefilter with fuel oil heater / prefiltra con riscaldatore nafta	D 2866 LF 21	01/94 > 12/95		S 6059 NE	
prefilter without fuel oil heater / prefiltra senza riscaldatore nafta	D 2866 LF 21	01/94 > 12/95		S 6062 NE	
27.373 DF	D 2866 LF 21	01/94 > 12/95		S 4378 NR	S 1970 A S 3053 C
with gearbox ZF Ecosplit and Intarder / con cambio ZF Ecosplit e Intarder	D 2866 LF 21	01/94 > 12/95			S 2234 Z
dryer filter / filtro essiccatore	D 2866 LF 21	01/94 > 12/95			S 7259 A
inner / interno	D 2866 LF 21	01/94 > 12/95			
2 filters / N.2 filtri	D 2866 LF 21	01/95 > 12/95	S 5005 PE		S 7405 A
prefilter with fuel oil heater / prefiltra con riscaldatore nafta	D 2866 LF 21	01/94 > 12/95		S 6059 NE	
prefilter without fuel oil heater / prefiltra senza riscaldatore nafta	D 2866 LF 21	01/94 > 12/95		S 6062 NE	
27.403	D 2866 LF 20	01/94 > 08/96		S 4378 NR	S 1970 A S 3053 C
	D 2866 LF 20	09/96 >	S 5016 PE	S 4378 NR	S 1970 A S 3053 C
with gearbox ZF Ecosplit and Intarder / con cambio ZF Ecosplit e Intarder	D 2866 LF 20	01/94 >			S 2234 Z
dryer filter / filtro essiccatore	D 2866 LF 20	01/94 >			S 7259 A
inner / interno	D 2866 LF 20	01/94 >			
2 filters / N.2 filtri	D 2866 LF 20	01/95 > 08/96	S 5005 PE		S 7405 A
prefilter with fuel oil heater / prefiltra con riscaldatore nafta	D 2866 LF 20	01/94 >		S 6059 NE	
prefilter without fuel oil heater / prefiltra senza riscaldatore nafta	D 2866 LF 20	01/94 >		S 6062 NE	
27.403 DF	D 2866 LF 20	01/94 > 08/96		S 4378 NR	S 1970 A S 3053 C
	D 2866 LF 20	09/96 >	S 5016 PE	S 4378 NR	S 1970 A S 3053 C
with gearbox ZF Ecosplit and Intarder / con cambio ZF Ecosplit e Intarder	D 2866 LF 20	01/94 >			S 2234 Z
dryer filter / filtro essiccatore	D 2866 LF 20	01/94 >			S 7259 A
inner / interno	D 2866 LF 20	01/94 >			
2 filters / N.2 filtri	D 2866 LF 20	01/95 > 08/96	S 5005 PE		S 7405 A

M



kW HP



...MAN - trucks/autocarri

M



prefilter with fuel oil heater / prefiltro con riscaldatore nafta	D 2866 LF 20	01/94 >		S 6059 NE		
prefilter without fuel oil heater / prefiltro senza riscaldatore nafta	D 2866 LF 20	01/94 >		S 6062 NE		
27.414	D 2866 LF 31	09/98 >	S 5016 PE	S 4378 NR	S 1970 A	S 3053 C
with gearbox ZF Ecosplit and Intarder / con cambio ZF Ecosplit e Intarder	D 2866 LF 31	09/98 >				S 2234 Z
dryer filter / filtro essiccatore	D 2866 LF 31	09/98 >				S 7259 A
inner / interno	D 2866 LF 31	09/98 >			S 7405 A	
prefilter with fuel oil heater / prefiltro con riscaldatore nafta	D 2866 LF 31	09/98 >		S 6059 NE		
prefilter without fuel oil heater / prefiltro senza riscaldatore nafta	D 2866 LF 31	09/98 >		S 6062 NE		
27.414 F	D 2866 LF 31	09/98 >	S 5016 PE	S 4378 NR	S 1970 A	S 3053 C
with gearbox ZF Ecosplit and Intarder / con cambio ZF Ecosplit e Intarder	D 2866 LF 31	09/98 >				S 2234 Z
dryer filter / filtro essiccatore	D 2866 LF 31	09/98 >				S 7259 A
inner / interno	D 2866 LF 31	09/98 >			S 7405 A	
prefilter with fuel oil heater / prefiltro con riscaldatore nafta	D 2866 LF 31	09/98 >		S 6059 NE		
prefilter without fuel oil heater / prefiltro senza riscaldatore nafta	D 2866 LF 31	09/98 >		S 6062 NE		
27.423	D 2866 LF 22	01/94 > 12/95		S 4378 NR	S 1970 A	S 3053 C
with gearbox ZF Ecosplit and Intarder / con cambio ZF Ecosplit e Intarder	D 2866 LF 22	01/94 > 12/95				S 2234 Z
dryer filter / filtro essiccatore	D 2866 LF 22	01/94 > 12/95				S 7259 A
inner / interno	D 2866 LF 22	01/94 > 12/95			S 7405 A	
2 filters / N.2 filtri	D 2866 LF 22	01/95 > 12/95	S 5005 PE			
prefilter with fuel oil heater / prefiltro con riscaldatore nafta	D 2866 LF 22	01/94 > 12/95		S 6059 NE		
prefilter without fuel oil heater / prefiltro senza riscaldatore nafta	D 2866 LF 22	01/94 > 12/95		S 6062 NE		
27.423 DF	D 2866 LF 22	01/94 > 12/95		S 4378 NR	S 1970 A	S 3053 C
with gearbox ZF Ecosplit and Intarder / con cambio ZF Ecosplit e Intarder	D 2866 LF 22	01/94 > 12/95				S 2234 Z
dryer filter / filtro essiccatore	D 2866 LF 22	01/94 > 12/95				S 7259 A
inner / interno	D 2866 LF 22	01/94 > 12/95			S 7405 A	
2 filters / N.2 filtri	D 2866 LF 22	01/95 > 12/95	S 5005 PE			
prefilter with fuel oil heater / prefiltro con riscaldatore nafta	D 2866 LF 22	01/94 > 12/95		S 6059 NE		
prefilter without fuel oil heater / prefiltro senza riscaldatore nafta	D 2866 LF 22	01/94 > 12/95		S 6062 NE		
27.463	D 2876 LF 02	01/94 > 08/96		S 4378 NR	S 1970 A	S 3053 C
	D 2876 LF 02	09/96 >	S 5016 PE	S 4378 NR	S 1970 A	S 3053 C
with gearbox ZF Ecosplit and Intarder / con cambio ZF Ecosplit e Intarder	D 2876 LF 02	01/94 >				S 2234 Z
dryer filter / filtro essiccatore	D 2876 LF 02	01/94 >				S 7259 A
inner / interno	D 2876 LF 02	01/94 >			S 7405 A	
2 filters / N.2 filtri	D 2876 LF 02	01/95 > 08/96	S 5005 PE			
prefilter with fuel oil heater / prefiltro con riscaldatore nafta	D 2876 LF 02	01/94 >		S 6059 NE		
prefilter without fuel oil heater / prefiltro senza riscaldatore nafta	D 2876 LF 02	01/94 >		S 6062 NE		
27.463 DF	D 2876 LF 02	01/94 > 08/96		S 4378 NR	S 1970 A	S 3053 C
	D 2876 LF 02	09/96 >	S 5016 PE	S 4378 NR	S 1970 A	S 3053 C
with gearbox ZF Ecosplit and Intarder / con cambio ZF Ecosplit e Intarder	D 2876 LF 02	01/94 >				S 2234 Z
dryer filter / filtro essiccatore	D 2876 LF 02	01/94 >				S 7259 A
inner / interno	D 2876 LF 02	01/94 >			S 7405 A	
2 filters / N.2 filtri	D 2876 LF 02	01/95 > 08/96	S 5005 PE			
prefilter with fuel oil heater / prefiltro con riscaldatore nafta	D 2876 LF 02	01/94 >		S 6059 NE		
prefilter without fuel oil heater / prefiltro senza riscaldatore nafta	D 2876 LF 02	01/94 >		S 6062 NE		
27.464	D 2876 LF 06	09/98 >	S 5016 PE	S 4378 NR	S 1970 A	S 3053 C
with gearbox ZF Ecosplit and Intarder / con cambio ZF Ecosplit e Intarder	D 2876 LF 06	09/98 >				S 2234 Z
dryer filter / filtro essiccatore	D 2876 LF 06	09/98 >				S 7259 A
inner / interno	D 2876 LF 06	09/98 >			S 7405 A	
prefilter with fuel oil heater / prefiltro con riscaldatore nafta	D 2876 LF 06	09/98 >		S 6059 NE		
prefilter without fuel oil heater / prefiltro senza riscaldatore nafta	D 2876 LF 06	09/98 >		S 6062 NE		
27.464 F	D 2876 LF 06	09/98 >	S 5016 PE	S 4378 NR	S 1970 A	S 3053 C
with gearbox ZF Ecosplit and Intarder / con cambio ZF Ecosplit e Intarder	D 2876 LF 06	09/98 >				S 2234 Z
dryer filter / filtro essiccatore	D 2876 LF 06	09/98 >				S 7259 A
inner / interno	D 2876 LF 06	09/98 >			S 7405 A	
prefilter with fuel oil heater / prefiltro con riscaldatore nafta	D 2876 LF 06	09/98 >		S 6059 NE		
prefilter without fuel oil heater / prefiltro senza riscaldatore nafta	D 2876 LF 06	09/98 >		S 6062 NE		
27.603	D 2840 LF 20	06/96 >		S 4378 NR	S 1970 A	S 3053 C
with gearbox ZF Ecosplit and Intarder / con cambio ZF Ecosplit e Intarder	D 2840 LF 20	06/96 >				S 2234 Z
dryer filter / filtro essiccatore	D 2840 LF 20	06/96 >				S 7259 A
inner / interno	D 2840 LF 20	06/96 >			S 7405 A	
2 filters / N.2 filtri	D 2840 LF 20	06/96 >	S 5005 PE			
prefilter with fuel oil heater / prefiltro con riscaldatore nafta	D 2840 LF 20	06/96 >		S 6059 NE		
prefilter without fuel oil heater / prefiltro senza riscaldatore nafta	D 2840 LF 20	06/96 >		S 6062 NE		
27.603 DF	D 2840 LF 20	06/96 >		S 4378 NR	S 1970 A	S 3053 C
with gearbox ZF Ecosplit and Intarder / con cambio ZF Ecosplit e Intarder	D 2840 LF 20	06/96 >				S 2234 Z
dryer filter / filtro essiccatore	D 2840 LF 20	06/96 >				S 7259 A
inner / interno	D 2840 LF 20	06/96 >			S 7405 A	



KW HP



...MAN - trucks/autocarri

32.464 F	D 2876 LF 06	09/98 >	S 5016 PE	S 4378 NR	S 1970 A	S 3053 C
with gearbox ZF Ecosplit and Intarder / con cambio ZF Ecosplit e Intarder	D 2876 LF 06	09/98 >				S 2234 Z
dryer filter / filtro essiccatore	D 2876 LF 06	09/98 >				S 7259 A
inner / interno	D 2876 LF 06	09/98 >			S 7405 A	
prefilter with fuel oil heater / prefiltro con riscaldatore nafta	D 2876 LF 06	09/98 >		S 6059 NE		
prefilter without fuel oil heater / prefiltro senza riscaldatore nafta	D 2876 LF 06	09/98 >		S 6062 NE		
32.464 VF	D 2876 LF 06	09/98 >	S 5016 PE	S 4378 NR	S 1970 A	S 3053 C
with gearbox ZF Ecosplit and Intarder / con cambio ZF Ecosplit e Intarder	D 2876 LF 06	09/98 >				S 2234 Z
dryer filter / filtro essiccatore	D 2876 LF 06	09/98 >				S 7259 A
inner / interno	D 2876 LF 06	09/98 >			S 7405 A	
prefilter with fuel oil heater / prefiltro con riscaldatore nafta	D 2876 LF 06	09/98 >		S 6059 NE		
prefilter without fuel oil heater / prefiltro senza riscaldatore nafta	D 2876 LF 06	09/98 >		S 6062 NE		
33.323	D 2865 LF 23	01/94 > 12/95		S 4378 NR	S 1970 A	S 3053 C
with gearbox ZF Ecosplit and Intarder / con cambio ZF Ecosplit e Intarder	D 2865 LF 23	01/94 > 12/95				S 2234 Z
dryer filter / filtro essiccatore	D 2865 LF 23	01/94 > 12/95				S 7259 A
inner / interno	D 2865 LF 23	01/94 > 12/95			S 7405 A	
2 filters / N.2 filtri	D 2865 LF 23	01/95 > 12/95	S 5005 PE			
prefilter with fuel oil heater / prefiltro con riscaldatore nafta	D 2865 LF 23	01/94 > 12/95		S 6059 NE		
prefilter without fuel oil heater / prefiltro senza riscaldatore nafta	D 2865 LF 23	01/94 > 12/95		S 6062 NE		
33.323 DF	D 2865 LF 23	01/94 > 12/95		S 4378 NR	S 1970 A	S 3053 C
with gearbox ZF Ecosplit and Intarder / con cambio ZF Ecosplit e Intarder	D 2865 LF 23	01/94 > 12/95				S 2234 Z
dryer filter / filtro essiccatore	D 2865 LF 23	01/94 > 12/95				S 7259 A
inner / interno	D 2865 LF 23	01/94 > 12/95			S 7405 A	
2 filters / N.2 filtri	D 2865 LF 23	01/95 > 12/95	S 5005 PE			
prefilter with fuel oil heater / prefiltro con riscaldatore nafta	D 2865 LF 23	01/94 > 12/95		S 6059 NE		
prefilter without fuel oil heater / prefiltro senza riscaldatore nafta	D 2865 LF 23	01/94 > 12/95		S 6062 NE		
33.343	D 2865 LF 21	01/94 > 08/96		S 4378 NR	S 1970 A	S 3053 C
	D 2865 LF 21	09/96 >	S 5016 PE	S 4378 NR	S 1970 A	S 3053 C
with gearbox ZF Ecosplit and Intarder / con cambio ZF Ecosplit e Intarder	D 2865 LF 21	01/94 >				S 2234 Z
dryer filter / filtro essiccatore	D 2865 LF 21	01/94 >				S 7259 A
inner / interno	D 2865 LF 21	01/94 >			S 7405 A	
2 filters / N.2 filtri	D 2865 LF 21	01/95 > 08/96	S 5005 PE			
prefilter with fuel oil heater / prefiltro con riscaldatore nafta	D 2865 LF 21	01/94 >		S 6059 NE		
prefilter without fuel oil heater / prefiltro senza riscaldatore nafta	D 2865 LF 21	01/94 >		S 6062 NE		
33.343 DF	D 2865 LF 21	01/94 > 08/96		S 4378 NR	S 1970 A	S 3053 C
	D 2865 LF 21	09/96 >	S 5016 PE	S 4378 NR	S 1970 A	S 3053 C
with gearbox ZF Ecosplit and Intarder / con cambio ZF Ecosplit e Intarder	D 2865 LF 21	01/94 >				S 2234 Z
dryer filter / filtro essiccatore	D 2865 LF 21	01/94 >				S 7259 A
inner / interno	D 2865 LF 21	01/94 >			S 7405 A	
2 filters / N.2 filtri	D 2865 LF 21	01/95 > 08/96	S 5005 PE			
prefilter with fuel oil heater / prefiltro con riscaldatore nafta	D 2865 LF 21	01/94 >		S 6059 NE		
prefilter without fuel oil heater / prefiltro senza riscaldatore nafta	D 2865 LF 21	01/94 >		S 6062 NE		
33.364 DF	D 2866 LF 35	09/97 >	S 5016 PE	S 4378 NR	S 1970 A	S 3053 C
with gearbox ZF Ecosplit and Intarder / con cambio ZF Ecosplit e Intarder	D 2866 LF 35	09/97 >				S 2234 Z
dryer filter / filtro essiccatore	D 2866 LF 35	09/97 >				S 7259 A
inner / interno	D 2866 LF 35	09/97 >			S 7405 A	
prefilter with fuel oil heater / prefiltro con riscaldatore nafta	D 2866 LF 35	09/97 >		S 6059 NE		
prefilter without fuel oil heater / prefiltro senza riscaldatore nafta	D 2866 LF 35	09/97 >		S 6062 NE		
33.373	D 2866 LF 21	01/94 > 12/95		S 4378 NR	S 1970 A	S 3053 C
with gearbox ZF Ecosplit and Intarder / con cambio ZF Ecosplit e Intarder	D 2866 LF 21	01/94 > 12/95				S 2234 Z
dryer filter / filtro essiccatore	D 2866 LF 21	01/94 > 12/95				S 7259 A
inner / interno	D 2866 LF 21	01/94 > 12/95			S 7405 A	
2 filters / N.2 filtri	D 2866 LF 21	01/95 > 12/95	S 5005 PE			
prefilter with fuel oil heater / prefiltro con riscaldatore nafta	D 2866 LF 21	01/94 > 12/95		S 6059 NE		
prefilter without fuel oil heater / prefiltro senza riscaldatore nafta	D 2866 LF 21	01/94 > 12/95		S 6062 NE		
33.373 DF	D 2866 LF 21	01/94 > 12/95		S 4378 NR	S 1970 A	S 3053 C
with gearbox ZF Ecosplit and Intarder / con cambio ZF Ecosplit e Intarder	D 2866 LF 21	01/94 > 12/95				S 2234 Z
dryer filter / filtro essiccatore	D 2866 LF 21	01/94 > 12/95				S 7259 A
inner / interno	D 2866 LF 21	01/94 > 12/95			S 7405 A	
2 filters / N.2 filtri	D 2866 LF 21	01/95 > 12/95	S 5005 PE			
prefilter with fuel oil heater / prefiltro con riscaldatore nafta	D 2866 LF 21	01/94 > 12/95		S 6059 NE		
prefilter without fuel oil heater / prefiltro senza riscaldatore nafta	D 2866 LF 21	01/94 > 12/95		S 6062 NE		
33.403	D 2866 LF 20	01/94 > 08/96		S 4378 NR	S 1970 A	S 3053 C
	D 2866 LF 20	09/96 >	S 5016 PE	S 4378 NR	S 1970 A	S 3053 C
with gearbox ZF Ecosplit and Intarder / con cambio ZF Ecosplit e Intarder	D 2866 LF 20	01/94 >				S 2234 Z
dryer filter / filtro essiccatore	D 2866 LF 20	01/94 >				S 7259 A
inner / interno	D 2866 LF 20	01/94 >			S 7405 A	

M





KW HP



...MAN - trucks/autocarri

M



2 filters / N.2 filtri	D 2866 LF 20	01/95 > 08/96	S 5005 PE			
prefilter with fuel oil heater / prefiltra con riscaldatore nafta	D 2866 LF 20	01/94 >		S 6059 NE		
prefilter without fuel oil heater / prefiltra senza riscaldatore nafta	D 2866 LF 20	01/94 >		S 6062 NE		
33.403 DF	D 2866 LF 20	01/94 > 08/96		S 4378 NR	S 1970 A	S 3053 C
	D 2866 LF 20	09/96 >	S 5016 PE	S 4378 NR	S 1970 A	S 3053 C
with gearbox ZF Ecosplit and Intarder / con cambio ZF Ecosplit e Intarder	D 2866 LF 20	01/94 >				S 2234 Z
dryer filter / filtro essiccatore	D 2866 LF 20	01/94 >				S 7259 A
inner / interno	D 2866 LF 20	01/94 >			S 7405 A	
2 filters / N.2 filtri	D 2866 LF 20	01/95 > 08/96	S 5005 PE			
prefilter with fuel oil heater / prefiltra con riscaldatore nafta	D 2866 LF 20	01/94 >		S 6059 NE		
prefilter without fuel oil heater / prefiltra senza riscaldatore nafta	D 2866 LF 20	01/94 >		S 6062 NE		
33.414 F	D 2866 LF 31	09/98 >	S 5016 PE	S 4378 NR	S 1970 A	S 3053 C
with gearbox ZF Ecosplit and Intarder / con cambio ZF Ecosplit e Intarder	D 2866 LF 31	09/98 >				S 2234 Z
dryer filter / filtro essiccatore	D 2866 LF 31	09/98 >				S 7259 A
inner / interno	D 2866 LF 31	09/98 >			S 7405 A	
prefilter with fuel oil heater / prefiltra con riscaldatore nafta	D 2866 LF 31	09/98 >		S 6059 NE		
prefilter without fuel oil heater / prefiltra senza riscaldatore nafta	D 2866 LF 31	09/98 >		S 6062 NE		
33.414 VF	D 2866 LF 31	09/98 >	S 5016 PE	S 4378 NR	S 1970 A	S 3053 C
with gearbox ZF Ecosplit and Intarder / con cambio ZF Ecosplit e Intarder	D 2866 LF 31	09/98 >				S 2234 Z
dryer filter / filtro essiccatore	D 2866 LF 31	09/98 >				S 7259 A
inner / interno	D 2866 LF 31	09/98 >			S 7405 A	
prefilter with fuel oil heater / prefiltra con riscaldatore nafta	D 2866 LF 31	09/98 >		S 6059 NE		
prefilter without fuel oil heater / prefiltra senza riscaldatore nafta	D 2866 LF 31	09/98 >		S 6062 NE		
33.423	D 2866 LF 22	01/94 > 12/95		S 4378 NR	S 1970 A	S 3053 C
with gearbox ZF Ecosplit and Intarder / con cambio ZF Ecosplit e Intarder	D 2866 LF 22	01/94 > 12/95				S 2234 Z
dryer filter / filtro essiccatore	D 2866 LF 22	01/94 > 12/95				S 7259 A
inner / interno	D 2866 LF 22	01/94 > 12/95			S 7405 A	
2 filters / N.2 filtri	D 2866 LF 22	01/95 > 12/95	S 5005 PE			
prefilter with fuel oil heater / prefiltra con riscaldatore nafta	D 2866 LF 22	01/94 > 12/95		S 6059 NE		
prefilter without fuel oil heater / prefiltra senza riscaldatore nafta	D 2866 LF 22	01/94 > 12/95		S 6062 NE		
33.423 DF	D 2866 LF 22	01/94 > 12/95		S 4378 NR	S 1970 A	S 3053 C
with gearbox ZF Ecosplit and Intarder / con cambio ZF Ecosplit e Intarder	D 2866 LF 22	01/94 > 12/95				S 2234 Z
dryer filter / filtro essiccatore	D 2866 LF 22	01/94 > 12/95				S 7259 A
inner / interno	D 2866 LF 22	01/94 > 12/95			S 7405 A	
2 filters / N.2 filtri	D 2866 LF 22	01/95 > 12/95	S 5005 PE			
prefilter with fuel oil heater / prefiltra con riscaldatore nafta	D 2866 LF 22	01/94 > 12/95		S 6059 NE		
prefilter without fuel oil heater / prefiltra senza riscaldatore nafta	D 2866 LF 22	01/94 > 12/95		S 6062 NE		
33.463	D 2876 LF 02	01/94 > 08/96		S 4378 NR	S 1970 A	S 3053 C
	D 2876 LF 02	09/96 >	S 5016 PE	S 4378 NR	S 1970 A	S 3053 C
with gearbox ZF Ecosplit and Intarder / con cambio ZF Ecosplit e Intarder	D 2876 LF 02	01/94 >				S 2234 Z
dryer filter / filtro essiccatore	D 2876 LF 02	01/94 >				S 7259 A
inner / interno	D 2876 LF 02	01/94 >			S 7405 A	
2 filters / N.2 filtri	D 2876 LF 02	01/95 > 08/96	S 5005 PE			
prefilter with fuel oil heater / prefiltra con riscaldatore nafta	D 2876 LF 02	01/94 >		S 6059 NE		
prefilter without fuel oil heater / prefiltra senza riscaldatore nafta	D 2876 LF 02	01/94 >		S 6062 NE		
33.463 DF	D 2876 LF 02	01/94 > 08/96		S 4378 NR	S 1970 A	S 3053 C
	D 2876 LF 02	09/96 >	S 5016 PE	S 4378 NR	S 1970 A	S 3053 C
with gearbox ZF Ecosplit and Intarder / con cambio ZF Ecosplit e Intarder	D 2876 LF 02	01/94 >				S 2234 Z
dryer filter / filtro essiccatore	D 2876 LF 02	01/94 >				S 7259 A
inner / interno	D 2876 LF 02	01/94 >			S 7405 A	
2 filters / N.2 filtri	D 2876 LF 02	01/95 > 08/96	S 5005 PE			
prefilter with fuel oil heater / prefiltra con riscaldatore nafta	D 2876 LF 02	01/94 >		S 6059 NE		
prefilter without fuel oil heater / prefiltra senza riscaldatore nafta	D 2876 LF 02	01/94 >		S 6062 NE		
prefilter without fuel oil heater / prefiltra senza riscaldatore nafta	D 2876 LF 02	01/94 >		S 6062 NE		
33.464 DF	D 2876 LF 02/06	09/98 >	S 5016 PE	S 4378 NR	S 1970 A	S 3053 C
with gearbox ZF Ecosplit and Intarder / con cambio ZF Ecosplit e Intarder	D 2876 LF 02/06	09/98 >				S 2234 Z
dryer filter / filtro essiccatore	D 2876 LF 02/06	09/98 >				S 7259 A
inner / interno	D 2876 LF 02/06	09/98 >			S 7405 A	
prefilter with fuel oil heater / prefiltra con riscaldatore nafta	D 2876 LF 02/06	09/98 >		S 6059 NE		
prefilter without fuel oil heater / prefiltra senza riscaldatore nafta	D 2876 LF 02/06	09/98 >		S 6062 NE		
33.603 DF	D 2840 LF 20	09/97 >		S 4378 NR	S 1970 A	S 3053 C
with gearbox ZF Ecosplit and Intarder / con cambio ZF Ecosplit e Intarder	D 2840 LF 20	09/97 >				S 2234 Z
dryer filter / filtro essiccatore	D 2840 LF 20	09/97 >				S 7259 A
inner / interno	D 2840 LF 20	09/97 >			S 7405 A	
2 filters / N.2 filtri	D 2840 LF 20	09/97 >	S 5005 PE			
prefilter with fuel oil heater / prefiltra con riscaldatore nafta	D 2840 LF 20	09/97 >		S 6059 NE		
prefilter without fuel oil heater / prefiltra senza riscaldatore nafta	D 2840 LF 20	09/97 >		S 6062 NE		



kW HP



...MAN - trucks/autocarri

M

inner / interno	D 2876 LF 02	08/95 >			S 7405 A	
2 filters / N.2 filtri	D 2876 LF 02	08/95 > 08/96	S 5005 PE			
prefilter with fuel oil heater / prefiltra con riscaldatore nafta	D 2876 LF 02	08/95 >		S 6059 NE		
prefilter without fuel oil heater / prefiltra senza riscaldatore nafta	D 2876 LF 02	08/95 >		S 6062 NE		
35.463 VF	D 2876 LF 02	08/95 > 08/96		S 4378 NR	S 1970 A	S 3053 C
	D 2876 LF 02	09/96 >	S 5016 PE	S 4378 NR	S 1970 A	S 3053 C
with gearbox ZF Ecosplit and Intarder / con cambio ZF Ecosplit e Intarder	D 2876 LF 02	08/95 >				S 2234 Z
dryer filter / filtro essiccatore	D 2876 LF 02	08/95 >				S 7259 A
inner / interno	D 2876 LF 02	08/95 >			S 7405 A	
2 filters / N.2 filtri	D 2876 LF 02	08/95 > 08/96	S 5005 PE			
prefilter with fuel oil heater / prefiltra con riscaldatore nafta	D 2876 LF 02	08/95 >		S 6059 NE		
prefilter without fuel oil heater / prefiltra senza riscaldatore nafta	D 2876 LF 02	08/95 >		S 6062 NE		
35.464 F	D 2876 LF 06	09/98 >	S 5016 PE	S 4378 NR	S 1970 A	S 3053 C
with gearbox ZF Ecosplit and Intarder / con cambio ZF Ecosplit e Intarder	D 2876 LF 06	09/98 >				S 2234 Z
dryer filter / filtro essiccatore	D 2876 LF 06	09/98 >				S 7259 A
inner / interno	D 2876 LF 06	09/98 >			S 7405 A	
prefilter with fuel oil heater / prefiltra con riscaldatore nafta	D 2876 LF 06	09/98 >		S 6059 NE		
prefilter without fuel oil heater / prefiltra senza riscaldatore nafta	D 2876 LF 06	09/98 >		S 6062 NE		
35.464 VF	D 2876 LF 06	09/98 >	S 5016 PE	S 4378 NR	S 1970 A	S 3053 C
with gearbox ZF Ecosplit and Intarder / con cambio ZF Ecosplit e Intarder	D 2876 LF 06	09/98 >				S 2234 Z
dryer filter / filtro essiccatore	D 2876 LF 06	09/98 >				S 7259 A
inner / interno	D 2876 LF 06	09/98 >			S 7405 A	
prefilter with fuel oil heater / prefiltra con riscaldatore nafta	D 2876 LF 06	09/98 >		S 6059 NE		
prefilter without fuel oil heater / prefiltra senza riscaldatore nafta	D 2876 LF 06	09/98 >		S 6062 NE		
40.463 VFC	D 2876 LF 02	08/95 > 08/96		S 4378 NR	S 1970 A	S 3053 C
	D 2876 LF 02	09/96 >	S 5016 PE	S 4378 NR	S 1970 A	S 3053 C
with gearbox ZF Ecosplit and Intarder / con cambio ZF Ecosplit e Intarder	D 2876 LF 02	08/95 >				S 2234 Z
dryer filter / filtro essiccatore	D 2876 LF 02	08/95 >				S 7259 A
inner / interno	D 2876 LF 02	08/95 >			S 7405 A	
2 filters / N.2 filtri	D 2876 LF 02	08/95 > 08/96	S 5005 PE			
prefilter with fuel oil heater / prefiltra con riscaldatore nafta	D 2876 LF 02	08/95 >		S 6059 NE		
prefilter without fuel oil heater / prefiltra senza riscaldatore nafta	D 2876 LF 02	08/95 >		S 6062 NE		
power steering / servosterzo	D 2876 LF 02	08/95 >				S 3081 PO
40.463 VFK	D 2876 LF 02	08/95 > 08/96		S 4378 NR	S 1970 A	S 3053 C
	D 2876 LF 02	09/96 >	S 5016 PE	S 4378 NR	S 1970 A	S 3053 C
with gearbox ZF Ecosplit and Intarder / con cambio ZF Ecosplit e Intarder	D 2876 LF 02	08/95 >				S 2234 Z
dryer filter / filtro essiccatore	D 2876 LF 02	08/95 >				S 7259 A
inner / interno	D 2876 LF 02	08/95 >			S 7405 A	
2 filters / N.2 filtri	D 2876 LF 02	08/95 > 08/96	S 5005 PE			
prefilter with fuel oil heater / prefiltra con riscaldatore nafta	D 2876 LF 02	08/95 >		S 6059 NE		
prefilter without fuel oil heater / prefiltra senza riscaldatore nafta	D 2876 LF 02	08/95 >		S 6062 NE		
power steering / servosterzo	D 2876 LF 02	08/95 >				S 3081 PO
40.603 DF	D 2840 LF 20	09/97 >		S 4378 NR	S 1970 A	S 3053 C
with gearbox ZF Ecosplit and Intarder / con cambio ZF Ecosplit e Intarder	D 2840 LF 20	09/97 >				S 2234 Z
dryer filter / filtro essiccatore	D 2840 LF 20	09/97 >				S 7259 A
inner / interno	D 2840 LF 20	09/97 >			S 7405 A	
2 filters / N.2 filtri	D 2840 LF 20	09/97 >	S 5005 PE			
40.604 DF	D 2840 LF 21	08/97 >		S 4378 NR	S 1970 A	S 3053 C
with gearbox ZF Ecosplit and Intarder / con cambio ZF Ecosplit e Intarder	D 2840 LF 21	08/97 >				S 2234 Z
dryer filter / filtro essiccatore	D 2840 LF 21	08/97 >				S 7259 A
inner / interno	D 2840 LF 21	08/97 >			S 7405 A	
2 filters / N.2 filtri	D 2840 LF 21	08/97 >	S 5005 PE			
41.343	D 2865 LF 21	08/95 > 08/96		S 4378 NR	S 1970 A	S 3053 C
	D 2865 LF 21	09/96 >	S 5016 PE	S 4378 NR	S 1970 A	S 3053 C
with gearbox ZF Ecosplit and Intarder / con cambio ZF Ecosplit e Intarder	D 2865 LF 21	08/95 >				S 2234 Z
dryer filter / filtro essiccatore	D 2865 LF 21	08/95 >				S 7259 A
inner / interno	D 2865 LF 21	08/95 >			S 7405 A	
2 filters / N.2 filtri	D 2865 LF 21	08/95 > 08/96	S 5005 PE			
prefilter with fuel oil heater / prefiltra con riscaldatore nafta	D 2865 LF 21	08/95 >		S 6059 NE		
prefilter without fuel oil heater / prefiltra senza riscaldatore nafta	D 2865 LF 21	08/95 >		S 6062 NE		
41.343 VF	D 2865 LF 21	08/95 > 08/96		S 4378 NR	S 1970 A	S 3053 C
	D 2865 LF 21	09/96 >	S 5016 PE	S 4378 NR	S 1970 A	S 3053 C
with gearbox ZF Ecosplit and Intarder / con cambio ZF Ecosplit e Intarder	D 2865 LF 21	08/95 >				S 2234 Z
dryer filter / filtro essiccatore	D 2865 LF 21	08/95 >				S 7259 A
inner / interno	D 2865 LF 21	08/95 >			S 7405 A	
2 filters / N.2 filtri	D 2865 LF 21	08/95 > 08/96	S 5005 PE			
prefilter with fuel oil heater / prefiltra con riscaldatore nafta	D 2865 LF 21	08/95 >		S 6059 NE		

**KW HP****...MAN - trucks/autocarri**

41.403	D 2866 LF 20	294	400	08/95 >	08/96	S 5016 PE	S 1970 A	S 3053 C			
	D 2866 LF 20	294	400	09/96 >				S 1970 A	S 3053 C		
	with gearbox ZF Ecosplit and Intarder / con cambio ZF Ecosplit e Intarder	D 2866 LF 20	294	400	08/95 >					S 2234 Z	
	dryer filter / filtro essiccatore	D 2866 LF 20	294	400	08/95 >					S 7259 A	
	inner / interno	D 2866 LF 20	294	400	08/95 >				S 7405 A		
	2 filters / N.2 filtri	D 2866 LF 20	294	400	08/95 >			08/96	S 5005 PE	S 4378 NR	
2 filters / N.2 filtri	D 2866 LF 20	294	400	09/96 >		S 4378 NR					
41.403 VF	D 2866 LF 20	294	400	08/95 >	08/96	S 5016 PE	S 1970 A	S 3053 C			
	D 2866 LF 20	294	400	09/96 >				S 1970 A	S 3053 C		
	with gearbox ZF Ecosplit and Intarder / con cambio ZF Ecosplit e Intarder	D 2866 LF 20	294	400	08/95 >					S 2234 Z	
	dryer filter / filtro essiccatore	D 2866 LF 20	294	400	08/95 >					S 7259 A	
	inner / interno	D 2866 LF 20	294	400	08/95 >				S 7405 A		
	2 filters / N.2 filtri	D 2866 LF 20	294	400	08/95 >			08/96	S 5005 PE	S 4378 NR	
2 filters / N.2 filtri	D 2866 LF 20	294	400	09/96 >		S 4378 NR					
41.463	D 2876 LF 02	338	460	08/95 >	08/96	S 5016 PE	S 1970 A	S 3053 C			
	D 2876 LF 02	338	460	09/96 >				S 1970 A	S 3053 C		
	with gearbox ZF Ecosplit and Intarder / con cambio ZF Ecosplit e Intarder	D 2876 LF 02	338	460	08/95 >					S 2234 Z	
	dryer filter / filtro essiccatore	D 2876 LF 02	338	460	08/95 >					S 7259 A	
	inner / interno	D 2876 LF 02	338	460	08/95 >				S 7405 A		
	2 filters / N.2 filtri	D 2876 LF 02	338	460	08/95 >			08/96	S 5005 PE	S 4378 NR	
2 filters / N.2 filtri	D 2876 LF 02	338	460	09/96 >		S 4378 NR					
41.463 VF	D 2876 LF 02	338	460	08/95 >	08/96	S 5016 PE	S 1970 A	S 3053 C			
	D 2876 LF 02	338	460	09/96 >				S 1970 A	S 3053 C		
	with gearbox ZF Ecosplit and Intarder / con cambio ZF Ecosplit e Intarder	D 2876 LF 02	338	460	08/95 >					S 2234 Z	
	dryer filter / filtro essiccatore	D 2876 LF 02	338	460	08/95 >					S 7259 A	
	inner / interno	D 2876 LF 02	338	460	08/95 >				S 7405 A		
	2 filters / N.2 filtri	D 2876 LF 02	338	460	08/95 >			08/96	S 5005 PE	S 4378 NR	
2 filters / N.2 filtri	D 2876 LF 02	338	460	09/96 >		S 4378 NR					
41.603 DF	D 2840 LF 20	441	601	09/97 >		S 5005 PE	S 1970 A	S 3053 C			
	with gearbox ZF Ecosplit and Intarder / con cambio ZF Ecosplit e Intarder	D 2840 LF 20	441	601	09/97 >					S 2234 Z	
	dryer filter / filtro essiccatore	D 2840 LF 20	441	601	09/97 >					S 7259 A	
	inner / interno	D 2840 LF 20	441	601	09/97 >				S 7405 A		
	2 filters / N.2 filtri	D 2840 LF 20	441	601	09/97 >				S 5005 PE	S 4378 NR	
	2 filters / N.2 filtri	D 2840 LF 20	441	601	09/97 >				S 4378 NR		
50.603	D 2840 LF 20	441	601	09/97 >		S 5005 PE	S 1970 A	S 3053 C			
	with gearbox ZF Ecosplit and Intarder / con cambio ZF Ecosplit e Intarder	D 2840 LF 20	441	601	09/97 >					S 2234 Z	
	dryer filter / filtro essiccatore	D 2840 LF 20	441	601	09/97 >					S 7259 A	
	inner / interno	D 2840 LF 20	441	601	09/97 >				S 7405 A		
	2 filters / N.2 filtri	D 2840 LF 20	441	601	09/97 >				S 5005 PE	S 4378 NR	
	2 filters / N.2 filtri	D 2840 LF 20	441	601	09/97 >				S 4378 NR		
F90 Serie											
19.342	D 2865 LF 09			05/94 >	06/96	S 5005 PE	S 4378 NR	S 1970 A	S 3053 C		
	with gearbox ZF Ecosplit and Intarder / con cambio ZF Ecosplit e Intarder	D 2865 LF 09		05/94 >	06/96					S 2234 Z	
	dryer filter / filtro essiccatore	D 2865 LF 09		05/94 >	06/96					S 7259 A	
	inner / interno	D 2865 LF 09		05/94 >	06/96				S 7405 A		
	2 filters / N.2 filtri	D 2865 LF 09		02/95 >	06/96						
19.342 F	D 2865 LF 09			05/94 >	06/96	S 5005 PE	S 4378 NR	S 1970 A	S 3053 C		
	with gearbox ZF Ecosplit and Intarder / con cambio ZF Ecosplit e Intarder	D 2865 LF 09		05/94 >	06/96					S 2234 Z	
	dryer filter / filtro essiccatore	D 2865 LF 09		05/94 >	06/96					S 7259 A	
	inner / interno	D 2865 LF 09		05/94 >	06/96				S 7405 A		
	2 filters / N.2 filtri	D 2865 LF 09		02/95 >	06/96						
19.402	D 2866 LF 16			05/94 >	06/96	S 5005 PE	S 4378 NR	S 1970 A	S 3053 C		
	with gearbox ZF Ecosplit and Intarder / con cambio ZF Ecosplit e Intarder	D 2866 LF 16		05/94 >	06/96					S 2234 Z	
	dryer filter / filtro essiccatore	D 2866 LF 16		05/94 >	06/96					S 7259 A	
	inner / interno	D 2866 LF 16		05/94 >	06/96				S 7405 A		
	2 filters / N.2 filtri	D 2866 LF 16		02/95 >	06/96						
19.402 F	D 2866 LF 16			05/94 >	06/96	S 5005 PE	S 4378 NR	S 1970 A	S 3053 C		
	with gearbox ZF Ecosplit and Intarder / con cambio ZF Ecosplit e Intarder	D 2866 LF 16		05/94 >	06/96					S 2234 Z	
	dryer filter / filtro essiccatore	D 2866 LF 16		05/94 >	06/96					S 7259 A	
	inner / interno	D 2866 LF 16		05/94 >	06/96				S 7405 A		
	2 filters / N.2 filtri	D 2866 LF 16		02/95 >	06/96						
24.342	D 2865 LF 09			05/94 >	05/95	S 5005 PE	S 4378 NR	S 1970 A	S 3053 C		
	with gearbox ZF Ecosplit and Intarder / con cambio ZF Ecosplit e Intarder	D 2865 LF 09		05/94 >	05/95					S 2234 Z	
	dryer filter / filtro essiccatore	D 2865 LF 09		05/94 >	05/95					S 7259 A	
	inner / interno	D 2865 LF 09		05/94 >	05/95				S 7405 A		
	2 filters / N.2 filtri	D 2865 LF 09		02/95 >	05/95						
24.342 FNL	D 2865 LF 09			05/94 >	05/95	S 5005 PE	S 4378 NR	S 1970 A	S 3053 C		
	with gearbox ZF Ecosplit and Intarder / con cambio ZF Ecosplit e Intarder	D 2865 LF 09		05/94 >	05/95					S 2234 Z	
	dryer filter / filtro essiccatore	D 2865 LF 09		05/94 >	05/95					S 7259 A	

M



KW HP



...MAN - trucks/autocarri

M



2 filters / N.2 filtri	D 2866 LF 16	01/95 > 06/96	S 5005 PE			
41.402 VF	D 2866 LF 16	05/94 > 06/96		S 4378 NR	S 1970 A	S 3053 C
with gearbox ZF Ecosplit and Intarder / con cambio ZF Ecosplit e Intarder	D 2866 LF 16	05/94 > 06/96				S 2234 Z
dryer filter / filtro essiccatore	D 2866 LF 16	05/94 > 06/96				S 7259 A
inner / interno	D 2866 LF 16	05/94 > 06/96			S 7405 A	
2 filters / N.2 filtri	D 2866 LF 16	01/95 > 06/96	S 5005 PE			
48.362	D 2866 LXF	07/89 > 02/90	S 7260 PO	S 1411 N	S 1050 A	S 3053 C
spin-on / avvitabile	D 2866 LXF	07/89 > 02/90	S 7260 PO	S 4378 NR	S 1050 A	S 3053 C
dryer filter / filtro essiccatore	D 2866 LXF	07/89 > 02/90				S 7259 A
48.362 VF	D 2866 LXF	07/89 > 02/90	S 7260 PO	S 1411 N	S 1050 A	S 3053 C
spin-on / avvitabile	D 2866 LXF	07/89 > 02/90	S 7260 PO	S 4378 NR	S 1050 A	S 3053 C
dryer filter / filtro essiccatore	D 2866 LXF	07/89 > 02/90				S 7259 A

G90 Serie

10.150	D 0226 MF/Silent	05/90 > 10/93	S 5536 PO	S 4378 NR	S 2450 A	
10.150	D 0826 GF/01/02	09/87 > 10/93	S 3292 R	S 1378 NR	S 2450 A	
2nd passage / 2.passaggio	D 0826 GF/01/02	09/87 > 10/93		S 4378 NR		
10.150 F	D 0226 MF/Silent	05/90 > 10/93	S 5536 PO	S 4378 NR	S 2450 A	
10.150 F	D 0826 GF/01/02	09/87 > 10/93	S 3292 R	S 1378 NR	S 2450 A	
2nd passage / 2.passaggio	D 0826 GF/01/02	09/87 > 10/93		S 4378 NR		
6.100	D 0824 GF/01/02	09/87 > 10/93	S 3292 R	S 1378 NR	S 2450 A	
2nd passage / 2.passaggio	D 0824 GF/01/02	09/87 > 10/93		S 4378 NR		
6.100 F	D 0824 GF/01/02	09/87 > 10/93	S 3292 R	S 1378 NR	S 2450 A	
2nd passage / 2.passaggio	D 0824 GF/01/02	09/87 > 10/93		S 4378 NR		
8.100	D 0824 GF/01/02	09/87 > 10/93	S 3292 R	S 1378 NR	S 2450 A	
2nd passage / 2.passaggio	D 0824 GF/01/02	09/87 > 10/93		S 4378 NR		
8.100 F	D 0824 GF/01/02	09/87 > 10/93	S 3292 R	S 1378 NR	S 2450 A	
2nd passage / 2.passaggio	D 0824 GF/01/02	09/87 > 10/93		S 4378 NR		
8.150	D 0226 MF	05/90 > 10/93	S 5536 PO	S 4378 NR	S 2450 A	
some / alcuni	D 0226 MF	05/90 > 10/93	S 5536 PO	S 4378 NR	S 2650 A	
8.150	D 0826 GF/03	09/87 > 05/95	S 3292 R	S 1378 NR	S 2450 A	
2nd passage / 2.passaggio	D 0826 GF/03	09/87 > 05/95		S 4378 NR		
8.150 F	D 0226 MF	05/90 > 10/93	S 5536 PO	S 4378 NR	S 2450 A	
some / alcuni	D 0226 MF	05/90 > 10/93	S 5536 PO	S 4378 NR	S 2650 A	
8.150 F	D 0826 GF/03	09/87 > 05/95	S 3292 R	S 1378 NR	S 2450 A	
2nd passage / 2.passaggio	D 0826 GF/03	09/87 > 05/95		S 4378 NR		
9.150	D 0226 MF/Silent	05/90 > 10/93	S 3292 R	S 4378 NR	S 2450 A	
some / alcuni	D 0226 MF/Silent	05/90 > 10/93	S 3292 R	S 4378 NR	S 2650 A	
9.150	D 0826 GF/03	09/87 > 05/95	S 3292 R	S 1378 NR	S 2450 A	
2nd passage / 2.passaggio	D 0826 GF/03	09/87 > 05/95		S 4378 NR		
9.150 F	D 0226 MF/Silent	05/90 > 10/93	S 3292 R	S 4378 NR	S 2450 A	
some / alcuni	D 0226 MF/Silent	05/90 > 10/93	S 3292 R	S 4378 NR	S 2650 A	
9.150 F	D 0826 GF/03	09/87 > 05/95	S 3292 R	S 1378 NR	S 2450 A	
2nd passage / 2.passaggio	D 0826 GF/03	09/87 > 05/95		S 4378 NR		

L2000 Serie

10.145 L	D0834LFL02/11 103 140	05/01 >	S 3292 R	S 4378 NR	S 8502 A	S 3048 C
dryer filter / filtro essiccatore	D0834LFL02/11 103 140	05/01 >				S 7259 A
power steering / servosterzo	D0834LFL02/11 103 140	05/01 >				S 3081 PO
10.150	D0824LFO 114 155	04/95 >	S 3292 R	S 4378 NR	S 2450 A	S 3048 C
1st passage / 1.passaggio	D0824LFO 114 155	04/95 >		S 1378 NR		
dryer filter / filtro essiccatore	D0824LFO 114 155	04/95 >				S 7259 A
power steering / servosterzo	D0824LFO 114 155	04/95 >				S 3081 PO
10.150	D0824LFO 118 160	04/95 >	S 3292 R	S 4378 NR	S 2450 A	S 3048 C
1st passage / 1.passaggio	D0824LFO 118 160	04/95 >		S 1378 NR		
dryer filter / filtro essiccatore	D0824LFO 118 160	04/95 >				S 7259 A
power steering / servosterzo	D0824LFO 118 160	04/95 >				S 3081 PO
10.150 FOC	D0824LFO 114 155	04/95 >	S 3292 R	S 4378 NR	S 2450 A	S 3048 C
1st passage / 1.passaggio	D0824LFO 114 155	04/95 >		S 1378 NR		
dryer filter / filtro essiccatore	D0824LFO 114 155	04/95 >				S 7259 A
power steering / servosterzo	D0824LFO 114 155	04/95 >				S 3081 PO
10.150 FOC	D0824LFO 118 160	04/95 >	S 3292 R	S 4378 NR	S 2450 A	S 3048 C
1st passage / 1.passaggio	D0824LFO 118 160	04/95 >		S 1378 NR		
dryer filter / filtro essiccatore	D0824LFO 118 160	04/95 >				S 7259 A
power steering / servosterzo	D0824LFO 118 160	04/95 >				S 3081 PO
10.153	D0824LFL01/05 114 155	10/93 > 06/96	S 3292 R	S 1378 NR	S 2450 A	S 3048 C
2nd passage / 2.passaggio	D0824LFL01/05 114 155	10/93 > 06/96		S 4378 NR		
dryer filter / filtro essiccatore	D0824LFL01/05 114 155	10/93 > 06/96				S 7259 A
10.153 F	D0824LFL01/05 114 155	10/93 > 06/96	S 3292 R	S 1378 NR	S 2450 A	S 3048 C

**KW HP****...MAN - trucks/autocarri**

2nd passage / 2.passaggio	D0824LFL01/05	114	155	10/93	>	06/96		S 4378 NR		S 7259 A
dryer filter / filtro essiccatore	D0824LFL01/05	114	155	10/93	>	06/96				S 3048 C
10.163	D0824LFL02	118	160	05/94	>		S 3292 R	S 1378 NR	S 2650 A	S 3048 C
2nd passage / 2.passaggio	D0824LFL02	118	160	05/94	>			S 4378 NR		
some / alcuni	D0824LFL02	118	160	05/94	>		S 3292 R	S 1378 NR	S 2450 A	S 3048 C
dryer filter / filtro essiccatore	D0824LFL02	118	160	05/94	>					S 7259 A
power steering / servosterzo	D0824LFL02	118	160	05/94	>					S 3081 PO
10.163	D0824LFL06/09	114	155	05/94	>		S 3292 R	S 1378 NR	S 2650 A	S 3048 C
2nd passage / 2.passaggio	D0824LFL06/09	114	155	05/94	>			S 4378 NR		
some / alcuni	D0824LFL06/09	114	155	05/94	>		S 3292 R	S 1378 NR	S 2450 A	S 3048 C
dryer filter / filtro essiccatore	D0824LFL06/09	114	155	05/94	>					S 7259 A
power steering / servosterzo	D0824LFL06/09	114	155	05/94	>					S 3081 PO
10.163 F	D0824LFL02	118	160	05/94	>		S 3292 R	S 1378 NR	S 2650 A	S 3048 C
2nd passage / 2.passaggio	D0824LFL02	118	160	05/94	>			S 4378 NR		
some / alcuni	D0824LFL02	118	160	05/94	>		S 3292 R	S 1378 NR	S 2450 A	S 3048 C
dryer filter / filtro essiccatore	D0824LFL02	118	160	05/94	>					S 7259 A
power steering / servosterzo	D0824LFL02	118	160	05/94	>					S 3081 PO
10.163 F	D0824LFL06/09	114	155	05/94	>		S 3292 R	S 1378 NR	S 2650 A	S 3048 C
2nd passage / 2.passaggio	D0824LFL06/09	114	155	05/94	>			S 4378 NR		
some / alcuni	D0824LFL06/09	114	155	05/94	>		S 3292 R	S 1378 NR	S 2450 A	S 3048 C
dryer filter / filtro essiccatore	D0824LFL06/09	114	155	05/94	>					S 7259 A
power steering / servosterzo	D0824LFL06/09	114	155	05/94	>					S 3081 PO
10.185 L	D0834	132	180	05/01	>		S 3292 R	S 4378 NR	S 8502 A	S 3048 C
dryer filter / filtro essiccatore	D0834	132	180	05/01	>					S 7259 A
power steering / servosterzo	D0834	132	180	05/01	>					S 3081 PO
10.220 FOC	D0826LFL03	162	220	02/95	>		S 3292 R	S 1378 NR	S 8502 A	S 3048 C
2nd passage / 2.passaggio	D0826LFL03	162	220	02/95	>			S 4378 NR		
some / alcuni	D0826LFL03	162	220	02/95	>		S 3292 R	S 1378 NR	S 7187 A	S 3048 C
dryer filter / filtro essiccatore	D0826LFL03	162	220	02/95	>					S 7259 A
power steering / servosterzo	D0826LFL03	162	220	02/95	>					S 3081 PO
10.223	D0826LFL02/06	162	220	10/93	>	06/96	S 3292 R	S 1378 NR	S 2650 A	S 3048 C
2nd passage / 2.passaggio	D0826LFL02/06	162	220	10/93	>	06/96		S 4378 NR		
dryer filter / filtro essiccatore	D0826LFL02/06	162	220	10/93	>	06/96				S 7259 A
power steering / servosterzo	D0826LFL02/06	162	220	10/93	>	06/96				S 3081 PO
10.223 F	D0826LFL02/06	162	220	10/93	>	06/96	S 3292 R	S 1378 NR	S 2650 A	S 3048 C
2nd passage / 2.passaggio	D0826LFL02/06	162	220	10/93	>	06/96	S 3292 R	S 4378 NR	S 2650 A	
dryer filter / filtro essiccatore	D0826LFL02/06	162	220	10/93	>	06/96				S 7259 A
power steering / servosterzo	D0826LFL02/06	162	220	10/93	>	06/96				S 3081 PO
10.224	D0826LFL03	162	220	05/94	>		S 3292 R	S 1378 NR	S 2650 A	S 3048 C
2nd passage / 2.passaggio	D0826LFL03	162	220	05/94	>			S 4378 NR		
dryer filter / filtro essiccatore	D0826LFL03	162	220	05/94	>					S 7259 A
power steering / servosterzo	D0826LFL03	162	220	05/94	>					S 3081 PO
10.224 F	D 0826 LFL 03	162	220	05/94	>		S 3292 R	S 1378 NR	S 2650 A	S 3048 C
2nd passage / 2.passaggio	D 0826 LFL 03	162	220	05/94	>			S 4378 NR		
dryer filter / filtro essiccatore	D 0826 LFL 03	162	220	05/94	>					S 7259 A
power steering / servosterzo	D 0826 LFL 03	162	220	05/94	>					S 3081 PO
10.225 L	D0836LFL02	162	220	05/01	>		S 3292 R	S 4378 NR	S 8502 A	S 3048 C
dryer filter / filtro essiccatore	D0836LFL02	162	220	05/01	>					S 7259 A
power steering / servosterzo	D0836LFL02	162	220	05/01	>					S 3081 PO
8.103	D0824FL01	75	102	10/93	>	06/96	S 3292 R	S 1378 NR	S 2450 A	S 3048 C
2nd passage / 2.passaggio	D0824FL01	75	102	10/93	>	06/96		S 4378 NR		
dryer filter / filtro essiccatore	D0824FL01	75	102	10/93	>	06/96				S 7259 A
8.103 F	D0824FL01	75	102	10/93	>	06/96	S 3292 R	S 1378 NR	S 2450 A	S 3048 C
2nd passage / 2.passaggio	D0824FL01	75	102	10/93	>	06/96		S 4378 NR		
dryer filter / filtro essiccatore	D0824FL01	75	102	10/93	>	06/96				S 7259 A
8.113	D0824LFL04	81	110	08/95	>		S 3292 R	S 1378 NR	S 2450 A	S 3048 C
2nd passage / 2.passaggio	D0824LFL04	81	110	08/95	>			S 4378 NR		
dryer filter / filtro essiccatore	D0824LFL04	81	110	08/95	>					S 7259 A
8.113 L	D0824LFL04	81	110	08/95	>		S 3292 R	S 1378 NR	S 2450 A	S 3048 C
2nd passage / 2.passaggio	D0824LFL04	81	110	08/95	>			S 4378 NR		
dryer filter / filtro essiccatore	D0824LFL04	81	110	08/95	>					S 7259 A
8.113 LK	D0824LFL04	81	110	08/95	>		S 3292 R	S 1378 NR	S 2450 A	S 3048 C
2nd passage / 2.passaggio	D0824LFL04	81	110	08/95	>			S 4378 NR		
dryer filter / filtro essiccatore	D0824LFL04	81	110	08/95	>					S 7259 A
8.145 L	D0834LFL02/11	103	140	05/01	>		S 3292 R	S 4378 NR	S 8502 A	S 3048 C
dryer filter / filtro essiccatore	D0834LFL02/11	103	140	05/01	>					S 7259 A
prefilter with fuel oil heater / prefiltro con riscaldatore nafta	D0834LFL02/11	103	140	05/01	>			S 6064 NE		

M

**KW HP****...MAN - trucks/autocarri**

prefilter without fuel oil heater / prefiltrato senza riscaldatore nafta	D0834LFL02/11	103	140	05/01	>		S 6063 NE		S 3081 PO
power steering / servosterzo	D0834LFL02/11	103	140	05/01	>				S 3081 PO
8.150 FOC	D0824LFO	114	155	04/95	>	S 3292 R	S 1378 NR	S 2450 A	S 3048 C
2nd passage / 2.passaggio	D0824LFO	114	155	04/95	>		S 4378 NR		
dryer filter / filtro essiccatore	D0824LFO	114	155	04/95	>				S 7259 A
power steering / servosterzo	D0824LFO	114	155	04/95	>				S 3081 PO
8.150 FOC	D0824LFO	118	160	04/95	>	S 3292 R	S 1378 NR	S 2450 A	S 3048 C
2nd passage / 2.passaggio	D0824LFO	118	160	04/95	>		S 4378 NR		
dryer filter / filtro essiccatore	D0824LFO	118	160	04/95	>				S 7259 A
power steering / servosterzo	D0824LFO	118	160	04/95	>				S 3081 PO
8.153	D0824LFL01/05	114	155	10/93	> 07/97	S 3292 R	S 1378 NR	S 2450 A	S 3048 C
2nd passage / 2.passaggio	D0824LFL01/05	114	155	10/93	> 07/97		S 4378 NR		
dryer filter / filtro essiccatore	D0824LFL01/05	114	155	10/93	> 07/97				S 7259 A
8.153 F	D0824LFL01/05	114	155	10/93	> 07/97	S 3292 R	S 1378 NR	S 2450 A	S 3048 C
2nd passage / 2.passaggio	D0824LFL01/05	114	155	10/93	> 07/97		S 4378 NR		
dryer filter / filtro essiccatore	D0824LFL01/05	114	155	10/93	> 07/97				S 7259 A
8.155 L	D0834LF	114	155	02/04	>	S 3292 R	S 4378 NR	S 8502 A	S 3048 C
dryer filter / filtro essiccatore	D0834LF	114	155	02/04	>				S 7259 A
power steering / servosterzo	D0834LF	114	155	02/04	>				S 3081 PO
8.163	D0824LFL02	118	160	05/94	>	S 3292 R	S 1378 NR	S 2450 A	S 3048 C
2nd passage / 2.passaggio	D0824LFL02	118	160	05/94	>		S 4378 NR		
dryer filter / filtro essiccatore	D0824LFL02	118	160	05/94	>				S 7259 A
power steering / servosterzo	D0824LFL02	118	160	05/94	>				S 3081 PO
8.163	D0824LFL06/09	114	155	05/94	>	S 3292 R	S 1378 NR	S 2450 A	S 3048 C
2nd passage / 2.passaggio	D0824LFL06/09	114	155	05/94	>		S 4378 NR		
dryer filter / filtro essiccatore	D0824LFL06/09	114	155	05/94	>				S 7259 A
power steering / servosterzo	D0824LFL06/09	114	155	05/94	>				S 3081 PO
8.163 F	D0824LFL02	118	160	05/94	>	S 3292 R	S 1378 NR	S 2450 A	S 3048 C
2nd passage / 2.passaggio	D0824LFL02	118	160	05/94	>		S 4378 NR		
dryer filter / filtro essiccatore	D0824LFL02	118	160	05/94	>				S 7259 A
power steering / servosterzo	D0824LFL02	118	160	05/94	>				S 3081 PO
8.163 F	D0824LFL06/09	114	155	05/94	>	S 3292 R	S 1378 NR	S 2450 A	S 3048 C
2nd passage / 2.passaggio	D0824LFL06/09	114	155	05/94	>		S 4378 NR		
dryer filter / filtro essiccatore	D0824LFL06/09	114	155	05/94	>				S 7259 A
power steering / servosterzo	D0824LFL06/09	114	155	05/94	>				S 3081 PO
8.163 L	D0824LFL07	104	141	08/95	>	S 3292 R	S 1378 NR	S 2450 A	S 3048 C
2nd passage / 2.passaggio	D0824LFL07	104	141	08/95	>		S 4378 NR		
dryer filter / filtro essiccatore	D0824LFL07	104	141	08/95	>				S 7259 A
power steering / servosterzo	D0824LFL07	104	141	08/95	>				S 3081 PO
8.185 L	D0834LFL03	132	180	05/01	>	S 3292 R	S 4378 NR	S 8502 A	S 3048 C
dryer filter / filtro essiccatore	D0834LFL03	132	180	05/01	>				S 7259 A
power steering / servosterzo	D0834LFL03	132	180	05/01	>				S 3081 PO
8.220	D0826LFL03	162	220	04/95	>	S 3292 R	S 1378 NR	S 8502 A	S 3048 C
2nd passage / 2.passaggio	D0826LFL03	162	220	04/95	>		S 4378 NR		
some / alcuni	D0826LFL03	162	220	04/95	>	S 3292 R	S 1378 NR	S 7187 A	S 3048 C
dryer filter / filtro essiccatore	D0826LFL03	162	220	04/95	>				S 7259 A
power steering / servosterzo	D0826LFL03	162	220	04/95	>				S 3081 PO
8.220 FOC	D0826LFL03	162	220	04/95	>	S 3292 R	S 1378 NR	S 8502 A	S 3048 C
	D0826LFL03	162	220	04/95	>			S 7474 A	
2nd passage / 2.passaggio	D0826LFL03	162	220	04/95	>		S 4378 NR		
some / alcuni	D0826LFL03	162	220	04/95	>	S 3292 R	S 1378 NR	S 7187 A	S 3048 C
dryer filter / filtro essiccatore	D0826LFL03	162	220	04/95	>				S 7259 A
power steering / servosterzo	D0826LFL03	162	220	04/95	>				S 3081 PO
8.223	D0826LFL02	169	230	10/93	> 06/96	S 3292 R	S 1378 NR	S 2650 A	S 3048 C
2nd passage / 2.passaggio	D0826LFL02	169	230	10/93	> 06/96		S 4378 NR		
dryer filter / filtro essiccatore	D0826LFL02	169	230	10/93	> 06/96				S 7259 A
8.223 F	D0826LFL02	169	230	10/93	> 06/96	S 3292 R	S 1378 NR	S 2650 A	S 3048 C
2nd passage / 2.passaggio	D0826LFL02	169	230	10/93	> 06/96		S 4378 NR		
dryer filter / filtro essiccatore	D0826LFL02	169	230	10/93	> 06/96				S 7259 A
power steering / servosterzo	D0826LFL02	169	230	10/93	> 06/96				S 3081 PO
8.223 L	D0826LFL06	162	220	05/94	>	S 3292 R	S 1378 NR	S 2650 A	S 3048 C
2nd passage / 2.passaggio	D0826LFL06	162	220	05/94	>		S 4378 NR		
dryer filter / filtro essiccatore	D0826LFL06	162	220	05/94	>				S 7259 A
power steering / servosterzo	D0826LFL06	162	220	05/94	>				S 3081 PO
8.224	D0826LFL03	162	220	05/94	>	S 3292 R	S 1378 NR	S 2650 A	S 3048 C
2nd passage / 2.passaggio	D0826LFL03	162	220	05/94	>		S 4378 NR		
dryer filter / filtro essiccatore	D0826LFL03	162	220	05/94	>				S 7259 A

**KW HP****...MAN - trucks/autocarri**

8.224 F	D0826LFL03	162	220	05/94	>	S 3292 R	S 1378 NR	S 2650 A	S 3048 C
2nd passage / 2.passaggio	D0826LFL03	162	220	05/94	>		S 4378 NR		
dryer filter / filtro essiccatore	D0826LFL03	162	220	05/94	>				S 7259 A
8.225 L	D0836LFL02	162	220	05/01	>	S 3292 R	S 4378 NR	S 8502 A	S 3048 C
dryer filter / filtro essiccatore	D0836LFL02	162	220	05/01	>				S 7259 A
power steering / servosterzo	D0836LFL02	162	220	05/01	>				S 3081 PO
9.145 L	D0834LFL02/11	103	140	05/01	>	S 3292 R	S 4378 NR	S 8502 A	S 3048 C
dryer filter / filtro essiccatore	D0834LFL02/11	103	140	05/01	>				S 7259 A
power steering / servosterzo	D0834LFL02/11	103	140	05/01	>				S 3081 PO
9.153	D0824LFL01/05	114	155	10/93	> 06/96	S 3292 R	S 1378 NR	S 2450 A	S 3048 C
2nd passage / 2.passaggio	D0824LFL01/05	114	155	10/93	> 06/96		S 4378 NR		
dryer filter / filtro essiccatore	D0824LFL01/05	114	155	10/93	> 06/96				S 7259 A
9.153 F	D0824LFL01/05	114	155	10/93	> 06/96	S 3292 R	S 1378 NR	S 2450 A	S 3048 C
2nd passage / 2.passaggio	D0824LFL01/05	114	155	10/93	> 06/96		S 4378 NR		
dryer filter / filtro essiccatore	D0824LFL01/05	114	155	10/93	> 06/96				S 7259 A
9.163	D0824LFL02	118	160	05/94	>	S 3292 R	S 1378 NR	S 2450 A	S 3048 C
2nd passage / 2.passaggio	D0824LFL02	118	160	05/94	>		S 4378 NR		
dryer filter / filtro essiccatore	D0824LFL02	118	160	05/94	>				S 7259 A
9.163	D0824LFL06/09	114	155	05/94	>	S 3292 R	S 1378 NR	S 2450 A	S 3048 C
2nd passage / 2.passaggio	D0824LFL06/09	114	155	05/94	>		S 4378 NR		
dryer filter / filtro essiccatore	D0824LFL06/09	114	155	05/94	>				S 7259 A
9.163 F	D0824LFL02	118	160	05/94	>	S 3292 R	S 1378 NR	S 2450 A	S 3048 C
2nd passage / 2.passaggio	D0824LFL02	118	160	05/94	>		S 4378 NR		
dryer filter / filtro essiccatore	D0824LFL02	118	160	05/94	>				S 7259 A
9.163 F	D0824LFL06/09	114	155	05/94	>	S 3292 R	S 1378 NR	S 2450 A	S 3048 C
2nd passage / 2.passaggio	D0824LFL06/09	114	155	05/94	>		S 4378 NR		
dryer filter / filtro essiccatore	D0824LFL06/09	114	155	05/94	>				S 7259 A
9.163 L	D0824LFL07	104	141	08/95	> 03/97	S 3292 R	S 1378 NR	S 2450 A	S 3048 C
2nd passage / 2.passaggio	D0824LFL07	104	141	08/95	> 03/97		S 4378 NR		
dryer filter / filtro essiccatore	D0824LFL07	104	141	08/95	> 03/97				S 7259 A
power steering / servosterzo	D0824LFL07	104	141	08/95	> 03/97				S 3081 PO
9.185 L	D0834	132	180	05/01	>	S 3292 R	S 4378 NR	S 8502 A	S 3048 C
dryer filter / filtro essiccatore	D0834	132	180	05/01	>				S 7259 A
power steering / servosterzo	D0834	132	180	05/01	>				S 3081 PO
9.223	D0826LFL02/06	162	220	10/93	> 06/96	S 3292 R	S 1378 NR	S 2650 A	S 3048 C
2nd passage / 2.passaggio	D0826LFL02/06	162	220	10/93	> 06/96		S 4378 NR		
dryer filter / filtro essiccatore	D0826LFL02/06	162	220	10/93	> 06/96				S 7259 A
9.223 F	D0826LFL02/06	162	220	10/93	> 06/96	S 3292 R	S 1378 NR	S 2650 A	S 3048 C
2nd passage / 2.passaggio	D0826LFL02/06	162	220	10/93	> 06/96		S 4378 NR		
9.224	D0826LFL03	162	220	05/94	>	S 3292 R	S 1378 NR	S 2650 A	S 3048 C
2nd passage / 2.passaggio	D0826LFL03	162	220	05/94	>		S 4378 NR		
dryer filter / filtro essiccatore	D0826LFL03	162	220	05/94	>				S 7259 A
9.224 F	D0826LFL03	162	220	05/94	>	S 3292 R	S 1378 NR	S 2650 A	S 3048 C
2nd passage / 2.passaggio	D0826LFL03	162	220	05/94	>		S 4378 NR		
dryer filter / filtro essiccatore	D0826LFL03	162	220	05/94	>				S 7259 A
9.225 L	D0836LFL02	162	220	05/01	>	S 3292 R	S 4378 NR	S 8502 A	S 3048 C
dryer filter / filtro essiccatore	D0836LFL02	162	220	05/01	>				S 7259 A
power steering / servosterzo	D0836LFL02	162	220	05/01	>				S 3081 PO
LE Serie									
LE 110 C (L2000)	D0824LFL06	83	113	08/00	> 04/07	S 3292 R	S 4378 NR	S 8502 A	S 3048 C
dryer filter / filtro essiccatore	D0824LFL06	83	113	08/00	> 04/07				S 7259 A
prefilter without fuel oil heater / prefiltra senza riscaldatore nafta	D0824LFL06	83	113	08/00	> 04/07		S 6063 NE		
power steering / servosterzo	D0824LFL06	83	113	08/00	> 04/07				S 3081 PO
LE 110 C (L2000)	D0824LFL08	83	113	08/00	> 04/07	S 3292 R	S 4378 NR	S 8502 A	S 3048 C
dryer filter / filtro essiccatore	D0824LFL08	83	113	08/00	> 04/07				S 7259 A
power steering / servosterzo	D0824LFL08	83	113	08/00	> 04/07				S 3081 PO
LE 140 C (L2000)	D0834LFL02	103	140	01/01	> 04/07	S 3292 R	S 4378 NR	S 8502 A	S 3048 C
dryer filter / filtro essiccatore	D0834LFL02	103	140	01/01	> 04/07				S 7259 A
power steering / servosterzo	D0834LFL02	103	140	01/01	> 04/07				S 3081 PO
LE 160 C (L2000)	D0824LFL09	114	155	08/00	> 04/07	S 3292 R	S 4378 NR	S 8502 A	S 3048 C
dryer filter / filtro essiccatore	D0824LFL09	114	155	08/00	> 04/07				S 7259 A
power steering / servosterzo	D0824LFL09	114	155	08/00	> 04/07				S 3081 PO
LE 180 C (L2000)	D0834LFL03	132	180	09/00	> 04/07	S 3292 R	S 4378 NR	S 8502 A	S 3048 C
dryer filter / filtro essiccatore	D0834LFL03	132	180	09/00	> 04/07				S 7259 A
power steering / servosterzo	D0834LFL03	132	180	09/00	> 04/07				S 3081 PO
LE 220 B (M2000)	D 0826 LFL 10			09/00	> 04/07	S 3292 R	S 4378 NR	S 8502 A	S 3053 C
dryer filter / filtro essiccatore	D 0826 LFL 10			09/00	> 04/07				S 7259 A

M



KW HP



...MAN - trucks/autocarri

M



power steering / servosterzo	D 0826 LFL 10	09/00 > 04/07				S 3081 PO
LE 220 B (M2000)	D 0836	01/01 > 04/07	S 3292 R	S 4378 NR	S 8502 A	S 3053 C
dryer filter / filtro essiccatore	D 0836	01/01 > 04/07				S 7259 A
power steering / servosterzo	D 0836	01/01 > 04/07				S 3081 PO
LE 220 C (L2000)	D 0826 LFL 10	08/00 > 04/07	S 3292 R	S 4378 NR	S 8502 A	S 3048 C
dryer filter / filtro essiccatore	D 0826 LFL 10	08/00 > 04/07				S 7259 A
power steering / servosterzo	D 0826 LFL 10	08/00 > 04/07				S 3081 PO
LE 220 C (L2000)	D 0836	01/01 > 04/07	S 3292 R	S 4378 NR	S 8502 A	S 3048 C
dryer filter / filtro essiccatore	D 0836	01/01 > 04/07				S 7259 A
power steering / servosterzo	D 0836	01/01 > 04/07				S 3081 PO
LE 250 B (M2000)	D 0836	01/01 > 04/07	S 3292 R	S 4378 NR	S 8502 A	S 3053 C
dryer filter / filtro essiccatore	D 0836	01/01 > 04/07				S 7259 A
power steering / servosterzo	D 0836	01/01 > 04/07				S 3081 PO
LE 280 B (M2000)	D 0836	01/01 > 04/07	S 3292 R	S 4378 NR	S 8502 A	S 3053 C
dryer filter / filtro essiccatore	D 0836	01/01 > 04/07				S 7259 A
power steering / servosterzo	D 0836	01/01 > 04/07				S 3081 PO
M2000 Serie						
12.145 L	D 0834	05/01 >	S 3292 R	S 4378 NR	S 8502 A	S 3053 C
dryer filter / filtro essiccatore	D 0834	05/01 >				S 7259 A
power steering / servosterzo	D 0834	05/01 >				S 3081 PO
12.163	D 0824 LFL 06/09	08/95 >	S 3292 R	S 1378 NR		S 3053 C
2nd passage / 2.passaggio	D 0824 LFL 06/09	08/95 >		S 4378 NR		
some / alcuni	D 0824 LFL 06/09	08/95 >	S 3292 R	S 1378 NR	S 2450 A	S 3053 C
dryer filter / filtro essiccatore	D 0824 LFL 06/09	08/95 >				S 7259 A
12.163 L	D 0824 LFL 06/09	08/95 >	S 3292 R	S 1378 NR		S 3053 C
2nd passage / 2.passaggio	D 0824 LFL 06/09	08/95 >		S 4378 NR		
some / alcuni	D 0824 LFL 06/09	08/95 >	S 3292 R	S 1378 NR	S 2450 A	S 3053 C
dryer filter / filtro essiccatore	D 0824 LFL 06/09	08/95 >				S 7259 A
12.185 L	D 0834	05/01 >	S 3292 R	S 4378 NR	S 8502 A	S 3053 C
dryer filter / filtro essiccatore	D 0834	05/01 >				S 7259 A
power steering / servosterzo	D 0834	05/01 >				S 3081 PO
12.224	D 0826 LFL 03/06/10	05/94 >	S 3292 R	S 1378 NR	S 8502 A	S 3053 C
2nd passage / 2.passaggio	D 0826 LFL 03/06/10	05/94 >		S 4378 NR		
outer / esterno	D 0826 LFL 03/06/10	05/94 >	S 3292 R	S 1378 NR	S 7187 A	S 3053 C
dryer filter / filtro essiccatore	D 0826 LFL 03/06/10	05/94 >				S 7259 A
12.224 L	D 0826 LFL 03/06/10	05/94 >	S 3292 R	S 1378 NR	S 8502 A	S 3053 C
2nd passage / 2.passaggio	D 0826 LFL 03/06/10	05/94 >		S 4378 NR		
outer / esterno	D 0826 LFL 03/06/10	05/94 >	S 3292 R	S 1378 NR	S 7187 A	S 3053 C
dryer filter / filtro essiccatore	D 0826 LFL 03/06/10	05/94 >				S 7259 A
or / oppure	D 0826 LFL 03/06/10	05/94 >			S 7482 A	
12.225 L	D 0834	05/01 >	S 3292 R	S 4378 NR	S 8502 A	S 3053 C
dryer filter / filtro essiccatore	D 0834	05/01 >				S 7259 A
power steering / servosterzo	D 0834	05/01 >				S 3081 PO
12.255 L	D 0836	05/01 >	S 3292 R	S 4378 NR	S 8502 A	S 3053 C
dryer filter / filtro essiccatore	D 0836	05/01 >				S 7259 A
power steering / servosterzo	D 0836	05/01 >				S 3081 PO
12.264	D 0826 LF 17	11/98 >	S 3292 R	S 1378 NR	S 8502 A	S 3053 C
2nd passage / 2.passaggio	D 0826 LF 17	11/98 >		S 4378 NR		
dryer filter / filtro essiccatore	D 0826 LF 17	11/98 >				S 7259 A
power steering / servosterzo	D 0826 LF 17	11/98 >				S 3081 PO
12.284	D 0836 LF	11/98 >	S 3292 R	S 1378 NR	S 8502 A	S 3053 C
2nd passage / 2.passaggio	D 0836 LF	11/98 >		S 4378 NR		
dryer filter / filtro essiccatore	D 0836 LF	11/98 >				S 7259 A
14.163	D 0824 LFL 06/09	08/95 >	S 3292 R	S 1378 NR	S 8502 A	S 3053 C
2nd passage / 2.passaggio	D 0824 LFL 06/09	08/95 >		S 4378 NR		
dryer filter / filtro essiccatore	D 0824 LFL 06/09	08/95 >				S 7259 A
14.163 L	D 0824 LFL 06/09	08/95 >	S 3292 R	S 1378 NR	S 8502 A	S 3053 C
2nd passage / 2.passaggio	D 0824 LFL 06/09	08/95 >		S 4378 NR		
dryer filter / filtro essiccatore	D 0824 LFL 06/09	08/95 >				S 7259 A
14.185 L	D 0834	05/01 >	S 3292 R	S 4378 NR	S 8502 A	S 3053 C
dryer filter / filtro essiccatore	D 0834	05/01 >				S 7259 A
power steering / servosterzo	D 0834	05/01 >				S 3081 PO
14.185 M	D 0834	05/01 >	S 3292 R	S 4378 NR	S 8502 A	S 3053 C
dryer filter / filtro essiccatore	D 0834	05/01 >				S 7259 A
power steering / servosterzo	D 0834	05/01 >				S 3081 PO
14.224	D 0826 LFL 03/10/15/18	08/95 >	S 3292 R	S 1378 NR	S 8502 A	S 3053 C
2nd passage / 2.passaggio	D 0826 LFL 03/10/15/18	08/95 >		S 4378 NR		



kW HP



...MAN - trucks/autocarri

outer / esterno	D 0826 LFL 03/10/15/18	08/95 >	S 3292 R	S 1378 NR	S 7187 A	S 3053 C
dryer filter / filtro essiccatore	D 0826 LFL 03/10/15/18	08/95 >				S 7259 A
14.224 L	D 0826 LFL 03/10/15/18	08/95 >	S 3292 R	S 1378 NR	S 8502 A	S 3053 C
2nd passage / 2.passaggio	D 0826 LFL 03/10/15/18	08/95 >		S 4378 NR		
outer / esterno	D 0826 LFL 03/10/15/18	08/95 >	S 3292 R	S 1378 NR	S 7187 A	S 3053 C
dryer filter / filtro essiccatore	D 0826 LFL 03/10/15/18	08/95 >				S 7259 A
or / oppure	D 0826 LFL 03/10/15/18	08/95 >			S 7482 A	
14.224 M	D 0826 LFL 03/10/15/18	08/95 >	S 3292 R	S 1378 NR	S 8502 A	S 3053 C
2nd passage / 2.passaggio	D 0826 LFL 03/10/15/18	08/95 >		S 4378 NR		
outer / esterno	D 0826 LFL 03/10/15/18	08/95 >	S 3292 R	S 1378 NR	S 7187 A	S 3053 C
dryer filter / filtro essiccatore	D 0826 LFL 03/10/15/18	08/95 >				S 7259 A
or / oppure	D 0826 LFL 03/10/15/18	08/95 >			S 7482 A	
14.225 L	D 0836	05/01 >	S 3292 R	S 4378 NR	S 8502 A	S 3053 C
dryer filter / filtro essiccatore	D 0836	05/01 >				S 7259 A
power steering / servosterzo	D 0836	05/01 >				S 3081 PO
14.225 M	D 0836	05/01 >	S 3292 R	S 4378 NR	S 8502 A	S 3053 C
dryer filter / filtro essiccatore	D 0836	05/01 >				S 7259 A
power steering / servosterzo	D 0836	05/01 >				S 3081 PO
14.255 L	D 0836	05/01 >	S 3292 R	S 4378 NR	S 8502 A	S 3053 C
dryer filter / filtro essiccatore	D 0836	05/01 >				S 7259 A
power steering / servosterzo	D 0836	05/01 >				S 3081 PO
14.264	D 0826 LF 17	08/95 >	S 3292 R	S 1378 NR	S 8502 A	S 3053 C
2nd passage / 2.passaggio	D 0826 LF 17	08/95 >		S 4378 NR		
some / alcuni	D 0826 LF 17	08/95 >	S 3292 R	S 1378 NR	S 7187 A	S 3053 C
dryer filter / filtro essiccatore	D 0826 LF 17	08/95 >				S 7259 A
14.264	D 0826 LFL 09	08/95 >	S 3292 R	S 1378 NR	S 8502 A	S 3053 C
2nd passage / 2.passaggio	D 0826 LFL 09	08/95 >		S 4378 NR		
some / alcuni	D 0826 LFL 09	08/95 >	S 3292 R	S 1378 NR	S 7187 A	S 3053 C
dryer filter / filtro essiccatore	D 0826 LFL 09	08/95 >				S 7259 A
14.264 L	D 0826 LF 17	08/95 >	S 3292 R	S 1378 NR	S 8502 A	S 3053 C
2nd passage / 2.passaggio	D 0826 LF 17	08/95 >		S 4378 NR		
some / alcuni	D 0826 LF 17	08/95 >	S 3292 R	S 1378 NR	S 7187 A	S 3053 C
dryer filter / filtro essiccatore	D 0826 LF 17	08/95 >				S 7259 A
14.264 L	D 0826 LFL 09	08/95 >	S 3292 R	S 1378 NR	S 8502 A	S 3053 C
2nd passage / 2.passaggio	D 0826 LFL 09	08/95 >		S 4378 NR		
some / alcuni	D 0826 LFL 09	08/95 >	S 3292 R	S 1378 NR	S 7187 A	S 3053 C
dryer filter / filtro essiccatore	D 0826 LFL 09	08/95 >				S 7259 A
14.264 M	D 0826 LF 17	08/95 >	S 3292 R	S 1378 NR	S 8502 A	S 3053 C
2nd passage / 2.passaggio	D 0826 LF 17	08/95 >		S 4378 NR		
some / alcuni	D 0826 LF 17	08/95 >	S 3292 R	S 1378 NR	S 7187 A	S 3053 C
dryer filter / filtro essiccatore	D 0826 LF 17	08/95 >				S 7259 A
14.264 M	D 0826 LFL 09	08/95 >	S 3292 R	S 1378 NR	S 8502 A	S 3053 C
2nd passage / 2.passaggio	D 0826 LFL 09	08/95 >		S 4378 NR		
some / alcuni	D 0826 LFL 09	08/95 >	S 3292 R	S 1378 NR	S 7187 A	S 3053 C
dryer filter / filtro essiccatore	D 0826 LFL 09	08/95 >				S 7259 A
14.284	D 0836 LF/LFL 01	06/98 >	S 3292 R	S 1378 NR	S 8502 A	S 3053 C
2nd passage / 2.passaggio	D 0836 LF/LFL 01	06/98 >		S 4378 NR		
dryer filter / filtro essiccatore	D 0836 LF/LFL 01	06/98 >				S 7259 A
14.284 L	D 0836 LF/LFL 01	06/98 >	S 3292 R	S 1378 NR	S 8502 A	S 3053 C
2nd passage / 2.passaggio	D 0836 LF/LFL 01	06/98 >		S 4378 NR		
dryer filter / filtro essiccatore	D 0836 LF/LFL 01	06/98 >				S 7259 A
14.284 M	D 0836 LF/LFL 01	06/98 >	S 3292 R	S 1378 NR	S 8502 A	S 3053 C
2nd passage / 2.passaggio	D 0836 LF/LFL 01	06/98 >		S 4378 NR		
dryer filter / filtro essiccatore	D 0836 LF/LFL 01	06/98 >				S 7259 A
14.285 L	D 0836	05/01 >	S 3292 R	S 4378 NR	S 8502 A	S 3053 C
dryer filter / filtro essiccatore	D 0836	05/01 >				S 7259 A
power steering / servosterzo	D 0836	05/01 >				S 3081 PO
14.285 M	D 0836	05/01 >	S 3292 R	S 4378 NR	S 8502 A	S 3053 C
dryer filter / filtro essiccatore	D 0836	05/01 >				S 7259 A
power steering / servosterzo	D 0836	05/01 >				S 3081 PO
15.163	D 0824 LFL 06/09	08/95 >	S 3292 R	S 1378 NR	S 8502 A	S 3053 C
2nd passage / 2.passaggio	D 0824 LFL 06/09	08/95 >		S 4378 NR		
dryer filter / filtro essiccatore	D 0824 LFL 06/09	05/01 >				S 7259 A
power steering / servosterzo	D 0824 LFL 06/09	05/01 >				S 3081 PO
15.163 L	D 0824 LFL 06/09	08/95 >	S 3292 R	S 1378 NR	S 8502 A	S 3053 C
2nd passage / 2.passaggio	D 0824 LFL 06/09	08/95 >		S 4378 NR		
dryer filter / filtro essiccatore	D 0824 LFL 06/09	05/01 >				S 7259 A

M





KW HP



...MAN - trucks/autocarri

M

power steering / servosterzo	D 0824 LFL 06/09	05/01 >				S 3081 PO
15.185 L	D 0834	05/01 >	S 3292 R	S 4378 NR	S 8502 A	S 3053 C
dryer filter / filtro essiccatore	D 0834	05/01 >				S 7259 A
power steering / servosterzo	D 0834	05/01 >				S 3081 PO
15.224	D 0826 LFL 03/10	08/95 >	S 3292 R	S 1378 NR	S 8502 A	S 3053 C
2nd passage / 2.passaggio	D 0826 LFL 03/10	08/95 >		S 4378 NR		
some / alcuni	D 0826 LFL 03/10	08/95 >	S 3292 R	S 1378 NR	S 7187 A	S 3053 C
dryer filter / filtro essiccatore	D 0826 LFL 03/10	08/95 >				S 7259 A
power steering / servosterzo	D 0826 LFL 03/10	08/95 >				S 3081 PO
15.224 L	D 0826 LFL 03/10	08/95 >	S 3292 R	S 1378 NR	S 8502 A	S 3053 C
2nd passage / 2.passaggio	D 0826 LFL 03/10	08/95 >		S 4378 NR		
some / alcuni	D 0826 LFL 03/10	08/95 >	S 3292 R	S 1378 NR	S 7187 A	S 3053 C
dryer filter / filtro essiccatore	D 0826 LFL 03/10	08/95 >				S 7259 A
power steering / servosterzo	D 0826 LFL 03/10	08/95 >				S 3081 PO
15.225 L	D 0836	05/01 >	S 3292 R	S 4378 NR	S 8502 A	S 3053 C
dryer filter / filtro essiccatore	D 0836	05/01 >				S 7259 A
power steering / servosterzo	D 0836	05/01 >				S 3081 PO
15.255 L	D 0836	05/01 >	S 3292 R	S 4378 NR	S 8502 A	S 3053 C
dryer filter / filtro essiccatore	D 0836	05/01 >				S 7259 A
power steering / servosterzo	D 0836	05/01 >				S 3081 PO
15.264	D 0826 LFL 09	08/95 >	S 3292 R	S 1378 NR	S 8502 A	S 3053 C
2nd passage / 2.passaggio	D 0826 LFL 09	08/95 >		S 4378 NR		
some / alcuni	D 0826 LFL 09	08/95 >	S 3292 R	S 1378 NR	S 7187 A	S 3053 C
dryer filter / filtro essiccatore	D 0826 LFL 09	08/95 >				S 7259 A
power steering / servosterzo	D 0826 LFL 09	08/95 >				S 3081 PO
15.264 L	D 0826 LFL 09	08/95 >	S 3292 R	S 1378 NR	S 8502 A	S 3053 C
2nd passage / 2.passaggio	D 0826 LFL 09	08/95 >		S 4378 NR		
some / alcuni	D 0826 LFL 09	08/95 >	S 3292 R	S 1378 NR	S 7187 A	S 3053 C
dryer filter / filtro essiccatore	D 0826 LFL 09	08/95 >				S 7259 A
power steering / servosterzo	D 0826 LFL 09	08/95 >				S 3081 PO
15.284	D 0836 LF/LFL 01	06/98 >	S 3292 R	S 1378 NR	S 8502 A	S 3053 C
2nd passage / 2.passaggio	D 0836 LF/LFL 01	06/98 >		S 4378 NR		
dryer filter / filtro essiccatore	D 0836 LF/LFL 01	06/98 >				S 7259 A
power steering / servosterzo	D 0836 LF/LFL 01	06/98 >				S 3081 PO
15.284 L	D 0836 LF/LFL 01	06/98 >	S 3292 R	S 1378 NR	S 8502 A	S 3053 C
2nd passage / 2.passaggio	D 0836 LF/LFL 01	06/98 >		S 4378 NR		
dryer filter / filtro essiccatore	D 0836 LF/LFL 01	06/98 >				S 7259 A
power steering / servosterzo	D 0836 LF/LFL 01	06/98 >				S 3081 PO
15.285 L	D 0836	05/01 >	S 3292 R	S 4378 NR	S 8502 A	S 3053 C
dryer filter / filtro essiccatore	D 0836	05/01 >				S 7259 A
power steering / servosterzo	D 0836	05/01 >				S 3081 PO
18.224	D 0826 LF 15/18	08/95 >	S 3292 R	S 1378 NR	S 8502 A	S 3053 C
2nd passage / 2.passaggio	D 0826 LF 15/18	08/95 >		S 4378 NR		
some / alcuni	D 0826 LF 15/18	08/95 >	S 3292 R	S 1378 NR	S 7187 A	S 3053 C
dryer filter / filtro essiccatore	D 0826 LF 15/18	08/95 >				S 7259 A
18.224	D 0826 LFL 03/10	08/95 >	S 3292 R	S 1378 NR	S 8502 A	S 3053 C
2nd passage / 2.passaggio	D 0826 LFL 03/10	08/95 >		S 4378 NR		
some / alcuni	D 0826 LFL 03/10	08/95 >	S 3292 R	S 1378 NR	S 7187 A	S 3053 C
dryer filter / filtro essiccatore	D 0826 LFL 03/10	08/95 >				S 7259 A
18.224 L	D 0826 LF 15/18	08/95 >	S 3292 R	S 1378 NR	S 8502 A	S 3053 C
2nd passage / 2.passaggio	D 0826 LF 15/18	08/95 >		S 4378 NR		
some / alcuni	D 0826 LF 15/18	08/95 >	S 3292 R	S 1378 NR	S 7187 A	S 3053 C
dryer filter / filtro essiccatore	D 0826 LF 15/18	08/95 >				S 7259 A
18.224 L	D 0826 LFL 03/10	08/95 >	S 3292 R	S 1378 NR	S 8502 A	S 3053 C
2nd passage / 2.passaggio	D 0826 LFL 03/10	08/95 >		S 4378 NR		
some / alcuni	D 0826 LFL 03/10	08/95 >	S 3292 R	S 1378 NR	S 7187 A	S 3053 C
dryer filter / filtro essiccatore	D 0826 LFL 03/10	08/95 >				S 7259 A
18.225 L	D 0836	05/01 >	S 3292 R	S 4378 NR	S 8502 A	S 3053 C
dryer filter / filtro essiccatore	D 0836	05/01 >				S 7259 A
power steering / servosterzo	D 0836	05/01 >				S 3081 PO
18.225 M	D 0836	05/01 >	S 3292 R	S 4378 NR	S 8502 A	S 3053 C
dryer filter / filtro essiccatore	D 0836	05/01 >				S 7259 A
power steering / servosterzo	D 0836	05/01 >				S 3081 PO
18.255 L	D 0836	05/01 >	S 3292 R	S 4378 NR	S 8502 A	S 3053 C
dryer filter / filtro essiccatore	D 0836	05/01 >				S 7259 A
power steering / servosterzo	D 0836	05/01 >				S 3081 PO
18.255 M	D 0836	05/01 >	S 3292 R	S 4378 NR	S 8502 A	S 3053 C



KW HP



...MAN - trucks/autocarri

dryer filter / filtro essiccatore	D 0836	05/01 >				S 7259 A
power steering / servosterzo	D 0836	05/01 >				S 3081 PO
18.264	D 0826 LF 17	08/95 >	S 3292 R	S 1378 NR	S 8502 A	S 3053 C
2nd passage / 2.passaggio	D 0826 LF 17	08/95 >		S 4378 NR		
some / alcuni	D 0826 LF 17	08/95 >	S 3292 R	S 1378 NR	S 7187 A	S 3053 C
dryer filter / filtro essiccatore	D 0826 LF 17	08/95 >				S 7259 A
18.264	D 0826 LFL 09	08/95 >	S 3292 R	S 1378 NR	S 8502 A	S 3053 C
2nd passage / 2.passaggio	D 0826 LFL 09	08/95 >		S 4378 NR		
some / alcuni	D 0826 LFL 09	08/95 >	S 3292 R	S 1378 NR	S 7187 A	S 3053 C
dryer filter / filtro essiccatore	D 0826 LFL 09	08/95 >				S 7259 A
18.264 L	D 0826 LF 17	08/95 >	S 3292 R	S 1378 NR	S 8502 A	S 3053 C
2nd passage / 2.passaggio	D 0826 LF 17	08/95 >		S 4378 NR		
some / alcuni	D 0826 LF 17	08/95 >	S 3292 R	S 1378 NR	S 7187 A	S 3053 C
dryer filter / filtro essiccatore	D 0826 LF 17	08/95 >				S 7259 A
18.264 L	D 0826 LFL 09	08/95 >	S 3292 R	S 1378 NR	S 8502 A	S 3053 C
2nd passage / 2.passaggio	D 0826 LFL 09	08/95 >		S 4378 NR		
some / alcuni	D 0826 LFL 09	08/95 >	S 3292 R	S 1378 NR	S 7187 A	S 3053 C
dryer filter / filtro essiccatore	D 0826 LFL 09	08/95 >				S 7259 A
18.284	D 0836 LF/LFL 01	06/98 >	S 3292 R	S 1378 NR	S 8502 A	S 3053 C
2nd passage / 2.passaggio	D 0836 LF/LFL 01	06/98 >		S 4378 NR		
dryer filter / filtro essiccatore	D 0836 LF/LFL 01	06/98 >				S 7259 A
18.284 L	D 0836 LF/LFL 01	06/98 >	S 3292 R	S 1378 NR	S 8502 A	S 3053 C
2nd passage / 2.passaggio	D 0836 LF/LFL 01	06/98 >		S 4378 NR		
dryer filter / filtro essiccatore	D 0836 LF/LFL 01	06/98 >				S 7259 A
18.284 M	D 0836 LF/LFL 01	06/98 >	S 3292 R	S 1378 NR	S 8502 A	S 3053 C
2nd passage / 2.passaggio	D 0836 LF/LFL 01	06/98 >		S 4378 NR		
dryer filter / filtro essiccatore	D 0836 LF/LFL 01	06/98 >				S 7259 A
18.285	D 0836	05/01 >	S 3292 R	S 4378 NR	S 8502 A	S 3053 C
dryer filter / filtro essiccatore	D 0836	05/01 >				S 7259 A
power steering / servosterzo	D 0836	05/01 >				S 3081 PO
18.285 L	D 0836	05/01 >	S 3292 R	S 4378 NR	S 8502 A	S 3053 C
dryer filter / filtro essiccatore	D 0836	05/01 >				S 7259 A
power steering / servosterzo	D 0836	05/01 >				S 3081 PO
18.285 M	D 0836	05/01 >	S 3292 R	S 4378 NR	S 8502 A	S 3053 C
dryer filter / filtro essiccatore	D 0836	05/01 >				S 7259 A
power steering / servosterzo	D 0836	05/01 >				S 3081 PO
19.264	D 0826 LF 17	08/95 >	S 3292 R	S 4378 NR	S 8502 A	S 3053 C
outer / esterno	D 0826 LF 17	08/95 >	S 3292 R	S 4378 NR	S 7187 A	S 3053 C
dryer filter / filtro essiccatore	D 0826 LF 17	08/95 >				S 7259 A
or / oppure	D 0826 LF 17	08/95 >			S 7482 A	
19.264	D 0826 LFL 09	08/95 >	S 3292 R	S 4378 NR	S 8502 A	S 3053 C
outer / esterno	D 0826 LFL 09	08/95 >	S 3292 R	S 4378 NR	S 7187 A	S 3053 C
dryer filter / filtro essiccatore	D 0826 LFL 09	08/95 >				S 7259 A
or / oppure	D 0826 LFL 09	08/95 >			S 7482 A	
20.224	D 0826 LFL 10	09/97 >	S 3292 R	S 4378 NR	S 8502 A	S 3053 C
some / alcuni	D 0826 LFL 10	09/97 >	S 3292 R	S 4378 NR	S 7187 A	S 3053 C
dryer filter / filtro essiccatore	D 0826 LFL 10	09/97 >				S 7259 A
20.224 L	D 0826 LFL 10	09/97 >	S 3292 R	S 4378 NR	S 8502 A	S 3053 C
some / alcuni	D 0826 LFL 10	09/97 >	S 3292 R	S 4378 NR	S 7187 A	S 3053 C
dryer filter / filtro essiccatore	D 0826 LFL 10	09/97 >				S 7259 A
20.225 L	D 0836	05/01 >	S 3292 R	S 4378 NR	S 8502 A	S 3053 C
dryer filter / filtro essiccatore	D 0836	05/01 >				S 7259 A
power steering / servosterzo	D 0836	05/01 >				S 3081 PO
20.255 L	D 0836	05/01 >	S 3292 R	S 4378 NR	S 8502 A	S 3053 C
dryer filter / filtro essiccatore	D 0836	05/01 >				S 7259 A
power steering / servosterzo	D 0836	05/01 >				S 3081 PO
20.264	D 0826 LFL 09	09/97 >	S 3292 R	S 4378 NR	S 8502 A	S 3053 C
some / alcuni	D 0826 LFL 09	09/97 >	S 3292 R	S 1378 NR	S 7187 A	S 3053 C
dryer filter / filtro essiccatore	D 0826 LFL 09	09/97 >				S 7259 A
20.264 L	D 0826 LFL 09	09/97 >	S 3292 R	S 4378 NR	S 8502 A	S 3053 C
some / alcuni	D 0826 LFL 09	09/97 >	S 3292 R	S 1378 NR	S 7187 A	S 3053 C
dryer filter / filtro essiccatore	D 0826 LFL 09	09/97 >				S 7259 A
20.284	D 0836 LF/LFL 01	11/98 >	S 3292 R	S 1378 NR	S 8502 A	S 3053 C
2nd passage / 2.passaggio	D 0836 LF/LFL 01	11/98 >		S 4378 NR		
dryer filter / filtro essiccatore	D 0836 LF/LFL 01	11/98 >				S 7259 A
20.284 L	D 0836 LF/LFL 01	11/98 >	S 3292 R	S 1378 NR	S 8502 A	S 3053 C
2nd passage / 2.passaggio	D 0836 LF/LFL 01	11/98 >		S 4378 NR		

M





KW HP



...MAN - trucks/autocarri

M



dryer filter / filtro essiccatore	D 0836 LF/LFL 01	11/98 >				S 7259 A
20.285	D 0836	05/01 >	S 3292 R	S 4378 NR	S 8502 A	S 3053 C
dryer filter / filtro essiccatore	D 0836	05/01 >				S 7259 A
power steering / servosterzo	D 0836	05/01 >				S 3081 PO
20.285 L	D 0836	05/01 >	S 3292 R	S 4378 NR	S 8502 A	S 3053 C
dryer filter / filtro essiccatore	D 0836	05/01 >				S 7259 A
power steering / servosterzo	D 0836	05/01 >				S 3081 PO
23.284	D 0836 LF	11/98 >	S 3292 R	S 1378 NR	S 8502 A	S 3053 C
2nd passage / 2.passaggio	D 0836 LF	11/98 >		S 4378 NR		
dryer filter / filtro essiccatore	D 0836 LF	11/98 >				S 7259 A
23.284 L	D 0836 LF	11/98 >	S 3292 R	S 1378 NR	S 8502 A	S 3053 C
2nd passage / 2.passaggio	D 0836 LF	11/98 >		S 4378 NR		
dryer filter / filtro essiccatore	D 0836 LF	11/98 >				S 7259 A
25.224	D 0826 LF 15/18	08/95 >	S 3292 R	S 1378 NR	S 8502 A	S 3053 C
2nd passage / 2.passaggio	D 0826 LF 15/18	08/95 >		S 4378 NR		
some / alcuni	D 0826 LF 15/18	08/95 >	S 3292 R	S 1378 NR	S 7187 A	S 3053 C
dryer filter / filtro essiccatore	D 0826 LF 15/18	08/95 >				S 7259 A
power steering / servosterzo	D 0826 LF 15/18	08/95 >				S 3081 PO
25.224 M	D 0826 LF 15/18	08/95 >	S 3292 R	S 1378 NR	S 8502 A	S 3053 C
2nd passage / 2.passaggio	D 0826 LF 15/18	08/95 >		S 4378 NR		
some / alcuni	D 0826 LF 15/18	08/95 >	S 3292 R	S 1378 NR	S 7187 A	S 3053 C
dryer filter / filtro essiccatore	D 0826 LF 15/18	08/95 >				S 7259 A
power steering / servosterzo	D 0826 LF 15/18	08/95 >				S 3081 PO
25.225 M	D 0836	05/01 >	S 3292 R	S 4378 NR	S 8502 A	S 3053 C
dryer filter / filtro essiccatore	D 0836	05/01 >				S 7259 A
power steering / servosterzo	D 0836	05/01 >				S 3081 PO
25.255 M	D 0836	05/01 >	S 3292 R	S 4378 NR	S 8502 A	S 3053 C
dryer filter / filtro essiccatore	D 0836	05/01 >				S 7259 A
power steering / servosterzo	D 0836	05/01 >				S 3081 PO
25.264	D 0826 LF 17	08/95 >	S 3292 R	S 1378 NR	S 8502 A	S 3053 C
2nd passage / 2.passaggio	D 0826 LF 17	08/95 >		S 4378 NR		
outer / esterno	D 0826 LF 17	08/95 >	S 3292 R	S 1378 NR	S 7187 A	S 3053 C
dryer filter / filtro essiccatore	D 0826 LF 17	08/95 >				S 7259 A
power steering / servosterzo	D 0826 LF 17	08/95 >				S 3081 PO
25.264 M	D 0826 LF 17	08/95 >	S 3292 R	S 1378 NR	S 8502 A	
2nd passage / 2.passaggio	D 0826 LF 17	08/95 >		S 4378 NR		
outer / esterno	D 0826 LF 17	08/95 >	S 3292 R	S 1378 NR	S 7187 A	S 3053 C
dryer filter / filtro essiccatore	D 0826 LF 17	08/95 >				S 7259 A
or / oppure	D 0826 LF 17	08/95 >			S 7482 A	
power steering / servosterzo	D 0826 LF 17	08/95 >				S 3081 PO
25.284	D 0836 LF/LF 01	11/98 >	S 3292 R	S 1378 NR	S 8502 A	S 3053 C
2nd passage / 2.passaggio	D 0836 LF/LF 01	11/98 >		S 4378 NR		
dryer filter / filtro essiccatore	D 0836 LF/LF 01	11/98 >				S 7259 A
25.284 L	D 0836 LF/LF 01	11/98 >	S 3292 R	S 1378 NR	S 8502 A	S 3053 C
2nd passage / 2.passaggio	D 0836 LF/LF 01	11/98 >		S 4378 NR		
dryer filter / filtro essiccatore	D 0836 LF/LF 01	11/98 >				S 7259 A
25.284 M	D 0836 LF/LF 01	11/98 >	S 3292 R	S 1378 NR	S 8502 A	S 3053 C
2nd passage / 2.passaggio	D 0836 LF/LF 01	11/98 >		S 4378 NR		
dryer filter / filtro essiccatore	D 0836 LF/LF 01	11/98 >				S 7259 A
25.285 M	D 0836	05/01 >	S 3292 R	S 4378 NR	S 8502 A	S 3053 C
dryer filter / filtro essiccatore	D 0836	05/01 >				S 7259 A
power steering / servosterzo	D 0836	05/01 >				S 3081 PO
26.224 L	D 0826 LF/LFL	09/97 >	S 3292 R	S 4378 NR	S 8502 A	S 3053 C
dryer filter / filtro essiccatore	D 0826 LF/LFL	09/97 >				S 7259 A
26.225 L	D 0836	05/01 >	S 3292 R	S 4378 NR	S 8502 A	S 3053 C
dryer filter / filtro essiccatore	D 0836	05/01 >				S 7259 A
power steering / servosterzo	D 0836	05/01 >				S 3081 PO
26.255 L	D 0836	05/01 >	S 3292 R	S 4378 NR	S 8502 A	S 3053 C
dryer filter / filtro essiccatore	D 0836	05/01 >				S 7259 A
power steering / servosterzo	D 0836	05/01 >				S 3081 PO
26.284 L	D 0836 LFL 01	05/99 >	S 3292 R	S 4378 NR	S 8502 A	S 3053 C
dryer filter / filtro essiccatore	D 0836 LFL 01	05/99 >				S 7259 A
26.285 L	D 0836	05/01 >	S 3292 R	S 4378 NR	S 8502 A	S 3053 C
dryer filter / filtro essiccatore	D 0836	05/01 >				S 7259 A
power steering / servosterzo	D 0836	05/01 >				S 3081 PO
M90 Serie						
12.152	D 0826 F 01/02	12/88 > 05/94	S 3292 R	S 1378 NR	S 2450 A	

**KW HP****...MAN - trucks/autocarri**

2nd passage / 2.passaggio	D 0826 F 01/02	12/88 > 05/94		S 4378 NR	
12.152 F	D 0826 F 01/02	12/88 > 05/94	S 3292 R	S 1378 NR	S 2450 A
2nd passage / 2.passaggio	D 0826 F 01/02	12/88 > 05/94		S 4378 NR	
12.192	D 0826 LF 01/05/07	07/90 > 06/96	S 3292 R	S 1378 NR	S 2650 A
2nd passage / 2.passaggio	D 0826 LF 01/05/07	07/90 > 06/96		S 4378 NR	
12.192 F	D 0826 LF 01/05/07	07/90 > 06/96	S 3292 R	S 1378 NR	S 2650 A
2nd passage / 2.passaggio	D 0826 LF 01/05/07	07/90 > 06/96		S 4378 NR	
12.222	D 0826 LF 11	05/94 > 06/96	S 3292 R	S 1378 NR	
2nd passage / 2.passaggio	D 0826 LF 11	05/94 > 06/96		S 4378 NR	
12.222 F	D 0826 LF 11	05/94 > 06/96	S 3292 R	S 1378 NR	
2nd passage / 2.passaggio	D 0826 LF 11	05/94 > 06/96		S 4378 NR	
12.232	D 0826 LF 02/06/08	08/88 > 06/96	S 3292 R	S 1378 NR	S 2650 A
2nd passage / 2.passaggio	D 0826 LF 02/06/08	08/88 > 06/96		S 4378 NR	
12.232 F	D 0826 LF 02/06/08	08/88 > 06/96	S 3292 R	S 1378 NR	S 2650 A
2nd passage / 2.passaggio	D 0826 LF 02/06/08	08/88 > 06/96		S 4378 NR	
12.272	D 0826 LF 04	10/92 > 06/96	S 3292 R	S 1378 NR	
2nd passage / 2.passaggio	D 0826 LF 04	10/92 > 06/96		S 4378 NR	
12.272 F	D 0826 LF 04	10/92 > 06/96	S 3292 R	S 1378 NR	
2nd passage / 2.passaggio	D 0826 LF 04	10/92 > 06/96		S 4378 NR	
14.152	D 0824 LF 01	05/94 > 06/96	S 3292 R	S 1378 NR	S 2450 A
2nd passage / 2.passaggio	D 0824 LF 01	05/94 > 06/96		S 4378 NR	
14.152	D 0826 F 01/02	12/88 > 05/94	S 3292 R	S 1378 NR	S 2450 A
2nd passage / 2.passaggio	D 0826 F 01/02	12/88 > 05/94		S 4378 NR	
14.152 F	D 0824 LF 01	05/94 > 06/96	S 3292 R	S 1378 NR	S 2450 A
2nd passage / 2.passaggio	D 0824 LF 01	05/94 > 06/96		S 4378 NR	
14.152 F	D 0826 F 01/02	12/88 > 05/94	S 3292 R	S 1378 NR	S 2450 A
2nd passage / 2.passaggio	D 0826 F 01/02	12/88 > 05/94		S 4378 NR	
14.162	D 0824 LF 02	08/95 > 06/96	S 3292 R	S 1378 NR	S 2450 A
2nd passage / 2.passaggio	D 0824 LF 02	08/95 > 06/96		S 4378 NR	
14.192	D 0826 LF 01/05/07	07/90 > 06/96	S 3292 R	S 1378 NR	S 2650 A
2nd passage / 2.passaggio	D 0826 LF 01/05/07	07/90 > 06/96		S 4378 NR	
14.192	D 0826 TF	08/88 > 06/90	S 3292 R	S 1378 NR	S 2650 A
2nd passage / 2.passaggio	D 0826 TF	08/88 > 06/90		S 4378 NR	
14.192 F	D 0826 LF 01/05/07	07/90 > 06/96	S 3292 R	S 1378 NR	S 2650 A
2nd passage / 2.passaggio	D 0826 LF 01/05/07	07/90 > 06/96		S 4378 NR	
14.222	D 0826 LF 11	05/94 > 06/96	S 3292 R	S 1378 NR	S 2650 A
2nd passage / 2.passaggio	D 0826 LF 11	05/94 > 06/96		S 4378 NR	
14.222 F	D 0826 LF 11	05/94 > 06/96	S 3292 R	S 1378 NR	S 2650 A
2nd passage / 2.passaggio	D 0826 LF 11	05/94 > 06/96		S 4378 NR	
14.232	D 0826 LF 02/06/08	08/88 > 06/96	S 3292 R	S 1378 NR	S 2650 A
2nd passage / 2.passaggio	D 0826 LF 02/06/08	08/88 > 06/96		S 4378 NR	
14.232	D 0826 LF 217/Silent	05/90 > 04/95	S 3292 R	S 1378 NR	S 2650 A
2nd passage / 2.passaggio	D 0826 LF 217/Silent	05/90 > 04/95		S 4378 NR	
14.232 F	D 0826 LF 217/Silent	05/90 > 04/95	S 3292 R	S 1378 NR	S 2650 A
2nd passage / 2.passaggio	D 0826 LF 217/Silent	05/90 > 04/95		S 4378 NR	
14.262	D 0826 LF 13	08/95 > 06/96	S 3292 R	S 1378 NR	S 2650 A
2nd passage / 2.passaggio	D 0826 LF 13	08/95 > 06/96		S 4378 NR	
some / alcuni	D 0826 LF 13	08/95 > 06/96	S 3292 R	S 1378 NR	S 7187 A
14.262 F	D 0826 LF 13	08/95 > 06/96	S 3292 R	S 1378 NR	S 2650 A
2nd passage / 2.passaggio	D 0826 LF 13	08/95 > 06/96		S 4378 NR	
some / alcuni	D 0826 LF 13	08/95 > 06/96	S 3292 R	S 1378 NR	S 7187 A
14.272	D 0826 LF 04	10/92 > 06/96	S 3292 R	S 1378 NR	S 7187 A
2nd passage / 2.passaggio	D 0826 LF 04	10/92 > 06/96	S 3292 R	S 4378 NR	
14.272 F	D 0826 LF 04	10/92 > 06/96	S 3292 R	S 1378 NR	S 7187 A
2nd passage / 2.passaggio	D 0826 LF 04	10/92 > 06/96		S 4378 NR	
17.192	D 0826 LF 01/05/07	07/90 > 06/96	S 3292 R	S 1378 NR	S 2650 A
2nd passage / 2.passaggio	D 0826 LF 01/05/07	07/90 > 06/96		S 4378 NR	
17.192	D 0826 TF	08/88 > 06/90	S 3292 R	S 1378 NR	S 2650 A
2nd passage / 2.passaggio	D 0826 TF	08/88 > 06/90		S 4378 NR	
17.192 F	D 0826 LF 01/05/07	07/90 > 06/96	S 3292 R	S 1378 NR	S 2650 A
2nd passage / 2.passaggio	D 0826 LF 01/05/07	07/90 > 06/96		S 4378 NR	
17.222	D 0826 LF 11	05/94 > 06/96	S 3292 R	S 1378 NR	
2nd passage / 2.passaggio	D 0826 LF 11	05/94 > 06/96		S 4378 NR	
some / alcuni	D 0826 LF 11	05/94 > 06/96	S 3292 R	S 1378 NR	S 2650 A
17.222 FA	D 0826 LF 11	05/94 > 06/96	S 3292 R	S 1378 NR	
2nd passage / 2.passaggio	D 0826 LF 11	05/94 > 06/96		S 4378 NR	
some / alcuni	D 0826 LF 11	05/94 > 06/96	S 3292 R	S 1378 NR	S 2650 A

M



KW HP



...MAN - trucks/autocarri

M



17.232	D 0826 LF 02/06/08			08/88 > 06/96	S 3292 R	S 1378 NR	S 2650 A	
2nd passage / 2.passaggio	D 0826 LF 02/06/08			08/88 > 06/96		S 4378 NR		
17.232	D 0826 LF 217/Silent			05/90 > 04/95	S 3292 R	S 1378 NR	S 2650 A	
2nd passage / 2.passaggio	D 0826 LF 217/Silent			05/90 > 04/95		S 4378 NR		
dryer filter / filtro essiccatore	D 0826 LF 217/Silent			05/90 > 04/95				S 7259 A
17.232 F	D 0826 LF 217/Silent			05/90 > 04/95	S 3292 R	S 1378 NR	S 2650 A	
2nd passage / 2.passaggio	D 0826 LF 217/Silent			05/90 > 04/95		S 4378 NR		
18.192	D 0826 LF 01/05/07			09/90 > 06/96	S 3292 R	S 1378 NR	S 2650 A	
2nd passage / 2.passaggio	D 0826 LF 01/05/07			09/90 > 06/96		S 4378 NR		
18.192 F	D 0826 LF 01/05/07			09/90 > 06/96	S 3292 R	S 1378 NR	S 2650 A	
2nd passage / 2.passaggio	D 0826 LF 01/05/07			09/90 > 06/96		S 4378 NR		
18.222	D 0826 LF 11			05/94 > 06/96	S 3292 R	S 1378 NR	S 2650 A	
2nd passage / 2.passaggio	D 0826 LF 11			05/94 > 06/96		S 4378 NR		
18.222 F	D 0826 LF 11			05/94 > 06/96	S 3292 R	S 1378 NR	S 2650 A	
2nd passage / 2.passaggio	D 0826 LF 11			05/94 > 06/96		S 4378 NR		
18.232	D 0826 LF 02/06/08			09/90 > 06/96	S 3292 R	S 1378 NR	S 2650 A	
2nd passage / 2.passaggio	D 0826 LF 02/06/08			09/90 > 06/96		S 4378 NR		
18.232 F	D 0826 LF 02/06/08			09/90 > 06/96	S 3292 R	S 1378 NR	S 2650 A	
2nd passage / 2.passaggio	D 0826 LF 02/06/08			09/90 > 06/96		S 4378 NR		
18.262	D 0826 LF 13			08/95 > 06/96	S 3292 R	S 1378 NR	S 2650 A	
2nd passage / 2.passaggio	D 0826 LF 13			08/95 > 06/96		S 4378 NR		
some / alcuni	D 0826 LF 13			08/95 > 06/96	S 3292 R	S 1378 NR	S 7187 A	
18.262 F	D 0826 LF 13			08/95 > 06/96	S 3292 R	S 1378 NR	S 2650 A	
2nd passage / 2.passaggio	D 0826 LF 13			08/95 > 06/96		S 4378 NR		
some / alcuni	D 0826 LF 13			08/95 > 06/96	S 3292 R	S 1378 NR	S 7187 A	
18.272	D 0826 LF 04			10/92 > 06/96	S 3292 R	S 1378 NR	S 2650 A	
2nd passage / 2.passaggio	D 0826 LF 04			10/92 > 06/96		S 4378 NR		
some / alcuni	D 0826 LF 04			10/92 > 06/96	S 3292 R	S 1378 NR	S 7187 A	
24.192	D 0826 LF 01/05/07			07/89 > 06/96	S 3292 R	S 1378 NR	S 2650 A	
2nd passage / 2.passaggio	D 0826 LF 01/05/07			07/89 > 06/96		S 4378 NR		
24.192 FNL	D 0826 LF 01/05/07			07/89 > 06/96	S 3292 R	S 1378 NR	S 2650 A	
2nd passage / 2.passaggio	D 0826 LF 01/05/07			07/89 > 06/96		S 4378 NR		
24.222	D 0826 LF 11			05/94 > 06/96	S 3292 R	S 1378 NR	S 2650 A	
2nd passage / 2.passaggio	D 0826 LF 11			05/94 > 06/96		S 4378 NR		
24.222 FNL	D 0826 LF 11			05/94 > 06/96	S 3292 R	S 1378 NR	S 2650 A	
2nd passage / 2.passaggio	D 0826 LF 11			05/94 > 06/96		S 4378 NR		
24.232	D 0826 LF 02/06/08			07/89 > 06/96	S 3292 R	S 1378 NR	S 2650 A	
2nd passage / 2.passaggio	D 0826 LF 02/06/08			07/89 > 06/96		S 4378 NR		
24.232	D 0826 LF 217/Silent			05/90 > 06/96	S 3292 R	S 1378 NR	S 2650 A	
2nd passage / 2.passaggio	D 0826 LF 217/Silent			05/90 > 06/96	S 3292 R	S 4378 NR	S 2650 A	
24.232 FNL	D 0826 LF 217/Silent			05/90 > 06/96	S 3292 R	S 1378 NR	S 2650 A	
2nd passage / 2.passaggio	D 0826 LF 217/Silent			05/90 > 06/96		S 4378 NR		
24.262	D 2826 LF 13			08/95 > 06/96	S 7260 PO	S 1378 NR		
2nd passage / 2.passaggio	D 2826 LF 13			08/95 > 06/96		S 4378 NR		
some / alcuni	D 2826 LF 13			08/95 > 06/96	S 7260 PO	S 1378 NR	S 7187 A	
24.262 FNL	D 2826 LF 13			08/95 > 06/96	S 7260 PO	S 1378 NR		
2nd passage / 2.passaggio	D 2826 LF 13			08/95 > 06/96		S 4378 NR		
some / alcuni	D 2826 LF 13			08/95 > 06/96	S 7260 PO	S 1378 NR	S 7187 A	
28.272 F	D 0826 LF 04			10/92 > 06/96	S 3292 R	S 1378 NR	S 2650 A	
2nd passage / 2.passaggio	D 0826 LF 04			10/92 > 06/96		S 4378 NR		
some / alcuni	D 0826 LF 04			10/92 > 06/96	S 3292 R	S 1378 NR	S 7187 A	
ME Serie								
ME 220 B	D 0836			08/00 > 04/07	S 3292 R	S 4378 NR	S 8502 A	S 3053 C
dryer filter / filtro essiccatore	D 0836			08/00 > 04/07				S 7259 A
power steering / servosterzo	D 0836			08/00 > 04/07				S 3081 PO
ME 250 B	D 0836			08/00 > 04/07	S 3292 R	S 4378 NR	S 8502 A	S 3053 C
dryer filter / filtro essiccatore	D 0836			08/00 > 04/07				S 7259 A
power steering / servosterzo	D 0836			08/00 > 04/07				S 3081 PO
ME 280 B	D 0836			08/00 > 04/07	S 3292 R	S 4378 NR	S 8502 A	S 3053 C
dryer filter / filtro essiccatore	D 0836			08/00 > 04/07				S 7259 A
power steering / servosterzo	D 0836			08/00 > 04/07				S 3081 PO
TGA Serie								
TG280A	D0836LF41	206 280		10/02 >	S 5095 PE	S 6016 NE	S 7619 A	S 3165 C
with air-conditioner / con climatizzatore	D0836LF41	206 280		10/02 >	S 5095 PE	S 6016 NE	S 7619 A	S 4177 CA
dryer filter WABCO / filtro essiccatore WABCO	D0836LF41	206 280		10/02 >				S 7259 A
inner / interno	D0836LF41	206 280		10/02 >			S 7616 A	
prefilter with fuel oil heater / prefiltro con riscaldatore nafta	D0836LF41	206 280		10/02 >		S 6059 NE		

**KW HP****...MAN - trucks/autocarri**

prefilter without fuel oil heater / prefiltrò senza riscaldatore nafta	D0836LF41	206	280	10/02	>		S 6062 NE		
power steering / servosterzo	D0836LF41	206	280	10/02	>				S 3081 PO
TG310A	D2066LF04	228	310	02/04	>	S 5046 PE	S 6011 NE	S 7619 A	S 3165 C
with air-conditioner / con climatizzatore	D2066LF04	228	310	02/04	>	S 5046 PE	S 6011 NE	S 7619 A	S 4177 CA
dryer filter WABCO / filtro essiccatore WABCO	D2066LF04	228	310	02/04	>				S 7259 A
inner / interno	D2066LF04	228	310	02/04	>			S 7616 A	
prefilter with fuel oil heater / prefiltrò con riscaldatore nafta	D2066LF04	228	310	02/04	>		S 6059 NE		
prefilter without fuel oil heater / prefiltrò senza riscaldatore nafta	D2066LF04	228	310	02/04	>		S 6062 NE		
power steering / servosterzo	D2066LF04	228	310	02/04	>				S 3081 PO
TG310A	D2866LF23/26/36	228	310	05/00	> 02/04	S 5016 PE	S 6004 NE	S 7619 A	S 3165 C
with air-conditioner / con climatizzatore	D2866LF23/26/36	228	310	05/00	> 02/04	S 5016 PE	S 6004 NE	S 7619 A	S 4177 CA
dryer filter WABCO / filtro essiccatore WABCO	D2866LF23/26/36	228	310	05/00	> 02/04				S 7259 A
inner / interno	D2866LF23/26/36	228	310	05/00	> 02/04			S 7616 A	
prefilter with fuel oil heater / prefiltrò con riscaldatore nafta	D2866LF23/26/36	228	310	05/00	> 02/04		S 6059 NE		
prefilter without fuel oil heater / prefiltrò senza riscaldatore nafta	D2866LF23/26/36	228	310	05/00	> 02/04		S 6062 NE		
power steering / servosterzo	D2866LF23/26/36	228	310	05/00	> 02/04				S 3081 PO
TG330A	D0836LF44	240	326	10/02	>	S 5095 PE	S 6016 NE	S 7619 A	S 3165 C
with air-conditioner / con climatizzatore	D0836LF44	240	326	10/02	>	S 5095 PE	S 6016 NE	S 7619 A	S 4177 CA
dryer filter WABCO / filtro essiccatore WABCO	D0836LF44	240	326	10/02	>				S 7259 A
inner / interno	D0836LF44	240	326	10/02	>			S 7616 A	
prefilter with fuel oil heater / prefiltrò con riscaldatore nafta	D0836LF44	240	326	10/02	>		S 6059 NE		
prefilter without fuel oil heater / prefiltrò senza riscaldatore nafta	D0836LF44	240	326	10/02	>		S 6062 NE		
power steering / servosterzo	D0836LF44	240	326	10/02	>				S 3081 PO
TG350A	D2066LF03/13	257	350	02/04	>	S 5046 PE	S 6011 NE	S 7619 A	S 3165 C
with air-conditioner / con climatizzatore	D2066LF03/13	257	350	02/04	>	S 5046 PE	S 6011 NE	S 7619 A	S 4177 CA
dryer filter WABCO / filtro essiccatore WABCO	D2066LF03/13	257	350	02/04	>				S 7259 A
inner / interno	D2066LF03/13	257	350	02/04	>			S 7616 A	
prefilter with fuel oil heater / prefiltrò con riscaldatore nafta	D2066LF03/13	257	350	02/04	>		S 6059 NE		
prefilter without fuel oil heater / prefiltrò senza riscaldatore nafta	D2066LF03/13	257	350	02/04	>		S 6062 NE		
power steering / servosterzo	D2066LF03/13	257	350	02/04	>				S 3081 PO
TG360A	D2066LF33	265	360	09/06	>	S 5046 PE	S 6011 NE	S 7619 A	S 3165 C
with air-conditioner / con climatizzatore	D2066LF33	265	360	09/06	>	S 5046 PE	S 6011 NE	S 7619 A	S 4177 CA
dryer filter WABCO / filtro essiccatore WABCO	D2066LF33	265	360	09/06	>				S 7259 A
inner / interno	D2066LF33	265	360	09/06	>			S 7616 A	
prefilter with fuel oil heater / prefiltrò con riscaldatore nafta	D2066LF33	265	360	09/06	>		S 6059 NE		
prefilter without fuel oil heater / prefiltrò senza riscaldatore nafta	D2066LF33	265	360	09/06	>		S 6062 NE		
power steering / servosterzo	D2066LF33	265	360	09/06	>				S 3081 PO
TG360A	D2866LF24/27/37	265	360	05/00	>	S 5016 PE	S 6004 NE	S 7619 A	S 3165 C
with air-conditioner / con climatizzatore	D2866LF24/27/37	265	360	05/00	>	S 5016 PE	S 6004 NE	S 7619 A	S 4177 CA
dryer filter WABCO / filtro essiccatore WABCO	D2866LF24/27/37	265	360	05/00	>				S 7259 A
inner / interno	D2866LF24/27/37	265	360	05/00	>			S 7616 A	
prefilter with fuel oil heater / prefiltrò con riscaldatore nafta	D2866LF24/27/37	265	360	05/00	>		S 6059 NE		
prefilter without fuel oil heater / prefiltrò senza riscaldatore nafta	D2866LF24/27/37	265	360	05/00	>		S 6062 NE		
power steering / servosterzo	D2866LF24/27/37	265	360	05/00	>				S 3081 PO
TG390A	D2066LF02	287	390	02/04	>	S 5046 PE	S 6011 NE	S 7619 A	S 3165 C
with air-conditioner / con climatizzatore	D2066LF02	287	390	02/04	>	S 5046 PE	S 6011 NE	S 7619 A	S 4177 CA
dryer filter WABCO / filtro essiccatore WABCO	D2066LF02	287	390	02/04	>				S 7259 A
inner / interno	D2066LF02	287	390	02/04	>			S 7616 A	
prefilter with fuel oil heater / prefiltrò con riscaldatore nafta	D2066LF02	287	390	02/04	>		S 6059 NE		
prefilter without fuel oil heater / prefiltrò senza riscaldatore nafta	D2066LF02	287	390	02/04	>		S 6062 NE		
power steering / servosterzo	D2066LF02	287	390	02/04	>				S 3081 PO
TG400A	D2066LF24/32 Euro4/5	294	400	05/06	>	S 5046 PE	S 6011 NE	S 7619 A	S 3165 C
with air-conditioner / con climatizzatore	D2066LF24/32 Euro4/5	294	400	05/06	>	S 5046 PE	S 6011 NE	S 7619 A	S 4177 CA
inner / interno	D2066LF24/32 Euro4/5	294	400	05/06	>			S 7616 A	
prefilter with fuel oil heater / prefiltrò con riscaldatore nafta	D2066LF24/32 Euro4/5	294	400	05/06	>		S 6059 NE		
prefilter without fuel oil heater / prefiltrò senza riscaldatore nafta	D2066LF24/32 Euro4/5	294	400	05/06	>		S 6062 NE		
power steering / servosterzo	D2066LF24/32 Euro4/5	294	400	05/06	>				S 3081 PO
TG410A	D2866LF25	301	410	04/00	>	S 5016 PE	S 6004 NE	S 7619 A	S 3165 C
with air-conditioner / con climatizzatore	D2866LF25	301	410	04/00	>	S 5016 PE	S 6004 NE	S 7619 A	S 4177 CA
dryer filter WABCO / filtro essiccatore WABCO	D2866LF25	301	410	04/00	>				S 7259 A
inner / interno	D2866LF25	301	410	04/00	>			S 7616 A	
prefilter with fuel oil heater / prefiltrò con riscaldatore nafta	D2866LF25	301	410	04/00	>		S 6059 NE		
prefilter without fuel oil heater / prefiltrò senza riscaldatore nafta	D2866LF25	301	410	04/00	>		S 6062 NE		
power steering / servosterzo	D2866LF25	301	410	04/00	>				S 3081 PO
TG410A	D2866LF28	301	410	04/00	>	S 5016 PE	S 6004 NE	S 7619 A	S 3165 C
with air-conditioner / con climatizzatore	D2866LF28	301	410	04/00	>	S 5016 PE	S 6004 NE	S 7619 A	S 4177 CA
dryer filter WABCO / filtro essiccatore WABCO	D2866LF28	301	410	04/00	>				S 7259 A

M

**KW HP****...MAN - trucks/autocarri**

inner / interno	D2866LF28	301	410	04/00	>			S 7616 A	
prefilter with fuel oil heater / prefiltro con riscaldatore nafta	D2866LF28	301	410	04/00	>		S 6059 NE		
prefilter without fuel oil heater / prefiltro senza riscaldatore nafta	D2866LF28	301	410	04/00	>		S 6062 NE		
power steering / servosterzo	D2866LF28	301	410	04/00	>				S 3081 PO
TG410A	D2866LF32	301	410	04/00	>	S 5016 PE	S 6004 NE	S 7619 A	S 3165 C
with air-conditioner / con climatizzatore	D2866LF32	301	410	04/00	>	S 5016 PE	S 6004 NE	S 7619 A	S 4177 CA
dryer filter WABCO / filtro essiccatore WABCO	D2866LF32	301	410	04/00	>				S 7259 A
inner / interno	D2866LF32	301	410	04/00	>			S 7616 A	
prefilter with fuel oil heater / prefiltro con riscaldatore nafta	D2866LF32	301	410	04/00	>		S 6059 NE		
prefilter without fuel oil heater / prefiltro senza riscaldatore nafta	D2866LF32	301	410	04/00	>		S 6062 NE		
power steering / servosterzo	D2866LF32	301	410	04/00	>				S 3081 PO
TG410A	D2866LF33	301	410	04/00	>	S 5016 PE	S 6004 NE	S 7619 A	S 3165 C
with air-conditioner / con climatizzatore	D2866LF33	301	410	04/00	>	S 5016 PE	S 6004 NE	S 7619 A	S 4177 CA
dryer filter WABCO / filtro essiccatore WABCO	D2866LF33	301	410	04/00	>				S 7259 A
inner / interno	D2866LF33	301	410	04/00	>			S 7616 A	
prefilter with fuel oil heater / prefiltro con riscaldatore nafta	D2866LF33	301	410	04/00	>		S 6059 NE		
prefilter without fuel oil heater / prefiltro senza riscaldatore nafta	D2866LF33	301	410	04/00	>		S 6062 NE		
power steering / servosterzo	D2866LF33	301	410	04/00	>				S 3081 PO
TG430A	D2066LF01/11	316	430	02/04	>	S 5046 PE	S 6011 NE	S 7619 A	S 3165 C
with air-conditioner / con climatizzatore	D2066LF01/11	316	430	02/04	>	S 5046 PE	S 6011 NE	S 7619 A	S 4177 CA
dryer filter WABCO / filtro essiccatore WABCO	D2066LF01/11	316	430	02/04	>				S 7259 A
inner / interno	D2066LF01/11	316	430	02/04	>			S 7616 A	
prefilter with fuel oil heater / prefiltro con riscaldatore nafta	D2066LF01/11	316	430	02/04	>		S 6059 NE		
prefilter without fuel oil heater / prefiltro senza riscaldatore nafta	D2066LF01/11	316	430	02/04	>		S 6062 NE		
power steering / servosterzo	D2066LF01/11	316	430	02/04	>				S 3081 PO
TG440A	D2066LF23/31 Euro4/5	321	436	05/06	>	S 5046 PE	S 6011 NE	S 7619 A	S 3165 C
with air-conditioner / con climatizzatore	D2066LF23/31 Euro4/5	321	436	05/06	>	S 5046 PE	S 6011 NE	S 7619 A	S 4177 CA
inner / interno	D2066LF23/31 Euro4/5	321	436	05/06	>			S 7616 A	
prefilter with fuel oil heater / prefiltro con riscaldatore nafta	D2066LF23/31 Euro4/5	321	436	05/06	>		S 6059 NE		
prefilter without fuel oil heater / prefiltro senza riscaldatore nafta	D2066LF23/31 Euro4/5	321	436	05/06	>		S 6062 NE		
power steering / servosterzo	D2066LF23/31 Euro4/5	321	436	05/06	>				S 3081 PO
TG460A	D2876LF02	338	460	04/00	>	S 5016 PE	S 6004 NE	S 7619 A	S 3165 C
with air-conditioner / con climatizzatore	D2876LF02	338	460	04/00	>	S 5016 PE	S 6004 NE	S 7619 A	S 4177 CA
dryer filter WABCO / filtro essiccatore WABCO	D2876LF02	338	460	04/00	>				S 7259 A
inner / interno	D2876LF02	338	460	04/00	>			S 7616 A	
prefilter with fuel oil heater / prefiltro con riscaldatore nafta	D2876LF02	338	460	04/00	>		S 6059 NE		
prefilter without fuel oil heater / prefiltro senza riscaldatore nafta	D2876LF02	338	460	04/00	>		S 6062 NE		
power steering / servosterzo	D2876LF02	338	460	04/00	>				S 3081 PO
TG460A	D2876LF03/07	338	460	04/00	>	S 5016 PE	S 6004 NE	S 7619 A	S 3165 C
with air-conditioner / con climatizzatore	D2876LF03/07	338	460	04/00	>	S 5016 PE	S 6004 NE	S 7619 A	S 4177 CA
dryer filter WABCO / filtro essiccatore WABCO	D2876LF03/07	338	460	04/00	>				S 7259 A
inner / interno	D2876LF03/07	338	460	04/00	>			S 7616 A	
prefilter with fuel oil heater / prefiltro con riscaldatore nafta	D2876LF03/07	338	460	04/00	>		S 6059 NE		
prefilter without fuel oil heater / prefiltro senza riscaldatore nafta	D2876LF03/07	338	460	04/00	>		S 6062 NE		
power steering / servosterzo	D2876LF03/07	338	460	04/00	>				S 3081 PO
TG460A	D2876LF04	338	460	04/00	>	S 5016 PE	S 6004 NE	S 7619 A	S 3165 C
with air-conditioner / con climatizzatore	D2876LF04	338	460	04/00	>	S 5016 PE	S 6004 NE	S 7619 A	S 4177 CA
dryer filter WABCO / filtro essiccatore WABCO	D2876LF04	338	460	04/00	>				S 7259 A
inner / interno	D2876LF04	338	460	04/00	>			S 7616 A	
prefilter with fuel oil heater / prefiltro con riscaldatore nafta	D2876LF04	338	460	04/00	>		S 6059 NE		
prefilter without fuel oil heater / prefiltro senza riscaldatore nafta	D2876LF04	338	460	04/00	>		S 6062 NE		
power steering / servosterzo	D2876LF04	338	460	04/00	>				S 3081 PO
TG480A	D2676LF01/12 Euro4/5	353	480	05/06	>	S 5046 PE	S 6011 NE	S 7619 A	S 3165 C
with air-conditioner / con climatizzatore	D2676LF01/12 Euro4/5	353	480	05/06	>	S 5046 PE	S 6011 NE	S 7619 A	S 4177 CA
inner / interno	D2676LF01/12 Euro4/5	353	480	05/06	>			S 7616 A	
prefilter with fuel oil heater / prefiltro con riscaldatore nafta	D2676LF01/12 Euro4/5	353	480	05/06	>		S 6059 NE		
prefilter without fuel oil heater / prefiltro senza riscaldatore nafta	D2676LF01/12 Euro4/5	353	480	05/06	>		S 6062 NE		
power steering / servosterzo	D2676LF01/12 Euro4/5	353	480	05/06	>				S 3081 PO
TG480A	D2876LF12/25	353	480	09/02	>	S 5016 PE	S 6016 NE	S 7619 A	S 3165 C
with air-conditioner / con climatizzatore	D2876LF12/25	353	480	09/02	>	S 5016 PE	S 6016 NE	S 7619 A	S 4177 CA
dryer filter WABCO / filtro essiccatore WABCO	D2876LF12/25	353	480	09/02	>				S 7259 A
inner / interno	D2876LF12/25	353	480	09/02	>			S 7616 A	
prefilter with fuel oil heater / prefiltro con riscaldatore nafta	D2876LF12/25	353	480	09/02	>		S 6059 NE		
prefilter without fuel oil heater / prefiltro senza riscaldatore nafta	D2876LF12/25	353	480	09/02	>		S 6062 NE		
power steering / servosterzo	D2876LF12/25	353	480	09/02	>				S 3081 PO
TG510A	D2876LF05	375	510	08/00	>	S 5016 PE	S 6004 NE	S 7619 A	S 3165 C
with air-conditioner / con climatizzatore	D2876LF05	375	510	08/00	>	S 5016 PE	S 6004 NE	S 7619 A	S 4177 CA



...MAN - trucks/autocarri

dryer filter WABCO / filtro essiccatore WABCO	D2876LF05	375	510	08/00	>				S 7259 A
inner / interno	D2876LF05	375	510	08/00	>			S 7616 A	
prefilter with fuel oil heater / prefiltro con riscaldatore nafta	D2876LF05	375	510	08/00	>		S 6059 NE		
prefilter without fuel oil heater / prefiltro senza riscaldatore nafta	D2876LF05	375	510	08/00	>		S 6062 NE		
power steering / servosterzo	D2876LF05	375	510	08/00	>				S 3081 PO
TG530A	D2876LF13	390	530	09/02	>	S 5016 PE	S 6016 NE	S 7619 A	S 3165 C
with air-conditioner / con climatizzatore	D2876LF13	390	530	09/02	>	S 5016 PE	S 6016 NE	S 7619 A	S 4177 CA
dryer filter WABCO / filtro essiccatore WABCO	D2876LF13	390	530	09/02	>				S 7259 A
inner / interno	D2876LF13	390	530	09/02	>			S 7616 A	
prefilter with fuel oil heater / prefiltro con riscaldatore nafta	D2876LF13	390	530	09/02	>		S 6059 NE		
prefilter without fuel oil heater / prefiltro senza riscaldatore nafta	D2876LF13	390	530	09/02	>		S 6062 NE		
power steering / servosterzo	D2876LF13	390	530	09/02	>				S 3081 PO
TG540A	D2676LF11 Euro5	397	540	07/06	>	S 5046 PE	S 6011 NE	S 7619 A	S 3165 C
with air-conditioner / con climatizzatore	D2676LF11 Euro5	397	540	07/06	>	S 5046 PE	S 6011 NE	S 7619 A	S 4177 CA
inner / interno	D2676LF11 Euro5	397	540	07/06	>			S 7616 A	
prefilter with fuel oil heater / prefiltro con riscaldatore nafta	D2676LF11 Euro5	397	540	07/06	>		S 6059 NE		
prefilter without fuel oil heater / prefiltro senza riscaldatore nafta	D2676LF11 Euro5	397	540	07/06	>		S 6062 NE		
power steering / servosterzo	D2676LF11 Euro5	397	540	07/06	>				S 3081 PO
TG660A	D2840LF25	485	660	09/02	>		S 6004 NE	S 7619 A	S 3165 C
with air-conditioner / con climatizzatore	D2840LF25	485	660	09/02	>		S 6004 NE	S 7619 A	S 4177 CA
dryer filter WABCO / filtro essiccatore WABCO	D2840LF25	485	660	09/02	>				S 7259 A
inner / interno	D2840LF25	485	660	09/02	>			S 7616 A	
2 filters / N.2 filtri	D2840LF25	485	660	09/02	>	S 5005 PE			
2 filters some / N.2 filtri alcuni	D2840LF25	485	660	09/02	>			S 7573 A	
prefilter with fuel oil heater / prefiltro con riscaldatore nafta	D2840LF25	485	660	09/02	>		S 6059 NE		
prefilter without fuel oil heater / prefiltro senza riscaldatore nafta	D2840LF25	485	660	09/02	>		S 6062 NE		
power steering / servosterzo	D2840LF25	485	660	09/02	>				S 3081 PO
TGL Serie									
TGL 10.180	D0834LFL41/51	132	180	06/05	>	S 5095 PE	S 6011 NE		S 3165 C
with air-conditioner / con climatizzatore	D0834LFL41/51	132	180	06/05	>				S 4177 CA
assembly KNECHT-MAHLE LPO7210 / montaggio KNECHT-MAHLE LPO7210	D0834LFL41/51	132	180	06/05	>			S 7B01 A	
assembly MANN+HUMMEL NLG Piclon / montaggio MANN+HUMMEL NLG Piclon	D0834LFL41/51	132	180	06/05	>			S 7F16 A	
assembly MANN+HUMMEL NLG Pico / montaggio MANN+HUMMEL NLG Pico	D0834LFL41/51	132	180	06/05	>			S 7F17 A	
prefilter with fuel oil heater / prefiltro con riscaldatore nafta	D0834LFL41/51	132	180	06/05	>		S 6064 NE		
prefilter without fuel oil heater / prefiltro senza riscaldatore nafta	D0834LFL41/51	132	180	06/05	>		S 6063 NE		
power steering / servosterzo	D0834LFL41/51	132	180	06/05	>				S 3081 PO
TGL 10.190	D0834LFL	140	180	09/17	>	S 5095 PE	S 6011 NE		S 3165 C
with air-conditioner / con climatizzatore	D0834LFL	140	180	09/17	>				S 4177 CA
dryer filter / filtro essiccatore	D0834LFL	140	180	09/17	>				S 7A66 A
assembly KNECHT-MAHLE LSA / montaggio KNECHT-MAHLE LSA	D0834LFL	140	180	09/17	>			S 3B55 A	
assembly MANN+HUMMEL NLG Pico / montaggio MANN+HUMMEL NLG Pico	D0834LFL	140	180	09/17	>			S 7F25 A	
prefilter UFI FILTERS / prefiltro UFI FILTERS	D0834LFL	140	180	09/17	>		S 4035 NR		
power steering / servosterzo	D0834LFL	140	180	09/17	>				S 3081 PO
TGL 10.210	D0834LFL42/52	151	206	06/05	>	S 5095 PE	S 6011 NE		S 3165 C
with air-conditioner / con climatizzatore	D0834LFL42/52	151	206	06/05	>				S 4177 CA
assembly KNECHT-MAHLE LPO7210 / montaggio KNECHT-MAHLE LPO7210	D0834LFL42/52	151	206	06/05	>			S 7B01 A	
assembly MANN+HUMMEL NLG Piclon / montaggio MANN+HUMMEL NLG Piclon	D0834LFL42/52	151	206	06/05	>			S 7F16 A	
assembly MANN+HUMMEL NLG Pico / montaggio MANN+HUMMEL NLG Pico	D0834LFL42/52	151	206	06/05	>			S 7F17 A	
prefilter with fuel oil heater / prefiltro con riscaldatore nafta	D0834LFL42/52	151	206	06/05	>		S 6064 NE		
prefilter without fuel oil heater / prefiltro senza riscaldatore nafta	D0834LFL42/52	151	206	06/05	>				S 4177 CA
power steering / servosterzo	D0834LFL42/52	151	206	06/05	>				S 3081 PO
TGL 10.220	D0834 Euro5	162	220	09/08	>	S 5095 PE	S 6011 NE		S 3165 C
with air-conditioner / con climatizzatore	D0834 Euro5	162	220	09/08	>				S 4177 CA
assembly KNECHT-MAHLE LPO7210 / montaggio KNECHT-MAHLE LPO7210	D0834 Euro5	162	220	09/08	>			S 7B01 A	
assembly MANN+HUMMEL NLG Piclon / montaggio MANN+HUMMEL NLG Piclon	D0834 Euro5	162	220	09/08	>			S 7F16 A	
assembly MANN+HUMMEL NLG Pico / montaggio MANN+HUMMEL NLG Pico	D0834 Euro5	162	220	09/08	>			S 7F17 A	
power steering / servosterzo	D0834 Euro5	162	220	09/08	>				S 3081 PO
TGL 10.240	D0836LFL40/50	176	240	06/05	>	S 5095 PE	S 6011 NE		S 3165 C
with air-conditioner / con climatizzatore	D0836LFL40/50	176	240	06/05	>				S 4177 CA
assembly KNECHT-MAHLE LPO7210 / montaggio KNECHT-MAHLE LPO7210	D0836LFL40/50	176	240	06/05	>			S 7B01 A	
assembly MANN+HUMMEL NLG Pico / montaggio MANN+HUMMEL NLG Pico	D0836LFL40/50	176	240	06/05	>			S 7F17 A	
power steering / servosterzo	D0836LFL40/50	176	240	06/05	>				S 3081 PO
TGL 10.250	D0836LFL60/63	184	250	05/09	>	S 5095 PE	S 6011 NE		S 3165 C
with air-conditioner / con climatizzatore	D0836LFL60/63	184	250	05/09	>	S 5095 PE	S 6011 NE		S 4177 CA
power steering / servosterzo	D0836LFL60/63	184	250	05/09	>				S 3081 PO
TGL 12.180	D0834LFL41/51	132	180	06/05	>	S 5095 PE	S 6011 NE		S 3165 C
with air-conditioner / con climatizzatore	D0834LFL41/51	132	180	06/05	>	S 5095 PE	S 6011 NE		S 4177 CA

M



kW HP



...MAN - trucks/autocarri

M

power steering / servosterzo	D0834LFL41/51	132	180	06/05	>				S 3081 PO
TGL 12.210	D0834LFL42/52	151	206	06/05	>	S 5095 PE	S 6011 NE		S 3165 C
with air-conditioner / con climatizzatore	D0834LFL42/52	151	206	06/05	>	S 5095 PE	S 6011 NE		S 4177 CA
power steering / servosterzo	D0834LFL42/52	151	206	06/05	>				S 3081 PO
TGL 12.220	D0834 Euro5	162	220	09/08	>	S 5095 PE	S 6011 NE		S 3165 C
with air-conditioner / con climatizzatore	D0834 Euro5	162	220	09/08	>	S 5095 PE	S 6011 NE		S 4177 CA
power steering / servosterzo	D0834 Euro5	162	220	09/08	>				S 3081 PO
TGL 12.240	D0836LFL40/50	176	240	06/05	>	S 5095 PE	S 6011 NE		S 3165 C
with air-conditioner / con climatizzatore	D0836LFL40/50	176	240	06/05	>	S 5095 PE	S 6011 NE		S 4177 CA
power steering / servosterzo	D0836LFL40/50	176	240	06/05	>				S 3081 PO
TGL 12.250	D0836 Euro5	184	250	09/08	>	S 5095 PE	S 6011 NE		S 3165 C
with air-conditioner / con climatizzatore	D0836 Euro5	184	250	09/08	>	S 5095 PE	S 6011 NE		S 4177 CA
power steering / servosterzo	D0836 Euro5	184	250	09/08	>				S 3081 PO
TGL 7.150	D0834LFL40/50	110	150	06/05	>	S 5095 PE	S 6011 NE		S 3165 C
with air-conditioner / con climatizzatore	D0834LFL40/50	110	150	06/05	>			S 7B01 A	S 4177 CA
assembly KNECHT-MAHLE LPO7210 / montaggio KNECHT-MAHLE LPO7210	D0834LFL40/50	110	150	06/05	>			S 7F16 A	
assembly MANN+HUMMEL NLG Piclon / montaggio MANN+HUMMEL NLG Piclon	D0834LFL40/50	110	150	06/05	>			S 7F17 A	
assembly MANN+HUMMEL NLG Pico / montaggio MANN+HUMMEL NLG Pico	D0834LFL40/50	110	150	06/05	>				
prefilter with fuel oil heater / prefiltro con riscaldatore nafta	D0834LFL40/50	110	150	06/05	>		S 6064 NE		
prefilter without fuel oil heater / prefiltro senza riscaldatore nafta	D0834LFL40/50	110	150	06/05	>		S 6063 NE		
power steering / servosterzo	D0834LFL40/50	110	150	06/05	>				S 3081 PO
TGL 7.180	D0834LFL41/51	132	180	06/05	>	S 5095 PE	S 6011 NE		S 3165 C
with air-conditioner / con climatizzatore	D0834LFL41/51	132	180	06/05	>	S 5095 PE	S 6011 NE		S 4177 CA
power steering / servosterzo	D0834LFL41/51	132	180	06/05	>				S 3081 PO
TGL 7.220	D0834LFL62/65	162	220	09/08	>	S 5095 PE	S 6011 NE		S 3165 C
with air-conditioner / con climatizzatore	D0834LFL62/65	162	220	09/08	>	S 5095 PE	S 6011 NE		S 4177 CA
power steering / servosterzo	D0834LFL62/65	162	220	09/08	>				S 3081 PO
TGL 7.250	D0836LFL60/63	184	250	09/08	>	S 5095 PE	S 6011 NE		S 3165 C
with air-conditioner / con climatizzatore	D0836LFL60/63	184	250	09/08	>	S 5095 PE	S 6011 NE		S 4177 CA
power steering / servosterzo	D0836LFL60/63	184	250	09/08	>				S 3081 PO
TGL 8.150	D0834LFL40/50	110	150	10/06	>	S 5095 PE	S 6011 NE		S 3165 C
with air-conditioner / con climatizzatore	D0834LFL40/50	110	150	10/06	>	S 5095 PE	S 6011 NE		S 4177 CA
power steering / servosterzo	D0834LFL40/50	110	150	10/06	>				S 3081 PO
TGL 8.180	D0834LFL41/51	132	180	06/05	>	S 5095 PE	S 6011 NE		S 3165 C
with air-conditioner / con climatizzatore	D0834LFL41/51	132	180	06/05	>	S 5095 PE	S 6011 NE		S 4177 CA
power steering / servosterzo	D0834LFL41/51	132	180	06/05	>				S 3081 PO
TGL 8.210	D0834LFL42/52	151	206	06/05	>	S 5095 PE	S 6011 NE		S 3165 C
with air-conditioner / con climatizzatore	D0834LFL42/52	151	206	06/05	>	S 5095 PE	S 6011 NE		S 4177 CA
power steering / servosterzo	D0834LFL42/52	151	206	06/05	>				S 3081 PO
TGL 8.220	D0834 Euro5	162	220	09/08	>	S 5095 PE	S 6011 NE		S 3165 C
with air-conditioner / con climatizzatore	D0834 Euro5	162	220	09/08	>	S 5095 PE	S 6011 NE		S 4177 CA
power steering / servosterzo	D0834 Euro5	162	220	09/08	>				S 3081 PO
TGL 8.240	D0836LFL40/50	176	240	06/05	>	S 5095 PE	S 6011 NE		S 3165 C
with air-conditioner / con climatizzatore	D0836LFL40/50	176	240	06/05	>	S 5095 PE	S 6011 NE		S 4177 CA
power steering / servosterzo	D0836LFL40/50	176	240	06/05	>				S 3081 PO
TGL 8.250	D0836 Euro5	184	250	09/08	>	S 5095 PE	S 6011 NE		S 3165 C
with air-conditioner / con climatizzatore	D0836 Euro5	184	250	09/08	>	S 5095 PE	S 6011 NE		S 4177 CA
power steering / servosterzo	D0836 Euro5	184	250	09/08	>				S 3081 PO
TGM Serie									
TGM 12.240	D0836LFL50	176	240	09/06	>	S 5095 PE	S 6011 NE		S 3165 C
with air-conditioner / con climatizzatore	D0836LFL50	176	240	09/06	>	S 5095 PE	S 6011 NE		S 4177 CA
power steering / servosterzo	D0836LFL50	176	240	09/06	>				S 3081 PO
TGM 12.280	D0836LFL51	206	280	09/06	>	S 5095 PE	S 6011 NE		S 3165 C
with air-conditioner / con climatizzatore	D0836LFL51	206	280	09/06	>	S 5095 PE	S 6011 NE		S 4177 CA
power steering / servosterzo	D0836LFL51	206	280	09/06	>				S 3081 PO
TGM 12.290	D0836 Euro5	213	290	09/08	>	S 5095 PE	S 6011 NE		S 3165 C
with air-conditioner / con climatizzatore	D0836 Euro5	213	290	09/08	>	S 5095 PE	S 6011 NE		S 4177 CA
power steering / servosterzo	D0836 Euro5	213	290	09/08	>				S 3081 PO
TGM 13.240	D0836LFL50	176	240	09/06	>	S 5095 PE	S 6011 NE		S 3165 C
with air-conditioner / con climatizzatore	D0836LFL50	176	240	09/06	>	S 5095 PE	S 6011 NE		S 4177 CA
power steering / servosterzo	D0836LFL50	176	240	09/06	>				S 3081 PO
TGM 13.250	D0836 Euro5	184	250	09/08	>	S 5095 PE	S 6011 NE		S 3165 C
with air-conditioner / con climatizzatore	D0836 Euro5	184	250	09/08	>	S 5095 PE	S 6011 NE		S 4177 CA
power steering / servosterzo	D0836 Euro5	184	250	09/08	>				S 3081 PO
TGM 13.280	D0836LFL51	206	280	09/06	>	S 5095 PE	S 6011 NE		S 3165 C
with air-conditioner / con climatizzatore	D0836LFL51	206	280	09/06	>	S 5095 PE	S 6011 NE		S 4177 CA
power steering / servosterzo	D0836LFL51	206	280	09/06	>				S 3081 PO

**KW HP****...MAN - trucks/autocarri**

TGM 13.290	D0836 Euro5	213	290	09/08	>	S 5095 PE	S 6011 NE		S 3165 C
with air-conditioner / con climatizzatore	D0836 Euro5	213	290	09/08	>	S 5095 PE	S 6011 NE		S 4177 CA
power steering / servosterzo	D0836 Euro5	213	290	09/08	>				S 3081 PO
TGM 15.240	D0836LFL50	176	240	09/06	>	S 5095 PE	S 6011 NE		S 3165 C
with air-conditioner / con climatizzatore	D0836LFL50	176	240	09/06	>	S 5095 PE	S 6011 NE		S 4177 CA
power steering / servosterzo	D0836LFL50	176	240	09/06	>				S 3081 PO
TGM 15.250	D0836 Euro5	184	250	09/08	>	S 5095 PE	S 6011 NE		S 3165 C
with air-conditioner / con climatizzatore	D0836 Euro5	184	250	09/08	>	S 5095 PE	S 6011 NE		S 4177 CA
power steering / servosterzo	D0836 Euro5	184	250	09/08	>				S 3081 PO
TGM 15.280	D0836LFL51	206	280	09/06	>	S 5095 PE	S 6011 NE		S 3165 C
with air-conditioner / con climatizzatore	D0836LFL51	206	280	09/06	>	S 5095 PE	S 6011 NE		S 4177 CA
power steering / servosterzo	D0836LFL51	206	280	09/06	>				S 3081 PO
TGM 15.290	D0836 Euro5	213	290	09/08	>	S 5095 PE	S 6011 NE		S 3165 C
with air-conditioner / con climatizzatore	D0836 Euro5	213	290	09/08	>	S 5095 PE	S 6011 NE		S 4177 CA
power steering / servosterzo	D0836 Euro5	213	290	09/08	>				S 3081 PO
TGM 16.290	D0836 Euro5	213	290	09/08	>	S 5095 PE	S 6011 NE		S 3165 C
with air-conditioner / con climatizzatore	D0836 Euro5	213	290	09/08	>	S 5095 PE	S 6011 NE		S 4177 CA
power steering / servosterzo	D0836 Euro5	213	290	09/08	>				S 3081 PO
TGM 18.240	D0836LFL40/50	176	240	11/05	>	S 5095 PE	S 6011 NE		S 3165 C
with air-conditioner / con climatizzatore	D0836LFL40/50	176	240	11/05	>	S 5095 PE	S 6011 NE		S 4177 CA
power steering / servosterzo	D0836LFL40/50	176	240	11/05	>				S 3081 PO
TGM 18.250	D0836 Euro5	184	250	09/08	>	S 5095 PE	S 6011 NE		S 3165 C
with air-conditioner / con climatizzatore	D0836 Euro5	184	250	09/08	>	S 5095 PE	S 6011 NE		S 4177 CA
power steering / servosterzo	D0836 Euro5	184	250	09/08	>				S 3081 PO
TGM 18.280	D0836LFL41/51	206	280	11/05	>	S 5095 PE	S 6011 NE		S 3165 C
with air-conditioner / con climatizzatore	D0836LFL41/51	206	280	11/05	>	S 5095 PE	S 6011 NE		S 4177 CA
power steering / servosterzo	D0836LFL41/51	206	280	11/05	>				S 3081 PO
TGM 18.330	D0836LFL44/52	240	326	11/05	>	S 5095 PE	S 6011 NE		S 3165 C
with air-conditioner / con climatizzatore	D0836LFL44/52	240	326	11/05	>	S 5095 PE	S 6011 NE		S 4177 CA
power steering / servosterzo	D0836LFL44/52	240	326	11/05	>				S 3081 PO
TGM 18.340	D0836 Euro5	250	340	09/08	>	S 5095 PE	S 6011 NE		S 3165 C
with air-conditioner / con climatizzatore	D0836 Euro5	250	340	09/08	>	S 5095 PE	S 6011 NE		S 4177 CA
power steering / servosterzo	D0836 Euro5	250	340	09/08	>				S 3081 PO
TGM 22.280	D0836LFL51	206	280	09/06	>	S 5095 PE	S 6011 NE		S 3165 C
with air-conditioner / con climatizzatore	D0836LFL51	206	280	09/06	>	S 5095 PE	S 6011 NE		S 4177 CA
power steering / servosterzo	D0836LFL51	206	280	09/06	>				S 3081 PO
TGM 26.250	D0836 Euro5	184	250	09/08	>	S 5095 PE	S 6011 NE		S 3165 C
with air-conditioner / con climatizzatore	D0836 Euro5	184	250	09/08	>	S 5095 PE	S 6011 NE		S 4177 CA
power steering / servosterzo	D0836 Euro5	184	250	09/08	>				S 3081 PO
TGM 26.280	D0836LFL51	206	280	09/06	>	S 5095 PE	S 6011 NE		S 3165 C
with air-conditioner / con climatizzatore	D0836LFL51	206	280	09/06	>	S 5095 PE	S 6011 NE		S 4177 CA
power steering / servosterzo	D0836LFL51	206	280	09/06	>				S 3081 PO
TGM 26.330	D0836LFL52	240	326	09/06	>	S 5095 PE	S 6011 NE		S 3165 C
with air-conditioner / con climatizzatore	D0836LFL52	240	326	09/06	>	S 5095 PE	S 6011 NE		S 4177 CA
power steering / servosterzo	D0836LFL52	240	326	09/06	>				S 3081 PO
TGM 26.340	D0836 Euro5	250	340	09/08	>	S 5095 PE	S 6011 NE		S 3165 C
with air-conditioner / con climatizzatore	D0836 Euro5	250	340	09/08	>	S 5095 PE	S 6011 NE		S 4177 CA
power steering / servosterzo	D0836 Euro5	250	340	09/08	>				S 3081 PO
TGS Serie									
TGS 18.320	D2066 CR Euro6	235	320	09/12	> 06/16	S 5235 PE	S 6011 NE	S 7619 A	S 3165 C
	D2066 CR Euro6	235	320	07/16	>	S 5235 PE	S 6011 NE	S 7F27 A	S 3165 C
with automatic gearbox and hydraulic retarder ZF 16S / con cambio automatico e rallentatore idraulico ZF 16S	D2066 CR Euro6	235	320	09/12	>				S 2234 Z
with air-conditioner / con climatizzatore	D2066 CR Euro6	235	320	09/12	>				S 4177 CA
dryer filter / filtro essiccatore	D2066 CR Euro6	235	320	09/12	>				S 7A66 A
retarder R3500/4100 (TipMatic 12+2) / freno di rallentamento R3500/4100 (TipMatic 12+2)	D2066 CR Euro6	235	320	07/16	>				S 5613 PO
inner / interno	D2066 CR Euro6	235	320	09/12	> 06/16			S 7616 A	
inner / interno	D2066 CR Euro6	235	320	07/16	>			S 7F28 A	
prefilter / prefiltro	D2066 CR Euro6	235	320	09/12	>		S 4035 NR		
prefilter 300 Micron / prefiltro 300 Micron	D2066 CR Euro6	235	320	09/12	>		S 6088 NE		
power steering / servosterzo	D2066 CR Euro6	235	320	09/12	>				S 3081 PO
power steering ZF Servocom RAS-EC / servosterzo ZF Servocom RAS-EC	D2066 CR Euro6	235	320	09/12	>				S 5664 PO
Vehicles for building site / veicoli da cantiere	D2066 CR Euro6	235	320	09/12	> 06/16			S 7E35 A	
Vehicles for building site / veicoli da cantiere	D2066 CR Euro6	235	320	07/16	>			S 7F29 A	
TGS 18.320	D2066 Euro4/5/EEV	235	320	10/07	> 08/12	S 5046 PE	S 6011 NE	S 7619 A	S 3165 C
with air-conditioner / con climatizzatore	D2066 Euro4/5/EEV	235	320	10/07	> 08/12				S 4177 CA
inner / interno	D2066 Euro4/5/EEV	235	320	10/07	> 08/12			S 7616 A	
prefilter 300 Micron / prefiltro 300 Micron	D2066 Euro4/5/EEV	235	320	10/07	> 08/12		S 6088 NE		

M

**KW HP****...MAN - trucks/autocarri**

prefilter with fuel oil heater / prefiltro con riscaldatore nafta	D2066 Euro4/5/EEV	235	320	10/07	>	08/12		S 6059 NE		
prefilter without fuel oil heater / prefiltro senza riscaldatore nafta	D2066 Euro4/5/EEV	235	320	10/07	>	08/12		S 6062 NE		
power steering / servosterzo	D2066 Euro4/5/EEV	235	320	10/07	>	08/12				S 3081 PO
TGS 18.350	D2066 CR Euro6	257	349	09/12	>	06/16	S 5235 PE	S 6011 NE	S 7619 A	S 3165 C
with automatic gearbox and hydraulic retarder ZF 16S / con cambio automatico e rallentatore idraulico ZF 16S	D2066 CR Euro6	257	349	09/12	>	06/16				S 2234 Z
with air-conditioner / con climatizzatore	D2066 CR Euro6	257	349	09/12	>	06/16				S 4177 CA
retarder R3500/4100 (TipMatic 12+2) / freno di rallentamento R3500/4100 (TipMatic 12+2)	D2066 CR Euro6	257	349	09/12	>	06/16				S 5613 PO
inner / interno	D2066 CR Euro6	257	349	09/12	>	06/16			S 7616 A	
prefilter / prefiltro	D2066 CR Euro6	257	349	09/12	>	06/16		S 4035 NR		
prefilter 300 Micron / prefiltro 300 Micron	D2066 CR Euro6	257	349	09/12	>	06/16		S 6088 NE		
power steering / servosterzo	D2066 CR Euro6	257	349	09/12	>	06/16				S 3081 PO
power steering ZF Servocom RAS-EC / servosterzo ZF Servocom RAS-EC	D2066 CR Euro6	257	349	09/12	>	06/16				S 5664 PO
Vehicles for building site / veicoli da cantiere	D2066 CR Euro6	257	349	09/12	>	06/16			S 7E35 A	
TGS 18.350	D2066 Euro4/5/EEV	257	349	10/07	>	08/12	S 5046 PE	S 6011 NE	S 7619 A	S 3165 C
with air-conditioner / con climatizzatore	D2066 Euro4/5/EEV	257	349	10/07	>	08/12				S 4177 CA
inner / interno	D2066 Euro4/5/EEV	257	349	10/07	>	08/12			S 7616 A	
prefilter 300 Micron / prefiltro 300 Micron	D2066 Euro4/5/EEV	257	349	10/07	>	08/12		S 6088 NE		
prefilter with fuel oil heater / prefiltro con riscaldatore nafta	D2066 Euro4/5/EEV	257	349	10/07	>	08/12		S 6059 NE		
prefilter without fuel oil heater / prefiltro senza riscaldatore nafta	D2066 Euro4/5/EEV	257	349	10/07	>	08/12		S 6062 NE		
power steering / servosterzo	D2066 Euro4/5/EEV	257	349	10/07	>	08/12				S 3081 PO
TGS 18.360	D2066 CR Euro6	265	360	09/12	>	06/16	S 5235 PE	S 6011 NE	S 7619 A	S 3165 C
with automatic gearbox and hydraulic retarder ZF 16S / con cambio automatico e rallentatore idraulico ZF 16S	D2066 CR Euro6	265	360	07/16	>		S 5235 PE	S 6011 NE	S 7F27 A	S 3165 C
with air-conditioner / con climatizzatore	D2066 CR Euro6	265	360	09/12	>					S 2234 Z
retarder R3500/4100 (TipMatic 12+2) / freno di rallentamento R3500/4100 (TipMatic 12+2)	D2066 CR Euro6	265	360	07/16	>					S 4177 CA
inner / interno	D2066 CR Euro6	265	360	09/12	>	06/16			S 7616 A	S 5613 PO
inner / interno	D2066 CR Euro6	265	360	07/16	>				S 7F28 A	
prefilter / prefiltro	D2066 CR Euro6	265	360	09/12	>			S 4035 NR		
prefilter 300 Micron / prefiltro 300 Micron	D2066 CR Euro6	265	360	09/12	>			S 6088 NE		
power steering / servosterzo	D2066 CR Euro6	265	360	09/12	>					S 3081 PO
power steering ZF Servocom RAS-EC / servosterzo ZF Servocom RAS-EC	D2066 CR Euro6	265	360	09/12	>					S 5664 PO
Vehicles for building site / veicoli da cantiere	D2066 CR Euro6	265	360	09/12	>	06/16			S 7E35 A	
Vehicles for building site / veicoli da cantiere	D2066 CR Euro6	265	360	07/16	>				S 7F29 A	
TGS 18.360	D2066 Euro4/5/EEV	265	360	10/07	>	08/12	S 5046 PE	S 6011 NE	S 7619 A	S 3165 C
with air-conditioner / con climatizzatore	D2066 Euro4/5/EEV	265	360	10/07	>	08/12				S 4177 CA
inner / interno	D2066 Euro4/5/EEV	265	360	10/07	>	08/12			S 7616 A	
prefilter 300 Micron / prefiltro 300 Micron	D2066 Euro4/5/EEV	265	360	10/07	>	08/12		S 6088 NE		
prefilter with fuel oil heater / prefiltro con riscaldatore nafta	D2066 Euro4/5/EEV	265	360	10/07	>	08/12		S 6059 NE		
prefilter without fuel oil heater / prefiltro senza riscaldatore nafta	D2066 Euro4/5/EEV	265	360	10/07	>	08/12		S 6062 NE		
power steering / servosterzo	D2066 Euro4/5/EEV	265	360	10/07	>	08/12				S 3081 PO
TGS 18.390	D2066 CR Euro6	287	390	09/12	>	06/16	S 5235 PE	S 6011 NE	S 7619 A	S 3165 C
with automatic gearbox and hydraulic retarder ZF 16S / con cambio automatico e rallentatore idraulico ZF 16S	D2066 CR Euro6	287	390	09/12	>	06/16				S 2234 Z
with air-conditioner / con climatizzatore	D2066 CR Euro6	287	390	09/12	>	06/16				S 4177 CA
retarder R3500/4100 (TipMatic 12+2) / freno di rallentamento R3500/4100 (TipMatic 12+2)	D2066 CR Euro6	287	390	09/12	>	06/16				S 5613 PO
inner / interno	D2066 CR Euro6	287	390	09/12	>	06/16			S 7616 A	
prefilter / prefiltro	D2066 CR Euro6	287	390	09/12	>	06/16		S 4035 NR		
prefilter 300 Micron / prefiltro 300 Micron	D2066 CR Euro6	287	390	09/12	>	06/16		S 6088 NE		
power steering / servosterzo	D2066 CR Euro6	287	390	09/12	>	06/16				S 3081 PO
power steering ZF Servocom RAS-EC / servosterzo ZF Servocom RAS-EC	D2066 CR Euro6	287	390	09/12	>	06/16				S 5664 PO
Vehicles for building site / veicoli da cantiere	D2066 CR Euro6	287	390	09/12	>	06/16			S 7E35 A	
TGS 18.390	D2066 Euro4/5/EEV	287	390	06/08	>	08/12	S 5046 PE	S 6011 NE	S 7619 A	S 3165 C
with air-conditioner / con climatizzatore	D2066 Euro4/5/EEV	287	390	06/08	>	08/12				S 4177 CA
inner / interno	D2066 Euro4/5/EEV	287	390	06/08	>	08/12			S 7616 A	
prefilter 300 Micron / prefiltro 300 Micron	D2066 Euro4/5/EEV	287	390	06/08	>	08/12		S 6088 NE		
prefilter with fuel oil heater / prefiltro con riscaldatore nafta	D2066 Euro4/5/EEV	287	390	06/08	>	08/12		S 6059 NE		
prefilter without fuel oil heater / prefiltro senza riscaldatore nafta	D2066 Euro4/5/EEV	287	390	06/08	>	08/12		S 6062 NE		
power steering / servosterzo	D2066 Euro4/5/EEV	287	390	06/08	>	08/12				S 3081 PO
TGS 18.400	D2066 CR Euro6	294	400	09/12	>	06/16	S 5235 PE	S 6011 NE	S 7619 A	S 3165 C
with automatic gearbox and hydraulic retarder ZF 16S / con cambio automatico e rallentatore idraulico ZF 16S	D2066 CR Euro6	294	400	09/12	>	06/16				S 2234 Z
with air-conditioner / con climatizzatore	D2066 CR Euro6	294	400	09/12	>	06/16				S 4177 CA
inner / interno	D2066 CR Euro6	294	400	09/12	>	06/16			S 7616 A	
prefilter / prefiltro	D2066 CR Euro6	294	400	09/12	>	06/16		S 4035 NR		
prefilter 300 Micron / prefiltro 300 Micron	D2066 CR Euro6	294	400	09/12	>	06/16		S 6088 NE		
power steering / servosterzo	D2066 CR Euro6	294	400	09/12	>	06/16				S 3081 PO
power steering ZF Servocom RAS-EC / servosterzo ZF Servocom RAS-EC	D2066 CR Euro6	294	400	09/12	>	06/16				S 5664 PO
Vehicles for building site / veicoli da cantiere	D2066 CR Euro6	294	400	09/12	>	06/16			S 7E35 A	
TGS 18.400	D2066 Euro4/5/EEV	294	400	10/07	>	08/12	S 5046 PE	S 6011 NE	S 7619 A	S 3165 C

**KW HP****...MAN - trucks/autocarri**

with air-conditioner / con climatizzatore	D2066 Euro4/5/EEV	294	400	10/07	>	08/12			S 4177 CA
inner / interno	D2066 Euro4/5/EEV	294	400	10/07	>	08/12			
prefilter 300 Micron / prefiltro 300 Micron	D2066 Euro4/5/EEV	294	400	10/07	>	08/12		S 6088 NE	S 7616 A
prefilter with fuel oil heater / prefiltro con riscaldatore nafta	D2066 Euro4/5/EEV	294	400	10/07	>	08/12		S 6059 NE	
prefilter without fuel oil heater / prefiltro senza riscaldatore nafta	D2066 Euro4/5/EEV	294	400	10/07	>	08/12		S 6062 NE	
power steering / servosterzo	D2066 Euro4/5/EEV	294	400	10/07	>	08/12			S 3081 PO
TGS 18.420	D2676 CR Euro6	309	420	07/16	>		S 5235 PE	S 6011 NE	S 7F27 A
with automatic gearbox and hydraulic retarder ZF 16S / con cambio automatico e rallentatore idraulico ZF 16S	D2676 CR Euro6	309	420	07/16	>				S 3165 C
with air-conditioner / con climatizzatore	D2676 CR Euro6	309	420	07/16	>				S 2234 Z
dryer filter / filtro essiccatore	D2676 CR Euro6	309	420	07/16	>				S 4177 CA
retarder R3500/4100 (TipMatic 12+2) / freno di rallentamento R3500/4100 (TipMatic 12+2)	D2676 CR Euro6	309	420	07/16	>				S 7A66 A
inner / interno	D2676 CR Euro6	309	420	07/16	>				S 5613 PO
prefilter / prefiltro	D2676 CR Euro6	309	420	07/16	>			S 4035 NR	
prefilter 300 Micron / prefiltro 300 Micron	D2676 CR Euro6	309	420	07/16	>			S 6088 NE	
power steering / servosterzo	D2676 CR Euro6	309	420	07/16	>				S 3081 PO
power steering ZF Servocom RAS-EC / servosterzo ZF Servocom RAS-EC	D2676 CR Euro6	309	420	07/16	>				S 5664 PO
Vehicles for building site / veicoli da cantiere	D2676 CR Euro6	309	420	07/16	>				S 7F29 A
TGS 18.430	D2066 CR Euro6	316	430	09/12	>	06/16	S 5235 PE	S 6011 NE	S 7619 A
with automatic gearbox and hydraulic retarder ZF 16S / con cambio automatico e rallentatore idraulico ZF 16S	D2066 CR Euro6	316	430	09/12	>	06/16			S 3165 C
with air-conditioner / con climatizzatore	D2066 CR Euro6	316	430	09/12	>	06/16			S 2234 Z
retarder R3500/4100 (TipMatic 12+2) / freno di rallentamento R3500/4100 (TipMatic 12+2)	D2066 CR Euro6	316	430	09/12	>	06/16			S 4177 CA
inner / interno	D2066 CR Euro6	316	430	09/12	>	06/16			S 5613 PO
prefilter / prefiltro	D2066 CR Euro6	316	430	09/12	>	06/16		S 4035 NR	
prefilter 300 Micron / prefiltro 300 Micron	D2066 CR Euro6	316	430	09/12	>	06/16		S 6088 NE	
power steering / servosterzo	D2066 CR Euro6	316	430	09/12	>	06/16			S 3081 PO
power steering ZF Servocom RAS-EC / servosterzo ZF Servocom RAS-EC	D2066 CR Euro6	316	430	09/12	>	06/16			S 5664 PO
Vehicles for building site / veicoli da cantiere	D2066 CR Euro6	316	430	09/12	>	06/16			S 7E35 A
TGS 18.430	D2066 Euro4/5/EEV	316	430	10/07	>	08/12	S 5046 PE	S 6011 NE	S 7619 A
with air-conditioner / con climatizzatore	D2066 Euro4/5/EEV	316	430	10/07	>	08/12			S 3165 C
inner / interno	D2066 Euro4/5/EEV	316	430	10/07	>	08/12			S 4177 CA
prefilter 300 Micron / prefiltro 300 Micron	D2066 Euro4/5/EEV	316	430	10/07	>	08/12		S 6088 NE	
prefilter with fuel oil heater / prefiltro con riscaldatore nafta	D2066 Euro4/5/EEV	316	430	10/07	>	08/12		S 6059 NE	
prefilter without fuel oil heater / prefiltro senza riscaldatore nafta	D2066 Euro4/5/EEV	316	430	10/07	>	08/12		S 6062 NE	
power steering / servosterzo	D2066 Euro4/5/EEV	316	430	10/07	>	08/12			S 3081 PO
TGS 18.440	D2066 CR Euro6	324	440	09/12	>		S 5235 PE	S 6011 NE	S 7619 A
with automatic gearbox and hydraulic retarder ZF 16S / con cambio automatico e rallentatore idraulico ZF 16S	D2066 CR Euro6	324	440	09/12	>				S 3165 C
with air-conditioner / con climatizzatore	D2066 CR Euro6	324	440	09/12	>				S 2234 Z
inner / interno	D2066 CR Euro6	324	440	09/12	>				S 4177 CA
prefilter / prefiltro	D2066 CR Euro6	324	440	09/12	>			S 4035 NR	
prefilter 300 Micron / prefiltro 300 Micron	D2066 CR Euro6	324	440	09/12	>			S 6088 NE	
power steering / servosterzo	D2066 CR Euro6	324	440	09/12	>				S 3081 PO
TGS 18.440	D2066 Euro4/5/EEV	324	441	10/07	>	08/12	S 5046 PE	S 6011 NE	S 7619 A
with air-conditioner / con climatizzatore	D2066 Euro4/5/EEV	324	441	10/07	>	08/12			S 3165 C
inner / interno	D2066 Euro4/5/EEV	324	441	10/07	>	08/12			S 4177 CA
prefilter with fuel oil heater / prefiltro con riscaldatore nafta	D2066 Euro4/5/EEV	324	441	10/07	>	08/12		S 6059 NE	
prefilter without fuel oil heater / prefiltro senza riscaldatore nafta	D2066 Euro4/5/EEV	324	441	10/07	>	08/12		S 6062 NE	
power steering / servosterzo	D2066 Euro4/5/EEV	324	441	10/07	>	08/12			S 3081 PO
TGS 18.460	D2676 Euro6	338	460	07/16	>		S 5235 PE	S 6011 NE	S 7619 A
with air-conditioner / con climatizzatore	D2676 Euro6	338	460	07/16	>				S 3165 C
dryer filter / filtro essiccatore	D2676 Euro6	338	460	07/16	>				S 4177 CA
prefilter / prefiltro	D2676 Euro6	338	460	07/16	>			S 4035 NR	
prefilter 300 Micron / prefiltro 300 Micron	D2676 Euro6	338	460	07/16	>			S 6088 NE	
power steering / servosterzo	D2676 Euro6	338	460	07/16	>				S 3081 PO
power steering ZF Servocom RAS-EC / servosterzo ZF Servocom RAS-EC	D2676 Euro6	338	460	07/16	>				S 5664 PO
TGS 18.480	D2676 CR Euro6	353	480	09/12	>		S 5235 PE	S 6011 NE	S 7619 A
with automatic gearbox and hydraulic retarder ZF 16S / con cambio automatico e rallentatore idraulico ZF 16S	D2676 CR Euro6	353	480	09/12	>				S 3165 C
with air-conditioner / con climatizzatore	D2676 CR Euro6	353	480	09/12	>				S 2234 Z
inner / interno	D2676 CR Euro6	353	480	09/12	>				S 4177 CA
prefilter / prefiltro	D2676 CR Euro6	353	480	09/12	>			S 4035 NR	
prefilter 300 Micron / prefiltro 300 Micron	D2676 CR Euro6	353	480	09/12	>			S 6088 NE	
power steering / servosterzo	D2676 CR Euro6	353	480	09/12	>				S 3081 PO
TGS 18.480	D2676 Euro4/5/EEV	353	480	10/07	>	08/12	S 5046 PE	S 6011 NE	S 7619 A
with air-conditioner / con climatizzatore	D2676 Euro4/5/EEV	353	480	10/07	>	08/12			S 3165 C
inner / interno	D2676 Euro4/5/EEV	353	480	10/07	>	08/12			S 4177 CA
prefilter with fuel oil heater / prefiltro con riscaldatore nafta	D2676 Euro4/5/EEV	353	480	10/07	>	08/12		S 6059 NE	
prefilter without fuel oil heater / prefiltro senza riscaldatore nafta	D2676 Euro4/5/EEV	353	480	10/07	>	08/12		S 6062 NE	
power steering / servosterzo	D2676 Euro4/5/EEV	353	480	10/07	>	08/12			S 3081 PO

M



...MAN - trucks/autocarri

M

TGS 18.500	D2676 Euro6	368	500	07/16	>	S 5235 PE	S 6011 NE		S 3165 C
with air-conditioner / con climatizzatore	D2676 Euro6	368	500	07/16	>				S 4177 CA
dryer filter / filtro essiccatore	D2676 Euro6	368	500	07/16	>				S 7A66 A
prefilter / prefiltro	D2676 Euro6	368	500	07/16	>		S 4035 NR		
prefilter 300 Micron / prefiltro 300 Micron	D2676 Euro6	368	500	07/16	>		S 6088 NE		
power steering / servosterzo	D2676 Euro6	368	500	07/16	>				S 3081 PO
power steering ZF Servocom RAS-EC / servosterzo ZF Servocom RAS-EC	D2676 Euro6	368	500	07/16	>				S 5664 PO
TGS 18.540	D2676 Euro4/5/EEV	397	540	10/07	> 08/12	S 5046 PE	S 6011 NE	S 7619 A	S 3165 C
with air-conditioner / con climatizzatore	D2676 Euro4/5/EEV	397	540	10/07	> 08/12				S 4177 CA
inner / interno	D2676 Euro4/5/EEV	397	540	10/07	> 08/12			S 7616 A	
prefilter with fuel oil heater / prefiltro con riscaldatore nafta	D2676 Euro4/5/EEV	397	540	10/07	> 08/12		S 6059 NE		
prefilter without fuel oil heater / prefiltro senza riscaldatore nafta	D2676 Euro4/5/EEV	397	540	10/07	> 08/12		S 6062 NE		
power steering / servosterzo	D2676 Euro4/5/EEV	397	540	10/07	> 08/12				S 3081 PO
TGS 19.350	D2066 CR Euro6	257	349	09/12	> 06/16	S 5235 PE	S 6011 NE	S 7619 A	S 3165 C
with automatic gearbox and hydraulic retarder ZF 16S / con cambio automatico e rallentatore idraulico ZF 16S	D2066 CR Euro6	257	349	09/12	> 06/16				S 2234 Z
with air-conditioner / con climatizzatore	D2066 CR Euro6	257	349	09/12	> 06/16				S 4177 CA
retarder R3500/4100 (TipMatic 12+2) / freno di rallentamento R3500/4100 (TipMatic 12+2)	D2066 CR Euro6	257	349	09/12	> 06/16				S 5613 PO
inner / interno	D2066 CR Euro6	257	349	09/12	> 06/16			S 7616 A	
prefilter / prefiltro	D2066 CR Euro6	257	349	09/12	> 06/16		S 4035 NR		
prefilter 300 Micron / prefiltro 300 Micron	D2066 CR Euro6	257	349	09/12	> 06/16		S 6088 NE		
power steering / servosterzo	D2066 CR Euro6	257	349	09/12	> 06/16				S 3081 PO
power steering ZF Servocom RAS-EC / servosterzo ZF Servocom RAS-EC	D2066 CR Euro6	257	349	09/12	> 06/16				S 5664 PO
Vehicles for building site / veicoli da cantiere	D2066 CR Euro6	257	349	09/12	> 06/16			S 7E35 A	
TGS 19.350	D2066 Euro4/5/EEV	257	349	10/07	> 08/12	S 5046 PE	S 6011 NE	S 7619 A	S 3165 C
with air-conditioner / con climatizzatore	D2066 Euro4/5/EEV	257	349	10/07	> 08/12				S 4177 CA
inner / interno	D2066 Euro4/5/EEV	257	349	10/07	> 08/12			S 7616 A	
prefilter 300 Micron / prefiltro 300 Micron	D2066 Euro4/5/EEV	257	349	10/07	> 08/12		S 6088 NE		
prefilter with fuel oil heater / prefiltro con riscaldatore nafta	D2066 Euro4/5/EEV	257	349	10/07	> 08/12		S 6059 NE		
prefilter without fuel oil heater / prefiltro senza riscaldatore nafta	D2066 Euro4/5/EEV	257	349	10/07	> 08/12		S 6062 NE		
power steering / servosterzo	D2066 Euro4/5/EEV	257	349	10/07	> 08/12				S 3081 PO
TGS 19.360	D2066 CR Euro6	265	360	09/12	> 06/16	S 5235 PE	S 6011 NE	S 7619 A	S 3165 C
with automatic gearbox and hydraulic retarder ZF 16S / con cambio automatico e rallentatore idraulico ZF 16S	D2066 CR Euro6	265	360	07/16	>	S 5235 PE	S 6011 NE	S 7F27 A	S 3165 C
with air-conditioner / con climatizzatore	D2066 CR Euro6	265	360	09/12	>				S 2234 Z
retarder R3500/4100 (TipMatic 12+2) / freno di rallentamento R3500/4100 (TipMatic 12+2)	D2066 CR Euro6	265	360	07/16	>				S 4177 CA
inner / interno	D2066 CR Euro6	265	360	09/12	> 06/16			S 7616 A	S 5613 PO
inner / interno	D2066 CR Euro6	265	360	07/16	>			S 7F28 A	
prefilter / prefiltro	D2066 CR Euro6	265	360	09/12	>		S 4035 NR		
prefilter 300 Micron / prefiltro 300 Micron	D2066 CR Euro6	265	360	09/12	>		S 6088 NE		
power steering / servosterzo	D2066 CR Euro6	265	360	09/12	>				S 3081 PO
power steering ZF Servocom RAS-EC / servosterzo ZF Servocom RAS-EC	D2066 CR Euro6	265	360	09/12	>				S 5664 PO
Vehicles for building site / veicoli da cantiere	D2066 CR Euro6	265	360	09/12	> 06/16			S 7E35 A	
Vehicles for building site / veicoli da cantiere	D2066 CR Euro6	265	360	07/16	>			S 7F29 A	
TGS 19.360	D2066 Euro4/5/EEV	265	360	02/11	> 08/12	S 5046 PE	S 6011 NE	S 7619 A	S 3165 C
with air-conditioner / con climatizzatore	D2066 Euro4/5/EEV	265	360	02/11	> 08/12				S 4177 CA
inner / interno	D2066 Euro4/5/EEV	265	360	02/11	> 08/12			S 7616 A	
prefilter 300 Micron / prefiltro 300 Micron	D2066 Euro4/5/EEV	265	360	02/11	> 08/12		S 6088 NE		
prefilter with fuel oil heater / prefiltro con riscaldatore nafta	D2066 Euro4/5/EEV	265	360	02/11	> 08/12		S 6059 NE		
prefilter without fuel oil heater / prefiltro senza riscaldatore nafta	D2066 Euro4/5/EEV	265	360	02/11	> 08/12		S 6062 NE		
power steering / servosterzo	D2066 Euro4/5/EEV	265	360	02/11	> 08/12				S 3081 PO
TGS 19.390	D2066 CR Euro6	287	390	09/12	> 06/16	S 5235 PE	S 6011 NE	S 7619 A	S 3165 C
with automatic gearbox and hydraulic retarder ZF 16S / con cambio automatico e rallentatore idraulico ZF 16S	D2066 CR Euro6	287	390	09/12	> 06/16				S 2234 Z
with air-conditioner / con climatizzatore	D2066 CR Euro6	287	390	09/12	> 06/16				S 4177 CA
retarder R3500/4100 (TipMatic 12+2) / freno di rallentamento R3500/4100 (TipMatic 12+2)	D2066 CR Euro6	287	390	09/12	> 06/16				S 5613 PO
inner / interno	D2066 CR Euro6	287	390	09/12	> 06/16			S 7616 A	
prefilter / prefiltro	D2066 CR Euro6	287	390	09/12	> 06/16		S 4035 NR		
prefilter 300 Micron / prefiltro 300 Micron	D2066 CR Euro6	287	390	09/12	> 06/16		S 6088 NE		
power steering / servosterzo	D2066 CR Euro6	287	390	09/12	> 06/16				S 3081 PO
power steering ZF Servocom RAS-EC / servosterzo ZF Servocom RAS-EC	D2066 CR Euro6	287	390	09/12	> 06/16				S 5664 PO
Vehicles for building site / veicoli da cantiere	D2066 CR Euro6	287	390	09/12	> 06/16			S 7E35 A	
TGS 19.390	D2066 Euro4/5/EEV	287	390	06/08	> 08/12	S 5046 PE	S 6011 NE	S 7619 A	S 3165 C
with air-conditioner / con climatizzatore	D2066 Euro4/5/EEV	287	390	06/08	> 08/12				S 4177 CA
inner / interno	D2066 Euro4/5/EEV	287	390	06/08	> 08/12			S 7616 A	
prefilter 300 Micron / prefiltro 300 Micron	D2066 Euro4/5/EEV	287	390	06/08	> 08/12		S 6088 NE		
prefilter with fuel oil heater / prefiltro con riscaldatore nafta	D2066 Euro4/5/EEV	287	390	06/08	> 08/12		S 6059 NE		
prefilter without fuel oil heater / prefiltro senza riscaldatore nafta	D2066 Euro4/5/EEV	287	390	06/08	> 08/12		S 6062 NE		
power steering / servosterzo	D2066 Euro4/5/EEV	287	390	06/08	> 08/12				S 3081 PO

**KW HP****...MAN - trucks/autocarri**

TGS 19.400	D2066 CR Euro6	294	400	09/12	>	06/16	S 5235 PE	S 6011 NE	S 7619 A	S 3165 C
with automatic gearbox and hydraulic retarder ZF 16S / con cambio automatico e rallentatore idraulico ZF 16S	D2066 CR Euro6	294	400	09/12	>	06/16				S 2234 Z
with air-conditioner / con climatizzatore	D2066 CR Euro6	294	400	09/12	>	06/16				S 4177 CA
inner / interno	D2066 CR Euro6	294	400	09/12	>	06/16			S 7616 A	
prefilter / prefiltra	D2066 CR Euro6	294	400	09/12	>	06/16		S 4035 NR		
prefilter 300 Micron / prefiltra 300 Micron	D2066 CR Euro6	294	400	09/12	>	06/16		S 6088 NE		
power steering / servosterzo	D2066 CR Euro6	294	400	09/12	>	06/16				S 3081 PO
power steering ZF Servocom RAS-EC / servosterzo ZF Servocom RAS-EC	D2066 CR Euro6	294	400	09/12	>	06/16				S 5664 PO
Vehicles for building site / veicoli da cantiere	D2066 CR Euro6	294	400	09/12	>	06/16			S 7E35 A	
TGS 19.400	D2066 Euro4/5/EEV	294	400	02/11	>	08/12	S 5046 PE	S 6011 NE	S 7619 A	S 3165 C
with air-conditioner / con climatizzatore	D2066 Euro4/5/EEV	294	400	02/11	>	08/12				S 4177 CA
inner / interno	D2066 Euro4/5/EEV	294	400	02/11	>	08/12			S 7616 A	
prefilter 300 Micron / prefiltra 300 Micron	D2066 Euro4/5/EEV	294	400	02/11	>	08/12		S 6088 NE		
prefilter with fuel oil heater / prefiltra con riscaldatore nafta	D2066 Euro4/5/EEV	294	400	02/11	>	08/12		S 6059 NE		
prefilter without fuel oil heater / prefiltra senza riscaldatore nafta	D2066 Euro4/5/EEV	294	400	02/11	>	08/12		S 6062 NE		
power steering / servosterzo	D2066 Euro4/5/EEV	294	400	02/11	>	08/12				S 3081 PO
TGS 19.420	D2676 CR Euro6	309	420	07/16	>		S 5235 PE	S 6011 NE	S 7F27 A	S 3165 C
with automatic gearbox and hydraulic retarder ZF 16S / con cambio automatico e rallentatore idraulico ZF 16S	D2676 CR Euro6	309	420	07/16	>					S 2234 Z
with air-conditioner / con climatizzatore	D2676 CR Euro6	309	420	07/16	>					S 4177 CA
retarder R3500/4100 (TipMatic 12+2) / freno di rallentamento R3500/4100 (TipMatic 12+2)	D2676 CR Euro6	309	420	07/16	>					S 5613 PO
inner / interno	D2676 CR Euro6	309	420	07/16	>				S 7F28 A	
prefilter / prefiltra	D2676 CR Euro6	309	420	07/16	>			S 4035 NR		
prefilter 300 Micron / prefiltra 300 Micron	D2676 CR Euro6	309	420	07/16	>			S 6088 NE		
power steering / servosterzo	D2676 CR Euro6	309	420	07/16	>					S 3081 PO
power steering ZF Servocom RAS-EC / servosterzo ZF Servocom RAS-EC	D2676 CR Euro6	309	420	07/16	>					S 5664 PO
Vehicles for building site / veicoli da cantiere	D2676 CR Euro6	309	420	07/16	>				S 7F29 A	
TGS 19.430	D2066 CR Euro6	316	430	09/12	>	06/16	S 5235 PE	S 6011 NE	S 7619 A	S 3165 C
with automatic gearbox and hydraulic retarder ZF 16S / con cambio automatico e rallentatore idraulico ZF 16S	D2066 CR Euro6	316	430	09/12	>	06/16				S 2234 Z
with air-conditioner / con climatizzatore	D2066 CR Euro6	316	430	09/12	>	06/16				S 4177 CA
retarder R3500/4100 (TipMatic 12+2) / freno di rallentamento R3500/4100 (TipMatic 12+2)	D2066 CR Euro6	316	430	09/12	>	06/16				S 5613 PO
inner / interno	D2066 CR Euro6	316	430	09/12	>	06/16			S 7616 A	
prefilter / prefiltra	D2066 CR Euro6	316	430	09/12	>	06/16		S 4035 NR		
prefilter 300 Micron / prefiltra 300 Micron	D2066 CR Euro6	316	430	09/12	>	06/16		S 6088 NE		
power steering / servosterzo	D2066 CR Euro6	316	430	09/12	>	06/16				S 3081 PO
power steering ZF Servocom RAS-EC / servosterzo ZF Servocom RAS-EC	D2066 CR Euro6	316	430	09/12	>	06/16				S 5664 PO
Vehicles for building site / veicoli da cantiere	D2066 CR Euro6	316	430	09/12	>	06/16			S 7E35 A	
TGS 19.430	D2066 Euro4/5/EEV	316	430	10/07	>	08/12	S 5046 PE	S 6011 NE	S 7619 A	S 3165 C
with air-conditioner / con climatizzatore	D2066 Euro4/5/EEV	316	430	10/07	>	08/12				S 4177 CA
inner / interno	D2066 Euro4/5/EEV	316	430	10/07	>	08/12			S 7616 A	
prefilter 300 Micron / prefiltra 300 Micron	D2066 Euro4/5/EEV	316	430	10/07	>	08/12		S 6088 NE		
prefilter with fuel oil heater / prefiltra con riscaldatore nafta	D2066 Euro4/5/EEV	316	430	10/07	>	08/12		S 6059 NE		
prefilter without fuel oil heater / prefiltra senza riscaldatore nafta	D2066 Euro4/5/EEV	316	430	10/07	>	08/12		S 6062 NE		
power steering / servosterzo	D2066 Euro4/5/EEV	316	430	10/07	>	08/12				S 3081 PO
TGS 19.440	D2066 CR Euro6	324	440	09/12	>		S 5235 PE	S 6011 NE	S 7619 A	S 3165 C
with automatic gearbox and hydraulic retarder ZF 16S / con cambio automatico e rallentatore idraulico ZF 16S	D2066 CR Euro6	324	440	09/12	>					S 2234 Z
with air-conditioner / con climatizzatore	D2066 CR Euro6	324	440	09/12	>					S 4177 CA
inner / interno	D2066 CR Euro6	324	440	09/12	>				S 7616 A	
prefilter / prefiltra	D2066 CR Euro6	324	440	09/12	>			S 4035 NR		
prefilter 300 Micron / prefiltra 300 Micron	D2066 CR Euro6	324	440	09/12	>			S 6088 NE		
power steering / servosterzo	D2066 CR Euro6	324	440	09/12	>					S 3081 PO
TGS 19.460	D2676 Euro6	338	460	07/16	>		S 5235 PE	S 6011 NE		S 3165 C
with air-conditioner / con climatizzatore	D2676 Euro6	338	460	07/16	>					S 4177 CA
dryer filter / filtro essiccatore	D2676 Euro6	338	460	07/16	>					S 7A66 A
prefilter / prefiltra	D2676 Euro6	338	460	07/16	>			S 4035 NR		
prefilter 300 Micron / prefiltra 300 Micron	D2676 Euro6	338	460	07/16	>			S 6088 NE		
power steering / servosterzo	D2676 Euro6	338	460	07/16	>					S 3081 PO
power steering ZF Servocom RAS-EC / servosterzo ZF Servocom RAS-EC	D2676 Euro6	338	460	07/16	>					S 5664 PO
TGS 19.480	D2676 CR Euro6	353	480	09/12	>	07/16	S 5235 PE	S 6011 NE	S 7619 A	S 3165 C
with automatic gearbox and hydraulic retarder ZF 16S / con cambio automatico e rallentatore idraulico ZF 16S	D2676 CR Euro6	353	480	09/12	>	07/16				S 2234 Z
with air-conditioner / con climatizzatore	D2676 CR Euro6	353	480	09/12	>	07/16				S 4177 CA
inner / interno	D2676 CR Euro6	353	480	09/12	>	07/16			S 7616 A	
prefilter / prefiltra	D2676 CR Euro6	353	480	09/12	>	07/16		S 4035 NR		
prefilter 300 Micron / prefiltra 300 Micron	D2676 CR Euro6	353	480	09/12	>	07/16		S 6088 NE		
power steering / servosterzo	D2676 CR Euro6	353	480	09/12	>	07/16				S 3081 PO
TGS 19.480	D2676 Euro4/5/EEV	353	480	02/11	>	08/12	S 5046 PE	S 6011 NE	S 7619 A	S 3165 C
with air-conditioner / con climatizzatore	D2676 Euro4/5/EEV	353	480	02/11	>	08/12				S 4177 CA
inner / interno	D2676 Euro4/5/EEV	353	480	02/11	>	08/12			S 7616 A	

M

**KW HP****...MAN - trucks/autocarri**

prefilter with fuel oil heater / prefiltro con riscaldatore nafta	D2676 Euro4/5/EEV	353	480	02/11 >	08/12		S 6059 NE		
prefilter without fuel oil heater / prefiltro senza riscaldatore nafta	D2676 Euro4/5/EEV	353	480	02/11 >	08/12		S 6062 NE		
power steering / servosterzo	D2676 Euro4/5/EEV	353	480	02/11 >	08/12				S 3081 PO
TGS 19.500	D2676 Euro6	368	500	07/16 >		S 5235 PE	S 6011 NE		S 3165 C
with air-conditioner / con climatizzatore	D2676 Euro6	368	500	07/16 >					S 4177 CA
dryer filter / filtro essiccatore	D2676 Euro6	368	500	07/16 >					S 7A66 A
prefilter / prefiltro	D2676 Euro6	368	500	07/16 >			S 4035 NR		
prefilter 300 Micron / prefiltro 300 Micron	D2676 Euro6	368	500	07/16 >			S 6088 NE		
power steering / servosterzo	D2676 Euro6	368	500	07/16 >					S 3081 PO
power steering ZF Servocom RAS-EC / servosterzo ZF Servocom RAS-EC	D2676 Euro6	368	500	07/16 >					S 5664 PO
TGS 21.360	D2066 CR Euro6	265	360	09/12 >	06/16	S 5235 PE	S 6011 NE	S 7619 A	S 3165 C
	D2066 CR Euro6	265	360	07/16 >		S 5235 PE	S 6011 NE	S 7F27 A	S 3165 C
with automatic gearbox and hydraulic retarder ZF 16S / con cambio automatico e rallentatore idraulico ZF 16S	D2066 CR Euro6	265	360	09/12 >					S 2234 Z
with air-conditioner / con climatizzatore	D2066 CR Euro6	265	360	09/12 >					S 4177 CA
retarder R3500/4100 (TipMatic 12+2) / freno di rallentamento R3500/4100 (TipMatic 12+2)	D2066 CR Euro6	265	360	07/16 >					S 5613 PO
inner / interno	D2066 CR Euro6	265	360	09/12 >	06/16			S 7616 A	
inner / interno	D2066 CR Euro6	265	360	07/16 >				S 7F28 A	
prefilter / prefiltro	D2066 CR Euro6	265	360	09/12 >			S 4035 NR		
prefilter 300 Micron / prefiltro 300 Micron	D2066 CR Euro6	265	360	09/12 >			S 6088 NE		
power steering / servosterzo	D2066 CR Euro6	265	360	09/12 >					S 3081 PO
power steering ZF Servocom RAS-EC / servosterzo ZF Servocom RAS-EC	D2066 CR Euro6	265	360	09/12 >					S 5664 PO
Vehicles for building site / veicoli da cantiere	D2066 CR Euro6	265	360	09/12 >	06/16			S 7E35 A	
Vehicles for building site / veicoli da cantiere	D2066 CR Euro6	265	360	07/16 >				S 7F29 A	
TGS 21.360	D2066 Euro4/5/EEV	265	360	10/07 >	08/12	S 5046 PE	S 6011 NE	S 7619 A	S 3165 C
with air-conditioner / con climatizzatore	D2066 Euro4/5/EEV	265	360	10/07 >	08/12				S 4177 CA
inner / interno	D2066 Euro4/5/EEV	265	360	10/07 >	08/12			S 7616 A	
prefilter 300 Micron / prefiltro 300 Micron	D2066 Euro4/5/EEV	265	360	10/07 >	08/12		S 6088 NE		
prefilter with fuel oil heater / prefiltro con riscaldatore nafta	D2066 Euro4/5/EEV	265	360	10/07 >	08/12		S 6059 NE		
prefilter without fuel oil heater / prefiltro senza riscaldatore nafta	D2066 Euro4/5/EEV	265	360	10/07 >	08/12		S 6062 NE		
power steering / servosterzo	D2066 Euro4/5/EEV	265	360	10/07 >	08/12				S 3081 PO
TGS 21.420	D2676 CR Euro6	309	420	07/16 >		S 5235 PE	S 6011 NE	S 7F27 A	S 3165 C
with automatic gearbox and hydraulic retarder ZF 16S / con cambio automatico e rallentatore idraulico ZF 16S	D2676 CR Euro6	309	420	07/16 >					S 2234 Z
with air-conditioner / con climatizzatore	D2676 CR Euro6	309	420	07/16 >					S 4177 CA
dryer filter / filtro essiccatore	D2676 CR Euro6	309	420	07/16 >					S 7A66 A
retarder R3500/4100 (TipMatic 12+2) / freno di rallentamento R3500/4100 (TipMatic 12+2)	D2676 CR Euro6	309	420	07/16 >					S 5613 PO
inner / interno	D2676 CR Euro6	309	420	07/16 >				S 7F28 A	
prefilter / prefiltro	D2676 CR Euro6	309	420	07/16 >			S 4035 NR		
prefilter 300 Micron / prefiltro 300 Micron	D2676 CR Euro6	309	420	07/16 >			S 6088 NE		
power steering / servosterzo	D2676 CR Euro6	309	420	07/16 >					S 3081 PO
power steering ZF Servocom RAS-EC / servosterzo ZF Servocom RAS-EC	D2676 CR Euro6	309	420	07/16 >					S 5664 PO
Vehicles for building site / veicoli da cantiere	D2676 CR Euro6	309	420	07/16 >				S 7F29 A	
TGS 21.460	D2676 CR Euro6	338	460	07/16 >		S 5235 PE	S 6011 NE		S 3165 C
with air-conditioner / con climatizzatore	D2676 CR Euro6	338	460	07/16 >					S 4177 CA
dryer filter / filtro essiccatore	D2676 CR Euro6	338	460	07/16 >					S 7A66 A
prefilter / prefiltro	D2676 CR Euro6	338	460	07/16 >			S 4035 NR		
prefilter 300 Micron / prefiltro 300 Micron	D2676 CR Euro6	338	460	07/16 >			S 6088 NE		
power steering / servosterzo	D2676 CR Euro6	338	460	07/16 >					S 3081 PO
power steering ZF Servocom RAS-EC / servosterzo ZF Servocom RAS-EC	D2676 CR Euro6	338	460	07/16 >					S 5664 PO
TGS 21.500	D2676 CR Euro6	368	500	07/16 >		S 5235 PE	S 6011 NE		S 3165 C
with air-conditioner / con climatizzatore	D2676 CR Euro6	368	500	07/16 >					S 4177 CA
dryer filter / filtro essiccatore	D2676 CR Euro6	368	500	07/16 >					S 7A66 A
prefilter / prefiltro	D2676 CR Euro6	368	500	07/16 >			S 4035 NR		
prefilter 300 Micron / prefiltro 300 Micron	D2676 CR Euro6	368	500	07/16 >			S 6088 NE		
power steering / servosterzo	D2676 CR Euro6	368	500	07/16 >					S 3081 PO
power steering ZF Servocom RAS-EC / servosterzo ZF Servocom RAS-EC	D2676 CR Euro6	368	500	07/16 >					S 5664 PO
TGS 24.320	D2066 CR Euro6	235	320	09/12 >	06/16	S 5235 PE	S 6011 NE	S 7619 A	S 3165 C
	D2066 CR Euro6	235	320	07/16 >		S 5235 PE	S 6011 NE	S 7F27 A	S 3165 C
with automatic gearbox and hydraulic retarder ZF 16S / con cambio automatico e rallentatore idraulico ZF 16S	D2066 CR Euro6	235	320	09/12 >					S 2234 Z
with air-conditioner / con climatizzatore	D2066 CR Euro6	235	320	09/12 >					S 4177 CA
dryer filter / filtro essiccatore	D2066 CR Euro6	235	320	09/12 >					S 7A66 A
retarder R3500/4100 (TipMatic 12+2) / freno di rallentamento R3500/4100 (TipMatic 12+2)	D2066 CR Euro6	235	320	07/16 >					S 5613 PO
inner / interno	D2066 CR Euro6	235	320	09/12 >	06/16			S 7616 A	
inner / interno	D2066 CR Euro6	235	320	07/16 >				S 7F28 A	
prefilter / prefiltro	D2066 CR Euro6	235	320	09/12 >			S 4035 NR		
prefilter 300 Micron / prefiltro 300 Micron	D2066 CR Euro6	235	320	09/12 >			S 6088 NE		
power steering / servosterzo	D2066 CR Euro6	235	320	09/12 >					S 3081 PO
power steering ZF Servocom RAS-EC / servosterzo ZF Servocom RAS-EC	D2066 CR Euro6	235	320	09/12 >					S 5664 PO



...MAN - trucks/autocarri

Vehicles for building site / veicoli da cantiere	D2066 CR Euro6	235	320	09/12	>	06/16			S 7E35 A	
Vehicles for building site / veicoli da cantiere	D2066 CR Euro6	235	320	07/16	>				S 7F29 A	
TGS 24.320	D2066 Euro4/5/EEV	235	320	10/07	>	08/12	S 5046 PE	S 6011 NE	S 7619 A	S 3165 C
with air-conditioner / con climatizzatore	D2066 Euro4/5/EEV	235	320	10/07	>	08/12				S 4177 CA
inner / interno	D2066 Euro4/5/EEV	235	320	10/07	>	08/12			S 7616 A	
prefilter 300 Micron / prefilto 300 Micron	D2066 Euro4/5/EEV	235	320	10/07	>	08/12		S 6088 NE		
prefilter with fuel oil heater / prefilto con riscaldatore nafta	D2066 Euro4/5/EEV	235	320	10/07	>	08/12		S 6059 NE		
prefilter without fuel oil heater / prefilto senza riscaldatore nafta	D2066 Euro4/5/EEV	235	320	10/07	>	08/12		S 6062 NE		
power steering / servosterzo	D2066 Euro4/5/EEV	235	320	10/07	>	08/12				S 3081 PO
TGS 24.360	D2066 CR Euro6	265	360	09/12	>	06/16	S 5235 PE	S 6011 NE	S 7619 A	S 3165 C
	D2066 CR Euro6	265	360	07/16	>		S 5235 PE	S 6011 NE	S 7F27 A	S 3165 C
with automatic gearbox and hydraulic retarder ZF 16S / con cambio automatico e rallentatore idraulico ZF 16S	D2066 CR Euro6	265	360	09/12	>					S 2234 Z
with air-conditioner / con climatizzatore	D2066 CR Euro6	265	360	09/12	>					S 4177 CA
retarder R3500/4100 (TipMatic 12+2) / freno di rallentamento R3500/4100 (TipMatic 12+2)	D2066 CR Euro6	265	360	07/16	>					S 5613 PO
inner / interno	D2066 CR Euro6	265	360	09/12	>	06/16			S 7616 A	
inner / interno	D2066 CR Euro6	265	360	07/16	>				S 7F28 A	
prefilter / prefilto	D2066 CR Euro6	265	360	09/12	>			S 4035 NR		
prefilter 300 Micron / prefilto 300 Micron	D2066 CR Euro6	265	360	09/12	>			S 6088 NE		
power steering / servosterzo	D2066 CR Euro6	265	360	09/12	>					S 3081 PO
power steering ZF Servocom RAS-EC / servosterzo ZF Servocom RAS-EC	D2066 CR Euro6	265	360	09/12	>					S 5664 PO
Vehicles for building site / veicoli da cantiere	D2066 CR Euro6	265	360	09/12	>	06/16			S 7E35 A	
Vehicles for building site / veicoli da cantiere	D2066 CR Euro6	265	360	07/16	>				S 7F29 A	
TGS 24.360	D2066 Euro4/5/EEV	265	360	10/07	>	08/12	S 5046 PE	S 6011 NE	S 7619 A	S 3165 C
with air-conditioner / con climatizzatore	D2066 Euro4/5/EEV	265	360	10/07	>	08/12				S 4177 CA
inner / interno	D2066 Euro4/5/EEV	265	360	10/07	>	08/12			S 7616 A	
prefilter 300 Micron / prefilto 300 Micron	D2066 Euro4/5/EEV	265	360	10/07	>	08/12		S 6088 NE		
prefilter with fuel oil heater / prefilto con riscaldatore nafta	D2066 Euro4/5/EEV	265	360	10/07	>	08/12		S 6059 NE		
prefilter without fuel oil heater / prefilto senza riscaldatore nafta	D2066 Euro4/5/EEV	265	360	10/07	>	08/12		S 6062 NE		
power steering / servosterzo	D2066 Euro4/5/EEV	265	360	10/07	>	08/12				S 3081 PO
TGS 24.400	D2066 CR Euro6	294	400	09/12	>		S 5235 PE	S 6011 NE	S 7619 A	S 3165 C
with automatic gearbox and hydraulic retarder ZF 16S / con cambio automatico e rallentatore idraulico ZF 16S	D2066 CR Euro6	294	400	09/12	>					S 2234 Z
with air-conditioner / con climatizzatore	D2066 CR Euro6	294	400	09/12	>					S 4177 CA
inner / interno	D2066 CR Euro6	294	400	09/12	>				S 7616 A	
prefilter / prefilto	D2066 CR Euro6	294	400	09/12	>			S 4035 NR		
prefilter 300 Micron / prefilto 300 Micron	D2066 CR Euro6	294	400	09/12	>			S 6088 NE		
power steering / servosterzo	D2066 CR Euro6	294	400	09/12	>					S 3081 PO
TGS 24.400	D2066 Euro4/5/EEV	294	400	10/07	>	08/12	S 5046 PE	S 6011 NE	S 7619 A	S 3165 C
with air-conditioner / con climatizzatore	D2066 Euro4/5/EEV	294	400	10/07	>	08/12				S 4177 CA
inner / interno	D2066 Euro4/5/EEV	294	400	10/07	>	08/12			S 7616 A	
prefilter with fuel oil heater / prefilto con riscaldatore nafta	D2066 Euro4/5/EEV	294	400	10/07	>	08/12		S 6059 NE		
prefilter without fuel oil heater / prefilto senza riscaldatore nafta	D2066 Euro4/5/EEV	294	400	10/07	>	08/12		S 6062 NE		
power steering / servosterzo	D2066 Euro4/5/EEV	294	400	10/07	>	08/12				S 3081 PO
TGS 24.420	D2676 CR Euro6	309	420	07/16	>		S 5235 PE	S 6011 NE	S 7F27 A	S 3165 C
with automatic gearbox and hydraulic retarder ZF 16S / con cambio automatico e rallentatore idraulico ZF 16S	D2676 CR Euro6	309	420	07/16	>					S 2234 Z
with air-conditioner / con climatizzatore	D2676 CR Euro6	309	420	07/16	>					S 4177 CA
dryer filter / filtro essiccatore	D2676 CR Euro6	309	420	07/16	>					S 7A66 A
retarder R3500/4100 (TipMatic 12+2) / freno di rallentamento R3500/4100 (TipMatic 12+2)	D2676 CR Euro6	309	420	07/16	>					S 5613 PO
inner / interno	D2676 CR Euro6	309	420	07/16	>				S 7F28 A	
prefilter / prefilto	D2676 CR Euro6	309	420	07/16	>			S 4035 NR		
prefilter 300 Micron / prefilto 300 Micron	D2676 CR Euro6	309	420	07/16	>			S 6088 NE		
power steering / servosterzo	D2676 CR Euro6	309	420	07/16	>					S 3081 PO
power steering ZF Servocom RAS-EC / servosterzo ZF Servocom RAS-EC	D2676 CR Euro6	309	420	07/16	>					S 5664 PO
Vehicles for building site / veicoli da cantiere	D2676 CR Euro6	309	420	07/16	>				S 7F29 A	
TGS 24.440	D2066 CR Euro6	324	440	09/12	>		S 5235 PE	S 6011 NE	S 7619 A	S 3165 C
with automatic gearbox and hydraulic retarder ZF 16S / con cambio automatico e rallentatore idraulico ZF 16S	D2066 CR Euro6	324	440	09/12	>					S 2234 Z
with air-conditioner / con climatizzatore	D2066 CR Euro6	324	440	09/12	>					S 4177 CA
inner / interno	D2066 CR Euro6	324	440	09/12	>				S 7616 A	
prefilter / prefilto	D2066 CR Euro6	324	440	09/12	>			S 4035 NR		
prefilter 300 Micron / prefilto 300 Micron	D2066 CR Euro6	324	440	09/12	>			S 6088 NE		
power steering / servosterzo	D2066 CR Euro6	324	440	09/12	>					S 3081 PO
TGS 24.440	D2066 Euro4/5/EEV	324	441	10/07	>	08/12	S 5046 PE	S 6011 NE	S 7619 A	S 3165 C
with air-conditioner / con climatizzatore	D2066 Euro4/5/EEV	324	441	10/07	>	08/12	S 5046 PE	S 6011 NE	S 7619 A	S 4177 CA
inner / interno	D2066 Euro4/5/EEV	324	441	10/07	>	08/12			S 7616 A	
prefilter with fuel oil heater / prefilto con riscaldatore nafta	D2066 Euro4/5/EEV	324	441	10/07	>	08/12		S 6059 NE		
prefilter without fuel oil heater / prefilto senza riscaldatore nafta	D2066 Euro4/5/EEV	324	441	10/07	>	08/12		S 6062 NE		
power steering / servosterzo	D2066 Euro4/5/EEV	324	441	10/07	>	08/12				S 3081 PO
TGS 24.460	D2676 CR Euro6	338	460	07/16	>		S 5235 PE	S 6011 NE		S 3165 C

M

**KW HP****...MAN - trucks/autocarri**

with air-conditioner / con climatizzatore	D2676 CR Euro6	338	460	07/16	>				S 4177 CA
dryer filter / filtro essiccatore	D2676 CR Euro6	338	460	07/16	>				S 7A66 A
prefilter / prefiltro	D2676 CR Euro6	338	460	07/16	>		S 4035 NR		
prefilter 300 Micron / prefiltro 300 Micron	D2676 CR Euro6	338	460	07/16	>		S 6088 NE		
power steering / servosterzo	D2676 CR Euro6	338	460	07/16	>				S 3081 PO
power steering ZF Servocom RAS-EC / servosterzo ZF Servocom RAS-EC	D2676 CR Euro6	338	460	07/16	>				S 5664 PO
TGS 24.480	D2676 CR Euro6	353	480	09/12	>	07/16	S 5235 PE	S 6011 NE	S 7619 A
with automatic gearbox and hydraulic retarder ZF 16S / con cambio automatico e rallentatore idraulico ZF 16S	D2676 CR Euro6	353	480	09/12	>	07/16			S 3165 C
with air-conditioner / con climatizzatore	D2676 CR Euro6	353	480	09/12	>	07/16			S 2234 Z
inner / interno	D2676 CR Euro6	353	480	09/12	>	07/16		S 7616 A	S 4177 CA
prefilter / prefiltro	D2676 CR Euro6	353	480	09/12	>	07/16	S 4035 NR		
prefilter 300 Micron / prefiltro 300 Micron	D2676 CR Euro6	353	480	09/12	>	07/16	S 6088 NE		
power steering / servosterzo	D2676 CR Euro6	353	480	09/12	>	07/16			S 3081 PO
TGS 24.480	D2676 Euro4/5/EEV	353	480	10/07	>	08/12	S 5046 PE	S 6011 NE	S 7619 A
with air-conditioner / con climatizzatore	D2676 Euro4/5/EEV	353	480	10/07	>	08/12	S 5046 PE	S 6011 NE	S 7619 A
inner / interno	D2676 Euro4/5/EEV	353	480	10/07	>	08/12			S 7616 A
prefilter with fuel oil heater / prefiltro con riscaldatore nafta	D2676 Euro4/5/EEV	353	480	10/07	>	08/12		S 6059 NE	
prefilter without fuel oil heater / prefiltro senza riscaldatore nafta	D2676 Euro4/5/EEV	353	480	10/07	>	08/12		S 6062 NE	
power steering / servosterzo	D2676 Euro4/5/EEV	353	480	10/07	>	08/12			S 3081 PO
TGS 24.500	D2676 CR Euro6	368	500	07/16	>		S 5235 PE	S 6011 NE	S 3165 C
with air-conditioner / con climatizzatore	D2676 CR Euro6	368	500	07/16	>				S 4177 CA
dryer filter / filtro essiccatore	D2676 CR Euro6	368	500	07/16	>				S 7A66 A
prefilter / prefiltro	D2676 CR Euro6	368	500	07/16	>		S 4035 NR		
prefilter 300 Micron / prefiltro 300 Micron	D2676 CR Euro6	368	500	07/16	>		S 6088 NE		
power steering / servosterzo	D2676 CR Euro6	368	500	07/16	>				S 3081 PO
power steering ZF Servocom RAS-EC / servosterzo ZF Servocom RAS-EC	D2676 CR Euro6	368	500	07/16	>				S 5664 PO
TGS 24.540	D2676 Euro4/5/EEV	397	540	10/07	>	08/12	S 5046 PE	S 6011 NE	S 7619 A
with air-conditioner / con climatizzatore	D2676 Euro4/5/EEV	397	540	10/07	>	08/12			S 3165 C
inner / interno	D2676 Euro4/5/EEV	397	540	10/07	>	08/12		S 7616 A	S 4177 CA
prefilter with fuel oil heater / prefiltro con riscaldatore nafta	D2676 Euro4/5/EEV	397	540	10/07	>	08/12		S 6059 NE	
prefilter without fuel oil heater / prefiltro senza riscaldatore nafta	D2676 Euro4/5/EEV	397	540	10/07	>	08/12		S 6062 NE	
power steering / servosterzo	D2676 Euro4/5/EEV	397	540	10/07	>	08/12			S 3081 PO
TGS 26.320	D2066 CR Euro6	235	320	09/12	>	06/16	S 5235 PE	S 6011 NE	S 7619 A
	D2066 CR Euro6	235	320	07/16	>		S 5235 PE	S 6011 NE	S 7F27 A
with automatic gearbox and hydraulic retarder ZF 16S / con cambio automatico e rallentatore idraulico ZF 16S	D2066 CR Euro6	235	320	09/12	>				S 3165 C
with air-conditioner / con climatizzatore	D2066 CR Euro6	235	320	09/12	>				S 2234 Z
dryer filter / filtro essiccatore	D2066 CR Euro6	235	320	09/12	>				S 4177 CA
retarder R3500/4100 (TipMatic 12+2) / freno di rallentamento R3500/4100 (TipMatic 12+2)	D2066 CR Euro6	235	320	07/16	>				S 7A66 A
inner / interno	D2066 CR Euro6	235	320	09/12	>	06/16		S 7616 A	S 5613 PO
inner / interno	D2066 CR Euro6	235	320	07/16	>			S 7F28 A	
prefilter / prefiltro	D2066 CR Euro6	235	320	09/12	>		S 4035 NR		
prefilter 300 Micron / prefiltro 300 Micron	D2066 CR Euro6	235	320	09/12	>		S 6088 NE		
power steering / servosterzo	D2066 CR Euro6	235	320	09/12	>				S 3081 PO
power steering ZF Servocom RAS-EC / servosterzo ZF Servocom RAS-EC	D2066 CR Euro6	235	320	09/12	>				S 5664 PO
Vehicles for building site / veicoli da cantiere	D2066 CR Euro6	235	320	09/12	>	06/16			S 7E35 A
Vehicles for building site / veicoli da cantiere	D2066 CR Euro6	235	320	07/16	>				S 7F29 A
TGS 26.320	D2066 Euro4/5/EEV	235	320	10/07	>	08/12	S 5046 PE	S 6011 NE	S 7619 A
with air-conditioner / con climatizzatore	D2066 Euro4/5/EEV	235	320	10/07	>	08/12			S 3165 C
inner / interno	D2066 Euro4/5/EEV	235	320	10/07	>	08/12			S 4177 CA
prefilter 300 Micron / prefiltro 300 Micron	D2066 Euro4/5/EEV	235	320	10/07	>	08/12		S 7616 A	
prefilter with fuel oil heater / prefiltro con riscaldatore nafta	D2066 Euro4/5/EEV	235	320	10/07	>	08/12		S 6088 NE	
prefilter without fuel oil heater / prefiltro senza riscaldatore nafta	D2066 Euro4/5/EEV	235	320	10/07	>	08/12		S 6059 NE	
power steering / servosterzo	D2066 Euro4/5/EEV	235	320	10/07	>	08/12		S 6062 NE	
TGS 26.350	D2066 CR Euro6	257	349	09/12	>		S 5235 PE	S 6011 NE	S 7619 A
with automatic gearbox and hydraulic retarder ZF 16S / con cambio automatico e rallentatore idraulico ZF 16S	D2066 CR Euro6	257	349	09/12	>				S 3165 C
with air-conditioner / con climatizzatore	D2066 CR Euro6	257	349	09/12	>				S 2234 Z
retarder R3500/4100 (TipMatic 12+2) / freno di rallentamento R3500/4100 (TipMatic 12+2)	D2066 CR Euro6	257	349	09/12	>				S 4177 CA
inner / interno	D2066 CR Euro6	257	349	09/12	>			S 7616 A	S 5613 PO
prefilter / prefiltro	D2066 CR Euro6	257	349	09/12	>		S 4035 NR		
prefilter 300 Micron / prefiltro 300 Micron	D2066 CR Euro6	257	349	09/12	>		S 6088 NE		
power steering / servosterzo	D2066 CR Euro6	257	349	09/12	>				S 3081 PO
power steering ZF Servocom RAS-EC / servosterzo ZF Servocom RAS-EC	D2066 CR Euro6	257	349	09/12	>				S 5664 PO
Vehicles for building site / veicoli da cantiere	D2066 CR Euro6	257	349	09/12	>				S 7E35 A
TGS 26.350	D2066 Euro4/5/EEV	257	349	10/07	>	08/12	S 5046 PE	S 6011 NE	S 7619 A
with air-conditioner / con climatizzatore	D2066 Euro4/5/EEV	257	349	10/07	>	08/12			S 3165 C
inner / interno	D2066 Euro4/5/EEV	257	349	10/07	>	08/12			S 4177 CA
prefilter 300 Micron / prefiltro 300 Micron	D2066 Euro4/5/EEV	257	349	10/07	>	08/12		S 7616 A	
							S 6088 NE		

**KW HP****...MAN - trucks/autocarri**

prefilter with fuel oil heater / prefiltro con riscaldatore nafta	D2066 Euro4/5/EEV	257	349	10/07 >	08/12		S 6059 NE		
prefilter without fuel oil heater / prefiltro senza riscaldatore nafta	D2066 Euro4/5/EEV	257	349	10/07 >	08/12		S 6062 NE		
power steering / servosterzo	D2066 Euro4/5/EEV	257	349	10/07 >	08/12				S 3081 PO
TGS 26.360	D2066 CR Euro6	265	360	09/12 >	06/16	S 5235 PE	S 6011 NE	S 7619 A	S 3165 C
	D2066 CR Euro6	265	360	07/16 >		S 5235 PE	S 6011 NE	S 7F27 A	S 3165 C
with automatic gearbox and hydraulic retarder ZF 16S / con cambio automatico e rallentatore idraulico ZF 16S	D2066 CR Euro6	265	360	09/12 >					S 2234 Z
with air-conditioner / con climatizzatore	D2066 CR Euro6	265	360	09/12 >					S 4177 CA
retarder R3500/4100 (TipMatic 12+2) / freno di rallentamento R3500/4100 (TipMatic 12+2)	D2066 CR Euro6	265	360	07/16 >					S 5613 PO
inner / interno	D2066 CR Euro6	265	360	09/12 >	06/16			S 7616 A	
inner / interno	D2066 CR Euro6	265	360	07/16 >				S 7F28 A	
prefilter / prefiltro	D2066 CR Euro6	265	360	09/12 >			S 4035 NR		
prefilter 300 Micron / prefiltro 300 Micron	D2066 CR Euro6	265	360	09/12 >			S 6088 NE		
power steering / servosterzo	D2066 CR Euro6	265	360	09/12 >					S 3081 PO
power steering ZF Servocom RAS-EC / servosterzo ZF Servocom RAS-EC	D2066 CR Euro6	265	360	09/12 >					S 5664 PO
Vehicles for building site / veicoli da cantiere	D2066 CR Euro6	265	360	09/12 >	06/16			S 7E35 A	
Vehicles for building site / veicoli da cantiere	D2066 CR Euro6	265	360	07/16 >				S 7F29 A	
TGS 26.360	D2066 Euro4/5/EEV	265	360	10/07 >	08/12	S 5046 PE	S 6011 NE	S 7619 A	S 3165 C
with air-conditioner / con climatizzatore	D2066 Euro4/5/EEV	265	360	10/07 >	08/12				S 4177 CA
inner / interno	D2066 Euro4/5/EEV	265	360	10/07 >	08/12			S 7616 A	
prefilter 300 Micron / prefiltro 300 Micron	D2066 Euro4/5/EEV	265	360	10/07 >	08/12		S 6088 NE		
prefilter with fuel oil heater / prefiltro con riscaldatore nafta	D2066 Euro4/5/EEV	265	360	10/07 >	08/12		S 6059 NE		
prefilter without fuel oil heater / prefiltro senza riscaldatore nafta	D2066 Euro4/5/EEV	265	360	10/07 >	08/12		S 6062 NE		
power steering / servosterzo	D2066 Euro4/5/EEV	265	360	10/07 >	08/12				S 3081 PO
TGS 26.390	D2066 CR Euro6	287	390	09/12 >	06/16	S 5235 PE	S 6011 NE	S 7619 A	S 3165 C
with automatic gearbox and hydraulic retarder ZF 16S / con cambio automatico e rallentatore idraulico ZF 16S	D2066 CR Euro6	287	390	09/12 >	06/16				S 2234 Z
with air-conditioner / con climatizzatore	D2066 CR Euro6	287	390	09/12 >	06/16				S 4177 CA
retarder R3500/4100 (TipMatic 12+2) / freno di rallentamento R3500/4100 (TipMatic 12+2)	D2066 CR Euro6	287	390	09/12 >	06/16				S 5613 PO
inner / interno	D2066 CR Euro6	287	390	09/12 >	06/16			S 7616 A	
prefilter / prefiltro	D2066 CR Euro6	287	390	09/12 >	06/16		S 4035 NR		
prefilter 300 Micron / prefiltro 300 Micron	D2066 CR Euro6	287	390	09/12 >	06/16		S 6088 NE		
power steering / servosterzo	D2066 CR Euro6	287	390	09/12 >	06/16				S 3081 PO
power steering ZF Servocom RAS-EC / servosterzo ZF Servocom RAS-EC	D2066 CR Euro6	287	390	09/12 >	06/16				S 5664 PO
Vehicles for building site / veicoli da cantiere	D2066 CR Euro6	287	390	09/12 >	06/16			S 7E35 A	
TGS 26.390	D2066 Euro4/5/EEV	287	390	06/08 >	08/12	S 5046 PE	S 6011 NE	S 7619 A	S 3165 C
with air-conditioner / con climatizzatore	D2066 Euro4/5/EEV	287	390	06/08 >	08/12				S 4177 CA
inner / interno	D2066 Euro4/5/EEV	287	390	06/08 >	08/12			S 7616 A	
prefilter 300 Micron / prefiltro 300 Micron	D2066 Euro4/5/EEV	287	390	06/08 >	08/12		S 6088 NE		
prefilter with fuel oil heater / prefiltro con riscaldatore nafta	D2066 Euro4/5/EEV	287	390	06/08 >	08/12		S 6059 NE		
prefilter without fuel oil heater / prefiltro senza riscaldatore nafta	D2066 Euro4/5/EEV	287	390	06/08 >	08/12		S 6062 NE		
power steering / servosterzo	D2066 Euro4/5/EEV	287	390	06/08 >	08/12				S 3081 PO
TGS 26.400	D2066 CR Euro6	294	400	09/12 >		S 5235 PE	S 6011 NE	S 7619 A	S 3165 C
with automatic gearbox and hydraulic retarder ZF 16S / con cambio automatico e rallentatore idraulico ZF 16S	D2066 CR Euro6	294	400	09/12 >					S 2234 Z
with air-conditioner / con climatizzatore	D2066 CR Euro6	294	400	09/12 >					S 4177 CA
inner / interno	D2066 CR Euro6	294	400	09/12 >				S 7616 A	
prefilter / prefiltro	D2066 CR Euro6	294	400	09/12 >			S 4035 NR		
prefilter 300 Micron / prefiltro 300 Micron	D2066 CR Euro6	294	400	09/12 >			S 6088 NE		
power steering / servosterzo	D2066 CR Euro6	294	400	09/12 >					S 3081 PO
TGS 26.400	D2066 Euro4/5/EEV	294	400	10/07 >	08/12	S 5046 PE	S 6011 NE	S 7619 A	S 3165 C
with air-conditioner / con climatizzatore	D2066 Euro4/5/EEV	294	400	10/07 >	08/12				S 4177 CA
inner / interno	D2066 Euro4/5/EEV	294	400	10/07 >	08/12			S 7616 A	
prefilter with fuel oil heater / prefiltro con riscaldatore nafta	D2066 Euro4/5/EEV	294	400	10/07 >	08/12		S 6059 NE		
prefilter without fuel oil heater / prefiltro senza riscaldatore nafta	D2066 Euro4/5/EEV	294	400	10/07 >	08/12		S 6062 NE		
power steering / servosterzo	D2066 Euro4/5/EEV	294	400	10/07 >	08/12				S 3081 PO
TGS 26.420	D2676 CR Euro6	309	420	07/16 >		S 5235 PE	S 6011 NE	S 7F27 A	S 3165 C
with automatic gearbox and hydraulic retarder ZF 16S / con cambio automatico e rallentatore idraulico ZF 16S	D2676 CR Euro6	309	420	07/16 >					S 2234 Z
with air-conditioner / con climatizzatore	D2676 CR Euro6	309	420	07/16 >					S 4177 CA
dryer filter / filtro essiccatore	D2676 CR Euro6	309	420	07/16 >					S 7A66 A
retarder R3500/4100 (TipMatic 12+2) / freno di rallentamento R3500/4100 (TipMatic 12+2)	D2676 CR Euro6	309	420	07/16 >					S 5613 PO
inner / interno	D2676 CR Euro6	309	420	07/16 >				S 7F28 A	
prefilter / prefiltro	D2676 CR Euro6	309	420	07/16 >			S 4035 NR		
prefilter 300 Micron / prefiltro 300 Micron	D2676 CR Euro6	309	420	07/16 >			S 6088 NE		
power steering / servosterzo	D2676 CR Euro6	309	420	07/16 >					S 3081 PO
power steering ZF Servocom RAS-EC / servosterzo ZF Servocom RAS-EC	D2676 CR Euro6	309	420	07/16 >					S 5664 PO
Vehicles for building site / veicoli da cantiere	D2676 CR Euro6	309	420	07/16 >				S 7F29 A	
TGS 26.430	D2066 CR Euro6	316	430	09/12 >	06/16	S 5235 PE	S 6011 NE	S 7619 A	S 3165 C
with automatic gearbox and hydraulic retarder ZF 16S / con cambio automatico e rallentatore idraulico ZF 16S	D2066 CR Euro6	316	430	09/12 >	06/16				S 2234 Z
with air-conditioner / con climatizzatore	D2066 CR Euro6	316	430	09/12 >	06/16				S 4177 CA

M

**KW HP****...MAN - trucks/autocarri**

retarder R3500/4100 (TipMatic 12+2) / freno di rallentamento R3500/4100 (TipMatic 12+2)	D2066 CR Euro6	316	430	09/12 >	06/16				S 5613 PO
inner / interno	D2066 CR Euro6	316	430	09/12 >	06/16				
prefilter / prefiltro	D2066 CR Euro6	316	430	09/12 >	06/16		S 4035 NR	S 7616 A	
prefilter 300 Micron / prefiltro 300 Micron	D2066 CR Euro6	316	430	09/12 >	06/16		S 6088 NE		
power steering / servosterzo	D2066 CR Euro6	316	430	09/12 >	06/16				S 3081 PO
power steering ZF Servocom RAS-EC / servosterzo ZF Servocom RAS-EC	D2066 CR Euro6	316	430	09/12 >	06/16				S 5664 PO
Vehicles for building site / veicoli da cantiere	D2066 CR Euro6	316	430	09/12 >	06/16			S 7E35 A	
TGS 26.430	D2066 Euro4/5/EEV	316	430	06/08 >	08/12	S 5046 PE	S 6011 NE	S 7619 A	S 3165 C
with air-conditioner / con climatizzatore	D2066 Euro4/5/EEV	316	430	06/08 >	08/12				S 4177 CA
inner / interno	D2066 Euro4/5/EEV	316	430	06/08 >	08/12			S 7616 A	
prefilter 300 Micron / prefiltro 300 Micron	D2066 Euro4/5/EEV	316	430	06/08 >	08/12		S 6088 NE		
prefilter with fuel oil heater / prefiltro con riscaldatore nafta	D2066 Euro4/5/EEV	316	430	06/08 >	08/12		S 6059 NE		
prefilter without fuel oil heater / prefiltro senza riscaldatore nafta	D2066 Euro4/5/EEV	316	430	06/08 >	08/12		S 6062 NE		
power steering / servosterzo	D2066 Euro4/5/EEV	316	430	06/08 >	08/12				S 3081 PO
TGS 26.440	D2066 CR Euro6	324	440	09/12 >		S 5235 PE	S 6011 NE	S 7619 A	S 3165 C
with automatic gearbox and hydraulic retarder ZF 16S / con cambio automatico e rallentatore idraulico ZF 16S	D2066 CR Euro6	324	440	09/12 >					S 2234 Z
with air-conditioner / con climatizzatore	D2066 CR Euro6	324	440	09/12 >				S 7616 A	S 4177 CA
inner / interno	D2066 CR Euro6	324	440	09/12 >					
prefilter / prefiltro	D2066 CR Euro6	324	440	09/12 >			S 4035 NR		
prefilter 300 Micron / prefiltro 300 Micron	D2066 CR Euro6	324	440	09/12 >			S 6088 NE		
power steering / servosterzo	D2066 CR Euro6	324	440	09/12 >					S 3081 PO
TGS 26.440	D2066 Euro4/5/EEV	324	441	10/07 >	08/12	S 5046 PE	S 6011 NE	S 7619 A	S 3165 C
with air-conditioner / con climatizzatore	D2066 Euro4/5/EEV	324	441	10/07 >	08/12	S 5046 PE	S 6011 NE	S 7619 A	S 4177 CA
inner / interno	D2066 Euro4/5/EEV	324	441	10/07 >	08/12			S 7616 A	
prefilter with fuel oil heater / prefiltro con riscaldatore nafta	D2066 Euro4/5/EEV	324	441	10/07 >	08/12		S 6059 NE		
prefilter without fuel oil heater / prefiltro senza riscaldatore nafta	D2066 Euro4/5/EEV	324	441	10/07 >	08/12		S 6062 NE		
power steering / servosterzo	D2066 Euro4/5/EEV	324	441	10/07 >	08/12				S 3081 PO
TGS 26.460	D2676 CR Euro6	338	460	07/16 >		S 5235 PE	S 6011 NE		S 3165 C
with air-conditioner / con climatizzatore	D2676 CR Euro6	338	460	07/16 >					S 4177 CA
dryer filter / filtro essiccatore	D2676 CR Euro6	338	460	07/16 >					S 7A66 A
prefilter / prefiltro	D2676 CR Euro6	338	460	07/16 >			S 4035 NR		
prefilter 300 Micron / prefiltro 300 Micron	D2676 CR Euro6	338	460	07/16 >			S 6088 NE		
power steering / servosterzo	D2676 CR Euro6	338	460	07/16 >					S 3081 PO
power steering ZF Servocom RAS-EC / servosterzo ZF Servocom RAS-EC	D2676 CR Euro6	338	460	07/16 >					S 5664 PO
TGS 26.480	D2676 CR Euro6	353	480	09/12 >	07/16	S 5235 PE	S 6011 NE	S 7619 A	S 3165 C
with automatic gearbox and hydraulic retarder ZF 16S / con cambio automatico e rallentatore idraulico ZF 16S	D2676 CR Euro6	353	480	09/12 >	07/16				S 2234 Z
with air-conditioner / con climatizzatore	D2676 CR Euro6	353	480	09/12 >	07/16				S 4177 CA
inner / interno	D2676 CR Euro6	353	480	09/12 >	07/16			S 7616 A	
prefilter / prefiltro	D2676 CR Euro6	353	480	09/12 >	07/16		S 4035 NR		
prefilter 300 Micron / prefiltro 300 Micron	D2676 CR Euro6	353	480	09/12 >	07/16		S 6088 NE		
power steering / servosterzo	D2676 CR Euro6	353	480	09/12 >	07/16				S 3081 PO
TGS 26.480	D2676 Euro4/5/EEV	353	480	10/07 >	08/12	S 5046 PE	S 6011 NE	S 7619 A	S 3165 C
with air-conditioner / con climatizzatore	D2676 Euro4/5/EEV	353	480	10/07 >	08/12				S 4177 CA
inner / interno	D2676 Euro4/5/EEV	353	480	10/07 >	08/12			S 7616 A	
prefilter with fuel oil heater / prefiltro con riscaldatore nafta	D2676 Euro4/5/EEV	353	480	10/07 >	08/12		S 6059 NE		
prefilter without fuel oil heater / prefiltro senza riscaldatore nafta	D2676 Euro4/5/EEV	353	480	10/07 >	08/12		S 6062 NE		
power steering / servosterzo	D2676 Euro4/5/EEV	353	480	10/07 >	08/12				S 3081 PO
TGS 26.500	D2676 CR Euro6	368	500	07/16 >		S 5235 PE	S 6011 NE		S 3165 C
with air-conditioner / con climatizzatore	D2676 CR Euro6	368	500	07/16 >					S 4177 CA
dryer filter / filtro essiccatore	D2676 CR Euro6	368	500	07/16 >					S 7A66 A
prefilter / prefiltro	D2676 CR Euro6	368	500	07/16 >			S 4035 NR		
prefilter 300 Micron / prefiltro 300 Micron	D2676 CR Euro6	368	500	07/16 >			S 6088 NE		
power steering / servosterzo	D2676 CR Euro6	368	500	07/16 >					S 3081 PO
power steering ZF Servocom RAS-EC / servosterzo ZF Servocom RAS-EC	D2676 CR Euro6	368	500	07/16 >					S 5664 PO
TGS 26.540	D2676 Euro4/5/EEV	397	540	10/07 >	08/12	S 5046 PE	S 6011 NE	S 7619 A	S 3165 C
with air-conditioner / con climatizzatore	D2676 Euro4/5/EEV	397	540	10/07 >	08/12				S 4177 CA
inner / interno	D2676 Euro4/5/EEV	397	540	10/07 >	08/12			S 7616 A	
prefilter with fuel oil heater / prefiltro con riscaldatore nafta	D2676 Euro4/5/EEV	397	540	10/07 >	08/12		S 6059 NE		
prefilter without fuel oil heater / prefiltro senza riscaldatore nafta	D2676 Euro4/5/EEV	397	540	10/07 >	08/12		S 6062 NE		
power steering / servosterzo	D2676 Euro4/5/EEV	397	540	10/07 >	08/12				S 3081 PO
TGS 28.320	D2066 CR Euro6	235	320	09/12 >	06/16	S 5235 PE	S 6011 NE	S 7619 A	S 3165 C
	D2066 CR Euro6	235	320	07/16 >		S 5235 PE	S 6011 NE	S 7F27 A	S 3165 C
with automatic gearbox and hydraulic retarder ZF 16S / con cambio automatico e rallentatore idraulico ZF 16S	D2066 CR Euro6	235	320	09/12 >					S 2234 Z
with air-conditioner / con climatizzatore	D2066 CR Euro6	235	320	09/12 >					S 4177 CA
dryer filter / filtro essiccatore	D2066 CR Euro6	235	320	09/12 >					S 7A66 A
retarder R3500/4100 (TipMatic 12+2) / freno di rallentamento R3500/4100 (TipMatic 12+2)	D2066 CR Euro6	235	320	07/16 >					S 5613 PO
inner / interno	D2066 CR Euro6	235	320	09/12 >	06/16			S 7616 A	

**KW HP****...MAN - trucks/autocarri**

inner / interno	D2066 CR Euro6	235	320	07/16	>			S 7F28 A	
prefilter / prefiltro	D2066 CR Euro6	235	320	09/12	>		S 4035 NR		
prefilter 300 Micron / prefiltro 300 Micron	D2066 CR Euro6	235	320	09/12	>		S 6088 NE		
power steering / servosterzo	D2066 CR Euro6	235	320	09/12	>				S 3081 PO
power steering ZF Servocom RAS-EC / servosterzo ZF Servocom RAS-EC	D2066 CR Euro6	235	320	09/12	>				S 5664 PO
Vehicles for building site / veicoli da cantiere	D2066 CR Euro6	235	320	09/12	>	06/16		S 7E35 A	
Vehicles for building site / veicoli da cantiere	D2066 CR Euro6	235	320	07/16	>			S 7F29 A	
TGS 28.320	D2066 Euro4/5/EEV	235	320	10/07	>	08/12	S 5046 PE	S 6011 NE	S 7619 A
with air-conditioner / con climatizzatore	D2066 Euro4/5/EEV	235	320	10/07	>	08/12			S 3165 C
inner / interno	D2066 Euro4/5/EEV	235	320	10/07	>	08/12		S 7616 A	S 4177 CA
prefilter 300 Micron / prefiltro 300 Micron	D2066 Euro4/5/EEV	235	320	10/07	>	08/12		S 6088 NE	
prefilter with fuel oil heater / prefiltro con riscaldatore nafta	D2066 Euro4/5/EEV	235	320	10/07	>	08/12		S 6059 NE	
prefilter without fuel oil heater / prefiltro senza riscaldatore nafta	D2066 Euro4/5/EEV	235	320	10/07	>	08/12		S 6062 NE	
power steering / servosterzo	D2066 Euro4/5/EEV	235	320	10/07	>	08/12			S 3081 PO
TGS 28.350	D2066 CR Euro6	257	349	09/12	>		S 5235 PE	S 6011 NE	S 7619 A
with automatic gearbox and hydraulic retarder ZF 16S / con cambio automatico e rallentatore idraulico ZF 16S	D2066 CR Euro6	257	349	09/12	>				S 2234 Z
with air-conditioner / con climatizzatore	D2066 CR Euro6	257	349	09/12	>				S 4177 CA
retarder R3500/4100 (TipMatic 12+2) / freno di rallentamento R3500/4100 (TipMatic 12+2)	D2066 CR Euro6	257	349	09/12	>				S 5613 PO
inner / interno	D2066 CR Euro6	257	349	09/12	>			S 7616 A	
prefilter / prefiltro	D2066 CR Euro6	257	349	09/12	>		S 4035 NR		
prefilter 300 Micron / prefiltro 300 Micron	D2066 CR Euro6	257	349	09/12	>		S 6088 NE		
power steering / servosterzo	D2066 CR Euro6	257	349	09/12	>				S 3081 PO
power steering ZF Servocom RAS-EC / servosterzo ZF Servocom RAS-EC	D2066 CR Euro6	257	349	09/12	>				S 5664 PO
Vehicles for building site / veicoli da cantiere	D2066 CR Euro6	257	349	09/12	>			S 7E35 A	
TGS 28.350	D2066 Euro4/5/EEV	257	349	10/07	>	08/12	S 5046 PE	S 6011 NE	S 7619 A
with air-conditioner / con climatizzatore	D2066 Euro4/5/EEV	257	349	10/07	>	08/12			S 4177 CA
inner / interno	D2066 Euro4/5/EEV	257	349	10/07	>	08/12		S 7616 A	
prefilter 300 Micron / prefiltro 300 Micron	D2066 Euro4/5/EEV	257	349	10/07	>	08/12		S 6088 NE	
prefilter with fuel oil heater / prefiltro con riscaldatore nafta	D2066 Euro4/5/EEV	257	349	10/07	>	08/12		S 6059 NE	
prefilter without fuel oil heater / prefiltro senza riscaldatore nafta	D2066 Euro4/5/EEV	257	349	10/07	>	08/12		S 6062 NE	
power steering / servosterzo	D2066 Euro4/5/EEV	257	349	10/07	>	08/12			S 3081 PO
TGS 28.360	D2066 CR Euro6	265	360	09/12	>	06/16	S 5235 PE	S 6011 NE	S 7619 A
	D2066 CR Euro6	265	360	07/16	>		S 5235 PE	S 6011 NE	S 7F27 A
with automatic gearbox and hydraulic retarder ZF 16S / con cambio automatico e rallentatore idraulico ZF 16S	D2066 CR Euro6	265	360	09/12	>				S 2234 Z
with air-conditioner / con climatizzatore	D2066 CR Euro6	265	360	09/12	>				S 4177 CA
retarder R3500/4100 (TipMatic 12+2) / freno di rallentamento R3500/4100 (TipMatic 12+2)	D2066 CR Euro6	265	360	07/16	>				S 5613 PO
inner / interno	D2066 CR Euro6	265	360	09/12	>	06/16		S 7616 A	
inner / interno	D2066 CR Euro6	265	360	07/16	>			S 7F28 A	
prefilter / prefiltro	D2066 CR Euro6	265	360	09/12	>		S 4035 NR		
prefilter 300 Micron / prefiltro 300 Micron	D2066 CR Euro6	265	360	09/12	>		S 6088 NE		
power steering / servosterzo	D2066 CR Euro6	265	360	09/12	>				S 3081 PO
power steering ZF Servocom RAS-EC / servosterzo ZF Servocom RAS-EC	D2066 CR Euro6	265	360	09/12	>				S 5664 PO
Vehicles for building site / veicoli da cantiere	D2066 CR Euro6	265	360	09/12	>	06/16		S 7E35 A	
Vehicles for building site / veicoli da cantiere	D2066 CR Euro6	265	360	07/16	>			S 7F29 A	
TGS 28.360	D2066 Euro4/5/EEV	265	360	10/07	>	08/12	S 5046 PE	S 6011 NE	S 7619 A
with air-conditioner / con climatizzatore	D2066 Euro4/5/EEV	265	360	10/07	>	08/12			S 4177 CA
inner / interno	D2066 Euro4/5/EEV	265	360	10/07	>	08/12		S 7616 A	
prefilter 300 Micron / prefiltro 300 Micron	D2066 Euro4/5/EEV	265	360	10/07	>	08/12		S 6088 NE	
prefilter with fuel oil heater / prefiltro con riscaldatore nafta	D2066 Euro4/5/EEV	265	360	10/07	>	08/12		S 6059 NE	
prefilter without fuel oil heater / prefiltro senza riscaldatore nafta	D2066 Euro4/5/EEV	265	360	10/07	>	08/12		S 6062 NE	
power steering / servosterzo	D2066 Euro4/5/EEV	265	360	10/07	>	08/12			S 3081 PO
TGS 28.390	D2066 CR Euro6	287	390	09/12	>	06/16	S 5235 PE	S 6011 NE	S 7619 A
with automatic gearbox and hydraulic retarder ZF 16S / con cambio automatico e rallentatore idraulico ZF 16S	D2066 CR Euro6	287	390	09/12	>	06/16			S 2234 Z
with air-conditioner / con climatizzatore	D2066 CR Euro6	287	390	09/12	>	06/16			S 4177 CA
retarder R3500/4100 (TipMatic 12+2) / freno di rallentamento R3500/4100 (TipMatic 12+2)	D2066 CR Euro6	287	390	09/12	>	06/16			S 5613 PO
inner / interno	D2066 CR Euro6	287	390	09/12	>	06/16		S 7616 A	
prefilter / prefiltro	D2066 CR Euro6	287	390	09/12	>	06/16		S 4035 NR	
prefilter 300 Micron / prefiltro 300 Micron	D2066 CR Euro6	287	390	09/12	>	06/16		S 6088 NE	
power steering / servosterzo	D2066 CR Euro6	287	390	09/12	>	06/16			S 3081 PO
power steering ZF Servocom RAS-EC / servosterzo ZF Servocom RAS-EC	D2066 CR Euro6	287	390	09/12	>	06/16			S 5664 PO
Vehicles for building site / veicoli da cantiere	D2066 CR Euro6	287	390	09/12	>	06/16		S 7E35 A	
TGS 28.390	D2066 Euro4/5/EEV	287	390	06/08	>	08/12	S 5046 PE	S 6011 NE	S 7619 A
with air-conditioner / con climatizzatore	D2066 Euro4/5/EEV	287	390	06/08	>	08/12			S 4177 CA
inner / interno	D2066 Euro4/5/EEV	287	390	06/08	>	08/12		S 7616 A	
prefilter 300 Micron / prefiltro 300 Micron	D2066 Euro4/5/EEV	287	390	06/08	>	08/12		S 6088 NE	
prefilter with fuel oil heater / prefiltro con riscaldatore nafta	D2066 Euro4/5/EEV	287	390	06/08	>	08/12		S 6059 NE	
prefilter without fuel oil heater / prefiltro senza riscaldatore nafta	D2066 Euro4/5/EEV	287	390	06/08	>	08/12		S 6062 NE	

M

**KW HP****...MAN - trucks/autocarri**

power steering / servosterzo	D2066 Euro4/5/EEV	287	390	06/08	>	08/12				S 3081 PO
TGS 28.400	D2066 CR Euro6	294	400	09/12	>		S 5235 PE	S 6011 NE	S 7619 A	S 3165 C
with automatic gearbox and hydraulic retarder ZF 16S / con cambio automatico e rallentatore idraulico ZF 16S	D2066 CR Euro6	294	400	09/12	>					S 2234 Z
with air-conditioner / con climatizzatore	D2066 CR Euro6	294	400	09/12	>					S 4177 CA
inner / interno	D2066 CR Euro6	294	400	09/12	>				S 7616 A	
prefilter / prefiltro	D2066 CR Euro6	294	400	09/12	>			S 4035 NR		
prefilter 300 Micron / prefiltro 300 Micron	D2066 CR Euro6	294	400	09/12	>			S 6088 NE		
power steering / servosterzo	D2066 CR Euro6	294	400	09/12	>					S 3081 PO
TGS 28.400	D2066 Euro4/5/EEV	294	400	10/07	>	08/12	S 5046 PE	S 6011 NE	S 7619 A	S 3165 C
with air-conditioner / con climatizzatore	D2066 Euro4/5/EEV	294	400	10/07	>	08/12				S 4177 CA
inner / interno	D2066 Euro4/5/EEV	294	400	10/07	>	08/12			S 7616 A	
prefilter with fuel oil heater / prefiltro con riscaldatore nafta	D2066 Euro4/5/EEV	294	400	10/07	>	08/12		S 6059 NE		
prefilter without fuel oil heater / prefiltro senza riscaldatore nafta	D2066 Euro4/5/EEV	294	400	10/07	>	08/12		S 6062 NE		
power steering / servosterzo	D2066 Euro4/5/EEV	294	400	10/07	>	08/12				S 3081 PO
TGS 28.420	D2676 CR Euro6	309	420	07/16	>		S 5235 PE	S 6011 NE	S 7F27 A	S 3165 C
with automatic gearbox and hydraulic retarder ZF 16S / con cambio automatico e rallentatore idraulico ZF 16S	D2676 CR Euro6	309	420	07/16	>					S 2234 Z
with air-conditioner / con climatizzatore	D2676 CR Euro6	309	420	07/16	>					S 4177 CA
dryer filter / filtro essiccatore	D2676 CR Euro6	309	420	07/16	>					S 7A66 A
retarder R3500/4100 (TipMatic 12+2) / freno di rallentamento R3500/4100 (TipMatic 12+2)	D2676 CR Euro6	309	420	07/16	>					S 5613 PO
inner / interno	D2676 CR Euro6	309	420	07/16	>				S 7F28 A	
prefilter / prefiltro	D2676 CR Euro6	309	420	07/16	>			S 4035 NR		
prefilter 300 Micron / prefiltro 300 Micron	D2676 CR Euro6	309	420	07/16	>			S 6088 NE		
power steering / servosterzo	D2676 CR Euro6	309	420	07/16	>					S 3081 PO
power steering ZF Servocom RAS-EC / servosterzo ZF Servocom RAS-EC	D2676 CR Euro6	309	420	07/16	>					S 5664 PO
Vehicles for building site / veicoli da cantiere	D2676 CR Euro6	309	420	07/16	>				S 7F29 A	
TGS 28.430	D2066 CR Euro6	316	430	09/12	>	06/16	S 5235 PE	S 6011 NE	S 7619 A	S 3165 C
with automatic gearbox and hydraulic retarder ZF 16S / con cambio automatico e rallentatore idraulico ZF 16S	D2066 CR Euro6	316	430	09/12	>	06/16				S 2234 Z
with air-conditioner / con climatizzatore	D2066 CR Euro6	316	430	09/12	>	06/16				S 4177 CA
retarder R3500/4100 (TipMatic 12+2) / freno di rallentamento R3500/4100 (TipMatic 12+2)	D2066 CR Euro6	316	430	09/12	>	06/16				S 5613 PO
inner / interno	D2066 CR Euro6	316	430	09/12	>	06/16			S 7616 A	
prefilter / prefiltro	D2066 CR Euro6	316	430	09/12	>	06/16		S 4035 NR		
prefilter 300 Micron / prefiltro 300 Micron	D2066 CR Euro6	316	430	09/12	>	06/16		S 6088 NE		
power steering / servosterzo	D2066 CR Euro6	316	430	09/12	>	06/16				S 3081 PO
power steering ZF Servocom RAS-EC / servosterzo ZF Servocom RAS-EC	D2066 CR Euro6	316	430	09/12	>	06/16				S 5664 PO
Vehicles for building site / veicoli da cantiere	D2066 CR Euro6	316	430	09/12	>	06/16			S 7E35 A	
TGS 28.430	D2066 Euro4/5/EEV	316	430	06/08	>	08/12	S 5046 PE	S 6011 NE	S 7619 A	S 3165 C
with air-conditioner / con climatizzatore	D2066 Euro4/5/EEV	316	430	06/08	>	08/12				S 4177 CA
inner / interno	D2066 Euro4/5/EEV	316	430	06/08	>	08/12			S 7616 A	
prefilter 300 Micron / prefiltro 300 Micron	D2066 Euro4/5/EEV	316	430	06/08	>	08/12		S 6088 NE		
prefilter with fuel oil heater / prefiltro con riscaldatore nafta	D2066 Euro4/5/EEV	316	430	06/08	>	08/12		S 6059 NE		
prefilter without fuel oil heater / prefiltro senza riscaldatore nafta	D2066 Euro4/5/EEV	316	430	06/08	>	08/12		S 6062 NE		
power steering / servosterzo	D2066 Euro4/5/EEV	316	430	06/08	>	08/12				S 3081 PO
TGS 28.440	D2066 CR Euro6	324	440	09/12	>		S 5235 PE	S 6011 NE	S 7619 A	S 3165 C
with automatic gearbox and hydraulic retarder ZF 16S / con cambio automatico e rallentatore idraulico ZF 16S	D2066 CR Euro6	324	440	09/12	>					S 2234 Z
with air-conditioner / con climatizzatore	D2066 CR Euro6	324	440	09/12	>					S 4177 CA
inner / interno	D2066 CR Euro6	324	440	09/12	>				S 7616 A	
prefilter / prefiltro	D2066 CR Euro6	324	440	09/12	>			S 4035 NR		
prefilter 300 Micron / prefiltro 300 Micron	D2066 CR Euro6	324	440	09/12	>			S 6088 NE		
power steering / servosterzo	D2066 CR Euro6	324	440	09/12	>					S 3081 PO
TGS 28.440	D2066 Euro4/5/EEV	324	441	10/07	>	08/12	S 5046 PE	S 6011 NE	S 7619 A	S 3165 C
with air-conditioner / con climatizzatore	D2066 Euro4/5/EEV	324	441	10/07	>	08/12	S 5046 PE	S 6011 NE	S 7619 A	S 4177 CA
inner / interno	D2066 Euro4/5/EEV	324	441	10/07	>	08/12			S 7616 A	
prefilter with fuel oil heater / prefiltro con riscaldatore nafta	D2066 Euro4/5/EEV	324	441	10/07	>	08/12		S 6059 NE		
prefilter without fuel oil heater / prefiltro senza riscaldatore nafta	D2066 Euro4/5/EEV	324	441	10/07	>	08/12		S 6062 NE		
power steering / servosterzo	D2066 Euro4/5/EEV	324	441	10/07	>	08/12				S 3081 PO
TGS 28.460	D2676 CR Euro6	338	460	07/16	>		S 5235 PE	S 6011 NE		S 3165 C
with air-conditioner / con climatizzatore	D2676 CR Euro6	338	460	07/16	>					S 4177 CA
dryer filter / filtro essiccatore	D2676 CR Euro6	338	460	07/16	>					S 7A66 A
prefilter / prefiltro	D2676 CR Euro6	338	460	07/16	>			S 4035 NR		
prefilter 300 Micron / prefiltro 300 Micron	D2676 CR Euro6	338	460	07/16	>			S 6088 NE		
power steering / servosterzo	D2676 CR Euro6	338	460	07/16	>					S 3081 PO
power steering ZF Servocom RAS-EC / servosterzo ZF Servocom RAS-EC	D2676 CR Euro6	338	460	07/16	>					S 5664 PO
TGS 28.480	D2676 CR Euro6	353	480	09/12	>	07/16	S 5235 PE	S 6011 NE	S 7619 A	S 3165 C
with automatic gearbox and hydraulic retarder ZF 16S / con cambio automatico e rallentatore idraulico ZF 16S	D2676 CR Euro6	353	480	09/12	>	07/16				S 2234 Z
with air-conditioner / con climatizzatore	D2676 CR Euro6	353	480	09/12	>	07/16				S 4177 CA
inner / interno	D2676 CR Euro6	353	480	09/12	>	07/16			S 7616 A	
prefilter / prefiltro	D2676 CR Euro6	353	480	09/12	>	07/16		S 4035 NR		



...MAN - trucks/autocarri

prefilter 300 Micron / prefiltro 300 Micron	D2676 CR Euro6	353	480	09/12	>	07/16		S 6088 NE		
power steering / servosterzo	D2676 CR Euro6	353	480	09/12	>	07/16				S 3081 PO
TGS 28.480	D2676 Euro4/5/EEV	353	480	10/07	>	08/12	S 5046 PE	S 6011 NE	S 7619 A	S 3165 C
with air-conditioner / con climatizzatore	D2676 Euro4/5/EEV	353	480	10/07	>	08/12				S 4177 CA
inner / interno	D2676 Euro4/5/EEV	353	480	10/07	>	08/12			S 7616 A	
prefilter with fuel oil heater / prefiltro con riscaldatore nafta	D2676 Euro4/5/EEV	353	480	10/07	>	08/12		S 6059 NE		
prefilter without fuel oil heater / prefiltro senza riscaldatore nafta	D2676 Euro4/5/EEV	353	480	10/07	>	08/12		S 6062 NE		
power steering / servosterzo	D2676 Euro4/5/EEV	353	480	10/07	>	08/12				S 3081 PO
TGS 28.500	D2676 CR Euro6	368	500	07/16	>		S 5235 PE	S 6011 NE		S 3165 C
with air-conditioner / con climatizzatore	D2676 CR Euro6	368	500	07/16	>					S 4177 CA
dryer filter / filtro essiccatore	D2676 CR Euro6	368	500	07/16	>					S 7A66 A
prefilter / prefiltro	D2676 CR Euro6	368	500	07/16	>			S 4035 NR		
prefilter 300 Micron / prefiltro 300 Micron	D2676 CR Euro6	368	500	07/16	>			S 6088 NE		
power steering / servosterzo	D2676 CR Euro6	368	500	07/16	>					S 3081 PO
power steering ZF Servocom RAS-EC / servosterzo ZF Servocom RAS-EC	D2676 CR Euro6	368	500	07/16	>					S 5664 PO
TGS 28.540	D2676 Euro4/5/EEV	397	540	10/07	>	08/12	S 5046 PE	S 6011 NE	S 7619 A	S 3165 C
with air-conditioner / con climatizzatore	D2676 Euro4/5/EEV	397	540	10/07	>	08/12				S 4177 CA
inner / interno	D2676 Euro4/5/EEV	397	540	10/07	>	08/12			S 7616 A	
prefilter with fuel oil heater / prefiltro con riscaldatore nafta	D2676 Euro4/5/EEV	397	540	10/07	>	08/12		S 6059 NE		
prefilter without fuel oil heater / prefiltro senza riscaldatore nafta	D2676 Euro4/5/EEV	397	540	10/07	>	08/12		S 6062 NE		
power steering / servosterzo	D2676 Euro4/5/EEV	397	540	10/07	>	08/12				S 3081 PO
TGS 32.320	D2066 CR Euro6	235	320	09/12	>	06/16	S 5235 PE	S 6011 NE	S 7619 A	S 3165 C
	D2066 CR Euro6	235	320	07/16	>		S 5235 PE	S 6011 NE	S 7F27 A	S 3165 C
with automatic gearbox and hydraulic retarder ZF 16S / con cambio automatico e rallentatore idraulico ZF 16S	D2066 CR Euro6	235	320	09/12	>					S 2234 Z
with air-conditioner / con climatizzatore	D2066 CR Euro6	235	320	09/12	>					S 4177 CA
dryer filter / filtro essiccatore	D2066 CR Euro6	235	320	09/12	>					S 7A66 A
retarder R3500/4100 (TipMatic 12+2) / freno di rallentamento R3500/4100 (TipMatic 12+2)	D2066 CR Euro6	235	320	07/16	>					S 5613 PO
inner / interno	D2066 CR Euro6	235	320	09/12	>	06/16			S 7616 A	
inner / interno	D2066 CR Euro6	235	320	07/16	>				S 7F28 A	
prefilter / prefiltro	D2066 CR Euro6	235	320	09/12	>			S 4035 NR		
prefilter 300 Micron / prefiltro 300 Micron	D2066 CR Euro6	235	320	09/12	>			S 6088 NE		
power steering / servosterzo	D2066 CR Euro6	235	320	09/12	>					S 3081 PO
power steering ZF Servocom RAS-EC / servosterzo ZF Servocom RAS-EC	D2066 CR Euro6	235	320	09/12	>					S 5664 PO
Vehicles for building site / veicoli da cantiere	D2066 CR Euro6	235	320	09/12	>	06/16			S 7E35 A	
Vehicles for building site / veicoli da cantiere	D2066 CR Euro6	235	320	07/16	>				S 7F29 A	
TGS 32.320	D2066 Euro4/5/EEV	235	320	10/07	>	08/12	S 5046 PE	S 6011 NE	S 7619 A	S 3165 C
with air-conditioner / con climatizzatore	D2066 Euro4/5/EEV	235	320	10/07	>	08/12				S 4177 CA
inner / interno	D2066 Euro4/5/EEV	235	320	10/07	>	08/12			S 7616 A	
prefilter 300 Micron / prefiltro 300 Micron	D2066 Euro4/5/EEV	235	320	10/07	>	08/12		S 6088 NE		
prefilter with fuel oil heater / prefiltro con riscaldatore nafta	D2066 Euro4/5/EEV	235	320	10/07	>	08/12		S 6059 NE		
prefilter without fuel oil heater / prefiltro senza riscaldatore nafta	D2066 Euro4/5/EEV	235	320	10/07	>	08/12		S 6062 NE		
power steering / servosterzo	D2066 Euro4/5/EEV	235	320	10/07	>	08/12				S 3081 PO
TGS 32.350	D2066 CR Euro6	257	349	09/12	>		S 5235 PE	S 6011 NE	S 7619 A	S 3165 C
with automatic gearbox and hydraulic retarder ZF 16S / con cambio automatico e rallentatore idraulico ZF 16S	D2066 CR Euro6	257	349	09/12	>					S 2234 Z
with air-conditioner / con climatizzatore	D2066 CR Euro6	257	349	09/12	>					S 4177 CA
retarder R3500/4100 (TipMatic 12+2) / freno di rallentamento R3500/4100 (TipMatic 12+2)	D2066 CR Euro6	257	349	09/12	>					S 5613 PO
inner / interno	D2066 CR Euro6	257	349	09/12	>				S 7616 A	
prefilter / prefiltro	D2066 CR Euro6	257	349	09/12	>			S 4035 NR		
prefilter 300 Micron / prefiltro 300 Micron	D2066 CR Euro6	257	349	09/12	>			S 6088 NE		
power steering / servosterzo	D2066 CR Euro6	257	349	09/12	>					S 3081 PO
power steering ZF Servocom RAS-EC / servosterzo ZF Servocom RAS-EC	D2066 CR Euro6	257	349	09/12	>					S 5664 PO
Vehicles for building site / veicoli da cantiere	D2066 CR Euro6	257	349	09/12	>				S 7E35 A	
TGS 32.350	D2066 Euro4/5/EEV	257	349	10/07	>	08/12	S 5046 PE	S 6011 NE	S 7619 A	S 3165 C
with air-conditioner / con climatizzatore	D2066 Euro4/5/EEV	257	349	10/07	>	08/12				S 4177 CA
inner / interno	D2066 Euro4/5/EEV	257	349	10/07	>	08/12			S 7616 A	
prefilter 300 Micron / prefiltro 300 Micron	D2066 Euro4/5/EEV	257	349	10/07	>	08/12		S 6088 NE		
prefilter with fuel oil heater / prefiltro con riscaldatore nafta	D2066 Euro4/5/EEV	257	349	10/07	>	08/12		S 6059 NE		
prefilter without fuel oil heater / prefiltro senza riscaldatore nafta	D2066 Euro4/5/EEV	257	349	10/07	>	08/12		S 6062 NE		
power steering / servosterzo	D2066 Euro4/5/EEV	257	349	10/07	>	08/12				S 3081 PO
TGS 32.390	D2066 CR Euro6	287	390	09/12	>	06/16	S 5235 PE	S 6011 NE	S 7619 A	S 3165 C
with automatic gearbox and hydraulic retarder ZF 16S / con cambio automatico e rallentatore idraulico ZF 16S	D2066 CR Euro6	287	390	09/12	>	06/16				S 2234 Z
with air-conditioner / con climatizzatore	D2066 CR Euro6	287	390	09/12	>	06/16				S 4177 CA
retarder R3500/4100 (TipMatic 12+2) / freno di rallentamento R3500/4100 (TipMatic 12+2)	D2066 CR Euro6	287	390	09/12	>	06/16				S 5613 PO
inner / interno	D2066 CR Euro6	287	390	09/12	>	06/16			S 7616 A	
prefilter / prefiltro	D2066 CR Euro6	287	390	09/12	>	06/16		S 4035 NR		
prefilter 300 Micron / prefiltro 300 Micron	D2066 CR Euro6	287	390	09/12	>	06/16		S 6088 NE		
power steering / servosterzo	D2066 CR Euro6	287	390	09/12	>	06/16				S 3081 PO

M

**KW HP****...MAN - trucks/autocarri**

power steering ZF Servocom RAS-EC / servosterzo ZF Servocom RAS-EC	D2066 CR Euro6	287	390	09/12	>	06/16				S 5664 PO
Vehicles for building site / veicoli da cantiere	D2066 CR Euro6	287	390	09/12	>	06/16				
TGS 32.390	D2066 Euro4/5/EEV	287	390	06/08	>	08/12	S 5046 PE	S 6011 NE	S 7E35 A	S 3165 C
with air-conditioner / con climatizzatore	D2066 Euro4/5/EEV	287	390	06/08	>	08/12			S 7619 A	S 4177 CA
inner / interno	D2066 Euro4/5/EEV	287	390	06/08	>	08/12			S 7616 A	
prefilter 300 Micron / prefilto 300 Micron	D2066 Euro4/5/EEV	287	390	06/08	>	08/12		S 6088 NE		
prefilter with fuel oil heater / prefilto con riscaldatore nafta	D2066 Euro4/5/EEV	287	390	06/08	>	08/12		S 6059 NE		
prefilter without fuel oil heater / prefilto senza riscaldatore nafta	D2066 Euro4/5/EEV	287	390	06/08	>	08/12		S 6062 NE		
power steering / servosterzo	D2066 Euro4/5/EEV	287	390	06/08	>	08/12				S 3081 PO
TGS 32.420	D2676 CR Euro6	309	420	07/16	>		S 5235 PE	S 6011 NE	S 7F27 A	S 3165 C
with automatic gearbox and hydraulic retarder ZF 16S / con cambio automatico e rallentatore idraulico ZF 16S	D2676 CR Euro6	309	420	07/16	>					S 2234 Z
with air-conditioner / con climatizzatore	D2676 CR Euro6	309	420	07/16	>					S 4177 CA
dryer filter / filtro essiccatore	D2676 CR Euro6	309	420	07/16	>					S 7A66 A
retarder R3500/4100 (TipMatic 12+2) / freno di rallentamento R3500/4100 (TipMatic 12+2)	D2676 CR Euro6	309	420	07/16	>					S 5613 PO
inner / interno	D2676 CR Euro6	309	420	07/16	>				S 7F28 A	
prefilter / prefilto	D2676 CR Euro6	309	420	07/16	>			S 4035 NR		
prefilter 300 Micron / prefilto 300 Micron	D2676 CR Euro6	309	420	07/16	>			S 6088 NE		
power steering / servosterzo	D2676 CR Euro6	309	420	07/16	>					S 3081 PO
power steering ZF Servocom RAS-EC / servosterzo ZF Servocom RAS-EC	D2676 CR Euro6	309	420	07/16	>					S 5664 PO
Vehicles for building site / veicoli da cantiere	D2676 CR Euro6	309	420	07/16	>				S 7F29 A	
TGS 32.460	D2676 CR Euro6	338	460	07/16	>		S 5235 PE	S 6011 NE		S 3165 C
with air-conditioner / con climatizzatore	D2676 CR Euro6	338	460	07/16	>					S 4177 CA
dryer filter / filtro essiccatore	D2676 CR Euro6	338	460	07/16	>					S 7A66 A
prefilter / prefilto	D2676 CR Euro6	338	460	07/16	>			S 4035 NR		
prefilter 300 Micron / prefilto 300 Micron	D2676 CR Euro6	338	460	07/16	>			S 6088 NE		
power steering / servosterzo	D2676 CR Euro6	338	460	07/16	>					S 3081 PO
power steering ZF Servocom RAS-EC / servosterzo ZF Servocom RAS-EC	D2676 CR Euro6	338	460	07/16	>					S 5664 PO
TGS 32.480	D2676 CR Euro6	353	480	09/12	>	07/16	S 5235 PE	S 6011 NE	S 7619 A	S 3165 C
with automatic gearbox and hydraulic retarder ZF 16S / con cambio automatico e rallentatore idraulico ZF 16S	D2676 CR Euro6	353	480	09/12	>	07/16				S 2234 Z
with air-conditioner / con climatizzatore	D2676 CR Euro6	353	480	09/12	>	07/16				S 4177 CA
inner / interno	D2676 CR Euro6	353	480	09/12	>	07/16			S 7616 A	
prefilter / prefilto	D2676 CR Euro6	353	480	09/12	>	07/16		S 4035 NR		
prefilter 300 Micron / prefilto 300 Micron	D2676 CR Euro6	353	480	09/12	>	07/16		S 6088 NE		
power steering / servosterzo	D2676 CR Euro6	353	480	09/12	>	07/16				S 3081 PO
TGS 32.480	D2676 Euro4/5/EEV	353	480	10/07	>	08/12	S 5046 PE	S 6011 NE	S 7619 A	S 3165 C
with air-conditioner / con climatizzatore	D2676 Euro4/5/EEV	353	480	10/07	>	08/12				S 4177 CA
inner / interno	D2676 Euro4/5/EEV	353	480	10/07	>	08/12			S 7616 A	
prefilter with fuel oil heater / prefilto con riscaldatore nafta	D2676 Euro4/5/EEV	353	480	10/07	>	08/12		S 6059 NE		
prefilter without fuel oil heater / prefilto senza riscaldatore nafta	D2676 Euro4/5/EEV	353	480	10/07	>	08/12		S 6062 NE		
power steering / servosterzo	D2676 Euro4/5/EEV	353	480	10/07	>	08/12				S 3081 PO
TGS 32.500	D2676 CR Euro6	368	500	07/16	>		S 5235 PE	S 6011 NE		S 3165 C
with air-conditioner / con climatizzatore	D2676 CR Euro6	368	500	07/16	>					S 4177 CA
dryer filter / filtro essiccatore	D2676 CR Euro6	368	500	07/16	>					S 7A66 A
prefilter / prefilto	D2676 CR Euro6	368	500	07/16	>			S 4035 NR		
prefilter 300 Micron / prefilto 300 Micron	D2676 CR Euro6	368	500	07/16	>			S 6088 NE		
power steering / servosterzo	D2676 CR Euro6	368	500	07/16	>					S 3081 PO
power steering ZF Servocom RAS-EC / servosterzo ZF Servocom RAS-EC	D2676 CR Euro6	368	500	07/16	>					S 5664 PO
TGS 33.320	D2066 CR Euro6	235	320	09/12	>	06/16	S 5235 PE	S 6011 NE	S 7619 A	S 3165 C
	D2066 CR Euro6	235	320	07/16	>		S 5235 PE	S 6011 NE	S 7F27 A	S 3165 C
with automatic gearbox and hydraulic retarder ZF 16S / con cambio automatico e rallentatore idraulico ZF 16S	D2066 CR Euro6	235	320	09/12	>					S 2234 Z
with air-conditioner / con climatizzatore	D2066 CR Euro6	235	320	09/12	>					S 4177 CA
dryer filter / filtro essiccatore	D2066 CR Euro6	235	320	09/12	>					S 7A66 A
retarder R3500/4100 (TipMatic 12+2) / freno di rallentamento R3500/4100 (TipMatic 12+2)	D2066 CR Euro6	235	320	07/16	>					S 5613 PO
inner / interno	D2066 CR Euro6	235	320	09/12	>	06/16			S 7616 A	
inner / interno	D2066 CR Euro6	235	320	07/16	>				S 7F28 A	
prefilter / prefilto	D2066 CR Euro6	235	320	09/12	>			S 4035 NR		
prefilter 300 Micron / prefilto 300 Micron	D2066 CR Euro6	235	320	09/12	>			S 6088 NE		
power steering / servosterzo	D2066 CR Euro6	235	320	09/12	>					S 3081 PO
power steering ZF Servocom RAS-EC / servosterzo ZF Servocom RAS-EC	D2066 CR Euro6	235	320	09/12	>					S 5664 PO
Vehicles for building site / veicoli da cantiere	D2066 CR Euro6	235	320	09/12	>	06/16				S 7E35 A
Vehicles for building site / veicoli da cantiere	D2066 CR Euro6	235	320	07/16	>					S 7F29 A
TGS 33.320	D2066 Euro4/5/EEV	235	320	10/07	>	08/12	S 5046 PE	S 6011 NE	S 7619 A	S 3165 C
with air-conditioner / con climatizzatore	D2066 Euro4/5/EEV	235	320	10/07	>	08/12				S 4177 CA
inner / interno	D2066 Euro4/5/EEV	235	320	10/07	>	08/12			S 7616 A	
prefilter 300 Micron / prefilto 300 Micron	D2066 Euro4/5/EEV	235	320	10/07	>	08/12		S 6088 NE		
prefilter with fuel oil heater / prefilto con riscaldatore nafta	D2066 Euro4/5/EEV	235	320	10/07	>	08/12		S 6059 NE		
prefilter without fuel oil heater / prefilto senza riscaldatore nafta	D2066 Euro4/5/EEV	235	320	10/07	>	08/12		S 6062 NE		

**KW HP****...MAN - trucks/autocarri**

power steering / servosterzo	D2066 Euro4/5/EEV	235	320	10/07 >	08/12				S 3081 PO
TGS 33.350	D2066 CR Euro6	257	349	09/12 >		S 5235 PE	S 6011 NE	S 7619 A	S 3165 C
with automatic gearbox and hydraulic retarder ZF 16S / con cambio automatico e rallentatore idraulico ZF 16S	D2066 CR Euro6	257	349	09/12 >					S 2234 Z
with air-conditioner / con climatizzatore	D2066 CR Euro6	257	349	09/12 >					S 4177 CA
retarder R3500/4100 (TipMatic 12+2) / freno di rallentamento R3500/4100 (TipMatic 12+2)	D2066 CR Euro6	257	349	09/12 >					S 5613 PO
inner / interno	D2066 CR Euro6	257	349	09/12 >				S 7616 A	
prefilter / prefiltra	D2066 CR Euro6	257	349	09/12 >			S 4035 NR		
prefilter 300 Micron / prefiltra 300 Micron	D2066 CR Euro6	257	349	09/12 >			S 6088 NE		
power steering / servosterzo	D2066 CR Euro6	257	349	09/12 >					S 3081 PO
power steering ZF Servocom RAS-EC / servosterzo ZF Servocom RAS-EC	D2066 CR Euro6	257	349	09/12 >					S 5664 PO
Vehicles for building site / veicoli da cantiere	D2066 CR Euro6	257	349	09/12 >				S 7E35 A	
TGS 33.350	D2066 Euro4/5/EEV	257	349	10/07 >	08/12	S 5046 PE	S 6011 NE	S 7619 A	S 3165 C
with air-conditioner / con climatizzatore	D2066 Euro4/5/EEV	257	349	10/07 >	08/12				S 4177 CA
inner / interno	D2066 Euro4/5/EEV	257	349	10/07 >	08/12			S 7616 A	
prefilter 300 Micron / prefiltra 300 Micron	D2066 Euro4/5/EEV	257	349	10/07 >	08/12		S 6088 NE		
prefilter with fuel oil heater / prefiltra con riscaldatore nafta	D2066 Euro4/5/EEV	257	349	10/07 >	08/12		S 6059 NE		
prefilter without fuel oil heater / prefiltra senza riscaldatore nafta	D2066 Euro4/5/EEV	257	349	10/07 >	08/12		S 6062 NE		
power steering / servosterzo	D2066 Euro4/5/EEV	257	349	10/07 >	08/12				S 3081 PO
TGS 33.360	D2066 CR Euro6	265	360	09/12 >	06/16	S 5235 PE	S 6011 NE	S 7619 A	S 3165 C
	D2066 CR Euro6	265	360	07/16 >		S 5235 PE	S 6011 NE	S 7F27 A	S 3165 C
with automatic gearbox and hydraulic retarder ZF 16S / con cambio automatico e rallentatore idraulico ZF 16S	D2066 CR Euro6	265	360	09/12 >					S 2234 Z
with air-conditioner / con climatizzatore	D2066 CR Euro6	265	360	09/12 >					S 4177 CA
retarder R3500/4100 (TipMatic 12+2) / freno di rallentamento R3500/4100 (TipMatic 12+2)	D2066 CR Euro6	265	360	07/16 >					S 5613 PO
inner / interno	D2066 CR Euro6	265	360	09/12 >	06/16			S 7616 A	
inner / interno	D2066 CR Euro6	265	360	07/16 >				S 7F28 A	
prefilter / prefiltra	D2066 CR Euro6	265	360	09/12 >			S 4035 NR		
prefilter 300 Micron / prefiltra 300 Micron	D2066 CR Euro6	265	360	09/12 >			S 6088 NE		
power steering / servosterzo	D2066 CR Euro6	265	360	09/12 >					S 3081 PO
power steering ZF Servocom RAS-EC / servosterzo ZF Servocom RAS-EC	D2066 CR Euro6	265	360	09/12 >					S 5664 PO
Vehicles for building site / veicoli da cantiere	D2066 CR Euro6	265	360	09/12 >	06/16			S 7E35 A	
Vehicles for building site / veicoli da cantiere	D2066 CR Euro6	265	360	07/16 >				S 7F29 A	
TGS 33.360	D2066 Euro4/5/EEV	265	360	10/07 >	08/12	S 5046 PE	S 6011 NE	S 7619 A	S 3165 C
with air-conditioner / con climatizzatore	D2066 Euro4/5/EEV	265	360	10/07 >	08/12				S 4177 CA
inner / interno	D2066 Euro4/5/EEV	265	360	10/07 >	08/12			S 7616 A	
prefilter 300 Micron / prefiltra 300 Micron	D2066 Euro4/5/EEV	265	360	10/07 >	08/12		S 6088 NE		
prefilter with fuel oil heater / prefiltra con riscaldatore nafta	D2066 Euro4/5/EEV	265	360	10/07 >	08/12		S 6059 NE		
prefilter without fuel oil heater / prefiltra senza riscaldatore nafta	D2066 Euro4/5/EEV	265	360	10/07 >	08/12		S 6062 NE		
power steering / servosterzo	D2066 Euro4/5/EEV	265	360	10/07 >	08/12				S 3081 PO
TGS 33.390	D2066 CR Euro6	287	390	09/12 >	06/16	S 5235 PE	S 6011 NE	S 7619 A	S 3165 C
with automatic gearbox and hydraulic retarder ZF 16S / con cambio automatico e rallentatore idraulico ZF 16S	D2066 CR Euro6	287	390	09/12 >	06/16				S 2234 Z
with air-conditioner / con climatizzatore	D2066 CR Euro6	287	390	09/12 >	06/16				S 4177 CA
retarder R3500/4100 (TipMatic 12+2) / freno di rallentamento R3500/4100 (TipMatic 12+2)	D2066 CR Euro6	287	390	09/12 >	06/16				S 5613 PO
inner / interno	D2066 CR Euro6	287	390	09/12 >	06/16			S 7616 A	
prefilter / prefiltra	D2066 CR Euro6	287	390	09/12 >	06/16		S 4035 NR		
prefilter 300 Micron / prefiltra 300 Micron	D2066 CR Euro6	287	390	09/12 >	06/16		S 6088 NE		
power steering / servosterzo	D2066 CR Euro6	287	390	09/12 >	06/16				S 3081 PO
power steering ZF Servocom RAS-EC / servosterzo ZF Servocom RAS-EC	D2066 CR Euro6	287	390	09/12 >	06/16				S 5664 PO
Vehicles for building site / veicoli da cantiere	D2066 CR Euro6	287	390	09/12 >	06/16			S 7E35 A	
TGS 33.390	D2066 Euro4/5/EEV	287	390	06/08 >	08/12	S 5046 PE	S 6011 NE	S 7619 A	S 3165 C
with air-conditioner / con climatizzatore	D2066 Euro4/5/EEV	287	390	06/08 >	08/12				S 4177 CA
inner / interno	D2066 Euro4/5/EEV	287	390	06/08 >	08/12			S 7616 A	
prefilter 300 Micron / prefiltra 300 Micron	D2066 Euro4/5/EEV	287	390	06/08 >	08/12		S 6088 NE		
prefilter with fuel oil heater / prefiltra con riscaldatore nafta	D2066 Euro4/5/EEV	287	390	06/08 >	08/12		S 6059 NE		
prefilter without fuel oil heater / prefiltra senza riscaldatore nafta	D2066 Euro4/5/EEV	287	390	06/08 >	08/12		S 6062 NE		
power steering / servosterzo	D2066 Euro4/5/EEV	287	390	06/08 >	08/12				S 3081 PO
TGS 33.400	D2066 CR Euro6	294	400	09/12 >		S 5235 PE	S 6011 NE	S 7619 A	S 3165 C
with automatic gearbox and hydraulic retarder ZF 16S / con cambio automatico e rallentatore idraulico ZF 16S	D2066 CR Euro6	294	400	09/12 >					S 2234 Z
with air-conditioner / con climatizzatore	D2066 CR Euro6	294	400	09/12 >					S 4177 CA
inner / interno	D2066 CR Euro6	294	400	09/12 >				S 7616 A	
prefilter / prefiltra	D2066 CR Euro6	294	400	09/12 >			S 4035 NR		
prefilter 300 Micron / prefiltra 300 Micron	D2066 CR Euro6	294	400	09/12 >			S 6088 NE		
power steering / servosterzo	D2066 CR Euro6	294	400	09/12 >					S 3081 PO
TGS 33.400	D2066 Euro4/5/EEV	294	400	10/07 >	08/12	S 5046 PE	S 6011 NE	S 7619 A	S 3165 C
with air-conditioner / con climatizzatore	D2066 Euro4/5/EEV	294	400	10/07 >	08/12				S 4177 CA
inner / interno	D2066 Euro4/5/EEV	294	400	10/07 >	08/12			S 7616 A	
prefilter with fuel oil heater / prefiltra con riscaldatore nafta	D2066 Euro4/5/EEV	294	400	10/07 >	08/12		S 6059 NE		
prefilter without fuel oil heater / prefiltra senza riscaldatore nafta	D2066 Euro4/5/EEV	294	400	10/07 >	08/12		S 6062 NE		

M

**KW HP****...MAN - trucks/autocarri**

power steering / servosterzo	D2066 Euro4/5/EEV	294	400	10/07	>	08/12				S 3081 PO
TGS 33.420	D2676 CR Euro6	309	420	07/16	>		S 5235 PE	S 6011 NE	S 7F27 A	S 3165 C
with automatic gearbox and hydraulic retarder ZF 16S / con cambio automatico e rallentatore idraulico ZF 16S	D2676 CR Euro6	309	420	07/16	>					S 2234 Z
with air-conditioner / con climatizzatore	D2676 CR Euro6	309	420	07/16	>					S 4177 CA
dryer filter / filtro essiccatore	D2676 CR Euro6	309	420	07/16	>					S 7A66 A
retarder R3500/4100 (TipMatic 12+2) / freno di rallentamento R3500/4100 (TipMatic 12+2)	D2676 CR Euro6	309	420	07/16	>					S 5613 PO
inner / interno	D2676 CR Euro6	309	420	07/16	>				S 7F28 A	
prefilter / prefiltra	D2676 CR Euro6	309	420	07/16	>			S 4035 NR		
prefilter 300 Micron / prefiltra 300 Micron	D2676 CR Euro6	309	420	07/16	>			S 6088 NE		
power steering / servosterzo	D2676 CR Euro6	309	420	07/16	>					S 3081 PO
power steering ZF Servocom RAS-EC / servosterzo ZF Servocom RAS-EC	D2676 CR Euro6	309	420	07/16	>					S 5664 PO
Vehicles for building site / veicoli da cantiere	D2676 CR Euro6	309	420	07/16	>				S 7F29 A	
TGS 33.430	D2066 CR Euro6	316	430	09/12	>	06/16	S 5235 PE	S 6011 NE	S 7619 A	S 3165 C
with automatic gearbox and hydraulic retarder ZF 16S / con cambio automatico e rallentatore idraulico ZF 16S	D2066 CR Euro6	316	430	09/12	>	06/16				S 2234 Z
with air-conditioner / con climatizzatore	D2066 CR Euro6	316	430	09/12	>	06/16				S 4177 CA
retarder R3500/4100 (TipMatic 12+2) / freno di rallentamento R3500/4100 (TipMatic 12+2)	D2066 CR Euro6	316	430	09/12	>	06/16				S 5613 PO
inner / interno	D2066 CR Euro6	316	430	09/12	>	06/16			S 7616 A	
prefilter / prefiltra	D2066 CR Euro6	316	430	09/12	>	06/16		S 4035 NR		
prefilter 300 Micron / prefiltra 300 Micron	D2066 CR Euro6	316	430	09/12	>	06/16		S 6088 NE		
power steering / servosterzo	D2066 CR Euro6	316	430	09/12	>	06/16				S 3081 PO
power steering ZF Servocom RAS-EC / servosterzo ZF Servocom RAS-EC	D2066 CR Euro6	316	430	09/12	>	06/16				S 5664 PO
Vehicles for building site / veicoli da cantiere	D2066 CR Euro6	316	430	09/12	>	06/16			S 7E35 A	
TGS 33.430	D2066 Euro4/5/EEV	316	430	06/08	>	08/12	S 5046 PE	S 6011 NE	S 7619 A	S 3165 C
with air-conditioner / con climatizzatore	D2066 Euro4/5/EEV	316	430	06/08	>	08/12				S 4177 CA
inner / interno	D2066 Euro4/5/EEV	316	430	06/08	>	08/12			S 7616 A	
prefilter 300 Micron / prefiltra 300 Micron	D2066 Euro4/5/EEV	316	430	06/08	>	08/12		S 6088 NE		
prefilter with fuel oil heater / prefiltra con riscaldatore nafta	D2066 Euro4/5/EEV	316	430	06/08	>	08/12		S 6059 NE		
prefilter without fuel oil heater / prefiltra senza riscaldatore nafta	D2066 Euro4/5/EEV	316	430	06/08	>	08/12		S 6062 NE		
power steering / servosterzo	D2066 Euro4/5/EEV	316	430	06/08	>	08/12				S 3081 PO
TGS 33.440	D2066 CR Euro6	324	440	09/12	>		S 5235 PE	S 6011 NE	S 7619 A	S 3165 C
with automatic gearbox and hydraulic retarder ZF 16S / con cambio automatico e rallentatore idraulico ZF 16S	D2066 CR Euro6	324	440	09/12	>					S 2234 Z
with air-conditioner / con climatizzatore	D2066 CR Euro6	324	440	09/12	>					S 4177 CA
inner / interno	D2066 CR Euro6	324	440	09/12	>				S 7616 A	
prefilter / prefiltra	D2066 CR Euro6	324	440	09/12	>			S 4035 NR		
prefilter 300 Micron / prefiltra 300 Micron	D2066 CR Euro6	324	440	09/12	>			S 6088 NE		
power steering / servosterzo	D2066 CR Euro6	324	440	09/12	>					S 3081 PO
TGS 33.440	D2066 Euro4/5/EEV	324	441	10/07	>	08/12	S 5046 PE	S 6011 NE	S 7619 A	S 3165 C
with air-conditioner / con climatizzatore	D2066 Euro4/5/EEV	324	441	10/07	>	08/12	S 5046 PE	S 6011 NE	S 7619 A	S 4177 CA
inner / interno	D2066 Euro4/5/EEV	324	441	10/07	>	08/12			S 7616 A	
prefilter with fuel oil heater / prefiltra con riscaldatore nafta	D2066 Euro4/5/EEV	324	441	10/07	>	08/12		S 6059 NE		
prefilter without fuel oil heater / prefiltra senza riscaldatore nafta	D2066 Euro4/5/EEV	324	441	10/07	>	08/12		S 6062 NE		
power steering / servosterzo	D2066 Euro4/5/EEV	324	441	10/07	>	08/12				S 3081 PO
TGS 33.460	D2676 CR Euro6	338	460	07/16	>		S 5235 PE	S 6011 NE		S 3165 C
	D2676 CR Euro6	338	460	07/16	>		S 5235 PE	S 6011 NE		S 3165 C
with air-conditioner / con climatizzatore	D2676 CR Euro6	338	460	07/16	>					S 4177 CA
with air-conditioner / con climatizzatore	D2676 CR Euro6	338	460	07/16	>					S 4177 CA
dryer filter / filtro essiccatore	D2676 CR Euro6	338	460	07/16	>					S 7A66 A
dryer filter / filtro essiccatore	D2676 CR Euro6	338	460	07/16	>					S 7A66 A
prefilter / prefiltra	D2676 CR Euro6	338	460	07/16	>			S 4035 NR		
prefilter / prefiltra	D2676 CR Euro6	338	460	07/16	>			S 4035 NR		
prefilter 300 Micron / prefiltra 300 Micron	D2676 CR Euro6	338	460	07/16	>			S 6088 NE		
prefilter 300 Micron / prefiltra 300 Micron	D2676 CR Euro6	338	460	07/16	>			S 6088 NE		
power steering / servosterzo	D2676 CR Euro6	338	460	07/16	>					S 3081 PO
power steering / servosterzo	D2676 CR Euro6	338	460	07/16	>					S 3081 PO
power steering ZF Servocom RAS-EC / servosterzo ZF Servocom RAS-EC	D2676 CR Euro6	338	460	07/16	>					S 5664 PO
power steering ZF Servocom RAS-EC / servosterzo ZF Servocom RAS-EC	D2676 CR Euro6	338	460	07/16	>					S 5664 PO
TGS 33.480	D2676 CR Euro6	353	480	09/12	>	07/16	S 5235 PE	S 6011 NE	S 7619 A	S 3165 C
with automatic gearbox and hydraulic retarder ZF 16S / con cambio automatico e rallentatore idraulico ZF 16S	D2676 CR Euro6	353	480	09/12	>	07/16				S 2234 Z
with air-conditioner / con climatizzatore	D2676 CR Euro6	353	480	09/12	>	07/16				S 4177 CA
inner / interno	D2676 CR Euro6	353	480	09/12	>	07/16			S 7616 A	
prefilter / prefiltra	D2676 CR Euro6	353	480	09/12	>	07/16		S 4035 NR		
prefilter 300 Micron / prefiltra 300 Micron	D2676 CR Euro6	353	480	09/12	>	07/16		S 6088 NE		
power steering / servosterzo	D2676 CR Euro6	353	480	09/12	>	07/16				S 3081 PO
TGS 33.480	D2676 Euro4/5/EEV	353	480	10/07	>	08/12	S 5046 PE	S 6011 NE	S 7619 A	S 3165 C
with air-conditioner / con climatizzatore	D2676 Euro4/5/EEV	353	480	10/07	>	08/12				S 4177 CA
inner / interno	D2676 Euro4/5/EEV	353	480	10/07	>	08/12			S 7616 A	
prefilter with fuel oil heater / prefiltra con riscaldatore nafta	D2676 Euro4/5/EEV	353	480	10/07	>	08/12		S 6059 NE		

**KW HP****...MAN - trucks/autocarri**

prefilter without fuel oil heater / prefiltrato senza riscaldatore nafta	D2676 Euro4/5/EEV	353	480	10/07	>	08/12		S 6062 NE		
power steering / servosterzo	D2676 Euro4/5/EEV	353	480	10/07	>	08/12				S 3081 PO
TGS 33.500	D2676 CR Euro6	368	500	07/16	>		S 5235 PE	S 6011 NE		S 3165 C
with air-conditioner / con climatizzatore	D2676 CR Euro6	368	500	07/16	>					S 4177 CA
dryer filter / filtro essiccatore	D2676 CR Euro6	368	500	07/16	>					S 7A66 A
prefilter / prefiltrato	D2676 CR Euro6	368	500	07/16	>			S 4035 NR		
prefilter 300 Micron / prefiltrato 300 Micron	D2676 CR Euro6	368	500	07/16	>			S 6088 NE		
power steering / servosterzo	D2676 CR Euro6	368	500	07/16	>					S 3081 PO
power steering ZF Servocom RAS-EC / servosterzo ZF Servocom RAS-EC	D2676 CR Euro6	368	500	07/16	>					S 5664 PO
TGS 33.540	D2676 Euro4/5/EEV	397	540	10/07	>	08/12	S 5046 PE	S 6011 NE	S 7619 A	S 3165 C
with air-conditioner / con climatizzatore	D2676 Euro4/5/EEV	397	540	10/07	>	08/12				S 4177 CA
inner / interno	D2676 Euro4/5/EEV	397	540	10/07	>	08/12			S 7616 A	
prefilter with fuel oil heater / prefiltrato con riscaldatore nafta	D2676 Euro4/5/EEV	397	540	10/07	>	08/12		S 6059 NE		
prefilter without fuel oil heater / prefiltrato senza riscaldatore nafta	D2676 Euro4/5/EEV	397	540	10/07	>	08/12		S 6062 NE		
power steering / servosterzo	D2676 Euro4/5/EEV	397	540	10/07	>	08/12				S 3081 PO
TGS 35.320	D2066 CR Euro6	235	320	09/12	>	06/16	S 5235 PE	S 6011 NE	S 7619 A	S 3165 C
	D2066 CR Euro6	235	320	07/16	>		S 5235 PE	S 6011 NE	S 7F27 A	S 3165 C
with automatic gearbox and hydraulic retarder ZF 16S / con cambio automatico e rallentatore idraulico ZF 16S	D2066 CR Euro6	235	320	09/12	>					S 2234 Z
with air-conditioner / con climatizzatore	D2066 CR Euro6	235	320	09/12	>					S 4177 CA
dryer filter / filtro essiccatore	D2066 CR Euro6	235	320	09/12	>					S 7A66 A
retarder R3500/4100 (TipMatic 12+2) / freno di rallentamento R3500/4100 (TipMatic 12+2)	D2066 CR Euro6	235	320	07/16	>					S 5613 PO
inner / interno	D2066 CR Euro6	235	320	09/12	>	06/16			S 7616 A	
inner / interno	D2066 CR Euro6	235	320	07/16	>				S 7F28 A	
prefilter / prefiltrato	D2066 CR Euro6	235	320	09/12	>			S 4035 NR		
prefilter 300 Micron / prefiltrato 300 Micron	D2066 CR Euro6	235	320	09/12	>			S 6088 NE		
power steering / servosterzo	D2066 CR Euro6	235	320	09/12	>					S 3081 PO
power steering ZF Servocom RAS-EC / servosterzo ZF Servocom RAS-EC	D2066 CR Euro6	235	320	09/12	>					S 5664 PO
Vehicles for building site / veicoli da cantiere	D2066 CR Euro6	235	320	09/12	>	06/16			S 7E35 A	
Vehicles for building site / veicoli da cantiere	D2066 CR Euro6	235	320	07/16	>				S 7F29 A	
TGS 35.320	D2066 Euro4/5/EEV	235	320	10/07	>	08/12	S 5046 PE	S 6011 NE	S 7619 A	S 3165 C
with air-conditioner / con climatizzatore	D2066 Euro4/5/EEV	235	320	10/07	>	08/12				S 4177 CA
inner / interno	D2066 Euro4/5/EEV	235	320	10/07	>	08/12			S 7616 A	
prefilter 300 Micron / prefiltrato 300 Micron	D2066 Euro4/5/EEV	235	320	10/07	>	08/12		S 6088 NE		
prefilter with fuel oil heater / prefiltrato con riscaldatore nafta	D2066 Euro4/5/EEV	235	320	10/07	>	08/12		S 6059 NE		
prefilter without fuel oil heater / prefiltrato senza riscaldatore nafta	D2066 Euro4/5/EEV	235	320	10/07	>	08/12		S 6062 NE		
power steering / servosterzo	D2066 Euro4/5/EEV	235	320	10/07	>	08/12				S 3081 PO
TGS 35.350	D2066 CR Euro6	257	349	09/12	>		S 5235 PE	S 6011 NE	S 7619 A	S 3165 C
with automatic gearbox and hydraulic retarder ZF 16S / con cambio automatico e rallentatore idraulico ZF 16S	D2066 CR Euro6	257	349	09/12	>					S 2234 Z
with air-conditioner / con climatizzatore	D2066 CR Euro6	257	349	09/12	>					S 4177 CA
retarder R3500/4100 (TipMatic 12+2) / freno di rallentamento R3500/4100 (TipMatic 12+2)	D2066 CR Euro6	257	349	09/12	>					S 5613 PO
inner / interno	D2066 CR Euro6	257	349	09/12	>				S 7616 A	
prefilter / prefiltrato	D2066 CR Euro6	257	349	09/12	>			S 4035 NR		
prefilter 300 Micron / prefiltrato 300 Micron	D2066 CR Euro6	257	349	09/12	>			S 6088 NE		
power steering / servosterzo	D2066 CR Euro6	257	349	09/12	>					S 3081 PO
power steering ZF Servocom RAS-EC / servosterzo ZF Servocom RAS-EC	D2066 CR Euro6	257	349	09/12	>					S 5664 PO
Vehicles for building site / veicoli da cantiere	D2066 CR Euro6	257	349	09/12	>				S 7E35 A	
TGS 35.350	D2066 Euro4/5/EEV	257	349	10/07	>	08/12	S 5046 PE	S 6011 NE	S 7619 A	S 3165 C
with air-conditioner / con climatizzatore	D2066 Euro4/5/EEV	257	349	10/07	>	08/12				S 4177 CA
inner / interno	D2066 Euro4/5/EEV	257	349	10/07	>	08/12			S 7616 A	
prefilter 300 Micron / prefiltrato 300 Micron	D2066 Euro4/5/EEV	257	349	10/07	>	08/12		S 6088 NE		
prefilter with fuel oil heater / prefiltrato con riscaldatore nafta	D2066 Euro4/5/EEV	257	349	10/07	>	08/12		S 6059 NE		
prefilter without fuel oil heater / prefiltrato senza riscaldatore nafta	D2066 Euro4/5/EEV	257	349	10/07	>	08/12		S 6062 NE		
power steering / servosterzo	D2066 Euro4/5/EEV	257	349	10/07	>	08/12				S 3081 PO
TGS 35.360	D2066 CR Euro6	265	360	09/12	>	06/16	S 5235 PE	S 6011 NE	S 7619 A	S 3165 C
	D2066 CR Euro6	265	360	07/16	>		S 5235 PE	S 6011 NE	S 7F27 A	S 3165 C
with automatic gearbox and hydraulic retarder ZF 16S / con cambio automatico e rallentatore idraulico ZF 16S	D2066 CR Euro6	265	360	09/12	>					S 2234 Z
with air-conditioner / con climatizzatore	D2066 CR Euro6	265	360	09/12	>					S 4177 CA
retarder R3500/4100 (TipMatic 12+2) / freno di rallentamento R3500/4100 (TipMatic 12+2)	D2066 CR Euro6	265	360	07/16	>					S 5613 PO
inner / interno	D2066 CR Euro6	265	360	09/12	>	06/16			S 7616 A	
inner / interno	D2066 CR Euro6	265	360	07/16	>				S 7F28 A	
prefilter / prefiltrato	D2066 CR Euro6	265	360	09/12	>			S 4035 NR		
prefilter 300 Micron / prefiltrato 300 Micron	D2066 CR Euro6	265	360	09/12	>			S 6088 NE		
power steering / servosterzo	D2066 CR Euro6	265	360	09/12	>					S 3081 PO
power steering ZF Servocom RAS-EC / servosterzo ZF Servocom RAS-EC	D2066 CR Euro6	265	360	09/12	>					S 5664 PO
Vehicles for building site / veicoli da cantiere	D2066 CR Euro6	265	360	09/12	>	06/16			S 7E35 A	
Vehicles for building site / veicoli da cantiere	D2066 CR Euro6	265	360	07/16	>				S 7F29 A	
TGS 35.360	D2066 Euro4/5/EEV	265	360	10/07	>	08/12	S 5046 PE	S 6011 NE	S 7619 A	S 3165 C

M

**KW HP****...MAN - trucks/autocarri**

with air-conditioner / con climatizzatore	D2066 Euro4/5/EEV	265	360	10/07	>	08/12	S 5046 PE	S 6011 NE	S 7619 A	S 4177 CA
inner / interno	D2066 Euro4/5/EEV	265	360	10/07	>	08/12			S 7616 A	
prefilter with fuel oil heater / prefiltra con riscaldatore nafta	D2066 Euro4/5/EEV	265	360	10/07	>	08/12		S 6059 NE		
prefilter without fuel oil heater / prefiltra senza riscaldatore nafta	D2066 Euro4/5/EEV	265	360	10/07	>	08/12		S 6062 NE		
power steering / servosterzo	D2066 Euro4/5/EEV	265	360	10/07	>	08/12				S 3081 PO
TGS 35.390	D2066 CR Euro6	287	390	09/12	>	06/16	S 5235 PE	S 6011 NE	S 7619 A	S 3165 C
with automatic gearbox and hydraulic retarder ZF 16S / con cambio automatico e rallentatore idraulico ZF 16S	D2066 CR Euro6	287	390	09/12	>	06/16				S 2234 Z
with air-conditioner / con climatizzatore	D2066 CR Euro6	287	390	09/12	>	06/16				S 4177 CA
retarder R3500/4100 (TipMatic 12+2) / freno di rallentamento R3500/4100 (TipMatic 12+2)	D2066 CR Euro6	287	390	09/12	>	06/16				S 5613 PO
inner / interno	D2066 CR Euro6	287	390	09/12	>	06/16			S 7616 A	
prefilter / prefiltra	D2066 CR Euro6	287	390	09/12	>	06/16		S 4035 NR		
prefilter 300 Micron / prefiltra 300 Micron	D2066 CR Euro6	287	390	09/12	>	06/16		S 6088 NE		
power steering / servosterzo	D2066 CR Euro6	287	390	09/12	>	06/16				S 3081 PO
power steering ZF Servocom RAS-EC / servosterzo ZF Servocom RAS-EC	D2066 CR Euro6	287	390	09/12	>	06/16				S 5664 PO
Vehicles for building site / veicoli da cantiere	D2066 CR Euro6	287	390	09/12	>	06/16			S 7E35 A	
TGS 35.390	D2066 Euro4/5/EEV	287	390	06/08	>	08/12	S 5046 PE	S 6011 NE	S 7619 A	S 3165 C
with air-conditioner / con climatizzatore	D2066 Euro4/5/EEV	287	390	06/08	>	08/12				S 4177 CA
inner / interno	D2066 Euro4/5/EEV	287	390	06/08	>	08/12			S 7616 A	
prefilter 300 Micron / prefiltra 300 Micron	D2066 Euro4/5/EEV	287	390	06/08	>	08/12		S 6088 NE		
prefilter with fuel oil heater / prefiltra con riscaldatore nafta	D2066 Euro4/5/EEV	287	390	06/08	>	08/12		S 6059 NE		
prefilter without fuel oil heater / prefiltra senza riscaldatore nafta	D2066 Euro4/5/EEV	287	390	06/08	>	08/12		S 6062 NE		
power steering / servosterzo	D2066 Euro4/5/EEV	287	390	06/08	>	08/12				S 3081 PO
TGS 35.400	D2066 CR Euro6	294	400	09/12	>		S 5235 PE	S 6011 NE	S 7619 A	S 3165 C
with automatic gearbox and hydraulic retarder ZF 16S / con cambio automatico e rallentatore idraulico ZF 16S	D2066 CR Euro6	294	400	09/12	>					S 2234 Z
with air-conditioner / con climatizzatore	D2066 CR Euro6	294	400	09/12	>					S 4177 CA
inner / interno	D2066 CR Euro6	294	400	09/12	>				S 7616 A	
prefilter / prefiltra	D2066 CR Euro6	294	400	09/12	>			S 4035 NR		
prefilter 300 Micron / prefiltra 300 Micron	D2066 CR Euro6	294	400	09/12	>			S 6088 NE		
power steering / servosterzo	D2066 CR Euro6	294	400	09/12	>					S 3081 PO
TGS 35.400	D2066 Euro4/5/EEV	294	400	10/07	>	08/12	S 5046 PE	S 6011 NE	S 7619 A	S 3165 C
with air-conditioner / con climatizzatore	D2066 Euro4/5/EEV	294	400	10/07	>	08/12				S 4177 CA
inner / interno	D2066 Euro4/5/EEV	294	400	10/07	>	08/12			S 7616 A	
prefilter with fuel oil heater / prefiltra con riscaldatore nafta	D2066 Euro4/5/EEV	294	400	10/07	>	08/12		S 6059 NE		
prefilter without fuel oil heater / prefiltra senza riscaldatore nafta	D2066 Euro4/5/EEV	294	400	10/07	>	08/12		S 6062 NE		
power steering / servosterzo	D2066 Euro4/5/EEV	294	400	10/07	>	08/12				S 3081 PO
TGS 35.420	D2676 CR Euro6	309	420	07/16	>		S 5235 PE	S 6011 NE	S 7F27 A	S 3165 C
with automatic gearbox and hydraulic retarder ZF 16S / con cambio automatico e rallentatore idraulico ZF 16S	D2676 CR Euro6	309	420	07/16	>					S 2234 Z
with air-conditioner / con climatizzatore	D2676 CR Euro6	309	420	07/16	>					S 4177 CA
dryer filter / filtro essiccatore	D2676 CR Euro6	309	420	07/16	>					S 7A66 A
retarder R3500/4100 (TipMatic 12+2) / freno di rallentamento R3500/4100 (TipMatic 12+2)	D2676 CR Euro6	309	420	07/16	>					S 5613 PO
inner / interno	D2676 CR Euro6	309	420	07/16	>				S 7F28 A	
prefilter / prefiltra	D2676 CR Euro6	309	420	07/16	>			S 4035 NR		
prefilter 300 Micron / prefiltra 300 Micron	D2676 CR Euro6	309	420	07/16	>			S 6088 NE		
power steering / servosterzo	D2676 CR Euro6	309	420	07/16	>					S 3081 PO
power steering ZF Servocom RAS-EC / servosterzo ZF Servocom RAS-EC	D2676 CR Euro6	309	420	07/16	>					S 5664 PO
Vehicles for building site / veicoli da cantiere	D2676 CR Euro6	309	420	07/16	>				S 7F29 A	
TGS 35.430	D2066 CR Euro6	316	430	09/12	>	06/16	S 5235 PE	S 6011 NE	S 7619 A	S 3165 C
with automatic gearbox and hydraulic retarder ZF 16S / con cambio automatico e rallentatore idraulico ZF 16S	D2066 CR Euro6	316	430	09/12	>	06/16				S 2234 Z
with air-conditioner / con climatizzatore	D2066 CR Euro6	316	430	09/12	>	06/16				S 4177 CA
retarder R3500/4100 (TipMatic 12+2) / freno di rallentamento R3500/4100 (TipMatic 12+2)	D2066 CR Euro6	316	430	09/12	>	06/16				S 5613 PO
inner / interno	D2066 CR Euro6	316	430	09/12	>	06/16			S 7616 A	
prefilter / prefiltra	D2066 CR Euro6	316	430	09/12	>	06/16		S 4035 NR		
prefilter 300 Micron / prefiltra 300 Micron	D2066 CR Euro6	316	430	09/12	>	06/16		S 6088 NE		
power steering / servosterzo	D2066 CR Euro6	316	430	09/12	>	06/16				S 3081 PO
power steering ZF Servocom RAS-EC / servosterzo ZF Servocom RAS-EC	D2066 CR Euro6	316	430	09/12	>	06/16				S 5664 PO
Vehicles for building site / veicoli da cantiere	D2066 CR Euro6	316	430	09/12	>	06/16			S 7E35 A	
TGS 35.430	D2066 Euro4/5/EEV	316	430	06/08	>	08/12	S 5046 PE	S 6011 NE	S 7619 A	S 3165 C
with air-conditioner / con climatizzatore	D2066 Euro4/5/EEV	316	430	06/08	>	08/12				S 4177 CA
inner / interno	D2066 Euro4/5/EEV	316	430	06/08	>	08/12			S 7616 A	
prefilter 300 Micron / prefiltra 300 Micron	D2066 Euro4/5/EEV	316	430	06/08	>	08/12		S 6088 NE		
prefilter with fuel oil heater / prefiltra con riscaldatore nafta	D2066 Euro4/5/EEV	316	430	06/08	>	08/12		S 6059 NE		
prefilter without fuel oil heater / prefiltra senza riscaldatore nafta	D2066 Euro4/5/EEV	316	430	06/08	>	08/12		S 6062 NE		
power steering / servosterzo	D2066 Euro4/5/EEV	316	430	06/08	>	08/12				S 3081 PO
TGS 35.440	D2066 CR Euro6	324	440	09/12	>		S 5235 PE	S 6011 NE	S 7619 A	S 3165 C
with automatic gearbox and hydraulic retarder ZF 16S / con cambio automatico e rallentatore idraulico ZF 16S	D2066 CR Euro6	324	440	09/12	>					S 2234 Z
with air-conditioner / con climatizzatore	D2066 CR Euro6	324	440	09/12	>					S 4177 CA
inner / interno	D2066 CR Euro6	324	440	09/12	>				S 7616 A	

**KW HP****...MAN - trucks/autocarri**

prefilter / prefiltro	D2066 CR Euro6	324	440	09/12	>		S 4035 NR		
prefilter 300 Micron / prefiltro 300 Micron	D2066 CR Euro6	324	440	09/12	>		S 6088 NE		
power steering / servosterzo	D2066 CR Euro6	324	440	09/12	>				S 3081 PO
TGS 35.440	D2066 Euro4/5/EEV	324	441	10/07	>	08/12	S 5046 PE	S 6011 NE	S 7619 A
with air-conditioner / con climatizzatore	D2066 Euro4/5/EEV	324	441	10/07	>	08/12	S 5046 PE	S 6011 NE	S 7619 A
inner / interno	D2066 Euro4/5/EEV	324	441	10/07	>	08/12			S 7616 A
prefilter with fuel oil heater / prefiltro con riscaldatore nafta	D2066 Euro4/5/EEV	324	441	10/07	>	08/12		S 6059 NE	
prefilter without fuel oil heater / prefiltro senza riscaldatore nafta	D2066 Euro4/5/EEV	324	441	10/07	>	08/12		S 6062 NE	
power steering / servosterzo	D2066 Euro4/5/EEV	324	441	10/07	>	08/12			S 3081 PO
TGS 35.480	D2676 CR Euro6	353	480	09/12	>	07/16	S 5235 PE	S 6011 NE	S 7619 A
with automatic gearbox and hydraulic retarder ZF 16S / con cambio automatico e rallentatore idraulico ZF 16S	D2676 CR Euro6	353	480	09/12	>	07/16			S 3165 C
with air-conditioner / con climatizzatore	D2676 CR Euro6	353	480	09/12	>	07/16			S 2234 Z
inner / interno	D2676 CR Euro6	353	480	09/12	>	07/16			S 4177 CA
prefilter / prefiltro	D2676 CR Euro6	353	480	09/12	>	07/16		S 4035 NR	
prefilter 300 Micron / prefiltro 300 Micron	D2676 CR Euro6	353	480	09/12	>	07/16		S 6088 NE	
power steering / servosterzo	D2676 CR Euro6	353	480	09/12	>	07/16			S 3081 PO
TGS 35.480	D2676 Euro4/5/EEV	353	480	10/07	>	08/12	S 5046 PE	S 6011 NE	S 7619 A
with air-conditioner / con climatizzatore	D2676 Euro4/5/EEV	353	480	10/07	>	08/12			S 3165 C
inner / interno	D2676 Euro4/5/EEV	353	480	10/07	>	08/12			S 4177 CA
prefilter with fuel oil heater / prefiltro con riscaldatore nafta	D2676 Euro4/5/EEV	353	480	10/07	>	08/12		S 6059 NE	
prefilter without fuel oil heater / prefiltro senza riscaldatore nafta	D2676 Euro4/5/EEV	353	480	10/07	>	08/12		S 6062 NE	
power steering / servosterzo	D2676 Euro4/5/EEV	353	480	10/07	>	08/12			S 3081 PO
TGS 35.500	D2676 CR Euro6	468	500	07/16	>		S 5235 PE	S 6011 NE	S 3165 C
with air-conditioner / con climatizzatore	D2676 CR Euro6	468	500	07/16	>				S 4177 CA
dryer filter / filtro essiccatore	D2676 CR Euro6	468	500	07/16	>				S 7A66 A
prefilter / prefiltro	D2676 CR Euro6	468	500	07/16	>			S 4035 NR	
prefilter 300 Micron / prefiltro 300 Micron	D2676 CR Euro6	468	500	07/16	>			S 6088 NE	
power steering / servosterzo	D2676 CR Euro6	468	500	07/16	>				S 3081 PO
power steering ZF Servocom RAS-EC / servosterzo ZF Servocom RAS-EC	D2676 CR Euro6	468	500	07/16	>				S 5664 PO
TGS 35.540	D2676 Euro4/5/EEV	397	540	10/07	>	08/12	S 5046 PE	S 6011 NE	S 7619 A
with air-conditioner / con climatizzatore	D2676 Euro4/5/EEV	397	540	10/07	>	08/12			S 3165 C
inner / interno	D2676 Euro4/5/EEV	397	540	10/07	>	08/12			S 4177 CA
prefilter with fuel oil heater / prefiltro con riscaldatore nafta	D2676 Euro4/5/EEV	397	540	10/07	>	08/12		S 6059 NE	
prefilter without fuel oil heater / prefiltro senza riscaldatore nafta	D2676 Euro4/5/EEV	397	540	10/07	>	08/12		S 6062 NE	
power steering / servosterzo	D2676 Euro4/5/EEV	397	540	10/07	>	08/12			S 3081 PO
TGS 37.420	D2676 CR Euro6	309	420	07/16	>		S 5235 PE	S 6011 NE	S 7F27 A
with automatic gearbox and hydraulic retarder ZF 16S / con cambio automatico e rallentatore idraulico ZF 16S	D2676 CR Euro6	309	420	07/16	>				S 3165 C
with air-conditioner / con climatizzatore	D2676 CR Euro6	309	420	07/16	>				S 2234 Z
dryer filter / filtro essiccatore	D2676 CR Euro6	309	420	07/16	>				S 4177 CA
retarder R3500/4100 (TipMatic 12+2) / freno di rallentamento R3500/4100 (TipMatic 12+2)	D2676 CR Euro6	309	420	07/16	>				S 7A66 A
inner / interno	D2676 CR Euro6	309	420	07/16	>				S 5613 PO
prefilter / prefiltro	D2676 CR Euro6	309	420	07/16	>			S 4035 NR	
prefilter 300 Micron / prefiltro 300 Micron	D2676 CR Euro6	309	420	07/16	>			S 6088 NE	
power steering / servosterzo	D2676 CR Euro6	309	420	07/16	>				S 3081 PO
power steering ZF Servocom RAS-EC / servosterzo ZF Servocom RAS-EC	D2676 CR Euro6	309	420	07/16	>				S 5664 PO
Vehicles for building site / veicoli da cantiere	D2676 CR Euro6	309	420	07/16	>				S 7F29 A
TGS 39.320	D2066 CR Euro6	235	320	09/12	>	06/16	S 5235 PE	S 6011 NE	S 7619 A
	D2066 CR Euro6	235	320	07/16	>		S 5235 PE	S 6011 NE	S 7F27 A
with automatic gearbox and hydraulic retarder ZF 16S / con cambio automatico e rallentatore idraulico ZF 16S	D2066 CR Euro6	235	320	09/12	>				S 3165 C
with air-conditioner / con climatizzatore	D2066 CR Euro6	235	320	09/12	>				S 2234 Z
dryer filter / filtro essiccatore	D2066 CR Euro6	235	320	09/12	>				S 4177 CA
retarder R3500/4100 (TipMatic 12+2) / freno di rallentamento R3500/4100 (TipMatic 12+2)	D2066 CR Euro6	235	320	07/16	>				S 7A66 A
inner / interno	D2066 CR Euro6	235	320	09/12	>	06/16			S 5613 PO
inner / interno	D2066 CR Euro6	235	320	07/16	>				S 7616 A
prefilter / prefiltro	D2066 CR Euro6	235	320	09/12	>				S 7F28 A
prefilter 300 Micron / prefiltro 300 Micron	D2066 CR Euro6	235	320	09/12	>			S 4035 NR	
power steering / servosterzo	D2066 CR Euro6	235	320	09/12	>			S 6088 NE	
power steering ZF Servocom RAS-EC / servosterzo ZF Servocom RAS-EC	D2066 CR Euro6	235	320	09/12	>				S 3081 PO
Vehicles for building site / veicoli da cantiere	D2066 CR Euro6	235	320	09/12	>	06/16			S 5664 PO
Vehicles for building site / veicoli da cantiere	D2066 CR Euro6	235	320	07/16	>				S 7E35 A
TGS 39.320	D2066 Euro4/5/EEV	235	320	10/07	>	08/12	S 5046 PE	S 6011 NE	S 7619 A
with air-conditioner / con climatizzatore	D2066 Euro4/5/EEV	235	320	10/07	>	08/12			S 3165 C
inner / interno	D2066 Euro4/5/EEV	235	320	10/07	>	08/12			S 4177 CA
prefilter 300 Micron / prefiltro 300 Micron	D2066 Euro4/5/EEV	235	320	10/07	>	08/12			S 7616 A
prefilter with fuel oil heater / prefiltro con riscaldatore nafta	D2066 Euro4/5/EEV	235	320	10/07	>	08/12		S 6088 NE	
prefilter without fuel oil heater / prefiltro senza riscaldatore nafta	D2066 Euro4/5/EEV	235	320	10/07	>	08/12		S 6059 NE	
power steering / servosterzo	D2066 Euro4/5/EEV	235	320	10/07	>	08/12		S 6062 NE	
	D2066 Euro4/5/EEV	235	320	10/07	>	08/12			S 3081 PO

M

**KW HP****...MAN - trucks/autocarri**

TGS 39.360	D2066 CR Euro6	265	360	09/12	>	06/16	S 5235 PE	S 6011 NE	S 7619 A	S 3165 C
	D2066 CR Euro6	265	360	07/16	>		S 5235 PE	S 6011 NE	S 7F27 A	S 3165 C
with automatic gearbox and hydraulic retarder ZF 16S / con cambio automatico e rallentatore idraulico ZF 16S	D2066 CR Euro6	265	360	09/12	>					S 2234 Z
with air-conditioner / con climatizzatore	D2066 CR Euro6	265	360	09/12	>					S 4177 CA
retarder R3500/4100 (TipMatic 12+2) / freno di rallentamento R3500/4100 (TipMatic 12+2)	D2066 CR Euro6	265	360	07/16	>					S 5613 PO
inner / interno	D2066 CR Euro6	265	360	09/12	>	06/16			S 7616 A	
inner / interno	D2066 CR Euro6	265	360	07/16	>				S 7F28 A	
prefilter / prefiltro	D2066 CR Euro6	265	360	09/12	>			S 4035 NR		
prefilter 300 Micron / prefiltro 300 Micron	D2066 CR Euro6	265	360	09/12	>			S 6088 NE		
power steering / servosterzo	D2066 CR Euro6	265	360	09/12	>					S 3081 PO
power steering ZF Servocom RAS-EC / servosterzo ZF Servocom RAS-EC	D2066 CR Euro6	265	360	09/12	>					S 5664 PO
Vehicles for building site / veicoli da cantiere	D2066 CR Euro6	265	360	09/12	>	06/16			S 7E35 A	
Vehicles for building site / veicoli da cantiere	D2066 CR Euro6	265	360	07/16	>				S 7F29 A	
TGS 39.360	D2066 Euro4/5/EEV	265	360	10/07	>	08/12	S 5046 PE	S 6011 NE	S 7619 A	S 3165 C
with air-conditioner / con climatizzatore	D2066 Euro4/5/EEV	265	360	10/07	>	08/12	S 5046 PE	S 6011 NE	S 7619 A	S 4177 CA
inner / interno	D2066 Euro4/5/EEV	265	360	10/07	>	08/12			S 7616 A	
prefilter with fuel oil heater / prefiltro con riscaldatore nafta	D2066 Euro4/5/EEV	265	360	10/07	>	08/12		S 6059 NE		
prefilter without fuel oil heater / prefiltro senza riscaldatore nafta	D2066 Euro4/5/EEV	265	360	10/07	>	08/12		S 6062 NE		
power steering / servosterzo	D2066 Euro4/5/EEV	265	360	10/07	>	08/12				S 3081 PO
TGS 39.400	D2066 CR Euro6	294	400	09/12	>		S 5235 PE	S 6011 NE	S 7619 A	S 3165 C
with automatic gearbox and hydraulic retarder ZF 16S / con cambio automatico e rallentatore idraulico ZF 16S	D2066 CR Euro6	294	400	09/12	>					S 2234 Z
with air-conditioner / con climatizzatore	D2066 CR Euro6	294	400	09/12	>					S 4177 CA
inner / interno	D2066 CR Euro6	294	400	09/12	>				S 7616 A	
prefilter / prefiltro	D2066 CR Euro6	294	400	09/12	>			S 4035 NR		
prefilter 300 Micron / prefiltro 300 Micron	D2066 CR Euro6	294	400	09/12	>			S 6088 NE		
power steering / servosterzo	D2066 CR Euro6	294	400	09/12	>					S 3081 PO
TGS 39.400	D2066 Euro4/5/EEV	294	400	10/07	>	08/12	S 5046 PE	S 6011 NE	S 7619 A	S 3165 C
with air-conditioner / con climatizzatore	D2066 Euro4/5/EEV	294	400	10/07	>	08/12				S 4177 CA
inner / interno	D2066 Euro4/5/EEV	294	400	10/07	>	08/12			S 7616 A	
prefilter with fuel oil heater / prefiltro con riscaldatore nafta	D2066 Euro4/5/EEV	294	400	10/07	>	08/12		S 6059 NE		
prefilter without fuel oil heater / prefiltro senza riscaldatore nafta	D2066 Euro4/5/EEV	294	400	10/07	>	08/12		S 6062 NE		
power steering / servosterzo	D2066 Euro4/5/EEV	294	400	10/07	>	08/12				S 3081 PO
TGS 39.420	D2676 CR Euro6	309	420	07/16	>		S 5235 PE	S 6011 NE	S 7F27 A	S 3165 C
with automatic gearbox and hydraulic retarder ZF 16S / con cambio automatico e rallentatore idraulico ZF 16S	D2676 CR Euro6	309	420	07/16	>					S 2234 Z
with air-conditioner / con climatizzatore	D2676 CR Euro6	309	420	07/16	>					S 4177 CA
dryer filter / filtro essiccatore	D2676 CR Euro6	309	420	07/16	>					S 7A66 A
retarder R3500/4100 (TipMatic 12+2) / freno di rallentamento R3500/4100 (TipMatic 12+2)	D2676 CR Euro6	309	420	07/16	>					S 5613 PO
inner / interno	D2676 CR Euro6	309	420	07/16	>				S 7F28 A	
prefilter / prefiltro	D2676 CR Euro6	309	420	07/16	>			S 4035 NR		
prefilter 300 Micron / prefiltro 300 Micron	D2676 CR Euro6	309	420	07/16	>			S 6088 NE		
power steering / servosterzo	D2676 CR Euro6	309	420	07/16	>					S 3081 PO
power steering ZF Servocom RAS-EC / servosterzo ZF Servocom RAS-EC	D2676 CR Euro6	309	420	07/16	>					S 5664 PO
Vehicles for building site / veicoli da cantiere	D2676 CR Euro6	309	420	07/16	>				S 7F29 A	
TGS 39.440	D2066 CR Euro6	324	440	09/12	>		S 5235 PE	S 6011 NE	S 7619 A	S 3165 C
with automatic gearbox and hydraulic retarder ZF 16S / con cambio automatico e rallentatore idraulico ZF 16S	D2066 CR Euro6	324	440	09/12	>					S 2234 Z
with air-conditioner / con climatizzatore	D2066 CR Euro6	324	440	09/12	>					S 4177 CA
inner / interno	D2066 CR Euro6	324	440	09/12	>				S 7616 A	
prefilter / prefiltro	D2066 CR Euro6	324	440	09/12	>			S 4035 NR		
prefilter 300 Micron / prefiltro 300 Micron	D2066 CR Euro6	324	440	09/12	>			S 6088 NE		
power steering / servosterzo	D2066 CR Euro6	324	440	09/12	>					S 3081 PO
TGS 39.440	D2066 Euro4/5/EEV	324	441	10/07	>	08/12	S 5046 PE	S 6011 NE	S 7619 A	S 3165 C
with air-conditioner / con climatizzatore	D2066 Euro4/5/EEV	324	441	10/07	>	08/12	S 5046 PE	S 6011 NE	S 7619 A	S 4177 CA
inner / interno	D2066 Euro4/5/EEV	324	441	10/07	>	08/12			S 7616 A	
prefilter with fuel oil heater / prefiltro con riscaldatore nafta	D2066 Euro4/5/EEV	324	441	10/07	>	08/12		S 6059 NE		
prefilter without fuel oil heater / prefiltro senza riscaldatore nafta	D2066 Euro4/5/EEV	324	441	10/07	>	08/12		S 6062 NE		
power steering / servosterzo	D2066 Euro4/5/EEV	324	441	10/07	>	08/12				S 3081 PO
TGS 39.480	D2676 CR Euro6	353	480	09/12	>	07/16	S 5235 PE	S 6011 NE	S 7619 A	S 3165 C
with automatic gearbox and hydraulic retarder ZF 16S / con cambio automatico e rallentatore idraulico ZF 16S	D2676 CR Euro6	353	480	09/12	>	07/16				S 2234 Z
with air-conditioner / con climatizzatore	D2676 CR Euro6	353	480	09/12	>	07/16				S 4177 CA
inner / interno	D2676 CR Euro6	353	480	09/12	>	07/16			S 7616 A	
prefilter / prefiltro	D2676 CR Euro6	353	480	09/12	>	07/16		S 4035 NR		
prefilter 300 Micron / prefiltro 300 Micron	D2676 CR Euro6	353	480	09/12	>	07/16		S 6088 NE		
power steering / servosterzo	D2676 CR Euro6	353	480	09/12	>	07/16				S 3081 PO
TGS 39.480	D2676 Euro4/5/EEV	353	480	10/07	>	08/12	S 5046 PE	S 6011 NE	S 7619 A	S 3165 C
with air-conditioner / con climatizzatore	D2676 Euro4/5/EEV	353	480	10/07	>	08/12				S 4177 CA
inner / interno	D2676 Euro4/5/EEV	353	480	10/07	>	08/12			S 7616 A	
prefilter with fuel oil heater / prefiltro con riscaldatore nafta	D2676 Euro4/5/EEV	353	480	10/07	>	08/12		S 6059 NE		

**KW HP****...MAN - trucks/autocarri**

prefilter without fuel oil heater / prefiltro senza riscaldatore nafta	D2676 Euro4/5/EEV	353	480	10/07	>	08/12		S 6062 NE		
power steering / servosterzo	D2676 Euro4/5/EEV	353	480	10/07	>	08/12				S 3081 PO
TGS 39.540	D2676 Euro4/5/EEV	397	540	10/07	>	08/12	S 5046 PE	S 6011 NE	S 7619 A	S 3165 C
with air-conditioner / con climatizzatore	D2676 Euro4/5/EEV	397	540	10/07	>	08/12				S 4177 CA
inner / interno	D2676 Euro4/5/EEV	397	540	10/07	>	08/12			S 7616 A	
prefilter with fuel oil heater / prefiltro con riscaldatore nafta	D2676 Euro4/5/EEV	397	540	10/07	>	08/12		S 6059 NE		
prefilter without fuel oil heater / prefiltro senza riscaldatore nafta	D2676 Euro4/5/EEV	397	540	10/07	>	08/12		S 6062 NE		
power steering / servosterzo	D2676 Euro4/5/EEV	397	540	10/07	>	08/12				S 3081 PO
TGS 40.320	D2066 CR Euro6	235	320	09/12	>	06/16	S 5235 PE	S 6011 NE	S 7619 A	S 3165 C
	D2066 CR Euro6	235	320	07/16	>		S 5235 PE	S 6011 NE	S 7F27 A	S 3165 C
with automatic gearbox and hydraulic retarder ZF 16S / con cambio automatico e rallentatore idraulico ZF 16S	D2066 CR Euro6	235	320	09/12	>					S 2234 Z
with air-conditioner / con climatizzatore	D2066 CR Euro6	235	320	09/12	>					S 4177 CA
dryer filter / filtro essiccatore	D2066 CR Euro6	235	320	09/12	>					S 7A66 A
retarder R3500/4100 (TipMatic 12+2) / freno di rallentamento R3500/4100 (TipMatic 12+2)	D2066 CR Euro6	235	320	07/16	>					S 5613 PO
inner / interno	D2066 CR Euro6	235	320	09/12	>	06/16			S 7616 A	
inner / interno	D2066 CR Euro6	235	320	07/16	>				S 7F28 A	
prefilter / prefiltro	D2066 CR Euro6	235	320	09/12	>			S 4035 NR		
prefilter 300 Micron / prefiltro 300 Micron	D2066 CR Euro6	235	320	09/12	>			S 6088 NE		
power steering / servosterzo	D2066 CR Euro6	235	320	09/12	>					S 3081 PO
power steering ZF Servocom RAS-EC / servosterzo ZF Servocom RAS-EC	D2066 CR Euro6	235	320	09/12	>					S 5664 PO
Vehicles for building site / veicoli da cantiere	D2066 CR Euro6	235	320	09/12	>	06/16			S 7E35 A	
Vehicles for building site / veicoli da cantiere	D2066 CR Euro6	235	320	07/16	>				S 7F29 A	
TGS 40.320	D2066 Euro4/5/EEV	235	320	10/07	>	08/12	S 5046 PE	S 6011 NE	S 7619 A	S 3165 C
with air-conditioner / con climatizzatore	D2066 Euro4/5/EEV	235	320	10/07	>	08/12				S 4177 CA
inner / interno	D2066 Euro4/5/EEV	235	320	10/07	>	08/12			S 7616 A	
prefilter 300 Micron / prefiltro 300 Micron	D2066 Euro4/5/EEV	235	320	10/07	>	08/12		S 6088 NE		
prefilter with fuel oil heater / prefiltro con riscaldatore nafta	D2066 Euro4/5/EEV	235	320	10/07	>	08/12		S 6059 NE		
prefilter without fuel oil heater / prefiltro senza riscaldatore nafta	D2066 Euro4/5/EEV	235	320	10/07	>	08/12		S 6062 NE		
power steering / servosterzo	D2066 Euro4/5/EEV	235	320	10/07	>	08/12				S 3081 PO
TGS 40.390	D2066 CR Euro6	287	390	09/12	>	06/16	S 5235 PE	S 6011 NE	S 7619 A	S 3165 C
with automatic gearbox and hydraulic retarder ZF 16S / con cambio automatico e rallentatore idraulico ZF 16S	D2066 CR Euro6	287	390	09/12	>	06/16				S 2234 Z
with air-conditioner / con climatizzatore	D2066 CR Euro6	287	390	09/12	>	06/16				S 4177 CA
retarder R3500/4100 (TipMatic 12+2) / freno di rallentamento R3500/4100 (TipMatic 12+2)	D2066 CR Euro6	287	390	09/12	>	06/16				S 5613 PO
inner / interno	D2066 CR Euro6	287	390	09/12	>	06/16			S 7616 A	
prefilter / prefiltro	D2066 CR Euro6	287	390	09/12	>	06/16		S 4035 NR		
prefilter 300 Micron / prefiltro 300 Micron	D2066 CR Euro6	287	390	09/12	>	06/16		S 6088 NE		
power steering / servosterzo	D2066 CR Euro6	287	390	09/12	>	06/16				S 3081 PO
power steering ZF Servocom RAS-EC / servosterzo ZF Servocom RAS-EC	D2066 CR Euro6	287	390	09/12	>	06/16				S 5664 PO
Vehicles for building site / veicoli da cantiere	D2066 CR Euro6	287	390	09/12	>	06/16			S 7E35 A	
TGS 40.390	D2066 Euro4/5/EEV	287	390	06/08	>	08/12	S 5046 PE	S 6011 NE	S 7619 A	S 3165 C
with air-conditioner / con climatizzatore	D2066 Euro4/5/EEV	287	390	06/08	>	08/12				S 4177 CA
inner / interno	D2066 Euro4/5/EEV	287	390	06/08	>	08/12			S 7616 A	
prefilter 300 Micron / prefiltro 300 Micron	D2066 Euro4/5/EEV	287	390	06/08	>	08/12		S 6088 NE		
prefilter with fuel oil heater / prefiltro con riscaldatore nafta	D2066 Euro4/5/EEV	287	390	06/08	>	08/12		S 6059 NE		
prefilter without fuel oil heater / prefiltro senza riscaldatore nafta	D2066 Euro4/5/EEV	287	390	06/08	>	08/12		S 6062 NE		
power steering / servosterzo	D2066 Euro4/5/EEV	287	390	06/08	>	08/12				S 3081 PO
TGS 40.400	D2066 CR Euro6	294	400	09/12	>		S 5235 PE	S 6011 NE	S 7619 A	S 3165 C
with automatic gearbox and hydraulic retarder ZF 16S / con cambio automatico e rallentatore idraulico ZF 16S	D2066 CR Euro6	294	400	09/12	>					S 2234 Z
with air-conditioner / con climatizzatore	D2066 CR Euro6	294	400	09/12	>					S 4177 CA
inner / interno	D2066 CR Euro6	294	400	09/12	>				S 7616 A	
prefilter / prefiltro	D2066 CR Euro6	294	400	09/12	>			S 4035 NR		
prefilter 300 Micron / prefiltro 300 Micron	D2066 CR Euro6	294	400	09/12	>			S 6088 NE		
power steering / servosterzo	D2066 CR Euro6	294	400	09/12	>					S 3081 PO
TGS 40.420	D2676 CR Euro6	309	420	07/16	>		S 5235 PE	S 6011 NE	S 7F27 A	S 3165 C
with automatic gearbox and hydraulic retarder ZF 16S / con cambio automatico e rallentatore idraulico ZF 16S	D2676 CR Euro6	309	420	07/16	>					S 2234 Z
with air-conditioner / con climatizzatore	D2676 CR Euro6	309	420	07/16	>					S 4177 CA
dryer filter / filtro essiccatore	D2676 CR Euro6	309	420	07/16	>					S 7A66 A
retarder R3500/4100 (TipMatic 12+2) / freno di rallentamento R3500/4100 (TipMatic 12+2)	D2676 CR Euro6	309	420	07/16	>					S 5613 PO
inner / interno	D2676 CR Euro6	309	420	07/16	>				S 7F28 A	
prefilter / prefiltro	D2676 CR Euro6	309	420	07/16	>			S 4035 NR		
prefilter 300 Micron / prefiltro 300 Micron	D2676 CR Euro6	309	420	07/16	>			S 6088 NE		
power steering / servosterzo	D2676 CR Euro6	309	420	07/16	>					S 3081 PO
power steering ZF Servocom RAS-EC / servosterzo ZF Servocom RAS-EC	D2676 CR Euro6	309	420	07/16	>					S 5664 PO
Vehicles for building site / veicoli da cantiere	D2676 CR Euro6	309	420	07/16	>				S 7F29 A	
TGS 40.430	D2066 CR Euro6	316	430	09/12	>	06/16	S 5235 PE	S 6011 NE	S 7619 A	S 3165 C
with automatic gearbox and hydraulic retarder ZF 16S / con cambio automatico e rallentatore idraulico ZF 16S	D2066 CR Euro6	316	430	09/12	>	06/16				S 2234 Z
with air-conditioner / con climatizzatore	D2066 CR Euro6	316	430	09/12	>	06/16				S 4177 CA

M

**KW HP****...MAN - trucks/autocarri**

retarder R3500/4100 (TipMatic 12+2) / freno di rallentamento R3500/4100 (TipMatic 12+2)	D2066 CR Euro6	316	430	09/12	>	06/16			S 7616 A	S 5613 PO
inner / interno	D2066 CR Euro6	316	430	09/12	>	06/16				
prefilter / prefiltro	D2066 CR Euro6	316	430	09/12	>	06/16		S 4035 NR		
prefilter 300 Micron / prefiltro 300 Micron	D2066 CR Euro6	316	430	09/12	>	06/16		S 6088 NE		
power steering / servosterzo	D2066 CR Euro6	316	430	09/12	>	06/16				S 3081 PO
power steering ZF Servocom RAS-EC / servosterzo ZF Servocom RAS-EC	D2066 CR Euro6	316	430	09/12	>	06/16				S 5664 PO
Vehicles for building site / veicoli da cantiere	D2066 CR Euro6	316	430	09/12	>	06/16			S 7E35 A	
TGS 40.430	D2066 Euro4/5/EEV	316	430	06/08	>	08/12	S 5046 PE	S 6011 NE	S 7619 A	S 3165 C
with air-conditioner / con climatizzatore	D2066 Euro4/5/EEV	316	430	06/08	>	08/12				S 4177 CA
inner / interno	D2066 Euro4/5/EEV	316	430	06/08	>	08/12			S 7616 A	
prefilter 300 Micron / prefiltro 300 Micron	D2066 Euro4/5/EEV	316	430	06/08	>	08/12		S 6088 NE		
prefilter with fuel oil heater / prefiltro con riscaldatore nafta	D2066 Euro4/5/EEV	316	430	06/08	>	08/12		S 6059 NE		
prefilter without fuel oil heater / prefiltro senza riscaldatore nafta	D2066 Euro4/5/EEV	316	430	06/08	>	08/12		S 6062 NE		
power steering / servosterzo	D2066 Euro4/5/EEV	316	430	06/08	>	08/12				S 3081 PO
TGS 40.440	D2066 CR Euro6	324	440	09/12	>		S 5235 PE	S 6011 NE	S 7619 A	S 3165 C
with automatic gearbox and hydraulic retarder ZF 16S / con cambio automatico e rallentatore idraulico ZF 16S	D2066 CR Euro6	324	440	09/12	>					S 2234 Z
with air-conditioner / con climatizzatore	D2066 CR Euro6	324	440	09/12	>				S 7616 A	S 4177 CA
inner / interno	D2066 CR Euro6	324	440	09/12	>					
prefilter / prefiltro	D2066 CR Euro6	324	440	09/12	>			S 4035 NR		
prefilter 300 Micron / prefiltro 300 Micron	D2066 CR Euro6	324	440	09/12	>			S 6088 NE		
power steering / servosterzo	D2066 CR Euro6	324	440	09/12	>					S 3081 PO
TGS 40.480	D2676 CR Euro6	353	480	09/12	>	07/16	S 5235 PE	S 6011 NE	S 7619 A	S 3165 C
with automatic gearbox and hydraulic retarder ZF 16S / con cambio automatico e rallentatore idraulico ZF 16S	D2676 CR Euro6	353	480	09/12	>	07/16				S 2234 Z
with air-conditioner / con climatizzatore	D2676 CR Euro6	353	480	09/12	>	07/16				S 4177 CA
inner / interno	D2676 CR Euro6	353	480	09/12	>	07/16			S 7616 A	
prefilter / prefiltro	D2676 CR Euro6	353	480	09/12	>	07/16		S 4035 NR		
prefilter 300 Micron / prefiltro 300 Micron	D2676 CR Euro6	353	480	09/12	>	07/16		S 6088 NE		
power steering / servosterzo	D2676 CR Euro6	353	480	09/12	>	07/16				S 3081 PO
TGS 40.480	D2676 Euro4/5/EEV	353	480	10/07	>	08/12	S 5046 PE	S 6011 NE	S 7619 A	S 3165 C
with air-conditioner / con climatizzatore	D2676 Euro4/5/EEV	353	480	10/07	>	08/12				S 4177 CA
inner / interno	D2676 Euro4/5/EEV	353	480	10/07	>	08/12			S 7616 A	
prefilter with fuel oil heater / prefiltro con riscaldatore nafta	D2676 Euro4/5/EEV	353	480	10/07	>	08/12		S 6059 NE		
prefilter without fuel oil heater / prefiltro senza riscaldatore nafta	D2676 Euro4/5/EEV	353	480	10/07	>	08/12		S 6062 NE		
power steering / servosterzo	D2676 Euro4/5/EEV	353	480	10/07	>	08/12				S 3081 PO
TGS 41.320	D2066 CR Euro6	235	320	09/12	>	06/16	S 5235 PE	S 6011 NE	S 7619 A	S 3165 C
	D2066 CR Euro6	235	320	07/16	>		S 5235 PE	S 6011 NE	S 7F27 A	S 3165 C
with automatic gearbox and hydraulic retarder ZF 16S / con cambio automatico e rallentatore idraulico ZF 16S	D2066 CR Euro6	235	320	09/12	>					S 2234 Z
with air-conditioner / con climatizzatore	D2066 CR Euro6	235	320	09/12	>					S 4177 CA
dryer filter / filtro essiccatore	D2066 CR Euro6	235	320	09/12	>					S 7A66 A
retarder R3500/4100 (TipMatic 12+2) / freno di rallentamento R3500/4100 (TipMatic 12+2)	D2066 CR Euro6	235	320	07/16	>					S 5613 PO
inner / interno	D2066 CR Euro6	235	320	09/12	>	06/16			S 7616 A	
inner / interno	D2066 CR Euro6	235	320	07/16	>				S 7F28 A	
prefilter / prefiltro	D2066 CR Euro6	235	320	09/12	>			S 4035 NR		
prefilter 300 Micron / prefiltro 300 Micron	D2066 CR Euro6	235	320	09/12	>			S 6088 NE		
power steering / servosterzo	D2066 CR Euro6	235	320	09/12	>					S 3081 PO
power steering ZF Servocom RAS-EC / servosterzo ZF Servocom RAS-EC	D2066 CR Euro6	235	320	09/12	>					S 5664 PO
Vehicles for building site / veicoli da cantiere	D2066 CR Euro6	235	320	09/12	>	06/16			S 7E35 A	
Vehicles for building site / veicoli da cantiere	D2066 CR Euro6	235	320	07/16	>				S 7F29 A	
TGS 41.320	D2066 Euro4/5/EEV	235	320	06/08	>	08/12	S 5046 PE	S 6011 NE	S 7619 A	S 3165 C
with air-conditioner / con climatizzatore	D2066 Euro4/5/EEV	235	320	06/08	>	08/12				S 4177 CA
inner / interno	D2066 Euro4/5/EEV	235	320	06/08	>	08/12			S 7616 A	
prefilter 300 Micron / prefiltro 300 Micron	D2066 Euro4/5/EEV	235	320	06/08	>	08/12		S 6088 NE		
prefilter with fuel oil heater / prefiltro con riscaldatore nafta	D2066 Euro4/5/EEV	235	320	06/08	>	08/12		S 6059 NE		
prefilter without fuel oil heater / prefiltro senza riscaldatore nafta	D2066 Euro4/5/EEV	235	320	06/08	>	08/12		S 6062 NE		
power steering / servosterzo	D2066 Euro4/5/EEV	235	320	06/08	>	08/12				S 3081 PO
TGS 41.390	D2066 CR Euro6	287	390	09/12	>	06/16	S 5235 PE	S 6011 NE	S 7619 A	S 3165 C
with automatic gearbox and hydraulic retarder ZF 16S / con cambio automatico e rallentatore idraulico ZF 16S	D2066 CR Euro6	287	390	09/12	>	06/16				S 2234 Z
with air-conditioner / con climatizzatore	D2066 CR Euro6	287	390	09/12	>	06/16				S 4177 CA
retarder R3500/4100 (TipMatic 12+2) / freno di rallentamento R3500/4100 (TipMatic 12+2)	D2066 CR Euro6	287	390	09/12	>	06/16				S 5613 PO
inner / interno	D2066 CR Euro6	287	390	09/12	>	06/16			S 7616 A	
prefilter / prefiltro	D2066 CR Euro6	287	390	09/12	>	06/16		S 4035 NR		
prefilter 300 Micron / prefiltro 300 Micron	D2066 CR Euro6	287	390	09/12	>	06/16		S 6088 NE		
power steering / servosterzo	D2066 CR Euro6	287	390	09/12	>	06/16				S 3081 PO
power steering ZF Servocom RAS-EC / servosterzo ZF Servocom RAS-EC	D2066 CR Euro6	287	390	09/12	>	06/16				S 5664 PO
Vehicles for building site / veicoli da cantiere	D2066 CR Euro6	287	390	09/12	>	06/16			S 7E35 A	
TGS 41.390	D2066 Euro4/5/EEV	287	390	06/08	>	08/12	S 5046 PE	S 6011 NE	S 7619 A	S 3165 C
with air-conditioner / con climatizzatore	D2066 Euro4/5/EEV	287	390	06/08	>	08/12				S 4177 CA



...MAN - trucks/autocarri

inner / interno	D2066 Euro4/5/EEV	287	390	06/08	>	08/12			S 7616 A	
prefilter 300 Micron / prefiltro 300 Micron	D2066 Euro4/5/EEV	287	390	06/08	>	08/12		S 6088 NE		
prefilter with fuel oil heater / prefiltro con riscaldatore nafta	D2066 Euro4/5/EEV	287	390	06/08	>	08/12		S 6059 NE		
prefilter without fuel oil heater / prefiltro senza riscaldatore nafta	D2066 Euro4/5/EEV	287	390	06/08	>	08/12		S 6062 NE		
power steering / servosterzo	D2066 Euro4/5/EEV	287	390	06/08	>	08/12				S 3081 PO
TGS 41.420	D2676 CR Euro6	309	420	07/16	>		S 5235 PE	S 6011 NE	S 7F27 A	S 3165 C
with automatic gearbox and hydraulic retarder ZF 16S / con cambio automatico e rallentatore idraulico ZF 16S	D2676 CR Euro6	309	420	07/16	>					S 2234 Z
with air-conditioner / con climatizzatore	D2676 CR Euro6	309	420	07/16	>					S 4177 CA
dryer filter / filtro essiccatore	D2676 CR Euro6	309	420	07/16	>					S 7A66 A
retarder R3500/4100 (TipMatic 12+2) / freno di rallentamento R3500/4100 (TipMatic 12+2)	D2676 CR Euro6	309	420	07/16	>					S 5613 PO
inner / interno	D2676 CR Euro6	309	420	07/16	>				S 7F28 A	
prefilter / prefiltro	D2676 CR Euro6	309	420	07/16	>			S 4035 NR		
prefilter 300 Micron / prefiltro 300 Micron	D2676 CR Euro6	309	420	07/16	>			S 6088 NE		
power steering / servosterzo	D2676 CR Euro6	309	420	07/16	>					S 3081 PO
power steering ZF Servocom RAS-EC / servosterzo ZF Servocom RAS-EC	D2676 CR Euro6	309	420	07/16	>					S 5664 PO
Vehicles for building site / veicoli da cantiere	D2676 CR Euro6	309	420	07/16	>					S 7F29 A
TGS 41.430	D2066 CR Euro6	316	430	09/12	>	06/16	S 5235 PE	S 6011 NE	S 7619 A	S 3165 C
with automatic gearbox and hydraulic retarder ZF 16S / con cambio automatico e rallentatore idraulico ZF 16S	D2066 CR Euro6	316	430	09/12	>	06/16				S 2234 Z
with air-conditioner / con climatizzatore	D2066 CR Euro6	316	430	09/12	>	06/16				S 4177 CA
retarder R3500/4100 (TipMatic 12+2) / freno di rallentamento R3500/4100 (TipMatic 12+2)	D2066 CR Euro6	316	430	09/12	>	06/16				S 5613 PO
inner / interno	D2066 CR Euro6	316	430	09/12	>	06/16			S 7616 A	
prefilter / prefiltro	D2066 CR Euro6	316	430	09/12	>	06/16		S 4035 NR		
prefilter 300 Micron / prefiltro 300 Micron	D2066 CR Euro6	316	430	09/12	>	06/16		S 6088 NE		
power steering / servosterzo	D2066 CR Euro6	316	430	09/12	>	06/16				S 3081 PO
power steering ZF Servocom RAS-EC / servosterzo ZF Servocom RAS-EC	D2066 CR Euro6	316	430	09/12	>	06/16				S 5664 PO
Vehicles for building site / veicoli da cantiere	D2066 CR Euro6	316	430	09/12	>	06/16				S 7E35 A
TGS 41.430	D2066 Euro4/5/EEV	316	430	06/08	>	08/12	S 5046 PE	S 6011 NE	S 7619 A	S 3165 C
with air-conditioner / con climatizzatore	D2066 Euro4/5/EEV	316	430	06/08	>	08/12				S 4177 CA
inner / interno	D2066 Euro4/5/EEV	316	430	06/08	>	08/12			S 7616 A	
prefilter 300 Micron / prefiltro 300 Micron	D2066 Euro4/5/EEV	316	430	06/08	>	08/12		S 6088 NE		
prefilter with fuel oil heater / prefiltro con riscaldatore nafta	D2066 Euro4/5/EEV	316	430	06/08	>	08/12		S 6059 NE		
prefilter without fuel oil heater / prefiltro senza riscaldatore nafta	D2066 Euro4/5/EEV	316	430	06/08	>	08/12		S 6062 NE		
power steering / servosterzo	D2066 Euro4/5/EEV	316	430	06/08	>	08/12				S 3081 PO
TGS 41.440	D2066 CR Euro6	324	440	09/12	>		S 5235 PE	S 6011 NE	S 7619 A	S 3165 C
with automatic gearbox and hydraulic retarder ZF 16S / con cambio automatico e rallentatore idraulico ZF 16S	D2066 CR Euro6	324	440	09/12	>					S 2234 Z
with air-conditioner / con climatizzatore	D2066 CR Euro6	324	440	09/12	>					S 4177 CA
inner / interno	D2066 CR Euro6	324	440	09/12	>				S 7616 A	
prefilter / prefiltro	D2066 CR Euro6	324	440	09/12	>			S 4035 NR		
prefilter 300 Micron / prefiltro 300 Micron	D2066 CR Euro6	324	440	09/12	>			S 6088 NE		
power steering / servosterzo	D2066 CR Euro6	324	440	09/12	>					S 3081 PO
TGS 41.480	D2676 CR Euro6	353	480	09/12	>		S 5235 PE	S 6011 NE	S 7619 A	S 3165 C
with automatic gearbox and hydraulic retarder ZF 16S / con cambio automatico e rallentatore idraulico ZF 16S	D2676 CR Euro6	353	480	09/12	>					S 2234 Z
with air-conditioner / con climatizzatore	D2676 CR Euro6	353	480	09/12	>					S 4177 CA
inner / interno	D2676 CR Euro6	353	480	09/12	>				S 7616 A	
prefilter / prefiltro	D2676 CR Euro6	353	480	09/12	>			S 4035 NR		
prefilter 300 Micron / prefiltro 300 Micron	D2676 CR Euro6	353	480	09/12	>			S 6088 NE		
power steering / servosterzo	D2676 CR Euro6	353	480	09/12	>					S 3081 PO
TGS 41.480	D2676 Euro4/5/EEV	353	480	03/08	>	08/12	S 5046 PE	S 6011 NE	S 7619 A	S 3165 C
with air-conditioner / con climatizzatore	D2676 Euro4/5/EEV	353	480	03/08	>	08/12				S 4177 CA
inner / interno	D2676 Euro4/5/EEV	353	480	03/08	>	08/12			S 7616 A	
prefilter with fuel oil heater / prefiltro con riscaldatore nafta	D2676 Euro4/5/EEV	353	480	03/08	>	08/12		S 6059 NE		
prefilter without fuel oil heater / prefiltro senza riscaldatore nafta	D2676 Euro4/5/EEV	353	480	03/08	>	08/12		S 6062 NE		
power steering / servosterzo	D2676 Euro4/5/EEV	353	480	03/08	>	08/12				S 3081 PO
TGS 50.440	D2066 CR Euro6	324	440	09/12	>		S 5235 PE	S 6011 NE	S 7619 A	S 3165 C
with automatic gearbox and hydraulic retarder ZF 16S / con cambio automatico e rallentatore idraulico ZF 16S	D2066 CR Euro6	324	440	09/12	>					S 2234 Z
with air-conditioner / con climatizzatore	D2066 CR Euro6	324	440	09/12	>					S 4177 CA
inner / interno	D2066 CR Euro6	324	440	09/12	>				S 7616 A	
prefilter / prefiltro	D2066 CR Euro6	324	440	09/12	>			S 4035 NR		
prefilter 300 Micron / prefiltro 300 Micron	D2066 CR Euro6	324	440	09/12	>			S 6088 NE		
power steering / servosterzo	D2066 CR Euro6	324	440	09/12	>					S 3081 PO
TGS 50.480	D2676 CR Euro6	353	480	09/12	>	07/16	S 5235 PE	S 6011 NE	S 7619 A	S 3165 C
with automatic gearbox and hydraulic retarder ZF 16S / con cambio automatico e rallentatore idraulico ZF 16S	D2676 CR Euro6	353	480	09/12	>	07/16				S 2234 Z
with air-conditioner / con climatizzatore	D2676 CR Euro6	353	480	09/12	>	07/16				S 4177 CA
dryer filter / filtro essiccatore	D2676 CR Euro6	353	480	09/12	>	07/16				S 7A66 A
retarder R3500/4100 (TipMatic 12+2) / freno di rallentamento R3500/4100 (TipMatic 12+2)	D2676 CR Euro6	353	480	09/12	>	07/16				S 5613 PO
inner / interno	D2676 CR Euro6	353	480	09/12	>	07/16			S 7616 A	
prefilter / prefiltro	D2676 CR Euro6	353	480	09/12	>	07/16		S 4035 NR		

M

**kW HP****...MAN - trucks/autocarri**

prefilter 300 Micron / prefiltro 300 Micron	D2676 CR Euro6	353	480	09/12 >	07/16		S 6088 NE		S 3081 PO
power steering / servosterzo	D2676 CR Euro6	353	480	09/12 >	07/16				S 5664 PO
power steering ZF Servocom RAS-EC / servosterzo ZF Servocom RAS-EC	D2676 CR Euro6	353	480	09/12 >	07/16				
Vehicles for building site / veicoli da cantiere	D2676 CR Euro6	353	480	09/12 >	07/16			S 7E35 A	
TGS 50.480	D2676 Euro4/5/EEV	353	480	09/08 >	08/12	S 5046 PE	S 6011 NE	S 7619 A	S 3165 C
with air-conditioner / con climatizzatore	D2676 Euro4/5/EEV	353	480	09/08 >	08/12				S 4177 CA
inner / interno	D2676 Euro4/5/EEV	353	480	09/08 >	08/12			S 7616 A	
prefilter with fuel oil heater / prefiltro con riscaldatore nafta	D2676 Euro4/5/EEV	353	480	09/08 >	08/12		S 6059 NE		
prefilter without fuel oil heater / prefiltro senza riscaldatore nafta	D2676 Euro4/5/EEV	353	480	09/08 >	08/12		S 6062 NE		
power steering / servosterzo	D2676 Euro4/5/EEV	353	480	09/08 >	08/12				S 3081 PO
TGX Serie									
TGX 18.320	D2066 CR Euro6	235	320	09/12 >	06/16	S 5235 PE	S 6011 NE	S 7619 A	S 3165 C
	D2066 CR Euro6	235	320	07/16 >				S 7F27 A	
with automatic gearbox and hydraulic retarder ZF 16S / con cambio automatico e rallentatore idraulico ZF 16S	D2066 CR Euro6	235	320	09/12 >					S 2234 Z
with air-conditioner / con climatizzatore	D2066 CR Euro6	235	320	09/12 >					S 4177 CA
inner / interno	D2066 CR Euro6	235	320	09/12 >	06/16			S 7616 A	
inner / interno	D2066 CR Euro6	235	320	07/16 >				S 7F28 A	
prefilter 300 Micron / prefiltro 300 Micron	D2066 CR Euro6	235	320	09/12 >			S 6088 NE		
prefilter UFI FILTERS / prefiltro UFI FILTERS	D2066 CR Euro6	235	320	09/12 >			S 4035 NR		
power steering / servosterzo	D2066 CR Euro6	235	320	09/12 >					S 3081 PO
power steering ZF Servocom RAS-EC / servosterzo ZF Servocom RAS-EC	D2066 CR Euro6	235	320	09/12 >					S 5664 PO
Vehicles for building site / veicoli da cantiere	D2066 CR Euro6	235	320	09/12 >	06/16			S 7E35 A	
Vehicles for building site / veicoli da cantiere	D2066 CR Euro6	235	320	07/16 >				S 7F29 A	
TGX 18.320	D2066 Euro4/5/EEV	235	320	10/07 >		S 5046 PE	S 6011 NE	S 7619 A	S 3165 C
with air-conditioner / con climatizzatore	D2066 Euro4/5/EEV	235	320	10/07 >					S 4177 CA
inner / interno	D2066 Euro4/5/EEV	235	320	10/07 >				S 7616 A	
prefilter with fuel oil heater / prefiltro con riscaldatore nafta	D2066 Euro4/5/EEV	235	320	10/07 >			S 6059 NE		
prefilter without fuel oil heater / prefiltro senza riscaldatore nafta	D2066 Euro4/5/EEV	235	320	10/07 >			S 6062 NE		
power steering / servosterzo	D2066 Euro4/5/EEV	235	320	10/07 >					S 3081 PO
TGX 18.360	D2066 CR Euro6	265	360	09/12 >	06/16	S 5235 PE	S 6011 NE	S 7619 A	S 3165 C
	D2066 CR Euro6	265	360	07/16 >				S 7F27 A	
with automatic gearbox and hydraulic retarder ZF 16S / con cambio automatico e rallentatore idraulico ZF 16S	D2066 CR Euro6	265	360	09/12 >					S 2234 Z
with air-conditioner / con climatizzatore	D2066 CR Euro6	265	360	09/12 >					S 4177 CA
inner / interno	D2066 CR Euro6	265	360	09/12 >	06/16			S 7616 A	
inner / interno	D2066 CR Euro6	265	360	07/16 >				S 7F28 A	
prefilter 300 Micron / prefiltro 300 Micron	D2066 CR Euro6	265	360	09/12 >			S 6088 NE		
prefilter UFI FILTERS / prefiltro UFI FILTERS	D2066 CR Euro6	265	360	09/12 >			S 4035 NR		
power steering / servosterzo	D2066 CR Euro6	265	360	09/12 >					S 3081 PO
power steering ZF Servocom RAS-EC / servosterzo ZF Servocom RAS-EC	D2066 CR Euro6	265	360	09/12 >					S 5664 PO
Vehicles for building site / veicoli da cantiere	D2066 CR Euro6	265	360	09/12 >	06/16			S 7E35 A	
Vehicles for building site / veicoli da cantiere	D2066 CR Euro6	265	360	07/16 >				S 7F29 A	
TGX 18.360	D2066 Euro4/5/EEV	265	360	10/07 >		S 5046 PE	S 6011 NE	S 7619 A	S 3165 C
with air-conditioner / con climatizzatore	D2066 Euro4/5/EEV	265	360	10/07 >					S 4177 CA
inner / interno	D2066 Euro4/5/EEV	265	360	10/07 >				S 7616 A	
prefilter with fuel oil heater / prefiltro con riscaldatore nafta	D2066 Euro4/5/EEV	265	360	10/07 >			S 6059 NE		
prefilter without fuel oil heater / prefiltro senza riscaldatore nafta	D2066 Euro4/5/EEV	265	360	10/07 >			S 6062 NE		
power steering / servosterzo	D2066 Euro4/5/EEV	265	360	10/07 >					S 3081 PO
TGX 18.400	D2066 Euro4/5/EEV	294	400	10/07 >	07/16	S 5046 PE	S 6011 NE	S 7619 A	S 3165 C
with air-conditioner / con climatizzatore	D2066 Euro4/5/EEV	294	400	10/07 >	07/16				S 4177 CA
inner / interno	D2066 Euro4/5/EEV	294	400	10/07 >	07/16			S 7616 A	
prefilter with fuel oil heater / prefiltro con riscaldatore nafta	D2066 Euro4/5/EEV	294	400	10/07 >	07/16		S 6059 NE		
prefilter without fuel oil heater / prefiltro senza riscaldatore nafta	D2066 Euro4/5/EEV	294	400	10/07 >	07/16		S 6062 NE		
power steering / servosterzo	D2066 Euro4/5/EEV	294	400	10/07 >	07/16				S 3081 PO
TGX 18.420	D2676 Euro6	309	420	07/16 >		S 5235 PE	S 6011 NE		S 3165 C
with air-conditioner / con climatizzatore	D2676 Euro6	309	420	07/16 >					S 4177 CA
dryer filter / filtro essiccatore	D2676 Euro6	309	420	07/16 >					S 7A66 A
prefilter / prefiltro	D2676 Euro6	309	420	07/16 >			S 4035 NR		
prefilter 300 Micron / prefiltro 300 Micron	D2676 Euro6	309	420	07/16 >			S 6088 NE		
power steering / servosterzo	D2676 Euro6	309	420	07/16 >					S 3081 PO
power steering ZF Servocom RAS-EC / servosterzo ZF Servocom RAS-EC	D2676 Euro6	309	420	07/16 >					S 5664 PO
TGX 18.440	D2066 Euro4/5/EEV	324	441	10/07 >	07/16	S 5046 PE	S 6011 NE	S 7619 A	S 3165 C
with air-conditioner / con climatizzatore	D2066 Euro4/5/EEV	324	441	10/07 >	07/16				S 4177 CA
inner / interno	D2066 Euro4/5/EEV	324	441	10/07 >	07/16			S 7616 A	
prefilter with fuel oil heater / prefiltro con riscaldatore nafta	D2066 Euro4/5/EEV	324	441	10/07 >	07/16		S 6059 NE		
prefilter without fuel oil heater / prefiltro senza riscaldatore nafta	D2066 Euro4/5/EEV	324	441	10/07 >	07/16		S 6062 NE		
power steering / servosterzo	D2066 Euro4/5/EEV	324	441	10/07 >	07/16				S 3081 PO
TGX 18.460	D2676 Euro6	338	460	07/16 >		S 5235 PE	S 6011 NE	S 7F27 A	S 3165 C



...MAN - trucks/autocarri

with automatic gearbox and hydraulic retarder ZF 16S / con cambio automatico e rallentatore idraulico ZF 16S	D2676 Euro6	338	460	07/16	>				S 2234 Z
with air-conditioner / con climatizzatore	D2676 Euro6	338	460	07/16	>				S 4177 CA
dryer filter / filtro essiccatore	D2676 Euro6	338	460	07/16	>				S 7A66 A
retarder R3500/4100 (TipMatic 12+2) / freno di rallentamento R3500/4100 (TipMatic 12+2)	D2676 Euro6	338	460	07/16	>				S 5613 PO
inner / interno	D2676 Euro6	338	460	07/16	>			S 7F28 A	
prefilter / prefiltra	D2676 Euro6	338	460	07/16	>		S 4035 NR		
prefilter 300 Micron / prefiltra 300 Micron	D2676 Euro6	338	460	07/16	>		S 6088 NE		
power steering / servosterzo	D2676 Euro6	338	460	07/16	>				S 3081 PO
power steering ZF Servocom RAS-EC / servosterzo ZF Servocom RAS-EC	D2676 Euro6	338	460	07/16	>				S 5664 PO
Vehicles for building site / veicoli da cantiere	D2676 Euro6	338	460	07/16	>			S 7F29 A	
TGX 18.480	D2676 Euro4/5/EEV	353	480	10/07	>	S 5046 PE	S 6011 NE	S 7619 A	S 3165 C
with automatic gearbox ZF 16S + Intarder / con cambio automatico ZF 16S + Intarder	D2676 Euro4/5/EEV	353	480	10/07	>				S 2234 Z
with air-conditioner / con climatizzatore	D2676 Euro4/5/EEV	353	480	10/07	>				S 4177 CA
dryer filter / filtro essiccatore	D2676 Euro4/5/EEV	353	480	10/07	>				S 7A66 A
inner / interno	D2676 Euro4/5/EEV	353	480	10/07	>			S 7616 A	
prefilter 300 Micron / prefiltra 300 Micron	D2676 Euro4/5/EEV	353	480	10/07	>		S 6088 NE		
prefilter with fuel oil heater / prefiltra con riscaldatore nafta	D2676 Euro4/5/EEV	353	480	10/07	>		S 6059 NE		
prefilter without fuel oil heater / prefiltra senza riscaldatore nafta	D2676 Euro4/5/EEV	353	480	10/07	>		S 6062 NE		
power steering / servosterzo	D2676 Euro4/5/EEV	353	480	10/07	>				S 3081 PO
power steering ZF Servocom RAS-EC / servosterzo ZF Servocom RAS-EC	D2676 Euro4/5/EEV	353	480	10/07	>				S 5664 PO
TGX 18.480	D2676 Euro6	353	480	09/12	>	S 5235 PE	S 6011 NE	S 7619 A	S 3165 C
with automatic gearbox and hydraulic retarder ZF 16S / con cambio automatico e rallentatore idraulico ZF 16S	D2676 Euro6	353	480	09/12	>				S 2234 Z
with air-conditioner / con climatizzatore	D2676 Euro6	353	480	09/12	>				S 4177 CA
inner / interno	D2676 Euro6	353	480	09/12	>			S 7616 A	
prefilter / prefiltra	D2676 Euro6	353	480	09/12	>		S 4035 NR		
prefilter 300 Micron / prefiltra 300 Micron	D2676 Euro6	353	480	09/12	>		S 6088 NE		
power steering / servosterzo	D2676 Euro6	353	480	09/12	>				S 3081 PO
TGX 18.500	D2676 Euro6	368	500	07/16	>	S 5235 PE	S 6011 NE		S 3165 C
with air-conditioner / con climatizzatore	D2676 Euro6	368	500	07/16	>				S 4177 CA
dryer filter / filtro essiccatore	D2676 Euro6	368	500	07/16	>				S 7A66 A
prefilter / prefiltra	D2676 Euro6	368	500	07/16	>		S 4035 NR		
prefilter 300 Micron / prefiltra 300 Micron	D2676 Euro6	368	500	07/16	>		S 6088 NE		
power steering / servosterzo	D2676 Euro6	368	500	07/16	>				S 3081 PO
power steering ZF Servocom RAS-EC / servosterzo ZF Servocom RAS-EC	D2676 Euro6	368	500	07/16	>				S 5664 PO
TGX 18.520 D38	D3876	382	519	08/14	>	S 5239 PE	S 6150 NE	S 7619 A	S 3165 C
with air-conditioner / con climatizzatore	D3876	382	519	08/14	>				S 4177 CA
dryer filter / filtro essiccatore	D3876	382	519	08/14	>				S 7A66 A
inner / interno	D3876	382	519	08/14	>			S 7616 A	
prefilter / prefiltra	D3876	382	519	08/14	>		S 4035 NR		
power steering / servosterzo	D3876	382	519	08/14	>				S 3081 PO
TGX 18.540	D2676 Euro4/5/EEV	397	540	10/07	> 07/16	S 5046 PE	S 6011 NE	S 7619 A	S 3165 C
with air-conditioner / con climatizzatore	D2676 Euro4/5/EEV	397	540	10/07	> 07/16				S 4177 CA
inner / interno	D2676 Euro4/5/EEV	397	540	10/07	> 07/16			S 7616 A	
prefilter with fuel oil heater / prefiltra con riscaldatore nafta	D2676 Euro4/5/EEV	397	540	10/07	> 07/16		S 6059 NE		
prefilter without fuel oil heater / prefiltra senza riscaldatore nafta	D2676 Euro4/5/EEV	397	540	10/07	> 07/16		S 6062 NE		
power steering / servosterzo	D2676 Euro4/5/EEV	397	540	10/07	> 07/16				S 3081 PO
TGX 18.540 D38	D3876 Euro6	397	540	07/16	>	S 5239 PE	S 6150 NE	S 7F27 A	S 3165 C
with automatic gearbox and hydraulic retarder ZF 16S / con cambio automatico e rallentatore idraulico ZF 16S	D3876 Euro6	397	540	07/16	>				S 2234 Z
with air-conditioner / con climatizzatore	D3876 Euro6	397	540	07/16	>				S 4177 CA
dryer filter / filtro essiccatore	D3876 Euro6	397	540	07/16	>				S 7A66 A
retarder R3500/4100 (TipMatic 12+2) / freno di rallentamento R3500/4100 (TipMatic 12+2)	D3876 Euro6	397	540	07/16	>				S 5613 PO
inner / interno	D3876 Euro6	397	540	07/16	>			S 7F28 A	
prefilter / prefiltra	D3876 Euro6	397	540	07/16	>		S 4035 NR		
prefilter 300 Micron / prefiltra 300 Micron	D3876 Euro6	397	540	07/16	>		S 6088 NE		
power steering / servosterzo	D3876 Euro6	397	540	07/16	>				S 3081 PO
power steering ZF Servocom RAS-EC / servosterzo ZF Servocom RAS-EC	D3876 Euro6	397	540	07/16	>				S 5664 PO
Vehicles for building site / veicoli da cantiere	D3876 Euro6	397	540	07/16	>			S 7F29 A	
TGX 18.560 D38	D3876	412	560	08/14	> 07/16	S 5239 PE	S 6150 NE	S 7619 A	S 3165 C
with air-conditioner / con climatizzatore	D3876	412	560	08/14	> 07/16				S 4177 CA
dryer filter / filtro essiccatore	D3876	412	560	08/14	> 07/16				S 7A66 A
inner / interno	D3876	412	560	08/14	> 07/16			S 7616 A	
prefilter / prefiltra	D3876	412	560	08/14	> 07/16		S 4035 NR		
power steering / servosterzo	D3876	412	560	08/14	> 07/16				S 3081 PO
TGX 18.580 D38	D3876 Euro6	427	580	07/16	>	S 5239 PE	S 6150 NE	S 7F27 A	S 3165 C
with automatic gearbox and hydraulic retarder ZF 16S / con cambio automatico e rallentatore idraulico ZF 16S	D3876 Euro6	427	580	07/16	>				S 2234 Z
with air-conditioner / con climatizzatore	D3876 Euro6	427	580	07/16	>				S 4177 CA
dryer filter / filtro essiccatore	D3876 Euro6	427	580	07/16	>				S 7A66 A

M



**KW HP****...MAN - trucks/autocarri**

retarder R3500/4100 (TipMatic 12+2) / freno di rallentamento R3500/4100 (TipMatic 12+2)	D3876 Euro6	427	580	07/16	>				S 5613 PO
inner / interno	D3876 Euro6	427	580	07/16	>			S 7F28 A	
prefilter / prefiltro	D3876 Euro6	427	580	07/16	>		S 4035 NR		
prefilter 300 Micron / prefiltro 300 Micron	D3876 Euro6	427	580	07/16	>		S 6088 NE		
power steering / servosterzo	D3876 Euro6	427	580	07/16	>				S 3081 PO
power steering ZF Servocom RAS-EC / servosterzo ZF Servocom RAS-EC	D3876 Euro6	427	580	07/16	>				S 5664 PO
Vehicles for building site / veicoli da cantiere	D3876 Euro6	427	580	07/16	>			S 7F29 A	
TGX 18.640 D38	D3876 Euro6	471	640	07/16	>	S 5239 PE	S 6150 NE	S 7F27 A	S 3165 C
with automatic gearbox and hydraulic retarder ZF 16S / con cambio automatico e rallentatore idraulico ZF 16S	D3876 Euro6	471	640	07/16	>				S 2234 Z
with air-conditioner / con climatizzatore	D3876 Euro6	471	640	07/16	>				S 4177 CA
dryer filter / filtro essiccatore	D3876 Euro6	471	640	07/16	>				S 7A66 A
retarder R3500/4100 (TipMatic 12+2) / freno di rallentamento R3500/4100 (TipMatic 12+2)	D3876 Euro6	471	640	07/16	>				S 5613 PO
inner / interno	D3876 Euro6	471	640	07/16	>			S 7F28 A	
prefilter / prefiltro	D3876 Euro6	471	640	07/16	>		S 4035 NR		
prefilter 300 Micron / prefiltro 300 Micron	D3876 Euro6	471	640	07/16	>		S 6088 NE		
power steering / servosterzo	D3876 Euro6	471	640	07/16	>				S 3081 PO
power steering ZF Servocom RAS-EC / servosterzo ZF Servocom RAS-EC	D3876 Euro6	471	640	07/16	>				S 5664 PO
Vehicles for building site / veicoli da cantiere	D3876 Euro6	471	640	07/16	>			S 7F29 A	
TGX 18.680 V8	D2868LF02/03/05	500	680	10/07	> 06/14		S 6011 NE	S 7619 A	S 3165 C
some 2 filters (51.05504.0110) / alcuni N.2 filtri (51.05504.0110)	D2868LF02/03/05	500	680	10/07	> 06/14	S 5147 PE			
with automatic gearbox and hydraulic retarder ZF 16S / con cambio automatico e rallentatore idraulico ZF 16S	D2868LF02/03/05	500	680	10/07	> 06/14				S 2234 Z
with air-conditioner / con climatizzatore	D2868LF02/03/05	500	680	10/07	> 06/14				S 4177 CA
dryer filter / filtro essiccatore	D2868LF02/03/05	500	680	10/07	> 06/14				S 7A66 A
inner / interno	D2868LF02/03/05	500	680	10/07	> 06/14			S 7616 A	
2 filters / N.2 filtri	D2868LF02/03/05	500	680	10/07	> 06/14	S 5046 PE			
prefilter 300 Micron / prefiltro 300 Micron	D2868LF02/03/05	500	680	10/07	> 06/14		S 6088 NE		
prefilter with fuel oil heater / prefiltro con riscaldatore nafta	D2868LF02/03/05	500	680	10/07	> 06/14		S 6059 NE		
prefilter without fuel oil heater / prefiltro senza riscaldatore nafta	D2868LF02/03/05	500	680	10/07	> 06/14		S 6062 NE		
power steering / servosterzo	D2868LF02/03/05	500	680	10/07	> 06/14				S 3081 PO
TGX 24.360	D2066 CR Euro6	265	360	09/12	> 06/16	S 5235 PE	S 6011 NE	S 7619 A	S 3165 C
	D2066 CR Euro6	265	360	07/16	>	S 5235 PE	S 6011 NE	S 7F27 A	S 3165 C
with automatic gearbox and hydraulic retarder ZF 16S / con cambio automatico e rallentatore idraulico ZF 16S	D2066 CR Euro6	265	360	09/12	>				S 2234 Z
with air-conditioner / con climatizzatore	D2066 CR Euro6	265	360	09/12	>				S 4177 CA
inner / interno	D2066 CR Euro6	265	360	09/12	> 06/16			S 7616 A	
inner / interno	D2066 CR Euro6	265	360	07/16	>			S 7F28 A	
prefilter 300 Micron / prefiltro 300 Micron	D2066 CR Euro6	265	360	09/12	>		S 6088 NE		
prefilter UFI FILTERS / prefiltro UFI FILTERS	D2066 CR Euro6	265	360	09/12	>		S 4035 NR		
power steering / servosterzo	D2066 CR Euro6	265	360	09/12	>				S 3081 PO
power steering ZF Servocom RAS-EC / servosterzo ZF Servocom RAS-EC	D2066 CR Euro6	265	360	09/12	>				S 5664 PO
Vehicles for building site / veicoli da cantiere	D2066 CR Euro6	265	360	09/12	> 06/16			S 7E35 A	
Vehicles for building site / veicoli da cantiere	D2066 CR Euro6	265	360	07/16	>			S 7F29 A	
TGX 24.360	D2066 Euro4/5/EEV	265	360	10/07	>	S 5046 PE	S 6011 NE	S 7619 A	S 3165 C
with air-conditioner / con climatizzatore	D2066 Euro4/5/EEV	265	360	10/07	>				S 4177 CA
inner / interno	D2066 Euro4/5/EEV	265	360	10/07	>			S 7616 A	
prefilter with fuel oil heater / prefiltro con riscaldatore nafta	D2066 Euro4/5/EEV	265	360	10/07	>		S 6059 NE		
prefilter without fuel oil heater / prefiltro senza riscaldatore nafta	D2066 Euro4/5/EEV	265	360	10/07	>		S 6062 NE		
power steering / servosterzo	D2066 Euro4/5/EEV	265	360	10/07	>				S 3081 PO
TGX 24.400	D2066 Euro4/5/EEV	294	400	10/07	>	S 5046 PE	S 6011 NE	S 7619 A	S 3165 C
with air-conditioner / con climatizzatore	D2066 Euro4/5/EEV	294	400	10/07	>				S 4177 CA
inner / interno	D2066 Euro4/5/EEV	294	400	10/07	>			S 7616 A	
prefilter with fuel oil heater / prefiltro con riscaldatore nafta	D2066 Euro4/5/EEV	294	400	10/07	>		S 6059 NE		
prefilter without fuel oil heater / prefiltro senza riscaldatore nafta	D2066 Euro4/5/EEV	294	400	10/07	>		S 6062 NE		
power steering / servosterzo	D2066 Euro4/5/EEV	294	400	10/07	>				S 3081 PO
TGX 24.420	D2676 Euro6	309	420	07/16	>	S 5235 PE	S 6011 NE	S 7F27 A	S 3165 C
with automatic gearbox and hydraulic retarder ZF 16S / con cambio automatico e rallentatore idraulico ZF 16S	D2676 Euro6	309	420	07/16	>				S 2234 Z
with air-conditioner / con climatizzatore	D2676 Euro6	309	420	07/16	>				S 4177 CA
dryer filter / filtro essiccatore	D2676 Euro6	309	420	07/16	>				S 7A66 A
retarder R3500/4100 (TipMatic 12+2) / freno di rallentamento R3500/4100 (TipMatic 12+2)	D2676 Euro6	309	420	07/16	>				S 5613 PO
inner / interno	D2676 Euro6	309	420	07/16	>			S 7F28 A	
prefilter / prefiltro	D2676 Euro6	309	420	07/16	>		S 4035 NR		
prefilter 300 Micron / prefiltro 300 Micron	D2676 Euro6	309	420	07/16	>		S 6088 NE		
power steering / servosterzo	D2676 Euro6	309	420	07/16	>				S 3081 PO
power steering ZF Servocom RAS-EC / servosterzo ZF Servocom RAS-EC	D2676 Euro6	309	420	07/16	>				S 5664 PO
Vehicles for building site / veicoli da cantiere	D2676 Euro6	309	420	07/16	>			S 7F29 A	
TGX 24.440	D2066 Euro4/5/EEV	324	441	10/07	>	S 5046 PE	S 6011 NE	S 7619 A	S 3165 C
with air-conditioner / con climatizzatore	D2066 Euro4/5/EEV	324	441	10/07	>				S 4177 CA
inner / interno	D2066 Euro4/5/EEV	324	441	10/07	>			S 7616 A	

**KW HP****...MAN - trucks/autocarri**

prefilter with fuel oil heater / prefiltro con riscaldatore nafta	D2066 Euro4/5/EEV	324	441	10/07	>		S 6059 NE		
prefilter without fuel oil heater / prefiltro senza riscaldatore nafta	D2066 Euro4/5/EEV	324	441	10/07	>		S 6062 NE		
power steering / servosterzo	D2066 Euro4/5/EEV	324	441	10/07	>				S 3081 PO
TXG 24.440	D2676 Euro5	323	440	09/08	>	S 5046 PE	S 6011 NE	S 7619 A	S 3165 C
with air-conditioner / con climatizzatore	D2676 Euro5	323	440	09/08	>				S 4177 CA
inner / interno	D2676 Euro5	323	440	09/08	>			S 7616 A	
prefilter with fuel oil heater / prefiltro con riscaldatore nafta	D2676 Euro5	323	440	09/08	>		S 6059 NE		
prefilter without fuel oil heater / prefiltro senza riscaldatore nafta	D2676 Euro5	323	440	09/08	>		S 6062 NE		
power steering / servosterzo	D2676 Euro5	323	440	09/08	>				S 3081 PO
TXG 24.460	D2676 Euro6	338	460	07/16	>	S 5235 PE	S 6011 NE	S 7F27 A	S 3165 C
with automatic gearbox and hydraulic retarder ZF 16S / con cambio automatico e rallentatore idraulico ZF 16S	D2676 Euro6	338	460	07/16	>				S 2234 Z
with air-conditioner / con climatizzatore	D2676 Euro6	338	460	07/16	>				S 4177 CA
dryer filter / filtro essiccatore	D2676 Euro6	338	460	07/16	>				S 7A66 A
retarder R3500/4100 (TipMatic 12+2) / freno di rallentamento R3500/4100 (TipMatic 12+2)	D2676 Euro6	338	460	07/16	>				S 5613 PO
inner / interno	D2676 Euro6	338	460	07/16	>			S 7F28 A	
prefilter / prefiltro	D2676 Euro6	338	460	07/16	>		S 4035 NR		
prefilter 300 Micron / prefiltro 300 Micron	D2676 Euro6	338	460	07/16	>		S 6088 NE		
power steering / servosterzo	D2676 Euro6	338	460	07/16	>				S 3081 PO
power steering ZF Servocom RAS-EC / servosterzo ZF Servocom RAS-EC	D2676 Euro6	338	460	07/16	>				S 5664 PO
Vehicles for building site / veicoli da cantiere	D2676 Euro6	338	460	07/16	>			S 7F29 A	
TXG 24.480	D2676 Euro4/5/EEV	353	480	10/07	>	S 5046 PE	S 6011 NE	S 7619 A	S 3165 C
with air-conditioner / con climatizzatore	D2676 Euro4/5/EEV	353	480	10/07	>				S 4177 CA
inner / interno	D2676 Euro4/5/EEV	353	480	10/07	>			S 7616 A	
prefilter with fuel oil heater / prefiltro con riscaldatore nafta	D2676 Euro4/5/EEV	353	480	10/07	>		S 6059 NE		
prefilter without fuel oil heater / prefiltro senza riscaldatore nafta	D2676 Euro4/5/EEV	353	480	10/07	>		S 6062 NE		
power steering / servosterzo	D2676 Euro4/5/EEV	353	480	10/07	>				S 3081 PO
TXG 24.500	D2676 Euro6	368	500	07/16	>	S 5235 PE	S 6011 NE	S 7F27 A	S 3165 C
with automatic gearbox and hydraulic retarder ZF 16S / con cambio automatico e rallentatore idraulico ZF 16S	D2676 Euro6	368	500	07/16	>				S 2234 Z
with air-conditioner / con climatizzatore	D2676 Euro6	368	500	07/16	>				S 4177 CA
dryer filter / filtro essiccatore	D2676 Euro6	368	500	07/16	>				S 7A66 A
retarder R3500/4100 (TipMatic 12+2) / freno di rallentamento R3500/4100 (TipMatic 12+2)	D2676 Euro6	368	500	07/16	>				S 5613 PO
inner / interno	D2676 Euro6	368	500	07/16	>			S 7F28 A	
prefilter / prefiltro	D2676 Euro6	368	500	07/16	>		S 4035 NR		
prefilter 300 Micron / prefiltro 300 Micron	D2676 Euro6	368	500	07/16	>		S 6088 NE		
power steering / servosterzo	D2676 Euro6	368	500	07/16	>				S 3081 PO
power steering ZF Servocom RAS-EC / servosterzo ZF Servocom RAS-EC	D2676 Euro6	368	500	07/16	>				S 5664 PO
Vehicles for building site / veicoli da cantiere	D2676 Euro6	368	500	07/16	>			S 7F29 A	
TXG 24.520 D38	D3876	382	519	08/14	>	S 5239 PE	S 6150 NE	S 7619 A	S 3165 C
with air-conditioner / con climatizzatore	D3876	382	519	08/14	>				S 4177 CA
dryer filter / filtro essiccatore	D3876	382	519	08/14	>				S 7A66 A
inner / interno	D3876	382	519	08/14	>			S 7616 A	
prefilter / prefiltro	D3876	382	519	08/14	>		S 4035 NR		
power steering / servosterzo	D3876	382	519	08/14	>				S 3081 PO
TXG 24.540	D2676 Euro4/5/EEV	397	540	10/07	>	S 5046 PE	S 6011 NE	S 7619 A	S 3165 C
with air-conditioner / con climatizzatore	D2676 Euro4/5/EEV	397	540	10/07	>				S 4177 CA
inner / interno	D2676 Euro4/5/EEV	397	540	10/07	>			S 7616 A	
prefilter with fuel oil heater / prefiltro con riscaldatore nafta	D2676 Euro4/5/EEV	397	540	10/07	>		S 6059 NE		
prefilter without fuel oil heater / prefiltro senza riscaldatore nafta	D2676 Euro4/5/EEV	397	540	10/07	>		S 6062 NE		
power steering / servosterzo	D2676 Euro4/5/EEV	397	540	10/07	>				S 3081 PO
TXG 24.540 D38	D3876 Euro6	397	540	07/16	>	S 5239 PE	S 6150 NE	S 7F27 A	S 3165 C
with automatic gearbox and hydraulic retarder ZF 16S / con cambio automatico e rallentatore idraulico ZF 16S	D3876 Euro6	397	540	07/16	>				S 2234 Z
with air-conditioner / con climatizzatore	D3876 Euro6	397	540	07/16	>				S 4177 CA
dryer filter / filtro essiccatore	D3876 Euro6	397	540	07/16	>				S 7A66 A
retarder R3500/4100 (TipMatic 12+2) / freno di rallentamento R3500/4100 (TipMatic 12+2)	D3876 Euro6	397	540	07/16	>				S 5613 PO
inner / interno	D3876 Euro6	397	540	07/16	>			S 7F28 A	
prefilter / prefiltro	D3876 Euro6	397	540	07/16	>		S 4035 NR		
prefilter 300 Micron / prefiltro 300 Micron	D3876 Euro6	397	540	07/16	>		S 6088 NE		
power steering / servosterzo	D3876 Euro6	397	540	07/16	>				S 3081 PO
power steering ZF Servocom RAS-EC / servosterzo ZF Servocom RAS-EC	D3876 Euro6	397	540	07/16	>				S 5664 PO
Vehicles for building site / veicoli da cantiere	D3876 Euro6	397	540	07/16	>			S 7F29 A	
TXG 24.560 D38	D3876	412	560	08/14	>	S 5239 PE	S 6150 NE	S 7619 A	S 3165 C
with air-conditioner / con climatizzatore	D3876	412	560	08/14	>				S 4177 CA
dryer filter / filtro essiccatore	D3876	412	560	08/14	>				S 7A66 A
inner / interno	D3876	412	560	08/14	>			S 7616 A	
prefilter / prefiltro	D3876	412	560	08/14	>		S 4035 NR		
power steering / servosterzo	D3876	412	560	08/14	>				S 3081 PO
TXG 24.580 D38	D3876 Euro6	427	580	07/16	>	S 5239 PE	S 6150 NE	S 7F27 A	S 3165 C

M

**kW HP****...MAN - trucks/autocarri**

with automatic gearbox and hydraulic retarder ZF 16S / con cambio automatico e rallentatore idraulico ZF 16S	D3876 Euro6	427	580	07/16	>				S 2234 Z
with air-conditioner / con climatizzatore	D3876 Euro6	427	580	07/16	>				S 4177 CA
dryer filter / filtro essiccatore	D3876 Euro6	427	580	07/16	>				S 7A66 A
retarder R3500/4100 (TipMatic 12+2) / freno di rallentamento R3500/4100 (TipMatic 12+2)	D3876 Euro6	427	580	07/16	>				S 5613 PO
inner / interno	D3876 Euro6	427	580	07/16	>			S 7F28 A	
prefilter / prefiltro	D3876 Euro6	427	580	07/16	>		S 4035 NR		
prefilter 300 Micron / prefiltro 300 Micron	D3876 Euro6	427	580	07/16	>		S 6088 NE		
power steering / servosterzo	D3876 Euro6	427	580	07/16	>				S 3081 PO
power steering ZF Servocom RAS-EC / servosterzo ZF Servocom RAS-EC	D3876 Euro6	427	580	07/16	>				S 5664 PO
Vehicles for building site / veicoli da cantiere	D3876 Euro6	427	580	07/16	>			S 7F29 A	
TGX 24.640 D38	D3876 Euro6	471	640	07/16	>	S 5239 PE	S 6150 NE	S 7F27 A	S 3165 C
with automatic gearbox and hydraulic retarder ZF 16S / con cambio automatico e rallentatore idraulico ZF 16S	D3876 Euro6	471	640	07/16	>				S 2234 Z
with air-conditioner / con climatizzatore	D3876 Euro6	471	640	07/16	>				S 4177 CA
dryer filter / filtro essiccatore	D3876 Euro6	471	640	07/16	>				S 7A66 A
retarder R3500/4100 (TipMatic 12+2) / freno di rallentamento R3500/4100 (TipMatic 12+2)	D3876 Euro6	471	640	07/16	>				S 5613 PO
inner / interno	D3876 Euro6	471	640	07/16	>			S 7F28 A	
prefilter / prefiltro	D3876 Euro6	471	640	07/16	>		S 4035 NR		
prefilter 300 Micron / prefiltro 300 Micron	D3876 Euro6	471	640	07/16	>		S 6088 NE		
power steering / servosterzo	D3876 Euro6	471	640	07/16	>				S 3081 PO
power steering ZF Servocom RAS-EC / servosterzo ZF Servocom RAS-EC	D3876 Euro6	471	640	07/16	>				S 5664 PO
Vehicles for building site / veicoli da cantiere	D3876 Euro6	471	640	07/16	>			S 7F29 A	
TGX 24.680 V8	D2868LF02/03/05	500	680	10/07	> 06/14		S 6011 NE	S 7619 A	S 3165 C
some 2 filters (51.05504.0110) / alcuni N.2 filtri (51.05504.0110)	D2868LF02/03/05	500	680	10/07	> 06/14	S 5147 PE			
with automatic gearbox and hydraulic retarder ZF 16S / con cambio automatico e rallentatore idraulico ZF 16S	D2868LF02/03/05	500	680	10/07	> 06/14				S 2234 Z
with air-conditioner / con climatizzatore	D2868LF02/03/05	500	680	10/07	> 06/14				S 4177 CA
dryer filter / filtro essiccatore	D2868LF02/03/05	500	680	10/07	> 06/14				S 7A66 A
inner / interno	D2868LF02/03/05	500	680	10/07	> 06/14			S 7616 A	
2 filters / N.2 filtri	D2868LF02/03/05	500	680	10/07	> 06/14	S 5046 PE			
prefilter 300 Micron / prefiltro 300 Micron	D2868LF02/03/05	500	680	10/07	> 06/14		S 6088 NE		
prefilter with fuel oil heater / prefiltro con riscaldatore nafta	D2868LF02/03/05	500	680	10/07	> 06/14		S 6059 NE		
prefilter without fuel oil heater / prefiltro senza riscaldatore nafta	D2868LF02/03/05	500	680	10/07	> 06/14		S 6062 NE		
power steering / servosterzo	D2868LF02/03/05	500	680	10/07	> 06/14				S 3081 PO
TGX 26.360	D2066 Euro4/5/EEV	265	360	10/07	>	S 5046 PE	S 6011 NE	S 7619 A	S 3165 C
with air-conditioner / con climatizzatore	D2066 Euro4/5/EEV	265	360	10/07	>				S 4177 CA
inner / interno	D2066 Euro4/5/EEV	265	360	10/07	>			S 7616 A	
prefilter with fuel oil heater / prefiltro con riscaldatore nafta	D2066 Euro4/5/EEV	265	360	10/07	>		S 6059 NE		
prefilter without fuel oil heater / prefiltro senza riscaldatore nafta	D2066 Euro4/5/EEV	265	360	10/07	>		S 6062 NE		
power steering / servosterzo	D2066 Euro4/5/EEV	265	360	10/07	>				S 3081 PO
TGX 26.400	D2066 Euro4/5/EEV	294	400	10/07	>	S 5046 PE	S 6011 NE	S 7619 A	S 3165 C
with air-conditioner / con climatizzatore	D2066 Euro4/5/EEV	294	400	10/07	>				S 4177 CA
inner / interno	D2066 Euro4/5/EEV	294	400	10/07	>			S 7616 A	
prefilter with fuel oil heater / prefiltro con riscaldatore nafta	D2066 Euro4/5/EEV	294	400	10/07	>		S 6059 NE		
prefilter without fuel oil heater / prefiltro senza riscaldatore nafta	D2066 Euro4/5/EEV	294	400	10/07	>		S 6062 NE		
power steering / servosterzo	D2066 Euro4/5/EEV	294	400	10/07	>				S 3081 PO
TGX 26.420	D2676 Euro6	309	420	07/16	>	S 5235 PE	S 6011 NE	S 7F27 A	S 3165 C
with automatic gearbox and hydraulic retarder ZF 16S / con cambio automatico e rallentatore idraulico ZF 16S	D2676 Euro6	309	420	07/16	>				S 2234 Z
with air-conditioner / con climatizzatore	D2676 Euro6	309	420	07/16	>				S 4177 CA
dryer filter / filtro essiccatore	D2676 Euro6	309	420	07/16	>				S 7A66 A
retarder R3500/4100 (TipMatic 12+2) / freno di rallentamento R3500/4100 (TipMatic 12+2)	D2676 Euro6	309	420	07/16	>				S 5613 PO
inner / interno	D2676 Euro6	309	420	07/16	>			S 7F28 A	
prefilter / prefiltro	D2676 Euro6	309	420	07/16	>		S 4035 NR		
prefilter 300 Micron / prefiltro 300 Micron	D2676 Euro6	309	420	07/16	>		S 6088 NE		
power steering / servosterzo	D2676 Euro6	309	420	07/16	>				S 3081 PO
power steering ZF Servocom RAS-EC / servosterzo ZF Servocom RAS-EC	D2676 Euro6	309	420	07/16	>				S 5664 PO
Vehicles for building site / veicoli da cantiere	D2676 Euro6	309	420	07/16	>			S 7F29 A	
TGX 26.440	D2066 Euro4/5/EEV	324	441	10/07	>	S 5046 PE	S 6011 NE	S 7619 A	S 3165 C
with air-conditioner / con climatizzatore	D2066 Euro4/5/EEV	324	441	10/07	>				S 4177 CA
inner / interno	D2066 Euro4/5/EEV	324	441	10/07	>			S 7616 A	
prefilter with fuel oil heater / prefiltro con riscaldatore nafta	D2066 Euro4/5/EEV	324	441	10/07	>		S 6059 NE		
prefilter without fuel oil heater / prefiltro senza riscaldatore nafta	D2066 Euro4/5/EEV	324	441	10/07	>		S 6062 NE		
power steering / servosterzo	D2066 Euro4/5/EEV	324	441	10/07	>				S 3081 PO
TGX 26.460	D2676 Euro6	338	460	07/16	>	S 5235 PE	S 6011 NE	S 7F27 A	S 3165 C
with automatic gearbox and hydraulic retarder ZF 16S / con cambio automatico e rallentatore idraulico ZF 16S	D2676 Euro6	338	460	07/16	>				S 2234 Z
with air-conditioner / con climatizzatore	D2676 Euro6	338	460	07/16	>				S 4177 CA
dryer filter / filtro essiccatore	D2676 Euro6	338	460	07/16	>				S 7A66 A
retarder R3500/4100 (TipMatic 12+2) / freno di rallentamento R3500/4100 (TipMatic 12+2)	D2676 Euro6	338	460	07/16	>				S 5613 PO
inner / interno	D2676 Euro6	338	460	07/16	>			S 7F28 A	

**KW HP****...MAN - trucks/autocarri**

prefilter / prefiltro	D2676 Euro6	338	460	07/16	>		S 4035 NR		
prefilter 300 Micron / prefiltro 300 Micron	D2676 Euro6	338	460	07/16	>		S 6088 NE		
power steering / servosterzo	D2676 Euro6	338	460	07/16	>				S 3081 PO
power steering ZF Servocom RAS-EC / servosterzo ZF Servocom RAS-EC	D2676 Euro6	338	460	07/16	>				S 5664 PO
Vehicles for building site / veicoli da cantiere	D2676 Euro6	338	460	07/16	>			S 7F29 A	
TGX 26.480	D2676 Euro4/5/EEV	353	480	10/07	>	S 5046 PE	S 6011 NE	S 7619 A	S 3165 C
with air-conditioner / con climatizzatore	D2676 Euro4/5/EEV	353	480	10/07	>				S 4177 CA
inner / interno	D2676 Euro4/5/EEV	353	480	10/07	>			S 7616 A	
prefilter with fuel oil heater / prefiltro con riscaldatore nafta	D2676 Euro4/5/EEV	353	480	10/07	>		S 6059 NE		
prefilter without fuel oil heater / prefiltro senza riscaldatore nafta	D2676 Euro4/5/EEV	353	480	10/07	>		S 6062 NE		
power steering / servosterzo	D2676 Euro4/5/EEV	353	480	10/07	>				S 3081 PO
TGX 26.500	D2676 Euro6	368	500	07/16	>	S 5235 PE	S 6011 NE	S 7F27 A	S 3165 C
with automatic gearbox and hydraulic retarder ZF 16S / con cambio automatico e rallentatore idraulico ZF 16S	D2676 Euro6	368	500	07/16	>				S 2234 Z
with air-conditioner / con climatizzatore	D2676 Euro6	368	500	07/16	>				S 4177 CA
dryer filter / filtro essiccatore	D2676 Euro6	368	500	07/16	>				S 7A66 A
retarder R3500/4100 (TipMatic 12+2) / freno di rallentamento R3500/4100 (TipMatic 12+2)	D2676 Euro6	368	500	07/16	>				S 5613 PO
inner / interno	D2676 Euro6	368	500	07/16	>			S 7F28 A	
prefilter / prefiltro	D2676 Euro6	368	500	07/16	>		S 4035 NR		
prefilter 300 Micron / prefiltro 300 Micron	D2676 Euro6	368	500	07/16	>		S 6088 NE		
power steering / servosterzo	D2676 Euro6	368	500	07/16	>				S 3081 PO
power steering ZF Servocom RAS-EC / servosterzo ZF Servocom RAS-EC	D2676 Euro6	368	500	07/16	>				S 5664 PO
Vehicles for building site / veicoli da cantiere	D2676 Euro6	368	500	07/16	>			S 7F29 A	
TGX 26.520 D38	D3876	382	519	08/14	>	S 5239 PE	S 6150 NE	S 7619 A	S 3165 C
with air-conditioner / con climatizzatore	D3876	382	519	08/14	>				S 4177 CA
dryer filter / filtro essiccatore	D3876	382	519	08/14	>				S 7A66 A
inner / interno	D3876	382	519	08/14	>			S 7616 A	
prefilter / prefiltro	D3876	382	519	08/14	>		S 4035 NR		
power steering / servosterzo	D3876	382	519	08/14	>				S 3081 PO
TGX 26.540	D2676 Euro4/5/EEV	397	540	10/07	> 07/16	S 5046 PE	S 6011 NE	S 7619 A	S 3165 C
with air-conditioner / con climatizzatore	D2676 Euro4/5/EEV	397	540	10/07	> 07/16				S 4177 CA
inner / interno	D2676 Euro4/5/EEV	397	540	10/07	> 07/16			S 7616 A	
prefilter with fuel oil heater / prefiltro con riscaldatore nafta	D2676 Euro4/5/EEV	397	540	10/07	> 07/16		S 6059 NE		
prefilter without fuel oil heater / prefiltro senza riscaldatore nafta	D2676 Euro4/5/EEV	397	540	10/07	> 07/16		S 6062 NE		
power steering / servosterzo	D2676 Euro4/5/EEV	397	540	10/07	> 07/16				S 3081 PO
TGX 26.540 D38	D3876 Euro6	397	540	07/16	>	S 5239 PE	S 6150 NE	S 7F27 A	S 3165 C
with automatic gearbox and hydraulic retarder ZF 16S / con cambio automatico e rallentatore idraulico ZF 16S	D3876 Euro6	397	540	07/16	>				S 2234 Z
with air-conditioner / con climatizzatore	D3876 Euro6	397	540	07/16	>				S 4177 CA
dryer filter / filtro essiccatore	D3876 Euro6	397	540	07/16	>				S 7A66 A
retarder R3500/4100 (TipMatic 12+2) / freno di rallentamento R3500/4100 (TipMatic 12+2)	D3876 Euro6	397	540	07/16	>				S 5613 PO
inner / interno	D3876 Euro6	397	540	07/16	>			S 7F28 A	
prefilter / prefiltro	D3876 Euro6	397	540	07/16	>		S 4035 NR		
prefilter 300 Micron / prefiltro 300 Micron	D3876 Euro6	397	540	07/16	>		S 6088 NE		
power steering / servosterzo	D3876 Euro6	397	540	07/16	>				S 3081 PO
power steering ZF Servocom RAS-EC / servosterzo ZF Servocom RAS-EC	D3876 Euro6	397	540	07/16	>				S 5664 PO
Vehicles for building site / veicoli da cantiere	D3876 Euro6	397	540	07/16	>			S 7F29 A	
TGX 26.560 D38	D3876	412	560	08/14	>	S 5239 PE	S 6150 NE	S 7619 A	S 3165 C
with air-conditioner / con climatizzatore	D3876	412	560	08/14	>				S 4177 CA
dryer filter / filtro essiccatore	D3876	412	560	08/14	>				S 7A66 A
inner / interno	D3876	412	560	08/14	>			S 7616 A	
prefilter / prefiltro	D3876	412	560	08/14	>		S 4035 NR		
power steering / servosterzo	D3876	412	560	08/14	>				S 3081 PO
TGX 26.580 D38	D3876 Euro6	427	580	07/16	>	S 5239 PE	S 6150 NE	S 7F27 A	S 3165 C
with automatic gearbox and hydraulic retarder ZF 16S / con cambio automatico e rallentatore idraulico ZF 16S	D3876 Euro6	427	580	07/16	>				S 2234 Z
with air-conditioner / con climatizzatore	D3876 Euro6	427	580	07/16	>				S 4177 CA
dryer filter / filtro essiccatore	D3876 Euro6	427	580	07/16	>				S 7A66 A
retarder R3500/4100 (TipMatic 12+2) / freno di rallentamento R3500/4100 (TipMatic 12+2)	D3876 Euro6	427	580	07/16	>				S 5613 PO
inner / interno	D3876 Euro6	427	580	07/16	>			S 7F28 A	
prefilter / prefiltro	D3876 Euro6	427	580	07/16	>		S 4035 NR		
prefilter 300 Micron / prefiltro 300 Micron	D3876 Euro6	427	580	07/16	>		S 6088 NE		
power steering / servosterzo	D3876 Euro6	427	580	07/16	>				S 3081 PO
power steering ZF Servocom RAS-EC / servosterzo ZF Servocom RAS-EC	D3876 Euro6	427	580	07/16	>				S 5664 PO
Vehicles for building site / veicoli da cantiere	D3876 Euro6	427	580	07/16	>			S 7F29 A	
TGX 26.640 D38	D3876 Euro6	471	640	07/16	>	S 5239 PE	S 6150 NE	S 7F27 A	S 3165 C
with automatic gearbox and hydraulic retarder ZF 16S / con cambio automatico e rallentatore idraulico ZF 16S	D3876 Euro6	471	640	07/16	>				S 2234 Z
with air-conditioner / con climatizzatore	D3876 Euro6	471	640	07/16	>				S 4177 CA
dryer filter / filtro essiccatore	D3876 Euro6	471	640	07/16	>				S 7A66 A
retarder R3500/4100 (TipMatic 12+2) / freno di rallentamento R3500/4100 (TipMatic 12+2)	D3876 Euro6	471	640	07/16	>				S 5613 PO

M



...MAN - trucks/autocarri

M



inner / interno	D3876 Euro6	471	640	07/16	>			S 7F28 A	
prefilter / prefiltro	D3876 Euro6	471	640	07/16	>		S 4035 NR		
prefilter 300 Micron / prefiltro 300 Micron	D3876 Euro6	471	640	07/16	>		S 6088 NE		
power steering / servosterzo	D3876 Euro6	471	640	07/16	>				S 3081 PO
power steering ZF Servocom RAS-EC / servosterzo ZF Servocom RAS-EC	D3876 Euro6	471	640	07/16	>				S 5664 PO
Vehicles for building site / veicoli da cantiere	D3876 Euro6	471	640	07/16	>			S 7F29 A	
TXG 26.680 V8	D2868LF02/03/05	500	680	10/07	>	06/14	S 6011 NE	S 7619 A	S 3165 C
some 2 filters (51.05504.0110) / alcuni N.2 filtri (51.05504.0110)	D2868LF02/03/05	500	680	10/07	>	06/14	S 5147 PE		
with automatic gearbox and hydraulic retarder ZF 16S / con cambio automatico e rallentatore idraulico ZF 16S	D2868LF02/03/05	500	680	10/07	>	06/14			S 2234 Z
with air-conditioner / con climatizzatore	D2868LF02/03/05	500	680	10/07	>	06/14			S 4177 CA
dryer filter / filtro essiccatore	D2868LF02/03/05	500	680	10/07	>	06/14			S 7A66 A
inner / interno	D2868LF02/03/05	500	680	10/07	>	06/14		S 7616 A	
2 filters / N.2 filtri	D2868LF02/03/05	500	680	10/07	>	06/14	S 5046 PE		
prefilter 300 Micron / prefiltro 300 Micron	D2868LF02/03/05	500	680	10/07	>	06/14	S 6088 NE		
prefilter with fuel oil heater / prefiltro con riscaldatore nafta	D2868LF02/03/05	500	680	10/07	>	06/14	S 6059 NE		
prefilter without fuel oil heater / prefiltro senza riscaldatore nafta	D2868LF02/03/05	500	680	10/07	>	06/14	S 6062 NE		
power steering / servosterzo	D2868LF02/03/05	500	680	10/07	>	06/14			S 3081 PO
TXG 28.360	D2066 Euro4/5/EEV	265	360	10/07	>		S 5046 PE	S 6011 NE	S 7619 A
with air-conditioner / con climatizzatore	D2066 Euro4/5/EEV	265	360	10/07	>				S 3165 C
inner / interno	D2066 Euro4/5/EEV	265	360	10/07	>			S 7616 A	S 4177 CA
prefilter with fuel oil heater / prefiltro con riscaldatore nafta	D2066 Euro4/5/EEV	265	360	10/07	>		S 6059 NE		
prefilter without fuel oil heater / prefiltro senza riscaldatore nafta	D2066 Euro4/5/EEV	265	360	10/07	>		S 6062 NE		
power steering / servosterzo	D2066 Euro4/5/EEV	265	360	10/07	>				S 3081 PO
TXG 28.400	D2066 Euro4/5/EEV	294	400	10/07	>		S 5046 PE	S 6011 NE	S 7619 A
with air-conditioner / con climatizzatore	D2066 Euro4/5/EEV	294	400	10/07	>				S 3165 C
inner / interno	D2066 Euro4/5/EEV	294	400	10/07	>			S 7616 A	S 4177 CA
prefilter with fuel oil heater / prefiltro con riscaldatore nafta	D2066 Euro4/5/EEV	294	400	10/07	>		S 6059 NE		
prefilter without fuel oil heater / prefiltro senza riscaldatore nafta	D2066 Euro4/5/EEV	294	400	10/07	>		S 6062 NE		
power steering / servosterzo	D2066 Euro4/5/EEV	294	400	10/07	>				S 3081 PO
TXG 28.420	D2676 Euro6	309	420	07/16	>		S 5235 PE	S 6011 NE	S 7F27 A
with automatic gearbox and hydraulic retarder ZF 16S / con cambio automatico e rallentatore idraulico ZF 16S	D2676 Euro6	309	420	07/16	>				S 3165 C
with air-conditioner / con climatizzatore	D2676 Euro6	309	420	07/16	>				S 2234 Z
dryer filter / filtro essiccatore	D2676 Euro6	309	420	07/16	>				S 4177 CA
retarder R3500/4100 (TipMatic 12+2) / freno di rallentamento R3500/4100 (TipMatic 12+2)	D2676 Euro6	309	420	07/16	>				S 7A66 A
inner / interno	D2676 Euro6	309	420	07/16	>			S 7F28 A	S 5613 PO
prefilter / prefiltro	D2676 Euro6	309	420	07/16	>		S 4035 NR		
prefilter 300 Micron / prefiltro 300 Micron	D2676 Euro6	309	420	07/16	>		S 6088 NE		
power steering / servosterzo	D2676 Euro6	309	420	07/16	>				S 3081 PO
power steering ZF Servocom RAS-EC / servosterzo ZF Servocom RAS-EC	D2676 Euro6	309	420	07/16	>				S 5664 PO
Vehicles for building site / veicoli da cantiere	D2676 Euro6	309	420	07/16	>			S 7F29 A	
TXG 28.440	D2066 Euro4/5/EEV	324	441	10/07	>		S 5046 PE	S 6011 NE	S 7619 A
with air-conditioner / con climatizzatore	D2066 Euro4/5/EEV	324	441	10/07	>				S 3165 C
inner / interno	D2066 Euro4/5/EEV	324	441	10/07	>			S 7616 A	S 4177 CA
prefilter with fuel oil heater / prefiltro con riscaldatore nafta	D2066 Euro4/5/EEV	324	441	10/07	>		S 6059 NE		
prefilter without fuel oil heater / prefiltro senza riscaldatore nafta	D2066 Euro4/5/EEV	324	441	10/07	>		S 6062 NE		
power steering / servosterzo	D2066 Euro4/5/EEV	324	441	10/07	>				S 3081 PO
TXG 28.460	D2676 Euro6	338	460	07/16	>		S 5235 PE	S 6011 NE	S 7F27 A
with automatic gearbox and hydraulic retarder ZF 16S / con cambio automatico e rallentatore idraulico ZF 16S	D2676 Euro6	338	460	07/16	>				S 3165 C
with air-conditioner / con climatizzatore	D2676 Euro6	338	460	07/16	>				S 2234 Z
dryer filter / filtro essiccatore	D2676 Euro6	338	460	07/16	>				S 4177 CA
retarder R3500/4100 (TipMatic 12+2) / freno di rallentamento R3500/4100 (TipMatic 12+2)	D2676 Euro6	338	460	07/16	>				S 7A66 A
inner / interno	D2676 Euro6	338	460	07/16	>			S 7F28 A	S 5613 PO
prefilter / prefiltro	D2676 Euro6	338	460	07/16	>		S 4035 NR		
prefilter 300 Micron / prefiltro 300 Micron	D2676 Euro6	338	460	07/16	>		S 6088 NE		
power steering / servosterzo	D2676 Euro6	338	460	07/16	>				S 3081 PO
power steering ZF Servocom RAS-EC / servosterzo ZF Servocom RAS-EC	D2676 Euro6	338	460	07/16	>				S 5664 PO
Vehicles for building site / veicoli da cantiere	D2676 Euro6	338	460	07/16	>			S 7F29 A	
TXG 28.480	D2676 Euro4/5/EEV	353	480	10/07	>		S 5046 PE	S 6011 NE	S 7619 A
with air-conditioner / con climatizzatore	D2676 Euro4/5/EEV	353	480	10/07	>				S 3165 C
inner / interno	D2676 Euro4/5/EEV	353	480	10/07	>			S 7616 A	S 4177 CA
prefilter with fuel oil heater / prefiltro con riscaldatore nafta	D2676 Euro4/5/EEV	353	480	10/07	>		S 6059 NE		
prefilter without fuel oil heater / prefiltro senza riscaldatore nafta	D2676 Euro4/5/EEV	353	480	10/07	>		S 6062 NE		
power steering / servosterzo	D2676 Euro4/5/EEV	353	480	10/07	>				S 3081 PO
TXG 28.500	D2676 Euro6	368	500	07/16	>		S 5235 PE	S 6011 NE	S 7F27 A
with automatic gearbox and hydraulic retarder ZF 16S / con cambio automatico e rallentatore idraulico ZF 16S	D2676 Euro6	368	500	07/16	>				S 3165 C
with air-conditioner / con climatizzatore	D2676 Euro6	368	500	07/16	>				S 2234 Z
dryer filter / filtro essiccatore	D2676 Euro6	368	500	07/16	>				S 4177 CA
									S 7A66 A

**KW HP****...MAN - trucks/autocarri**

retarder R3500/4100 (TipMatic 12+2) / freno di rallentamento R3500/4100 (TipMatic 12+2)	D2676 Euro6	368	500	07/16	>				S 5613 PO
inner / interno	D2676 Euro6	368	500	07/16	>			S 7F28 A	
prefilter / prefiltro	D2676 Euro6	368	500	07/16	>		S 4035 NR		
prefilter 300 Micron / prefiltro 300 Micron	D2676 Euro6	368	500	07/16	>		S 6088 NE		
power steering / servosterzo	D2676 Euro6	368	500	07/16	>				S 3081 PO
power steering ZF Servocom RAS-EC / servosterzo ZF Servocom RAS-EC	D2676 Euro6	368	500	07/16	>				S 5664 PO
Vehicles for building site / veicoli da cantiere	D2676 Euro6	368	500	07/16	>			S 7F29 A	
TGX 28.520 D38	D3876	382	519	08/14	>	S 5239 PE	S 6150 NE	S 7619 A	S 3165 C
with air-conditioner / con climatizzatore	D3876	382	519	08/14	>				S 4177 CA
dryer filter / filtro essiccatore	D3876	382	519	08/14	>				S 7A66 A
inner / interno	D3876	382	519	08/14	>			S 7616 A	
prefilter / prefiltro	D3876	382	519	08/14	>		S 4035 NR		
power steering / servosterzo	D3876	382	519	08/14	>				S 3081 PO
TGX 28.540	D2676 Euro4/5/EEV	397	540	10/07	> 07/16	S 5046 PE	S 6011 NE	S 7619 A	S 3165 C
with air-conditioner / con climatizzatore	D2676 Euro4/5/EEV	397	540	10/07	> 07/16			S 7616 A	S 4177 CA
inner / interno	D2676 Euro4/5/EEV	397	540	10/07	> 07/16				
prefilter with fuel oil heater / prefiltro con riscaldatore nafta	D2676 Euro4/5/EEV	397	540	10/07	> 07/16		S 6059 NE		
prefilter without fuel oil heater / prefiltro senza riscaldatore nafta	D2676 Euro4/5/EEV	397	540	10/07	> 07/16		S 6062 NE		
power steering / servosterzo	D2676 Euro4/5/EEV	397	540	10/07	> 07/16				S 3081 PO
TGX 28.540 D38	D3876 Euro6	397	540	07/16	>	S 5239 PE	S 6150 NE	S 7F27 A	S 3165 C
with automatic gearbox and hydraulic retarder ZF 16S / con cambio automatico e rallentatore idraulico ZF 16S	D3876 Euro6	397	540	07/16	>				S 2234 Z
with air-conditioner / con climatizzatore	D3876 Euro6	397	540	07/16	>				S 4177 CA
dryer filter / filtro essiccatore	D3876 Euro6	397	540	07/16	>				S 7A66 A
retarder R3500/4100 (TipMatic 12+2) / freno di rallentamento R3500/4100 (TipMatic 12+2)	D3876 Euro6	397	540	07/16	>				S 5613 PO
inner / interno	D3876 Euro6	397	540	07/16	>			S 7F28 A	
prefilter / prefiltro	D3876 Euro6	397	540	07/16	>		S 4035 NR		
prefilter 300 Micron / prefiltro 300 Micron	D3876 Euro6	397	540	07/16	>		S 6088 NE		
power steering / servosterzo	D3876 Euro6	397	540	07/16	>				S 3081 PO
power steering ZF Servocom RAS-EC / servosterzo ZF Servocom RAS-EC	D3876 Euro6	397	540	07/16	>				S 5664 PO
Vehicles for building site / veicoli da cantiere	D3876 Euro6	397	540	07/16	>			S 7F29 A	
TGX 28.560 D38	D3876	412	560	08/14	>	S 5239 PE	S 6150 NE	S 7619 A	S 3165 C
with air-conditioner / con climatizzatore	D3876	412	560	08/14	>				S 4177 CA
dryer filter / filtro essiccatore	D3876	412	560	08/14	>				S 7A66 A
inner / interno	D3876	412	560	08/14	>			S 7616 A	
prefilter / prefiltro	D3876	412	560	08/14	>		S 4035 NR		
power steering / servosterzo	D3876	412	560	08/14	>				S 3081 PO
TGX 28.580 D38	D3876 Euro6	427	580	07/16	>	S 5239 PE	S 6150 NE	S 7F27 A	S 3165 C
with automatic gearbox and hydraulic retarder ZF 16S / con cambio automatico e rallentatore idraulico ZF 16S	D3876 Euro6	427	580	07/16	>				S 2234 Z
with air-conditioner / con climatizzatore	D3876 Euro6	427	580	07/16	>				S 4177 CA
dryer filter / filtro essiccatore	D3876 Euro6	427	580	07/16	>				S 7A66 A
retarder R3500/4100 (TipMatic 12+2) / freno di rallentamento R3500/4100 (TipMatic 12+2)	D3876 Euro6	427	580	07/16	>				S 5613 PO
inner / interno	D3876 Euro6	427	580	07/16	>			S 7F28 A	
prefilter / prefiltro	D3876 Euro6	427	580	07/16	>		S 4035 NR		
prefilter 300 Micron / prefiltro 300 Micron	D3876 Euro6	427	580	07/16	>		S 6088 NE		
power steering / servosterzo	D3876 Euro6	427	580	07/16	>				S 3081 PO
power steering ZF Servocom RAS-EC / servosterzo ZF Servocom RAS-EC	D3876 Euro6	427	580	07/16	>				S 5664 PO
Vehicles for building site / veicoli da cantiere	D3876 Euro6	427	580	07/16	>			S 7F29 A	
TGX 28.640 D38	D3876 Euro6	471	640	07/16	>	S 5239 PE	S 6150 NE	S 7F27 A	S 3165 C
with automatic gearbox and hydraulic retarder ZF 16S / con cambio automatico e rallentatore idraulico ZF 16S	D3876 Euro6	471	640	07/16	>				S 2234 Z
with air-conditioner / con climatizzatore	D3876 Euro6	471	640	07/16	>				S 4177 CA
dryer filter / filtro essiccatore	D3876 Euro6	471	640	07/16	>				S 7A66 A
retarder R3500/4100 (TipMatic 12+2) / freno di rallentamento R3500/4100 (TipMatic 12+2)	D3876 Euro6	471	640	07/16	>				S 5613 PO
inner / interno	D3876 Euro6	471	640	07/16	>			S 7F28 A	
prefilter / prefiltro	D3876 Euro6	471	640	07/16	>		S 4035 NR		
prefilter 300 Micron / prefiltro 300 Micron	D3876 Euro6	471	640	07/16	>		S 6088 NE		
power steering / servosterzo	D3876 Euro6	471	640	07/16	>				S 3081 PO
power steering ZF Servocom RAS-EC / servosterzo ZF Servocom RAS-EC	D3876 Euro6	471	640	07/16	>				S 5664 PO
Vehicles for building site / veicoli da cantiere	D3876 Euro6	471	640	07/16	>			S 7F29 A	
TGX 28.680 V8	D2868LF02/03/05	500	680	10/07	> 06/14		S 6011 NE	S 7619 A	S 3165 C
some 2 filters (51.05504.0110) / alcuni N.2 filtri (51.05504.0110)	D2868LF02/03/05	500	680	10/07	> 06/14	S 5147 PE			
with automatic gearbox and hydraulic retarder ZF 16S / con cambio automatico e rallentatore idraulico ZF 16S	D2868LF02/03/05	500	680	10/07	> 06/14				S 2234 Z
with air-conditioner / con climatizzatore	D2868LF02/03/05	500	680	10/07	> 06/14				S 4177 CA
dryer filter / filtro essiccatore	D2868LF02/03/05	500	680	10/07	> 06/14				S 7A66 A
inner / interno	D2868LF02/03/05	500	680	10/07	> 06/14			S 7616 A	
2 filters / N.2 filtri	D2868LF02/03/05	500	680	10/07	> 06/14	S 5046 PE			
prefilter 300 Micron / prefiltro 300 Micron	D2868LF02/03/05	500	680	10/07	> 06/14		S 6088 NE		
prefilter with fuel oil heater / prefiltro con riscaldatore nafta	D2868LF02/03/05	500	680	10/07	> 06/14		S 6059 NE		

M

**KW HP****...MAN - trucks/autocarri**

prefilter without fuel oil heater / prefiltro senza riscaldatore nafta	D2868LF02/03/05	500	680	10/07	>	06/14		S 6062 NE		
power steering / servosterzo	D2868LF02/03/05	500	680	10/07	>	06/14				S 3081 PO
TXG 33.360	D2066 Euro4/5/EEV	265	360	10/07	>		S 5046 PE	S 6011 NE	S 7619 A	S 3165 C
with air-conditioner / con climatizzatore	D2066 Euro4/5/EEV	265	360	10/07	>				S 7616 A	S 4177 CA
inner / interno	D2066 Euro4/5/EEV	265	360	10/07	>					
prefilter with fuel oil heater / prefiltro con riscaldatore nafta	D2066 Euro4/5/EEV	265	360	10/07	>			S 6059 NE		
prefilter without fuel oil heater / prefiltro senza riscaldatore nafta	D2066 Euro4/5/EEV	265	360	10/07	>			S 6062 NE		
power steering / servosterzo	D2066 Euro4/5/EEV	265	360	10/07	>					S 3081 PO
TXG 33.400	D2066 Euro4/5/EEV	294	400	10/07	>		S 5046 PE	S 6011 NE	S 7619 A	S 3165 C
with air-conditioner / con climatizzatore	D2066 Euro4/5/EEV	294	400	10/07	>				S 7616 A	S 4177 CA
inner / interno	D2066 Euro4/5/EEV	294	400	10/07	>					
prefilter with fuel oil heater / prefiltro con riscaldatore nafta	D2066 Euro4/5/EEV	294	400	10/07	>			S 6059 NE		
prefilter without fuel oil heater / prefiltro senza riscaldatore nafta	D2066 Euro4/5/EEV	294	400	10/07	>			S 6062 NE		
power steering / servosterzo	D2066 Euro4/5/EEV	294	400	10/07	>					S 3081 PO
TXG 33.420	D2676 Euro6	309	420	07/16	>		S 5235 PE	S 6011 NE	S 7F27 A	S 3165 C
with automatic gearbox and hydraulic retarder ZF 16S / con cambio automatico e rallentatore idraulico ZF 16S	D2676 Euro6	309	420	07/16	>					S 2234 Z
with air-conditioner / con climatizzatore	D2676 Euro6	309	420	07/16	>					S 4177 CA
dryer filter / filtro essiccatore	D2676 Euro6	309	420	07/16	>					S 7A66 A
retarder R3500/4100 (TipMatic 12+2) / freno di rallentamento R3500/4100 (TipMatic 12+2)	D2676 Euro6	309	420	07/16	>					S 5613 PO
inner / interno	D2676 Euro6	309	420	07/16	>				S 7F28 A	
prefilter / prefiltro	D2676 Euro6	309	420	07/16	>			S 4035 NR		
prefilter 300 Micron / prefiltro 300 Micron	D2676 Euro6	309	420	07/16	>			S 6088 NE		
power steering / servosterzo	D2676 Euro6	309	420	07/16	>					S 3081 PO
power steering ZF Servocom RAS-EC / servosterzo ZF Servocom RAS-EC	D2676 Euro6	309	420	07/16	>					S 5664 PO
Vehicles for building site / veicoli da cantiere	D2676 Euro6	309	420	07/16	>				S 7F29 A	
TXG 33.440	D2066 Euro4/5/EEV	324	441	10/07	>		S 5046 PE	S 6011 NE	S 7619 A	S 3165 C
with air-conditioner / con climatizzatore	D2066 Euro4/5/EEV	324	441	10/07	>				S 7616 A	S 4177 CA
inner / interno	D2066 Euro4/5/EEV	324	441	10/07	>					
prefilter with fuel oil heater / prefiltro con riscaldatore nafta	D2066 Euro4/5/EEV	324	441	10/07	>			S 6059 NE		
prefilter without fuel oil heater / prefiltro senza riscaldatore nafta	D2066 Euro4/5/EEV	324	441	10/07	>			S 6062 NE		
power steering / servosterzo	D2066 Euro4/5/EEV	324	441	10/07	>					S 3081 PO
TXG 33.460	D2676 Euro6	338	460	07/16	>		S 5235 PE	S 6011 NE	S 7F27 A	S 3165 C
with automatic gearbox and hydraulic retarder ZF 16S / con cambio automatico e rallentatore idraulico ZF 16S	D2676 Euro6	338	460	07/16	>					S 2234 Z
with air-conditioner / con climatizzatore	D2676 Euro6	338	460	07/16	>					S 4177 CA
dryer filter / filtro essiccatore	D2676 Euro6	338	460	07/16	>					S 7A66 A
retarder R3500/4100 (TipMatic 12+2) / freno di rallentamento R3500/4100 (TipMatic 12+2)	D2676 Euro6	338	460	07/16	>					S 5613 PO
inner / interno	D2676 Euro6	338	460	07/16	>				S 7F28 A	
prefilter / prefiltro	D2676 Euro6	338	460	07/16	>			S 4035 NR		
prefilter 300 Micron / prefiltro 300 Micron	D2676 Euro6	338	460	07/16	>			S 6088 NE		
power steering / servosterzo	D2676 Euro6	338	460	07/16	>					S 3081 PO
power steering ZF Servocom RAS-EC / servosterzo ZF Servocom RAS-EC	D2676 Euro6	338	460	07/16	>					S 5664 PO
Vehicles for building site / veicoli da cantiere	D2676 Euro6	338	460	07/16	>				S 7F29 A	
TXG 33.480	D2676 Euro4/5/EEV	353	480	10/07	>		S 5046 PE	S 6011 NE	S 7619 A	S 3165 C
with air-conditioner / con climatizzatore	D2676 Euro4/5/EEV	353	480	10/07	>				S 7616 A	S 4177 CA
inner / interno	D2676 Euro4/5/EEV	353	480	10/07	>					
prefilter with fuel oil heater / prefiltro con riscaldatore nafta	D2676 Euro4/5/EEV	353	480	10/07	>			S 6059 NE		
prefilter without fuel oil heater / prefiltro senza riscaldatore nafta	D2676 Euro4/5/EEV	353	480	10/07	>			S 6062 NE		
power steering / servosterzo	D2676 Euro4/5/EEV	353	480	10/07	>					S 3081 PO
TXG 33.500	D2676 Euro6	368	500	07/16	>		S 5235 PE	S 6011 NE	S 7F27 A	S 3165 C
with automatic gearbox and hydraulic retarder ZF 16S / con cambio automatico e rallentatore idraulico ZF 16S	D2676 Euro6	368	500	07/16	>					S 2234 Z
with air-conditioner / con climatizzatore	D2676 Euro6	368	500	07/16	>					S 4177 CA
dryer filter / filtro essiccatore	D2676 Euro6	368	500	07/16	>					S 7A66 A
retarder R3500/4100 (TipMatic 12+2) / freno di rallentamento R3500/4100 (TipMatic 12+2)	D2676 Euro6	368	500	07/16	>					S 5613 PO
inner / interno	D2676 Euro6	368	500	07/16	>				S 7F28 A	
prefilter / prefiltro	D2676 Euro6	368	500	07/16	>			S 4035 NR		
prefilter 300 Micron / prefiltro 300 Micron	D2676 Euro6	368	500	07/16	>			S 6088 NE		
power steering / servosterzo	D2676 Euro6	368	500	07/16	>					S 3081 PO
power steering ZF Servocom RAS-EC / servosterzo ZF Servocom RAS-EC	D2676 Euro6	368	500	07/16	>					S 5664 PO
Vehicles for building site / veicoli da cantiere	D2676 Euro6	368	500	07/16	>				S 7F29 A	
TXG 33.520 D38	D3876	382	519	08/14	>		S 5239 PE	S 6150 NE	S 7619 A	S 3165 C
with air-conditioner / con climatizzatore	D3876	382	519	08/14	>					S 4177 CA
dryer filter / filtro essiccatore	D3876	382	519	08/14	>					S 7A66 A
inner / interno	D3876	382	519	08/14	>				S 7616 A	
prefilter / prefiltro	D3876	382	519	08/14	>			S 4035 NR		
power steering / servosterzo	D3876	382	519	08/14	>					S 3081 PO
TXG 33.540	D2676 Euro4/5/EEV	397	540	10/07	>	07/16	S 5046 PE	S 6011 NE	S 7619 A	S 3165 C
with air-conditioner / con climatizzatore	D2676 Euro4/5/EEV	397	540	10/07	>	07/16				S 4177 CA

**kW HP****...MAN - trucks/autocarri**

inner / interno	D2676 Euro4/5/EEV	397	540	10/07	>	07/16			S 7616 A	
prefilter with fuel oil heater / prefiltro con riscaldatore nafta	D2676 Euro4/5/EEV	397	540	10/07	>	07/16		S 6059 NE		
prefilter without fuel oil heater / prefiltro senza riscaldatore nafta	D2676 Euro4/5/EEV	397	540	10/07	>	07/16		S 6062 NE		
power steering / servosterzo	D2676 Euro4/5/EEV	397	540	10/07	>	07/16				S 3081 PO
TGX 33.540 D38	D3876 Euro6	397	540	07/16	>		S 5239 PE	S 6150 NE	S 7F27 A	S 3165 C
with automatic gearbox and hydraulic retarder ZF 16S / con cambio automatico e rallentatore idraulico ZF 16S	D3876 Euro6	397	540	07/16	>					S 2234 Z
with air-conditioner / con climatizzatore	D3876 Euro6	397	540	07/16	>					S 4177 CA
dryer filter / filtro essiccatore	D3876 Euro6	397	540	07/16	>					S 7A66 A
retarder R3500/4100 (TipMatic 12+2) / freno di rallentamento R3500/4100 (TipMatic 12+2)	D3876 Euro6	397	540	07/16	>					S 5613 PO
inner / interno	D3876 Euro6	397	540	07/16	>				S 7F28 A	
prefilter / prefiltro	D3876 Euro6	397	540	07/16	>			S 4035 NR		
prefilter 300 Micron / prefiltro 300 Micron	D3876 Euro6	397	540	07/16	>			S 6088 NE		
power steering / servosterzo	D3876 Euro6	397	540	07/16	>					S 3081 PO
power steering ZF Servocom RAS-EC / servosterzo ZF Servocom RAS-EC	D3876 Euro6	397	540	07/16	>					S 5664 PO
Vehicles for building site / veicoli da cantiere	D3876 Euro6	397	540	07/16	>				S 7F29 A	
TGX 33.560 D38	D3876	412	560	08/14	>		S 5239 PE	S 6150 NE	S 7619 A	S 3165 C
with air-conditioner / con climatizzatore	D3876	412	560	08/14	>					S 4177 CA
dryer filter / filtro essiccatore	D3876	412	560	08/14	>					S 7A66 A
inner / interno	D3876	412	560	08/14	>				S 7616 A	
prefilter / prefiltro	D3876	412	560	08/14	>			S 4035 NR		
power steering / servosterzo	D3876	412	560	08/14	>					S 3081 PO
TGX 33.580 D38	D3876 Euro6	427	580	07/16	>		S 5239 PE	S 6150 NE	S 7F27 A	S 3165 C
with automatic gearbox and hydraulic retarder ZF 16S / con cambio automatico e rallentatore idraulico ZF 16S	D3876 Euro6	427	580	07/16	>					S 2234 Z
with air-conditioner / con climatizzatore	D3876 Euro6	427	580	07/16	>					S 4177 CA
dryer filter / filtro essiccatore	D3876 Euro6	427	580	07/16	>					S 7A66 A
retarder R3500/4100 (TipMatic 12+2) / freno di rallentamento R3500/4100 (TipMatic 12+2)	D3876 Euro6	427	580	07/16	>					S 5613 PO
inner / interno	D3876 Euro6	427	580	07/16	>				S 7F28 A	
prefilter / prefiltro	D3876 Euro6	427	580	07/16	>			S 4035 NR		
prefilter 300 Micron / prefiltro 300 Micron	D3876 Euro6	427	580	07/16	>			S 6088 NE		
power steering / servosterzo	D3876 Euro6	427	580	07/16	>					S 3081 PO
power steering ZF Servocom RAS-EC / servosterzo ZF Servocom RAS-EC	D3876 Euro6	427	580	07/16	>					S 5664 PO
Vehicles for building site / veicoli da cantiere	D3876 Euro6	427	580	07/16	>				S 7F29 A	
TGX 33.640 D38	D3876 Euro6	471	640	08/14	>	06/16	S 5239 PE	S 6150 NE	S 7619 A	S 3165 C
	D3876 Euro6	471	640	07/16	>		S 5239 PE	S 6150 NE	S 7F27 A	S 3165 C
with automatic gearbox and hydraulic retarder ZF 16S / con cambio automatico e rallentatore idraulico ZF 16S	D3876 Euro6	471	640	08/14	>					S 2234 Z
with air-conditioner / con climatizzatore	D3876 Euro6	471	640	08/14	>					S 4177 CA
dryer filter / filtro essiccatore	D3876 Euro6	471	640	08/14	>					S 7A66 A
retarder R3500/4100 (TipMatic 12+2) / freno di rallentamento R3500/4100 (TipMatic 12+2)	D3876 Euro6	471	640	07/16	>					S 5613 PO
inner / interno	D3876 Euro6	471	640	08/14	>	06/16			S 7616 A	
inner / interno	D3876 Euro6	471	640	07/16	>				S 7F28 A	
prefilter / prefiltro	D3876 Euro6	471	640	08/14	>			S 4035 NR		
prefilter 300 Micron / prefiltro 300 Micron	D3876 Euro6	471	640	08/14	>			S 6088 NE		
power steering / servosterzo	D3876 Euro6	471	640	08/14	>					S 3081 PO
power steering ZF Servocom RAS-EC / servosterzo ZF Servocom RAS-EC	D3876 Euro6	471	640	07/16	>					S 5664 PO
Vehicles for building site / veicoli da cantiere	D3876 Euro6	471	640	08/14	>	06/16			S 7E35 A	
Vehicles for building site / veicoli da cantiere	D3876 Euro6	471	640	07/16	>				S 7F29 A	
TGX 33.680 V8	D2868LF02/03/05	500	680	10/07	>	06/14		S 6011 NE	S 7619 A	S 3165 C
some 2 filters (51.05504.0110) / alcuni N.2 filtri (51.05504.0110)	D2868LF02/03/05	500	680	10/07	>	06/14	S 5147 PE			
with automatic gearbox and hydraulic retarder ZF 16S / con cambio automatico e rallentatore idraulico ZF 16S	D2868LF02/03/05	500	680	10/07	>	06/14				S 2234 Z
with air-conditioner / con climatizzatore	D2868LF02/03/05	500	680	10/07	>	06/14				S 4177 CA
dryer filter / filtro essiccatore	D2868LF02/03/05	500	680	10/07	>	06/14				S 7A66 A
inner / interno	D2868LF02/03/05	500	680	10/07	>	06/14			S 7616 A	
2 filters / N.2 filtri	D2868LF02/03/05	500	680	10/07	>	06/14	S 5046 PE			
prefilter 300 Micron / prefiltro 300 Micron	D2868LF02/03/05	500	680	10/07	>	06/14		S 6088 NE		
prefilter with fuel oil heater / prefiltro con riscaldatore nafta	D2868LF02/03/05	500	680	10/07	>	06/14		S 6059 NE		
prefilter without fuel oil heater / prefiltro senza riscaldatore nafta	D2868LF02/03/05	500	680	10/07	>	06/14		S 6062 NE		
power steering / servosterzo	D2868LF02/03/05	500	680	10/07	>	06/14				S 3081 PO
TGX 35.420	D2676 Euro6	309	420	07/16	>		S 5235 PE	S 6011 NE	S 7F27 A	S 3165 C
with automatic gearbox and hydraulic retarder ZF 16S / con cambio automatico e rallentatore idraulico ZF 16S	D2676 Euro6	309	420	07/16	>					S 2234 Z
with air-conditioner / con climatizzatore	D2676 Euro6	309	420	07/16	>					S 4177 CA
dryer filter / filtro essiccatore	D2676 Euro6	309	420	07/16	>					S 7A66 A
retarder R3500/4100 (TipMatic 12+2) / freno di rallentamento R3500/4100 (TipMatic 12+2)	D2676 Euro6	309	420	07/16	>					S 5613 PO
inner / interno	D2676 Euro6	309	420	07/16	>				S 7F28 A	
prefilter / prefiltro	D2676 Euro6	309	420	07/16	>			S 4035 NR		
prefilter 300 Micron / prefiltro 300 Micron	D2676 Euro6	309	420	07/16	>			S 6088 NE		
power steering / servosterzo	D2676 Euro6	309	420	07/16	>					S 3081 PO
power steering ZF Servocom RAS-EC / servosterzo ZF Servocom RAS-EC	D2676 Euro6	309	420	07/16	>					S 5664 PO

M



...MAN - trucks/autocarri



Vehicles for building site / veicoli da cantiere	D2676 Euro6	309	420	07/16	>			S 7F29 A	
TXG 35.460	D2676 Euro6	338	460	07/16	>	S 5235 PE	S 6011 NE	S 7F27 A	S 3165 C
with automatic gearbox and hydraulic retarder ZF 16S / con cambio automatico e rallentatore idraulico ZF 16S	D2676 Euro6	338	460	07/16	>				S 2234 Z
with air-conditioner / con climatizzatore	D2676 Euro6	338	460	07/16	>				S 4177 CA
dryer filter / filtro essiccatore	D2676 Euro6	338	460	07/16	>				S 7A66 A
retarder R3500/4100 (TipMatic 12+2) / freno di rallentamento R3500/4100 (TipMatic 12+2)	D2676 Euro6	338	460	07/16	>				S 5613 PO
inner / interno	D2676 Euro6	338	460	07/16	>			S 7F28 A	
prefilter / prefiltra	D2676 Euro6	338	460	07/16	>		S 4035 NR		
prefilter 300 Micron / prefiltra 300 Micron	D2676 Euro6	338	460	07/16	>		S 6088 NE		
power steering / servosterzo	D2676 Euro6	338	460	07/16	>				S 3081 PO
power steering ZF Servocom RAS-EC / servosterzo ZF Servocom RAS-EC	D2676 Euro6	338	460	07/16	>				S 5664 PO
Vehicles for building site / veicoli da cantiere	D2676 Euro6	338	460	07/16	>			S 7F29 A	
TXG 35.500	D2676 Euro6	368	500	07/16	>	S 5235 PE	S 6011 NE	S 7F27 A	S 3165 C
with automatic gearbox and hydraulic retarder ZF 16S / con cambio automatico e rallentatore idraulico ZF 16S	D2676 Euro6	368	500	07/16	>				S 2234 Z
with air-conditioner / con climatizzatore	D2676 Euro6	368	500	07/16	>				S 4177 CA
dryer filter / filtro essiccatore	D2676 Euro6	368	500	07/16	>				S 7A66 A
retarder R3500/4100 (TipMatic 12+2) / freno di rallentamento R3500/4100 (TipMatic 12+2)	D2676 Euro6	368	500	07/16	>				S 5613 PO
inner / interno	D2676 Euro6	368	500	07/16	>			S 7F28 A	
prefilter / prefiltra	D2676 Euro6	368	500	07/16	>		S 4035 NR		
prefilter 300 Micron / prefiltra 300 Micron	D2676 Euro6	368	500	07/16	>		S 6088 NE		
power steering / servosterzo	D2676 Euro6	368	500	07/16	>				S 3081 PO
power steering ZF Servocom RAS-EC / servosterzo ZF Servocom RAS-EC	D2676 Euro6	368	500	07/16	>				S 5664 PO
Vehicles for building site / veicoli da cantiere	D2676 Euro6	368	500	07/16	>			S 7F29 A	
TXG 35.520 D38	D3876	382	519	08/14	>	S 5239 PE	S 6150 NE	S 7619 A	S 3165 C
with air-conditioner / con climatizzatore	D3876	382	519	08/14	>				S 4177 CA
dryer filter / filtro essiccatore	D3876	382	519	08/14	>				S 7A66 A
inner / interno	D3876	382	519	08/14	>			S 7616 A	
prefilter / prefiltra	D3876	382	519	08/14	>		S 4035 NR		
power steering / servosterzo	D3876	382	519	08/14	>				S 3081 PO
TXG 35.540 D38	D3876 Euro6	397	540	07/16	>	S 5239 PE	S 6150 NE	S 7F27 A	S 3165 C
with automatic gearbox and hydraulic retarder ZF 16S / con cambio automatico e rallentatore idraulico ZF 16S	D3876 Euro6	397	540	07/16	>				S 2234 Z
with air-conditioner / con climatizzatore	D3876 Euro6	397	540	07/16	>				S 4177 CA
dryer filter / filtro essiccatore	D3876 Euro6	397	540	07/16	>				S 7A66 A
retarder R3500/4100 (TipMatic 12+2) / freno di rallentamento R3500/4100 (TipMatic 12+2)	D3876 Euro6	397	540	07/16	>				S 5613 PO
inner / interno	D3876 Euro6	397	540	07/16	>			S 7F28 A	
prefilter / prefiltra	D3876 Euro6	397	540	07/16	>		S 4035 NR		
prefilter 300 Micron / prefiltra 300 Micron	D3876 Euro6	397	540	07/16	>		S 6088 NE		
power steering / servosterzo	D3876 Euro6	397	540	07/16	>				S 3081 PO
power steering ZF Servocom RAS-EC / servosterzo ZF Servocom RAS-EC	D3876 Euro6	397	540	07/16	>				S 5664 PO
Vehicles for building site / veicoli da cantiere	D3876 Euro6	397	540	07/16	>			S 7F29 A	
TXG 35.560 D38	D3876	412	560	08/14	>	S 5239 PE	S 6150 NE	S 7619 A	S 3165 C
with air-conditioner / con climatizzatore	D3876	412	560	08/14	>				S 4177 CA
dryer filter / filtro essiccatore	D3876	412	560	08/14	>				S 7A66 A
inner / interno	D3876	412	560	08/14	>			S 7616 A	
prefilter / prefiltra	D3876	412	560	08/14	>		S 4035 NR		
power steering / servosterzo	D3876	412	560	08/14	>				S 3081 PO
TXG 35.580 D38	D3876 Euro6	427	580	07/16	>	S 5239 PE	S 6150 NE	S 7F27 A	S 3165 C
with automatic gearbox and hydraulic retarder ZF 16S / con cambio automatico e rallentatore idraulico ZF 16S	D3876 Euro6	427	580	07/16	>				S 2234 Z
with air-conditioner / con climatizzatore	D3876 Euro6	427	580	07/16	>				S 4177 CA
dryer filter / filtro essiccatore	D3876 Euro6	427	580	07/16	>				S 7A66 A
retarder R3500/4100 (TipMatic 12+2) / freno di rallentamento R3500/4100 (TipMatic 12+2)	D3876 Euro6	427	580	07/16	>				S 5613 PO
inner / interno	D3876 Euro6	427	580	07/16	>			S 7F28 A	
prefilter / prefiltra	D3876 Euro6	427	580	07/16	>		S 4035 NR		
prefilter 300 Micron / prefiltra 300 Micron	D3876 Euro6	427	580	07/16	>		S 6088 NE		
power steering / servosterzo	D3876 Euro6	427	580	07/16	>				S 3081 PO
power steering ZF Servocom RAS-EC / servosterzo ZF Servocom RAS-EC	D3876 Euro6	427	580	07/16	>				S 5664 PO
Vehicles for building site / veicoli da cantiere	D3876 Euro6	427	580	07/16	>			S 7F29 A	
TXG 35.640 D38	D3876 Euro6	471	640	08/14	>	S 5239 PE	S 6150 NE	S 7619 A	S 3165 C
	D3876 Euro6	471	640	07/16	>	S 5239 PE	S 6150 NE	S 7F27 A	S 3165 C
with automatic gearbox and hydraulic retarder ZF 16S / con cambio automatico e rallentatore idraulico ZF 16S	D3876 Euro6	471	640	08/14	>				S 2234 Z
with air-conditioner / con climatizzatore	D3876 Euro6	471	640	08/14	>				S 4177 CA
dryer filter / filtro essiccatore	D3876 Euro6	471	640	08/14	>				S 7A66 A
retarder R3500/4100 (TipMatic 12+2) / freno di rallentamento R3500/4100 (TipMatic 12+2)	D3876 Euro6	471	640	07/16	>				S 5613 PO
inner / interno	D3876 Euro6	471	640	08/14	>			S 7616 A	
inner / interno	D3876 Euro6	471	640	07/16	>			S 7F28 A	
prefilter / prefiltra	D3876 Euro6	471	640	08/14	>		S 4035 NR		
prefilter 300 Micron / prefiltra 300 Micron	D3876 Euro6	471	640	08/14	>		S 6088 NE		

**kW HP**

...MAN - trucks/autocarri

power steering / servosterzo	D3876 Euro6	471	640	08/14	>				S 3081 PO
power steering ZF Servocom RAS-EC / servosterzo ZF Servocom RAS-EC	D3876 Euro6	471	640	07/16	>				S 5664 PO
Vehicles for building site / veicoli da cantiere	D3876 Euro6	471	640	08/14	>	06/16		S 7E35 A	
Vehicles for building site / veicoli da cantiere	D3876 Euro6	471	640	07/16	>			S 7F29 A	
TXG 41.460	D2676 Euro6	338	460	07/16	>		S 5235 PE	S 6011 NE	S 7F27 A
with automatic gearbox and hydraulic retarder ZF 16S / con cambio automatico e rallentatore idraulico ZF 16S	D2676 Euro6	338	460	07/16	>				S 3165 C
with air-conditioner / con climatizzatore	D2676 Euro6	338	460	07/16	>				S 2234 Z
dryer filter / filtro essiccatore	D2676 Euro6	338	460	07/16	>				S 4177 CA
retarder R3500/4100 (TipMatic 12+2) / freno di rallentamento R3500/4100 (TipMatic 12+2)	D2676 Euro6	338	460	07/16	>				S 7A66 A
inner / interno	D2676 Euro6	338	460	07/16	>			S 7F28 A	S 5613 PO
prefilter / prefiltra	D2676 Euro6	338	460	07/16	>			S 4035 NR	
prefilter 300 Micron / prefiltra 300 Micron	D2676 Euro6	338	460	07/16	>			S 6088 NE	
power steering / servosterzo	D2676 Euro6	338	460	07/16	>				S 3081 PO
power steering ZF Servocom RAS-EC / servosterzo ZF Servocom RAS-EC	D2676 Euro6	338	460	07/16	>				S 5664 PO
Vehicles for building site / veicoli da cantiere	D2676 Euro6	338	460	07/16	>			S 7F29 A	
TXG 41.480	D2676 Euro4/5/EEV	353	480	10/07	>		S 5046 PE	S 6011 NE	S 7619 A
with air-conditioner / con climatizzatore	D2676 Euro4/5/EEV	353	480	10/07	>				S 3165 C
inner / interno	D2676 Euro4/5/EEV	353	480	10/07	>			S 7616 A	S 4177 CA
prefilter with fuel oil heater / prefiltra con riscaldatore nafta	D2676 Euro4/5/EEV	353	480	10/07	>			S 6059 NE	
prefilter without fuel oil heater / prefiltra senza riscaldatore nafta	D2676 Euro4/5/EEV	353	480	10/07	>			S 6062 NE	
power steering / servosterzo	D2676 Euro4/5/EEV	353	480	10/07	>				S 3081 PO
TXG 41.500	D2676 Euro6	368	500	07/16	>		S 5235 PE	S 6011 NE	S 7F27 A
with automatic gearbox and hydraulic retarder ZF 16S / con cambio automatico e rallentatore idraulico ZF 16S	D2676 Euro6	368	500	07/16	>				S 3165 C
with air-conditioner / con climatizzatore	D2676 Euro6	368	500	07/16	>				S 2234 Z
dryer filter / filtro essiccatore	D2676 Euro6	368	500	07/16	>				S 4177 CA
retarder R3500/4100 (TipMatic 12+2) / freno di rallentamento R3500/4100 (TipMatic 12+2)	D2676 Euro6	368	500	07/16	>				S 7A66 A
inner / interno	D2676 Euro6	368	500	07/16	>			S 7F28 A	S 5613 PO
prefilter / prefiltra	D2676 Euro6	368	500	07/16	>			S 4035 NR	
prefilter 300 Micron / prefiltra 300 Micron	D2676 Euro6	368	500	07/16	>			S 6088 NE	
power steering / servosterzo	D2676 Euro6	368	500	07/16	>				S 3081 PO
power steering ZF Servocom RAS-EC / servosterzo ZF Servocom RAS-EC	D2676 Euro6	368	500	07/16	>				S 5664 PO
Vehicles for building site / veicoli da cantiere	D2676 Euro6	368	500	07/16	>			S 7F29 A	
TXG 41.520 D38	D3876	382	519	08/14	>		S 5239 PE	S 6150 NE	S 7619 A
with air-conditioner / con climatizzatore	D3876	382	519	08/14	>				S 3165 C
dryer filter / filtro essiccatore	D3876	382	519	08/14	>				S 4177 CA
inner / interno	D3876	382	519	08/14	>			S 7616 A	S 7A66 A
prefilter / prefiltra	D3876	382	519	08/14	>			S 4035 NR	
power steering / servosterzo	D3876	382	519	08/14	>				S 3081 PO
TXG 41.540	D2676 Euro4/5/EEV	397	540	10/07	>	07/16	S 5046 PE	S 6011 NE	S 7619 A
with air-conditioner / con climatizzatore	D2676 Euro4/5/EEV	397	540	10/07	>	07/16			S 3165 C
inner / interno	D2676 Euro4/5/EEV	397	540	10/07	>	07/16		S 7616 A	S 4177 CA
prefilter with fuel oil heater / prefiltra con riscaldatore nafta	D2676 Euro4/5/EEV	397	540	10/07	>	07/16		S 6059 NE	
prefilter without fuel oil heater / prefiltra senza riscaldatore nafta	D2676 Euro4/5/EEV	397	540	10/07	>	07/16		S 6062 NE	
power steering / servosterzo	D2676 Euro4/5/EEV	397	540	10/07	>	07/16			S 3081 PO
TXG 41.540 D38	D3876 Euro6	397	540	07/16	>		S 5239 PE	S 6150 NE	S 7F27 A
with automatic gearbox and hydraulic retarder ZF 16S / con cambio automatico e rallentatore idraulico ZF 16S	D3876 Euro6	397	540	07/16	>				S 3165 C
with air-conditioner / con climatizzatore	D3876 Euro6	397	540	07/16	>				S 2234 Z
dryer filter / filtro essiccatore	D3876 Euro6	397	540	07/16	>				S 4177 CA
retarder R3500/4100 (TipMatic 12+2) / freno di rallentamento R3500/4100 (TipMatic 12+2)	D3876 Euro6	397	540	07/16	>				S 7A66 A
inner / interno	D3876 Euro6	397	540	07/16	>			S 7F28 A	S 5613 PO
prefilter / prefiltra	D3876 Euro6	397	540	07/16	>			S 4035 NR	
prefilter 300 Micron / prefiltra 300 Micron	D3876 Euro6	397	540	07/16	>			S 6088 NE	
power steering / servosterzo	D3876 Euro6	397	540	07/16	>				S 3081 PO
power steering ZF Servocom RAS-EC / servosterzo ZF Servocom RAS-EC	D3876 Euro6	397	540	07/16	>				S 5664 PO
Vehicles for building site / veicoli da cantiere	D3876 Euro6	397	540	07/16	>			S 7F29 A	
TXG 41.560 D38	D3876	412	560	08/14	>		S 5239 PE	S 6150 NE	S 7619 A
with air-conditioner / con climatizzatore	D3876	412	560	08/14	>				S 3165 C
dryer filter / filtro essiccatore	D3876	412	560	08/14	>				S 4177 CA
inner / interno	D3876	412	560	08/14	>			S 7616 A	S 7A66 A
prefilter / prefiltra	D3876	412	560	08/14	>			S 4035 NR	
power steering / servosterzo	D3876	412	560	08/14	>				S 3081 PO
TXG 41.580 D38	D3876 Euro6	427	580	07/16	>		S 5239 PE	S 6150 NE	S 7F27 A
with automatic gearbox and hydraulic retarder ZF 16S / con cambio automatico e rallentatore idraulico ZF 16S	D3876 Euro6	427	580	07/16	>				S 3165 C
with air-conditioner / con climatizzatore	D3876 Euro6	427	580	07/16	>				S 2234 Z
dryer filter / filtro essiccatore	D3876 Euro6	427	580	07/16	>				S 4177 CA
retarder R3500/4100 (TipMatic 12+2) / freno di rallentamento R3500/4100 (TipMatic 12+2)	D3876 Euro6	427	580	07/16	>				S 7A66 A
inner / interno	D3876 Euro6	427	580	07/16	>			S 7F28 A	S 5613 PO

M



kW HP



...MAN - trucks/autocarri

M



prefilter / prefiltro	D3876 Euro6	427	580	07/16	>		S 4035 NR		
prefilter 300 Micron / prefiltro 300 Micron	D3876 Euro6	427	580	07/16	>		S 6088 NE		
power steering / servosterzo	D3876 Euro6	427	580	07/16	>				S 3081 PO
power steering ZF Servocom RAS-EC / servosterzo ZF Servocom RAS-EC	D3876 Euro6	427	580	07/16	>				S 5664 PO
Vehicles for building site / veicoli da cantiere	D3876 Euro6	427	580	07/16	>			S 7F29 A	
TGX 41.640 D38	D3876 Euro6	471	640	08/14	> 06/16	S 5239 PE	S 6150 NE	S 7619 A	S 3165 C
	D3876 Euro6	471	640	07/16	>	S 5239 PE	S 6150 NE	S 7F27 A	S 3165 C
with automatic gearbox and hydraulic retarder ZF 16S / con cambio automatico e rallentatore idraulico ZF 16S	D3876 Euro6	471	640	08/14	>				S 2234 Z
with air-conditioner / con climatizzatore	D3876 Euro6	471	640	08/14	>				S 4177 CA
dryer filter / filtro essiccatore	D3876 Euro6	471	640	08/14	>				S 7A66 A
retarder R3500/4100 (TipMatic 12+2) / freno di rallentamento R3500/4100 (TipMatic 12+2)	D3876 Euro6	471	640	07/16	>				S 5613 PO
inner / interno	D3876 Euro6	471	640	08/14	> 06/16			S 7616 A	
inner / interno	D3876 Euro6	471	640	07/16	>			S 7F28 A	
prefilter / prefiltro	D3876 Euro6	471	640	08/14	>		S 4035 NR		
prefilter 300 Micron / prefiltro 300 Micron	D3876 Euro6	471	640	08/14	>		S 6088 NE		
power steering / servosterzo	D3876 Euro6	471	640	08/14	>				S 3081 PO
power steering ZF Servocom RAS-EC / servosterzo ZF Servocom RAS-EC	D3876 Euro6	471	640	07/16	>				S 5664 PO
Vehicles for building site / veicoli da cantiere	D3876 Euro6	471	640	08/14	> 06/16			S 7E35 A	
Vehicles for building site / veicoli da cantiere	D3876 Euro6	471	640	07/16	>			S 7F29 A	
TGX 41.680 V8	D2868LF02/03/05	500	680	10/07	> 06/14		S 6011 NE	S 7619 A	S 3165 C
some 2 filters (51.05504.0110) / alcuni N.2 filtri (51.05504.0110)	D2868LF02/03/05	500	680	10/07	> 06/14	S 5147 PE			
with automatic gearbox and hydraulic retarder ZF 16S / con cambio automatico e rallentatore idraulico ZF 16S	D2868LF02/03/05	500	680	10/07	> 06/14				S 2234 Z
with air-conditioner / con climatizzatore	D2868LF02/03/05	500	680	10/07	> 06/14				S 4177 CA
dryer filter / filtro essiccatore	D2868LF02/03/05	500	680	10/07	> 06/14				S 7A66 A
inner / interno	D2868LF02/03/05	500	680	10/07	> 06/14			S 7616 A	
2 filters / N.2 filtri	D2868LF02/03/05	500	680	10/07	> 06/14	S 5046 PE			
prefilter 300 Micron / prefiltro 300 Micron	D2868LF02/03/05	500	680	10/07	> 06/14		S 6088 NE		
prefilter with fuel oil heater / prefiltro con riscaldatore nafta	D2868LF02/03/05	500	680	10/07	> 06/14		S 6059 NE		
prefilter without fuel oil heater / prefiltro senza riscaldatore nafta	D2868LF02/03/05	500	680	10/07	> 06/14		S 6062 NE		
power steering / servosterzo	D2868LF02/03/05	500	680	10/07	> 06/14				S 3081 PO

MAN

buses/autobus

10.210									
10.210	U 11 D						S 1411 N		
11.210 R13									
11.210 R13	U 11 D						S 1411 N		
11M160									
11M160	D 2156					S 0530 PO	S 1411 N	S 7987 A	
power steering / servosterzo	D 2156								S 8790 PO
11UE192-R13									
11UE192-R13	D 2156					S 0530 PO	S 1411 N	S 7987 A	
power steering / servosterzo	D 2156								S 8790 PO
11V160									
11V160	D 2156					S 0530 PO	S 1411 N	S 7987 A	
power steering / servosterzo	D 2156								S 8790 PO
12.210 R15									
12.210 R15	U 11 D						S 1411 N		
12UE192-R14									
12UE192-R14	D 2156					S 0530 PO	S 1411 N	S 7987 A	
power steering / servosterzo	D 2156								S 8790 PO
12V160									
12V160	D 2156					S 0530 PO	S 1411 N	S 7987 A	
power steering / servosterzo	D 2156								S 8790 PO
415 Serie									
415				01/60	>	S 0530 PO	S 7411 N		
420 Serie									
420				01/60	>	S 0530 PO	S 7411 N		
530 Serie									
530						S 0530 PO	S 1411 N		
power steering / servosterzo									S 8790 PO
530	D 0026 M						S 1411 N		
paper / in carta	D 0026 M						S 1411 N		
535 Serie									
535	D 0026 M						S 1411 N		
paper / in carta	D 0026 M						S 1411 N		
535 HO	D 0836 HM 7 H						S 7411 N		
535 HO-R10	D 0836 M 3 H						S 1411 N		



kW HP



...MAN - buses/autobus

535 HO-UE10	D 0836 M 3 H			S 1411 N		
545 Serie						
545	D 0026 M			S 1411 N		
paper / in carta	D 0026 M			S 1411 N		
560 Serie						
560		01/60 >	S 0530 PO	S 7411 N		
560 FOC-1	D 1546 M 4		S 0530 PO	S 7411 N		
640 Serie						
640 HO-1	D 0836 M 2 U			S 7411 N		
750 Serie						
750	D 0836 HM 91 U			S 7411 N	S 5270 A	
750	D 0836 HM 95 U			S 7411 N	S 5270 A	
750	D 2146 HM 5 U		S 0530 PO	S 1411 N	S 5270 A	
some / alcuni	D 2146 HM 5 U		S 0530 PO	S 1411 N	S 7987 A	
power steering / servosterzo	D 2146 HM 5 U					S 8790 PO
750	D 2146 HM 51 U		S 0530 PO	S 1411 N	S 5270 A	
some / alcuni	D 2146 HM 51 U		S 0530 PO	S 1411 N	S 7987 A	
power steering / servosterzo	D 2146 HM 51 U					S 8790 PO
750 HO-M10	D 0836 HM 3 U		S 0530 PO	S 7411 N		
750 HO-M10	D 0846 HM 91 U	01/70 > 04/71		S 7411 N	S 5270 A	
some / alcuni	D 0846 HM 91 U	01/70 > 04/71		S 7411 N	S 7987 A	
power steering / servosterzo	D 0846 HM 91 U	01/70 > 04/71				S 8790 PO
750 HO-M10 A	D 0846 HM 91 U	01/70 > 04/71		S 7411 N	S 5270 A	
some / alcuni	D 0846 HM 91 U	01/70 > 04/71		S 7411 N	S 7987 A	
power steering / servosterzo	D 0846 HM 91 U	01/70 > 04/71				S 8790 PO
750 HO-M11	D 0836 HM 3 U		S 0530 PO	S 7411 N		
750 HO-R10	D 0836 HM 3 U		S 0530 PO	S 7411 N		
750 HO-R11	D 0836 HM 3 U		S 0530 PO	S 7411 N		
750 HO-SL (Standardbus VOEV)	D 0836 HM 9 U			S 7411 N	S 7987 A	
power steering / servosterzo	D 0836 HM 9 U					S 8790 PO
750 HO-SL (Standardbus VOEV)	D 0836 HM 91 U			S 7411 N	S 7987 A	
power steering / servosterzo	D 0836 HM 91 U					S 8790 PO
750 HO-UE11	D 0836 HM 3 U		S 0530 PO	S 7411 N		
750 HO-V11	D 0836 HM 3 U		S 0530 PO	S 7411 N		
760 Serie						
760		01/60 >	S 0530 PO	S 7411 N		
760	D 0836 HM 91 U			S 7411 N	S 5270 A	
760	D 0836 HM 95 U			S 7411 N	S 5270 A	
760	D 1546 M 4		S 0530 PO	S 7411 N		
760 UO	D 1546 M1U			S 7411 N		
890 Serie						
890			S 0530 PO	S 1411 N		S 8790 PO
power steering / servosterzo						
890	D 2146 HM 5 U		S 0530 PO	S 1411 N	S 5270 A	
some / alcuni	D 2146 HM 5 U		S 0530 PO	S 1411 N	S 7987 A	
power steering / servosterzo	D 2146 HM 5 U					S 8790 PO
890	D 2146 HM 51 U		S 0530 PO	S 1411 N	S 5270 A	
some / alcuni	D 2146 HM 51 U		S 0530 PO	S 1411 N	S 7987 A	
power steering / servosterzo	D 2146 HM 51 U					S 8790 PO
Alé Minibus						
Alé Minibus	D 0834 LOH 01	09/00 >	S 3292 R	S 4378 NR	S 2450 A	
dryer filter / filtro essiccatore	D 0834 LOH 01	09/00 >				S 7259 A
EL Serie						
EL 202	D 0826 LUH 03/05/12	01/89 > 06/97	S 3292 R	S 1378 NR	S 7187 A	S 3439 C
2nd passage / 2.passaggio	D 0826 LUH 03/05/12	01/89 > 06/97		S 4378 NR		
some / alcuni	D 0826 LUH 03/05/12	01/89 > 06/97	S 3292 R	S 1378 NR	S 2650 A	
with automatic gearbox VOITH D851.3, D854.3, D863.3 / con cambio automatico VOITH D851.3, D854.3, D863.3	D 0826 LUH 03/05/12	01/89 > 06/97				S 6449 PO
dryer filter / filtro essiccatore	D 0826 LUH 03/05/12	01/89 > 06/97				S 7259 A
prefilter SEPAR 2000 / prefilto SEPAR 2000	D 0826 LUH 03/05/12	01/89 > 06/97		S 6063 NE		
power steering / servosterzo	D 0826 LUH 03/05/12	01/89 > 06/97				S 8790 PO
EL 202 F	D 0826 LUH 03/05/12	01/89 > 06/97	S 3292 R	S 1378 NR	S 7187 A	S 3439 C
2nd passage / 2.passaggio	D 0826 LUH 03/05/12	01/89 > 06/97		S 4378 NR		
some / alcuni	D 0826 LUH 03/05/12	01/89 > 06/97	S 3292 R	S 1378 NR	S 2650 A	
with automatic gearbox VOITH D851.3, D854.3, D863.3 / con cambio automatico VOITH D851.3, D854.3, D863.3	D 0826 LUH 03/05/12	01/89 > 06/97				S 6449 PO
dryer filter / filtro essiccatore	D 0826 LUH 03/05/12	01/89 > 06/97				S 7259 A
prefilter SEPAR 2000 / prefilto SEPAR 2000	D 0826 LUH 03/05/12	01/89 > 06/97		S 6063 NE		
power steering / servosterzo	D 0826 LUH 03/05/12	01/89 > 06/97				S 8790 PO

M



**KW HP****...MAN - buses/autobus**

EL 222	D 0826 LUH 12 162 220 11/95 >	S 3292 R	S 1378 NR		
2nd passage / 2.passaggio	D 0826 LUH 12 162 220 11/95 >		S 4378 NR		
with automatic gearbox VOITH D851.3, D854.3, D863.3 / con cambio automatico VOITH D851.3, D854.3, D863.3	D 0826 LUH 12 162 220 11/95 >				S 6449 PO
dryer filter / filtro essiccatore	D 0826 LUH 12 162 220 11/95 >				S 7259 A
prefilter SEPAR 2000 / prefiltrato SEPAR 2000	D 0826 LUH 12 162 220 11/95 >		S 6063 NE		
EL 222 F	D 0826 LUH 12 162 220 05/97 >	S 3292 R	S 1378 NR		S 3439 C
2nd passage / 2.passaggio	D 0826 LUH 12 162 220 05/97 >		S 4378 NR		
with automatic gearbox VOITH D851.3, D854.3, D863.3 / con cambio automatico VOITH D851.3, D854.3, D863.3	D 0826 LUH 12 162 220 05/97 >				S 6449 PO
dryer filter / filtro essiccatore	D 0826 LUH 12 162 220 05/97 >				S 7259 A
	D 0826 LUH 12 162 220 05/97 >				S 3439 C
EL 223	D 0836 LOH 162 220 09/04 >				S 3439 C
EL 262	D 0826 LUH 13 191 260 01/96 >	S 3292 R	S 4378 NR		S 3439 C
with automatic gearbox VOITH D851.3, D854.3, D863.3 / con cambio automatico VOITH D851.3, D854.3, D863.3	D 0826 LUH 13 191 260 01/96 >				S 6449 PO
dryer filter / filtro essiccatore	D 0826 LUH 13 191 260 01/96 >				S 7259 A
prefilter SEPAR 2000 / prefiltrato SEPAR 2000	D 0826 LUH 13 191 260 01/96 >		S 6063 NE		
EL 262 F	D 0826 LUH 13 191 260 06/97 >	S 3292 R	S 4378 NR		S 3439 C
with automatic gearbox VOITH D851.3, D854.3, D863.3 / con cambio automatico VOITH D851.3, D854.3, D863.3	D 0826 LUH 13 191 260 06/97 >				S 6449 PO
dryer filter / filtro essiccatore	D 0826 LUH 13 191 260 06/97 >				S 7259 A
prefilter SEPAR 2000 / prefiltrato SEPAR 2000	D 0826 LUH 13 191 260 06/97 >		S 6063 NE		
EL 263 EEV	D 0836 LOH 63 191 260 09/07 >	S 3292 R	S 6011 NE		S 3439 C
additional EBERSPAECHER / WEBASTO / addizionale EBERSPAECHER / WEBASTO	D 0836 LOH 63 191 260 09/07 >		S 4378 NR		
with automatic gearbox VOITH D851.3, D854.3, D863.3 / con cambio automatico VOITH D851.3, D854.3, D863.3	D 0836 LOH 63 191 260 09/07 >				S 6449 PO
prefilter SEPAR 2000 / prefiltrato SEPAR 2000	D 0836 LOH 63 191 260 09/07 >		S 6063 NE		
power steering / servosterzo	D 0836 LOH 63 191 260 09/07 >				S 3081 PO
EL 283	D 0836 LOH 40 206 280 09/09 >				S 3439 C
EL 283 D20	D 2066 LUH EEV Euro6 206 280 09/09 >	S 5046 PE	S 6011 NE	S 7A11 A	S 3439 C
with automatic gearbox VOITH D851.3, D854.3, D863.3 / con cambio automatico VOITH D851.3, D854.3, D863.3	D 2066 LUH EEV Euro6 206 280 09/09 >				S 6449 PO
with automatic gearbox VOITH D864.3E / con cambio automatico VOITH D864.3E	D 2066 LUH EEV Euro6 206 280 09/09 >				S 5663 PO
inner / interno	D 2066 LUH EEV Euro6 206 280 09/09 >			S 7649 A	
prefilter / prefiltrato	D 2066 LUH EEV Euro6 206 280 09/09 >		S 6088 NE		
power steering / servosterzo	D 2066 LUH EEV Euro6 206 280 09/09 >				S 3081 PO
EL 293	D 0836 LOH 60 EEV Euro6 213 290 09/08 >				S 3439 C
EL 313	D 2066 LUH EEV Euro6 235 320 09/09 >	S 5046 PE	S 6011 NE	S 7A11 A	S 3439 C
with automatic gearbox VOITH D851.3, D854.3, D863.3 / con cambio automatico VOITH D851.3, D854.3, D863.3	D 2066 LUH EEV Euro6 235 320 09/09 >				S 6449 PO
with automatic gearbox VOITH D864.3E / con cambio automatico VOITH D864.3E	D 2066 LUH EEV Euro6 235 320 09/09 >				S 5663 PO
inner / interno	D 2066 LUH EEV Euro6 235 320 09/09 >			S 7649 A	
prefilter / prefiltrato	D 2066 LUH EEV Euro6 235 320 09/09 >		S 6088 NE		
power steering / servosterzo	D 2066 LUH EEV Euro6 235 320 09/09 >				S 3081 PO
EL 363	D 2066 LUH EEV Euro6 265 360 09/09 >	S 5046 PE	S 6011 NE	S 7A11 A	S 3439 C
with automatic gearbox VOITH D851.3, D854.3, D863.3 / con cambio automatico VOITH D851.3, D854.3, D863.3	D 2066 LUH EEV Euro6 265 360 09/09 >				S 6449 PO
with automatic gearbox VOITH D864.3E / con cambio automatico VOITH D864.3E	D 2066 LUH EEV Euro6 265 360 09/09 >				S 5663 PO
inner / interno	D 2066 LUH EEV Euro6 265 360 09/09 >			S 7649 A	
prefilter / prefiltrato	D 2066 LUH EEV Euro6 265 360 09/09 >		S 6088 NE		
power steering / servosterzo	D 2066 LUH EEV Euro6 265 360 09/09 >				S 3081 PO
EM Serie					
EM 11.222	D 0826 LOH, D 0286 LUH 02/96 >	S 3292 R	S 1378 NR		
2nd passage / 2.passaggio	D 0826 LOH, D 0286 LUH 02/96 >		S 4378 NR		
dryer filter / filtro essiccatore	D 0826 LOH, D 0286 LUH 02/96 >				S 7259 A
EM 13.222	D 0826 LOH, D 0286 LUH 02/96 >	S 3292 R	S 1378 NR		
2nd passage / 2.passaggio	D 0826 LOH, D 0286 LUH 02/96 >		S 4378 NR		
dryer filter / filtro essiccatore	D 0826 LOH, D 0286 LUH 02/96 >				S 7259 A
EM 192 Europa Midi	D 0826 LOH 06 10/93 > 06/97	S 3292 R	S 1378 NR	S 2650 A	S 3439 C
2nd passage / 2.passaggio	D 0826 LOH 06 10/93 > 06/97		S 4378 NR		
dryer filter / filtro essiccatore	D 0826 LOH 06 10/93 > 06/97				S 7259 A
EM 222	D 0826 LOH, D 0286 LUH 02/96 >	S 3292 R	S 1378 NR		S 3439 C
2nd passage / 2.passaggio	D 0826 LOH, D 0286 LUH 02/96 >		S 4378 NR		
dryer filter / filtro essiccatore	D 0826 LOH, D 0286 LUH 02/96 >				S 7259 A
EM 223	D 0826 LOH, D 0826 LUH 02/96 >	S 3292 R	S 1378 NR		S 3439 C
2nd passage / 2.passaggio	D 0826 LOH, D 0826 LUH 02/96 >		S 4378 NR		
dryer filter / filtro essiccatore	D 0826 LOH, D 0826 LUH 02/96 >				S 7259 A
F Serie					
292 F	D 2866 TUH 290 03/86 > 04/94	S 7260 PO	S 1411 N	S 1050 A	
dryer filter / filtro essiccatore	D 2866 TUH 290 03/86 > 04/94				S 7259 A
292 FH	D 2866 TUH 290 03/86 > 04/94	S 7260 PO	S 1411 N	S 1050 A	
dryer filter / filtro essiccatore	D 2866 TUH 290 03/86 > 04/94				S 7259 A
332 F	D 2866 LUH 330 09/85 > 04/94	S 7260 PO	S 1411 N	S 1050 A	
dryer filter / filtro essiccatore	D 2866 LUH 330 09/85 > 04/94				S 7259 A
332 HF	D 2866 LUH 330 09/85 > 04/94	S 7260 PO	S 1411 N	S 1050 A	



KW HP



...MAN - buses/autobus

dryer filter / filtro essiccatore	D 2866 LUH 330	09/85 > 04/94				S 7259 A
362 F	D 2866 KUH 360	09/85 > 04/94	S 7260 PO	S 1411 N	S 1050 A	
dryer filter / filtro essiccatore	D 2866 KUH 360	09/85 > 04/94				S 7259 A
362 HF	D 2866 KUH 360	09/85 > 04/94	S 7260 PO	S 1411 N	S 1050 A	
dryer filter / filtro essiccatore	D 2866 KUH 360	09/85 > 04/94				S 7259 A
FOC Bus chassis						
8.150 (G90)	D 0826 GF 01/03	07/88 > 10/93	S 3292 R	S 1378 NR	S 2450 A	
2nd passage / 2.passaggio	D 0826 GF 01/03	07/88 > 10/93		S 4378 NR		
8.170	D 0226 MCFO 170	09/85 > 10/93	S 5536 PO	S 4378 NR	S 2650 A	
prefilter / prefiltrato	D 0226 MCFO 170	09/85 > 10/93		S 4323 NR		
9.150	D 0826 GF 01/03	07/88 > 10/93	S 3292 R	S 1378 NR	S 2450 A	
2nd passage / 2.passaggio	D 0826 GF 01/03	07/88 > 10/93		S 4378 NR		
9.170	D 0226 MCFO 170	09/85 > 10/93	S 5536 PO	S 4378 NR	S 2650 A	
prefilter / prefiltrato	D 0226 MCFO 170	09/85 > 10/93		S 4323 NR		
FR Serie						
FR 292	D 2866 TOH 310	04/92 > 12/94	S 7260 PO	S 1411 N	S 1050 A	
spin-on / avvitabile	D 2866 TOH 310	04/92 > 12/94	S 7260 PO	S 4378 NR	S 1050 A	
dryer filter / filtro essiccatore	D 2866 TOH 310	04/92 > 12/94				S 7259 A
FR 292	D 2866 TUH 290	03/86 > 04/92	S 7260 PO	S 1411 N	S 1050 A	
spin-on / avvitabile	D 2866 TUH 290	03/86 > 04/92	S 7260 PO	S 4378 NR	S 1050 A	
dryer filter / filtro essiccatore	D 2866 TUH 290	03/86 > 04/92				S 7259 A
FRH Serie						
292	D 2866 TOH 310	03/91 > 12/94	S 7260 PO	S 1411 N	S 1050 A	
spin-on / avvitabile	D 2866 TOH 310	03/91 > 12/94	S 7260 PO	S 4378 NR	S 1050 A	
dryer filter / filtro essiccatore	D 2866 TOH 310	03/91 > 12/94				S 7259 A
292	D 2866 TUH 290	05/85 > 03/91	S 7260 PO	S 1411 N	S 1050 A	
spin-on / avvitabile	D 2866 TUH 290	05/85 > 03/91	S 7260 PO	S 4378 NR	S 1050 A	
dryer filter / filtro essiccatore	D 2866 TUH 290	05/85 > 03/91				S 7259 A
352 Lion's Star	D 2866 LOH 26	09/95 >	S 7260 PO	S 1411 N		
spin-on / avvitabile	D 2866 LOH 26	09/95 >	S 7260 PO	S 4378 NR		
dryer filter / filtro essiccatore	D 2866 LOH 26	09/95 >				S 7259 A
362	D 2866 KUH 360	05/85 > 12/92	S 7260 PO	S 1411 N	S 1050 A	
spin-on / avvitabile	D 2866 KUH 360	05/85 > 12/92	S 7260 PO	S 4378 NR	S 1050 A	
dryer filter / filtro essiccatore	D 2866 KUH 360	05/85 > 12/92				S 7259 A
402 F Lion's Star	D 2866 LOH 23	07/98 >	S 7260 PO	S 4378 NR		
dryer filter / filtro essiccatore	D 2866 LOH 23	07/98 >				S 7259 A
402 F Lion's Star	D 2866 LOH 26	07/98 >	S 7260 PO	S 4378 NR		
dryer filter / filtro essiccatore	D 2866 LOH 26	07/98 >				S 7259 A
402 Lion's Star	D 2866 LOH 23	09/95 >	S 7260 PO	S 4378 NR	S 1050 A	
dryer filter / filtro essiccatore	D 2866 LOH 23	09/95 >				S 7259 A
402 Lion's Star	D 2866 LOH 26	09/95 >	S 7260 PO	S 4378 NR	S 1050 A	
dryer filter / filtro essiccatore	D 2866 LOH 26	09/95 >				S 7259 A
402 Lion's Top Coach	D 2866 LOH 23	09/95 >	S 7260 PO	S 4378 NR	S 1050 A	
dryer filter / filtro essiccatore	D 2866 LOH 23	09/95 >				S 7259 A
422 Lion's Star	D 2866 LOH 20	01/93 > 09/96	S 7260 PO	S 4378 NR		
dryer filter / filtro essiccatore	D 2866 LOH 20	01/93 > 09/96				S 7259 A
power steering / servosterzo	D 2866 LOH 20	01/93 > 09/96				S 3081 PO
422 Lion's Star	D 2866 LOH 21	01/93 > 09/96	S 7260 PO	S 4378 NR		
dryer filter / filtro essiccatore	D 2866 LOH 21	01/93 > 09/96				S 7259 A
462 Lion's Star	D 2876 LOH 23	09/98 >	S 5016 PE	S 4378 NR		
dryer filter / filtro essiccatore	D 2876 LOH 23	09/98 >				S 7259 A
462 Lion's Top Coach	D 2876 LOH 23	09/98 >	S 5016 PE	S 4378 NR	S 1050 A	
dryer filter / filtro essiccatore	D 2876 LOH 23	09/98 >				S 7259 A
G Serie						
9.135	D 0836 HM 91 U			S 7411 N	S 5270 A	
9.135	D 0836 HM 95 U			S 7411 N	S 5270 A	
HOCL Bus chassis						
10.150	D 0826 OH	01/88 >	S 3292 R	S 4378 NR	S 2450 A	
10.180	D 0826 TOH	01/88 >	S 3292 R	S 4378 NR		
some / alcuni	D 0826 TOH	01/88 >	S 3292 R	S 4378 NR	S 2650 A	
14.280	D 0836 LOH02	09/01 >	S 3292 R	S 4378 NR	S 7187 A	
with automatic gearbox ZF HP500/590 / con cambio automatico ZF HP500/590	D 0836 LOH02	09/01 >				S 2234 Z
dryer filter / filtro essiccatore	D 0836 LOH02	09/00 >				S 7259 A
18.310 HOCL-N	E 2876 LUH 02 228 310	09/03 >	S 5016 PE		S 7651 A	
with automatic gearbox ZF HP500 / con cambio automatico ZF HP500	E 2876 LUH 02 228 310	09/03 >				S 2234 Z
dryer filter / filtro essiccatore	E 2876 LUH 02 228 310	09/03 >				S 7259 A
power steering / servosterzo	E 2876 LUH 02 228 310	09/03 >				S 3081 PO

M





kW HP



...MAN - buses/autobus

M

18.460 (A51)	D 2876 LOH	09/00 >	S 5016 PE	S 4378 NR	S 1050 A		
dryer filter / filtro essiccatore	D 2876 LOH	09/00 >				S 7259 A	
24.440 HOCL-N (R37)	D 2066 LOH Euro4 324 440	07/06 >	S 5046 PE	S 6011 NE	S 7644 A	✗	
dryer filter / filtro essiccatore	D 2066 LOH Euro4 324 440	07/06 >				S 7A66 A	
inner / interno	D 2066 LOH Euro4 324 440	07/06 >			S 7646 A		
prefilter / prefiltrato	D 2066 LOH Euro4 324 440	07/06 >		S 6088 NE			
power steering / servosterzo	D 2066 LOH Euro4 324 440	07/06 >				S 3081 PO	
24.460 (A54)	D 2876 LOH	09/00 >	S 5016 PE	S 4378 NR	S 1050 A		
dryer filter / filtro essiccatore	D 2876 LOH	09/00 >				S 7259 A	
Midi Beta 11.190	D 0826 LOH 06	03/93 > 09/95	S 3292 R	S 4378 NR	S 2650 A		
dryer filter / filtro essiccatore	D 0826 LOH 06	03/93 > 09/95				S 7259 A	
Porto Star 22.370 HOCLN	D 2866 LOH 07	03/93 > 02/95	S 7260 PO	S 4378 NR	S 1050 A		
dryer filter / filtro essiccatore	D 2866 LOH 07	03/93 > 02/95				S 7259 A	
L2000 Serie							
10.150	D 0824 LFO	02/95 > 01/96	S 3292 R	S 1378 NR	S 2450 A		
2nd passage / 2.passaggio	D 0824 LFO	02/95 > 01/96		S 4378 NR			
10.220	D 0826 LFL 03	02/95 >	S 3292 R	S 1378 NR	S 2650 A		
2nd passage / 2.passaggio	D 0826 LFL 03	02/95 >		S 4378 NR			
8.150	D 0824 LFO	02/95 >	S 3292 R	S 1378 NR	S 2650 A		
2nd passage / 2.passaggio	D 0824 LFO	02/95 >		S 4378 NR			
8.220	D 0826 LFL 03	04/95 >	S 3292 R	S 1378 NR	S 7187 A		
2nd passage / 2.passaggio	D 0826 LFL 03	04/95 >		S 4378 NR			
Lion's Coach Supreme							
404 (R09)	D2066LOH Euro4 294 400	03/07 >	S 5046 PE	S 6011 NE	S 7644 A		
with air-conditioner Webasto Aerosphere World / con climatizzatore Webasto Aerosphere World	D2066LOH Euro4 294 400	03/07 >				S 3283 C	
dryer filter / filtro essiccatore	D2066LOH Euro4 294 400	03/07 >				S 7A66 A	
inner / interno	D2066LOH Euro4 294 400	03/07 >			S 7646 A		
prefilter / prefiltrato	D2066LOH Euro4 294 400	03/07 >		S 6088 NE			
power steering / servosterzo	D2066LOH Euro4 294 400	03/07 >				S 3081 PO	
444 (R09)	D2066LOH04/6 Euro4 324 440	07/06 >	S 5046 PE	S 6011 NE	S 7644 A	S 3448 C	
with air-conditioner Webasto Aerosphere World / con climatizzatore Webasto Aerosphere World	D2066LOH04/6 Euro4 324 440	07/06 >				S 3283 C	
dryer filter / filtro essiccatore	D2066LOH04/6 Euro4 324 440	07/06 >				S 7A66 A	
inner / interno	D2066LOH04/6 Euro4 324 440	07/06 >			S 7646 A		
prefilter / prefiltrato	D2066LOH04/6 Euro4 324 440	07/06 >		S 6088 NE			
power steering / servosterzo	D2066LOH04/6 Euro4 324 440	07/06 >				S 3081 PO	
444 (R09)	D2676 CR EEV 324 440	09/08 >	S 5046 PE	S 6011 NE	S 7644 A	S 3448 C	
with air-conditioner Webasto Aerosphere World / con climatizzatore Webasto Aerosphere World	D2676 CR EEV 324 440	09/08 >				S 3283 C	
dryer filter / filtro essiccatore	D2676 CR EEV 324 440	09/08 >				S 7A66 A	
inner / interno	D2676 CR EEV 324 440	09/08 >			S 7646 A		
prefilter / prefiltrato	D2676 CR EEV 324 440	09/08 >		S 6088 NE			
power steering / servosterzo	D2676 CR EEV 324 440	09/08 >				S 3081 PO	
464 (R09)	D2676LOH01/6 Euro4 338 460	07/06 >	S 5046 PE	S 6011 NE	S 7644 A	S 3448 C	
with air-conditioner Webasto Aerosphere World / con climatizzatore Webasto Aerosphere World	D2676LOH01/6 Euro4 338 460	07/06 >				S 3283 C	
dryer filter / filtro essiccatore	D2676LOH01/6 Euro4 338 460	07/06 >				S 7A66 A	
inner / interno	D2676LOH01/6 Euro4 338 460	07/06 >			S 7646 A		
prefilter / prefiltrato	D2676LOH01/6 Euro4 338 460	07/06 >		S 6088 NE			
power steering / servosterzo	D2676LOH01/6 Euro4 338 460	07/06 >				S 3081 PO	
484 (R09)	D2676LOH02 Euro4 353 480	09/07 >	S 5046 PE	S 6011 NE	S 7644 A	S 3448 C	
with air-conditioner Webasto Aerosphere World / con climatizzatore Webasto Aerosphere World	D2676LOH02 Euro4 353 480	09/07 >				S 3283 C	
dryer filter / filtro essiccatore	D2676LOH02 Euro4 353 480	09/07 >				S 7A66 A	
inner / interno	D2676LOH02 Euro4 353 480	09/07 >			S 7646 A		
prefilter / prefiltrato	D2676LOH02 Euro4 353 480	09/07 >		S 6088 NE			
power steering / servosterzo	D2676LOH02 Euro4 353 480	09/07 >				S 3081 PO	
Lion's Intercity							
Intercity C R61	D0836LOH Euro6 213 290	03/15 >	S 3292 R	S 6011 NE			
with automatic gearbox and hydraulic retarder ZF 6S1901 / con cambio automatico e rallentatore idraulico ZF 6S1901	D0836LOH Euro6 213 290	03/15 >				S 2234 Z	
with air-conditioner frontbox / con climatizzatore frontbox	D0836LOH Euro6 213 290	03/15 >				S 3165 C	
with air-conditioner KONVEKTA P700 (8 pcs) / con climatizzatore KONVEKTA P700 (8 pezzi)	D0836LOH Euro6 213 290	03/15 >				S 3279 C	
spheros aeroshere world SPHEROS / con climatizzatore sul tetto SPHEROS	D0836LOH Euro6 213 290	03/15 >				S 3457 C	
with activated carbon air-conditioner frontbox / con climatizzatore, ai carboni attivi frontbox	D0836LOH Euro6 213 290	03/15 >				S 4177 CA	
dryer filter / filtro essiccatore	D0836LOH Euro6 213 290	03/15 >				S 7A66 A	
assembly KNECHT-MAHLE / montaggio KNECHT-MAHLE	D0836LOH Euro6 213 290	03/15 >			S 7B01 A		
assembly MANN+HUMMEL / montaggio MANN+HUMMEL	D0836LOH Euro6 213 290	03/15 >			S 7F16 A		
prefilter / prefiltrato	D0836LOH Euro6 213 290	03/15 >		S 6088 NE			
prefilter with fuel oil heater (SEPAR) / prefiltrato con riscaldatore nafta (SEPAR)	D0836LOH Euro6 213 290	03/15 >		S 6059 NE			
prefilter without fuel oil heater (SEPAR) / prefiltrato senza riscaldatore nafta (SEPAR)	D0836LOH Euro6 213 290	03/15 >		S 6062 NE			
power steering / servosterzo	D0836LOH Euro6 213 290	03/15 >				S 3081 PO	

**KW HP**

...MAN - buses/autobus

Intercity C R62	D0836LOH Euro6	213	290	03/15	>	S 3292 R	S 6011 NE		S 2234 Z
with automatic gearbox and hydraulic retarder ZF 6S1901 / con cambio automatico e rallentatore idraulico ZF 6S1901	D0836LOH Euro6	213	290	03/15	>				S 3165 C
with air-conditioner frontbox / con climatizzatore frontbox	D0836LOH Euro6	213	290	03/15	>				S 3279 C
with air-conditioner KONVEKTA P700 (8 pcs) / con climatizzatore KONVEKTA P700 (8 pezzi)	D0836LOH Euro6	213	290	03/15	>				S 3457 C
spheros aeroshere world SPHEROS / con climatizzatore sul tetto SPHEROS	D0836LOH Euro6	213	290	03/15	>				S 4177 CA
with activated carbon air-conditioner frontbox / con climatizzatore, ai carboni attivi frontbox	D0836LOH Euro6	213	290	03/15	>				S 7A66 A
dryer filter / filtro essiccatore	D0836LOH Euro6	213	290	03/15	>				
assembly KNECHT-MAHLE / montaggio KNECHT-MAHLE	D0836LOH Euro6	213	290	03/15	>			S 7B01 A	
assembly MANN+HUMMEL / montaggio MANN+HUMMEL	D0836LOH Euro6	213	290	03/15	>			S 7F16 A	
prefilter / prefiltro	D0836LOH Euro6	213	290	03/15	>		S 6088 NE		
prefilter with fuel oil heater (SEPAR) / prefiltro con riscaldatore nafta (SEPAR)	D0836LOH Euro6	213	290	03/15	>		S 6059 NE		
prefilter without fuel oil heater (SEPAR) / prefiltro senza riscaldatore nafta (SEPAR)	D0836LOH Euro6	213	290	03/15	>		S 6062 NE		
power steering / servosterzo	D0836LOH Euro6	213	290	03/15	>				S 3081 PO
Intercity R60	D0836LOH Euro6	213	290	03/15	>	S 3292 R	S 6011 NE		
with automatic gearbox and hydraulic retarder ZF 6S1901 / con cambio automatico e rallentatore idraulico ZF 6S1901	D0836LOH Euro6	213	290	03/15	>				S 2234 Z
with air-conditioner frontbox / con climatizzatore frontbox	D0836LOH Euro6	213	290	03/15	>				S 3165 C
with air-conditioner KONVEKTA P700 (8 pcs) / con climatizzatore KONVEKTA P700 (8 pezzi)	D0836LOH Euro6	213	290	03/15	>				S 3279 C
spheros aeroshere world SPHEROS / con climatizzatore sul tetto SPHEROS	D0836LOH Euro6	213	290	03/15	>				S 3457 C
with activated carbon air-conditioner frontbox / con climatizzatore, ai carboni attivi frontbox	D0836LOH Euro6	213	290	03/15	>				S 4177 CA
dryer filter / filtro essiccatore	D0836LOH Euro6	213	290	03/15	>				S 7A66 A
assembly KNECHT-MAHLE / montaggio KNECHT-MAHLE	D0836LOH Euro6	213	290	03/15	>			S 7B01 A	
assembly MANN+HUMMEL / montaggio MANN+HUMMEL	D0836LOH Euro6	213	290	03/15	>			S 7F16 A	
prefilter / prefiltro	D0836LOH Euro6	213	290	03/15	>		S 6088 NE		
prefilter with fuel oil heater (SEPAR) / prefiltro con riscaldatore nafta (SEPAR)	D0836LOH Euro6	213	290	03/15	>		S 6059 NE		
prefilter without fuel oil heater (SEPAR) / prefiltro senza riscaldatore nafta (SEPAR)	D0836LOH Euro6	213	290	03/15	>		S 6062 NE		
power steering / servosterzo	D0836LOH Euro6	213	290	03/15	>				S 3081 PO
ND Serie									
ND 313 Lions City DD	D2866LHU24/51	228	310	09/04	> 02/14				S 3439 C
spheros aeroshere world SPHEROS / con climatizzatore sul tetto SPHEROS	D2866LHU24/51	228	310	09/04	> 02/14				S 3457 C
with air-conditioner WEBASTO Aerosphere / con climatizzatore WEBASTO Aerosphere	D2866LHU24/51	228	310	09/04	>	S 7260 PO	S 4378 NR		S 3081 C
power steering / servosterzo	D2866LHU24/51	228	310	09/04	>				S 3081 PO
NG Serie									
NG 232 CNG Lions City G	E2866DUH01/02	170	231	09/95	> 12/99	S 7260 PO		S 7187 A	S 3439 C
	E2866DUH01/02	170	231	09/95	> 12/99			S 7482 A	
with automatic gearbox ZF HP500/590 / con cambio automatico ZF HP500/590	E2866DUH01/02	170	231	09/95	> 12/99				S 2234 Z
spheros aeroshere world / con climatizzatore sul tetto	E2866DUH01/02	170	231	09/95	> 12/99				S 3440 C
spheros aeroshere world SPHEROS / con climatizzatore sul tetto SPHEROS	E2866DUH01/02	170	231	09/95	> 12/90				S 3457 C
dryer filter / filtro essiccatore	E2866DUH01/02	170	231	09/95	> 12/99				S 7259 A
power steering / servosterzo	E2866DUH01/02	170	231	09/95	> 12/99				S 3081 PO
NG 262	D0826LUH01	191	260	08/92	> 07/98	S 3292 R	S 1378 NR	S 7187 A	
2nd passage / 2.passaggio	D0826LUH01	191	260	08/92	> 07/98		S 4378 NR		
with automatic gearbox ZF HP500/590 / con cambio automatico ZF HP500/590	D0826LUH01	191	260	08/92	> 07/98				S 2234 Z
dryer filter / filtro essiccatore	D0826LUH01	191	260	08/92	> 07/98				S 7259 A
NG 262	D2865LUH09	191	260	06/97	> 07/98	S 7260 PO	S 4378 NR		
dryer filter / filtro essiccatore	D2865LUH09	191	260	06/97	> 07/98				S 7259 A
cartridge / immersione	D2865LUH09	191	260	06/97	> 07/98	S 7260 PO	S 1411 N		
NG 262	D2866LUH22	191	260	07/98	>	S 7260 PO	S 1411 N		S 3439 C
spin-on / avvitabile	D2866LUH22	191	260	07/98	>	S 7260 PO	S 4378 NR		
with automatic gearbox ZF HP500 / con cambio automatico ZF HP500	D2866LUH22	191	260	07/98	>				S 2234 Z
spheros aeroshere world SPHEROS / con climatizzatore sul tetto SPHEROS	D2866LUH22	191	260	07/98	>				S 3457 C
with air-conditioner WEBASTO Aerosphere / con climatizzatore WEBASTO Aerosphere	D2866LUH22	191	260	07/98	>				S 3081 C
dryer filter / filtro essiccatore	D2866LUH22	191	260	07/98	>				S 7259 A
power steering / servosterzo	D2866LUH22	191	260	07/98	>				S 3081 PO
NG 263	D0826	191	260	01/99	>				S 3439 C
2nd passage / 2.passaggio	D0826	191	260	01/99	>		S 4378 NR		
with automatic gearbox ZF HP500 / con cambio automatico ZF HP500	D0826	191	260	01/99	>				S 2234 Z
spheros aeroshere world / con climatizzatore sul tetto	D0826	191	260	01/99	>				S 3440 C
spheros aeroshere world SPHEROS / con climatizzatore sul tetto SPHEROS	D0826	191	260	01/99	>				S 3457 C
with air-conditioner WEBASTO Aerosphere / con climatizzatore WEBASTO Aerosphere	D0826	191	260	01/99	>	S 3292 R	S 1378 NR		
dryer filter / filtro essiccatore	D0826	191	260	01/99	>				S 7259 A
power steering / servosterzo	D0826	191	260	01/99	>				S 3081 PO
NG 263	D2866LUH22	191	260	07/98	>	S 7260 PO	S 1411 N		
spin-on / avvitabile	D2866LUH22	191	260	07/98	>	S 7260 PO	S 4378 NR		
with automatic gearbox ZF HP500 / con cambio automatico ZF HP500	D2866LUH22	191	260	07/98	>				S 2234 Z
spheros aeroshere world SPHEROS / con climatizzatore sul tetto SPHEROS	D2866LUH22	191	260	09/98	>				S 3457 C
with air-conditioner WEBASTO Aerosphere / con climatizzatore WEBASTO Aerosphere	D2866LUH22	191	260	07/98	>				S 3081 C
dryer filter / filtro essiccatore	D2866LUH22	191	260	07/98	>				S 7259 A

M

**KW HP****...MAN - buses/autobus**

power steering / servosterzo	D2866LUH22	191	260	07/98	>				S 3081 PO
NG 272	D0826LUH01	198	270	06/90	> 09/99	S 3292 R	S 1378 NR	S 7187 A	S 3439 C
	D0826LUH01	198	270	06/90	> 09/99			S 7482 A	
2nd passage / 2.passaggio	D0826LUH01	198	270	06/90	> 09/99		S 4378 NR		
with automatic gearbox ZF HP500/590 / con cambio automatico ZF HP500/590	D0826LUH01	198	270	06/90	> 09/99				S 2234 Z
spheros aeroshere world SPHEROS / con climatizzatore sul tetto SPHEROS	D0826LUH01	198	270	06/90	> 09/99				S 3457 C
dryer filter / filtro essiccatore	D0826LUH01	198	270	06/90	> 09/99				S 7259 A
power steering / servosterzo	D0826LUH01	198	270	06/90	> 09/99				S 3081 PO
NG 273 (A23)	D2066LUH11	199	270	09/07	>	S 5046 PE	S 6011 NE	S 7A11 A	
spheros aeroshere world / con climatizzatore sul tetto	D2066LUH11	199	270	09/07	>				S 3440 C
spheros aeroshere world SPHEROS / con climatizzatore sul tetto SPHEROS	D2066LUH11	199	270	09/07	>				S 3457 C
power steering / servosterzo	D2066LUH11	199	270	09/07	>				S 3081 PO
NG 312	D2865LUH07	228	310	09/95	> 07/98	S 7260 PO	S 4378 NR	S 7431 A	S 3439 C
with automatic gearbox ZF HP500/590 / con cambio automatico ZF HP500/590	D2865LUH07	228	310	09/95	> 07/98				S 2234 Z
spheros aeroshere world / con climatizzatore sul tetto	D2865LUH07	228	310	09/95	>				S 3440 C
spheros aeroshere world SPHEROS / con climatizzatore sul tetto SPHEROS	D2865LUH07	228	310	09/95	>				S 3457 C
dryer filter / filtro essiccatore	D2865LUH07	228	310	09/95	> 07/98				S 7259 A
power steering / servosterzo	D2865LUH07	228	310	09/95	> 07/98				S 3081 PO
NG 312	D2866LUH26	228	310	07/98	> 11/99				S 2234 Z
with automatic gearbox ZF HP500 / con cambio automatico ZF HP500	D2866LUH26	228	310	07/98	> 11/99	S 7260 PO	S 4378 NR		
with air-conditioner WEBASTO Aerosphere / con climatizzatore WEBASTO Aerosphere	D2866LUH26	228	310	07/98	> 11/99				S 7259 A
dryer filter / filtro essiccatore	D2866LUH26	228	310	07/98	> 11/99				
cartridge / immersione	D2866LUH26	228	310	07/98	> 11/99		S 1411 N		
power steering / servosterzo	D2866LUH26	228	310	07/98	> 11/99				S 3081 PO
NG 313	D0826	227	309	01/99	>	S 3292 R	S 1378 NR		S 3439 C
2nd passage / 2.passaggio	D0826	227	309	01/99	>		S 4378 NR		
spheros aeroshere world / con climatizzatore sul tetto	D0826	227	309	01/99	>				S 3440 C
spheros aeroshere world SPHEROS / con climatizzatore sul tetto SPHEROS	D0826	227	309	01/99	>				S 3457 C
NG 313	D2066LUH12/22	228	310	01/06	> 10/09	S 5046 PE	S 6011 NE	S 7A11 A	
with air-conditioner Webasto Aerosphere World / con climatizzatore Webasto Aerosphere World	D2066LUH12/22	228	310	01/06	> 10/09				S 3283 C
dryer filter / filtro essiccatore	D2066LUH12/22	228	310	01/06	> 10/09				S 7A66 A
inner / interno	D2066LUH12/22	228	310	01/06	> 10/09			S 7649 A	
prefilter / prefiltra	D2066LUH12/22	228	310	01/06	> 10/09		S 6088 NE		
power steering / servosterzo	D2066LUH12/22	228	310	01/06	> 10/09				S 3081 PO
NG 313	D2865	227	309	01/98	>	S 7260 PO	S 4378 NR		
NG 313	D2866LUH26	228	310	01/98	>				S 3439 C
with automatic gearbox ZF HP500 / con cambio automatico ZF HP500	D2866LUH26	228	310	07/98	> 12/01				S 2234 Z
spheros aeroshere world / con climatizzatore sul tetto	D2866LUH26	228	310	01/98	>				S 3440 C
spheros aeroshere world SPHEROS / con climatizzatore sul tetto SPHEROS	D2866LUH26	228	310	01/98	>				S 3457 C
with air-conditioner WEBASTO Aerosphere / con climatizzatore WEBASTO Aerosphere	D2866LUH26	228	310	07/98	> 12/01	S 7260 PO	S 4378 NR		
dryer filter / filtro essiccatore	D2866LUH26	228	310	07/98	> 12/01				S 7259 A
cartridge / immersione	D2866LUH26	228	310	07/98	> 12/01		S 1411 N		
power steering / servosterzo	D2866LUH26	228	310	07/98	> 12/01				S 3081 PO
NG 313 CNG	E2876LUH02	228	310	05/07	> 12/14	S 7260 PO		S 7651 A	
with automatic gearbox ZF HP500 / con cambio automatico ZF HP500	E2876LUH02	228	310	05/07	> 12/14				S 2234 Z
spheros aeroshere world SPHEROS / con climatizzatore sul tetto SPHEROS	E2876LUH02	228	310	05/13	>				S 3457 C
dryer filter / filtro essiccatore	E2876LUH02	228	310	05/07	> 12/14				S 7259 A
power steering / servosterzo	E2876LUH02	228	310	05/07	> 12/14				S 3081 PO
NG 323	D2066LUH42	235	320	05/07	> 12/14	S 5046 PE	S 6011 NE	S 7A11 A	
with air-conditioner Webasto Aerosphere World / con climatizzatore Webasto Aerosphere World	D2066LUH42	235	320	05/07	> 12/14				S 3283 C
dryer filter / filtro essiccatore	D2066LUH42	235	320	05/07	> 12/14				S 7A66 A
inner / interno	D2066LUH42	235	320	05/07	> 12/14			S 7649 A	
prefilter / prefiltra	D2066LUH42	235	320	05/07	> 12/14		S 6088 NE		
power steering / servosterzo	D2066LUH42	235	320	05/07	> 12/14				S 3081 PO
NG 363	D2066LUH48	265	360	05/07	> 12/14	S 5046 PE	S 6011 NE	S 7A11 A	
with air-conditioner Webasto Aerosphere World / con climatizzatore Webasto Aerosphere World	D2066LUH48	265	360	05/07	> 12/14				S 3283 C
dryer filter / filtro essiccatore	D2066LUH48	265	360	05/07	> 12/14				S 7A66 A
inner / interno	D2066LUH48	265	360	05/07	> 12/14			S 7649 A	
prefilter / prefiltra	D2066LUH48	265	360	05/07	> 12/14		S 6088 NE		
power steering / servosterzo	D2066LUH48	265	360	05/07	> 12/14				S 3081 PO
NG 363 Lions City G									
with automatic gearbox ZF HP500 / con cambio automatico ZF HP500	D2866LUH25	265	361	02/01	>				S 2234 Z
spheros aeroshere world SPHEROS / con climatizzatore sul tetto SPHEROS	D2866LUH25	265	361	02/01	>				S 3457 C
with air-conditioner WEBASTO Aerosphere / con climatizzatore WEBASTO Aerosphere	D2866LUH25	265	361	02/01	>	S 7260 PO	S 4378 NR		S 3081 C
dryer filter / filtro essiccatore	D2866LUH25	265	361	02/01	>				S 7259 A
power steering / servosterzo	D2866LUH25	265	361	02/01	>				S 3081 PO

NL Serie



KW HP



...MAN - buses/autobus

NL 202	D 0826 LUH 03/12	08/92 >	S 3292 R	S 1378 NR	S 7187 A	
2nd passage / 2.passaggio	D 0826 LUH 03/12	08/92 >		S 4378 NR		
with automatic gearbox ZF HP500/590 / con cambio automatico ZF HP500/590	D 0826 LUH 03/12	08/92 >				S 2234 Z
NL 202	D 0826 LUH/213	09/89 > 05/97	S 3292 R	S 1378 NR	S 7187 A	S 3439 C
	D 0826 LUH/213	09/89 > 05/97			S 7482 A	
2nd passage / 2.passaggio	D 0826 LUH/213	09/89 > 05/97		S 4378 NR		
with automatic gearbox ZF HP500/590 / con cambio automatico ZF HP500/590	D 0826 LUH/213	09/89 > 05/97				S 2234 Z
spheros aeroshere world / con climatizzatore sul tetto	D 0826 LUH/213	09/89 > 05/97				S 3440 C
spheros aeroshere world SPHEROS / con climatizzatore sul tetto SPHEROS	D 0826 LUH/213	09/89 > 05/97				S 3457 C
dryer filter / filtro essiccatore	D 0826 LUH/213	09/89 > 05/97				S 7259 A
NL 222	D 0826 LUH 03/12	12/95 >	S 3292 R	S 1378 NR	S 7187 A	S 3439 C
	D 0826 LUH 03/12	12/95 >			S 7482 A	
2nd passage / 2.passaggio	D 0826 LUH 03/12	12/95 >		S 4378 NR		
with automatic gearbox ZF HP500/590 / con cambio automatico ZF HP500/590	D 0826 LUH 03/12	12/95 >				S 2234 Z
spheros aeroshere world / con climatizzatore sul tetto	D 0826 LUH 03/12	12/95 >				S 3440 C
spheros aeroshere world SPHEROS / con climatizzatore sul tetto SPHEROS	D 0826 LUH 03/12	12/95 >				S 3457 C
dryer filter / filtro essiccatore	D 0826 LUH 03/12	12/95 >				S 7259 A
power steering / servosterzo	D 0826 LUH 03/12	12/95 >				S 3081 PO
NL 222 F	D 0826 LUH 12	02/96 >	S 3292 R	S 1378 NR	S 7187 A	
	D 0826 LUH 12	02/96 >		S 4378 NR		
2nd passage / 2.passaggio	D 0826 LUH 12	02/96 >				S 2234 Z
with automatic gearbox ZF HP500/590 / con cambio automatico ZF HP500/590	D 0826 LUH 12	02/96 >				S 7259 A
dryer filter / filtro essiccatore	D 0826 LUH 12	02/96 >				S 3081 PO
power steering / servosterzo	D 0826 LUH 12	02/96 >				
NL 223	D 0826 LUH 03/12	07/98 >	S 3292 R	S 1378 NR	S 7651 A	
	D 0826 LUH 03/12	07/98 >		S 4378 NR		
2nd passage / 2.passaggio	D 0826 LUH 03/12	07/98 >				S 2234 Z
with automatic gearbox ZF HP500 / con cambio automatico ZF HP500	D 0826 LUH 03/12	07/98 >				S 7259 A
dryer filter / filtro essiccatore	D 0826 LUH 03/12	07/98 >				S 3081 PO
power steering / servosterzo	D 0826 LUH 03/12	07/98 >				
NL 232 CNG	E 2866 DUH 01	11/95 >	S 7260 PO		S 7474 A	S 3439 C
spheros aeroshere world SPHEROS / con climatizzatore sul tetto SPHEROS	E 2866 DUH 01	09/93 > 12/99				S 3458 C
NL 243	D 0836 LOH	09/02 >	S 3292 R	S 6004 NE		S 3439 C
additional WEBASTO / addizionale WEBASTO	D 0836 LOH	09/02 >		S 4378 NR		
with automatic gearbox ZF HP500 / con cambio automatico ZF HP500	D 0836 LOH	09/02 >				S 2234 Z
spheros aeroshere world / con climatizzatore sul tetto	D 0836 LOH	09/03 >				S 3440 C
spheros aeroshere world SPHEROS / con climatizzatore sul tetto SPHEROS	D 0836 LOH	09/03 >				S 3457 C
dryer filter / filtro essiccatore	D 0836 LOH	09/02 >				S 7259 A
power steering / servosterzo	D 0836 LOH	09/02 >				S 3081 PO
NL 243 CNG	E 2866 DUH 03	09/03 >	S 7260 PO		S 7651 A	S 3439 C
with automatic gearbox ZF HP500 / con cambio automatico ZF HP500	E 2866 DUH 03	09/03 >				S 2234 Z
spheros aeroshere world / con climatizzatore sul tetto	E 2866 DUH 03	09/03 >				S 3440 C
spheros aeroshere world SPHEROS / con climatizzatore sul tetto SPHEROS	E 2866 DUH 03	09/03 >				S 3457 C
with air-conditioner Webasto Aerosphere / con climatizzatore Webasto Aerosphere	E 2866 DUH 03	09/03 >				S 3081 C
dryer filter / filtro essiccatore	E 2866 DUH 03	09/03 >				S 7259 A
power steering / servosterzo	E 2866 DUH 03	09/03 >				S 3081 PO
NL 262	D 0826 LUH 13	02/96 >	S 3292 R	S 1378 NR		
	D 0826 LUH 13	02/96 >		S 4378 NR		
2nd passage / 2.passaggio	D 0826 LUH 13	02/96 >				
NL 262	D 2865 LUH 09	06/97 > 07/98	S 7260 PO	S 4378 NR		
NL 262	D 2866 LUH 22	07/98 >	S 7260 PO	S 4378 NR	S 7651 A	
with automatic gearbox ZF HP500 / con cambio automatico ZF HP500	D 2866 LUH 22	07/98 >				S 2234 Z
dryer filter / filtro essiccatore	D 2866 LUH 22	07/98 >				S 7259 A
power steering / servosterzo	D 2866 LUH 22	07/98 >				S 3081 PO
NL 262 F	D 0826 LUH	02/96 >	S 3292 R	S 1378 NR		
	D 0826 LUH	02/96 >		S 4378 NR		
2nd passage / 2.passaggio	D 0826 LUH	02/96 >				
NL 263	D 0826 LUH 13	01/98 >	S 3292 R	S 1378 NR		S 3439 C
	D 0826 LUH 13	01/98 >		S 4378 NR		
2nd passage / 2.passaggio	D 0826 LUH 13	01/98 >				S 2234 Z
with automatic gearbox ZF HP500 / con cambio automatico ZF HP500	D 0826 LUH 13	01/98 >				S 3457 C
spheros aeroshere world SPHEROS / con climatizzatore sul tetto SPHEROS	D 0826 LUH 13	01/99 >				S 7259 A
dryer filter / filtro essiccatore	D 0826 LUH 13	01/98 >				S 3081 PO
power steering / servosterzo	D 0826 LUH 13	01/98 >				
NL 263	D 2865	01/98 >	S 7260 PO	S 4378 NR		
with automatic gearbox ZF HP500 / con cambio automatico ZF HP500	D 2865	01/98 >				S 2234 Z
dryer filter / filtro essiccatore	D 2865	01/98 >				S 7259 A
power steering / servosterzo	D 2865	01/98 >				S 3081 PO
NL 263	D 2866 LUH 22	07/98 >	S 7260 PO	S 4378 NR	S 7651 A	
with automatic gearbox ZF HP500 / con cambio automatico ZF HP500	D 2866 LUH 22	07/98 >				S 2234 Z
spheros aeroshere world SPHEROS / con climatizzatore sul tetto SPHEROS	D 2866 LUH 22	07/98 >				S 3457 C
dryer filter / filtro essiccatore	D 2866 LUH 22	07/98 >				S 7259 A

M





KW HP



...MAN - buses/autobus

M



power steering / servosterzo	D 2866 LUH 22			07/98 >				S 3081 PO
NL 263 F	D 0826			01/98 >	S 3292 R	S 1378 NR		S 3439 C
2nd passage / 2.passaggio	D 0826			01/98 >		S 4378 NR		
with automatic gearbox ZF HP500 / con cambio automatico ZF HP500	D 0826			01/98 >				S 2234 Z
spheros aeroshere world / con climatizzatore sul tetto	D 0826			01/99 >				S 3440 C
spheros aeroshere world SPHEROS / con climatizzatore sul tetto SPHEROS	D 0826			01/99 >				S 3457 C
dryer filter / filtro essiccatore	D 0826			01/98 >				S 7259 A
power steering / servosterzo	D 0826			01/98 >				S 3081 PO
NL 273 (A21)	D 2066 LUH 11	199	270	09/05 >	S 5046 PE	S 6011 NE	S 7A11 A	S 3439 C
with automatic gearbox VOITH D851.3, D854.3, D863.3 / con cambio automatico VOITH D851.3, D854.3, D863.3	D 2066 LUH 11	199	270	09/05 >				S 6449 PO
with automatic gearbox VOITH D854.3E, D864.3E / con cambio automatico VOITH D854.3E, D864.3E	D 2066 LUH 11	199	270	09/05 >				S 5663 PO
spheros aeroshere world / con climatizzatore sul tetto	D 2066 LUH 11	199	270	09/05 >				S 3440 C
spheros aeroshere world SPHEROS / con climatizzatore sul tetto SPHEROS	D 2066 LUH 11	199	270	09/05 >				S 3457 C
inner / interno	D 2066 LUH 11	199	270	09/05 >			S 7649 A	
power steering / servosterzo	D 2066 LUH 11	199	270	09/05 >				S 3081 PO
NL 283	D 0836 LOH40			09/02 >	S 3292 R	S 6004 NE		S 3439 C
additional WEBASTO / addizionale WEBASTO	D 0836 LOH40			09/02 >		S 4378 NR		
with automatic gearbox ZF HP500 / con cambio automatico ZF HP500	D 0836 LOH40			09/02 >				S 2234 Z
spheros aeroshere world / con climatizzatore sul tetto	D 0836 LOH40			09/02 >				S 3440 C
spheros aeroshere world SPHEROS / con climatizzatore sul tetto SPHEROS	D 0836 LOH40			09/02 >				S 3457 C
dryer filter / filtro essiccatore	D 0836 LOH40			09/02 >				S 7259 A
power steering / servosterzo	D 0836 LOH40			09/02 >				S 3081 PO
NL 283	D 0836 LUH40			09/02 >	S 3292 R	S 6004 NE		S 3439 C
with automatic gearbox / con cambio automatico	D 0836 LUH40			09/02 >				S 2234 Z
spheros aeroshere world / con climatizzatore sul tetto	D 0836 LUH40			09/02 >				S 3440 C
spheros aeroshere world SPHEROS / con climatizzatore sul tetto SPHEROS	D 0836 LUH40			09/02 >				S 3457 C
dryer filter / filtro essiccatore	D 0836 LUH40			09/02 >				S 7259 A
power steering / servosterzo	D 0836 LUH40			09/02 >				S 3081 PO
NL 283 EEV (A21/26)	D 2066 LUH	206	280	09/07 >	S 5046 PE	S 6011 NE	S 7A11 A	S 3439 C
spheros aeroshere world / con climatizzatore sul tetto	D 2066 LUH	206	280	09/07 >				S 3440 C
spheros aeroshere world SPHEROS / con climatizzatore sul tetto SPHEROS	D 2066 LUH	206	280	09/07 >				S 3457 C
power steering / servosterzo	D 2066 LUH	206	280	09/07 >				S 3081 PO
NL 312	D 2865 LUH 07			11/95 > 07/98	S 7260 PO	S 4378 NR	S 7482 A	S 3439 C
some / alcuni	D 2865 LUH 07			11/95 > 07/98	S 7260 PO	S 4323 NR		
spheros aeroshere world / con climatizzatore sul tetto	D 2865 LUH 07			10/95 > 07/98				S 3440 C
spheros aeroshere world SPHEROS / con climatizzatore sul tetto SPHEROS	D 2865 LUH 07			10/95 > 01/98				S 3457 C
NL 312 F	D 2865 LUH 07			02/96 > 07/98	S 7260 PO	S 4378 NR		
NL 313	D 0826			01/99 >	S 3292 R	S 1378 NR		S 3439 C
2nd passage / 2.passaggio	D 0826			01/99 >		S 4378 NR		
with automatic gearbox ZF HP500 / con cambio automatico ZF HP500	D 0826			01/99 >				S 2234 Z
spheros aeroshere world / con climatizzatore sul tetto	D 0826			01/99 >				S 3440 C
dryer filter / filtro essiccatore	D 0826			01/99 >				S 7259 A
power steering / servosterzo	D 0826			01/99 >				S 3081 PO
NL 313	D 2865			01/99 >	S 7260 PO	S 4378 NR		
with automatic gearbox ZF HP500 / con cambio automatico ZF HP500	D 2865			01/99 >				S 2234 Z
dryer filter / filtro essiccatore	D 2865			01/99 >				S 7259 A
power steering / servosterzo	D 2865			01/99 >				S 3081 PO
NL 313	D 2866 LUH 26			07/98 >	S 7260 PO	S 4378 NR	S 7651 A	
with automatic gearbox ZF HP500 / con cambio automatico ZF HP500	D 2866 LUH 26			07/98 >				S 2234 Z
dryer filter / filtro essiccatore	D 2866 LUH 26			07/98 >				S 7259 A
power steering / servosterzo	D 2866 LUH 26			07/98 >				S 3081 PO
NL 313 F	D 2866	227	310	01/99 >	S 7260 PO	S 4378 NR	S 7651 A	S 3439 C
with automatic gearbox ZF HP500 / con cambio automatico ZF HP500	D 2866	227	310	01/99 >				S 2234 Z
spheros aeroshere world / con climatizzatore sul tetto	D 2866	227	310	01/99 >				S 3440 C
spheros aeroshere world SPHEROS / con climatizzatore sul tetto SPHEROS	D 2866	227	310	01/99 >				S 3457 C
dryer filter / filtro essiccatore	D 2866	227	310	01/99 >				S 7259 A
power steering / servosterzo	D 2866	227	310	01/99 >				S 3081 PO
NL 363	D 2866 LOH			09/00 >	S 5016 PE	S 4378 NR	S 1050 A	S 3439 C
with automatic gearbox ZF HP500 / con cambio automatico ZF HP500	D 2866 LOH			09/00 >				S 2234 Z
spheros aeroshere world / con climatizzatore sul tetto	D 2866 LOH			09/00 >				S 3440 C
spheros aeroshere world SPHEROS / con climatizzatore sul tetto SPHEROS	D 2866 LOH			09/00 >				S 3457 C
dryer filter / filtro essiccatore	D 2866 LOH			09/00 >				S 7259 A
power steering / servosterzo	D 2866 LOH			09/00 >				S 3081 PO
NL 363 F	D 2866 LOH			09/00 >	S 5016 PE	S 4378 NR	S 1050 A	S 3439 C
with automatic gearbox ZF HP500 / con cambio automatico ZF HP500	D 2866 LOH			09/00 >				S 2234 Z
spheros aeroshere world / con climatizzatore sul tetto	D 2866 LOH			09/00 >				S 3440 C
spheros aeroshere world / con climatizzatore sul tetto	D 2866 LOH			09/00 >				S 3457 C



kW HP



...MAN - buses/autobus

dryer filter / filtro essiccatore	D 2866 LOH			09/00 >				S 7259 A
power steering / servosterzo	D 2866 LOH			09/00 >				S 3081 PO
NM Serie								
NM 152	D 0824 LOH 01			04/92 > 03/97	S 3292 R	S 1378 NR	S 2450 A	S 3439 C
2nd passage / 2.passaggio	D 0824 LOH 01			04/92 > 03/97		S 4378 NR		
dryer filter / filtro essiccatore	D 0824 LOH 01			04/92 > 03/97				S 7259 A
NM 152 Midi	D 0826 OH 02			05/90 > 10/93	S 3292 R	S 1378 NR	S 2650 A	S 3439 C
2nd passage / 2.passaggio	D 0826 OH 02			05/90 > 10/93		S 4378 NR		
some / alcuni	D 0826 OH 02			05/90 > 10/93	S 3292 R	S 1378 NR	S 7187 A	
dryer filter / filtro essiccatore	D 0826 OH 02			05/90 > 10/93				S 7259 A
NM 182 Midi	D 0826 TOH			05/90 >	S 3292 R	S 1378 NR	S 2650 A	
2nd passage / 2.passaggio	D 0826 TOH			05/90 >		S 4378 NR		
some / alcuni	D 0826 TOH			05/90 >	S 3292 R	S 1378 NR	S 7187 A	
dryer filter / filtro essiccatore	D 0826 TOH			05/90 >				S 7259 A
NM 192 Midi	D 0826 LOH			10/93 >	S 3292 R	S 1378 NR	S 2650 A	S 3439 C
2nd passage / 2.passaggio	D 0826 LOH			10/93 >		S 4378 NR		
some / alcuni	D 0826 LOH			10/93 >	S 3292 R	S 1378 NR	S 7187 A	
dryer filter / filtro essiccatore	D 0826 LOH			10/93 >				S 7259 A
NM 222	D 0826 LOH 15			02/96 >	S 3292 R			
dryer filter / filtro essiccatore	D 0826 LOH 15			02/96 >				S 7259 A
NM 222	D 0826 LUH 12			02/96 >	S 3292 R			
dryer filter / filtro essiccatore	D 0826 LUH 12			02/96 >				S 7259 A
NM 223	D 0826 LOH 15			02/96 >	S 3292 R			S 3439 C
dryer filter / filtro essiccatore	D 0826 LOH 15			02/96 >				S 7259 A
NM 223	D 0826 LUH 12			02/96 >	S 3292 R			
dryer filter / filtro essiccatore	D 0826 LUH 12			02/96 >				S 7259 A
NM 223 Midi	D 0836 LOH			09/00 >	S 3292 R	S 4378 NR	S 7187 A	S 3439 C
	D 0836 LOH			09/00 >			S 7482 A	
dryer filter / filtro essiccatore	D 0836 LOH			09/00 >				S 7259 A
NM 224 Lion's Midi	D 0836 LOH			03/01 >	S 3292 R	S 4378 NR		S 3439 C
dryer filter / filtro essiccatore	D 0836 LOH			03/01 >				S 7259 A
NM 283 Midi	D 0836 LOH			09/00 >	S 3292 R	S 4378 NR	S 7187 A	S 3439 C
	D 0836 LOH			09/00 >			S 7482 A	
dryer filter / filtro essiccatore	D 0836 LOH			09/00 >				S 7259 A
NM 284 Lion's Midi	D 0836 LOH			09/00 >	S 3292 R	S 4378 NR		S 3439 C
dryer filter / filtro essiccatore	D 0836 LOH			09/00 >				S 7259 A
NUE Serie								
NUE 223 (A20)	D 0826	161 220		01/99 >	S 3292 R	S 4473 NR	S 7651 A	S 3439 C
with automatic gearbox ZF HP500 / con cambio automatico ZF HP500	D 0826	161 220		01/99 >				S 2234 Z
spheros aeroshere world / con climatizzatore sul tetto	D 0826	161 220		01/99 >				S 3440 C
spheros aeroshere world SPHEROS / con climatizzatore sul tetto SPHEROS	D 0826	161 220		01/99 >				S 3457 C
with air-conditioner WEBASTO Aerosphere / con climatizzatore WEBASTO Aerosphere	D 0826	161 220		01/99 >				S 3081 C
dryer filter / filtro essiccatore	D 0826	161 220		01/99 >				S 7259 A
power steering / servosterzo	D 0826	161 220		01/99 >				S 3081 PO
NUE 263	D 0826	191 260		07/98 > 10/01	S 3292 R	S 4378 NR	S 7651 A	S 3439 C
with automatic gearbox ZF HP500 / con cambio automatico ZF HP500	D 0826	191 260		07/98 > 10/01				S 2234 Z
spheros aeroshere world / con climatizzatore sul tetto	D 0826	191 260		01/99 > 10/01				S 3444 C
spheros aeroshere world SPHEROS / con climatizzatore sul tetto SPHEROS	D 0826	191 260		01/99 > 10/01				S 3457 C
dryer filter / filtro essiccatore	D 0826	191 260		07/98 > 10/01				S 7259 A
power steering / servosterzo	D 0826	191 260		07/98 > 10/01				S 3081 PO
NUE 263	D 0826 LUH 13			07/98 >	S 3292 R	S 4378 NR		
with automatic gearbox ZF HP500 / con cambio automatico ZF HP500	D 0826 LUH 13			07/98 >				S 2234 Z
dryer filter / filtro essiccatore	D 0826 LUH 13			07/98 >				S 7259 A
power steering / servosterzo	D 0826 LUH 13			07/98 >				S 3081 PO
NUE 263	D 2865 LUH 09			09/96 > 07/98	S 7260 PO	S 4378 NR		
with automatic gearbox ZF HP500 / con cambio automatico ZF HP500	D 2865 LUH 09			09/96 > 07/98				S 2234 Z
dryer filter / filtro essiccatore	D 2865 LUH 09			09/96 > 07/98				S 7259 A
power steering / servosterzo	D 2865 LUH 09			09/96 > 07/98				S 3081 PO
NUE 263	D 2866 LUH 22/23	191 260		07/98 >	S 7260 PO	S 4378 NR		S 3439 C
with automatic gearbox ZF HP500 / con cambio automatico ZF HP500	D 2866 LUH 22/23	191 260		07/98 >				S 2234 Z
spheros aeroshere world / con climatizzatore sul tetto	D 2866 LUH 22/23	191 260		07/98 >				S 3440 C
spheros aeroshere world SPHEROS / con climatizzatore sul tetto SPHEROS	D 2866 LUH 22/23	191 260		07/98 >				S 3457 C
dryer filter / filtro essiccatore	D 2866 LUH 22/23	191 260		07/98 >				S 7259 A
power steering / servosterzo	D 2866 LUH 22/23	191 260		07/98 >				S 3081 PO
NUE 283								
additional WEBASTO / addizionale WEBASTO	D 0836 LUH01			02/01 >		S 4378 NR		
with automatic gearbox ZF HP500 / con cambio automatico ZF HP500	D 0836 LUH01			02/01 >				S 2234 Z

M





kW HP



...MAN - buses/autobus

M



spheros aeroshere world / con climatizzatore sul tetto	D 0836 LUH01	02/01 >				S 3440 C
spheros aeroshere world SPHEROS / con climatizzatore sul tetto SPHEROS	D 0836 LUH01	02/01 >				S 3457 C
dryer filter / filtro essiccatore	D 0836 LUH01	02/01 >				S 7259 A
power steering / servosterzo	D 0836 LUH01	02/01 >				S 3081 PO
NUE 313	D 0826	01/99 >	S 3292 R	S 1378 NR		S 3439 C
2nd passage / 2.passaggio	D 0826	01/99 >		S 4378 NR		
with automatic gearbox ZF HP500 / con cambio automatico ZF HP500	D 0826	01/99 >				S 2234 Z
spheros aeroshere world / con climatizzatore sul tetto	D 0826	01/99 >				S 3440 C
spheros aeroshere world SPHEROS / con climatizzatore sul tetto SPHEROS	D 0826	01/99 >				S 3457 C
dryer filter / filtro essiccatore	D 0826	01/99 >				S 7259 A
power steering / servosterzo	D 0826	01/99 >				S 3081 PO
NUE 313	D 2865	01/99 >	S 7260 PO	S 4378 NR		
with automatic gearbox ZF HP500 / con cambio automatico ZF HP500	D 2865	01/99 >				S 2234 Z
dryer filter / filtro essiccatore	D 2865	01/99 >				S 7259 A
power steering / servosterzo	D 2865	01/99 >				S 3081 PO
NUE 313	D 2866 LUH 26	07/98 >	S 7260 PO	S 4378 NR		S 3439 C
with automatic gearbox ZF HP500 / con cambio automatico ZF HP500	D 2866 LUH 26	07/98 >				S 2234 Z
spheros aeroshere world / con climatizzatore sul tetto	D 2866 LUH 26	02/98 >				S 3440 C
spheros aeroshere world SPHEROS / con climatizzatore sul tetto SPHEROS	D 2866 LUH 26	02/98 >				S 3457 C
dryer filter / filtro essiccatore	D 2866 LUH 26	07/98 >				S 7259 A
power steering / servosterzo	D 2866 LUH 26	07/98 >				S 3081 PO
NUE 313.15 M	D 2866 LUH 26	07/98 >	S 7260 PO	S 4378 NR		
NUE 353.15 M	D 2866 LUH 21	07/98 >	S 7260 PO	S 4378 NR		S 3439 C
with automatic gearbox ZF HP500 / con cambio automatico ZF HP500	D 2866 LUH 21	07/98 >				S 2234 Z
dryer filter / filtro essiccatore	D 2866 LUH 21	07/98 >				S 7259 A
power steering / servosterzo	D 2866 LUH 21	07/98 >				S 3081 PO
NUE 363	D 2866 LUH 25	02/01 >	S 7260 PO	S 4378 NR		S 3436 C
with automatic gearbox ZF HP500 / con cambio automatico ZF HP500	D 2866 LUH 25	02/01 >				S 2234 Z
spheros aeroshere world / con climatizzatore sul tetto	D 2866 LUH 25	02/01 >				S 3440 C
spheros aeroshere world SPHEROS / con climatizzatore sul tetto SPHEROS	D 2866 LUH 25	02/01 >				S 3457 C
dryer filter / filtro essiccatore	D 2866 LUH 25	02/01 >				S 7259 A
power steering / servosterzo	D 2866 LUH 25	02/01 >				S 3081 PO
R Serie						
R 240	D 2866	01/80 > 12/88	S 7260 PO	S 1411 N	S 2650 A	
R 280	D 2566	01/80 > 12/88	S 7260 PO	S 1411 N	S 1050 A	
R 292	D 2866 TOH 310	04/92 > 01/93	S 7260 PO	S 1411 N	S 1050 A	
spin-on / avvitabile	D 2866 TOH 310	04/92 > 01/93	S 7260 PO	S 4378 NR	S 1050 A	
dryer filter / filtro essiccatore	D 2866 TOH 310	04/92 > 01/93				S 7259 A
R 292	D 2866 TUH 290	03/86 > 04/92	S 7260 PO	S 1411 N	S 1050 A	
spin-on / avvitabile	D 2866 TUH 290	03/86 > 04/92	S 7260 PO	S 4378 NR	S 1050 A	
RH Serie						
353 Lion's Star	D 2866 LOH 26	09/95 >	S 7260 PO	S 1411 N		
spin-on / avvitabile	D 2866 LOH 26	09/95 >	S 7260 PO	S 4378 NR		
402 Lion's Coach (A32)	D 2866 LOH 23	09/98 >	S 7260 PO	S 4378 NR	S 1050 A	
dryer filter / filtro essiccatore	D 2866 LOH 23	09/98 >				S 7259 A
402 Lion's Star (A32)	D 2866 LOH 23	09/98 >	S 7260 PO	S 4378 NR	S 1050 A	
dryer filter / filtro essiccatore	D 2866 LOH 23	09/98 >				S 7259 A
403 Lion's Coach (A13)	D 2866 LOH 23	09/98 >	S 7260 PO	S 4378 NR	S 1050 A	
dryer filter / filtro essiccatore	D 2866 LOH 23	09/98 >				S 7259 A
403 Lion's Star	D 2866 LOH 23	09/95 >	S 7260 PO	S 4378 NR	S 1050 A	
some / alcuni	D 2866 LOH 23	09/95 >	S 7260 PO	S 4378 NR	S 1050 A	
403 Lion's Top Coach	D 2866 LOH 23	09/95 >	S 7260 PO	S 4378 NR		
some / alcuni	D 2866 LOH 23	09/95 >	S 7260 PO	S 4378 NR	S 1050 A	
413 Lion's Coach (R07)	D 2866 LOH 29	09/99 >	S 7260 PO	S 4378 NR	S 1050 A	
dryer filter / filtro essiccatore	D 2866 LOH 29	09/99 >				S 7259 A
460 Lion's Top Coach (A32)	D 2876 LOH	09/98 >	S 5016 PE	S 4378 NR	S 1050 A	
dryer filter / filtro essiccatore	D 2876 LOH	09/98 >				S 7259 A
inner / interno	D 2876 LOH	09/98 >			S 1307 A	
power steering / servosterzo	D 2876 LOH	09/98 >				S 3081 PO
463 Lion's Star (A03)	D 2876 LOH 01/02	09/98 >	S 5016 PE	S 4378 NR	S 1050 A	
dryer filter / filtro essiccatore	D 2876 LOH 01/02	09/98 >				S 7259 A
power steering / servosterzo	D 2876 LOH 01/02	09/98 >				S 3081 PO
RHC Serie						
414 Lion's Coach	D 2866 LOH 034	09/02 >	S 5016 PE	S 4378 NR	S 1050 A	
dryer filter / filtro essiccatore	D 2866 LOH 034	09/02 >				S 7259 A
inner / interno	D 2866 LOH 034	09/02 >			S 1307 A	
power steering / servosterzo	D 2866 LOH 034	09/02 >				S 3081 PO



kW HP



...MAN - buses/autobus

414 Lion's Top Coach	D 2866 LOH 034	09/02 >	S 5016 PE	S 4378 NR	S 1050 A		
dryer filter / filtro essiccatore	D 2866 LOH 034	09/02 >				S 7259 A	
inner / interno	D 2866 LOH 034	09/02 >			S 1307 A		
power steering / servosterzo	D 2866 LOH 034	09/02 >				S 3081 PO	
464 Lion's Top Coach	D 2876 LOH 03	09/02 >	S 5016 PE	S 6004 NE	S 1050 A		
dryer filter / filtro essiccatore	D 2876 LOH 03	09/02 >				S 7259 A	
inner / interno	D 2876 LOH 03	09/02 >			S 1307 A		
power steering / servosterzo	D 2876 LOH 03	09/02 >				S 3081 PO	
RHS Serie							
460 Lion's Top Coach (A32)	D 2876 LOH	09/98 >	S 5016 PE	S 4378 NR	S 1050 A		
dryer filter / filtro essiccatore	D 2876 LOH	09/98 >				S 7259 A	
inner / interno	D 2876 LOH	09/98 >			S 1307 A		
power steering / servosterzo	D 2876 LOH	09/98 >				S 3081 PO	
464 Lion's Coach (R07)	D 2876 LOH 03	09/02 >	S 5016 PE	S 6004 NE	S 1050 A		
dryer filter / filtro essiccatore	D 2876 LOH 03	09/02 >				S 7259 A	
inner / interno	D 2876 LOH 03	09/02 >			S 1307 A		
power steering / servosterzo	D 2876 LOH 03	09/02 >				S 3081 PO	
464 Lion's Star (R02)	D 2876 LOH 02	09/01 >	S 5016 PE	S 4378 NR	S 1050 A		
dryer filter / filtro essiccatore	D 2876 LOH 02	09/01 >				S 7259 A	
inner / interno	D 2876 LOH 02	09/01 >			S 1307 A		
power steering / servosterzo	D 2876 LOH 02	09/01 >				S 3081 PO	
464 Lion's Top Coach (R08)	D 2876 LOH 03	09/02 >	S 5016 PE	S 6004 NE	S 1050 A		
dryer filter / filtro essiccatore	D 2876 LOH 03	09/02 >				S 7259 A	
inner / interno	D 2876 LOH 03	09/02 >			S 1307 A		
power steering / servosterzo	D 2876 LOH 03	09/02 >				S 3081 PO	
464 Lion's Top Star (R03)	D 2876 LOH 03	09/02 >	S 5016 PE	S 6004 NE	S 1050 A		
dryer filter / filtro essiccatore	D 2876 LOH 03	09/02 >				S 7259 A	
inner / interno	D 2876 LOH 03	09/02 >			S 1307 A		
power steering / servosterzo	D 2876 LOH 03	09/02 >				S 3081 PO	
RN Serie							
313 Lion's Comfort	D 2866 LUH 20/26	09/96 >	S 7260 PO	S 4378 NR			
dryer filter / filtro essiccatore	D 2866 LUH 20/26	09/96 >				S 7259 A	
353 Lion's Comfort	D 2866 LUH 21	06/97 >	S 7260 PO	S 4378 NR			
RUE Serie							
RUE 240	D 2866 UH 240	01/80 > 12/88	S 7260 PO	S 1411 N	S 2650 A		
dryer filter / filtro essiccatore	D 2866 UH 240	11/85 > 12/88				S 7259 A	
RUE 280	D 2566 MTUH 280	01/80 > 12/88	S 7260 PO	S 1411 N	S 1050 A		
dryer filter / filtro essiccatore	D 2566 MTUH 280	11/85 > 12/88				S 7259 A	
RUE 290	D 2866		S 7260 PO	S 1411 N	S 2650 A		
power steering / servosterzo	D 2866					S 8790 PO	
S Serie							
211	U 11 D			S 1411 N			
230	D 2156		S 0530 PO	S 1411 N	S 7987 A		
power steering / servosterzo	D 2156					S 8790 PO	
313 UL	Mercedes Benz OM447HLA	04/95 >	S 7261 PO	S 2162 N			
spin-on / avvitabile	Mercedes Benz OM447HLA	04/95 >	S 7261 PO	S 4378 NR			
with automatic gearbox ZF HP500 / con cambio automatico ZF HP500	Mercedes Benz OM447HLA	04/95 >				S 2234 Z	
dryer filter / filtro essiccatore	Mercedes Benz OM447HLA	04/95 >				S 7259 A	
power steering / servosterzo	Mercedes Benz OM447HLA	04/95 >				S 8790 PO	
313 UL	Mercedes Benz OM457HLA	09/00 >		S 6001 NE			
dryer filter / filtro essiccatore	Mercedes Benz OM457HLA	09/00 >				S 7259 A	
power steering / servosterzo	Mercedes Benz OM457HLA	09/00 >				S 3081 PO	
SD Serie							
200	D 2566 MXUH 175	04/74 > 09/75	S 7260 PO	S 1411 N	S 7987 A		
power steering / servosterzo	D 2566 MXUH 175	04/74 > 09/75				S 8790 PO	
202	D 2566 UH	10/85 > 10/93	S 7260 PO	S 1411 N	S 2650 A		
spin-on / avvitabile	D 2566 UH	10/85 > 10/93	S 7260 PO	S 4378 NR	S 2650 A		
dryer filter / filtro essiccatore	D 2566 UH	10/85 > 10/93				S 7259 A	
SG Serie							
192	D 2156 HMXU 038	01/72 > 12/76	S 0530 PO	S 1411 N	S 7987 A	S 3439 C	
power steering / servosterzo	D 2156 HMXU 038	01/72 > 12/76				S 8790 PO	
192	D 2356 HMXU 066	01/72 > 12/76	S 0530 PO	S 1411 N	S 7987 A	S 3439 C	
power steering / servosterzo	D 2356 HMXU 066	01/72 > 12/76				S 8790 PO	
220	D 2566 MLUM/MUM	07/76 > 04/80	S 7260 PO	S 1411 N	S 7987 A	S 3439 C	
power steering / servosterzo	D 2566 MLUM/MUM	07/76 > 04/80				S 8790 PO	
220	D 2566 MUH	05/80 > 01/86	S 7260 PO	S 1411 N	S 7987 A		
with automatic gearbox ZF HP500/590 / con cambio automatico ZF HP500/590	D 2566 MUH	05/80 > 01/86				S 2234 Z	

M





kW HP



...MAN - buses/autobus

M



power steering / servosterzo	D 2566 MUH			05/80 > 01/86				S 8790 PO
220	D 2566 MUM/US			05/80 > 01/85	S 7260 PO	S 1411 N	S 7987 A	S 3439 C
power steering / servosterzo	D 2566 MUM/US			05/80 > 01/85				S 8790 PO
220 Chicago	D 2566 MLUM/MUM			07/76 > 04/80	S 7260 PO	S 1411 N	S 7987 A	
power steering / servosterzo	D 2566 MLUM/MUM			07/76 > 04/80				S 8790 PO
220 Chicago	D 2566 MUH			05/80 > 01/86	S 7260 PO	S 1411 N	S 7987 A	
with automatic gearbox ZF HP500/590 / con cambio automatico ZF HP500/590	D 2566 MUH			05/80 > 01/86				S 2234 Z
power steering / servosterzo	D 2566 MUH			05/80 > 01/86				S 8790 PO
220 Chicago	D 2566 MUM/US			05/80 > 01/85	S 7260 PO	S 1411 N	S 7987 A	
power steering / servosterzo	D 2566 MUM/US			05/80 > 01/85				S 8790 PO
240 H	D 2866 TUH 290			01/86 > 12/86	S 7260 PO	S 1411 N	S 2650 A	S 3439 C
power steering / servosterzo	D 2866 TUH 290			01/86 > 12/86				S 8790 PO
240 H UE	D 2566 MUH 240			05/80 > 01/86	S 7260 PO	S 1411 N	S 7987 A	S 3439 C
with automatic gearbox ZF HP500/590 / con cambio automatico ZF HP500/590	D 2566 MUH 240			05/80 > 01/86				S 2234 Z
power steering / servosterzo	D 2566 MUH 240			05/80 > 01/86				S 8790 PO
242	D 2866 TUH 290			09/85 > 12/87	S 7260 PO	S 1411 N	S 2650 A	S 3439 C
	D 2866 TUH 290			01/88 > 04/94	S 7260 PO	S 1411 N		S 3439 C
spin-on / avvitalabile	D 2866 TUH 290			09/90 > 04/94	S 7260 PO	S 4378 NR		
with automatic gearbox ZF HP500/590 / con cambio automatico ZF HP500/590	D 2866 TUH 290			09/85 > 04/94				S 2234 Z
dryer filter / filtro essiccatore	D 2866 TUH 290			09/85 > 04/94				S 7259 A
242 H	D 2566 MUH 240			11/84 > 01/85	S 7260 PO	S 1411 N	S 7987 A	S 3439 C
	D 2566 MUH 240			02/85 > 09/85	S 7260 PO	S 1411 N		S 3439 C
with automatic gearbox ZF HP500/590 / con cambio automatico ZF HP500/590	D 2566 MUH 240			11/84 > 09/85				S 2234 Z
power steering / servosterzo	D 2566 MUH 240			11/84 > 09/85				S 8790 PO
263 (A75)	D 2866			09/99 >	S 7260 PO	S 4378 NR		S 3439 C
with automatic gearbox ZF HP500/590 / con cambio automatico ZF HP500/590	D 2866			09/99 >				S 2234 Z
dryer filter / filtro essiccatore	D 2866			09/99 >				S 7259 A
292	D 2866			04/93 > 04/94	S 7260 PO	S 4378 NR	S 2650 A	S 3439 C
dryer filter / filtro essiccatore	D 2866			04/93 > 04/94				S 7259 A
292 H	D 2866 TUH 290			11/84 > 09/89	S 7260 PO	S 1411 N		S 3439 C
some / alcuni	D 2866 TUH 290			11/84 > 09/89	S 7260 PO	S 1411 N	S 1050 A	
with automatic gearbox ZF HP500/590 / con cambio automatico ZF HP500/590	D 2866 TUH 290			11/84 > 09/89				S 2234 Z
dryer filter / filtro essiccatore	D 2866 TUH 290			11/85 > 09/89				S 7259 A
310	D 2566 MLUM			08/81 > 11/83	S 7260 PO	S 1411 N	S 7987 A	S 3439 C
some / alcuni	D 2566 MLUM			08/81 > 11/83	S 7260 PO	S 1411 N	S 7987 A	
with automatic gearbox ZF HP500/590 / con cambio automatico ZF HP500/590	D 2566 MLUM			08/81 > 11/83				S 2234 Z
power steering / servosterzo	D 2566 MLUM			08/81 > 11/83				S 8790 PO
312	D 2865 LUH			02/94 > 06/97	S 7260 PO	S 4378 NR		
some / alcuni	D 2865 LUH			02/94 > 06/97	S 7260 PO	S 4378 NR	S 1050 A	
with automatic gearbox ZF HP500/590 / con cambio automatico ZF HP500/590	D 2865 LUH			02/94 > 06/97				S 2234 Z
313	D 2866 Euro 2			09/99 >	S 7260 PO	S 4378 NR		S 3439 C
with automatic gearbox ZF HP500 / con cambio automatico ZF HP500	D 2866 Euro 2			09/99 >				S 2234 Z
dryer filter / filtro essiccatore	D 2866 Euro 2			09/99 >				S 7259 A
322	D 2865 LUH			04/94 > 08/97	S 7260 PO	S 4378 NR		S 3439 C
some / alcuni	D 2865 LUH			04/94 > 08/97	S 7260 PO	S 4378 NR	S 1050 A	
with automatic gearbox ZF HP500 / con cambio automatico ZF HP500	D 2865 LUH			04/94 > 08/97				S 2234 Z
dryer filter / filtro essiccatore	D 2865 LUH			04/94 > 08/97				S 7259 A
SL II Serie								
202	D 2566 UH	155	211	06/84 > 08/89	S 7260 PO	S 1411 N	S 2650 A	
with automatic gearbox ZF HP500/590 / con cambio automatico ZF HP500/590	D 2566 UH	155	211	06/84 > 08/89				S 2234 Z
dryer filter / filtro essiccatore	D 2566 UH	155	211	11/85 > 08/89				S 7259 A
power steering / servosterzo	D 2566 UH	155	211	06/84 > 08/89				S 8790 PO
202	D 2866 UH 240	177	240	06/84 > 12/87	S 7260 PO	S 1411 N	S 0450 A	
	D 2866 UH 240	177	240	01/88 > 04/94	S 7260 PO	S 1411 N	S 7431 A	
spin-on / avvitalabile	D 2866 UH 240	177	240	06/84 > 04/94	S 7260 PO	S 4378 NR		
with automatic gearbox ZF HP500/590 / con cambio automatico ZF HP500/590	D 2866 UH 240	177	240	06/84 > 04/94				S 2234 Z
dryer filter / filtro essiccatore	D 2866 UH 240	177	240	11/85 > 04/94				S 7259 A
SL Serie								
160	D 0846 HMXU 015			05/71 > 12/76	S 0530 PO	S 7411 N		
192	D 2156 HMXU 037			05/71 > 12/76	S 0530 PO	S 1411 N	S 7987 A	
power steering / servosterzo	D 2156 HMXU 037			05/71 > 12/76				S 8790 PO
195	Buessing U 11 D 5			01/72 > 05/73		S 1411 N		
200	D 2556 MXUH 175			04/74 > 09/75	S 7260 PO	S 1411 N	S 7987 A	
some / alcuni	D 2556 MXUH 175			04/74 > 09/75	S 7260 PO	S 7411 N	S 7987 A	
power steering / servosterzo	D 2556 MXUH 175			04/74 > 09/75				S 8790 PO
200	D 2566 MUH 175			10/75 > 04/80	S 7260 PO	S 1411 N	S 7987 A	
power steering / servosterzo	D 2566 MUH 175			10/75 > 04/80				S 8790 PO



kW HP



...MAN - buses/autobus

223 (A74) dryer filter / filtro essiccatore	D 0836		03/00 >	S 3292 R	S 4378 NR	S 7187 A	
	D 0836		03/00 > 08/04			S 7482 A	
	D 0836		03/00 >				S 7259 A
240 Americana power steering / servosterzo	D 2566 MLUH		02/85 > 03/85	S 7260 PO	S 1411 N	S 2650 A	
	D 2566 MLUH		02/85 > 03/85				S 8790 PO
283 (A74) dryer filter / filtro essiccatore	D 0836		03/00 >	S 3292 R	S 4378 NR	S 7187 A	
	D 0836		03/00 >				S 7259 A
SM Serie							
152 Midi 2nd passage / 2.passaggio some / alcuni dryer filter / filtro essiccatore	D 0826 OH 02		11/87 > 04/94	S 3292 R	S 1378 NR	S 2650 A	
	D 0826 OH 02		11/87 > 04/94		S 4378 NR		
	D 0826 OH 02		11/87 > 04/94	S 3292 R	S 1378 NR	S 7187 A	
	D 0826 OH 02		11/87 > 04/94				S 7259 A
182 Midi 2nd passage / 2.passaggio some / alcuni dryer filter / filtro essiccatore	D 0826 TOH		11/87 > 04/91	S 3292 R	S 1378 NR	S 7187 A	
	D 0826 TOH		11/87 > 04/91		S 4378 NR		
	D 0826 TOH		11/87 > 04/91	S 3292 R	S 1378 NR	S 2650 A	
	D 0826 TOH		11/87 > 04/91				S 7259 A
192 Midi 2nd passage / 2.passaggio some / alcuni dryer filter / filtro essiccatore	D 0826 TOH		05/88 > 02/95	S 3292 R	S 1378 NR	S 7187 A	
	D 0826 TOH		05/88 > 02/95		S 4378 NR		
	D 0826 TOH		05/88 > 02/95	S 3292 R	S 1378 NR	S 2650 A	
	D 0826 TOH		05/88 > 02/95				S 7259 A
SR Serie							
240 power steering / servosterzo	D 2566 MUH 240		10/75 > 04/80	S 7260 PO	S 1411 N	S 7987 A	
	D 2566 MUH 240		10/75 > 04/80				S 8790 PO
280 power steering / servosterzo	D 2566 MTUH 280		05/80 > 06/83	S 7260 PO	S 1411 N	S 7028 A	
	D 2566 MTUH 280		05/80 > 06/83				S 8790 PO
292 292 H	D 2866 TUH 290		05/85 > 12/85	S 7260 PO	S 1411 N	S 1050 A	
	D 2866 TUH 290		05/85 > 12/85	S 7260 PO	S 1411 N	S 1050 A	
321 H power steering / servosterzo	D 2566 MKUH 320		03/82 > 11/86	S 7260 PO	S 1411 N	S 1050 A	
	D 2566 MKUH 320		03/82 > 11/86				S 8790 PO
361 361 H	D 2866 KUJ 360		06/84 > 11/86	S 7260 PO	S 1411 N	S 1050 A	
	D 2866 KUJ 360		06/84 > 11/86	S 7260 PO	S 1411 N	S 1050 A	
362 362 H	D 2866 KUJ 360		09/85 > 12/85	S 7260 PO	S 1411 N	S 1050 A	
	D 2866 KUJ 360		09/85 > 12/85	S 7260 PO	S 1411 N	S 1050 A	
SUE Serie							
210 223 (A72) with automatic gearbox ZF HP500/590 / con cambio automatico ZF HP500/590 dryer filter / filtro essiccatore	Buessing U 11 D		01/72 > 06/73		S 1411 N		S 3439 C
	D 0826	162 221	08/99 >	S 3292 R	S 4378 NR	S 7651 A	S 3439 C
	D 0826	162 221	08/99 >				S 2234 Z
230 240	D 2356 HMXU 062		01/72 > 12/75	S 0530 PO	S 1411 N		S 3439 C
	D 2556 MXUH 192		04/74 > 09/75	S 7260 PO	S 1411 N	S 2650 A	S 3439 C
240 power steering / servosterzo	D 2566 MTUH 280		11/82 > 01/86	S 7260 PO	S 1411 N	S 2650 A	S 3439 C
	D 2566 MTUH 280		11/82 > 01/86				S 8790 PO
240 power steering / servosterzo	D 2566 MUH 192		10/75 > 04/80	S 7260 PO	S 1411 N	S 2650 A	S 3439 C
	D 2566 MUH 192		10/75 > 04/80				S 8790 PO
240 power steering / servosterzo	D 2566 MUH 200		05/80 > 11/83	S 7260 PO	S 1411 N	S 2650 A	S 3439 C
	D 2566 MUH 200		05/80 > 11/83				S 8790 PO
240 some / alcuni dryer filter / filtro essiccatore	D 2866 TUH 290		01/86 > 09/89	S 7260 PO	S 1411 N	S 2650 A	S 3439 C
	D 2866 TUH 290		01/86 > 09/89	S 7260 PO	S 1411 N	S 7187 A	
	D 2866 TUH 290		01/86 > 09/89				S 7259 A
240 F power steering / servosterzo	D 2866 TUH 290		01/86 > 02/88	S 7260 PO	S 1411 N	S 2650 A	S 3439 C
	D 2866 TUH 290		01/86 > 02/88				S 8790 PO
242 spin-on / avvvitabile with automatic gearbox ZF HP500/590 / con cambio automatico ZF HP500/590 dryer filter / filtro essiccatore	D 2866 UH 240		01/87 > 04/93	S 7260 PO	S 1411 N	S 2650 A	S 3439 C
	D 2866 UH 240		01/87 > 04/93	S 7260 PO	S 4378 NR		
	D 2866 UH 240		01/87 > 04/93				S 2234 Z
	D 2866 UH 240		01/87 > 04/93				S 7259 A
263 (A72) with automatic gearbox ZF HP500/590 / con cambio automatico ZF HP500/590 dryer filter / filtro essiccatore	D 2866 LUH	191 260	09/99 >	S 7260 PO	S 4378 NR	S 7651 A	S 3439 C
	D 2866 LUH	191 260	09/99 >				S 2234 Z
	D 2866 LUH	191 260	09/99 >				S 7259 A
272 with automatic gearbox ZF HP500/590 / con cambio automatico ZF HP500/590 dryer filter / filtro essiccatore	D 2865 LUH 02		04/93 > 05/95	S 7260 PO	S 4378 NR		S 3439 C
	D 2865 LUH 02		04/93 > 05/95				S 2234 Z
	D 2865 LUH 02		04/93 > 05/95				S 7259 A
283 (A72) with automatic gearbox ZF HP500/590 / con cambio automatico ZF HP500/590 dryer filter / filtro essiccatore	D 0836 LOH	206 280	09/01 >	S 3292 R	S 4378 NR	S 7651 A	S 3439 C
	D 0836 LOH	206 280	09/01 >				S 2234 Z
	D 0836 LOH	206 280	09/01 >				S 7259 A
292 (888) dryer filter / filtro essiccatore	D 2866		04/92 > 04/93	S 7260 PO	S 4378 NR		S 3439 C
	D 2866		04/92 > 04/93				S 7259 A
293 (A72)	D 0836 LOH60	213 290	09/03 >	S 3292 R	S 4378 NR	S 7651 A	S 3439 C

M



**KW HP****...MAN - buses/autobus****M**

with automatic gearbox ZF HP500/590 / con cambio automatico ZF HP500/590	D 0836 LOH60	213	290	09/03	>			S 2234 Z	
dryer filter / filtro essiccatore	D 0836 LOH60	213	290	09/03	>			S 7259 A	
prefilter SEPAR 2000 / prefiltro SEPAR 2000	D 0836 LOH60	213	290	09/03	>		S 6063 NE		
313 (A72)	D 2866 Euro 2	228	310	09/99	> 08/04	S 7260 PO	S 4378 NR	S 7651 A	
with automatic gearbox ZF HP500/590 / con cambio automatico ZF HP500/590	D 2866 Euro 2	228	310	09/99	> 08/04			S 3439 C	
dryer filter / filtro essiccatore	D 2866 Euro 2	228	310	09/99	> 08/04			S 2234 Z	
								S 7259 A	
313 (A72)	D 2866 LUH Euro 3	228	310	09/01	>	S 7260 PO	S 4378 NR	S 7651 A	
with automatic gearbox ZF HP500/590 / con cambio automatico ZF HP500/590	D 2866 LUH Euro 3	228	310	09/01	>			S 3439 C	
dryer filter / filtro essiccatore	D 2866 LUH Euro 3	228	310	09/01	>			S 2234 Z	
								S 7259 A	
power steering / servosterzo	D 2866 LUH Euro 3	228	310	09/01	>			S 3081 PO	
322	D 2865 LUH 08			05/95	> 07/97	S 7260 PO		S 7431 A	
with automatic gearbox ZF HP500/590 / con cambio automatico ZF HP500/590	D 2865 LUH 08			05/95	> 07/97			S 3439 C	
dryer filter / filtro essiccatore	D 2865 LUH 08			05/95	> 07/97			S 2234 Z	
								S 7259 A	
2 filters / N.2 filtri	D 2865 LUH 08			05/95	> 07/97		S 4378 NR		
prefilter SEPAR 2000 / prefiltro SEPAR 2000	D 2865 LUH 08			05/95	> 07/97		S 6063 NE		
UE Serie									
590	D 0846 HMXH 013			09/75	> 12/77		S 7411 N	S 7987 A	
power steering / servosterzo	D 0846 HMXH 013			09/75	> 12/77			S 3081 PO	
power steering / servosterzo	D 0846 HMXH 013			09/75	> 12/77			S 8790 PO	
UEL Serie									
242	D2866UH	177	241	09/89	> 03/93	S 7260 PO	S 1411 N	S 2650 A	
spin-on / avvitabile	D2866UH	177	241	09/89	> 03/93	S 7260 PO	S 4378 NR	S 2650 A	
with automatic gearbox ZF HP500/590 / con cambio automatico ZF HP500/590	D2866UH	177	241	09/89	> 03/93			S 2234 Z	
dryer filter / filtro essiccatore	D2866UH	177	241	09/89	> 03/93			S 7259 A	
or / oppure	D2866UH	177	241	09/89	> 03/93			S 7432 A	
power steering / servosterzo	D2866UH	177	241	09/89	> 03/93			S 3081 PO	
power steering / servosterzo	D2866UH	177	241	09/89	> 03/93			S 8790 PO	
272	D2865LUH02			03/93	> 11/95	S 7260 PO	S 1411 N	S 2650 A	
spin-on / avvitabile	D2865LUH02			03/93	> 11/95	S 7260 PO	S 4378 NR	S 2650 A	
with automatic gearbox ZF HP500/590 / con cambio automatico ZF HP500/590	D2865LUH02			03/93	> 11/95			S 2234 Z	
dryer filter / filtro essiccatore	D2865LUH02			03/93	> 11/95			S 7259 A	
or / oppure	D2865LUH02			03/93	> 11/95			S 7432 A	
power steering / servosterzo	D2865LUH02			03/93	> 11/95			S 3081 PO	
power steering / servosterzo	D2865LUH02			03/93	> 11/95			S 8790 PO	
283 (R12/R13/R14)	D2066LUH13	206	280	07/06	>	S 5046 PE	S 6011 NE	S 7A11 A	
power steering / servosterzo	D2066LUH13	206	280	07/06	>			S 3081 PO	
292	D2865/D2866			04/89	> 10/95	S 7260 PO	S 1411 N	S 2650 A	
spin-on / avvitabile	D2865/D2866			04/89	> 10/95	S 7260 PO	S 4378 NR	S 2650 A	
dryer filter / filtro essiccatore	D2865/D2866			04/89	> 10/95			S 7259 A	
or / oppure	D2865/D2866			04/89	> 10/95			S 7432 A	
power steering / servosterzo	D2865/D2866			04/89	> 10/95			S 3081 PO	
power steering / servosterzo	D2865/D2866			04/89	> 10/95			S 8790 PO	
312	D2865LUH07			09/95	> 12/97	S 7260 PO	S 4378 NR	S 2650 A	
with automatic gearbox ZF HP500/590 / con cambio automatico ZF HP500/590	D2865LUH07			09/95	> 12/97			S 2234 Z	
dryer filter / filtro essiccatore	D2865LUH07			09/95	> 12/97			S 7259 A	
power steering / servosterzo	D2865LUH07			09/95	> 12/97			S 3081 PO	
power steering / servosterzo	D2865LUH07			09/95	> 12/97			S 8790 PO	
313	D2866LUH20/26			09/96	>	S 7260 PO	S 4378 NR		
dryer filter / filtro essiccatore	D2866LUH20/26			09/96	>			S 7259 A	
314 (R12/R13/R14)	D2866LUH28	228	310	09/04	>	S 7260 PO	S 6016 NE	S 7A23 A	
with activated carbons / ai carboni attivi	D2866LUH28	228	310	09/04	>			S 3165 C	
inner / interno	D2866LUH28	228	310	09/04	>			S 4177 CA	
power steering / servosterzo	D2866LUH28	228	310	09/04	>			S 7616 A	
								S 3081 PO	
353	D2866LUH21			06/97	> 12/01	S 7260 PO	S 4378 NR		
dryer filter / filtro essiccatore	D2866LUH21			06/97	> 12/01			S 7259 A	
353 (R12/R13/R14)	D2066LUH13	257	349	07/06	>	S 5046 PE	S 6011 NE	S 7A11 A	
power steering / servosterzo	D2066LUH13	257	349	07/06	>			S 3081 PO	
363	D2866LUH25	265	361	02/01	> 07/04	S 7260 PO	S 4378 NR	S 7651 A	
dryer filter / filtro essiccatore	D2866LUH25	265	361	02/01	> 07/04			S 7259 A	
power steering / servosterzo	D2866LUH25	265	361	02/01	> 07/04			S 3081 PO	
364 (R12/R13/R14)	D2066LUH CR EEV	265	360	09/07	>	S 5046 PE	S 6011 NE	S 7644 A	
with activated carbons / ai carboni attivi	D2066LUH CR EEV	265	360	09/07	>			S 3165 C	
dryer filter / filtro essiccatore	D2066LUH CR EEV	265	360	09/07	>			S 4177 CA	
prefilter / prefiltro	D2066LUH CR EEV	265	360	09/07	>		S 6088 NE	S 7A66 A	
power steering / servosterzo	D2066LUH CR EEV	265	360	09/07	>			S 3081 PO	
364 (R12/R13/R14)	D2866LUH29	265	360	09/04	>	S 7260 PO	S 6016 NE	S 7A23 A	
with activated carbons / ai carboni attivi	D2866LUH29	265	360	09/04	>			S 3165 C	
								S 4177 CA	



kW HP



...MAN - buses/autobus

inner / interno	D2866LUH29	265	360	09/04	>			S 7616 A	
power steering / servosterzo	D2866LUH29	265	360	09/04	>				S 3081 PO
394 (R12/R13/R14)	D2066LUH13	287	390	09/07	>	S 5046 PE	S 6011 NE	S 7A11 A	
power steering / servosterzo	D2066LUH13	287	390	09/07	>				S 3081 PO
414 (R12/R13/R14)	D2866LUH37	301	409	09/04	>	S 7260 PO	S 6016 NE	S 7A23 A	S 3165 C
with activated carbons / ai carboni attivi	D2866LUH37	301	409	09/04	>				S 4177 CA
inner / interno	D2866LUH37	301	409	09/04	>			S 7616 A	
power steering / servosterzo	D2866LUH37	301	409	09/04	>				S 3081 PO

MENARINI

buses/autobus

102									
102								S 7221 A	
inner / interno								S 7222 A	
201									
201								S 6940 A	
M240									
M240	Iveco 8360.46V					S 5003 DR	S 4329 NR		S 8410 AR
M321									
M 321								S 7221 A	

MERCEDES BENZ

trucks/autocarri

10 t Serie

1013	OM352	96	130	09/65	> 12/77	S 0300 O	S 2161 N	S 1070 A	
	OM352	96	130	01/78	> 05/79	S 5124 PE	S 2161 N	S 1070 A	
power steering / servosterzo	OM352	96	130	09/65	> 05/79				S 3081 PO
power steering / servosterzo	OM352	96	130	09/65	> 05/79				S 8790 PO
1013	OM353	96	130	02/76	> 12/77	S 0300 O	S 2161 N	S 1070 A	
	OM353	96	130	01/78	> 12/86	S 5124 PE	S 2161 N	S 1070 A	
power steering / servosterzo	OM353	96	130	02/76	> 12/86				S 8790 PO
power steering / servosterzo	OM353	96	130	02/76	> 12/86				S 3081 PO
1013 A	OM353	96	130	02/76	> 12/77	S 0300 O	S 2161 N	S 1070 A	
	OM353	96	130	01/78	> 12/86	S 5124 PE	S 2161 N	S 1070 A	
power steering / servosterzo	OM353	96	130	02/76	> 12/86				S 3081 PO
power steering / servosterzo	OM353	96	130	02/76	> 12/86				S 8790 PO
1013 KO	OM353	96	130	02/76	> 12/77	S 0300 O	S 2161 N	S 1070 A	
	OM353	96	130	01/78	> 12/86	S 5124 PE	S 2161 N	S 1070 A	
power steering / servosterzo	OM353	96	130	02/76	> 12/86				S 3081 PO
power steering / servosterzo	OM353	96	130	02/76	> 12/86				S 8790 PO
1013 S	OM353	96	130	02/76	> 12/77	S 0300 O	S 2161 N	S 1070 A	
	OM353	96	130	01/78	> 12/86	S 5124 PE	S 2161 N	S 1070 A	
power steering / servosterzo	OM353	96	130	02/76	> 12/86				S 3081 PO
power steering / servosterzo	OM353	96	130	02/76	> 12/86				S 8790 PO
1017	OM353A	124	168	11/75	> 02/91	S 2530 PO	S 2161 N		
some / alcuni	OM353A	124	168	11/75	> 02/91	S 2530 PO	S 2161 N	S 6370 A	
power steering / servosterzo	OM353A	124	168	11/75	> 02/91				S 3081 PO
power steering / servosterzo	OM353A	124	168	11/75	> 02/91				S 8790 PO
1017 A	OM353A	124	168	11/75	> 02/91	S 2530 PO	S 2161 N		
some / alcuni	OM353A	124	168	11/75	> 02/91	S 2530 PO	S 2161 N	S 6370 A	
power steering / servosterzo	OM353A	124	168	11/75	> 02/91				S 3081 PO
power steering / servosterzo	OM353A	124	168	11/75	> 02/91				S 8790 PO
1017 AF	OM353A	124	168	11/75	> 02/91	S 2530 PO	S 2161 N		
some / alcuni	OM353A	124	168	11/75	> 02/91	S 2530 PO	S 2161 N	S 6370 A	
power steering / servosterzo	OM353A	124	168	11/75	> 02/91				S 3081 PO
power steering / servosterzo	OM353A	124	168	11/75	> 02/91				S 8790 PO
1017 F	OM353A	124	168	11/75	> 02/91	S 2530 PO	S 2161 N		
some / alcuni	OM353A	124	168	11/75	> 02/91	S 2530 PO	S 2161 N	S 6370 A	
power steering / servosterzo	OM353A	124	168	11/75	> 02/91				S 3081 PO
power steering / servosterzo	OM353A	124	168	11/75	> 02/91				S 8790 PO
1017 KO	OM353A	124	168	11/75	> 02/91	S 2530 PO	S 2161 N		
some / alcuni	OM353A	124	168	11/75	> 02/91	S 2530 PO	S 2161 N	S 6370 A	
power steering / servosterzo	OM353A	124	168	11/75	> 02/91				S 3081 PO
power steering / servosterzo	OM353A	124	168	11/75	> 02/91				S 8790 PO
1017 LS	OM353A	124	168	11/75	> 02/91	S 2530 PO	S 2161 N		
some / alcuni	OM353A	124	168	11/75	> 02/91	S 2530 PO	S 2161 N	S 6370 A	
power steering / servosterzo	OM353A	124	168	11/75	> 02/91				S 3081 PO
power steering / servosterzo	OM353A	124	168	11/75	> 02/91				S 8790 PO
L 1013	OM352	96	130	09/65	> 12/77	S 0300 O	S 2161 N	S 1070 A	

M



**kW HP****...MERCEDES BENZ - trucks/autocarri**

	OM352	96	130	01/78 > 05/79	S 5124 PE	S 2161 N	S 1070 A	
power steering / servosterzo	OM352	96	130	09/65 > 05/79				S 3081 PO
power steering / servosterzo	OM352	96	130	09/65 > 05/79				S 8790 PO
LP 1013	OM352	96	130	09/65 > 12/77	S 0300 O	S 2161 N	S 1070 A	
	OM352	96	130	01/78 > 05/79	S 5124 PE	S 2161 N	S 1070 A	
power steering / servosterzo	OM352	96	130	09/65 > 05/79				S 8790 PO
power steering / servosterzo	OM352	96	130	02/76 > 12/86				S 3081 PO
LP 1013	OM353	96	130	02/76 > 12/77	S 0300 O	S 2161 N	S 1070 A	
	OM353	96	130	01/78 > 12/86	S 5124 PE	S 2161 N	S 1070 A	
some / alcuni	OM353	96	130	02/76 > 12/77	S 0300 O	S 2161 N	S 5270 A	
some / alcuni	OM353	96	130	02/76 > 12/77	S 0300 O	S 2161 N	S 2450 A	
some / alcuni	OM353	96	130	01/78 > 12/86	S 5124 PE	S 2161 N	S 5270 A	
some / alcuni	OM353	96	130	01/78 > 12/86	S 5124 PE	S 2161 N	S 2450 A	
power steering / servosterzo	OM353	96	130	02/76 > 12/86				S 3081 PO
power steering / servosterzo	OM353	96	130	02/76 > 12/86				S 8790 PO
LPK 1013	OM353	96	130	02/76 > 12/77	S 0300 O	S 2161 N	S 1070 A	
	OM353	96	130	01/78 > 12/86	S 5124 PE	S 2161 N	S 1070 A	
some / alcuni	OM353	96	130	02/76 > 12/77	S 0300 O	S 2161 N	S 2450 A	
some / alcuni	OM353	96	130	02/76 > 12/77	S 0300 O	S 2161 N	S 5270 A	
some / alcuni	OM353	96	130	01/78 > 12/86	S 5124 PE	S 2161 N	S 2450 A	
some / alcuni	OM353	96	130	01/78 > 12/86	S 5124 PE	S 2161 N	S 5270 A	
power steering / servosterzo	OM353	96	130	02/76 > 12/86				S 8790 PO
power steering / servosterzo	OM353	96	130	02/76 > 12/86				S 3081 PO
LPL 1013	OM353	96	130	02/76 > 12/77	S 0300 O	S 2161 N	S 1070 A	
	OM353	96	130	01/78 > 12/86	S 5124 PE	S 2161 N	S 1070 A	
some / alcuni	OM353	96	130	02/76 > 12/77	S 0300 O	S 2161 N	S 2450 A	
some / alcuni	OM353	96	130	02/76 > 12/77	S 0300 O	S 2161 N	S 5270 A	
some / alcuni	OM353	96	130	01/78 > 12/86	S 5124 PE	S 2161 N	S 2450 A	
some / alcuni	OM353	96	130	01/78 > 12/86	S 5124 PE	S 2161 N	S 5270 A	
power steering / servosterzo	OM353	96	130	02/76 > 12/86				S 8790 PO
power steering / servosterzo	OM353	96	130	02/76 > 12/86				S 3081 PO
11 t Serie								
1113	OM352	96	130	10/69 > 12/77	S 0300 O	S 2161 N		
	OM352	96	130	01/78 > 02/01	S 5124 PE	S 2161 N		
some / alcuni	OM352	96	130	10/69 > 12/77	S 5124 PE	S 2161 N	S 1070 A	
some / alcuni	OM352	96	130	01/78 > 02/01	S 2530 PO	S 2161 N	S 1070 A	
power steering / servosterzo	OM352	96	130	10/69 > 02/01				S 8790 PO
power steering / servosterzo	OM352	96	130	10/69 > 02/01				S 3081 PO
1113	OM353A (352)	96	130	01/72 > 02/01	S 2530 PO	S 2161 N	S 6370 A	
some / alcuni	OM353A (352)	96	130	01/72 > 02/01	S 2530 PO	S 2161 N	S 7998 A	
power steering / servosterzo	OM353A (352)	96	130	01/72 > 02/01				S 3081 PO
power steering / servosterzo	OM353A (352)	96	130	01/72 > 02/01				S 8790 PO
1114								
to engine No. 286114 / a motore N. 286114	OM356 (366)	100	136		S 5099 PE	S 2161 N	S 5250 A	
from engine No. 286115 / da motore N. 286115	OM356 (366)	100	136		S 5131 PE	S 2161 N	S 5250 A	
dryer filter / filtro essiccatore	OM356 (366)	100	136					S 7259 A
power steering / servosterzo	OM356 (366)	100	136					S 3081 PO
1114	OM364LA	100	136	10/94 >	S 5099 PE	S 2161 N	S 3059 A	
dryer filter / filtro essiccatore	OM364LA	100	136	10/94 >				S 7259 A
power steering / servosterzo	OM364LA	100	136	10/94 >				S 3081 PO
1114								
to engine No. 916577 / a motore N. 916577	OM366	100	136	03/84 > 09/88	S 5124 PE	S 2161 N	S 5250 A	
from engine No. 916578 / da motore N. 916578	OM366	100	136	10/88 > 02/93	S 5099 PE	S 2161 N	S 5250 A	
dryer filter / filtro essiccatore	OM366	100	136	01/85 > 02/93				S 7259 A
power steering / servosterzo	OM366	100	136	03/84 > 02/93				S 3081 PO
1114								
to engine No. 933107 / a motore N. 933107	OM366.918	100	136		S 5124 PE	S 2161 N		
from engine No. 933108 / da motore N. 933108	OM366.918	100	136		S 5099 PE	S 2161 N		
dryer filter / filtro essiccatore	OM366.918	100	136	01/85 > 02/93				S 7259 A
power steering / servosterzo	OM366.918	100	136	03/84 > 02/93				S 3081 PO
1114 AK								
to engine No. 916577 / a motore N. 916577	OM366	100	136	03/84 > 09/88	S 5124 PE	S 2161 N	S 5250 A	
from engine No. 916578 / da motore N. 916578	OM366	100	136	10/88 > 02/93	S 5099 PE	S 2161 N	S 5250 A	
dryer filter / filtro essiccatore	OM366	100	136	01/85 > 02/93				S 7259 A
power steering / servosterzo	OM366	100	136	03/84 > 02/93				S 3081 PO
1114 AK								
to engine No. 933107 / a motore N. 933107	OM366.918	100	136		S 5124 PE	S 2161 N		

**KW HP****...MERCEDES BENZ - trucks/autocarri**

from engine No. 933108 / da motore N. 933108	OM366.918	100	136		S 5099 PE	S 2161 N			S 7259 A
dryer filter / filtro essiccatore	OM366.918	100	136	01/85 > 02/93					S 3081 PO
power steering / servosterzo	OM366.918	100	136	03/84 > 02/93					
1114 L/LO									
to engine No. 916577 / a motore N. 916577	OM366	100	136	03/84 > 09/88	S 5124 PE	S 2161 N	S 5250 A		
from engine No. 916578 / da motore N. 916578	OM366	100	136	10/88 > 02/93	S 5099 PE	S 2161 N	S 5250 A		
dryer filter / filtro essiccatore	OM366	100	136	01/85 > 02/93					S 7259 A
power steering / servosterzo	OM366	100	136	03/84 > 02/93					S 3081 PO
1117									
to engine No. 286114 / a motore N. 286114	OM356A (366)	125	170	02/92 >	S 5124 PE	S 2161 N	S 2650 A		
some / alcuni	OM356A (366)	125	170	02/92 > 12/98	S 5131 PE	S 2161 N	S 9570 A		
some / alcuni	OM356A (366)	125	170	02/92 > 12/98	S 5099 PE	S 2161 N	S 6370 A		
from engine No. 286115 / da motore N. 286115	OM356A (366)	125	170	02/92 > 12/98	S 5132 PE	S 2161 N	S 2650 A		
dryer filter / filtro essiccatore	OM356A (366)	125	170	02/92 > 12/98					S 7259 A
power steering / servosterzo	OM356A (366)	125	170	02/92 > 12/98					S 3081 PO
1117									
dryer filter / filtro essiccatore	OM357LA (366)	125	170	03/94 > 12/98	S 5132 PE	S 2161 N	S 2650 A		✗
power steering / servosterzo	OM357LA (366)	125	170	03/94 > 12/98					S 7259 A
	OM357LA (366)	125	170	03/94 > 12/98					S 3081 PO
1117									
to engine No. 286114 / a motore N. 286114	OM366.941/947A	125	170	02/92 >	S 5124 PE	S 2161 N	S 2650 A		
some / alcuni	OM366.941/947A	125	170	02/92 > 12/98	S 5099 PE	S 2161 N	S 6370 A		
some / alcuni	OM366.941/947A	125	170	02/92 > 12/98	S 5131 PE	S 2161 N	S 9570 A		
from engine No. 286115 / da motore N. 286115	OM366.941/947A	125	170	> 12/98	S 5132 PE	S 2161 N	S 2650 A		
dryer filter / filtro essiccatore	OM366.941/947A	125	170	02/92 > 12/98					S 7259 A
power steering / servosterzo	OM366.941/947A	125	170	02/92 > 12/98					S 3081 PO
1117									
to engine No. 923826 / a motore N. 923826	OM366A	125	170	04/84 > 09/88	S 8260 PO	S 2161 N	S 2650 A		
some / alcuni	OM366A	125	170	04/84 > 12/92		S 2161 N	S 6370 A		
some / alcuni	OM366A	125	170	01/89 > 12/92		S 2161 N	S 9570 A		
some / alcuni	OM366A	125	170	01/92 > 12/92	S 5099 PE	S 2161 N	S 2650 A		
from engine No. 923827 / da motore N. 923827	OM366A	125	170	10/88 > 12/92	S 5124 PE	S 2161 N	S 2650 A		
dryer filter / filtro essiccatore	OM366A	125	170	01/85 > 12/92					S 7259 A
power steering / servosterzo	OM366A	125	170	04/84 > 12/92					S 3081 PO
1117									
dryer filter / filtro essiccatore	OM904LA	125	170	03/96 >	S 5007 PE	S 6017 NE	S 2650 A		
power steering / servosterzo	OM904LA	125	170	03/96 >					S 7259 A
	OM904LA	125	170	03/96 >					S 3081 PO
1117 A									
to engine No. 923826 / a motore N. 923826	OM356A (366)	125	170	06/87 >	S 8260 PO	S 2161 N	S 2650 A		
some / alcuni	OM356A (366)	125	170	06/87 > 12/92		S 2161 N	S 6370 A		
some / alcuni	OM356A (366)	125	170	01/89 > 12/92		S 2161 N	S 9570 A		
some / alcuni	OM356A (366)	125	170	01/92 > 12/92	S 5099 PE	S 2161 N	S 2650 A		
from engine No. 923827 / da motore N. 923827	OM356A (366)	125	170	> 12/92	S 5124 PE	S 2161 N	S 2650 A		
dryer filter / filtro essiccatore	OM356A (366)	125	170	06/87 > 12/92					S 7259 A
power steering / servosterzo	OM356A (366)	125	170	06/87 > 12/92					S 3081 PO
1117 A									
dryer filter / filtro essiccatore	OM357LA (366)	125	170	03/94 > 12/98	S 5132 PE	S 2161 N	S 2650 A		✗
power steering / servosterzo	OM357LA (366)	125	170	03/94 > 12/98					S 7259 A
	OM357LA (366)	125	170	03/94 > 12/98					S 3081 PO
1117 A									
to engine No. 286114 / a motore N. 286114	OM366.941/947A	125	170	02/92 >	S 5124 PE	S 2161 N	S 2650 A		
some / alcuni	OM366.941/947A	125	170	02/92 > 12/98	S 5131 PE	S 2161 N	S 9570 A		
some / alcuni	OM366.941/947A	125	170	02/92 > 12/98	S 5099 PE	S 2161 N	S 6370 A		
from engine No. 286115 / da motore N. 286115	OM366.941/947A	125	170	> 12/98	S 5132 PE	S 2161 N	S 2650 A		
dryer filter / filtro essiccatore	OM366.941/947A	125	170	02/92 > 12/98					S 7259 A
power steering / servosterzo	OM366.941/947A	125	170	02/92 > 12/98					S 3081 PO
1117 A									
to engine No. 923826 / a motore N. 923826	OM366A	125	170	04/84 > 09/88	S 8260 PO	S 2161 N	S 2650 A		
some / alcuni	OM366A	125	170	04/84 > 12/92		S 2161 N	S 6370 A		
some / alcuni	OM366A	125	170	01/89 > 12/92		S 2161 N	S 9570 A		
some / alcuni	OM366A	125	170	01/92 > 12/92	S 5099 PE	S 2161 N	S 2650 A		
from engine No. 923827 / da motore N. 923827	OM366A	125	170	10/88 > 12/92	S 5124 PE	S 2161 N	S 2650 A		
dryer filter / filtro essiccatore	OM366A	125	170	01/85 > 12/92					S 7259 A
power steering / servosterzo	OM366A	125	170	04/84 > 12/92					S 3081 PO
1117 L									
to engine No. 286114 / a motore N. 286114	OM356A (366)	125	170	02/92 >	S 5124 PE	S 2161 N	S 2650 A		
some / alcuni	OM356A (366)	125	170	02/92 > 12/98	S 5099 PE	S 2161 N	S 6370 A		
some / alcuni	OM356A (366)	125	170	02/92 > 12/98		S 2161 N	S 9570 A		
from engine No. 286115 / da motore N. 286115	OM356A (366)	125	170	> 12/98	S 5132 PE	S 2161 N	S 2650 A		

M



kW HP



...MERCEDES BENZ - trucks/autocarri

M



dryer filter / filtro essiccatore	OM356A (366)	125	170	02/92 >	12/98				S 7259 A
power steering / servosterzo	OM356A (366)	125	170	02/92 >	12/98				S 3081 PO
1117 L	OM357LA (366)	125	170	03/94 >	12/98	S 5132 PE	S 2161 N	S 2650 A	X
dryer filter / filtro essiccatore	OM357LA (366)	125	170	03/94 >	12/98				S 7259 A
power steering / servosterzo	OM357LA (366)	125	170	03/94 >	12/98				S 3081 PO
1117 L									
to engine No. 286114 / a motore N. 286114	OM366.941/947A	125	170			S 5124 PE	S 2161 N	S 2650 A	
some / alcuni	OM366.941/947A	125	170				S 2161 N	S 9570 A	
some / alcuni	OM366.941/947A	125	170			S 5099 PE	S 2161 N	S 6370 A	
from engine No. 286115 / da motore N. 286115	OM366.941/947A	125	170				S 2161 N	S 2650 A	
dryer filter / filtro essiccatore	OM366.941/947A	125	170						S 7259 A
power steering / servosterzo	OM366.941/947A	125	170						S 3081 PO
1117 L									
to engine No. 923826 / a motore N. 923826	OM366A	125	170	04/84 >	09/88	S 8260 PO	S 2161 N	S 2650 A	
some / alcuni	OM366A	125	170	04/84 >	12/92		S 2161 N	S 6370 A	
some / alcuni	OM366A	125	170	01/89 >	12/92		S 2161 N	S 9570 A	
some / alcuni	OM366A	125	170	01/92 >	12/92	S 5099 PE	S 2161 N	S 2650 A	
from engine No. 923827 / da motore N. 923827	OM366A	125	170	10/88 >	12/92	S 5124 PE	S 2161 N	S 2650 A	
dryer filter / filtro essiccatore	OM366A	125	170	01/85 >	12/92				S 7259 A
power steering / servosterzo	OM366A	125	170	04/84 >	12/92				S 3081 PO
1117 L	OM904LA	125	170	03/96 >		S 5007 PE		S 2650 A	
dryer filter / filtro essiccatore	OM904LA	125	170	03/96 >					S 7259 A
power steering / servosterzo	OM904LA	125	170	03/96 >					S 3081 PO
1117 LO									
to engine No. 286114 / a motore N. 286114	OM356A (366)	125	170	02/92 >		S 5124 PE	S 2161 N	S 2650 A	
some / alcuni	OM356A (366)	125	170				S 2161 N	S 9570 A	
some / alcuni	OM356A (366)	125	170	02/92 >		S 5099 PE	S 2161 N	S 6370 A	
from engine No. 286115 / da motore N. 286115	OM356A (366)	125	170	02/92 >			S 2161 N	S 2650 A	
dryer filter / filtro essiccatore	OM356A (366)	125	170						S 7259 A
power steering / servosterzo	OM356A (366)	125	170						S 3081 PO
1117 LO	OM357LA (366)	125	170	03/94 >	12/98	S 5132 PE	S 2161 N	S 2650 A	X
some / alcuni	OM357LA (366)	125	170	03/94 >	12/98			S 4940 A	X
dryer filter / filtro essiccatore	OM357LA (366)	125	170	03/94 >	12/98				S 7259 A
power steering / servosterzo	OM357LA (366)	125	170	03/94 >	12/98				S 3081 PO
1117 LO	OM904LA	125	170	03/96 >		S 5007 PE		S 2650 A	
dryer filter / filtro essiccatore	OM904LA	125	170	03/96 >					S 7259 A
power steering / servosterzo	OM904LA	125	170	03/96 >					S 3081 PO
1120									
to engine No. 286114 / a motore N. 286114	OM356LA (366)	155	211			S 5124 PE	S 2161 N	S 2650 A	
some / alcuni	OM356LA (366)	155	211	02/92 >			S 2161 N	S 6370 A	
from engine No. 286115 / da motore N. 286115	OM356LA (366)	155	211				S 2161 N	S 2650 A	
dryer filter / filtro essiccatore	OM356LA (366)	155	211	02/92 >					S 7259 A
power steering / servosterzo	OM356LA (366)	155	211	02/92 >					S 3081 PO
1120									
to engine No. 286114 / a motore N. 286114	OM357LA (366)	155	211			S 5124 PE	S 2161 N	S 2650 A	
some / alcuni	OM357LA (366)	155	211	06/94 >			S 2161 N	S 6370 A	
from engine No. 286115 / da motore N. 286115	OM357LA (366)	155	211				S 2161 N	S 2650 A	
dryer filter / filtro essiccatore	OM357LA (366)	155	211	06/94 >					S 7259 A
power steering / servosterzo	OM357LA (366)	155	211	06/94 >					S 3081 PO
1120									
to engine No. 923826 / a motore N. 923826	OM366LA	155	211	06/84 >	09/88	S 8260 PO	S 2161 N	S 2650 A	
with threaded case cover / con il coperchio del contenitore filettato	OM366LA	155	211				S 2161 N	S 6370 A	
from engine No. 923827 / da motore N. 923827	OM366LA	155	211	10/88 >	02/93	S 5124 PE	S 2161 N	S 2650 A	
dryer filter / filtro essiccatore	OM366LA	155	211	06/84 >	02/93				S 7259 A
power steering / servosterzo	OM366LA	155	211	06/84 >	02/93				S 3081 PO
1120	OM904LA	155	211	03/96 >	12/98	S 5007 PE	S 6017 NE	S 2650 A	
dryer filter / filtro essiccatore	OM904LA	155	211	03/96 >	12/98				S 7259 A
power steering / servosterzo	OM904LA	155	211	03/96 >	12/98				S 3081 PO
1120 AF									
to engine No. 286114 / a motore N. 286114	OM356LA (366)	155	211			S 5124 PE	S 2161 N	S 2650 A	
some / alcuni	OM356LA (366)	155	211	02/92 >			S 2161 N	S 6370 A	
from engine No. 286115 / da motore N. 286115	OM356LA (366)	155	211				S 2161 N	S 2650 A	
dryer filter / filtro essiccatore	OM356LA (366)	155	211	02/92 >					S 7259 A
power steering / servosterzo	OM356LA (366)	155	211	02/92 >					S 3081 PO
1120 AF									
to engine No. 923826 / a motore N. 923826	OM366LA	155	211	06/84 >	09/88	S 8260 PO	S 2161 N	S 2650 A	
some / alcuni	OM366LA	155	211	06/84 >	02/93		S 2161 N	S 6370 A	

**KW HP****...MERCEDES BENZ - trucks/autocarri**

with threaded case cover / con il coperchio del contenitore filettato	OM366LA	155	211						
from engine No. 923827 / da motore N. 923827	OM366LA	155	211	10/88 >	02/93	S 5124 PE	S 2161 N	S 2650 A	
dryer filter / filtro essiccatore	OM366LA	155	211	06/84 >	02/93				S 7259 A
power steering / servosterzo	OM366LA	155	211	06/84 >	02/93				S 3081 PO
1120 F									
to engine No. 286114 / a motore N. 286114	OM356LA (366)	155	211			S 5124 PE	S 2161 N	S 2650 A	
some / alcuni	OM356LA (366)	155	211	02/92 >			S 2161 N	S 6370 A	
from engine No. 286115 / da motore N. 286115	OM356LA (366)	155	211				S 2161 N	S 2650 A	
dryer filter / filtro essiccatore	OM356LA (366)	155	211	02/92 >					S 7259 A
power steering / servosterzo	OM356LA (366)	155	211	02/92 >					S 3081 PO
1120 F									
to engine No. 923826 / a motore N. 923826	OM366LA	155	211	06/84 >	09/88	S 8260 PO	S 2161 N	S 2650 A	
with threaded case cover / con il coperchio del contenitore filettato	OM366LA	155	211				S 2161 N	S 6370 A	
from engine No. 923827 / da motore N. 923827	OM366LA	155	211	10/88 >	02/93	S 5124 PE	S 2161 N	S 2650 A	
dryer filter / filtro essiccatore	OM366LA	155	211	06/84 >	02/93				S 7259 A
power steering / servosterzo	OM366LA	155	211	06/84 >	02/93				S 3081 PO
1120 L									
to engine No. 286114 / a motore N. 286114	OM356LA (366)	155	211			S 5124 PE	S 2161 N	S 2650 A	
some / alcuni	OM356LA (366)	155	211	02/92 >			S 2161 N	S 6370 A	
from engine No. 286115 / da motore N. 286115	OM356LA (366)	155	211				S 2161 N	S 2650 A	
dryer filter / filtro essiccatore	OM356LA (366)	155	211	02/92 >					S 7259 A
power steering / servosterzo	OM356LA (366)	155	211	02/92 >					S 3081 PO
1120 L									
to engine No. 286114 / a motore N. 286114	OM357LA (366)	155	211			S 5124 PE	S 2161 N	S 2650 A	
some / alcuni	OM357LA (366)	155	211	06/94 >			S 2161 N	S 6370 A	
from engine No. 286115 / da motore N. 286115	OM357LA (366)	155	211				S 2161 N	S 2650 A	
dryer filter / filtro essiccatore	OM357LA (366)	155	211	06/94 >					S 7259 A
power steering / servosterzo	OM357LA (366)	155	211	06/94 >					S 3081 PO
1120 L									
to engine No. 923826 / a motore N. 923826	OM366LA	155	211	06/84 >	09/88	S 8260 PO	S 2161 N	S 2650 A	
some / alcuni	OM366LA	155	211	06/84 >	02/93		S 2161 N	S 6370 A	
with threaded case cover / con il coperchio del contenitore filettato	OM366LA	155	211				S 2161 N		
from engine No. 923827 / da motore N. 923827	OM366LA	155	211	10/88 >	02/93	S 5124 PE	S 2161 N	S 2650 A	
dryer filter / filtro essiccatore	OM366LA	155	211	06/84 >	02/93				S 7259 A
power steering / servosterzo	OM366LA	155	211	06/84 >	02/93				S 3081 PO
1120 LO									
to engine No. 286114 / a motore N. 286114	OM356LA (366)	155	211			S 5124 PE	S 2161 N	S 2650 A	
some / alcuni	OM356LA (366)	155	211	02/92 >			S 2161 N	S 6370 A	
from engine No. 286115 / da motore N. 286115	OM356LA (366)	155	211				S 2161 N	S 2650 A	
dryer filter / filtro essiccatore	OM356LA (366)	155	211	02/92 >					S 7259 A
power steering / servosterzo	OM356LA (366)	155	211	02/92 >					S 3081 PO
1120 O									
to engine No. 286114 / a motore N. 286114	OM356LA (366)	155	211			S 5124 PE	S 2161 N	S 2650 A	
some / alcuni	OM356LA (366)	155	211	02/92 >			S 2161 N	S 6370 A	
from engine No. 286115 / da motore N. 286115	OM356LA (366)	155	211				S 2161 N	S 2650 A	
dryer filter / filtro essiccatore	OM356LA (366)	155	211	02/92 >					S 7259 A
power steering / servosterzo	OM356LA (366)	155	211	02/92 >					S 3081 PO
1124									
to engine No. 286114 / a motore N. 286114	OM357LA (366)	177	240			S 5124 PE	S 2161 N	S 2650 A	
some / alcuni	OM357LA (366)	177	240	06/94 >			S 2161 N	S 7187 A	
some / alcuni	OM357LA (366)	177	240	06/94 >			S 2161 N	S 6370 A	
from engine No. 286115 / da motore N. 286115	OM357LA (366)	177	240				S 2161 N	S 2650 A	
dryer filter / filtro essiccatore	OM357LA (366)	177	240	06/94 >					S 7259 A
power steering / servosterzo	OM357LA (366)	177	240	06/94 >					S 3081 PO
1124									
to engine No. 286114 / a motore N. 286114	OM366LA	177	240			S 5124 PE	S 2161 N	S 2650 A	
some / alcuni	OM366LA	177	240	03/92 >			S 2161 N	S 7187 A	
some / alcuni	OM366LA	177	240	03/92 >			S 2161 N	S 6370 A	
from engine No. 286115 / da motore N. 286115	OM366LA	177	240				S 2161 N	S 2650 A	
dryer filter / filtro essiccatore	OM366LA	177	240	03/92 >					S 7259 A
power steering / servosterzo	OM366LA	177	240	03/92 >					S 3081 PO
1124 AF									
to engine No. 286114 / a motore N. 286114	OM357LA (366)	177	240	03/92 >		S 5124 PE	S 2161 N	S 2650 A	
some / alcuni	OM357LA (366)	177	240	06/94 >			S 2161 N	S 7187 A	
some / alcuni	OM357LA (366)	177	240	06/94 >			S 2161 N	S 6370 A	
from engine No. 286115 / da motore N. 286115	OM357LA (366)	177	240		> 12/98		S 2161 N	S 2650 A	
dryer filter / filtro essiccatore	OM357LA (366)	177	240	06/94 >					S 7259 A

M

**KW HP****...MERCEDES BENZ - trucks/autocarri****M**

power steering / servosterzo	OM357LA (366)	177	240	06/94	>				S 3081 PO
1124 AF									
to engine No. 286114 / a motore N. 286114	OM366LA	177	240			S 5124 PE	S 2161 N	S 2650 A	
some / alcuni	OM366LA	177	240	03/92	>		S 2161 N	S 6370 A	
some / alcuni	OM366LA	177	240	03/92	>		S 2161 N	S 7187 A	
from engine No. 286115 / da motore N. 286115	OM366LA	177	240				S 2161 N	S 2650 A	
dryer filter / filtro essiccatore	OM366LA	177	240	03/92	>				S 7259 A
power steering / servosterzo	OM366LA	177	240	03/92	>				S 3081 PO
1124 F									
to engine No. 286114 / a motore N. 286114	OM357LA (366)	177	240	03/92	>	S 5124 PE	S 2161 N	S 2650 A	
some / alcuni	OM357LA (366)	177	240	06/94	>		S 2161 N	S 7187 A	
some / alcuni	OM357LA (366)	177	240	06/94	>		S 2161 N	S 6370 A	
from engine No. 286115 / da motore N. 286115	OM357LA (366)	177	240		> 12/98		S 2161 N	S 2650 A	
dryer filter / filtro essiccatore	OM357LA (366)	177	240	06/94	>				S 7259 A
power steering / servosterzo	OM357LA (366)	177	240	06/94	>				S 3081 PO
1124 F									
to engine No. 286114 / a motore N. 286114	OM366LA	177	240	03/92	>	S 5124 PE	S 2161 N	S 2650 A	
some / alcuni	OM366LA	177	240	03/92	> 12/98		S 2161 N	S 6370 A	
some / alcuni	OM366LA	177	240	03/92	> 12/98		S 2161 N	S 7187 A	
from engine No. 286115 / da motore N. 286115	OM366LA	177	240		> 12/98	S 5132 PE	S 2161 N	S 2650 A	
dryer filter / filtro essiccatore	OM366LA	177	240	03/92	> 12/98				S 7259 A
power steering / servosterzo	OM366LA	177	240	03/92	> 12/98				S 3081 PO
L 1113									
some / alcuni	OM353A (352)	96	130	01/72	> 02/01	S 2530 PO	S 2161 N	S 6370 A	
power steering / servosterzo	OM353A (352)	96	130	01/72	> 02/01	S 2530 PO	S 2161 N	S 7998 A	
power steering / servosterzo	OM353A (352)	96	130	01/72	> 02/01				S 8790 PO
power steering / servosterzo	OM353A (352)	96	130	01/72	> 02/01				S 3081 PO
LA 1113									
	OM352	96	130	10/69	> 12/77	S 0300 O	S 2161 N	S 1070 A	
	OM352	96	130	01/78	> 02/01	S 5124 PE	S 2161 N	S 1070 A	
power steering / servosterzo	OM352	96	130	10/69	> 02/01				S 8790 PO
power steering / servosterzo	OM352	96	130	10/69	> 02/01				S 3081 PO
LA 1113									
	OM353A (352)	96	130	01/72	> 02/01	S 2530 PO	S 2161 N	S 6370 A	
some / alcuni	OM353A (352)	96	130	01/72	> 02/01	S 2530 PO	S 2161 N	S 7998 A	
power steering / servosterzo	OM353A (352)	96	130	01/72	> 02/01				S 3081 PO
power steering / servosterzo	OM353A (352)	96	130	01/72	> 02/01				S 8790 PO
LKO 1113 B									
	OM352	96	130	10/69	> 12/77	S 0300 O	S 2161 N	S 1070 A	
	OM352	96	130	01/78	> 02/01	S 5124 PE	S 2161 N	S 1070 A	
power steering / servosterzo	OM352	96	130	10/69	> 02/01				S 3081 PO
power steering / servosterzo	OM352	96	130	10/69	> 02/01				S 8790 PO
OF 1113									
	OM352.997/998	96	130	01/75	> 12/77	S 0300 O	S 2162 N		
	OM352.997/998	96	130	01/78	> 12/92	S 5124 PE	S 2162 N		
power steering / servosterzo	OM352.997/998	96	130	01/75	> 02/01				S 3081 PO
power steering / servosterzo	OM352.997/998	96	130	01/75	> 02/01				S 8790 PO
12 t Serie									
1213									
some / alcuni	OM352	93	126	09/65	> 12/66	S 0300 O	S 2161 N	S 2450 A	
power steering / servosterzo	OM352	93	126	09/65	> 12/66	S 0300 O	S 2162 N	S 2450 A	
power steering / servosterzo	OM352	93	126	09/65	> 12/66				S 8790 PO
power steering / servosterzo	OM352	93	126	09/66	> 12/66				S 3081 PO
1213									
	OM353	96	130	09/75	> 12/77	S 0300 O	S 2161 N	S 1070 A	
	OM353	96	130	01/78	> 05/86	S 5124 PE	S 2161 N	S 1070 A	
some / alcuni	OM353	96	130	09/75	> 12/77	S 0300 O	S 2162 N	S 1070 A	
some / alcuni	OM353	96	130	01/78	> 05/86	S 5124 PE	S 2162 N	S 1070 A	
power steering / servosterzo	OM353	96	130	09/75	> 05/86				S 3081 PO
power steering / servosterzo	OM353	96	130	09/75	> 05/86				S 8790 PO
1213 AK									
	OM353	96	130	09/75	> 12/77	S 0300 O	S 2161 N	S 1070 A	
	OM353	96	130	09/75	> 12/77	S 0300 O	S 2162 N	S 1070 A	
	OM353	96	130	01/78	> 05/86	S 5124 PE	S 2161 N	S 1070 A	
	OM353	96	130	01/78	> 05/86	S 5124 PE	S 2162 N	S 1070 A	
power steering / servosterzo	OM353	96	130	09/75	> 05/86				S 3081 PO
power steering / servosterzo	OM353	96	130	09/75	> 05/86				S 8790 PO
1213 K									
	OM353	96	130	09/75	> 12/77	S 0300 O	S 2161 N	S 1070 A	
	OM353	96	130	01/78	> 05/86	S 5124 PE	S 2161 N	S 1070 A	
some / alcuni	OM353	96	130	09/75	> 12/77	S 5124 PE	S 2162 N	S 1070 A	
some / alcuni	OM353	96	130	01/78	> 05/86	S 5124 PE	S 2162 N	S 1070 A	
power steering / servosterzo	OM353	96	130	09/75	> 05/86				S 3081 PO
power steering / servosterzo	OM353	96	130	09/75	> 05/86				S 8790 PO
1217									
	OM353.950/951	124	168	09/75	> 09/85	S 2530 PO	S 2161 N		
some / alcuni	OM353.950/951	124	168	09/75	> 09/85	S 2530 PO	S 2161 N	S 6370 A	

**kW HP****...MERCEDES BENZ - trucks/autocarri**

power steering / servosterzo	OM353.950/951	124	168	09/75 >	09/85				S 3081 PO
power steering / servosterzo	OM353.950/951	124	168	09/75 >	09/85				S 8790 PO
1217 AK	OM353.950/951	124	168	09/75 >	09/85	S 2530 PO	S 2161 N		
some / alcuni	OM353.950/951	124	168	09/75 >	09/85	S 2530 PO	S 2161 N	S 6370 A	
power steering / servosterzo	OM353.950/951	124	168	09/75 >	09/85				S 3081 PO
power steering / servosterzo	OM353.950/951	124	168	09/75 >	09/85				S 8790 PO
1217 K	OM353.950/951	124	168	09/75 >	09/85	S 2530 PO	S 2161 N		
some / alcuni	OM353.950/951	124	168	09/75 >	09/85	S 2530 PO	S 2161 N	S 6370 A	
power steering / servosterzo	OM353.950/951	124	168	09/75 >	09/85				S 3081 PO
power steering / servosterzo	OM353.950/951	124	168	09/75 >	09/85				S 8790 PO
1219	OM401	141	192	09/75 >	09/84	S 8260 PO	S 2161 N	S 6370 A	
power steering / servosterzo	OM401	141	192	09/75 >	09/84				S 8790 PO
1219 A	OM401	141	192	09/75 >	09/84	S 8260 PO	S 2161 N	S 6370 A	
power steering / servosterzo	OM401	141	192	09/75 >	09/84				S 8790 PO
1219 F	OM401	141	192	09/75 >	09/84	S 8260 PO	S 2161 N	S 6370 A	
power steering / servosterzo	OM401	141	192	09/75 >	09/84				S 8790 PO
1219 K	OM401	141	192	09/75 >	09/84	S 8260 PO	S 2161 N	S 6370 A	
power steering / servosterzo	OM401	141	192	09/75 >	09/84				S 8790 PO
1222	OM421	165	224	05/82 >	02/90	S 7261 PO	S 2162 N	S 6370 A	
1222	OM441	165	224	07/89 >	08/94	S 8260 PO	S 2162 N	S 7185 A	
dryer filter / filtro essiccatore	OM441	165	224	07/89 >	08/94				S 7259 A
power steering / servosterzo	OM441	165	224	07/89 >	08/94				S 3081 PO
1222 A	OM421	165	224	05/82 >	02/90	S 7261 PO	S 2162 N	S 6370 A	
1222 A	OM441	165	224	07/89 >	08/94	S 8260 PO	S 2162 N	S 7185 A	
dryer filter / filtro essiccatore	OM441	165	224	07/89 >	08/94				S 7259 A
power steering / servosterzo	OM441	165	224	07/89 >	08/94				S 3081 PO
1222 AF	OM421	165	224	05/82 >	02/90	S 7261 PO	S 2162 N	S 6370 A	
1222 AF	OM441	165	224	07/89 >	08/94	S 8260 PO	S 2162 N	S 7185 A	
dryer filter / filtro essiccatore	OM441	165	224	07/89 >	08/94				S 7259 A
power steering / servosterzo	OM441	165	224	07/89 >	08/94				S 3081 PO
1224									
to engine No. 286114 / a motore N. 286114	OM356LA (366)	180	245			S 5124 PE	S 2161 N	S 2650 A	
some / alcuni	OM356LA (366)	180	245	02/93 >			S 2161 N	S 6370 A	
from engine No. 286115 / da motore N. 286115	OM356LA (366)	180	245				S 2161 N	S 2650 A	
dryer filter / filtro essiccatore	OM356LA (366)	180	245	02/93 >					S 7259 A
power steering / servosterzo	OM356LA (366)	180	245	02/93 >					S 3081 PO
1224									
to engine No. 286114 / a motore N. 286114	OM357LA (366)	180	245			S 5124 PE	S 2161 N	S 2650 A	
some / alcuni	OM357LA (366)	180	245	01/94 >			S 2161 N	S 6370 A	
from engine No. 286115 / da motore N. 286115	OM357LA (366)	180	245			S 5132 PE	S 2161 N	S 2650 A	
dryer filter / filtro essiccatore	OM357LA (366)	180	245	01/94 >					S 7259 A
power steering / servosterzo	OM357LA (366)	180	245	01/94 >					S 3081 PO
1224	OM401LA	180	245	02/93 >	09/96	S 5133 PE		S 7185 A	X
dryer filter / filtro essiccatore	OM401LA	180	245	02/93 >	09/96				S 7259 A
2 filters / N.2 filtri	OM401LA	180	245	02/93 >	09/96		S 2162 N		
power steering / servosterzo	OM401LA	180	245	02/93 >	09/96				S 3081 PO
1224 AF									
to engine No. 286114 / a motore N. 286114	OM356LA (366)	180	245			S 5124 PE	S 2161 N	S 2650 A	
some / alcuni	OM356LA (366)	180	245	02/93 >			S 2161 N	S 6370 A	
from engine No. 286115 / da motore N. 286115	OM356LA (366)	180	245			S 5132 PE	S 2161 N	S 2650 A	
dryer filter / filtro essiccatore	OM356LA (366)	180	245	02/93 >					S 7259 A
power steering / servosterzo	OM356LA (366)	180	245	02/93 >					S 3081 PO
1224 AF									
to engine No. 286114 / a motore N. 286114	OM357LA (366)	180	245			S 5124 PE	S 2161 N	S 2650 A	
some / alcuni	OM357LA (366)	180	245	01/94 >			S 2161 N	S 6370 A	
from engine No. 286115 / da motore N. 286115	OM357LA (366)	180	245				S 2161 N	S 2650 A	
dryer filter / filtro essiccatore	OM357LA (366)	180	245	01/94 >					S 7259 A
power steering / servosterzo	OM357LA (366)	180	245	01/94 >					S 3081 PO
1224 AF	OM401LA	180	245	02/93 >	09/96	S 5133 PE		S 7185 A	X
dryer filter / filtro essiccatore	OM401LA	180	245	02/93 >	09/96				S 7259 A
2 filters / N.2 filtri	OM401LA	180	245	02/93 >	09/96		S 2162 N		
power steering / servosterzo	OM401LA	180	245	02/93 >	09/96				S 3081 PO
1226	OM401LA	195	265	02/93 >	09/96	S 5133 PE		S 7185 A	X
dryer filter / filtro essiccatore	OM401LA	195	265	02/93 >	09/96				S 7259 A
2 filters / N.2 filtri	OM401LA	195	265	02/93 >	09/96		S 2162 N		
power steering / servosterzo	OM401LA	195	265	02/93 >	09/96				S 3081 PO
1226	OM441.989LA (OM441LA)	195	265	02/93 >	09/96	S 5133 PE		S 7185 A	X

M

**KW HP****...MERCEDES BENZ - trucks/autocarri****M**

dryer filter / filtro essiccatore	OM441.989LA (OM441LA)	195	265	02/93	>	09/96			S 7259 A	
2 filters / N.2 filtri	OM441.989LA (OM441LA)	195	265	02/93	>	09/96		S 2162 N		
power steering / servosterzo	OM441.989LA (OM441LA)	195	265	02/93	>	09/96			S 3081 PO	
1226	OM442	195	265	02/90	>	09/93	S 5133 PE		S 7185 A	✗
some / alcuni	OM442	195	265	02/90	>	08/90	S 8260 PO			
some / alcuni	OM442	195	265	02/90	>	09/93			S 6370 A	
dryer filter / filtro essiccatore	OM442	195	265	02/90	>	09/93				S 7259 A
2 filters / N.2 filtri	OM442	195	265	02/90	>	09/93		S 2162 N		
power steering / servosterzo	OM442	195	265	02/90	>	09/93				S 3081 PO
1226 AF	OM401LA	195	265	02/93	>	09/96	S 5133 PE		S 7185 A	✗
dryer filter / filtro essiccatore	OM401LA	195	265	02/93	>	09/96				S 7259 A
2 filters / N.2 filtri	OM401LA	195	265	02/93	>	09/96		S 2162 N		
power steering / servosterzo	OM401LA	195	265	02/93	>	09/96				S 3081 PO
1226 AF	OM441.989LA (OM441LA)	195	265	02/93	>	09/96	S 5133 PE		S 7185 A	✗
dryer filter / filtro essiccatore	OM441.989LA (OM441LA)	195	265	02/93	>	09/96				S 7259 A
2 filters / N.2 filtri	OM441.989LA (OM441LA)	195	265	02/93	>	09/96		S 2162 N		
power steering / servosterzo	OM441.989LA (OM441LA)	195	265	02/93	>	09/96				S 3081 PO
1226 AF	OM442	195	265	02/90	>	09/93	S 5133 PE		S 7185 A	✗
some / alcuni	OM442	195	265	02/90	>	08/90	S 8260 PO			
some / alcuni	OM442	195	265	02/90	>	09/93			S 6370 A	
dryer filter / filtro essiccatore	OM442	195	265	02/90	>	09/93				S 7259 A
2 filters / N.2 filtri	OM442	195	265	02/90	>	09/93		S 2162 N		
power steering / servosterzo	OM442	195	265	02/90	>	09/93				S 3081 PO
1227	OM401	200	272	01/92	>	07/92	S 5133 PE		S 7185 A	✗
dryer filter / filtro essiccatore	OM401	200	272	01/92	>	07/92				S 7259 A
2 filters / N.2 filtri	OM401	200	272	01/92	>	07/92		S 2162 N		
power steering / servosterzo	OM401	200	272	01/92	>	07/92				S 3081 PO
1227 A	OM401	200	272	01/92	>	07/92	S 5133 PE		S 7185 A	✗
dryer filter / filtro essiccatore	OM401	200	272	01/92	>	07/92				S 7259 A
power steering / servosterzo	OM401	200	272	01/92	>	07/92				S 3081 PO
1234	OM441LA	250	340	01/92	>	09/96	S 5133 PE		S 7185 A	✗
dryer filter / filtro essiccatore	OM441LA	250	340	01/92	>	09/96				S 7259 A
2 filters / N.2 filtri	OM441LA	250	340	01/92	>	09/96		S 2162 N		
power steering / servosterzo	OM441LA	250	340	01/92	>	09/96				S 3081 PO
1234 AF	OM441LA	250	340	01/92	>	09/96	S 5133 PE		S 7185 A	✗
dryer filter / filtro essiccatore	OM441LA	250	340	01/92	>	09/96				S 7259 A
2 filters / N.2 filtri	OM441LA	250	340	01/92	>	09/96		S 2162 N		
power steering / servosterzo	OM441LA	250	340	01/92	>	09/96				S 3081 PO
LP 1213	OM352	93	126	09/65	>	12/66	S 0300 O	S 2161 N	S 2450 A	
some / alcuni	OM352	93	126	09/65	>	12/66	S 0300 O	S 2162 N	S 2450 A	
power steering / servosterzo	OM352	93	126	09/65	>	12/66				S 3081 PO
power steering / servosterzo	OM352	93	126	09/65	>	12/66				S 8790 PO
13 t Serie										
1313	OM352	96	130	01/67	>	12/77	S 0300 O	S 2161 N	S 1070 A	
	OM352	96	130	01/78	>	02/01	S 5124 PE	S 2161 N	S 1070 A	
some / alcuni	OM352	96	130	01/67	>	12/77	S 0300 O	S 2162 N	S 1070 A	
some / alcuni	OM352	96	130	01/78	>	02/01	S 5124 PE	S 2162 N	S 2450 A	
power steering / servosterzo	OM352	96	130	01/67	>	02/01				S 8790 PO
power steering / servosterzo	OM352	96	130	01/67	>	02/01				S 3081 PO
1313	OM352A	96	130	01/85	>	01/87	S 2530 PO	S 2161 N		
some / alcuni	OM352A	96	130	01/85	>	01/87	S 2530 PO	S 2161 N	S 6370 A	
dryer filter / filtro essiccatore	OM352A	96	130	01/85	>	01/87				S 7259 A
power steering / servosterzo	OM352A	96	130	01/85	>	01/87				S 3081 PO
power steering / servosterzo	OM352A	96	130	01/85	>	01/87				S 8790 PO
1314	OM356 (366)	100	136				S 5099 PE	S 2161 N	S 1070 A	
to engine No. 286114 / a motore N. 286114	OM356 (366)	100	136	12/92	>	09/95		S 2161 N	S 6370 A	
some / alcuni	OM356 (366)	100	136					S 2161 N	S 1070 A	
from engine No. 286115 / da motore N. 286115	OM356 (366)	100	136							
dryer filter / filtro essiccatore	OM356 (366)	100	136	12/92	>	09/95				S 7259 A
power steering / servosterzo	OM356 (366)	100	136	12/92	>	09/95				S 3081 PO
1314	OM366	100	136				S 5099 PE	S 2161 N	S 1070 A	
to engine No. 286114 / a motore N. 286114	OM366	100	136	07/84	>	02/93		S 2161 N	S 6370 A	
some / alcuni	OM366	100	136					S 2161 N	S 1070 A	
from engine No. 286115 / da motore N. 286115	OM366	100	136							
dryer filter / filtro essiccatore	OM366	100	136	07/84	>	02/93				S 7259 A
power steering / servosterzo	OM366	100	136	07/84	>	02/93				S 3081 PO
1314										



KW HP



...MERCEDES BENZ - trucks/autocarri

to engine No. 933107 / a motore N. 933107	OM366.918	100	136		S 5124 PE	S 2161 N	S 5250 A		
some / alcuni	OM366.918	100	136	06/87 > 02/93		S 2161 N	S 5250 A		
from engine No. 933108 / da motore N. 933108	OM366.918	100	136		S 5099 PE	S 2161 N	S 5250 A		
dryer filter / filtro essiccatore	OM366.918	100	136	06/87 > 02/93				S 7259 A	
power steering / servosterzo	OM366.918	100	136	06/87 > 02/93				S 3081 PO	
1314 AK									
to engine No. 286114 / a motore N. 286114	OM356 (366)	100	136		S 5099 PE	S 2161 N	S 1070 A		
some / alcuni	OM356 (366)	100	136	12/92 > 09/95		S 2161 N	S 6370 A		
from engine No. 286115 / da motore N. 286115	OM356 (366)	100	136			S 2161 N	S 1070 A		
dryer filter / filtro essiccatore	OM356 (366)	100	136	12/92 > 09/95				S 7259 A	
power steering / servosterzo	OM356 (366)	100	136	12/92 > 09/95				S 3081 PO	
1314 AK									
to engine No. 286114 / a motore N. 286114	OM366	100	136		S 5099 PE	S 2161 N	S 1070 A		
some / alcuni	OM366	100	136	07/84 > 02/93		S 2161 N	S 6370 A		
from engine No. 286115 / da motore N. 286115	OM366	100	136			S 2161 N	S 1070 A		
dryer filter / filtro essiccatore	OM366	100	136	07/84 > 02/93				S 7259 A	
power steering / servosterzo	OM366	100	136	07/84 > 02/93				S 3081 PO	
1314 AK									
to engine No. 933107 / a motore N. 933107	OM366.918	100	136		S 5124 PE	S 2161 N	S 5250 A		
some / alcuni	OM366.918	100	136	06/87 > 02/93		S 2161 N	S 5250 A		
from engine No. 933108 / da motore N. 933108	OM366.918	100	136		S 5099 PE	S 2161 N	S 5250 A		
dryer filter / filtro essiccatore	OM366.918	100	136	06/87 > 02/93				S 7259 A	
power steering / servosterzo	OM366.918	100	136	06/87 > 02/93				S 3081 PO	
1314 KO									
to engine No. 286114 / a motore N. 286114	OM356 (366)	100	136		S 5099 PE	S 2161 N	S 1070 A		
some / alcuni	OM356 (366)	100	136	12/92 > 09/95		S 2161 N	S 6370 A		
from engine No. 286115 / da motore N. 286115	OM356 (366)	100	136			S 2161 N	S 1070 A		
dryer filter / filtro essiccatore	OM356 (366)	100	136	12/92 > 09/95				S 7259 A	
power steering / servosterzo	OM356 (366)	100	136	12/92 > 09/95				S 3081 PO	
1314 KO									
to engine No. 286114 / a motore N. 286114	OM366	100	136		S 5099 PE	S 2161 N	S 1070 A		
some / alcuni	OM366	100	136	07/84 > 02/93		S 2161 N	S 6370 A		
from engine No. 286115 / da motore N. 286115	OM366	100	136			S 2161 N	S 1070 A		
dryer filter / filtro essiccatore	OM366	100	136	07/84 > 02/93				S 7259 A	
power steering / servosterzo	OM366	100	136	07/84 > 02/93				S 3081 PO	
1317									
to engine No. 286114 / a motore N. 286114	OM356A (366)	125	170		S 5124 PE	S 2161 N	S 2650 A		
from engine No. 286115 / da motore N. 286115	OM356A (366)	125	170			S 2161 N	S 2650 A		
dryer filter / filtro essiccatore	OM356A (366)	125	170	12/92 >				S 7259 A	
1317									
to engine No. 286114 / a motore N. 286114	OM357A (366)	125	170		S 5124 PE	S 2161 N	S 2650 A		
from engine No. 286115 / da motore N. 286115	OM357A (366)	125	170			S 2161 N	S 2650 A		
dryer filter / filtro essiccatore	OM357A (366)	125	170	03/94 >				S 7259 A	
power steering / servosterzo	OM357A (366)	125	170	03/94 >				S 3081 PO	
1317									
some / alcuni	OM360	125	170	05/69 > 05/71	S 0300 O	S 2162 N			
power steering / servosterzo	OM360	125	170	05/69 > 05/71	S 0300 O	S 2162 N	S 5270 A		
power steering / servosterzo	OM360	125	170	05/69 > 05/71				S 3081 PO	
power steering / servosterzo	OM360	125	170	05/69 > 05/71				S 8790 PO	
1317									
to engine No. 923826 / a motore N. 923826	OM366A	125	170	07/84 > 09/88	S 8260 PO	S 2161 N	S 2650 A		
from engine No. 923827 / da motore N. 923827	OM366A	125	170	10/88 > 02/93	S 5124 PE	S 2161 N	S 2650 A		
dryer filter / filtro essiccatore	OM366A	125	170	01/85 > 02/93				S 7259 A	
power steering / servosterzo	OM366A	125	170	07/84 > 02/93				S 3081 PO	
1317									
dryer filter / filtro essiccatore	OM904LA	125	170	03/96 >	S 5007 PE	S 6017 NE	S 2650 A		
power steering / servosterzo	OM904LA	125	170	03/96 >				S 7259 A	
power steering / servosterzo	OM904LA	125	170	03/96 >				S 3081 PO	
1317 AK									
to engine No. 286114 / a motore N. 286114	OM356A (366)	125	170		S 5124 PE	S 2161 N	S 2650 A		
from engine No. 286115 / da motore N. 286115	OM356A (366)	125	170			S 2161 N	S 2650 A		
dryer filter / filtro essiccatore	OM356A (366)	125	170	12/92 >				S 7259 A	
1317 AK									
to engine No. 286114 / a motore N. 286114	OM357A (366)	125	170		S 5124 PE	S 2161 N	S 2650 A		
from engine No. 286115 / da motore N. 286115	OM357A (366)	125	170			S 2161 N	S 2650 A		
dryer filter / filtro essiccatore	OM357A (366)	125	170	03/94 >				S 7259 A	
power steering / servosterzo	OM357A (366)	125	170	03/94 >				S 3081 PO	
1317 L									
to engine No. 286114 / a motore N. 286114	OM356A (366)	125	170		S 5124 PE	S 2161 N	S 2650 A		

M





kW HP



...MERCEDES BENZ - trucks/autocarri

M



from engine No. 286115 / da motore N. 286115	OM356A (366)	125	170			S 2161 N	S 2650 A	
dryer filter / filtro essiccatore	OM356A (366)	125	170	12/92 >				S 7259 A
1317 L								
to engine No. 286114 / a motore N. 286114	OM357A (366)	125	170		S 5124 PE	S 2161 N	S 2650 A	
from engine No. 286115 / da motore N. 286115	OM357A (366)	125	170			S 2161 N	S 2650 A	
dryer filter / filtro essiccatore	OM357A (366)	125	170	03/94 >				S 7259 A
power steering / servosterzo	OM357A (366)	125	170	03/94 >				S 3081 PO
1317 L								
to engine No. 923826 / a motore N. 923826	OM366A	125	170	07/84 > 09/88	S 8260 PO	S 2161 N	S 2650 A	
from engine No. 923827 / da motore N. 923827	OM366A	125	170	10/88 > 02/93	S 5124 PE	S 2161 N	S 2650 A	
dryer filter / filtro essiccatore	OM366A	125	170	01/85 > 02/93				S 7259 A
power steering / servosterzo	OM366A	125	170	07/84 > 02/93				S 3081 PO
1317 L								
to engine No. 923826 / a motore N. 923826	OM904LA	125	170	01/96 >	S 5007 PE		S 2650 A	
dryer filter / filtro essiccatore	OM904LA	125	170	01/96 >				S 7259 A
power steering / servosterzo	OM904LA	125	170	01/96 >				S 3081 PO
1319								
to engine No. 923826 / a motore N. 923826	OM360	141	192	06/71 > 12/76	S 0300 O	S 2162 N	S 5270 A	
dryer filter / filtro essiccatore	OM360	141	192	06/71 > 12/76				S 3081 PO
power steering / servosterzo	OM360	141	192	06/71 > 12/76				S 8790 PO
1320								
to engine No. 286114 / a motore N. 286114	OM356LA (366)	148	201		S 5124 PE	S 2161 N	S 2650 A	
from engine No. 286115 / da motore N. 286115	OM356LA (366)	148	201			S 2161 N	S 2650 A	
dryer filter / filtro essiccatore	OM356LA (366)	148	201	12/92 >				S 7259 A
power steering / servosterzo	OM356LA (366)	148	201	12/92 >				S 3081 PO
1320								
to engine No. 286114 / a motore N. 286114	OM357LA (366)	155	211		S 5124 PE	S 2161 N	S 2650 A	
from engine No. 286115 / da motore N. 286115	OM357LA (366)	155	211			S 2161 N	S 2650 A	
dryer filter / filtro essiccatore	OM357LA (366)	155	211	03/94 >				S 7259 A
power steering / servosterzo	OM357LA (366)	155	211	03/94 >				S 3081 PO
1320								
to engine No. 923826 / a motore N. 923826	OM366LA	148	201	07/84 > 09/88	S 8260 PO	S 2161 N	S 2650 A	
from engine No. 923827 / da motore N. 923827	OM366LA	148	201	10/88 > 02/93	S 5124 PE	S 2161 N	S 2650 A	
dryer filter / filtro essiccatore	OM366LA	148	201	01/85 > 02/93				S 7259 A
power steering / servosterzo	OM366LA	148	201	07/84 > 02/93				S 3081 PO
1320 AK								
to engine No. 286114 / a motore N. 286114	OM357LA (366)	155	211		S 5124 PE	S 2161 N	S 2650 A	
from engine No. 286115 / da motore N. 286115	OM357LA (366)	155	211			S 2161 N	S 2650 A	
dryer filter / filtro essiccatore	OM357LA (366)	155	211	03/94 >				S 7259 A
power steering / servosterzo	OM357LA (366)	155	211	03/94 >				S 3081 PO
1320 KO								
to engine No. 286114 / a motore N. 286114	OM357LA (366)	155	211		S 5124 PE	S 2161 N	S 2650 A	
from engine No. 286115 / da motore N. 286115	OM357LA (366)	155	211			S 2161 N	S 2650 A	
dryer filter / filtro essiccatore	OM357LA (366)	155	211	03/94 >				S 7259 A
power steering / servosterzo	OM357LA (366)	155	211	03/94 >				S 3081 PO
1320 L								
to engine No. 286114 / a motore N. 286114	OM356LA (366)	155	211		S 5124 PE	S 2161 N	S 2650 A	
from engine No. 286115 / da motore N. 286115	OM356LA (366)	155	211			S 2161 N	S 2650 A	
dryer filter / filtro essiccatore	OM356LA (366)	155	211	12/92 >				S 7259 A
power steering / servosterzo	OM356LA (366)	155	211	12/92 >				S 3081 PO
1320 L								
to engine No. 923826 / a motore N. 923826	OM366LA	155	211	07/84 > 09/88	S 8260 PO	S 2161 N	S 2650 A	
from engine No. 923827 / da motore N. 923827	OM366LA	155	211	10/88 > 02/93	S 5124 PE	S 2161 N	S 2650 A	
dryer filter / filtro essiccatore	OM366LA	155	211	01/85 > 02/93				S 7259 A
power steering / servosterzo	OM366LA	155	211	07/84 > 02/93				S 3081 PO
1324								
to engine No. 286114 / a motore N. 286114	OM356LA (366)	177	240		S 5124 PE	S 2161 N	S 2650 A	
some / alcuni	OM356LA (366)	177	240	01/91 > 02/01		S 2161 N	S 7187 A	
some / alcuni	OM356LA (366)	177	240	01/91 > 02/01		S 2161 N	S 6370 A	
from engine No. 286115 / da motore N. 286115	OM356LA (366)	177	240			S 2161 N	S 2650 A	
dryer filter / filtro essiccatore	OM356LA (366)	177	240	01/91 > 02/01				S 7259 A
power steering / servosterzo	OM356LA (366)	177	240	01/91 > 02/01				S 3081 PO
1324								
to engine No. 923826 / a motore N. 923826	OM357LA (366)	177	240	03/94 >		S 2161 N	S 2650 A	
some / alcuni	OM357LA (366)	177	240	03/94 >		S 2161 N	S 6370 A	
some / alcuni	OM357LA (366)	177	240	03/94 >		S 2161 N	S 7187 A	
dryer filter / filtro essiccatore	OM357LA (366)	177	240	03/94 >				S 7259 A
power steering / servosterzo	OM357LA (366)	177	240	03/94 >				S 3081 PO
1324								
to engine No. 286114 / a motore N. 286114	OM366LA	177	240		S 5124 PE	S 2161 N	S 2650 A	



...MERCEDES BENZ - trucks/autocarri

some / alcuni	OM366LA	177	240	09/90	>		S 2161 N	S 7187 A	
some / alcuni	OM366LA	177	240	09/90	>		S 2161 N	S 6370 A	
from engine No. 286115 / da motore N. 286115	OM366LA	177	240				S 2161 N	S 2650 A	
dryer filter / filtro essiccatore	OM366LA	177	240	09/90	>				S 7259 A
power steering / servosterzo	OM366LA	177	240	09/90	>				S 3081 PO
1324 L									
to engine No. 286114 / a motore N. 286114	OM356LA (366)	177	240			S 5124 PE	S 2161 N	S 2650 A	
some / alcuni	OM356LA (366)	177	240	01/91	> 02/01		S 2161 N	S 6370 A	
some / alcuni	OM356LA (366)	177	240	01/91	> 02/01		S 2161 N	S 7187 A	
from engine No. 286115 / da motore N. 286115	OM356LA (366)	177	240				S 2161 N	S 2650 A	
dryer filter / filtro essiccatore	OM356LA (366)	177	240	01/91	> 02/01				S 7259 A
power steering / servosterzo	OM356LA (366)	177	240	01/91	> 02/01				S 3081 PO
1324 L									
some / alcuni	OM357LA (366)	177	240	03/94	>		S 2161 N	S 2650 A	
some / alcuni	OM357LA (366)	177	240	03/94	>		S 2161 N	S 6370 A	
some / alcuni	OM357LA (366)	177	240	03/94	>		S 2161 N	S 7187 A	
dryer filter / filtro essiccatore	OM357LA (366)	177	240	03/94	>				S 7259 A
power steering / servosterzo	OM357LA (366)	177	240	03/94	>				S 3081 PO
1324 L									
to engine No. 286114 / a motore N. 286114	OM366LA	177	240			S 5124 PE	S 2161 N	S 2650 A	
some / alcuni	OM366LA	177	240	09/90	>		S 2161 N	S 6370 A	
some / alcuni	OM366LA	177	240	09/90	>		S 2161 N	S 7187 A	
from engine No. 286115 / da motore N. 286115	OM366LA	177	240				S 2161 N	S 2650 A	
dryer filter / filtro essiccatore	OM366LA	177	240	09/90	>				S 7259 A
power steering / servosterzo	OM366LA	177	240	09/90	>				S 3081 PO
L 1313									
	OM352	96	130	01/67	> 12/77	S 0300 O	S 2161 N	S 1070 A	
	OM352	96	130	01/78	> 02/01	S 5124 PE	S 2161 N	S 1070 A	
some / alcuni	OM352	96	130	01/67	> 12/77	S 0300 O	S 2162 N	S 1070 A	
some / alcuni	OM352	96	130	01/78	> 02/01	S 5124 PE	S 2162 N	S 2450 A	
power steering / servosterzo	OM352	96	130	01/67	> 02/01				S 3081 PO
power steering / servosterzo	OM352	96	130	01/67	> 02/01				S 8790 PO
L 1313									
	OM352A	96	130	01/72	> 06/87	S 2530 PO	S 2161 N		
some / alcuni	OM352A	96	130	01/72	> 06/87	S 2530 PO	S 2161 N	S 6370 A	
power steering / servosterzo	OM352A	96	130	01/72	> 06/87				S 3081 PO
power steering / servosterzo	OM352A	96	130	01/72	> 06/87				S 8790 PO
L 1313									
	OM353A	96	130	01/72	> 01/87	S 2530 PO	S 2161 N		
some / alcuni	OM353A	96	130	01/72	> 01/87	S 2530 PO	S 2161 N	S 6370 A	
power steering / servosterzo	OM353A	96	130	01/72	> 01/87				S 8790 PO
power steering / servosterzo	OM353A	96	130	01/72	> 01/87				S 3081 PO
LA 1313									
	OM352	96	130	01/67	> 12/77	S 0300 O	S 2161 N	S 1070 A	
	OM352	96	130	01/78	> 02/01	S 5124 PE	S 2161 N	S 1070 A	
some / alcuni	OM352	96	130	01/67	> 12/77	S 0300 O	S 2162 N	S 1070 A	
some / alcuni	OM352	96	130	01/78	> 02/01	S 5124 PE	S 2162 N	S 2450 A	
power steering / servosterzo	OM352	96	130	01/67	> 02/01				S 8790 PO
power steering / servosterzo	OM352	96	130	01/67	> 02/01				S 3081 PO
LA 1313									
	OM352A	96	130	01/72	> 06/87	S 2530 PO	S 2161 N		
some / alcuni	OM352A	96	130	01/72	> 06/87	S 2530 PO	S 2161 N	S 6370 A	
power steering / servosterzo	OM352A	96	130	01/72	> 06/87				S 8790 PO
power steering / servosterzo	OM352A	96	130	01/72	> 06/87				S 3081 PO
LA 1313									
	OM353A	96	130	01/72	> 01/87	S 2530 PO	S 2161 N		
some / alcuni	OM353A	96	130	01/72	> 01/87	S 2530 PO	S 2161 N	S 6370 A	
power steering / servosterzo	OM353A	96	130	01/72	> 01/87				S 3081 PO
power steering / servosterzo	OM353A	96	130	01/72	> 01/87				S 8790 PO
LP 1313									
	OM352A	96	130	01/72	> 06/87	S 2530 PO	S 2161 N		
some / alcuni	OM352A	96	130	01/72	> 06/87	S 2530 PO	S 2161 N	S 6370 A	
power steering / servosterzo	OM352A	96	130	01/72	> 06/87				S 8790 PO
power steering / servosterzo	OM352A	96	130	01/72	> 06/87				S 3081 PO
LP 1313									
	OM353	96	130	01/72	> 03/77	S 0300 O	S 2161 N	S 2450 A	
some / alcuni	OM353	96	130	01/72	> 03/77	S 0300 O	S 2162 N	S 2450 A	
power steering / servosterzo	OM353	96	130	01/72	> 03/77				S 3081 PO
power steering / servosterzo	OM353	96	130	01/72	> 03/77				S 8790 PO
LP 1317									
	OM360	125	170	05/69	> 05/71	S 0300 O	S 2162 N		
some / alcuni	OM360	125	170	05/69	> 05/71	S 0300 O	S 2162 N	S 5270 A	
power steering / servosterzo	OM360	125	170	05/69	> 05/71				S 3081 PO
power steering / servosterzo	OM360	125	170	05/69	> 05/71				S 8790 PO
LP 1319									
	OM360	141	192	06/71	> 12/76	S 0300 O	S 2162 N	S 5270 A	
power steering / servosterzo	OM360	141	192	06/71	> 12/76				S 3081 PO
power steering / servosterzo	OM360	141	192	06/71	> 12/76				S 8790 PO

M

**KW HP****...MERCEDES BENZ - trucks/autocarri****M**

LS 1313 A	OM352A	96	130	01/85 > 01/87	S 2530 PO	S 2161 N			
some / alcuni	OM352A	96	130	01/85 > 01/87	S 2530 PO	S 2161 N	S 6370 A		
dryer filter / filtro essiccatore	OM352A	96	130	01/85 > 01/87					S 7259 A
power steering / servosterzo	OM352A	96	130	01/85 > 01/87					S 3081 PO
power steering / servosterzo	OM352A	96	130	01/85 > 01/87					S 8790 PO
14 t Serie									
1414									
to engine No. 916577 / a motore N. 916577	OM366.906/OM366.909	100	136	04/84 > 09/88	S 5124 PE	S 2161 N	S 1070 A		✗
some / alcuni	OM366.906/OM366.909	100	136	04/84 > 03/91		S 2161 N	S 6370 A		✗
from engine No. 916578 / da motore N. 916578	OM366.906/OM366.909	100	136	10/88 > 03/91	S 5099 PE	S 2161 N	S 1070 A		✗
dryer filter / filtro essiccatore	OM366.906/OM366.909	100	136	01/85 > 03/91					S 7259 A
power steering / servosterzo	OM366.906/OM366.909	100	136	04/84 > 03/91					S 3081 PO
1417									
	OM356A (366)	125	170	07/92 > 05/94		S 2161 N	S 2650 A		✗
	OM356A (366)	125	170	06/94 > 09/96		S 2161 N	S 2650 A		S 3056 C
to engine No. 286114 / a motore N. 286114	OM356A (366)	125	170	07/92 >	S 5124 PE				
some / alcuni	OM356A (366)	125	170		S 5131 PE	S 2161 N	S 6370 A		
some / alcuni	OM356A (366)	125	170		S 5099 PE	S 2161 N	S 9570 A		
from engine No. 286115 / da motore N. 286115	OM356A (366)	125	170	> 09/96	S 5132 PE				
dryer filter / filtro essiccatore	OM356A (366)	125	170	07/92 > 09/96					S 7259 A
power steering / servosterzo	OM356A (366)	125	170	07/92 > 09/96					S 3081 PO
1417									
	OM357A (366)	125	170	03/94 > 05/94		S 2161 N	S 2650 A		✗
	OM357A (366)	125	170	06/94 > 09/96		S 2161 N	S 2650 A		S 3056 C
to engine No. 286114 / a motore N. 286114	OM357A (366)	125	170	03/94 >	S 5124 PE				
some / alcuni	OM357A (366)	125	170		S 5099 PE	S 2161 N	S 9570 A		
some / alcuni	OM357A (366)	125	170		S 5131 PE	S 2161 N	S 6370 A		
from engine No. 286115 / da motore N. 286115	OM357A (366)	125	170	> 09/96	S 5132 PE				
dryer filter / filtro essiccatore	OM357A (366)	125	170	03/94 > 09/96					S 7259 A
power steering / servosterzo	OM357A (366)	125	170	03/94 > 09/96					S 3081 PO
1417									
to engine No. 923826 / a motore N. 923826	OM366.952A	125	170	07/89 >	S 8260 PO	S 2161 N	S 2650 A		✗
some / alcuni	OM366.952A	125	170	07/89 > 07/92		S 2161 N	S 7185 A		✗
from engine No. 923827 / da motore N. 923827	OM366.952A	125	170	> 07/92	S 5124 PE	S 2161 N	S 2650 A		✗
dryer filter / filtro essiccatore	OM366.952A	125	170	07/89 > 07/92					S 7259 A
power steering / servosterzo	OM366.952A	125	170	07/89 > 07/92					S 3081 PO
1417 A									
	OM353	124	168	05/75 > 12/77	S 0300 O		S 1070 A		✗
	OM353	124	168	01/78 > 12/84	S 5124 PE		S 1070 A		✗
some / alcuni	OM353	124	168	05/75 > 12/77	S 0300 O		S 2450 A		✗
some / alcuni	OM353	124	168	01/78 > 12/84	S 5124 PE		S 2450 A		✗
some 2 filters / alcuni N.2 filtri	OM353	124	168	05/75 > 12/84		S 2162 N			
2 filters / N.2 filtri	OM353	124	168	05/75 > 12/84		S 2161 N			
power steering / servosterzo	OM353	124	168	05/75 > 12/84					S 3081 PO
power steering / servosterzo	OM353	124	168	05/75 > 12/84					S 8790 PO
1417 A									
to engine No. 286114 / a motore N. 286114	OM356A (366)	125	170		S 5124 PE	S 2161 N	S 2650 A		
some / alcuni	OM356A (366)	125	170		S 5099 PE	S 2161 N	S 9570 A		
some / alcuni	OM356A (366)	125	170			S 2161 N	S 6370 A		
from engine No. 286115 / da motore N. 286115	OM356A (366)	125	170			S 2161 N	S 2650 A		
dryer filter / filtro essiccatore	OM356A (366)	125	170	07/92 >					S 7259 A
power steering / servosterzo	OM356A (366)	125	170	07/92 >					S 3081 PO
1417 A									
to engine No. 286114 / a motore N. 286114	OM357A (366)	125	170		S 5124 PE	S 2161 N	S 2650 A		
some / alcuni	OM357A (366)	125	170			S 2161 N	S 6370 A		
some / alcuni	OM357A (366)	125	170		S 5099 PE	S 2161 N	S 9570 A		
from engine No. 286115 / da motore N. 286115	OM357A (366)	125	170			S 2161 N	S 2650 A		
dryer filter / filtro essiccatore	OM357A (366)	125	170	03/94 >					S 7259 A
power steering / servosterzo	OM357A (366)	125	170	03/94 >					S 3081 PO
1417 A									
to engine No. 923826 / a motore N. 923826	OM366A	125	170		S 8260 PO	S 2161 N	S 2650 A		
some / alcuni	OM366A	125	170	04/84 > 07/92		S 2161 N	S 7185 A		
some / alcuni	OM366A	125	170	04/84 > 07/92		S 2161 N	S 6370 A		
from engine No. 923827 / da motore N. 923827	OM366A	125	170		S 5124 PE	S 2161 N	S 2650 A		
dryer filter / filtro essiccatore	OM366A	125	170	01/85 > 07/92					S 7259 A
power steering / servosterzo	OM366A	125	170	04/84 > 07/92					S 3081 PO
1417 AKO									
	OM353	124	168	05/75 > 12/77	S 0300 O	S 2161 N	S 1070 A		
	OM353	124	168	01/78 > 12/84	S 5124 PE	S 2161 N	S 1070 A		
some / alcuni	OM353	124	168	05/75 > 12/77	S 0300 O	S 2162 N	S 2450 A		
some / alcuni	OM353	124	168	01/78 > 12/84	S 5124 PE	S 2162 N	S 2450 A		

**KW HP****...MERCEDES BENZ - trucks/autocarri**

power steering / servosterzo	OM353	124	168	05/75 >	12/84				S 8790 PO
power steering / servosterzo	OM353	124	168	05/75 >	12/84				S 3081 PO
1417 C									
to engine No. 923826 / a motore N. 923826	OM366A	125	170			S 8260 PO	S 2161 N	S 2650 A	
some / alcuni	OM366A	125	170	04/84 >	07/92		S 2161 N	S 7185 A	
some / alcuni	OM366A	125	170	04/84 >	07/92		S 2161 N	S 6370 A	
from engine No. 923827 / da motore N. 923827	OM366A	125	170			S 5124 PE	S 2161 N	S 2650 A	
dryer filter / filtro essiccatore	OM366A	125	170	01/85 >	07/92				S 7259 A
power steering / servosterzo	OM366A	125	170	04/84 >	07/92				S 3081 PO
1417 K									
	OM353	124	168	05/75 >	12/77	S 0300 O	S 2161 N	S 1070 A	
	OM353	124	168	01/78 >	12/84	S 5124 PE	S 2161 N	S 1070 A	
some / alcuni	OM353	124	168	05/75 >	12/77	S 0300 O	S 2162 N	S 2450 A	
some / alcuni	OM353	124	168	01/78 >	12/84	S 5124 PE	S 2162 N	S 2450 A	
power steering / servosterzo	OM353	124	168	05/75 >	12/84				S 3081 PO
power steering / servosterzo	OM353	124	168	05/75 >	12/84				S 8790 PO
1419									
	OM401	141	192	05/75 >	03/82	S 8260 PO	S 2161 N	S 6370 A	
	OM401	141	192	04/82 >	12/82	S 8260 PO	S 2162 N	S 6370 A	
power steering / servosterzo	OM401	141	192	05/75 >	12/82				S 8790 PO
1419 C									
power steering / servosterzo	OM362	141	192	05/83 >	06/85	S 8260 PO	S 2161 N	S 6370 A	
power steering / servosterzo	OM362	141	192	05/83 >	06/85				S 3081 PO
1419 CL									
power steering / servosterzo	OM362	141	192	05/83 >	06/85	S 8260 PO	S 2161 N	S 6370 A	
power steering / servosterzo	OM362	141	192	05/83 >	06/85				S 3081 PO
1419 L									
	OM401	141	192	05/75 >	03/82	S 8260 PO	S 2161 N	S 6370 A	
	OM401	141	192	04/82 >	12/82	S 8260 PO	S 2162 N	S 6370 A	
power steering / servosterzo	OM401	141	192	05/75 >	12/82				S 8790 PO
1420									
to engine No. 286114 / a motore N. 286114	OM356LA (366)	150	204			S 5124 PE	S 2161 N	S 2650 A	
some / alcuni	OM356LA (366)	150	204	02/90 >	06/93		S 2161 N	S 6370 A	
from engine No. 286115 / da motore N. 286115	OM356LA (366)	150	204				S 2161 N	S 2650 A	
dryer filter / filtro essiccatore	OM356LA (366)	150	204	02/90 >	06/93				S 7259 A
power steering / servosterzo	OM356LA (366)	150	204	02/90 >	06/93				S 3081 PO
1420									
to engine No. 923826 / a motore N. 923826	OM366LA	150	204	07/85 >	09/88	S 8260 PO	S 2161 N	S 2650 A	
some / alcuni	OM366LA	150	204	07/85 >	03/91		S 2161 N	S 6370 A	
from engine No. 923827 / da motore N. 923827	OM366LA	150	204	10/88 >	03/91	S 5124 PE	S 2161 N	S 2650 A	
dryer filter / filtro essiccatore	OM366LA	150	204	07/87 >	03/91				S 7259 A
power steering / servosterzo	OM366LA	150	204	07/85 >	03/91				S 3081 PO
1420 L									
to engine No. 286114 / a motore N. 286114	OM356LA (366)	150	204			S 5124 PE	S 2161 N	S 2650 A	
some / alcuni	OM356LA (366)	150	204	02/90 >	06/93		S 2161 N	S 6370 A	
from engine No. 286115 / da motore N. 286115	OM356LA (366)	150	204				S 2161 N	S 2650 A	
dryer filter / filtro essiccatore	OM356LA (366)	150	204	02/90 >	06/93				S 7259 A
power steering / servosterzo	OM356LA (366)	150	204	02/90 >	06/93				S 3081 PO
1420 L									
to engine No. 923826 / a motore N. 923826	OM366LA	150	204			S 8260 PO	S 2161 N	S 2650 A	
some / alcuni	OM366LA	150	204	07/85 >	03/91		S 2161 N	S 6370 A	
from engine No. 923827 / da motore N. 923827	OM366LA	150	204			S 5124 PE	S 2161 N	S 2650 A	
dryer filter / filtro essiccatore	OM366LA	150	204	07/85 >	03/91				S 7259 A
power steering / servosterzo	OM366LA	150	204	07/85 >	03/91				S 3081 PO
1422									
dryer filter / filtro essiccatore	OM421	159	216	05/82 >	10/90	S 7261 PO	S 2162 N	S 6370 A	
dryer filter / filtro essiccatore	OM421	159	216	01/85 >	10/90				S 7259 A
1422									
dryer filter / filtro essiccatore	OM441.905	165	224	06/89 >	08/94	S 8260 PO		S 7185 A	
dryer filter / filtro essiccatore	OM441.905	165	224	06/89 >	08/94				S 7259 A
2 filters / N.2 filtri	OM441.905	165	224	06/89 >	08/94		S 2162 N		
power steering / servosterzo	OM441.905	165	224	06/89 >	08/94				S 3081 PO
1422									
dryer filter / filtro essiccatore	OM441LA	169	230	02/93 >	08/94	S 5133 PE		S 7185 A	✗
2 filters / N.2 filtri	OM441LA	169	230	02/93 >	08/94		S 2162 N		S 7259 A
power steering / servosterzo	OM441LA	169	230	02/93 >	08/94				S 3081 PO
1422 F									
	OM356LA (366)	177	241	03/93 >	05/94		S 2161 N	S 2650 A	✗
	OM356LA (366)	177	241	06/94 >	08/94		S 2161 N	S 2650 A	S 3056 C
to engine No. 286114 / a motore N. 286114	OM356LA (366)	177	241	03/93 >		S 5124 PE			
some / alcuni	OM356LA (366)	177	241	03/93 >	08/94			S 6370 A	
from engine No. 286115 / da motore N. 286115	OM356LA (366)	177	241	>	08/94	S 5132 PE			
dryer filter / filtro essiccatore	OM356LA (366)	177	241	03/93 >	08/94				S 7259 A
power steering / servosterzo	OM356LA (366)	177	241	03/93 >	08/94				S 3081 PO
1422 F									
	OM421	159	216	05/82 >	10/90	S 7261 PO	S 2162 N	S 6370 A	

M

**KW HP****...MERCEDES BENZ - trucks/autocarri****M**

dryer filter / filtro essiccatore	OM421	159	216	01/85 >	10/90				S 7259 A
1422 F	OM441.905	165	224	06/89 >	08/94	S 8260 PO		S 7185 A	
dryer filter / filtro essiccatore	OM441.905	165	224	06/89 >	08/94				S 7259 A
2 filters / N.2 filtri	OM441.905	165	224	06/89 >	08/94		S 2162 N		
power steering / servosterzo	OM441.905	165	224	06/89 >	08/94				S 3081 PO
1422 F	OM441LA	169	230	02/93 >	08/94	S 5133 PE		S 7185 A	✗
dryer filter / filtro essiccatore	OM441LA	169	230	02/93 >	08/94				S 7259 A
2 filters / N.2 filtri	OM441LA	169	230	02/93 >	08/94		S 2162 N		
power steering / servosterzo	OM441LA	169	230	02/93 >	08/94				S 3081 PO
1422 L									
to engine No. 286114 / a motore N. 286114	OM356LA (366)	155	211			S 5124 PE	S 2161 N	S 2650 A	
some / alcuni	OM356LA (366)	155	211	03/93 >	08/94		S 2161 N	S 6370 A	
from engine No. 286115 / da motore N. 286115	OM356LA (366)	155	211				S 2161 N	S 2650 A	
dryer filter / filtro essiccatore	OM356LA (366)	155	211	03/93 >	08/94				S 7259 A
power steering / servosterzo	OM356LA (366)	155	211	03/93 >	08/94				S 3081 PO
1422 L	OM421	159	216	05/82 >	10/90	S 7261 PO	S 2162 N	S 6370 A	
dryer filter / filtro essiccatore	OM421	159	216	01/85 >	10/90				S 7259 A
1422 L	OM441.905	165	224	06/89 >	08/94	S 8260 PO	S 2162 N	S 7185 A	
dryer filter / filtro essiccatore	OM441.905	165	224	06/89 >	08/94				S 7259 A
power steering / servosterzo	OM441.905	165	224	06/89 >	08/94				S 3081 PO
1422 L	OM441LA	160	218	02/93 >	08/94	S 8260 PO		S 7185 A	
dryer filter / filtro essiccatore	OM441LA	160	218	02/93 >	08/94				S 7259 A
2 filters / N.2 filtri	OM441LA	160	218	02/93 >	08/94		S 2162 N		
power steering / servosterzo	OM441LA	160	218	02/93 >	08/94				S 3081 PO
1424	OM355	177	240	03/78 >	08/94	S 9490 PO	S 2162 N		
some / alcuni	OM355	177	240	03/78 >	08/94	S 9490 PO	S 2162 N	S 5270 A	
power steering / servosterzo	OM355	177	240	03/78 >	08/94				S 8790 PO
power steering / servosterzo	OM355	177	240	03/78 >	08/94				S 3081 PO
1424	OM401LA	180	245	02/93 >	09/96	S 5133 PE		S 7185 A	
dryer filter / filtro essiccatore	OM401LA	180	245	02/93 >	09/96				S 7259 A
2 filters / N.2 filtri	OM401LA	180	245	02/93 >	09/96		S 2162 N		
power steering / servosterzo	OM401LA	180	245	02/93 >	09/96				S 3081 PO
1424	OM402	180	245	07/75 >	03/82	S 8260 PO	S 2161 N	S 6370 A	
	OM402	180	245	04/82 >	01/87	S 8260 PO	S 2162 N	S 6370 A	
some / alcuni	OM402	180	245	07/75 >	03/82	S 7261 PO	S 2161 N	S 7998 A	
some / alcuni	OM402	180	245	04/82 >	01/87	S 7261 PO	S 2162 N	S 7998 A	
power steering / servosterzo	OM402	180	245	07/75 >	01/87				S 8790 PO
1424	OM445LA (441)	180	245	01/95 >			S 2162 N	S 7185 A	
dryer filter / filtro essiccatore	OM445LA (441)	180	245	01/95 >					S 7259 A
power steering / servosterzo	OM445LA (441)	180	245	01/95 >					S 3081 PO
1424 F	OM402	180	245	07/75 >	03/82	S 7261 PO	S 2161 N	S 6370 A	
	OM402	180	245	04/82 >	01/87	S 7261 PO	S 2162 N	S 6370 A	
some / alcuni	OM402	180	245	07/75 >	03/82	S 8260 PO	S 2162 N	S 7998 A	
some / alcuni	OM402	180	245	04/82 >	01/87	S 8260 PO	S 2162 N	S 7998 A	
power steering / servosterzo	OM402	180	245	07/75 >	01/87				S 8790 PO
1424 L	OM355	177	240	03/78 >	08/94	S 9490 PO	S 2162 N		
some / alcuni	OM355	177	240	03/78 >	08/94	S 9490 PO	S 2162 N	S 5270 A	
power steering / servosterzo	OM355	177	240	03/78 >	08/94				S 8790 PO
power steering / servosterzo	OM355	177	240	03/78 >	08/94				S 3081 PO
1424 L	OM401LA	180	245	02/93 >			S 2162 N	S 7185 A	
dryer filter / filtro essiccatore	OM401LA	180	245	02/93 >					S 7259 A
power steering / servosterzo	OM401LA	180	245	02/93 >					S 3081 PO
1424 L	OM402	180	245	07/75 >	03/82	S 7261 PO	S 2161 N	S 6370 A	
	OM402	180	245	04/82 >	01/87	S 7261 PO	S 2162 N	S 6370 A	
some / alcuni	OM402	180	245	07/75 >	03/82	S 8260 PO	S 2162 N	S 7998 A	
some / alcuni	OM402	180	245	04/82 >	01/87	S 8260 PO	S 2162 N	S 7998 A	
power steering / servosterzo	OM402	180	245	07/75 >	01/87				S 8790 PO
1424 L	OM445LA (441)	180	245	01/95 >			S 2162 N	S 7185 A	
dryer filter / filtro essiccatore	OM445LA (441)	180	245	01/95 >					S 7259 A
power steering / servosterzo	OM445LA (441)	180	245	01/95 >					S 3081 PO
1425	OM422	184	250	11/82 >	03/91	S 7261 PO	S 2162 N	S 6370 A	
dryer filter / filtro essiccatore	OM422	184	250	01/85 >	03/91				S 7259 A
power steering / servosterzo	OM422	184	250	11/82 >	03/91				S 3081 PO
1425	OM442.905	184	250	04/87 >	03/91	S 8260 PO	S 2162 N	S 3570 A	
dryer filter / filtro essiccatore	OM442.905	184	250	04/87 >	03/91				S 7259 A
power steering / servosterzo	OM442.905	184	250	04/87 >	03/91				S 3081 PO
1425 LS	OM422	184	250	11/82 >	03/91	S 7261 PO	S 2162 N	S 6370 A	

**kW HP****...MERCEDES BENZ - trucks/autocarri**

dryer filter / filtro essiccatore	OM422	184	250	01/85 >	03/91				S 7259 A
power steering / servosterzo	OM422	184	250	11/82 >	03/91				S 3081 PO
1425 LS	OM442.905	184	250	04/87 >	03/91	S 8260 PO	S 2162 N	S 3570 A	
dryer filter / filtro essiccatore	OM442.905	184	250	04/87 >	03/91				S 7259 A
power steering / servosterzo	OM442.905	184	250	04/87 >	03/91				S 3081 PO
1425 S	OM422	184	250	11/82 >	03/91	S 7261 PO	S 2162 N	S 6370 A	
dryer filter / filtro essiccatore	OM422	184	250	01/85 >	03/91				S 7259 A
power steering / servosterzo	OM422	184	250	11/82 >	03/91				S 3081 PO
1425 S	OM442.905	184	250	04/87 >	03/91	S 8260 PO	S 2162 N	S 3570 A	
dryer filter / filtro essiccatore	OM442.905	184	250	04/87 >	03/91				S 7259 A
power steering / servosterzo	OM442.905	184	250	04/87 >	03/91				S 3081 PO
1426	OM442	195	265	02/90 >	07/90	S 7261 PO		S 7185 A	✗
	OM442	195	265	08/90 >	09/93	S 5133 PE		S 7185 A	✗
dryer filter / filtro essiccatore	OM442	195	265	02/90 >	09/93				S 7259 A
2 filters / N.2 filtri	OM442	195	265	08/90 >	09/93		S 2162 N		
power steering / servosterzo	OM442	195	265	02/90 >	09/93				S 3081 PO
1426 LS	OM442	195	265	02/90 >	07/90	S 7261 PO		S 7185 A	✗
	OM442	195	265	08/90 >	09/93	S 5133 PE		S 7185 A	✗
dryer filter / filtro essiccatore	OM442	195	265	02/90 >	09/93				S 7259 A
2 filters / N.2 filtri	OM442	195	265	08/90 >	09/93		S 2162 N		
power steering / servosterzo	OM442	195	265	02/90 >	09/93				S 3081 PO
1427	OM401LA	200	272	02/93 >	05/94	S 5133 PE		S 7185 A	✗
	OM401LA	200	272	06/94 >	09/96	S 5133 PE		S 7185 A	S 3056 C
dryer filter / filtro essiccatore	OM401LA	200	272	02/93 >	09/96				S 7259 A
2 filters / N.2 filtri	OM401LA	200	272	02/93 >	09/96		S 2162 N		
power steering / servosterzo	OM401LA	200	272	02/93 >	09/96				S 3081 PO
1427 F	OM401LA	200	272	02/93 >	05/94	S 5133 PE		S 7185 A	✗
	OM401LA	200	272	06/94 >	09/96	S 5133 PE		S 7185 A	S 3056 C
dryer filter / filtro essiccatore	OM401LA	200	272	02/93 >	09/96				S 7259 A
2 filters / N.2 filtri	OM401LA	200	272	02/93 >	09/96		S 2162 N		
power steering / servosterzo	OM401LA	200	272	02/93 >	09/96				S 3081 PO
15 t Serie									
1513	OM352	91	124	10/67 >	12/77	S 0300 O	S 2161 N	S 2450 A	
	OM352	91	124	01/78 >	02/01	S 5124 PE	S 2161 N	S 2450 A	
some / alcuni	OM352	91	124	10/67 >	12/77	S 0300 O	S 2162 N	S 5270 A	
some / alcuni	OM352	91	124	01/78 >	02/01	S 5124 PE	S 2162 N	S 5270 A	
power steering / servosterzo	OM352	91	124	10/67 >	02/01				S 8790 PO
power steering / servosterzo	OM352	91	124	10/67 >	02/01				S 3081 PO
1513	OM353A	124	168	01/72 >	02/01	S 2530 PO	S 2161 N	S 7998 A	
some / alcuni	OM353A	124	168	01/72 >	02/01	S 2530 PO	S 2161 N	S 6370 A	
power steering / servosterzo	OM353A	124	168	01/72 >	02/01				S 3081 PO
power steering / servosterzo	OM353A	124	168	01/72 >	02/01				S 8790 PO
1514									
to engine No. 286114 / a motore N. 286114	OM356 (366)	100	136	12/92 >		S 5099 PE	S 2161 N	S 1070 A	
some / alcuni	OM356 (366)	100	136	12/92 >			S 2161 N	S 6370 A	
from engine No. 286115 / da motore N. 286115	OM356 (366)	100	136	12/92 >			S 2161 N	S 1070 A	
dryer filter / filtro essiccatore	OM356 (366)	100	136	12/92 >					S 7259 A
power steering / servosterzo	OM356 (366)	100	136	12/92 >					S 3081 PO
1514									
to engine No. 286114 / a motore N. 286114	OM366	100	136	01/89 >	12/92	S 5099 PE	S 2161 N	S 1070 A	
some / alcuni	OM366	100	136	01/89 >	12/92		S 2161 N	S 6370 A	
from engine No. 286115 / da motore N. 286115	OM366	100	136	01/89 >	12/92		S 2161 N	S 1070 A	
dryer filter / filtro essiccatore	OM366	100	136	01/89 >	12/92				S 7259 A
power steering / servosterzo	OM366	100	136	01/89 >	12/92				S 3081 PO
1514 L									
to engine No. 286114 / a motore N. 286114	OM356 (366)	100	136	12/92 >		S 5099 PE	S 2161 N	S 1070 A	
some / alcuni	OM356 (366)	100	136	12/92 >			S 2161 N	S 6370 A	
from engine No. 286115 / da motore N. 286115	OM356 (366)	100	136	12/92 >			S 2161 N	S 1070 A	
dryer filter / filtro essiccatore	OM356 (366)	100	136	12/92 >					S 7259 A
power steering / servosterzo	OM356 (366)	100	136	12/92 >					S 3081 PO
1514 L									
to engine No. 286115 / a motore N. 286115	OM366	100	136	01/89 >	12/92	S 5099 PE	S 2161 N	S 1070 A	
some / alcuni	OM366	100	136	01/89 >	12/92		S 2161 N	S 6370 A	
from engine No. 286114 / da motore N. 286114	OM366	100	136	01/89 >	12/92		S 2161 N	S 1070 A	
dryer filter / filtro essiccatore	OM366	100	136	01/89 >	12/92				S 7259 A
power steering / servosterzo	OM366	100	136	01/89 >	12/92				S 3081 PO
1517									

M



kW HP



...MERCEDES BENZ - trucks/autocarri

M



to engine No. 286114 / a motore N. 286114	OM356A (366)	125	170	12/92	>	S 5124 PE	S 2161 N	S 2650 A	
some / alcuni	OM356A (366)	125	170	12/92	>		S 2161 N	S 9570 A	
from engine No. 286115 / da motore N. 286115	OM356A (366)	125	170	12/92	>		S 2161 N	S 2650 A	
dryer filter / filtro essiccatore	OM356A (366)	125	170	12/92	>				S 7259 A
power steering / servosterzo	OM356A (366)	125	170	12/92	>				S 3081 PO
1517	OM357LA (366)	125	170	03/94	>		S 2161 N	S 2650 A	
some / alcuni	OM357LA (366)	125	170	03/94	>		S 2161 N	S 9570 A	
dryer filter / filtro essiccatore	OM357LA (366)	125	170	03/94	>				S 7259 A
power steering / servosterzo	OM357LA (366)	125	170	03/94	>				S 3081 PO
1517	OM366A	125	170	10/88	> 12/92	S 5124 PE	S 2161 N	S 6370 A	
some / alcuni	OM366A	125	170	10/88	> 12/92	S 5099 PE	S 2161 N	S 2650 A	
some / alcuni	OM366A	125	170	10/88	> 12/92		S 2161 N	S 9570 A	
from engine No. 286115 / da motore N. 286115	OM366A	125	170	10/88	> 12/92		S 2161 N	S 6370 A	
dryer filter / filtro essiccatore	OM366A	125	170	10/88	> 12/92				S 7259 A
power steering / servosterzo	OM366A	125	170	10/88	> 12/92				S 3081 PO
1517	OM904LA	125	170	03/96	>	S 5007 PE	S 6017 NE	S 2650 A	
dryer filter / filtro essiccatore	OM904LA	125	170	03/96	>				S 7259 A
power steering / servosterzo	OM904LA	125	170	03/96	>				S 3081 PO
1517 L	OM356A (366)	125	170	12/92	>	S 5124 PE	S 2161 N	S 2650 A	
some / alcuni	OM356A (366)	125	170	12/92	>		S 2161 N	S 9570 A	
from engine No. 286115 / da motore N. 286115	OM356A (366)	125	170	12/92	>		S 2161 N	S 2650 A	
dryer filter / filtro essiccatore	OM356A (366)	125	170	12/92	>				S 7259 A
power steering / servosterzo	OM356A (366)	125	170	12/92	>				S 3081 PO
1517 L	OM357LA (366)	125	170	03/94	>		S 2161 N	S 2650 A	
some / alcuni	OM357LA (366)	125	170	03/94	>		S 2161 N	S 9570 A	
dryer filter / filtro essiccatore	OM357LA (366)	125	170	03/94	>				S 7259 A
power steering / servosterzo	OM357LA (366)	125	170	03/94	>				S 3081 PO
1517 L	OM366A	125	170	10/88	> 12/92	S 5124 PE	S 2161 N	S 6370 A	
some / alcuni	OM366A	125	170	10/88	> 12/92	S 5099 PE	S 2161 N	S 2650 A	
some / alcuni	OM366A	125	170	10/88	> 12/92		S 2161 N	S 9570 A	
from engine No. 286115 / da motore N. 286115	OM366A	125	170	10/88	> 12/92		S 2161 N	S 6370 A	
dryer filter / filtro essiccatore	OM366A	125	170	10/88	> 12/92				S 7259 A
power steering / servosterzo	OM366A	125	170	10/88	> 12/92				S 3081 PO
1517 L	OM904LA	125	170	01/96	>	S 5007 PE	S 6017 NE	S 2650 A	
dryer filter / filtro essiccatore	OM904LA	125	170	01/96	>				S 7259 A
power steering / servosterzo	OM904LA	125	170	01/96	>				S 3081 PO
1519	OM360	141	192	06/71	> 12/76	S 0300 O	S 2162 N	S 5270 A	
some / alcuni	OM360	141	192	06/71	> 12/76	S 0300 O	S 2162 N	S 5270 A	
power steering / servosterzo	OM360	141	192	06/71	> 12/76				S 3081 PO
power steering / servosterzo	OM360	141	192	06/71	> 12/76				S 8790 PO
1520	OM356LA (366)	155	211	12/92	>	S 5124 PE	S 2161 N	S 2650 A	
some / alcuni	OM356LA (366)	155	211	12/92	>		S 2161 N	S 6370 A	
from engine No. 286115 / da motore N. 286115	OM356LA (366)	155	211	12/92	>		S 2161 N	S 2650 A	
dryer filter / filtro essiccatore	OM356LA (366)	155	211	12/92	>				S 7259 A
power steering / servosterzo	OM356LA (366)	155	211	12/92	>				S 3081 PO
1520	OM357LA (366)	155	211	03/94	>		S 2161 N	S 2650 A	
with R.H.D. / con guida a destra	OM357LA (366)	155	211	03/94	>		S 2161 N	S 7187 A	
dryer filter / filtro essiccatore	OM357LA (366)	155	211	03/94	>				S 7259 A
power steering / servosterzo	OM357LA (366)	155	211	03/94	>				S 3081 PO
1520	OM366LA	155	211	01/89	> 12/92	S 8260 PO	S 2161 N	S 2650 A	
some / alcuni	OM366LA	155	211	01/89	> 12/92		S 2161 N	S 6370 A	
from engine No. 923827 / da motore N. 923827	OM366LA	155	211	01/89	> 12/92	S 5124 PE	S 2161 N	S 2650 A	
dryer filter / filtro essiccatore	OM366LA	155	211	01/89	> 12/92				S 7259 A
power steering / servosterzo	OM366LA	155	211	01/89	> 12/92				S 3081 PO
1520 L	OM356LA (366)	155	211	12/92	>	S 5124 PE	S 2161 N	S 2650 A	
some / alcuni	OM356LA (366)	155	211	12/92	>		S 2161 N	S 6370 A	
from engine No. 286115 / da motore N. 286115	OM356LA (366)	155	211	12/92	>		S 2161 N	S 2650 A	
dryer filter / filtro essiccatore	OM356LA (366)	155	211	12/92	>				S 7259 A
power steering / servosterzo	OM356LA (366)	155	211	12/92	>				S 3081 PO
1520 L	OM357LA (366)	155	211	03/94	>		S 2161 N	S 2650 A	
some / alcuni	OM357LA (366)	155	211	03/94	>		S 2161 N	S 2650 A	

**KW HP****...MERCEDES BENZ - trucks/autocarri**

with R.H.D. / con guida a destra	OM357LA (366)	155	211	03/94 >		S 2161 N	S 7187 A		
dryer filter / filtro essiccatore	OM357LA (366)	155	211	03/94 >				S 7259 A	
power steering / servosterzo	OM357LA (366)	155	211	03/94 >				S 3081 PO	
1520 L									
to engine No. 923827 / a motore N. 923827	OM366LA	155	211	01/89 > 12/92	S 8260 PO	S 2161 N	S 2650 A		
some / alcuni	OM366LA	155	211	01/89 > 12/92		S 2161 N	S 6370 A		
from engine No. 923826 / da motore N. 923826	OM366LA	155	211	01/89 > 12/92	S 5124 PE	S 2161 N	S 2650 A		
dryer filter / filtro essiccatore	OM366LA	155	211	01/89 > 12/92				S 7259 A	
power steering / servosterzo	OM366LA	155	211	01/89 > 12/92				S 3081 PO	
1524									
with R.H.D. / con guida a destra	OM357LA (366)	177	240	03/94 > 12/98	S 5132 PE	S 2161 N	S 7187 A	✗	
dryer filter / filtro essiccatore	OM357LA (366)	177	240	03/94 > 12/98			S 2650 A	S 7259 A	
power steering / servosterzo	OM357LA (366)	177	240	03/94 > 12/98				S 3081 PO	
1524									
to engine No. 286114 / a motore N. 286114	OM366LA	177	240	02/91 >	S 5124 PE	S 2161 N	S 7187 A	✗	
with R.H.D. / con guida a destra	OM366LA	177	240	02/91 > 12/98			S 2650 A	✗	
from engine No. 286115 / da motore N. 286115	OM366LA	177	240	02/91 > 12/98	S 5132 PE	S 2161 N	S 7187 A	✗	
dryer filter / filtro essiccatore	OM366LA	177	240	02/91 > 12/98				S 7259 A	
power steering / servosterzo	OM366LA	177	240	02/91 > 12/98				S 3081 PO	
1524 L									
with R.H.D. / con guida a destra	OM357LA (366)	177	240	03/94 > 12/98	S 5132 PE	S 2161 N	S 7187 A	✗	
dryer filter / filtro essiccatore	OM357LA (366)	177	240	03/94 > 12/98			S 2650 A	S 7259 A	
power steering / servosterzo	OM357LA (366)	177	240	03/94 > 12/98				S 3081 PO	
1524 L									
to engine No. 286114 / a motore N. 286114	OM366LA	177	240	02/91 >	S 5124 PE	S 2161 N	S 7187 A	✗	
with R.H.D. / con guida a destra	OM366LA	177	240	02/91 > 12/98			S 2650 A	✗	
from engine No. 286115 / da motore N. 286115	OM366LA	177	240	02/91 > 12/98	S 5132 PE	S 2161 N	S 7187 A	✗	
dryer filter / filtro essiccatore	OM366LA	177	240	02/91 > 12/98				S 7259 A	
power steering / servosterzo	OM366LA	177	240	02/91 > 12/98				S 3081 PO	
L 1513									
	OM352	96	130	10/67 > 12/77	S 0300 O	S 2161 N	S 2450 A		
	OM352	96	130	01/78 > 02/01	S 5124 PE	S 2161 N	S 2450 A		
some / alcuni	OM352	96	130	10/67 > 12/77	S 0300 O	S 2162 N	S 5270 A		
some / alcuni	OM352	96	130	01/78 > 02/01	S 5124 PE	S 2162 N	S 5270 A		
power steering / servosterzo	OM352	96	130	10/67 > 02/01				S 8790 PO	
power steering / servosterzo	OM352	96	130	10/67 > 02/01				S 3081 PO	
L 1513									
	OM353A	124	168	01/72 > 02/01	S 2530 PO	S 2161 N	S 7998 A		
some / alcuni	OM353A	124	168	01/72 > 02/01	S 2530 PO	S 2161 N	S 6370 A		
power steering / servosterzo	OM353A	124	168	01/72 > 02/01				S 3081 PO	
power steering / servosterzo	OM353A	124	168	01/72 > 02/01				S 8790 PO	
L 1519									
some / alcuni	OM360	141	192	06/71 > 12/76	S 0300 O	S 2162 N			
some / alcuni	OM360	141	192	06/71 > 12/76	S 0300 O	S 2162 N	S 5270 A		
power steering / servosterzo	OM360	141	192	06/71 > 12/76				S 3081 PO	
power steering / servosterzo	OM360	141	192	06/71 > 12/76				S 8790 PO	
LA 1513									
	OM352	91	124	10/67 > 12/77	S 0300 O	S 2161 N	S 2450 A		
	OM352	91	124	01/78 > 02/01	S 5124 PE	S 2161 N	S 2450 A		
some / alcuni	OM352	91	124	10/67 > 12/77	S 0300 O	S 2162 N	S 5270 A		
some / alcuni	OM352	91	124	01/78 > 02/01	S 5124 PE	S 2162 N	S 5270 A		
power steering / servosterzo	OM352	91	124	10/67 > 02/01				S 3081 PO	
power steering / servosterzo	OM352	91	124	10/67 > 02/01				S 8790 PO	
LA 1513									
	OM353A	124	168	01/72 > 02/01	S 2530 PO	S 2161 N	S 7998 A		
some / alcuni	OM353A	124	168	01/72 > 02/01	S 2530 PO	S 2161 N	S 6370 A		
power steering / servosterzo	OM353A	124	168	01/72 > 02/01				S 3081 PO	
power steering / servosterzo	OM353A	124	168	01/72 > 02/01				S 8790 PO	
LA 1519									
some / alcuni	OM360	141	192	06/71 > 12/76	S 0300 O	S 2162 N			
some / alcuni	OM360	141	192	06/71 > 12/76	S 0300 O	S 2162 N	S 5270 A		
power steering / servosterzo	OM360	141	192	06/71 > 12/76				S 8790 PO	
power steering / servosterzo	OM360	141	192	06/71 > 12/76				S 3081 PO	
16 t Serie									
1613									
	OM353	96	130	01/75 > 12/77	S 0300 O	S 2161 N			
	OM353	96	130	01/78 > 12/84	S 5124 PE	S 2161 N			
some / alcuni	OM353	96	130	01/75 > 12/77	S 0300 O	S 2161 N	S 1070 A		
some / alcuni	OM353	96	130	01/78 > 12/84	S 5124 PE	S 2161 N	S 1070 A		
power steering / servosterzo	OM353	96	130	01/75 > 12/84				S 3081 PO	
power steering / servosterzo	OM353	96	130	01/75 > 12/84				S 8790 PO	
1614									
to engine No. 916577 / a motore N. 916577	OM366	100	136	04/84 > 09/88	S 5124 PE	S 2161 N	S 1070 A		
some / alcuni	OM366	100	136	04/84 > 03/91		S 2161 N	S 6370 A		

M



...MERCEDES BENZ - trucks/autocarri

M

from engine No. 916578 / da motore N. 916578	OM366	100	136	10/88	>	03/91	S 5099 PE	S 2161 N	S 1070 A	
dryer filter / filtro essiccatore	OM366	100	136	01/85	>	03/91				S 7259 A
power steering / servosterzo	OM366	100	136	04/84	>	03/91				S 3081 PO
1617	OM353	124	168	01/75	>	12/77	S 0300 O	S 2161 N	S 1070 A	
	OM353	124	168	01/78	>	07/85	S 5124 PE	S 2161 N	S 1070 A	
some / alcuni	OM353	124	168	01/75	>	12/77	S 0300 O	S 2161 N	S 2450 A	
some / alcuni	OM353	124	168	01/75	>	12/77	S 0300 O	S 2161 N	S 1070 A	
some / alcuni	OM353	124	168	01/78	>	07/85	S 5124 PE	S 2161 N	S 2450 A	
some / alcuni	OM353	124	168	01/78	>	07/85	S 5124 PE	S 2161 N	S 5270 A	
power steering / servosterzo	OM353	124	168	01/75	>	07/85				S 3081 PO
power steering / servosterzo	OM353	124	168	01/75	>	07/85				S 8790 PO
1617 C										
to engine No. 923826 / a motore N. 923826	OM366A	125	170	04/84	>	09/88	S 8260 PO	S 2161 N	S 6370 A	
some / alcuni	OM366A	125	170	04/84	>	03/91		S 2161 N	S 2650 A	
some / alcuni	OM366A	125	170	01/89	>	03/91		S 2161 N	S 9570 A	
from engine No. 923827 / da motore N. 923827	OM366A	125	170	10/88	>	03/91	S 5124 PE	S 2161 N	S 6370 A	
dryer filter / filtro essiccatore	OM366A	125	170	01/85	>	03/91				S 7259 A
power steering / servosterzo	OM366A	125	170	04/84	>	03/91				S 3081 PO
1617 CA										
to engine No. 923826 / a motore N. 923826	OM366A	125	170	04/84	>	09/88	S 8260 PO	S 2161 N	S 6370 A	
some / alcuni	OM366A	125	170	04/84	>	03/91		S 2161 N	S 2650 A	
some / alcuni	OM366A	125	170	01/89	>	03/91		S 2161 N	S 9570 A	
from engine No. 923827 / da motore N. 923827	OM366A	125	170	10/88	>	03/91	S 5124 PE	S 2161 N	S 6370 A	
dryer filter / filtro essiccatore	OM366A	125	170	01/85	>	03/91				S 7259 A
power steering / servosterzo	OM366A	125	170	04/84	>	03/91				S 3081 PO
1617 CL										
to engine No. 923826 / a motore N. 923826	OM366A	125	170	04/84	>	09/88	S 8260 PO	S 2161 N	S 6370 A	
some / alcuni	OM366A	125	170	04/84	>	03/91		S 2161 N	S 2650 A	
some / alcuni	OM366A	125	170	01/89	>	03/91		S 2161 N	S 9570 A	
from engine No. 9237827 / da motore N. 9237827	OM366A	125	170	10/88	>	03/91	S 5124 PE	S 2161 N		
dryer filter / filtro essiccatore	OM366A	125	170	01/85	>	03/91				S 7259 A
power steering / servosterzo	OM366A	125	170	04/84	>	03/91				S 3081 PO
1619										
power steering / servosterzo	OM401	141	192	11/74	>	05/87	S 8260 PO	S 2161 N	S 6370 A	
	OM401	141	192	11/74	>	05/87				S 8790 PO
1619 C										
power steering / servosterzo	OM362LA	141	192	06/83	>	06/85	S 8260 PO	S 2161 N	S 6370 A	
	OM362LA	141	192	06/83	>	06/85				S 3081 PO
1619 K										
power steering / servosterzo	OM401	141	192	11/74	>	05/87	S 8260 PO	S 2161 N	S 6370 A	
	OM401	141	192	11/74	>	05/87				S 8790 PO
1619 L										
power steering / servosterzo	OM401	141	192	11/74	>	05/87	S 8260 PO	S 2161 N	S 6370 A	
	OM401	141	192	11/74	>	05/87				S 8790 PO
1620										
to engine No. 923826 / a motore N. 923826	OM366LA	150	204	07/85	>	09/88	S 8260 PO	S 2161 N	S 2650 A	
some / alcuni	OM366LA	150	204	07/85	>	03/91		S 2161 N	S 6370 A	
from engine No. 923827 / da motore N. 923827	OM366LA	150	204	10/88	>	03/91	S 5124 PE	S 2161 N	S 2650 A	
dryer filter / filtro essiccatore	OM366LA	150	204	07/85	>	03/91				S 7259 A
power steering / servosterzo	OM366LA	150	204	07/85	>	03/91				S 3081 PO
1620										
to engine No. 286114 / a motore N. 286114	OM366LA (356.950/356.993)	150	204				S 5124 PE	S 2161 N	S 2650 A	
some / alcuni	OM366LA (356.950/356.993)	150	204	04/91	>	09/96		S 2161 N	S 6370 A	
from engine No. 286115 / da motore N. 286115	OM366LA (356.950/356.993)	150	204					S 2161 N	S 2650 A	
dryer filter / filtro essiccatore	OM366LA (356.950/356.993)	150	204	04/91	>	09/96				S 7259 A
power steering / servosterzo	OM366LA (356.950/356.993)	150	204	04/91	>	09/96				S 3081 PO
1620 L										
to engine No. 923826 / a motore N. 923826	OM366LA	150	204	07/85	>	09/88	S 8260 PO	S 2161 N	S 2650 A	
some / alcuni	OM366LA	150	204	07/85	>	03/91		S 2161 N	S 6370 A	
from engine No. 923827 / da motore N. 923827	OM366LA	150	204	10/88	>	03/91	S 5124 PE	S 2161 N	S 2650 A	
dryer filter / filtro essiccatore	OM366LA	150	204	07/85	>	03/91				S 7259 A
power steering / servosterzo	OM366LA	150	204	07/85	>	03/91				S 3081 PO
1621										
	OM421	155	211	05/82	>	03/91	S 7261 PO	S 2162 N	S 6370 A	
1622										
some / alcuni	OM421	159	216	05/82	>	03/91	S 7261 PO	S 2162 N	S 6370 A	
	OM421	159	216	05/82	>	03/91	S 7261 PO	S 2161 N	S 6370 A	
1622										
some / alcuni	OM441	159	216	03/87	>	03/91	S 8260 PO	S 2162 N	S 7185 A	
some / alcuni	OM441	159	216	03/87	>	03/91	S 8260 PO	S 2161 N	S 7185 A	
dryer filter / filtro essiccatore	OM441	159	216	03/87	>	03/91				S 7259 A
power steering / servosterzo	OM441	159	216	03/87	>	03/91				S 3081 PO
1622 A										
some / alcuni	OM421	159	216	05/82	>	03/91	S 7261 PO	S 2162 N	S 6370 A	
	OM421	159	216	05/82	>	03/91	S 7261 PO	S 2161 N	S 6370 A	

**KW HP****...MERCEDES BENZ - trucks/autocarri**

1622 L	OM421	159 216	05/82 > 03/91	S 7261 PO	S 2162 N	S 6370 A	
some / alcuni	OM421	159 216	05/82 > 03/91	S 7261 PO	S 2161 N	S 6370 A	
1622 L	OM441	159 216	03/87 > 03/91	S 8260 PO	S 2162 N	S 7185 A	
some / alcuni	OM441	159 216	03/87 > 03/91	S 8260 PO	S 2161 N	S 7185 A	
dryer filter / filtro essiccatore	OM441	159 216	03/87 > 03/91				S 7259 A
power steering / servosterzo	OM441	159 216	03/87 > 03/91				S 3081 PO
1623	OM355	168 230	09/67 > 09/69	S 0300 O	S 2162 N	S 5270 A	
some / alcuni	OM355	168 230	09/67 > 09/69	S 0300 O	S 2162 N	S 5270 A	
power steering / servosterzo	OM355	168 230	09/67 > 09/69				S 3081 PO
power steering / servosterzo	OM355	168 230	09/67 > 09/69				S 8790 PO
1624	OM355	176 240	10/69 > 12/74	S 0300 O	S 2162 N		
some / alcuni	OM355	176 240	10/69 > 12/74	S 0300 O	S 2162 N	S 5270 A	
power steering / servosterzo	OM355	176 240	10/69 > 12/74				S 8790 PO
power steering / servosterzo	OM355	176 240	10/69 > 12/74				S 3081 PO
1624	OM402	176 240	05/75 > 03/82	S 8260 PO	S 2161 N	S 6370 A	
	OM402	176 240	04/82 > 12/82	S 8260 PO	S 2162 N	S 6370 A	
some / alcuni	OM402	176 240	05/75 > 03/82	S 7261 PO	S 2161 N	S 6370 A	
some / alcuni	OM402	176 240	04/82 > 12/82	S 7261 PO	S 2162 N	S 6370 A	
power steering / servosterzo	OM402	176 240	05/75 > 12/82				S 8790 PO
1624 K	OM402	176 240	04/75 > 03/82	S 8260 PO	S 2161 N	S 6370 A	
	OM402	176 240	04/82 > 12/82	S 8260 PO	S 2162 N	S 6370 A	
some / alcuni	OM402	176 240	04/75 > 03/82	S 7261 PO	S 2161 N	S 6370 A	
some / alcuni	OM402	176 240	04/82 > 12/82	S 7261 PO	S 2162 N	S 6370 A	
power steering / servosterzo	OM402	176 240	05/75 > 12/82				S 8790 PO
1624 L	OM402	176 240	05/75 > 03/82	S 8260 PO	S 2161 N	S 6370 A	
	OM402	176 240	04/82 > 12/82	S 8260 PO	S 2162 N	S 6370 A	
some / alcuni	OM402	176 240	05/75 > 03/82	S 7261 PO	S 2161 N	S 6370 A	
some / alcuni	OM402	176 240	04/82 > 12/82	S 7261 PO	S 2162 N	S 6370 A	
power steering / servosterzo	OM402	176 240	05/75 > 12/82				S 8790 PO
1624 S	OM402	176 240	05/75 > 03/82	S 8260 PO	S 2161 N	S 6370 A	
	OM402	176 240	04/82 > 12/82	S 8260 PO	S 2162 N	S 6370 A	
some / alcuni	OM402	176 240	05/75 > 03/82	S 7261 PO	S 2161 N	S 6370 A	
some / alcuni	OM402	176 240	04/82 > 12/82	S 7261 PO	S 2162 N	S 6370 A	
power steering / servosterzo	OM402	176 240	05/75 > 12/82				S 8790 PO
1625	OM422.909	184 250	05/80 > 06/82	S 7261 PO	S 2161 N	S 6370 A	
	OM422.909	184 250	07/82 > 02/90	S 7261 PO	S 2162 N	S 6370 A	
power steering / servosterzo	OM422.909	184 250	05/80 > 02/90				S 3081 PO
1625	OM442.905	184 250	03/87 > 02/90	S 8260 PO	S 2162 N	S 3570 A	
power steering / servosterzo	OM442.905	184 250	03/87 > 02/90				S 3081 PO
1625 A	OM422.909	184 250	05/80 > 06/82	S 7261 PO	S 2161 N	S 6370 A	
	OM422.909	184 250	07/82 > 02/90	S 7261 PO	S 2162 N	S 6370 A	
power steering / servosterzo	OM422.909	184 250	05/80 > 02/90				S 3081 PO
1625 L	OM422.909	184 250	05/80 > 06/82	S 7261 PO	S 2161 N	S 6370 A	
	OM422.909	184 250	07/82 > 02/90	S 7261 PO	S 2162 N	S 6370 A	
power steering / servosterzo	OM422.909	184 250	05/80 > 02/90				S 3081 PO
1625 L	OM442.905	184 250	03/87 > 02/90	S 8260 PO	S 2162 N	S 3570 A	
power steering / servosterzo	OM442.905	184 250	03/87 > 02/90				S 3081 PO
1626	OM402	188 256	05/74 > 12/80	S 8260 PO	S 2161 N	S 6370 A	
some / alcuni	OM402	188 256	05/74 > 12/80	S 7261 PO	S 2161 N	S 6370 A	
power steering / servosterzo	OM402	188 256	05/74 > 12/80				S 8790 PO
1628	OM422	206 280	01/80 > 06/82	S 7261 PO	S 2161 N	S 6370 A	
	OM422	206 280	07/82 > 05/89	S 7261 PO	S 2162 N	S 6370 A	
some / alcuni	OM422	206 280	01/80 > 06/82	S 7261 PO	S 2161 N	S 3570 A	
some / alcuni	OM422	206 280	07/82 > 05/89	S 7261 PO	S 2162 N	S 3570 A	
dryer filter / filtro essiccatore	OM422	206 280	01/85 > 05/89				S 7259 A
power steering / servosterzo	OM422	206 280	01/80 > 05/89				S 3081 PO
1628	OM441LA	206 280	07/87 > 02/90	S 8260 PO	S 2162 N	S 6370 A	
to frame No. 4785294 / a telaio N. 4785294	OM441LA	206 280	07/87 > 02/90	S 8260 PO	S 2162 N	S 3570 A	
from frame No. 4785295 / da telaio N. 4785295	OM441LA	206 280	07/87 > 02/90				S 7259 A
dryer filter / filtro essiccatore	OM441LA	206 280	07/87 > 02/90				S 3081 PO
power steering / servosterzo	OM441LA	206 280	07/87 > 02/90				S 3081 PO
1628 L	OM422	206 280	01/80 > 06/82	S 7261 PO	S 2161 N	S 6370 A	
	OM422	206 280	07/82 > 05/89	S 7261 PO	S 2162 N	S 6370 A	
some / alcuni	OM422	206 280	01/80 > 06/82	S 7261 PO	S 2161 N	S 3570 A	
some / alcuni	OM422	206 280	07/82 > 05/89	S 7261 PO	S 2162 N	S 3570 A	
dryer filter / filtro essiccatore	OM422	206 280	01/85 > 05/89				S 7259 A
power steering / servosterzo	OM422	206 280	01/80 > 05/89				S 3081 PO

M

**KW HP****...MERCEDES BENZ - trucks/autocarri****M**

1628 L									
to frame No. 4785294 / a telaio N. 4785294	OM441LA	206 280	07/87 > 02/90	S 8260 PO	S 2162 N	S 6370 A			
from frame No. 4785295 / da telaio N. 4785295	OM441LA	206 280	07/87 > 02/90	S 8260 PO	S 2162 N	S 3570 A			
dryer filter / filtro essiccatore	OM441LA	206 280	07/87 > 02/90						S 7259 A
power steering / servosterzo	OM441LA	206 280	07/87 > 02/90						S 3081 PO
1632									
	OM403	235 320	05/74 > 03/82	S 7261 PO	S 2161 N	S 3570 A			
	OM403	235 320	04/82 > 12/82	S 7261 PO	S 2162 N	S 3570 A			
power steering / servosterzo	OM403	235 320	05/74 > 12/82						S 8790 PO
1632									
	OM403.905	235 320	05/74 > 03/82		S 2161 N	S 3570 A			
	OM403.905	235 320	04/82 > 12/82		S 2162 N	S 3570 A			
power steering / servosterzo	OM403.905	235 320	05/74 > 12/82						S 8790 PO
1633									
	OM422A	243 330	10/80 > 05/87	S 7261 PO	S 2162 N	S 9570 A			
dryer filter / filtro essiccatore	OM422A	243 330	01/85 > 05/87						S 7259 A
power steering / servosterzo	OM422A	243 330	10/80 > 05/87						S 3081 PO
1633 L									
	OM422A	243 330	10/80 > 05/87	S 7261 PO	S 2162 N	S 9570 A			
dryer filter / filtro essiccatore	OM422A	243 330	01/85 > 05/87						S 7259 A
power steering / servosterzo	OM422A	243 330	10/80 > 05/87						S 3081 PO
1635									
to frame No. 5343252 / a telaio N. 5343252	OM442A	260 354	02/86 > 04/88	S 7261 PO	S 2162 N	S 9570 A			
some / alcuni	OM442A	260 354	09/88 > 07/89	S 7261 PO	S 2162 N	S 2450 A			
from frame No. 5343253 / da telaio N. 5343253	OM442A	260 354	02/86 > 07/89			S 7474 A			
from frame No. 5343253 / da telaio N. 5343253	OM442A	260 354	05/88 > 07/89	S 7261 PO	S 2162 N	S 1670 A			
series L (Silent) / Serie L (Silent)	OM442A	260 354	02/86 > 07/89	S 7261 PO	S 2162 N	S 7185 A			
power steering / servosterzo	OM442A	260 354	02/86 > 07/89						S 3081 PO
1635 L									
to frame No. 5343252 / a telaio N. 5343252	OM442A	260 354	02/86 > 04/88	S 7261 PO	S 2162 N	S 9570 A			
some / alcuni	OM442A	260 354	09/88 > 07/89	S 7261 PO	S 2162 N	S 2450 A			
from frame No. 5343253 / da telaio N. 5343253	OM442A	260 354	05/88 > 07/89	S 7261 PO	S 2162 N	S 1670 A			
series L (Silent) / Serie L (Silent)	OM442A	260 354	02/86 > 07/89	S 7261 PO	S 2162 N	S 7185 A			
power steering / servosterzo	OM442A	260 354	02/86 > 07/89						S 3081 PO
1636									
	OM423	261 355	12/83 > 03/91	S 7261 PO	S 2162 N	S 3570 A			
dryer filter / filtro essiccatore	OM423	261 355	01/85 > 03/91						S 7259 A
power steering / servosterzo	OM423	261 355	12/83 > 03/91						S 3081 PO
1636 L									
	OM423	261 355	12/83 > 03/91	S 7261 PO	S 2162 N	S 3570 A			
dryer filter / filtro essiccatore	OM423	261 355	01/85 > 03/91						S 7259 A
power steering / servosterzo	OM423	261 355	12/83 > 03/91						S 3081 PO
1638									
	OM422LA	276 376	11/80 > 12/86	S 7261 PO	S 2162 N	S 9570 A			
power steering / servosterzo	OM422LA	276 376	11/80 > 12/86						S 3081 PO
1644									
to frame No. 5343252 / a telaio N. 5343252	OM442LA	320 435		S 7261 PO	S 2162 N	S 9570 A			
from frame No. 5343253 / da telaio N. 5343253	OM442LA	320 435		S 7261 PO	S 2162 N	S 1670 A			
dryer filter / filtro essiccatore	OM442LA	320 435	06/86 > 08/89						S 7259 A
power steering / servosterzo	OM442LA	320 435	06/86 > 08/89						S 3081 PO
1644 LS									
to frame No. 5343252 / a telaio N. 5343252	OM442LA	320 435		S 7261 PO	S 2162 N	S 9570 A			
from frame No. 5343253 / da telaio N. 5343253	OM442LA	320 435		S 7261 PO	S 2162 N	S 1670 A			
dryer filter / filtro essiccatore	OM442LA	320 435	06/86 > 08/89						S 7259 A
power steering / servosterzo	OM442LA	320 435	06/86 > 08/89						S 3081 PO
L 1623									
	OM355	168 230	09/67 > 09/69	S 0300 O	S 2162 N	S 5270 A			
some / alcuni	OM355	168 230	09/67 > 09/69	S 0300 O	S 2162 N	S 5270 A			
power steering / servosterzo	OM355	168 230	09/67 > 09/69						S 3081 PO
power steering / servosterzo	OM355	168 230	09/67 > 09/69						S 8790 PO
17 t Serie									
1714									
to engine No. 286114 / a motore N. 286114	OM366	100 136		S 5099 PE	S 2161 N				
some / alcuni	OM366	100 136	02/91 >		S 2161 N	S 7185 A			
from engine No. 286115 / da motore N. 286115	OM366	100 136			S 2161 N				
dryer filter / filtro essiccatore	OM366	100 136	02/91 >						S 7259 A
power steering / servosterzo	OM366	100 136	02/91 >						S 3081 PO
1714 K									
to engine No. 286114 / a motore N. 286114	OM366	100 136		S 5099 PE	S 2161 N				
some / alcuni	OM366	100 136	02/91 >		S 2161 N	S 7185 A			
from engine No. 286115 / da motore N. 286115	OM366	100 136			S 2161 N				
dryer filter / filtro essiccatore	OM366	100 136	02/91 >						S 7259 A
power steering / servosterzo	OM366	100 136	02/91 >						S 3081 PO
1717									
to engine No. 923826 / a motore N. 923826	OM366A	129 175		S 8260 PO	S 2161 N	S 6370 A			



kW HP



...MERCEDES BENZ - trucks/autocarri

some / alcuni	OM366A	129	175	09/89 >	08/94		S 2161 N	S 2650 A	
some / alcuni	OM366A	129	175	09/89 >	08/94		S 2161 N	S 9570 A	
from engine No. 923827 / da motore N. 923827	OM366A	129	175			S 5124 PE	S 2161 N	S 6370 A	
dryer filter / filtro essiccatore	OM366A	129	175	09/89 >	08/94				S 7259 A
power steering / servosterzo	OM366A	129	175	09/89 >	08/94				S 3081 PO
1717 AK									
	OM366A			07/95 >			S 2161 N	S 6370 A	
some / alcuni	OM366A			07/95 >			S 2161 N	S 9570 A	
some / alcuni	OM366A			07/95 >			S 2161 N	S 2650 A	
dryer filter / filtro essiccatore	OM366A			07/95 >					S 7259 A
power steering / servosterzo	OM366A			07/95 >					S 3081 PO
1717 AK									
to engine No. 923826 / a motore N. 923826	OM366A	129	175			S 8260 PO	S 2161 N	S 6370 A	
some / alcuni	OM366A	129	175	09/89 >	08/94		S 2161 N	S 9570 A	
some / alcuni	OM366A	129	175	09/89 >	08/94		S 2161 N	S 2650 A	
from engine No. 923827 / da motore N. 923827	OM366A	129	175			S 5124 PE	S 2161 N	S 6370 A	
dryer filter / filtro essiccatore	OM366A	129	175	09/89 >	08/94				S 7259 A
power steering / servosterzo	OM366A	129	175	09/89 >	08/94				S 3081 PO
1717 L									
to engine No. 923826 / a motore N. 923826	OM366A					S 8260 PO	S 2161 N	S 6370 A	
some / alcuni	OM366A			09/89 >	08/94		S 2161 N	S 9570 A	
some / alcuni	OM366A			09/89 >	08/94		S 2161 N	S 2650 A	
from engine No. 923827 / da motore N. 923827	OM366A					S 5124 PE	S 2161 N	S 6370 A	
dryer filter / filtro essiccatore	OM366A			09/89 >	08/94				S 7259 A
power steering / servosterzo	OM366A			09/89 >	08/94				S 3081 PO
1718									
to engine No. 923826 / a motore N. 923826	OM366A					S 8260 PO	S 2161 N	S 6370 A	
some / alcuni	OM366A			07/90 >			S 2161 N	S 2650 A	
some / alcuni	OM366A			07/90 >			S 2161 N	S 9570 A	
from engine No. 923827 / da motore N. 923827	OM366A					S 5124 PE	S 2161 N	S 6370 A	
dryer filter / filtro essiccatore	OM366A			07/90 >					S 7259 A
power steering / servosterzo	OM366A			07/90 >					S 3081 PO
1718 K									
to engine No. 923826 / a motore N. 923826	OM366A					S 8260 PO	S 2161 N	S 6370 A	
some / alcuni	OM366A			07/90 >			S 2161 N	S 2650 A	
some / alcuni	OM366A			07/90 >			S 2161 N	S 9570 A	
from engine No. 923827 / da motore N. 923827	OM366A					S 5124 PE	S 2161 N	S 6370 A	
dryer filter / filtro essiccatore	OM366A			07/90 >					S 7259 A
power steering / servosterzo	OM366A			07/90 >					S 3081 PO
1719									
	OM401			09/73 >	03/82	S 8260 PO	S 2161 N	S 6370 A	
	OM401			04/82 >	08/82	S 8260 PO	S 2162 N	S 6370 A	
power steering / servosterzo	OM401			09/73 >	08/82				S 8790 PO
1720									
to engine No. 923826 / a motore N. 923826	OM356LA (366)					S 8260 PO	S 2161 N	S 2650 A	
some / alcuni	OM356LA (366)			02/90 >			S 2161 N	S 6370 A	
from engine No. 923827 / da motore N. 923827	OM356LA (366)					S 5124 PE	S 2161 N	S 2650 A	
dryer filter / filtro essiccatore	OM356LA (366)			02/90 >					S 7259 A
power steering / servosterzo	OM356LA (366)			02/90 >					S 3081 PO
1720 L									
to engine No. 923826 / a motore N. 923826	OM356LA (366)					S 8260 PO	S 2161 N	S 2650 A	
some / alcuni	OM356LA (366)			02/90 >			S 2161 N	S 6370 A	
from engine No. 923827 / da motore N. 923827	OM356LA (366)					S 5124 PE	S 2161 N	S 2650 A	
dryer filter / filtro essiccatore	OM356LA (366)			02/90 >					S 7259 A
power steering / servosterzo	OM356LA (366)			02/90 >					S 3081 PO
1721									
to engine No. 286114 / a motore N. 286114	OM366LA					S 5124 PE	S 2161 N	S 7185 A	
some / alcuni	OM366LA			12/94 >			S 2161 N	S 6370 A	
from engine No. 286115 / da motore N. 286115	OM366LA						S 2161 N	S 7185 A	
dryer filter / filtro essiccatore	OM366LA			12/94 >					S 7259 A
power steering / servosterzo	OM366LA			12/94 >					S 3081 PO
1721 S									
to engine No. 286114 / a motore N. 286114	OM366LA					S 5124 PE	S 2161 N	S 7185 A	
some / alcuni	OM366LA			12/94 >			S 2161 N	S 6370 A	
from engine No. 286115 / da motore N. 286115	OM366LA						S 2161 N	S 7185 A	
dryer filter / filtro essiccatore	OM366LA			12/94 >					S 7259 A
power steering / servosterzo	OM366LA			12/94 >					S 3081 PO
1722									
	OM421			05/82 >		S 7261 PO	S 2162 N	S 6370 A	
1722	OM441.905/OM441.923	160	218	12/88 >	09/93	S 8260 PO		S 7185 A	✗

M



**KW HP****...MERCEDES BENZ - trucks/autocarri****M**

dryer filter / filtro essiccatore	OM441.905/OM441.923	160	218	12/88 >	09/93			S 2162 N		S 7259 A
2 filters / N.2 filtri	OM441.905/OM441.923	160	218	12/88 >	09/93					
power steering / servosterzo	OM441.905/OM441.923	160	218	12/88 >	09/93					S 3081 PO
1722 AK	OM441			12/88 >	08/94			S 2162 N	S 7185 A	
dryer filter / filtro essiccatore	OM441			12/88 >	08/94					S 7259 A
power steering / servosterzo	OM441			12/88 >	08/94					S 3081 PO
1722 K	OM441			12/88 >	08/94			S 2162 N	S 7185 A	
dryer filter / filtro essiccatore	OM441			12/88 >	08/94					S 7259 A
power steering / servosterzo	OM441			12/88 >	08/94					S 3081 PO
1722 SK	OM441			12/88 >	08/94			S 2162 N	S 7185 A	
dryer filter / filtro essiccatore	OM441			12/88 >	08/94					S 7259 A
power steering / servosterzo	OM441			12/88 >	08/94					S 3081 PO
1726	OM442	191	260	12/88 >	12/89	S 7261 PO			S 7185 A	✗
	OM442	191	260	08/90 >	09/93	S 5133 PE			S 7185 A	✗
some / alcuni	OM442	191	260	01/90 >	07/90	S 7261 PO			S 7185 A	✗
some / alcuni	OM442	191	260	01/90 >	07/90	S 5133 PE			S 7185 A	✗
dryer filter / filtro essiccatore	OM442	191	260	12/88 >	09/93					S 7259 A
2 filters / N.2 filtri	OM442	191	260	12/88 >	09/93			S 2162 N		
power steering / servosterzo	OM442	191	260	12/88 >	09/93					S 3081 PO
1726 AK	OM442			12/88 >	09/93	S 7261 PO	S 2162 N		S 7185 A	
dryer filter / filtro essiccatore	OM442			12/88 >	09/93					S 7259 A
power steering / servosterzo	OM442			12/88 >	09/93					S 3081 PO
1726 L	OM442			12/88 >	09/93	S 7261 PO	S 2162 N		S 7185 A	
dryer filter / filtro essiccatore	OM442			12/88 >	09/93					S 7259 A
power steering / servosterzo	OM442			12/88 >	09/93					S 3081 PO
1729	OM442	213	290	07/88 >	12/89	S 7261 PO			S 7185 A	✗
	OM442	213	290	08/90 >	05/94	S 5133 PE			S 7185 A	✗
	OM442	213	290	06/94 >	09/96	S 5133 PE			S 7185 A	S 3056 C
some / alcuni	OM442	213	290	01/90 >	07/90	S 7261 PO			S 7185 A	✗
some / alcuni	OM442	213	290	01/90 >	07/90	S 5133 PE			S 7185 A	✗
dryer filter / filtro essiccatore	OM442	213	290	07/88 >	09/96					S 7259 A
2 filters / N.2 filtri	OM442	213	290	07/88 >	09/96			S 2162 N		
power steering / servosterzo	OM442	213	290	07/88 >	09/96					S 3081 PO
1729 A	OM442	213	290	07/88 >	12/89	S 7261 PO			S 7185 A	✗
	OM442	213	290	08/90 >	05/94	S 5133 PE			S 7185 A	✗
	OM442	213	290	06/94 >	09/96	S 5133 PE			S 7185 A	S 3056 C
some / alcuni	OM442	213	290	01/90 >	07/90	S 7261 PO			S 7185 A	✗
some / alcuni	OM442	213	290	01/90 >	07/90	S 5133 PE			S 7185 A	✗
dryer filter / filtro essiccatore	OM442	213	290	07/88 >	09/96					S 7259 A
2 filters / N.2 filtri	OM442	213	290	07/88 >	09/96			S 2162 N		
power steering / servosterzo	OM442	213	290	07/88 >	09/96					S 3081 PO
1729 AK (SK)	OM442	213	290	07/88 >	12/89	S 7261 PO			S 7185 A	✗
	OM442	213	290	08/90 >	01/95	S 5133 PE			S 7185 A	✗
	OM442	213	290	02/95 >	09/96	S 5133 PE			S 7185 A	
some / alcuni	OM442	213	290	01/90 >	07/90	S 7261 PO			S 7185 A	✗
some / alcuni	OM442	213	290	01/90 >	07/90	S 5133 PE			S 7185 A	✗
dryer filter / filtro essiccatore	OM442	213	290	07/88 >	09/96					S 7259 A
2 filters / N.2 filtri	OM442	213	290	07/88 >	09/96			S 2162 N		
power steering / servosterzo	OM442	213	290	07/88 >	09/96					S 3081 PO
1729 K (SK)	OM442	213	290	07/88 >	12/89	S 7261 PO			S 7185 A	✗
	OM442	213	290	08/90 >	01/95	S 5133 PE			S 7185 A	✗
	OM442	213	290	02/95 >	09/96	S 5133 PE			S 7185 A	
some / alcuni	OM442	213	290	01/90 >	07/90	S 7261 PO			S 7185 A	✗
some / alcuni	OM442	213	290	01/90 >	07/90	S 5133 PE			S 7185 A	✗
dryer filter / filtro essiccatore	OM442	213	290	07/88 >	09/96					S 7259 A
2 filters / N.2 filtri	OM442	213	290	07/88 >	09/96			S 2162 N		
power steering / servosterzo	OM442	213	290	07/88 >	09/96					S 3081 PO
1729 L (SK)	OM442	213	290	07/88 >	12/89	S 7261 PO			S 7185 A	✗
	OM442	213	290	08/90 >	05/94	S 5133 PE			S 7185 A	✗
	OM442	213	290	06/94 >	09/96	S 5133 PE			S 7185 A	S 3056 C
some / alcuni	OM442	213	290	01/90 >	07/90	S 7261 PO			S 7185 A	✗
some / alcuni	OM442	213	290	01/90 >	07/90	S 5133 PE			S 7185 A	✗
dryer filter / filtro essiccatore	OM442	213	290	07/88 >	09/96					S 7259 A
2 filters / N.2 filtri	OM442	213	290	07/88 >	09/96			S 2162 N		
power steering / servosterzo	OM442	213	290	07/88 >	09/96					S 3081 PO
1733	OM441LA			01/89 >	07/92			S 2162 N	S 7185 A	
some / alcuni	OM441LA			01/89 >	07/92			S 2162 N	S 1670 A	



kW HP



...MERCEDES BENZ - trucks/autocarri

dryer filter / filtro essiccatore	OM441LA			01/89 > 07/92				S 7259 A
power steering / servosterzo	OM441LA			01/89 > 07/92				S 3081 PO
1733 L	OM441LA			01/89 > 07/92		S 2162 N	S 7185 A	
some / alcuni	OM441LA			01/89 > 07/92		S 2162 N	S 1670 A	
dryer filter / filtro essiccatore	OM441LA			01/89 > 07/92				S 7259 A
power steering / servosterzo	OM441LA			01/89 > 07/92				S 3081 PO
1735	OM440A (442)			07/91 > 08/94		S 2162 N	S 1670 A	
some / alcuni	OM440A (442)			07/91 > 08/94		S 2162 N	S 2450 A	
dryer filter / filtro essiccatore	OM440A (442)			07/91 > 08/94				S 7259 A
series L (Silent) / Serie L (Silent)	OM440A (442)			07/91 > 08/94		S 2162 N	S 7185 A	
power steering / servosterzo	OM440A (442)			07/91 > 08/94				S 3081 PO
1735	OM442A			07/88 > 09/93			S 7474 A	
	OM442A			07/88 > 08/94	S 7261 PO	S 2162 N	S 1670 A	
some / alcuni	OM442A			07/88 > 08/94	S 7261 PO	S 2162 N	S 2450 A	
dryer filter / filtro essiccatore	OM442A			07/88 > 08/94				S 7259 A
series L (Silent) / Serie L (Silent)	OM442A			07/88 > 08/94	S 7261 PO	S 2162 N	S 7185 A	
power steering / servosterzo	OM442A			07/88 > 08/94				S 3081 PO
1735 AK	OM440A (442)			07/91 > 08/94		S 2162 N	S 1670 A	
some / alcuni	OM440A (442)			07/91 > 08/94		S 2162 N	S 2450 A	
dryer filter / filtro essiccatore	OM440A (442)			07/91 > 08/94				S 7259 A
series L (Silent) / Serie L (Silent)	OM440A (442)			07/91 > 08/94		S 2162 N	S 7185 A	
power steering / servosterzo	OM440A (442)			07/91 > 08/94				S 3081 PO
1735 AK	OM442A			07/88 > 08/94	S 7261 PO	S 2162 N	S 1670 A	
some / alcuni	OM442A			07/88 > 08/94	S 7261 PO	S 2162 N	S 2450 A	
dryer filter / filtro essiccatore	OM442A			07/88 > 08/94				S 7259 A
series L (Silent) / Serie L (Silent)	OM442A			07/88 > 08/94	S 7261 PO	S 2162 N	S 7185 A	
power steering / servosterzo	OM442A			07/88 > 08/94				S 3081 PO
1735 L	OM440A (442)			07/91 > 08/94		S 2162 N	S 1670 A	
some / alcuni	OM440A (442)			07/91 > 08/94		S 2162 N	S 2450 A	
dryer filter / filtro essiccatore	OM440A (442)			07/91 > 08/94				S 7259 A
series L (Silent) / Serie L (Silent)	OM440A (442)			07/91 > 08/94		S 2162 N	S 7185 A	
power steering / servosterzo	OM440A (442)			07/91 > 08/94				S 3081 PO
1735 L	OM442A			07/88 > 08/94	S 7261 PO	S 2162 N	S 1670 A	
some / alcuni	OM442A			07/88 > 08/94	S 7261 PO	S 2162 N	S 2450 A	
dryer filter / filtro essiccatore	OM442A			07/88 > 08/94				S 7259 A
series L (Silent) / Serie L (Silent)	OM442A			07/88 > 08/94	S 7261 PO	S 2162 N	S 7185 A	
power steering / servosterzo	OM442A			07/88 > 08/94				S 3081 PO
1748	OM442LA			07/88 > 07/90	S 7261 PO	S 2162 N	S 9570 A	
	OM442LA			09/88 > 07/92			S 7474 A	
some / alcuni	OM442LA			07/88 > 07/92	S 7261 PO	S 2162 N	S 1670 A	
dryer filter / filtro essiccatore	OM442LA			07/88 > 07/92				S 7259 A
power steering / servosterzo	OM442LA			07/88 > 07/92				S 3081 PO
1748 L	OM442LA			07/88 > 07/90	S 7261 PO	S 2162 N	S 9570 A	
some / alcuni	OM442LA			07/88 > 07/92	S 7261 PO	S 2162 N	S 1670 A	
dryer filter / filtro essiccatore	OM442LA			07/88 > 07/92				S 7259 A
power steering / servosterzo	OM442LA			07/88 > 07/92				S 3081 PO
18 t Serie								
1813	OM352	96	130	01/68 > 12/69	S 2530 PO	S 2161 N		
some / alcuni	OM352	96	130	01/68 > 12/69	S 2530 PO	S 2161 N	S 6370 A	
power steering / servosterzo	OM352	96	130	01/68 > 12/69				S 3081 PO
power steering / servosterzo	OM352	96	130	01/68 > 12/69				S 8790 PO
1813 L	OM352	96	130	01/68 > 12/69	S 2530 PO	S 2161 N		
some / alcuni	OM352	96	130	01/68 > 12/69	S 2530 PO	S 2161 N	S 6370 A	
power steering / servosterzo	OM352	96	130	01/68 > 12/69				S 8790 PO
power steering / servosterzo	OM352	96	130	01/68 > 12/69				S 3081 PO
1819	OM360	141	192	01/72 > 12/76	S 0300 O	S 2162 N		
some / alcuni	OM360	141	192	01/72 > 12/76	S 0300 O	S 2162 N	S 5270 A	
power steering / servosterzo	OM360	141	192	01/72 > 12/76				S 3081 PO
power steering / servosterzo	OM360	141	192	01/72 > 12/76				S 8790 PO
1819 L	OM360	141	192	01/72 > 12/76	S 0300 O	S 2162 N		
some / alcuni	OM360	141	192	01/72 > 12/76	S 0300 O	S 2162 N	S 5270 A	
power steering / servosterzo	OM360	141	192	01/72 > 12/76				S 8790 PO
power steering / servosterzo	OM360	141	192	01/72 > 12/76				S 3081 PO
1820								
to engine No. 286114 / a motore N. 286114	OM356LA (366)	155	211		S 5124 PE	S 2161 N	S 2650 A	
some / alcuni	OM356LA (366)	155	211	01/91 >		S 2161 N	S 6370 A	
from engine No. 286115 / da motore N. 286115	OM356LA (366)	155	211			S 2161 N	S 2650 A	

M



**KW HP****...MERCEDES BENZ - trucks/autocarri****M**

dryer filter / filtro essiccatore	OM356LA (366)	155	211	01/91	>				S 7259 A
power steering / servosterzo	OM356LA (366)	155	211	01/91	>				S 3081 PO
1820 L									
to engine No. 286114 / a motore N. 286114	OM356LA (366)	155	211			S 5124 PE	S 2161 N	S 2650 A	
some / alcuni	OM356LA (366)	155	211	01/91	>		S 2161 N	S 6370 A	
from engine No. 286115 / da motore N. 286115	OM356LA (366)	155	211				S 2161 N	S 2650 A	
dryer filter / filtro essiccatore	OM356LA (366)	155	211	01/91	>				S 7259 A
power steering / servosterzo	OM356LA (366)	155	211	01/91	>				S 3081 PO
1821									
to engine No. 286114 / a motore N. 286114	OM366A	155	211			S 5124 PE	S 2162 N	S 7185 A	
from engine No. 286115 / da motore N. 286115	OM366A	155	211				S 2162 N	S 7185 A	
1824	OM401LA	180	245	08/92	>		S 2162 N	S 7185 A	
dryer filter / filtro essiccatore	OM401LA	180	245	08/92	>				S 7259 A
power steering / servosterzo	OM401LA	180	245	08/92	>				S 3081 PO
1824 L	OM401LA	180	245	08/92	>		S 2162 N	S 7185 A	
dryer filter / filtro essiccatore	OM401LA	180	245	08/92	>				S 7259 A
power steering / servosterzo	OM401LA	180	245	08/92	>				S 3081 PO
1827	OM401LA	200	272	12/90	>		S 2162 N	S 7185 A	
dryer filter / filtro essiccatore	OM401LA	200	272	12/90	>				S 7259 A
power steering / servosterzo	OM401LA	200	272	12/90	>				S 3081 PO
1827	OM445LA (441)	200	272	01/94	>		S 2162 N	S 7185 A	
dryer filter / filtro essiccatore	OM445LA (441)	200	272	01/94	>				S 7259 A
power steering / servosterzo	OM445LA (441)	200	272	01/94	>				S 3081 PO
1827 L	OM401LA	200	272	12/90	>		S 2162 N	S 7185 A	
dryer filter / filtro essiccatore	OM401LA	200	272	12/90	>				S 7259 A
power steering / servosterzo	OM401LA	200	272	12/90	>				S 3081 PO
1827 L	OM445LA (441)	200	272	01/94	>		S 2162 N	S 7185 A	
dryer filter / filtro essiccatore	OM445LA (441)	200	272	01/94	>				S 7259 A
power steering / servosterzo	OM445LA (441)	200	272	01/94	>				S 3081 PO
1831	OM401LA	230	313	12/90	>		S 2162 N	S 7185 A	
dryer filter / filtro essiccatore	OM401LA	230	313	12/90	>				S 7259 A
power steering / servosterzo	OM401LA	230	313	12/90	>				S 3081 PO
1831	OM445LA (441)	230	313	01/94	>		S 2162 N	S 7185 A	
dryer filter / filtro essiccatore	OM445LA (441)	230	313	01/94	>				S 7259 A
power steering / servosterzo	OM445LA (441)	230	313	01/94	>				S 3081 PO
1831 AK	OM401LA	230	313	12/90	>		S 2162 N	S 7185 A	
dryer filter / filtro essiccatore	OM401LA	230	313	12/90	>				S 7259 A
power steering / servosterzo	OM401LA	230	313	12/90	>				S 3081 PO
1831 AK	OM445LA (441)	230	313	01/94	>		S 2162 N	S 7185 A	
dryer filter / filtro essiccatore	OM445LA (441)	230	313	01/94	>				S 7259 A
power steering / servosterzo	OM445LA (441)	230	313	01/94	>				S 3081 PO
1831 L	OM401LA	230	313	12/90	>		S 2162 N	S 7185 A	
dryer filter / filtro essiccatore	OM401LA	230	313	12/90	>				S 7259 A
power steering / servosterzo	OM401LA	230	313	12/90	>				S 3081 PO
1831 L	OM445LA (441)	230	313	01/94	>		S 2162 N	S 7185 A	
dryer filter / filtro essiccatore	OM445LA (441)	230	313	01/94	>				S 7259 A
power steering / servosterzo	OM445LA (441)	230	313	01/94	>				S 3081 PO
1834	OM441LA	250	340	01/91	>		S 2162 N	S 7185 A	
dryer filter / filtro essiccatore	OM441LA	250	340	01/91	>				S 7259 A
power steering / servosterzo	OM441LA	250	340	01/91	>				S 3081 PO
1834	OM445LA (441)	250	340	01/94	>		S 2162 N	S 7185 A	
dryer filter / filtro essiccatore	OM445LA (441)	250	340	01/94	>				S 7259 A
power steering / servosterzo	OM445LA (441)	250	340	01/94	>				S 3081 PO
1834 L	OM441LA	250	340	01/91	>		S 2162 N	S 7185 A	
dryer filter / filtro essiccatore	OM441LA	250	340	01/91	>				S 7259 A
power steering / servosterzo	OM441LA	250	340	01/91	>				S 3081 PO
1834 L	OM445LA (441)	250	340	01/94	>		S 2162 N	S 7185 A	
dryer filter / filtro essiccatore	OM445LA (441)	250	340	01/94	>				S 7259 A
power steering / servosterzo	OM445LA (441)	250	340	01/94	>				S 3081 PO
1838	OM402LA	280	381	12/90	>		S 2162 N	S 7185 A	
some / alcuni	OM402LA	280	381	12/90	>	05/94	S 2162 N	S 1670 A	
some / alcuni	OM402LA	280	381	06/94	>		S 2162 N	S 1670 A	S 3056 C
dryer filter / filtro essiccatore	OM402LA	280	381	12/90	>				S 7259 A
power steering / servosterzo	OM402LA	280	381	12/90	>				S 3081 PO
1838	OM446LA (442)	280	381	06/95	>		S 2162 N	S 7185 A	S 3056 C
some / alcuni	OM446LA (442)	280	381	06/95	>		S 2162 N	S 1670 A	S 3056 C
dryer filter / filtro essiccatore	OM446LA (442)	280	381	06/95	>				S 7259 A

**KW HP****...MERCEDES BENZ - trucks/autocarri**

power steering / servosterzo	OM446LA (442)	280	381	06/95 >				S 3081 PO
1838 AK	OM402LA	280	381	12/90 >			S 2162 N	S 7185 A
some / alcuni	OM402LA	280	381	12/90 > 05/94			S 2162 N	S 1670 A
some / alcuni	OM402LA	280	381	06/94 >			S 2162 N	S 1670 A
dryer filter / filtro essiccatore	OM402LA	280	381	12/90 >				S 7259 A
power steering / servosterzo	OM402LA	280	381	12/90 >				S 3081 PO
1838 AK	OM446LA (442)	280	381	06/95 >			S 2162 N	S 7185 A
some / alcuni	OM446LA (442)	280	381	06/95 >			S 2162 N	S 1670 A
dryer filter / filtro essiccatore	OM446LA (442)	280	381	06/95 >				S 7259 A
power steering / servosterzo	OM446LA (442)	280	381	06/95 >				S 3081 PO
1838 L (SK)	OM402LA	280	381	12/90 >			S 2162 N	S 7185 A
some / alcuni	OM402LA	280	381	12/90 > 05/94			S 2162 N	S 1670 A
some / alcuni	OM402LA	280	381	06/94 >			S 2162 N	S 1670 A
dryer filter / filtro essiccatore	OM402LA	280	381	12/90 >				S 7259 A
power steering / servosterzo	OM402LA	280	381	12/90 >				S 3081 PO
1838 L (SK)	OM446LA (442)	280	381	06/95 >			S 2162 N	S 7185 A
some / alcuni	OM446LA (442)	280	381	06/95 >			S 2162 N	S 1670 A
dryer filter / filtro essiccatore	OM446LA (442)	280	381	06/95 >				S 7259 A
power steering / servosterzo	OM446LA (442)	280	381	06/95 >				S 3081 PO
1840	OM402LA	280	381	07/91 > 07/92			S 2162 N	S 7185 A
some / alcuni	OM402LA	280	381	07/91 > 07/92			S 2162 N	S 1670 A
some / alcuni	OM402LA	280	381	07/91 > 07/92			S 2162 N	S 7213 A
dryer filter / filtro essiccatore	OM402LA	280	381	07/91 > 07/92				S 7259 A
power steering / servosterzo	OM402LA	280	381	07/91 > 07/92				S 3081 PO
1840 LS	OM402LA	280	381	07/91 > 07/92			S 2162 N	S 7185 A
some / alcuni	OM402LA	280	381	07/91 > 07/92			S 2162 N	S 1670 A
some / alcuni	OM402LA	280	381	07/91 > 07/92			S 2162 N	S 7213 A
dryer filter / filtro essiccatore	OM402LA	280	381	07/91 > 07/92				S 7259 A
power steering / servosterzo	OM402LA	280	381	07/91 > 07/92				S 3081 PO
1844								
to frame No. 5343252 / a telaio N. 5343252	OM440LA (442)	320	435				S 2162 N	S 9570 A
some / alcuni	OM440LA (442)	320	435	06/93 > 05/94			S 2162 N	S 7213 A
some / alcuni	OM440LA (442)	320	435	06/94 >			S 2162 N	S 7213 A
from frame No. 5343253 / da telaio N. 5343253	OM440LA (442)	320	435				S 2162 N	S 1670 A
dryer filter / filtro essiccatore	OM440LA (442)	320	435	11/91 >				S 7259 A
power steering / servosterzo	OM440LA (442)	320	435	11/91 >				S 3081 PO
1844								
to frame No. 5343252 / a telaio N. 5343252	OM446LA (442)	320	435				S 2162 N	S 9570 A
some / alcuni	OM446LA (442)	320	435	01/94 > 05/94			S 2162 N	S 7213 A
some / alcuni	OM446LA (442)	320	435	06/94 >			S 2162 N	S 7213 A
from frame No. 5343253 / da telaio N. 5343253	OM446LA (442)	320	435				S 2162 N	S 1670 A
dryer filter / filtro essiccatore	OM446LA (442)	320	435	01/94 >				S 7259 A
power steering / servosterzo	OM446LA (442)	320	435	01/94 >				S 3081 PO
1844 L (SK)								
to frame No. 5343252 / a telaio N. 5343252	OM440LA (442)	320	435				S 2162 N	S 9570 A
some / alcuni	OM440LA (442)	320	435	06/93 > 05/94			S 2162 N	S 7213 A
some / alcuni	OM440LA (442)	320	435	06/94 >			S 2162 N	S 7213 A
from frame No. 5343253 / da telaio N. 5343253	OM440LA (442)	320	435				S 2162 N	S 1670 A
dryer filter / filtro essiccatore	OM440LA (442)	320	435	11/91 >				S 7259 A
power steering / servosterzo	OM440LA (442)	320	435	11/91 >				S 3081 PO
1844 L (SK)								
to frame No. 5343252 / a telaio N. 5343252	OM446LA (442)	320	435				S 2162 N	S 9570 A
some / alcuni	OM446LA (442)	320	435	01/94 > 05/94			S 2162 N	S 7213 A
some / alcuni	OM446LA (442)	320	435	06/94 >			S 2162 N	S 7213 A
from frame No. 5343253 / da telaio N. 5343253	OM446LA (442)	320	435				S 2162 N	S 1670 A
dryer filter / filtro essiccatore	OM446LA (442)	320	435	01/94 >				S 7259 A
power steering / servosterzo	OM446LA (442)	320	435	01/94 >				S 3081 PO
1850	OM442LA	370	503	01/91 >			S 2162 N	S 7185 A
some / alcuni	OM442LA	370	503	01/91 > 05/94			S 2162 N	S 1670 A
some / alcuni	OM442LA	370	503	01/91 > 05/94			S 2162 N	S 7213 A
some / alcuni	OM442LA	370	503	06/94 >			S 2162 N	S 1670 A
some / alcuni	OM442LA	370	503	06/94 >			S 2162 N	S 7213 A
power steering / servosterzo	OM442LA	370	503	01/91 >				S 3081 PO
1850 L (SK)	OM442LA	370	503	01/91 > 09/96	S 5133 PE			S 7185 A
some / alcuni	OM442LA	370	503	01/91 > 05/94				S 1670 A
some / alcuni	OM442LA	370	503	01/91 > 05/94				S 7213 A
some / alcuni	OM442LA	370	503	06/94 > 09/96				S 1670 A

M

**KW HP****...MERCEDES BENZ - trucks/autocarri****M**

some / alcuni	OM442LA	370	503	06/94	>	09/96			S 7213 A	S 3056 C
2 filters / N.2 filtri	OM442LA	370	503	01/91	>	09/96		S 2162 N		
power steering / servosterzo	OM442LA	370	503	01/91	>	09/96				S 3081 PO
1853	OM446LA (442)	390	530	01/96	>	09/96	S 5133 PE		S 7213 A	S 3056 C
dryer filter / filtro essiccatore	OM446LA (442)	390	530	01/96	>	09/96				S 7259 A
2 filters / N.2 filtri	OM446LA (442)	390	530	01/96	>	09/96		S 2162 N		
power steering / servosterzo	OM446LA (442)	390	530	01/96	>	09/96				S 3081 PO
1853 AK	OM446LA (442)	390	530	01/96	>	09/96	S 5133 PE		S 7213 A	
dryer filter / filtro essiccatore	OM446LA (442)	390	530	01/96	>	09/96				S 7259 A
2 filters / N.2 filtri	OM446LA (442)	390	530	01/96	>	09/96		S 2162 N		
power steering / servosterzo	OM446LA (442)	390	530	01/96	>	09/96				S 3081 PO
1853 L (SK)	OM446LA (442)	390	530	01/96	>	09/96	S 5133 PE		S 7213 A	S 3056 C
dryer filter / filtro essiccatore	OM446LA (442)	390	530	01/96	>	09/96				S 7259 A
2 filters / N.2 filtri	OM446LA (442)	390	530	01/96	>	09/96		S 2162 N		
power steering / servosterzo	OM446LA (442)	390	530	01/96	>	09/96				S 3081 PO
19 t Serie										
1919	OM401	141	192	05/74	>	03/82	S 8260 PO	S 2161 N	S 6370 A	
	OM401	141	192	04/82	>	08/82	S 8260 PO	S 2162 N	S 6370 A	
power steering / servosterzo	OM401	141	192	05/74	>	08/82				S 8790 PO
1922	OM421.905	160	218	10/81	>	03/91	S 7261 PO	S 2162 N	S 6370 A	
power steering / servosterzo	OM421.905	160	218	10/81	>	03/91				S 3081 PO
1922 (SK)	OM441	160	218	05/89	>	08/94		S 2162 N	S 7185 A	
dryer filter / filtro essiccatore	OM441	160	218	05/89	>	08/94				S 7259 A
power steering / servosterzo	OM441	160	218	05/89	>	08/94				S 3081 PO
1923	OM355	168	230	09/67	>	09/69	S 0300 O	S 2162 N	S 2450 A	
some / alcuni	OM355	168	230	09/67	>	09/69	S 0300 O	S 2162 N	S 5270 A	
power steering / servosterzo	OM355	168	230	09/67	>	09/69				S 3081 PO
power steering / servosterzo	OM355	168	230	09/67	>	09/69				S 8790 PO
1924	OM355	177	241	05/79	>	02/01	S 9490 PO	S 2162 N	S 5270 A	
power steering / servosterzo	OM355	177	241	05/79	>	02/01				S 3081 PO
power steering / servosterzo	OM355	177	241	05/79	>	02/01				S 8790 PO
1924	OM355V	176	240	09/69	>	12/74	S 0300 O	S 2162 N	S 5270 A	
power steering / servosterzo	OM355V	176	240	09/69	>	12/74				S 8790 PO
power steering / servosterzo	OM355V	176	240	09/69	>	12/74				S 3081 PO
1926	OM402	188	256	08/73	>	12/80	S 8260 PO	S 2161 N	S 6370 A	
some / alcuni	OM402	188	256	08/73	>	12/80	S 7261 PO	S 2161 N	S 6370 A	
power steering / servosterzo	OM402	188	256	08/73	>	12/80				S 8790 PO
1926 AK	OM402	188	256	08/73	>	12/80	S 8260 PO	S 2161 N	S 6370 A	
some / alcuni	OM402	188	256	08/73	>	12/80	S 7261 PO	S 2161 N	S 6370 A	
power steering / servosterzo	OM402	188	256	08/73	>	12/80				S 8790 PO
1926 K	OM402	188	256	08/73	>	12/80	S 8260 PO	S 2161 N	S 6370 A	
some / alcuni	OM402	188	256	08/73	>	12/80	S 7261 PO	S 2161 N	S 6370 A	
power steering / servosterzo	OM402	188	256	08/73	>	12/80				S 8790 PO
1928	OM422	206	280	01/80	>	06/82	S 7261 PO	S 2161 N	S 6370 A	
	OM422	206	280	07/82	>	05/89	S 7261 PO	S 2162 N	S 6370 A	
some / alcuni	OM422	206	280	01/80	>	06/82	S 7261 PO	S 2161 N	S 3570 A	
some / alcuni	OM422	206	280	07/82	>	05/89	S 7261 PO	S 2162 N	S 3570 A	
power steering / servosterzo	OM422	206	280	01/80	>	05/89				S 3081 PO
1928	OM442.908	206	280	03/87	>	05/89	S 7261 PO	S 2162 N	S 6370 A	
some / alcuni	OM442.908	206	280	03/87	>	05/89	S 7261 PO	S 2162 N	S 3570 A	
dryer filter / filtro essiccatore	OM442.908	206	280	03/87	>	05/89				S 7259 A
power steering / servosterzo	OM442.908	206	280	03/87	>	05/89				S 3081 PO
1929 (SK)	OM442	213	290	07/88	>	12/89	S 7261 PO	S 2162 N	S 7185 A	
	OM442	213	290	08/90	>	05/94		S 2162 N	S 7185 A	
	OM442	213	290	06/94	>	09/96		S 2162 N	S 7185 A	S 3056 C
some / alcuni	OM442	213	290	01/90	>	07/90	S 7261 PO	S 2162 N	S 7185 A	
dryer filter / filtro essiccatore	OM442	213	290	07/88	>	09/96				S 7259 A
power steering / servosterzo	OM442	213	290	07/88	>	09/96				S 3081 PO
1929 AK (SK)	OM442	213	290	07/88	>	12/89	S 7261 PO	S 2162 N	S 7185 A	
	OM442	213	290	08/90	>	09/96		S 2162 N	S 7185 A	
some / alcuni	OM442	213	290	01/90	>	07/90	S 7261 PO	S 2162 N	S 7185 A	
dryer filter / filtro essiccatore	OM442	213	290	07/88	>	09/96				S 7259 A
power steering / servosterzo	OM442	213	290	07/88	>	09/96				S 3081 PO
1929 K (SK)	OM442	213	290	07/88	>	12/89	S 7261 PO	S 2162 N	S 7185 A	
	OM442	213	290	08/90	>	09/96		S 2162 N	S 7185 A	
some / alcuni	OM442	213	290	01/90	>	07/90	S 7261 PO	S 2162 N	S 7185 A	
dryer filter / filtro essiccatore	OM442	213	290	07/88	>	09/96				S 7259 A

**KW HP****...MERCEDES BENZ - trucks/autocarri**

power steering / servosterzo	OM422	213	290	07/88	>	09/96				S 3081 PO
1932	OM403	235	320	08/73	>	03/82	S 7261 PO	S 2161 N	S 3570 A	
	OM403	235	320	04/82	>	09/83	S 7261 PO	S 2162 N	S 3570 A	
power steering / servosterzo	OM403	235	320	08/73	>	09/83				S 8790 PO
1932	OM403.905	235	320	08/73	>	03/82		S 2161 N	S 3570 A	
	OM403.905	235	320	04/82	>	09/83		S 2162 N	S 3570 A	
power steering / servosterzo	OM403.905	235	320	08/73	>	09/83				S 8790 PO
1932 AK	OM403	235	320	08/73	>	03/82	S 7261 PO	S 2161 N	S 3570 A	
	OM403	235	320	04/82	>	09/83	S 7261 PO	S 2162 N	S 3570 A	
power steering / servosterzo	OM403	235	320	08/73	>	09/83				S 8790 PO
1932 AK	OM403.905	235	320	08/73	>	03/82		S 2161 N	S 3570 A	
	OM403.905	235	320	04/82	>	09/83		S 2162 N	S 3570 A	
power steering / servosterzo	OM403.905	235	320	08/73	>	09/83				S 8790 PO
1933	OM422A	243	330	11/80	>	03/91	S 7261 PO	S 2162 N	S 9570 A	
dryer filter / filtro essiccatore	OM422A	243	330	07/85	>	03/91				S 7259 A
power steering / servosterzo	OM422A	243	330	11/80	>	03/91				S 3081 PO
1933	OM441LA	243	330	01/89	>	07/92		S 2162 N	S 7185 A	
some / alcuni	OM441LA	243	330	01/89	>	07/92		S 2162 N	S 1670 A	
dryer filter / filtro essiccatore	OM441LA	243	330	01/89	>	07/92				S 7259 A
power steering / servosterzo	OM441LA	243	330	01/89	>	07/92				S 3081 PO
1935	OM442A	260	354	02/86	>	04/88	S 7261 PO	S 2162 N	S 9570 A	
	OM442A	260	354	05/88	>	12/89	S 7261 PO	S 2162 N	S 1670 A	
	OM442A	260	354	05/89	>	09/93			S 7474 A	
	OM442A	260	354	08/90	>	08/94		S 2162 N	S 1670 A	
some / alcuni	OM442A	260	354	02/86	>	08/94		S 2162 N	S 7185 A	
some / alcuni	OM442A	260	354	09/88	>	08/94		S 2162 N	S 2450 A	
some / alcuni	OM442A	260	354	01/90	>	07/90	S 7261 PO	S 2162 N		
dryer filter / filtro essiccatore	OM442A	260	354	02/86	>	08/94				S 7259 A
power steering / servosterzo	OM442A	260	354	02/86	>	08/94				S 3081 PO
1935 A	OM440A (442)	250	340	07/91	>	05/94		S 2162 N	S 1670 A	
	OM440A (442)	250	340	06/94	>	09/96		S 2162 N	S 1670 A	S 3056 C
some / alcuni	OM440A (442)	250	340	07/91	>	05/94		S 2162 N	S 2450 A	
some / alcuni	OM440A (442)	250	340	06/94	>	09/96		S 2162 N	S 2450 A	S 3056 C
dryer filter / filtro essiccatore	OM440A (442)	250	340	07/91	>	09/96				S 7259 A
series L (Silent) / Serie L (Silent)	OM440A (442)	250	340	07/91	>	05/94		S 2162 N	S 7185 A	
series L (Silent) / Serie L (Silent)	OM440A (442)	250	340	06/94	>	09/96		S 2162 N	S 2450 A	S 3056 C
power steering / servosterzo	OM440A (442)	250	340	07/91	>	09/96				S 3081 PO
1935 A	OM442A	260	354	02/86	>	04/88	S 7261 PO	S 2162 N	S 9570 A	
	OM442A	260	354	05/88	>	12/89	S 7261 PO	S 2162 N	S 1670 A	
	OM442A	260	354	08/90	>	08/94		S 2162 N	S 1670 A	
some / alcuni	OM442A	260	354	09/88	>	08/94		S 2162 N	S 2450 A	
some / alcuni	OM442A	260	354	01/90	>	07/90	S 7261 PO	S 2162 N		
some L (Silent) / alcuni L (Silent)	OM442A	260	354	02/86	>	08/94		S 2162 N	S 7185 A	
dryer filter / filtro essiccatore	OM442A	260	354	02/86	>	08/94				S 7259 A
power steering / servosterzo	OM442A	260	354	02/86	>	08/94				S 3081 PO
1935 AK (SK)	OM440A (442)	250	340	07/91	>	09/96		S 2162 N	S 1670 A	
	OM440A (442)	250	340	12/91	>	09/96			S 7474 A	
some / alcuni	OM440A (442)	250	340	07/91	>	09/96		S 2162 N	S 2450 A	
dryer filter / filtro essiccatore	OM440A (442)	250	340	07/91	>	09/96				S 7259 A
series L (Silent) / Serie L (Silent)	OM440A (442)	250	340	07/91	>	09/96		S 2162 N	S 7185 A	
power steering / servosterzo	OM440A (442)	250	340	07/91	>	09/96				S 3081 PO
1935 LS	OM442A	260	354	02/86	>	04/88	S 7261 PO	S 2162 N	S 9570 A	
	OM442A	260	354	05/88	>	12/89	S 7261 PO	S 2162 N	S 1670 A	
	OM442A	260	354	08/90	>	08/94		S 2162 N	S 1670 A	
some / alcuni	OM442A	260	354	02/86	>	08/94		S 2162 N	S 7185 A	
some / alcuni	OM442A	260	354	09/88	>	08/94		S 2162 N	S 2450 A	
some / alcuni	OM442A	260	354	01/90	>	07/90	S 7261 PO	S 2162 N		
dryer filter / filtro essiccatore	OM442A	260	354	02/86	>	08/94				S 7259 A
power steering / servosterzo	OM442A	260	354	02/86	>	08/94				S 3081 PO
1936	OM423	261	355	10/81	>	03/91	S 7261 PO	S 2162 N	S 3570 A	
power steering / servosterzo	OM423	261	355	10/81	>	03/91				S 3081 PO
1936 A	OM423	261	355	10/81	>	03/91	S 7261 PO	S 2162 N	S 3570 A	
power steering / servosterzo	OM423	261	355	10/81	>	03/91				S 3081 PO
1938	OM422LA	276	376	11/80	>	06/90	S 7261 PO	S 2162 N	S 9570 A	
power steering / servosterzo	OM422LA	276	376	11/80	>	06/90				S 3081 PO
1940	OM402/OM442LA	280	381	07/91	>	07/92		S 2162 N	S 7185 A	
some / alcuni	OM402/OM442LA	280	381	07/91	>	07/92		S 2162 N	S 1670 A	

M



kW HP



...MERCEDES BENZ - trucks/autocarri

M



some / alcuni	OM402/OM442LA	280	381	07/91	>	07/92		S 2162 N	S 7213 A	
power steering / servosterzo	OM402/OM442LA	280	381	07/91	>	07/92				S 3081 PO
1944	OM442LA	320	435	10/85	>	04/88	S 7261 PO	S 2162 N	S 9570 A	
	OM442LA	320	435	05/88	>	12/89	S 7261 PO	S 2162 N	S 1670 A	
dryer filter / filtro essiccatore	OM442LA	320	435	10/85	>	12/89				S 7259 A
power steering / servosterzo	OM442LA	320	435	10/85	>	12/89				S 3081 PO
1944 LS	OM442LA	320	435	10/85	>	04/88	S 7261 PO	S 2162 N	S 9570 A	
	OM442LA	320	435	05/88	>	12/89	S 7261 PO	S 2162 N	S 1670 A	
dryer filter / filtro essiccatore	OM442LA	320	435	10/85	>	12/89				S 7259 A
power steering / servosterzo	OM442LA	320	435	10/85	>	12/89				S 3081 PO
1948	OM442LA	353	480	09/88	>	12/89	S 7261 PO	S 2162 N	S 9570 A	
	OM442LA	353	480	01/90	>	05/91		S 2162 N	S 9570 A	
	OM442LA	353	480	06/91	>	07/92		S 2162 N	S 1670 A	
some / alcuni	OM442LA	353	480	01/90	>	07/90	S 7261 PO	S 2162 N		
dryer filter / filtro essiccatore	OM442LA	353	480	09/88	>	07/92				S 7259 A
or / oppure	OM442LA	353	480	09/88	>	07/92			S 7474 A	
power steering / servosterzo	OM442LA	353	480	09/88	>	07/92				S 3081 PO
L1923	OM355	168	230	09/67	>	09/69	S 0300 O	S 2162 N	S 2450 A	
some / alcuni	OM355	168	230	09/67	>	09/69	S 0300 O	S 2162 N	S 5270 A	
power steering / servosterzo	OM355	168	230	09/67	>	09/69				S 3081 PO
power steering / servosterzo	OM355	168	230	09/67	>	09/69				S 8790 PO
L1924	OM355	177	241	05/79	>	02/01	S 9490 PO	S 2162 N	S 5270 A	
power steering / servosterzo	OM355	177	241	05/79	>	02/01				S 3081 PO
power steering / servosterzo	OM355	177	241	05/79	>	02/01				S 8790 PO
L1924	OM355V	176	240	09/69	>	12/74	S 0300 O	S 2162 N	S 5270 A	
power steering / servosterzo	OM355V	176	240	09/69	>	12/74				S 8790 PO
power steering / servosterzo	OM355V	176	240	09/69	>	12/74				S 3081 PO
L1928	OM355A	206	280	05/79	>	02/01	S 9490 PO	S 2162 N	S 0450 A	
power steering / servosterzo	OM355A	206	280	05/79	>	02/01				S 3081 PO
LA1924	OM355V	176	240	09/69	>	12/74	S 0300 O	S 2162 N	S 5270 A	
power steering / servosterzo	OM355V	176	240	09/69	>	12/74				S 3081 PO
power steering / servosterzo	OM355V	176	240	09/69	>	12/74				S 8790 PO
20 t Serie										
2023	OM355	168	230	09/67	>	09/69	S 0300 O	S 2162 N	S 5270 A	
some / alcuni	OM355	168	230	09/67	>	09/69	S 0300 O	S 2162 N	S 5270 A	
power steering / servosterzo	OM355	168	230	09/67	>	09/69				S 3081 PO
power steering / servosterzo	OM355	168	230	09/67	>	09/69				S 8790 PO
2024	OM355 V	176	240	09/69	>	12/74	S 0300 O	S 2162 N		
some / alcuni	OM355 V	176	240	09/69	>	12/74	S 0300 O	S 2162 N	S 5270 A	
power steering / servosterzo	OM355 V	176	240	09/69	>	12/74				S 3081 PO
power steering / servosterzo	OM355 V	176	240	09/69	>	12/74				S 8790 PO
2024	OM356 (OM357)	177	240	01/84	>	12/98		S 2161 N		
to engine No. 286114 / a motore N. 286114	OM356 (OM357)	177	240	01/84	>		S 5124 PE			
with R.H.D. / con guida a destra	OM356 (OM357)	177	240	01/84	>	12/98			S 2650 A	
with L.H.D. / con guida a sinistra	OM356 (OM357)	177	240	01/84	>	12/98			S 7187 A	
from engine No. 286115 / da motore N. 286115	OM356 (OM357)	177	240		>	12/98	S 5132 PE			
dryer filter / filtro essiccatore	OM356 (OM357)	177	240	01/84	>	12/98				S 7259 A
power steering / servosterzo	OM356 (OM357)	177	240	01/84	>	12/98				S 3081 PO
2024	OM401LA	180	245	02/93	>			S 2162 N	S 7185 A	S 3056 C
dryer filter / filtro essiccatore	OM401LA	180	245	02/93	>					S 7259 A
power steering / servosterzo	OM401LA	180	245	02/93	>					S 3081 PO
power steering / servosterzo	OM401LA	180	245	02/93	>					S 8790 PO
2024 A (SK)	OM401LA	180	245	02/93	>			S 2162 N	S 7185 A	S 3056 C
dryer filter / filtro essiccatore	OM401LA	180	245	02/93	>					S 7259 A
power steering / servosterzo	OM401LA	180	245	02/93	>					S 3081 PO
2025	OM422	184	250	08/83	>	03/91	S 7261 PO	S 2162 N	S 6370 A	
dryer filter / filtro essiccatore	OM422	184	250	01/85	>	03/91				S 7259 A
power steering / servosterzo	OM422	184	250	08/83	>	03/91				S 3081 PO
2025	OM442.905	184	250	04/87	>	03/91	S 8260 PO	S 2162 N	S 3570 A	
dryer filter / filtro essiccatore	OM442.905	184	250	04/87	>	03/91				S 7259 A
power steering / servosterzo	OM442.905	184	250	04/87	>	03/91				S 3081 PO
2025 S	OM422	184	250	08/83	>	03/91	S 7261 PO	S 2162 N	S 6370 A	
dryer filter / filtro essiccatore	OM422	184	250	01/85	>	03/91				S 7259 A
power steering / servosterzo	OM422	184	250	08/83	>	03/91				S 3081 PO
2025 S	OM442.905	184	250	04/87	>	03/91	S 8260 PO	S 2162 N	S 3570 A	
dryer filter / filtro essiccatore	OM442.905	184	250	04/87	>	03/91				S 7259 A
power steering / servosterzo	OM442.905	184	250	04/87	>	03/91				S 3081 PO

**KW HP****...MERCEDES BENZ - trucks/autocarri**

2026	OM402	188	256	10/76 >	12/80	S 8260 PO	S 2161 N	S 6370 A	
some / alcuni	OM402	188	256	10/76 >	12/80	S 7261 PO	S 2161 N	S 6370 A	
power steering / servosterzo	OM402	188	256	10/76 >	12/80				S 8790 PO
2026 S	OM402	188	256	10/76 >	12/80	S 8260 PO	S 2161 N	S 6370 A	
some / alcuni	OM402	188	256	10/76 >	12/80	S 7261 PO	S 2161 N	S 6370 A	
power steering / servosterzo	OM402	188	256	10/76 >	12/80				S 8790 PO
2028	OM422	206	280	01/80 >	06/82	S 7261 PO	S 2161 N	S 6370 A	
	OM422	206	280	07/82 >	06/89	S 7261 PO	S 2162 N	S 6370 A	
some / alcuni	OM422	206	280	04/81 >	06/82	S 7261 PO	S 2161 N	S 3570 A	
some / alcuni	OM422	206	280	07/82 >	06/89	S 7261 PO	S 2162 N	S 3570 A	
dryer filter / filtro essiccatore	OM422	206	280	01/85 >	06/89				S 7259 A
power steering / servosterzo	OM422	206	280	01/80 >	06/89				S 3081 PO
2028 LS	OM422	206	280	01/80 >	06/82	S 7261 PO	S 2161 N	S 3570 A	
	OM422	206	280	07/82 >	06/89	S 7261 PO	S 2162 N	S 3570 A	
some / alcuni	OM422	206	280	04/81 >	06/82	S 7261 PO	S 2161 N	S 3570 A	
dryer filter / filtro essiccatore	OM422	206	280	01/85 >	06/89				S 7259 A
power steering / servosterzo	OM422	206	280	01/80 >	06/89				S 3081 PO
2028 LS 6x2	OM422	206	280	11/83 >	06/89	S 7261 PO	S 2162 N		
some / alcuni	OM422	206	280	11/83 >	06/89	S 7261 PO	S 2162 N	S 2450 A	
dryer filter / filtro essiccatore	OM422	206	280	01/85 >	06/89				S 7259 A
power steering / servosterzo	OM422	206	280	11/83 >	06/89				S 3081 PO
2028 LS 6x4	OM422	206	280	11/83 >	06/89	S 7261 PO	S 2162 N		
some / alcuni	OM422	206	280	11/83 >	06/89	S 7261 PO	S 2162 N	S 2450 A	
dryer filter / filtro essiccatore	OM422	206	280	01/85 >	06/89				S 7259 A
power steering / servosterzo	OM422	206	280	11/83 >	06/89				S 3081 PO
2031 (SK)	OM401LA	230	313	04/91 >			S 2162 N	S 7185 A	S 3056 C
dryer filter / filtro essiccatore	OM401LA	230	313	04/91 >					S 7259 A
power steering / servosterzo	OM401LA	230	313	04/91 >					S 3081 PO
2032	OM403	235	320	08/75 >	03/82	S 7261 PO	S 2161 N	S 3570 A	
	OM403	235	320	04/82 >	09/83	S 7261 PO	S 2162 N	S 3570 A	
power steering / servosterzo	OM403	235	320	08/75 >	09/83				S 8790 PO
2032 S	OM403	235	320	08/75 >	03/82	S 7261 PO	S 2161 N	S 3570 A	
	OM403	235	320	04/82 >	09/83	S 7261 PO	S 2162 N	S 3570 A	
power steering / servosterzo	OM403	235	320	08/75 >	09/83				S 8790 PO
2033	OM422A	243	330	12/81 >	05/87	S 7261 PO	S 2162 N	S 9570 A	
power steering / servosterzo	OM422A	243	330	12/81 >	05/87				S 3081 PO
2033 LS	OM422A	243	330	12/81 >	05/87	S 7261 PO	S 2162 N	S 9570 A	
power steering / servosterzo	OM422A	243	330	12/81 >	05/87				S 3081 PO
2033 LS 6x2	OM422A	243	330	06/83 >	05/87	S 7261 PO	S 2162 N		
some / alcuni	OM422A	243	330	06/83 >	05/87	S 7261 PO	S 2162 N	S 2450 A	
power steering / servosterzo	OM422A	243	330	06/83 >	05/87				S 3081 PO
2033 LS 6x4	OM422A	243	330	06/83 >	05/87	S 7261 PO	S 2162 N		
some / alcuni	OM422A	243	330	06/83 >	05/87	S 7261 PO	S 2162 N	S 2450 A	
power steering / servosterzo	OM422A	243	330	06/83 >	05/87				S 3081 PO
2035									
to frame No. 5343252 / a telaio N. 5343252	OM442A	260	354	06/86 >	04/88	S 7261 PO	S 2162 N	S 9570 A	
some / alcuni	OM442A	260	354	09/88 >	07/89	S 7261 PO	S 2162 N	S 2450 A	
from frame No. 5343253 / da telaio N. 5343253	OM442A	260	354	03/86 >	07/88			S 7474 A	
from frame No. 5343253 / da telaio N. 5343253	OM442A	260	354	05/88 >	07/89	S 7261 PO	S 2162 N	S 1670 A	
series L (Silent) / Serie L (Silent)	OM442A	260	354	06/86 >	07/89	S 7261 PO	S 2162 N	S 7185 A	
power steering / servosterzo	OM442A	260	354	06/86 >	07/89				S 3081 PO
2035 LS									
to frame No. 5343252 / a telaio N. 5343252	OM442A	260	354	06/86 >	04/88	S 7261 PO	S 2162 N	S 9570 A	
some / alcuni	OM442A	260	354	09/88 >	07/89	S 7261 PO	S 2162 N	S 2450 A	
from frame No. 5343253 / da telaio N. 5343253	OM442A	260	354	06/86 >	07/89			S 7474 A	
from frame No. 5343253 / da telaio N. 5343253	OM442A	260	354	05/88 >	07/89	S 7261 PO	S 2162 N	S 1670 A	
series L (Silent) / Serie L (Silent)	OM442A	260	354	06/86 >	07/89	S 7261 PO	S 2162 N	S 7185 A	
power steering / servosterzo	OM442A	260	354	06/86 >	07/89				S 3081 PO
2035 S									
to frame No. 5343252 / a telaio N. 5343252	OM442A	260	354	06/86 >	04/88	S 7261 PO	S 2162 N	S 9570 A	
some / alcuni	OM442A	260	354	09/88 >	07/89	S 7261 PO	S 2162 N	S 2450 A	
from frame No. 5343253 / da telaio N. 5343253	OM442A	260	354	06/86 >	07/89			S 7474 A	
from frame No. 5343253 / da telaio N. 5343253	OM442A	260	354	05/88 >	07/89	S 7261 PO	S 2162 N	S 1670 A	
series L (Silent) / Serie L (Silent)	OM442A	260	354	06/86 >	07/89	S 7261 PO	S 2162 N	S 7185 A	
power steering / servosterzo	OM442A	260	354	06/86 >	07/89				S 3081 PO
2036	OM423	261	355	03/84 >	03/91	S 7261 PO	S 2162 N	S 3570 A	
dryer filter / filtro essiccatore	OM423	261	355	01/85 >	03/91				S 7259 A

M

**KW HP****...MERCEDES BENZ - trucks/autocarri****M**

power steering / servosterzo	OM423	261	355	03/84 >	03/91				S 3081 PO
2036 LS	OM423	261	355	03/84 >	03/91	S 7261 PO	S 2162 N	S 3570 A	
dryer filter / filtro essiccatore	OM423	261	355	01/85 >	03/91				S 7259 A
power steering / servosterzo	OM423	261	355	03/84 >	03/91				S 3081 PO
2038	OM402LA	280	381	11/91 >			S 2162 N	S 7185 A	
some / alcuni	OM402LA	280	381	11/91 >	05/94		S 2162 N	S 1670 A	
some / alcuni	OM402LA	280	381	06/94 >			S 2162 N	S 1670 A	S 3056 C
dryer filter / filtro essiccatore	OM402LA	280	381	11/91 >					S 7259 A
power steering / servosterzo	OM402LA	280	381	11/91 >					S 3081 PO
2038 AS (SK)	OM402LA	280	381	11/91 >			S 2162 N	S 7185 A	
some / alcuni	OM402LA	280	381	11/91 >	05/94		S 2162 N	S 1670 A	
some / alcuni	OM402LA	280	381	06/94 >			S 2162 N	S 1670 A	S 3056 C
dryer filter / filtro essiccatore	OM402LA	280	381	11/91 >					S 7259 A
power steering / servosterzo	OM402LA	280	381	11/91 >					S 3081 PO
2044 (SK)									
to frame No. 5343252 / a telaio N. 5343252	OM440LA (442)	320	435				S 2162 N	S 9570 A	S 3056 C
some / alcuni	OM440LA (442)	320	435	06/93 >	05/94		S 2162 N	S 7213 A	
some / alcuni	OM440LA (442)	320	435	01/94 >			S 2162 N	S 7213 A	S 3056 C
from frame No. 5343253 / da telaio N. 5343253	OM440LA (442)	320	435				S 2162 N	S 1670 A	S 3056 C
dryer filter / filtro essiccatore	OM440LA (442)	320	435	01/92 >					S 7259 A
power steering / servosterzo	OM440LA (442)	320	435	01/92 >					S 3081 PO
2044 (SK)									
to frame No. 5343252 / a telaio N. 5343252	OM446LA (442)	320	435				S 2162 N	S 9570 A	S 3056 C
some / alcuni	OM446LA (442)	320	435	01/94 >	05/94		S 2162 N	S 7213 A	
some / alcuni	OM446LA (442)	320	435	06/94 >			S 2162 N	S 7213 A	S 3056 C
from frame No. 5343253 / da telaio N. 5343253	OM446LA (442)	320	435				S 2162 N	S 1670 A	S 3056 C
dryer filter / filtro essiccatore	OM446LA (442)	320	435	01/94 >					S 7259 A
power steering / servosterzo	OM446LA (442)	320	435	01/94 >					S 3081 PO
2050 (SK)	OM442LA (440)	370	503	01/91 >	05/94		S 2162 N	S 7185 A	
	OM442LA (440)	370	503	06/94 >			S 2162 N	S 7185 A	S 3056 C
some / alcuni	OM442LA (440)	370	503	01/91 >	05/94		S 2162 N	S 1670 A	
some / alcuni	OM442LA (440)	370	503	01/91 >	05/94		S 2162 N	S 7213 A	
some / alcuni	OM442LA (440)	370	503	06/94 >			S 2162 N	S 1670 A	S 3056 C
some / alcuni	OM442LA (440)	370	503	06/94 >			S 2162 N	S 7213 A	S 3056 C
dryer filter / filtro essiccatore	OM442LA (440)	370	503	01/91 >	02/01				S 7259 A
power steering / servosterzo	OM442LA (440)	370	503	01/91 >	02/01				S 3081 PO
2050 (SK)	OM446LA (422)	370	503	01/96 >			S 2162 N	S 7185 A	S 3056 C
some / alcuni	OM446LA (422)	370	503	01/96 >			S 2162 N	S 7213 A	S 3056 C
some / alcuni	OM446LA (422)	370	503	01/96 >			S 2162 N	S 1670 A	S 3056 C
dryer filter / filtro essiccatore	OM446LA (422)	370	503	01/96 >					S 7259 A
power steering / servosterzo	OM446LA (422)	370	503	01/96 >					S 3081 PO
2053 (SK)	OM446LA (442)	390	530	01/96 >			S 2162 N	S 7213 A	S 3056 C
dryer filter / filtro essiccatore	OM446LA (442)	390	530	01/96 >					S 7259 A
power steering / servosterzo	OM446LA (442)	390	530	01/96 >					S 3081 PO
L 2023	OM355	168	230	09/67 >	09/69	S 0300 O	S 2162 N	S 5270 A	
some / alcuni	OM355	168	230	09/67 >	09/69	S 0300 O	S 2162 N	S 5270 A	
power steering / servosterzo	OM355	168	230	09/67 >	09/69				S 8790 PO
power steering / servosterzo	OM355	168	230	09/67 >	09/69				S 3081 PO
LP 2032	OM403	235	320	08/75 >	03/82	S 7261 PO	S 2161 N	S 3570 A	
	OM403	235	320	04/82 >	09/83	S 7261 PO	S 2162 N	S 3570 A	
power steering / servosterzo	OM403	235	320	08/75 >	09/83				S 8790 PO
LPS 2024	OM355 V	176	240	09/69 >	12/74	S 0300 O	S 2162 N		
some / alcuni	OM355 V	176	240			S 0300 O	S 2162 N	S 5270 A	
power steering / servosterzo	OM355 V	176	240	09/69 >	12/74				S 8790 PO
power steering / servosterzo	OM355 V	176	240	09/69 >	12/74				S 3081 PO
22 t Serie									
2219	OM401	141	192	06/76 >	06/87	S 8260 PO	S 2161 N	S 6370 A	
power steering / servosterzo	OM401	141	192	06/76 >	06/87				S 8790 PO
2219 A	OM401	141	192	06/76 >	06/87	S 8260 PO	S 2161 N	S 6370 A	
power steering / servosterzo	OM401	141	192	06/76 >	06/87				S 8790 PO
2219 C	OM362LA	141	192	02/83 >	09/85	S 8260 PO	S 2161 N	S 6370 A	
power steering / servosterzo	OM362LA	141	192	02/83 >	09/85				S 3081 PO
2219 K	OM401	141	192	06/76 >	06/87	S 8260 PO	S 2161 N	S 6370 A	
power steering / servosterzo	OM401	141	192	06/76 >	06/87				S 8790 PO
2219 L	OM401	141	192	06/76 >	06/87	S 8260 PO	S 2161 N	S 6370 A	
power steering / servosterzo	OM401	141	192	06/76 >	06/87				S 8790 PO
2220									

**KW HP****...MERCEDES BENZ - trucks/autocarri**

to engine No. 923826 / a motore N. 923826	OM366LA	150	204	07/85 >	09/88	S 8260 PO	S 2161 N	S 2650 A	
some / alcuni	OM366LA	150	204	07/85 >	03/91		S 2161 N	S 6370 A	
from engine No. 923827 / da motore N. 923827	OM366LA	150	204	10/88 >	03/91	S 5124 PE	S 2161 N	S 2650 A	
power steering / servosterzo	OM366LA	150	204	07/85 >	03/91				S 3081 PO
2220 L									
to engine No. 923826 / a motore N. 923826	OM366LA	150	204	07/85 >	09/88	S 8260 PO	S 2161 N	S 2650 A	
some / alcuni	OM366LA	150	204	07/85 >	03/91		S 2161 N	S 6370 A	
from engine No. 923827 / da motore N. 923827	OM366LA	150	204	10/88 >	03/91	S 5124 PE	S 2161 N	S 2650 A	
power steering / servosterzo	OM366LA	150	204	07/85 >	03/91				S 3081 PO
2222	OM421	159	216	05/82 >	03/91	S 7261 PO	S 2162 N	S 6370 A	
dryer filter / filtro essiccatore	OM421	159	216	05/82 >	03/91				S 7259 A
2222	OM441	159	216	03/87 >	03/91	S 8260 PO	S 2162 N	S 7185 A	
dryer filter / filtro essiccatore	OM441	159	216	03/87 >	03/91				S 7259 A
power steering / servosterzo	OM441	159	216	03/87 >	03/91				S 3081 PO
2222 B	OM421	159	216	05/82 >	03/91	S 7261 PO	S 2162 N	S 6370 A	
dryer filter / filtro essiccatore	OM421	159	216	05/82 >	03/91				S 7259 A
2222 B	OM441	159	216	03/87 >	03/91	S 8260 PO	S 2162 N	S 7185 A	
dryer filter / filtro essiccatore	OM441	159	216	03/87 >	03/91				S 7259 A
power steering / servosterzo	OM441	159	216	03/87 >	03/91				S 3081 PO
2222 L	OM421	159	216	05/82 >	03/91	S 7261 PO	S 2162 N	S 6370 A	
dryer filter / filtro essiccatore	OM421	159	216	05/82 >	03/91				S 7259 A
2223	OM355	168	230	09/67 >	09/69	S 0300 O	S 2162 N	S 5270 A	
some / alcuni	OM355	168	230	09/67 >	09/69	S 0300 O	S 2162 N	S 5270 A	
power steering / servosterzo	OM355	168	230	09/67 >	09/69				S 3081 PO
power steering / servosterzo	OM355	168	230	09/67 >	09/69				S 8790 PO
2224	OM355 V	176	240	09/69 >	12/74	S 0300 O	S 2162 N		
some / alcuni	OM355 V	176	240	09/69 >	12/74	S 0300 O	S 2162 N	S 5270 A	
power steering / servosterzo	OM355 V	176	240	09/69 >	12/74				S 3081 PO
power steering / servosterzo	OM355 V	176	240	09/69 >	12/74				S 8790 PO
2224	OM402	176	240	04/76 >	03/82	S 8260 PO	S 2161 N	S 6370 A	
	OM402	176	240	04/82 >	12/82	S 8260 PO	S 2162 N	S 6370 A	
some / alcuni	OM402	176	240	04/76 >	03/82	S 7261 PO	S 2161 N	S 6370 A	
some / alcuni	OM402	176	240	04/82 >	12/82	S 7261 PO	S 2162 N	S 6370 A	
power steering / servosterzo	OM402	176	240	04/76 >	12/82				S 8790 PO
2225	OM422	184	250	08/83 >	03/91	S 7261 PO	S 2162 N	S 6370 A	
some / alcuni	OM422	184	250	08/83 >	03/19	S 7261 PO	S 2162 N	S 7998 A	
dryer filter / filtro essiccatore	OM422	184	250	01/85 >	03/91				S 7259 A
power steering / servosterzo	OM422	184	250	08/83 >	03/91				S 3081 PO
2225									
with R.H.D. / con guida a destra	OM442.905	184	250	03/87 >	03/91	S 8260 PO	S 2162 N	S 6370 A	
with L.H.D. / con guida a sinistra	OM442.905	184	250	03/87 >	03/91	S 8260 PO	S 2162 N	S 3570 A	
dryer filter / filtro essiccatore	OM442.905	184	250	03/87 >	03/91				S 7259 A
power steering / servosterzo	OM442.905	184	250	03/87 >	03/91				S 3081 PO
2225 B	OM422	184	250	08/83 >	03/91	S 7261 PO	S 2162 N	S 6370 A	
some / alcuni	OM422	184	250	08/83 >	03/19	S 7261 PO	S 2162 N	S 7998 A	
dryer filter / filtro essiccatore	OM422	184	250	01/85 >	03/91				S 7259 A
power steering / servosterzo	OM422	184	250	08/83 >	03/91				S 3081 PO
2225 B									
with R.H.D. / con guida a destra	OM442.905	184	250	03/87 >	03/91	S 8260 PO	S 2162 N	S 6370 A	
with L.H.D. / con guida a sinistra	OM442.905	184	250	03/87 >	03/91	S 8260 PO	S 2162 N	S 3570 A	
dryer filter / filtro essiccatore	OM442.905	184	250	03/87 >	03/91				S 7259 A
power steering / servosterzo	OM442.905	184	250	03/87 >	03/91				S 3081 PO
2226	OM402	188	256	09/75 >	12/80	S 8260 PO	S 2161 N	S 6370 A	
some / alcuni	OM402	188	256	09/75 >	12/80	S 7261 PO	S 2162 N	S 6370 A	
power steering / servosterzo	OM402	188	256	09/75 >	12/80				S 8790 PO
2228	OM422	206	280	12/79 >	06/82	S 7261 PO	S 2161 N	S 6370 A	
	OM422	206	280	07/82 >	03/91	S 7261 PO	S 2162 N	S 6370 A	
some / alcuni	OM422	206	280	12/79 >	06/82	S 7261 PO	S 2161 N	S 3570 A	
some / alcuni	OM422	206	280	07/82 >	03/91	S 7261 PO	S 2162 N	S 3570 A	
dryer filter / filtro essiccatore	OM422	206	280	01/85 >	03/91				S 7259 A
power steering / servosterzo	OM422	206	280	12/79 >	03/91				S 3081 PO
2228 L	OM422	206	280	12/79 >	06/82	S 7261 PO	S 2161 N	S 6370 A	
	OM422	206	280	07/82 >	03/91	S 7261 PO	S 2162 N	S 6370 A	
some / alcuni	OM422	206	280	12/79 >	06/82	S 7261 PO	S 2161 N	S 3570 A	
some / alcuni	OM422	206	280	07/82 >	03/91	S 7261 PO	S 2162 N	S 3570 A	
dryer filter / filtro essiccatore	OM422	206	280	01/85 >	03/91				S 7259 A
power steering / servosterzo	OM422	206	280	12/79 >	03/91				S 3081 PO

M

**KW HP****...MERCEDES BENZ - trucks/autocarri****M**

2232	OM403	235	320	05/74 >	03/82	S 7261 PO	S 2161 N	S 3570 A	
	OM403	235	320	04/82 >	09/83	S 7261 PO	S 2162 N	S 3570 A	
power steering / servosterzo	OM403	235	320	05/74 >	09/83				S 8790 PO
2232	OM403.905	235	320	09/70 >	12/75		S 2161 N	S 3570 A	
power steering / servosterzo	OM403.905	235	320	09/70 >	12/75				S 8790 PO
2232 L	OM403	235	320	05/74 >	03/82	S 7261 PO	S 2161 N	S 3570 A	
	OM403	235	320	04/82 >	09/83	S 7261 PO	S 2162 N	S 3570 A	
power steering / servosterzo	OM403	235	320	05/74 >	09/83				S 8790 PO
2232 S	OM403	235	320	05/74 >	03/82	S 7261 PO	S 2161 N	S 3570 A	
	OM403	235	320	04/82 >	09/83	S 7261 PO	S 2162 N	S 3570 A	
power steering / servosterzo	OM403	235	320	05/74 >	09/83				S 8790 PO
2233	OM422A	243	330	11/80 >	05/87	S 7261 PO	S 2162 N	S 9570 A	
power steering / servosterzo	OM422A	243	330	11/80 >	05/87				S 3081 PO
2233 L	OM422A	243	330	11/80 >	05/87	S 7261 PO	S 2162 N	S 9570 A	
power steering / servosterzo	OM422A	243	330	11/80 >	05/87				S 3081 PO
2235									
to frame No. 5343252 / a telaio N. 5343252	OM442A	260	354	03/86 >	04/88	S 7261 PO	S 2162 N	S 9570 A	
some / alcuni	OM442A	260	354	09/88 >	07/89	S 7261 PO	S 2162 N	S 2450 A	
from frame No. 5343253 / da telaio N. 5343253	OM442A	260	354	05/88 >	07/89	S 7261 PO	S 2162 N	S 1670 A	
dryer filter / filtro essiccatore	OM442A	260	354	03/86 >	07/89				S 7259 A
series L (Silent) / Serie L (Silent)	OM442A	260	354	03/86 >	07/89	S 7261 PO	S 2162 N	S 7185 A	
power steering / servosterzo	OM442A	260	354	03/86 >	07/89				S 3081 PO
2235 L									
to frame No. 5343252 / a telaio N. 5343252	OM442A	260	354	03/86 >	04/88	S 7261 PO	S 2162 N	S 9570 A	
to frame No. 5343253 / a telaio N. 5343253	OM442A	260	354	05/88 >	07/89	S 7261 PO	S 2162 N	S 1670 A	
some / alcuni	OM442A	260	354	09/88 >	07/89	S 7261 PO	S 2162 N	S 2450 A	
dryer filter / filtro essiccatore	OM442A	260	354	03/86 >	07/89				S 7259 A
series L (Silent) / Serie L (Silent)	OM442A	260	354	03/86 >	07/89	S 7261 PO	S 2162 N	S 7185 A	
power steering / servosterzo	OM442A	260	354	03/86 >	07/89				S 3081 PO
2236	OM423	261	355	09/82 >	03/91	S 7261 PO	S 2162 N	S 3570 A	
power steering / servosterzo	OM423	261	355	09/82 >	03/91				S 3081 PO
2238	OM422LA	203	276	01/81 >	12/86	S 7261 PO	S 2162 N	S 9570 A	
power steering / servosterzo	OM422LA	203	276	01/81 >	12/86				S 3081 PO
2244									
to frame No. 5343252 / a telaio N. 5343252	OM442LA	320	435			S 7261 PO	S 2162 N	S 9570 A	
from frame No. 5343253 / da telaio N. 5343253	OM442LA	320	435			S 7261 PO	S 2162 N	S 1670 A	
dryer filter / filtro essiccatore	OM442LA	320	435	10/85 >	07/89				S 7259 A
power steering / servosterzo	OM442LA	320	435	10/85 >	07/89				S 3081 PO
2244 L									
to frame No. 5343252 / a telaio N. 5343252	OM442LA	320	435			S 7261 PO	S 2162 N	S 9570 A	
from frame No. 5343253 / da telaio N. 5343253	OM442LA	320	435			S 7261 PO	S 2162 N	S 1670 A	
dryer filter / filtro essiccatore	OM442LA	320	435	10/85 >	07/89				S 7259 A
power steering / servosterzo	OM442LA	320	435	10/85 >	07/89				S 3081 PO
L 2223	OM355	168	230	09/67 >	09/69	S 0300 O	S 2162 N	S 5270 A	
some / alcuni	OM355	168	230	09/67 >	09/69	S 0300 O	S 2162 N	S 5270 A	
power steering / servosterzo	OM355	168	230	09/67 >	09/69				S 8790 PO
power steering / servosterzo	OM355	168	230	09/67 >	09/69				S 3081 PO
LP 2224	OM355 V	176	240	09/69 >	12/74	S 0300 O	S 2162 N	S 5270 A	
some / alcuni	OM355 V	176	240			S 0300 O	S 2162 N	S 5270 A	
power steering / servosterzo	OM355 V	176	240	09/69 >	12/74				S 8790 PO
power steering / servosterzo	OM355 V	176	240	09/69 >	12/74				S 3081 PO
24 t Serie									
2418	OM366A	135	184	03/91 >			S 2161 N	S 2650 A	
to engine No. 286114 / a motore N. 286114	OM366A	135	184			S 5124 PE	S 2161 N		
to engine No. 286114 / a motore N. 286114	OM366A	135	184			S 5099 PE	S 2161 N		
some / alcuni	OM366A	135	184	03/91 >			S 2161 N	S 9570 A	
some / alcuni	OM366A	135	184	03/91 >			S 2161 N	S 6370 A	
from engine No. 286115 / da motore N. 286115	OM366A	135	184				S 2161 N		
from engine No. 286115 / da motore N. 286115	OM366A	135	184				S 2161 N		
dryer filter / filtro essiccatore	OM366A	135	184	03/91 >					S 7259 A
power steering / servosterzo	OM366A	135	184	03/91 >					S 3081 PO
2419	OM401	141	192	01/80 >	03/82	S 8260 PO	S 2161 N	S 6370 A	
	OM401	141	192	04/82 >	10/82	S 8260 PO	S 2162 N	S 6370 A	
power steering / servosterzo	OM401	141	192	01/80 >	10/82				S 8790 PO
2419	OM421	141	192	05/82 >		S 7261 PO	S 2162 N	S 6370 A	
2420									
to engine No. 286114 / a motore N. 286114	OM356LA (366)	155	211			S 5124 PE	S 2161 N	S 2650 A	

**KW HP****...MERCEDES BENZ - trucks/autocarri**

some / alcuni	OM356LA (366)	155	211	02/90 >	08/94		S 2161 N	S 6370 A	
from engine No. 286115 / da motore N. 286115	OM356LA (366)	155	211				S 2161 N	S 2650 A	
dryer filter / filtro essiccatore	OM356LA (366)	155	211	02/90 >	08/94				S 7259 A
power steering / servosterzo	OM356LA (366)	155	211	02/90 >	08/94				S 3081 PO
2420 L									
to engine No. 286114 / a motore N. 286114	OM356LA (366)	155	211			S 5124 PE	S 2161 N	S 2650 A	
some / alcuni	OM356LA (366)	155	211	02/90 >	08/94		S 2161 N	S 6370 A	
from engine No. 286115 / da motore N. 286115	OM356LA (366)	155	211				S 2161 N	S 2650 A	
dryer filter / filtro essiccatore	OM356LA (366)	155	211	02/90 >	08/94				S 7259 A
power steering / servosterzo	OM356LA (366)	155	211	02/90 >	08/94				S 3081 PO
2421	OM421.11	148	201	02/83 >	09/89	S 7261 PO	S 2162 N	S 6370 A	
2422	OM421.905	160	218	05/86 >	06/89	S 7261 PO	S 2162 N	S 6370 A	
dryer filter / filtro essiccatore	OM421.905	160	218	05/86 >	06/89				S 7259 A
power steering / servosterzo	OM421.905	160	218	05/86 >	06/89				S 3081 PO
2422	OM441	160	218	09/89 >	09/93	S 8260 PO	S 2162 N	S 7185 A	
dryer filter / filtro essiccatore	OM441	160	218	09/89 >	09/93				S 7259 A
power steering / servosterzo	OM441	160	218	09/89 >	09/93				S 3081 PO
2422 L	OM441	160	218	09/89 >	09/93	S 8260 PO	S 2162 N	S 7185 A	
dryer filter / filtro essiccatore	OM441	160	218	09/89 >	09/93				S 7259 A
power steering / servosterzo	OM441	160	218	09/89 >	09/93				S 3081 PO
2425	OM422.909	184	250	09/85 >	06/89	S 7261 PO	S 2162 N	S 6370 A	
dryer filter / filtro essiccatore	OM422.909	184	250	09/85 >	06/89				S 7259 A
power steering / servosterzo	OM422.909	184	250	09/85 >	06/89				S 3081 PO
2426	OM442	195	265	01/90 >	09/93	S 5133 PE		S 7185 A	✗
some / alcuni	OM442	195	265	01/90 >	07/90	S 7261 PO			
some power steering / alcuni servosterzo	OM442	195	265	01/90 >	09/93				S 8790 PO
dryer filter / filtro essiccatore	OM442	195	265	01/90 >	09/93				S 7259 A
2 filters / N.2 filtri	OM442	195	265	01/90 >	09/93		S 2162 N		
power steering / servosterzo	OM442	195	265	01/90 >	09/93				S 3081 PO
2426 L	OM442	195	265	01/90 >	09/93	S 5133 PE		S 7185 A	✗
some / alcuni	OM442	195	265	01/90 >	07/90	S 7261 PO			
some power steering / alcuni servosterzo	OM442	195	265	01/90 >	09/93				S 8790 PO
dryer filter / filtro essiccatore	OM442	195	265	01/90 >	09/93				S 7259 A
2 filters / N.2 filtri	OM442	195	265	01/90 >	09/93		S 2162 N		
power steering / servosterzo	OM442	195	265	01/90 >	09/93				S 3081 PO
2427	OM401.973LA (OM401LA)	200	272	07/92 >	05/94	S 5133 PE		S 7185 A	∞
dryer filter / filtro essiccatore	OM401.973LA (OM401LA)	200	272	06/94 >	09/96	S 5133 PE		S 7185 A	S 3056 C
2 filters / N.2 filtri	OM401.973LA (OM401LA)	200	272	07/92 >	09/96		S 2162 N		S 7259 A
power steering / servosterzo	OM401.973LA (OM401LA)	200	272	07/92 >	09/96				S 3081 PO
2427 L (MK)	OM401.973LA (OM401LA)	200	272	07/92 >	05/94	S 5133 PE		S 7185 A	✗
dryer filter / filtro essiccatore	OM401.973LA (OM401LA)	200	272	06/94 >	09/96	S 5133 PE		S 7185 A	S 3056 C
2 filters / N.2 filtri	OM401.973LA (OM401LA)	200	272	07/92 >	09/96		S 2162 N		S 7259 A
power steering / servosterzo	OM401.973LA (OM401LA)	200	272	07/92 >	09/96				S 3081 PO
2428	OM422	206	280	01/80 >	06/82	S 7261 PO	S 2161 N	S 6370 A	
	OM422	206	280	07/82 >	03/91	S 7261 PO	S 2162 N	S 6370 A	
some / alcuni	OM422	206	280	01/80 >	06/82	S 7261 PO	S 2161 N	S 3570 A	
some / alcuni	OM422	206	280	07/82 >	03/91	S 7261 PO	S 2162 N	S 3570 A	
power steering / servosterzo	OM422	206	280	01/80 >	03/91				S 3081 PO
2429	OM442.906/923/925	213	290	07/88 >	12/89	S 7261 PO		S 7185 A	✗
	OM442.906/923/925	213	290	08/90 >	09/93	S 5133 PE		S 7185 A	✗
some / alcuni	OM442.906/923/925	213	290	01/90 >	07/90	S 7261 PO		S 7185 A	✗
some / alcuni	OM442.906/923/925	213	290	01/90 >	07/90	S 5133 PE		S 7185 A	✗
dryer filter / filtro essiccatore	OM442.906/923/925	213	290	07/88 >	09/93				S 7259 A
2 filters / N.2 filtri	OM442.906/923/925	213	290	07/88 >	09/93		S 2162 N		
power steering / servosterzo	OM442.906/923/925	213	290	07/88 >	09/93				S 3081 PO
2429 L	OM442.906/923/925	213	290	07/88 >	08/94	S 7261 PO	S 2162 N	S 7185 A	
dryer filter / filtro essiccatore	OM442.906/923/925	213	290	07/88 >	08/94				S 7259 A
series OM422.906/923 / Serie OM422.906/923	OM442.906/923/925	213	290	07/88 >	08/94	S 8260 PO	S 2162 N	S 7185 A	
power steering / servosterzo	OM442.906/923/925	213	290	07/88 >	08/94				S 3081 PO
2433	OM441LA (V6)	243	330	05/89 >	07/92		S 2162 N	S 7185 A	
some / alcuni	OM441LA (V6)	243	330	05/89 >	07/92		S 2162 N	S 1670 A	
dryer filter / filtro essiccatore	OM441LA (V6)	243	330	05/89 >	07/92				S 7259 A
power steering / servosterzo	OM441LA (V6)	243	330	05/89 >	07/92				S 3081 PO
2433 L	OM441LA (V6)	243	330	05/89 >	07/92		S 2162 N	S 7185 A	
some / alcuni	OM441LA (V6)	243	330	05/89 >	07/92		S 2162 N	S 1670 A	

M

**KW HP****...MERCEDES BENZ - trucks/autocarri****M**

dryer filter / filtro essiccatore	OM441LA (V6)	243	330	05/89 >	07/92				S 7259 A
power steering / servosterzo	OM441LA (V6)	243	330	05/89 >	07/92				S 3081 PO
2435	OM442A	260	354	07/88 >	12/89	S 7261 PO		S 1670 A	✗
	OM442A	260	354	07/88 >	09/93			S 7474 A	
	OM442A	260	354	08/90 >	09/93	S 5133 PE		S 1670 A	✗
some / alcuni	OM442A	260	354	01/90 >	07/90	S 7261 PO			✗
some / alcuni	OM442A	260	354	01/90 >	07/90	S 5133 PE			
some 2 filters / alcuni N.2 filtri	OM442A	260	354	07/88 >	09/93			S 2450 A	
dryer filter / filtro essiccatore	OM442A	260	354	07/88 >	09/93				S 7259 A
2 filters / N.2 filtri	OM442A	260	354	07/88 >	09/93		S 2162 N		
series L (Silent) / Serie L (Silent)	OM442A	260	354	07/88 >	09/93			S 7185 A	✗
power steering / servosterzo	OM442A	260	354	07/88 >	09/93				S 3081 PO
2435 K (SK)	OM440A (442)	250	340	07/91 >	05/94	S 5133 PE		S 1670 A	✗
	OM440A (442)	250	340	07/91 >	09/96			S 7474 A	
	OM440A (442)	250	340	06/94 >	09/96	S 5133 PE		S 1670 A	
some 2 filters / alcuni N.2 filtri	OM440A (442)	250	340	07/91 >	09/96			S 2450 A	
dryer filter / filtro essiccatore	OM440A (442)	250	340	07/91 >	09/96				S 7259 A
2 filters / N.2 filtri	OM440A (442)	250	340	07/91 >	09/96		S 2162 N		
series L (Silent) / Serie L (Silent)	OM440A (442)	250	340	07/91 >	09/96	S 5133 PE		S 7185 A	
power steering / servosterzo	OM440A (442)	250	340	07/91 >	09/96				S 3081 PO
2435 L	OM442A	260	354	07/88 >	12/89	S 7261 PO		S 1670 A	✗
	OM442A	260	354	08/90 >	09/93	S 5133 PE		S 1670 A	✗
some / alcuni	OM442A	260	354	01/90 >	07/90	S 7261 PO			✗
some / alcuni	OM442A	260	354	01/90 >	07/90	S 5133 PE			
some 2 filters / alcuni N.2 filtri	OM442A	260	354	07/88 >	09/93			S 2450 A	
dryer filter / filtro essiccatore	OM442A	260	354	07/88 >	09/93				S 7259 A
2 filters / N.2 filtri	OM442A	260	354	07/88 >	09/93		S 2162 N		
series L (Silent) / Serie L (Silent)	OM442A	260	354	07/88 >	09/93			S 7185 A	✗
power steering / servosterzo	OM442A	260	354	07/88 >	09/93				S 3081 PO
2448	OM442LA	353	480	07/88 >	12/89	S 7261 PO		S 9570 A	✗
	OM442LA	353	480	08/90 >	07/92	S 5133 PE		S 9570 A	✗
some / alcuni	OM442LA	353	480	07/88 >	07/92			S 1670 A	✗
dryer filter / filtro essiccatore	OM442LA	353	480	07/88 >	07/92				S 7259 A
power steering / servosterzo	OM442LA	353	480	07/88 >	07/92				S 3081 PO
2448 L	OM442LA	353	480	07/88 >	07/92	S 7261 PO		S 9570 A	✗
	OM442LA	353	480	08/90 >	07/92	S 5133 PE		S 9570 A	✗
some / alcuni	OM442LA	353	480	07/88 >	07/92			S 1670 A	✗
some / alcuni	OM442LA	353	480	01/90 >	07/90	S 7261 PO			
some / alcuni	OM442LA	353	480	01/90 >	07/90	S 5133 PE			
dryer filter / filtro essiccatore	OM442LA	353	480	07/88 >	07/92				S 7259 A
2 filters / N.2 filtri	OM442LA	353	480	07/88 >	07/92		S 2162 N		
power steering / servosterzo	OM442LA	353	480	07/88 >	07/92				S 3081 PO
LP 2419	OM421	141	192	05/82 >		S 7261 PO	S 2162 N	S 6370 A	
LPK 2419	OM421	141	192	05/82 >		S 7261 PO	S 2162 N	S 6370 A	
25 t Serie									
2524	OM401LA	180	245	06/92 >			S 2162 N	S 7185 A	S 3056 C
dryer filter / filtro essiccatore	OM401LA	180	245	06/92 >					S 7259 A
power steering / servosterzo	OM401LA	180	245	06/92 >					S 3081 PO
2524 L (MK)	OM401LA	180	245	06/92 >			S 2162 N	S 7185 A	S 3056 C
dryer filter / filtro essiccatore	OM401LA	180	245	06/92 >					S 7259 A
power steering / servosterzo	OM401LA	180	245	06/92 >					S 3081 PO
2527	OM401LA	200	272	03/91 >			S 2162 N	S 7185 A	S 3056 C
dryer filter / filtro essiccatore	OM401LA	200	272	03/91 >					S 7259 A
power steering / servosterzo	OM401LA	200	272	03/91 >					S 3081 PO
2527 B	OM401LA	200	272	03/91 >			S 2162 N	S 7185 A	S 3056 C
dryer filter / filtro essiccatore	OM401LA	200	272	03/91 >					S 7259 A
power steering / servosterzo	OM401LA	200	272	03/91 >					S 3081 PO
2527 L (MK)	OM401LA	200	272	03/91 >			S 2162 N	S 7185 A	S 3056 C
dryer filter / filtro essiccatore	OM401LA	200	272	03/91 >					S 7259 A
power steering / servosterzo	OM401LA	200	272	03/91 >					S 3081 PO
2528 A	OM422	206	280	01/86 >	12/92	S 7261 PO	S 2162 N	S 6370 A	
some / alcuni	OM422	206	280	01/86 >	12/92	S 8260 PO	S 2162 N	S 3570 A	
dryer filter / filtro essiccatore	OM422	206	280	01/86 >	12/92				S 7259 A
power steering / servosterzo	OM422	206	280	01/86 >	12/92				S 3081 PO
2531 (MK)	OM401LA	230	313	12/90 >			S 2162 N	S 7185 A	S 3056 C
dryer filter / filtro essiccatore	OM401LA	230	313	12/90 >					S 7259 A
2533	OM422A	243	330			S 7261 PO	S 2162 N	S 9570 A	

**KW HP****...MERCEDES BENZ - trucks/autocarri**

power steering / servosterzo	OM422A	243	330					S 3081 PO
2534 (MK)	OM441LA	250	340	01/91	>		S 2162 N	S 7185 A
dryer filter / filtro essiccatore	OM441LA	250	340	01/91	>			S 3056 C
power steering / servosterzo	OM441LA	250	340	01/91	>			S 7259 A
								S 3081 PO
2536 A	OM423.907	261	355	01/86	>	12/92	S 7261 PO	S 2162 N
dryer filter / filtro essiccatore	OM423.907	261	355	01/86	>	12/92		S 3570 A
power steering / servosterzo	OM423.907	261	355	01/86	>	12/92		S 7259 A
								S 3081 PO
2538 (SK)	OM402LA	280	381	03/91	>		S 2162 N	S 7185 A
some / alcuni	OM402LA	280	381	03/91	>		S 2162 N	S 1670 A
dryer filter / filtro essiccatore	OM402LA	280	381	03/91	>			S 3056 C
power steering / servosterzo	OM402LA	280	381	03/91	>			S 7259 A
								S 3081 PO
2538 (SK)	OM446LA (442)	280	381	03/91	>		S 2162 N	S 7185 A
some / alcuni	OM446LA (442)	280	381	03/91	>		S 2162 N	S 1670 A
dryer filter / filtro essiccatore	OM446LA (442)	280	381	03/91	>			S 3056 C
power steering / servosterzo	OM446LA (442)	280	381	03/91	>			S 7259 A
								S 3081 PO
2540								
some / alcuni	OM402/OM442LA	320	435	07/91	>		S 2162 N	S 7185 A
some / alcuni	OM402/OM442LA	320	435	07/91	>		S 2162 N	S 1670 A
some / alcuni	OM402/OM442LA	320	435	07/91	>		S 2162 N	S 7213 A
power steering / servosterzo	OM402/OM442LA	320	435	07/91	>			S 3081 PO
2544 (SK)								
to frame No. 5343252 / a telaio N. 5343252	OM440LA (442)	320	435				S 2162 N	S 9570 A
some / alcuni	OM440LA (442)	320	435	06/93	>		S 2162 N	S 7213 A
from frame No. 5343253 / da telaio N. 5343253	OM440LA (442)	320	435				S 2162 N	S 1670 A
dryer filter / filtro essiccatore	OM440LA (442)	320	435	01/92	>			S 3056 C
power steering / servosterzo	OM440LA (442)	320	435	01/92	>			S 7259 A
								S 3081 PO
2544 (SK)								
to frame No. 5343252 / a telaio N. 5343252	OM446LA (442)	320	435				S 2162 N	S 9570 A
some / alcuni	OM446LA (442)	320	435	01/94	>		S 2162 N	S 7213 A
from frame No. 5343253 / da telaio N. 5343253	OM446LA (442)	320	435				S 2162 N	S 1670 A
dryer filter / filtro essiccatore	OM446LA (442)	320	435	01/94	>			S 3056 C
power steering / servosterzo	OM446LA (442)	320	435	01/94	>			S 7259 A
								S 3081 PO
2550	OM442LA (446)	370	503	01/91	>		S 2162 N	S 7185 A
some / alcuni	OM442LA (446)	370	503	01/91	>		S 2162 N	S 1670 A
some / alcuni	OM442LA (446)	370	503	01/91	>		S 2162 N	S 7213 A
dryer filter / filtro essiccatore	OM442LA (446)	370	503	01/91	>			S 3056 C
power steering / servosterzo	OM442LA (446)	370	503	01/91	>			S 7259 A
								S 3081 PO
2550 L (SK)	OM442LA (446)	370	503	01/91	>		S 2162 N	S 7185 A
some / alcuni	OM442LA (446)	370	503	01/91	>		S 2162 N	S 1670 A
some / alcuni	OM442LA (446)	370	503	01/91	>		S 2162 N	S 7213 A
dryer filter / filtro essiccatore	OM442LA (446)	370	503	01/91	>			S 3056 C
power steering / servosterzo	OM442LA (446)	370	503	01/91	>			S 7259 A
								S 3081 PO
2553	OM442LA (446)	390	530	08/94	>		S 2162 N	S 7213 A
dryer filter / filtro essiccatore	OM442LA (446)	390	530	08/94	>			S 3056 C
power steering / servosterzo	OM442LA (446)	390	530	08/94	>			S 7259 A
								S 3081 PO
2553 L (SK)	OM442LA (446)	390	530	08/94	>		S 2162 N	S 7213 A
dryer filter / filtro essiccatore	OM442LA (446)	390	530	08/94	>			S 3056 C
power steering / servosterzo	OM442LA (446)	390	530	08/94	>			S 7259 A
								S 3081 PO

26 t Serie

2623	OM355	168	230	09/67	>	09/69	S 0300 O	S 2162 N	S 5270 A
some / alcuni	OM355	168	230	09/67	>	09/69	S 0300 O	S 2162 N	S 2450 A
power steering / servosterzo	OM355	168	230	09/67	>	09/69			S 3081 PO
power steering / servosterzo	OM355	168	230	09/67	>	09/69			S 8790 PO
2626 AB	OM402	188	256	05/74	>	12/80	S 8260 PO	S 2161 N	S 6370 A
some / alcuni	OM402	188	256	05/74	>	12/80	S 7261 PO	S 2162 N	S 6370 A
power steering / servosterzo	OM402	188	256	05/74	>	12/80			S 8790 PO
2626 AK	OM402.906/912	188	256	08/73	>	12/81	S 8260 PO	S 2161 N	S 6370 A
some / alcuni	OM402.906/912	188	256	08/73	>	12/81	S 7261 PO	S 2162 N	S 6370 A
power steering / servosterzo	OM402.906/912	188	256	08/73	>	12/81			S 8790 PO
2626 B	OM402	188	256	05/74	>	12/80	S 8260 PO	S 2161 N	S 6370 A
some / alcuni	OM402	188	256	05/74	>	12/80	S 7261 PO	S 2162 N	S 6370 A
power steering / servosterzo	OM402	188	256	05/74	>	12/80			S 8790 PO
2626 K	OM402.906/912	188	256	08/73	>	12/81	S 8260 PO	S 2161 N	S 6370 A
some / alcuni	OM402.906/912	188	256	08/73	>	12/81	S 7261 PO	S 2162 N	S 6370 A
power steering / servosterzo	OM402.906/912	188	256	08/73	>	12/81			S 8790 PO
2628	OM355A	206	280	11/78	>	02/01	S 9490 PO	S 2162 N	S 0450 A
power steering / servosterzo	OM355A	206	280	11/78	>	02/01			S 3081 PO

M

**KW HP****...MERCEDES BENZ - trucks/autocarri****M**

2628	OM422	206 280	02/80 > 06/82	S 7261 PO	S 2161 N	S 6370 A	
	OM422	206 280	07/82 > 03/91	S 7261 PO	S 2162 N	S 6370 A	
some / alcuni	OM422	206 280	02/80 > 06/82	S 7261 PO	S 2161 N	S 3570 A	
some / alcuni	OM422	206 280	07/82 > 03/91	S 7261 PO	S 2162 N	S 3570 A	
dryer filter / filtro essiccatore	OM422	206 280	01/85 > 03/91				S 7259 A
power steering / servosterzo	OM422	206 280	02/80 > 03/91				S 3081 PO
2628	OM443A	206 280	01/90 > 03/91	S 7261 PO	S 2162 N	S 3570 A	
2628 A	OM422	206 280	02/80 > 06/82	S 7261 PO	S 2161 N	S 6370 A	
	OM422	206 280	07/82 > 03/91	S 7261 PO	S 2162 N	S 6370 A	
some / alcuni	OM422	206 280	02/80 > 06/82	S 7261 PO	S 2161 N	S 3570 A	
some / alcuni	OM422	206 280	07/82 > 03/91	S 7261 PO	S 2162 N	S 3570 A	
dryer filter / filtro essiccatore	OM422	206 280	01/85 > 03/91				S 7259 A
power steering / servosterzo	OM422	206 280	02/80 > 03/91				S 3081 PO
2628 B	OM422	206 280	02/80 > 06/82	S 7261 PO	S 2161 N	S 6370 A	
	OM422	206 280	07/82 > 03/91	S 7261 PO	S 2162 N	S 6370 A	
some / alcuni	OM422	206 280	02/80 > 06/82	S 7261 PO	S 2161 N	S 3570 A	
some / alcuni	OM422	206 280	07/82 > 03/91	S 7261 PO	S 2162 N	S 3570 A	
dryer filter / filtro essiccatore	OM422	206 280	01/85 > 03/91				S 7259 A
power steering / servosterzo	OM422	206 280	02/80 > 03/91				S 3081 PO
2629	OM442	213 290	07/88 > 07/90	S 7261 PO	S 2162 N	S 7185 A	
power steering / servosterzo	OM442	213 290	07/88 > 08/94				S 3081 PO
2629 4WD	OM442	213 290	07/88 > 07/90	S 7261 PO	S 2162 N	S 6370 A	
power steering / servosterzo	OM442	213 290	07/88 > 08/94				S 3081 PO
2629 A	OM442	213 290	07/88 > 07/90	S 7261 PO	S 2162 N	S 7185 A	
power steering / servosterzo	OM442	213 290	07/88 > 08/94				S 3081 PO
2629 A 4WD	OM442	213 290	07/88 > 07/90	S 7261 PO	S 2162 N	S 6370 A	
power steering / servosterzo	OM442	213 290	07/88 > 08/94				S 3081 PO
2631 SK	OM401LA	230 313	04/91 > 05/94		S 2162 N	S 7185 A	
	OM401LA	230 313	06/94 >		S 2162 N	S 7185 A	S 3056 C
dryer filter / filtro essiccatore	OM401LA	230 313	04/91 >				S 7259 A
power steering / servosterzo	OM401LA	230 313	04/91 >				S 3081 PO
2632	OM403	236 320	08/73 > 03/82	S 7261 PO	S 2161 N	S 3570 A	
	OM403	236 320	04/82 > 09/83	S 7261 PO	S 2162 N	S 3570 A	
power steering / servosterzo	OM403	236 320	08/73 > 09/83				S 8790 PO
2632	OM403.905	236 320	08/73 > 03/82		S 2161 N	S 3570 A	
	OM403.905	236 320	04/82 > 09/83		S 2162 N	S 3570 A	
power steering / servosterzo	OM403.905	236 320	08/73 > 09/83				S 8790 PO
2632 AK	OM403	236 320	08/73 > 03/82	S 7261 PO	S 2161 N	S 3570 A	
	OM403	236 320	04/82 > 09/83	S 7261 PO	S 2162 N	S 3570 A	
power steering / servosterzo	OM403	236 320	08/73 > 09/83				S 8790 PO
2632 AK	OM403.905	236 320	08/73 > 03/82		S 2161 N	S 3570 A	
	OM403.905	236 320	04/82 > 09/83		S 2162 N	S 3570 A	
power steering / servosterzo	OM403.905	236 320	08/73 > 09/83				S 8790 PO
2632 K	OM403	236 320	08/73 > 03/82	S 7261 PO	S 2161 N	S 3570 A	
	OM403	236 320	04/82 > 09/83	S 7261 PO	S 2162 N	S 3570 A	
power steering / servosterzo	OM403	236 320	08/73 > 09/83				S 8790 PO
2632 K	OM403.905	236 320	08/73 > 03/82		S 2161 N	S 3570 A	
	OM403.905	236 320	04/82 > 09/83		S 2162 N	S 3570 A	
power steering / servosterzo	OM403.905	236 320	08/73 > 09/83				S 8790 PO
2633	OM422A	243 330	05/82 > 05/87	S 7261 PO	S 2162 N	S 9570 A	
power steering / servosterzo	OM422A	243 330	05/82 > 05/87				S 3081 PO
2635	OM440A (442)	260 354	07/91 > 05/94		S 2162 N	S 1670 A	
	OM440A (442)	260 354	06/94 >		S 2162 N	S 1670 A	S 3056 C
some / alcuni	OM440A (442)	260 354	07/91 > 05/94		S 2162 N	S 2450 A	
some / alcuni	OM440A (442)	260 354	06/94 >		S 2162 N	S 2450 A	S 3056 C
dryer filter / filtro essiccatore	OM440A (442)	260 354	07/91 >				S 7259 A
series L (Silent) / Serie L (Silent)	OM440A (442)	260 354	07/91 > 05/94		S 2162 N	S 7185 A	
series L (Silent) / Serie L (Silent)	OM440A (442)	260 354	06/94 >		S 2162 N	S 7185 A	S 3056 C
power steering / servosterzo	OM440A (442)	260 354	07/91 >				S 3081 PO
2635	OM442A	260 354	04/86 > 04/88	S 7261 PO	S 2162 N	S 9570 A	
	OM442A	260 354	05/88 > 12/89	S 7261 PO	S 2162 N	S 1670 A	
	OM442A	260 354	07/88 > 09/93			S 7474 A	
	OM442A	260 354	08/90 > 08/94		S 2162 N	S 1670 A	
some / alcuni	OM442A	260 354	09/88 > 08/94		S 2162 N	S 2450 A	
some / alcuni	OM442A	260 354	01/90 > 07/90	S 7261 PO	S 2162 N	S 1670 A	
some / alcuni	OM442A	260 354	06/94 > 08/94				S 3056 C
some L (Silent) / alcuni L (Silent)	OM442A	260 354	04/86 > 08/94		S 2162 N	S 7185 A	

**KW HP****...MERCEDES BENZ - trucks/autocarri**

dryer filter / filtro essiccatore	OM442A	260	354	04/86 >	08/94				S 7259 A
power steering / servosterzo	OM442A	260	354	04/86 >	08/94				S 3081 PO
2635 A	OM442A	260	354	04/86 >	04/88	S 7261 PO	S 2162 N	S 9570 A	
	OM442A	260	354	05/88 >	12/89	S 7261 PO	S 2162 N	S 1670 A	
	OM442A	260	354	08/90 >	08/94		S 2162 N	S 1670 A	
some / alcuni	OM442A	260	354	04/86 >	08/94		S 2162 N	S 7185 A	
some / alcuni	OM442A	260	354	09/88 >	08/94		S 2162 N	S 2450 A	
some / alcuni	OM442A	260	354	01/90 >	07/90	S 7261 PO	S 2162 N	S 1670 A	
some / alcuni	OM442A	260	354	06/94 >	08/94				S 3056 C
dryer filter / filtro essiccatore	OM442A	260	354	04/86 >	08/94				S 7259 A
power steering / servosterzo	OM442A	260	354	04/86 >	08/94				S 3081 PO
2635 A (SK)	OM440A (442)	260	354	07/91 >	05/94		S 2162 N	S 1670 A	
	OM440A (442)	260	354	06/94 >			S 2162 N	S 1670 A	S 3056 C
some / alcuni	OM440A (442)	260	354	07/91 >	05/94		S 2162 N	S 2450 A	
some / alcuni	OM440A (442)	260	354	06/94 >			S 2162 N	S 2450 A	S 3056 C
dryer filter / filtro essiccatore	OM440A (442)	260	354	07/91 >					S 7259 A
series L (Silent) / Serie L (Silent)	OM440A (442)	260	354	07/91 >	05/94		S 2162 N	S 7185 A	
series L (Silent) / Serie L (Silent)	OM440A (442)	260	354	06/94 >			S 2162 N	S 7185 A	S 3056 C
power steering / servosterzo	OM440A (442)	260	354	07/91 >					S 3081 PO
2636	OM423	261	356	11/81 >	03/91	S 7261 PO	S 2162 N	S 3570 A	
dryer filter / filtro essiccatore	OM423	261	356	01/85 >	03/91				S 7259 A
power steering / servosterzo	OM423	261	356	11/81 >	03/91				S 3081 PO
2636	OM443A	261	356	01/90 >	03/91	S 7261 PO	S 2162 N	S 3570 A	
dryer filter / filtro essiccatore	OM443A	261	356	01/90 >	03/91				S 7259 A
power steering / servosterzo	OM443A	261	356	01/90 >	03/91				S 3081 PO
2638	OM422LA	280	381	01/81 >	12/86	S 7261 PO	S 2162 N	S 9570 A	
power steering / servosterzo	OM422LA	280	381	01/81 >	12/86				S 3081 PO
2638	OM446LA (422)	280	381	01/94 >			S 2162 N	S 7185 A	
some / alcuni	OM446LA (422)	280	381	01/94 >			S 2162 N	S 1670 A	
dryer filter / filtro essiccatore	OM446LA (422)	280	381	01/94 >					S 7259 A
power steering / servosterzo	OM446LA (422)	280	381	01/94 >					S 3081 PO
2638 (SK)	OM402LA (422)	280	381	04/91 >			S 2162 N	S 7185 A	
some / alcuni	OM402LA (422)	280	381	04/91 >	05/94		S 2162 N	S 1670 A	
some / alcuni	OM402LA (422)	280	381	06/94 >			S 2162 N	S 1670 A	S 3056 C
dryer filter / filtro essiccatore	OM402LA (422)	280	381	04/91 >					S 7259 A
power steering / servosterzo	OM402LA (422)	280	381	04/91 >					S 3081 PO
2638 A	OM446LA (422)	280	381	01/94 >			S 2162 N	S 7185 A	
some / alcuni	OM446LA (422)	280	381	01/94 >			S 2162 N	S 1670 A	
dryer filter / filtro essiccatore	OM446LA (422)	280	381	01/94 >					S 7259 A
power steering / servosterzo	OM446LA (422)	280	381	01/94 >					S 3081 PO
2638 S	OM422LA	280	381	01/81 >	12/86	S 7261 PO	S 2162 N	S 9570 A	
power steering / servosterzo	OM422LA	280	381	01/81 >	12/86				S 3081 PO
2644 (SK)									
to frame No. 5343252 / a telaio N. 5343252	OM440LA (442)	320	435				S 2162 N	S 9570 A	
some / alcuni	OM440LA (442)	320	435	06/93 >			S 2162 N	S 7213 A	S 3056 C
from frame No. 5343253 / da telaio N. 5343253	OM440LA (442)	320	435				S 2162 N	S 1670 A	
dryer filter / filtro essiccatore	OM440LA (442)	320	435	01/92 >					S 7259 A
power steering / servosterzo	OM440LA (442)	320	435	01/92 >					S 3081 PO
2648	OM442LA	357	486	12/88 >	07/90	S 7261 PO	S 2162 N	S 1670 A	
some / alcuni	OM442LA	357	486	12/88 >	07/92	S 7261 PO	S 2162 N	S 9570 A	
dryer filter / filtro essiccatore	OM442LA	357	486	12/88 >	07/92				S 7259 A
power steering / servosterzo	OM442LA	357	486	12/88 >	07/92				S 3081 PO
2648 S	OM442LA	357	486	12/88 >	07/90	S 7261 PO	S 2162 N	S 1670 A	
some / alcuni	OM442LA	357	486	12/88 >	07/92	S 7261 PO	S 2162 N	S 9570 A	
dryer filter / filtro essiccatore	OM442LA	357	486	12/88 >	07/92				S 7259 A
or / oppure	OM442LA	357	486	12/88 >	07/92			S 7474 A	
power steering / servosterzo	OM442LA	357	486	12/88 >	07/92				S 3081 PO
2650 (SK)									
some / alcuni	OM442LA	370	503	07/92 >			S 2162 N	S 7185 A	S 3056 C
some / alcuni	OM442LA	370	503	07/92 >			S 2162 N	S 1670 A	S 3056 C
some / alcuni	OM442LA	370	503	07/92 >			S 2162 N	S 7213 A	S 3056 C
dryer filter / filtro essiccatore	OM442LA	370	503	07/92 >					S 7259 A
power steering / servosterzo	OM442LA	370	503	07/92 >					S 3081 PO
2653	OM442LA	390	530	08/94 >			S 2162 N	S 7213 A	
dryer filter / filtro essiccatore	OM442LA	390	530	08/94 >					S 7259 A
power steering / servosterzo	OM442LA	390	530	08/94 >					S 3081 PO
2653	OM446LA (442)	390	530	01/96 >			S 2162 N	S 7213 A	

M

**KW HP****...MERCEDES BENZ - trucks/autocarri****M**

some / alcuni	OM446LA (442)	390	530	01/96 >		S 2162 N	S 7213 A	S 3056 C	
dryer filter / filtro essiccatore	OM446LA (442)	390	530	01/96 >				S 7259 A	
power steering / servosterzo	OM446LA (442)	390	530	01/96 >				S 3081 PO	
2653 A	OM446LA (442)	390	530	01/96 >		S 2162 N	S 7213 A		
some / alcuni	OM446LA (442)	390	530	01/96 >		S 2162 N	S 7213 A	S 3056 C	
dryer filter / filtro essiccatore	OM446LA (442)	390	530	01/96 >				S 7259 A	
power steering / servosterzo	OM446LA (442)	390	530	01/96 >				S 3081 PO	
2653 K (SK)	OM446LA (442)	390	530	01/96 >		S 2162 N	S 7213 A		
some / alcuni	OM446LA (442)	390	530	01/96 >		S 2162 N	S 7213 A	S 3056 C	
dryer filter / filtro essiccatore	OM446LA (442)	390	530	01/96 >				S 7259 A	
power steering / servosterzo	OM446LA (442)	390	530	01/96 >				S 3081 PO	
L 2623	OM355	168	230	09/67 > 09/69	S 0300 O	S 2162 N	S 5270 A		
some / alcuni	OM355	168	230	09/67 > 09/69	S 0300 O	S 2162 N	S 5270 A		
power steering / servosterzo	OM355	168	230	09/67 > 09/69				S 8790 PO	
power steering / servosterzo	OM355	168	230	09/67 > 09/69				S 3081 PO	
L 2624	OM355	177	241	09/69 > 12/77	S 0300 O	S 2162 N			
	OM355	177	241	01/78 > 08/94	S 9490 PO	S 2162 N			
some / alcuni	OM355	177	241	09/69 > 12/77	S 0300 O	S 2162 N	S 5270 A		
some / alcuni	OM355	177	241	01/78 > 08/94	S 9490 PO	S 2162 N	S 5270 A		
power steering / servosterzo	OM355	177	241	09/69 > 08/94				S 8790 PO	
power steering / servosterzo	OM355	177	241	09/69 > 08/94				S 3081 PO	
L 2628	OM355A	206	280	11/78 > 02/01	S 9490 PO	S 2162 N	S 0450 A		
power steering / servosterzo	OM355A	206	280	11/78 > 02/01				S 3081 PO	
LAK 2624	OM355	177	241	09/69 > 12/77	S 0300 O	S 2162 N			
	OM355	177	241	01/78 > 08/94	S 9490 PO	S 2162 N			
some / alcuni	OM355	177	241	09/69 > 12/77	S 0300 O	S 2162 N	S 5270 A		
some / alcuni	OM355	177	241	01/78 > 08/94	S 9490 PO	S 2162 N	S 5270 A		
power steering / servosterzo	OM355	177	241	09/69 > 08/94				S 8790 PO	
power steering / servosterzo	OM355	177	241	09/69 > 08/94				S 3081 PO	
LK 2624	OM355	177	241	09/69 > 12/77	S 0300 O	S 2162 N			
	OM355	177	241	01/78 > 08/94	S 9490 PO	S 2162 N			
some / alcuni	OM355	177	241	09/69 > 12/77	S 0300 O	S 2162 N	S 5270 A		
some / alcuni	OM355	177	241	01/78 > 08/94	S 9490 PO	S 2162 N	S 5270 A		
power steering / servosterzo	OM355	177	241	09/69 > 08/94				S 8790 PO	
power steering / servosterzo	OM355	177	241	09/69 > 08/94				S 3081 PO	
30 t Serie									
3025	OM422	184	250	12/85 > 07/87	S 7261 PO	S 2162 N	S 6370 A		
dryer filter / filtro essiccatore	OM422	184	250	12/85 > 07/87				S 7259 A	
power steering / servosterzo	OM422	184	250	12/85 > 07/87				S 3081 PO	
3025	OM442.905	184	250	04/87 > 12/87	S 8260 PO	S 2162 N	S 3570 A		
dryer filter / filtro essiccatore	OM442.905	184	250	04/87 > 12/87				S 7259 A	
power steering / servosterzo	OM442.905	184	250	04/87 > 12/87				S 3081 PO	
3025 B	OM422	184	250	12/85 > 07/87	S 7261 PO	S 2162 N	S 6370 A		
dryer filter / filtro essiccatore	OM422	184	250	12/85 > 07/87				S 7259 A	
power steering / servosterzo	OM422	184	250	12/85 > 07/87				S 3081 PO	
3025 B	OM442.905	184	250	04/87 > 12/87	S 8260 PO	S 2162 N	S 3570 A		
dryer filter / filtro essiccatore	OM442.905	184	250	04/87 > 12/87				S 7259 A	
power steering / servosterzo	OM442.905	184	250	04/87 > 12/87				S 3081 PO	
3025 K	OM422	184	250	12/85 > 07/87	S 7261 PO	S 2162 N	S 6370 A		
dryer filter / filtro essiccatore	OM422	184	250	12/85 > 07/87				S 7259 A	
power steering / servosterzo	OM422	184	250	12/85 > 07/87				S 3081 PO	
3025 K	OM442.905	184	250	04/87 > 12/87	S 8260 PO	S 2162 N	S 3570 A		
dryer filter / filtro essiccatore	OM442.905	184	250	04/87 > 12/87				S 7259 A	
power steering / servosterzo	OM442.905	184	250	04/87 > 12/87				S 3081 PO	
3028	OM422	206	280	12/85 > 07/87	S 7261 PO	S 2162 N	S 6370 A		
some / alcuni	OM422	206	280	12/85 > 07/87	S 7261 PO	S 2162 N	S 3570 A		
power steering / servosterzo	OM422	206	280	12/85 > 07/87				S 3081 PO	
3028 B	OM422	206	280	12/85 > 07/87	S 7261 PO	S 2162 N	S 6370 A		
some / alcuni	OM422	206	280	12/85 > 07/87	S 7261 PO	S 2162 N	S 3570 A		
power steering / servosterzo	OM422	206	280	12/85 > 07/87				S 3081 PO	
3028 K	OM422	206	280	12/85 > 07/87	S 7261 PO	S 2162 N	S 6370 A		
some / alcuni	OM422	206	280	12/85 > 07/87	S 7261 PO	S 2162 N	S 3570 A		
power steering / servosterzo	OM422	206	280	12/85 > 07/87				S 3081 PO	
3032	OM403	235	320	09/73 > 03/82	S 7261 PO	S 2161 N	S 3570 A		
	OM403	235	320	04/82 > 08/93	S 7261 PO	S 2162 N	S 3570 A		
power steering / servosterzo	OM403	235	320	09/73 > 08/93				S 8790 PO	
3032	OM403.905	235	320	09/73 > 03/82		S 2161 N	S 3570 A		

**KW HP****...MERCEDES BENZ - trucks/autocarri**

	OM403.905	235	320	04/82 >	08/93		S 2162 N	S 3570 A	
power steering / servosterzo	OM403.905	235	320	09/73 >	08/93				S 8790 PO
3033	OM422A	243	330	05/82 >	05/87	S 7261 PO	S 2162 N	S 9570 A	
power steering / servosterzo	OM422A	243	330	05/82 >	05/87				S 3081 PO
3050	OM402	370	503	07/91 >	09/96		S 2162 N	S 7185 A	
some / alcuni	OM402	370	503	07/91 >	09/96		S 2162 N	S 1670 A	
some / alcuni	OM402	370	503	07/91 >	09/96		S 2162 N	S 7213 A	
dryer filter / filtro essiccatore	OM402	370	503	07/91 >	09/96				S 7259 A
power steering / servosterzo	OM402	370	503	07/91 >	09/96				S 3081 PO
3050	OM442LA	370	503	02/91 >	05/94		S 2162 N	S 7185 A	
	OM442LA	370	503	06/94 >	09/96		S 2162 N	S 7185 A	S 3056 C
some / alcuni	OM442LA	370	503	02/91 >	05/94		S 2162 N	S 7213 A	
some / alcuni	OM442LA	370	503	02/91 >	05/94		S 2162 N	S 1670 A	
some / alcuni	OM442LA	370	503	06/94 >	09/96		S 2162 N	S 7213 A	S 3056 C
some / alcuni	OM442LA	370	503	06/94 >	09/96		S 2162 N	S 1670 A	S 3056 C
dryer filter / filtro essiccatore	OM442LA	370	503	02/91 >	09/96				S 7259 A
power steering / servosterzo	OM442LA	370	503	02/91 >	09/96				S 3081 PO
3050 SK	OM440LA (442)	370	503	12/93 >	05/94		S 2162 N	S 7185 A	
	OM440LA (442)	370	503	06/94 >	09/96		S 2162 N	S 7185 A	S 3056 C
some / alcuni	OM440LA (442)	370	503	12/93 >	05/94		S 2162 N	S 1670 A	
some / alcuni	OM440LA (442)	370	503	12/93 >	05/94		S 2162 N	S 7213 A	
some / alcuni	OM440LA (442)	370	503	06/94 >	09/96		S 2162 N	S 1670 A	S 3056 C
some / alcuni	OM440LA (442)	370	503	06/94 >	09/96		S 2162 N	S 7213 A	S 3056 C
dryer filter / filtro essiccatore	OM440LA (442)	370	503	12/93 >	09/96				S 7259 A
power steering / servosterzo	OM440LA (442)	370	503	12/93 >	09/96				S 3081 PO
3053	OM442LA	390	530	08/94 >	09/96		S 2162 N	S 7213 A	
power steering / servosterzo	OM442LA	390	530	08/94 >	09/96				S 3081 PO
32 t Serie									
3225 B	OM422.920	184	250	07/87 >	03/91	S 7261 PO	S 2162 N	S 6370 A	
some / alcuni	OM422.920	184	250	07/87 >	03/91	S 8260 PO	S 2162 N	S 3570 A	
dryer filter / filtro essiccatore	OM422.920	184	250	07/87 >	03/91				S 7259 A
power steering / servosterzo	OM422.920	184	250	07/87 >	03/91				S 3081 PO
3225 K	OM422.920	184	250	07/87 >	03/91	S 7261 PO	S 2162 N	S 6370 A	
some / alcuni	OM422.920	184	250	07/87 >	03/91	S 8260 PO	S 2162 N	S 3570 A	
dryer filter / filtro essiccatore	OM422.920	184	250	07/87 >	03/91				S 7259 A
power steering / servosterzo	OM422.920	184	250	07/87 >	03/91				S 3081 PO
3228 B	OM422	206	280	07/87 >	03/91	S 7261 PO	S 2162 N	S 6370 A	
some / alcuni	OM422	206	280	07/87 >	03/91	S 7261 PO	S 2162 N	S 3570 A	
dryer filter / filtro essiccatore	OM422	206	280	07/87 >	03/91				S 7259 A
power steering / servosterzo	OM422	206	280	07/87 >	03/91				S 3081 PO
3228 K	OM422	206	280	07/87 >	03/91	S 7261 PO	S 2162 N	S 6370 A	
some / alcuni	OM422	206	280	07/87 >	03/91	S 7261 PO	S 2162 N	S 3570 A	
dryer filter / filtro essiccatore	OM422	206	280	07/87 >	03/91				S 7259 A
power steering / servosterzo	OM422	206	280	07/87 >	03/91				S 3081 PO
3229	OM442	213	290	09/89 >	12/89	S 7261 PO	S 2162 N	S 7185 A	
	OM442	213	290	01/90 >	08/94		S 2162 N	S 7185 A	
dryer filter / filtro essiccatore	OM442	213	290	09/89 >	08/94				S 7259 A
power steering / servosterzo	OM442	213	290	09/89 >	08/94				S 3081 PO
3233	OM441LA	250	340	10/90 >	07/92		S 2162 N	S 7185 A	
some / alcuni	OM441LA	250	340	10/90 >	07/92		S 2162 N	S 1670 A	
dryer filter / filtro essiccatore	OM441LA	250	340	10/90 >	07/92				S 7259 A
power steering / servosterzo	OM441LA	250	340	10/90 >	07/92				S 3081 PO
3234 (SK)	OM441LA	250	340	02/92 >	05/94		S 2162 N	S 7185 A	
	OM441LA	250	340	06/94 >	09/96		S 2162 N	S 7185 A	S 3056 C
dryer filter / filtro essiccatore	OM441LA	250	340	02/92 >	09/96				S 7259 A
power steering / servosterzo	OM441LA	250	340	02/92 >	09/96				S 3081 PO
3234 K (SK)	OM441LA	250	340	02/92 >	09/96	S 5133 PE		S 7185 A	
dryer filter / filtro essiccatore	OM441LA	250	340	02/92 >	09/96				S 7259 A
2 filters / N.2 filtri	OM441LA	250	340	02/92 >	09/96		S 2162 N		
power steering / servosterzo	OM441LA	250	340	02/92 >	09/96				S 3081 PO
3235	OM442A	260	354	07/87 >	04/88	S 7261 PO	S 2162 N	S 9570 A	
	OM442A	260	354	05/88 >	12/89	S 7261 PO	S 2162 N	S 1670 A	
	OM442A	260	354	10/88 >	07/92			S 7474 A	
some / alcuni	OM442A	260	354	07/87 >	07/92		S 2162 N	S 2450 A	
some / alcuni	OM442A	260	354	01/90 >	07/90	S 7261 PO	S 2162 N	S 1670 A	
some / alcuni	OM442A	260	354	08/90 >	07/92		S 2162 N	S 1670 A	
some L (Silent) / alcuni L (Silent)	OM442A	260	354	07/87 >	07/92		S 2162 N	S 7185 A	

M

**KW HP****...MERCEDES BENZ - trucks/autocarri****M**

dryer filter / filtro essiccatore	OM442A	260	354	07/87 > 07/92				S 7259 A
power steering / servosterzo	OM442A	260	354	07/87 > 07/92				S 3081 PO
3235 K	OM442A	260	354	07/87 > 04/88	S 7261 PO	S 2162 N	S 9570 A	
	OM442A	260	354	05/88 > 12/89	S 7261 PO	S 2162 N	S 1670 A	
some / alcuni	OM442A	260	354	07/87 > 07/92		S 2162 N	S 7185 A	
some / alcuni	OM442A	260	354	07/87 > 07/92		S 2162 N	S 2450 A	
some / alcuni	OM442A	260	354	01/90 > 07/90	S 7261 PO	S 2162 N	S 1670 A	
some / alcuni	OM442A	260	354	08/90 > 07/92		S 2162 N	S 1670 A	
dryer filter / filtro essiccatore	OM442A	260	354	07/87 > 07/92				S 7259 A
power steering / servosterzo	OM442A	260	354	07/87 > 07/92				S 3081 PO
3238 (SK)	OM402LA (422)	280	381	10/90 > 05/94		S 2162 N	S 7185 A	
	OM402LA (422)	280	381	06/94 > 09/96		S 2162 N	S 7185 A	S 3056 C
some / alcuni	OM402LA (422)	280	381	10/90 > 05/94		S 2162 N	S 1670 A	
some / alcuni	OM402LA (422)	280	381	06/94 > 09/96		S 2162 N	S 1670 A	S 3056 C
dryer filter / filtro essiccatore	OM402LA (422)	280	381	10/90 > 09/96				S 7259 A
power steering / servosterzo	OM402LA (422)	280	381	10/90 > 09/96				S 3081 PO
3238 AK (SK)	OM402LA (422)	280	381	10/90 > 09/96		S 2162 N	S 7185 A	
some / alcuni	OM402LA (422)	280	381	10/90 > 09/96		S 2162 N	S 1670 A	
dryer filter / filtro essiccatore	OM402LA (422)	280	381	10/90 > 09/96				S 7259 A
power steering / servosterzo	OM402LA (422)	280	381	10/90 > 09/96				S 3081 PO
3238 K (SK)	OM402LA (422)	280	381	10/90 > 09/96		S 2162 N	S 7185 A	
some / alcuni	OM402LA (422)	280	381	10/90 > 09/96		S 2162 N	S 1670 A	
dryer filter / filtro essiccatore	OM402LA (422)	280	381	10/90 > 09/96				S 7259 A
power steering / servosterzo	OM402LA (422)	280	381	10/90 > 09/96				S 3081 PO
3244	OM442LA	320	436	10/85 > 04/88	S 7261 PO	S 2162 N	S 9570 A	
	OM442LA	320	436	05/88 > 12/89	S 7261 PO	S 2162 N	S 1670 A	
some / alcuni	OM442LA	320	436	01/90 > 07/90	S 7261 PO	S 2162 N	S 1670 A	
some / alcuni	OM442LA	320	436	08/90 > 09/96		S 2162 N	S 1670 A	
some / alcuni	OM442LA	320	436	06/93 > 09/96		S 2162 N	S 7213 A	
power steering / servosterzo	OM442LA	320	436	10/85 > 09/96				S 3081 PO
3250	OM423LA/OM426LA	368	500		S 7261 PO	S 2162 N	S 3570 A	
power steering / servosterzo	OM423LA/OM426LA	368	500					S 3081 PO
3250	OM426LA	320	436		S 7261 PO	S 2162 N	S 3570 A	
power steering / servosterzo	OM426LA	320	436					S 3081 PO
3250	OM443LA	412	560		S 7261 PO	S 2162 N	S 3570 A	
power steering / servosterzo	OM443LA	412	560					S 3081 PO
3250 A	OM423LA	368	500	09/85 > 09/93	S 7261 PO	S 2162 N	S 3570 A	
dryer filter / filtro essiccatore	OM423LA	368	500	09/85 > 09/93				S 7259 A
power steering / servosterzo	OM423LA	368	500	09/85 > 09/93				S 3081 PO
3250 A	OM443.980LA	412	560	01/90 > 09/93	S 7261 PO	S 2162 N	S 3570 A	
dryer filter / filtro essiccatore	OM443.980LA	412	560	01/90 > 09/93				S 7259 A
power steering / servosterzo	OM443.980LA	412	560	01/90 > 09/93				S 3081 PO
3253 (SK)	OM446LA	390	530	01/96 > 09/96		S 2162 N	S 7213 A	S 3056 C
dryer filter / filtro essiccatore	OM446LA	390	530	01/96 > 09/96				S 7259 A
power steering / servosterzo	OM446LA	390	530	01/96 > 09/96				S 3081 PO
33 t Serie								
3328	OM422	206	280	07/82 > 07/87	S 7261 PO	S 2162 N	S 6370 A	
some / alcuni	OM422	206	280	07/82 > 07/87	S 7261 PO	S 2162 N	S 3570 A	
power steering / servosterzo	OM422	206	280	07/82 > 07/87				S 3081 PO
3333	OM422A	243	330	12/82 > 11/91	S 7261 PO	S 2162 N	S 9570 A	
dryer filter / filtro essiccatore	OM422A	243	330	01/85 > 11/91				S 7259 A
power steering / servosterzo	OM422A	243	330	12/82 > 11/91				S 3081 PO
3336	OM423	261	355	12/82 > 11/91	S 7261 PO	S 2162 N	S 3570 A	
dryer filter / filtro essiccatore	OM423	261	355	01/85 > 11/91				S 7259 A
power steering / servosterzo	OM423	261	355	12/82 > 11/91				S 3081 PO
3336	OM443A	261	355	12/82 > 11/91	S 7261 PO	S 2162 N	S 3570 A	
dryer filter / filtro essiccatore	OM443A	261	355	01/85 > 11/91				S 7259 A
power steering / servosterzo	OM443A	261	355	12/82 > 11/91				S 3081 PO
35 t Serie								
3528	OM422.919	206	280	07/87 > 09/89	S 7261 PO	S 2162 N	S 6370 A	
some / alcuni	OM422.919	206	280	07/87 > 09/89	S 7261 PO	S 2162 N	S 3570 A	
dryer filter / filtro essiccatore	OM422.919	206	280	07/87 > 09/89				S 7259 A
power steering / servosterzo	OM422.919	206	280	07/87 > 09/89				S 3081 PO
3528 B	OM422.919	206	280	07/87 > 09/89	S 7261 PO	S 2162 N	S 6370 A	
some / alcuni	OM422.919	206	280	07/87 > 09/89	S 7261 PO	S 2162 N	S 3570 A	
dryer filter / filtro essiccatore	OM422.919	206	280	07/87 > 09/89				S 7259 A
power steering / servosterzo	OM422.919	206	280	07/87 > 09/89				S 3081 PO

**KW HP****...MERCEDES BENZ - trucks/autocarri**

3528 K	OM422.919	206	280	07/87	>	09/89	S 7261 PO	S 2162 N	S 6370 A	
some / alcuni	OM422.919	206	280	07/87	>	09/89	S 7261 PO	S 2162 N	S 3570 A	
dryer filter / filtro essiccatore	OM422.919	206	280	07/87	>	09/89				S 7259 A
power steering / servosterzo	OM422.919	206	280	07/87	>	09/89				S 3081 PO
3534	OM441LA	250	340	10/93	>	05/94	S 5133 PE		S 7185 A	✗
	OM441LA	250	340	06/94	>	09/96	S 5133 PE		S 7185 A	S 3056 C
dryer filter / filtro essiccatore	OM441LA	250	340	10/93	>	09/96				S 7259 A
2 filters / N.2 filtri	OM441LA	250	340	10/93	>	09/96		S 2162 N		
power steering / servosterzo	OM441LA	250	340	10/93	>	09/96				S 3081 PO
3535	OM442A	260	354	10/88	>	12/89	S 7261 PO	S 2162 N	S 1670 A	
	OM442A	260	354	10/88	>	09/93			S 7474 A	
	OM442A	260	354	01/90	>	09/93		S 2162 N	S 1670 A	
some / alcuni	OM442A	260	354	10/88	>	12/89	S 7261 PO	S 2162 N	S 2450 A	
some / alcuni	OM442A	260	354	01/90	>	07/90	S 7261 PO	S 2162 N	S 2450 A	
some / alcuni	OM442A	260	354	08/90	>	09/93		S 2162 N	S 2450 A	
dryer filter / filtro essiccatore	OM442A	260	354	10/88	>	09/93				S 7259 A
series L (Silent) / Serie L (Silent)	OM442A	260	354	10/88	>	12/89	S 7261 PO	S 2162 N	S 7185 A	
series L (Silent) / Serie L (Silent)	OM442A	260	354	01/90	>	07/90	S 7261 PO	S 2162 N	S 7185 A	
series L (Silent) / Serie L (Silent)	OM442A	260	354	08/90	>	09/93		S 2162 N	S 7185 A	
power steering / servosterzo	OM442A	260	354	10/88	>	09/93				S 3081 PO
3536	OM423	261	355	11/81	>	03/91	S 7261 PO	S 2162 N	S 3570 A	
power steering / servosterzo	OM423	261	355	11/81	>	03/91				S 3081 PO
3536	OM443A	261	355	01/90	>	03/91	S 7261 PO	S 2162 N	S 3570 A	
power steering / servosterzo	OM443A	261	355	01/90	>	03/91				S 3081 PO
3538 (SK)	OM402LA	280	381	03/91	>	05/94		S 2162 N	S 7185 A	
	OM402LA	280	381	06/94	>	09/96		S 2162 N	S 7185 A	S 3056 C
some / alcuni	OM402LA	280	381	03/91	>	05/94		S 2162 N	S 1670 A	
some / alcuni	OM402LA	280	381	06/94	>	09/96		S 2162 N	S 1670 A	S 3056 C
dryer filter / filtro essiccatore	OM402LA	280	381	03/91	>	09/96				S 7259 A
power steering / servosterzo	OM402LA	280	381	03/91	>	09/96				S 3081 PO
3538 AK (SK)	OM402LA	280	381	03/91	>	09/96		S 2162 N	S 7185 A	
some / alcuni	OM402LA	280	381	03/91	>	09/96		S 2162 N	S 1670 A	
dryer filter / filtro essiccatore	OM402LA	280	381	03/91	>	09/96				S 7259 A
power steering / servosterzo	OM402LA	280	381	03/91	>	09/96				S 3081 PO
3538 K (SK)	OM402LA	280	381	03/91	>	09/96		S 2162 N	S 7185 A	
some / alcuni	OM402LA	280	381	03/91	>	09/96		S 2162 N	S 1670 A	
dryer filter / filtro essiccatore	OM402LA	280	381	03/91	>	09/96				S 7259 A
power steering / servosterzo	OM402LA	280	381	03/91	>	09/96				S 3081 PO
3544	OM440LA (442)	320	435	07/92	>	09/96		S 2162 N	S 9570 A	S 3056 C
some / alcuni	OM440LA (442)	320	435	07/92	>	09/96		S 2162 N	S 1670 A	S 3056 C
some / alcuni	OM440LA (442)	320	435	06/93	>	09/96		S 2162 N	S 7213 A	S 3056 C
power steering / servosterzo	OM440LA (442)	320	435	07/92	>	09/96				S 3081 PO
3544 S (SK)	OM440LA (442)	320	435	07/92	>	09/96		S 2162 N	S 9570 A	S 3056 C
some / alcuni	OM440LA (442)	320	435	07/92	>	09/96		S 2162 N	S 1670 A	S 3056 C
some / alcuni	OM440LA (442)	320	435	06/93	>	09/96		S 2162 N	S 7213 A	S 3056 C
power steering / servosterzo	OM440LA (442)	320	435	07/92	>	09/96				S 3081 PO
3548	OM440LA (442)	370	503	05/92	>	07/92		S 2162 N	S 1670 A	
some / alcuni	OM440LA (442)	370	503	05/92	>	07/92		S 2162 N	S 9570 A	
power steering / servosterzo	OM440LA (442)	370	503	05/92	>	07/92				S 3081 PO
3548	OM442LA	362	493				S 5133 PE		S 9570 A	✗
to frame No. 6901842 / a telaio N. 6901842	OM442LA	362	493				S 5133 PE		S 1670 A	✗
from frame No. 6901843 - 6902121 / da telaio N. 6901843 - 6902121	OM442LA	362	493				S 5133 PE		S 7213 A	✗
dryer filter / filtro essiccatore	OM442LA	362	493	10/90	>	07/92				S 7259 A
2 filters / N.2 filtri	OM442LA	362	493	10/90	>	07/92		S 2162 N		
power steering / servosterzo	OM442LA	362	493	10/90	>	07/92				S 3081 PO
3548 S	OM440LA (442)	370	503	05/92	>	07/92	S 5133 PE		S 1670 A	✗
some / alcuni	OM440LA (442)	370	503	05/92	>	07/92	S 5133 PE		S 9570 A	✗
dryer filter / filtro essiccatore	OM440LA (442)	370	503	05/92	>	07/92				S 7259 A
2 filters / N.2 filtri	OM440LA (442)	370	503	05/92	>	07/92		S 2162 N		
or / oppure	OM440LA (442)	370	503	05/92	>	07/92			S 7474 A	
power steering / servosterzo	OM440LA (442)	370	503	05/92	>	07/92				S 3081 PO
3548 S	OM442LA	362	493				S 5133 PE		S 9570 A	✗
to frame No. 6901842 / a telaio N. 6901842	OM442LA	362	493					S 2162 N	S 1670 A	
from frame No. 6901843 - 6902121 / da telaio N. 6901843 - 6902121	OM442LA	362	493					S 2162 N	S 7213 A	
power steering / servosterzo	OM442LA	362	493	10/90	>	07/92				S 3081 PO

M



KW HP



...MERCEDES BENZ - trucks/autocarri

M



3550 S (SK)	OM440LA (442)	370	503	05/92 >	05/94		S 2162 N	S 1670 A		
	OM440LA (442)	370	503	06/94 >	09/96		S 2162 N	S 1670 A	S 3056 C	
	some / alcuni	OM440LA (442)	370	503	05/92 >	05/94		S 2162 N	S 7213 A	
	some / alcuni	OM440LA (442)	370	503	06/94 >	09/96		S 2162 N	S 7213 A	S 3056 C
dryer filter / filtro essiccatore	OM440LA (442)	370	503	05/92 >	09/96				S 7259 A	
	power steering / servosterzo	OM440LA (442)	370	503	05/92 >	09/96			S 3081 PO	
3553 (SK)	OM446LA	390	530	04/92 >	05/94	S 5133 PE		S 7213 A	✗	
	OM446LA	390	530	06/94 >	09/96	S 5133 PE		S 7213 A	S 3056 C	
	dryer filter / filtro essiccatore	OM446LA	390	530	04/92 >	09/96			S 7259 A	
	2 filters / N.2 filtri	OM446LA	390	530	04/92 >	09/96	S 2162 N			
power steering / servosterzo	OM446LA	390	530	04/92 >	09/96			S 3081 PO		
3553 L (SK)	OM442/OM446	362	492	04/92 >	05/94	S 5133 PE		S 7213 A		
	OM442/OM446	362	492	06/94 >	09/96	S 5133 PE		S 7213 A	S 3056 C	
	dryer filter / filtro essiccatore	OM442/OM446	362	492	04/92 >	09/96			S 7259 A	
	2 filters / N.2 filtri	OM442/OM446	362	492	04/92 >	09/96	S 2162 N			
power steering / servosterzo	OM442/OM446	362	492	04/92 >	09/96			S 3081 PO		
3553 S (SK)	OM442LA	390	530	05/92 >	05/94		S 2162 N	S 7213 A		
	OM442LA	390	530	06/94 >	09/96		S 2162 N	S 7213 A	S 3056 C	
	dryer filter / filtro essiccatore	OM442LA	390	530	05/92 >	09/96			S 7259 A	
power steering / servosterzo	OM442LA	390	530	05/92 >	09/96			S 3081 PO		
38 t Serie										
3850	OM423LA	368	500	09/85 >	08/94	S 7261 PO	S 2162 N	S 3570 A		
	dryer filter / filtro essiccatore	OM423LA	368	500	09/85 >	08/94			S 7259 A	
	power steering / servosterzo	OM423LA	368	500	09/85 >	08/94			S 3081 PO	
3850 A	OM423LA	368	500	09/85 >	08/94	S 7261 PO	S 2162 N	S 3570 A		
	dryer filter / filtro essiccatore	OM423LA	368	500	09/85 >	08/94			S 7259 A	
	power steering / servosterzo	OM423LA	368	500	09/85 >	08/94			S 3081 PO	
L 3828	OM355A	206	280	05/79 >	02/01	S 9490 PO	S 2162 N	S 0450 A		
	power steering / servosterzo	OM355A	206	280	05/79 >	02/01			S 3081 PO	
4 t Serie										
405 D	OM314			01/67 >	02/77	S 4000 O	S 2161 N			
	OM314			03/77 >		S 5099 PE	S 2161 N			
	power steering / servosterzo	OM314		01/67 >					S 3081 PO	
408 D	OM314	63	85	01/70 >	02/77	S 4000 O	S 2161 N			
	OM314	63	85	03/77 >		S 5099 PE	S 2161 N			
	power steering / servosterzo	OM314	63	85	01/70 >				S 3081 PO	
L 408 DG	OM314	63	85	01/70 >	02/77	S 4000 O	S 2161 N			
	OM314	63	85	03/77 >		S 5099 PE	S 2161 N			
	power steering / servosterzo	OM314	63	85	01/70 >				S 3081 PO	
40 t Serie										
4050 A	OM423.950LA	368	500	07/87 >	07/91	S 7261 PO	S 2162 N	S 3570 A		
	dryer filter / filtro essiccatore	OM423.950LA	368	500	07/87 >	07/91			S 7259 A	
	power steering / servosterzo	OM423.950LA	368	500	07/87 >	07/91			S 3081 PO	
4050 A	OM440.975LA	370	503	07/87 >	07/91	S 7261 PO	S 2162 N	S 3570 A		
	dryer filter / filtro essiccatore	OM440.975LA	370	503	07/87 >	07/91			S 7259 A	
	power steering / servosterzo	OM440.975LA	370	503	07/87 >	07/91			S 3081 PO	
44 t Serie										
4435	OM442.959A (OM442A)	260	354	10/89 >	12/89	S 7261 PO		S 1670 A	✗	
	OM442.959A (OM442A)	260	354	01/90 >	07/90	S 7261 PO		S 1670 A	✗	
	OM442.959A (OM442A)	260	354	08/90 >	05/94	S 5133 PE		S 1670 A	✗	
	OM442.959A (OM442A)	260	354	06/94 >	09/96	S 5133 PE		S 1670 A	S 3056 C	
	some / alcuni	OM442.959A (OM442A)	260	354	01/90 >	07/90	S 5133 PE			
	some / alcuni	OM442.959A (OM442A)	260	354	01/90 >	07/90	S 7261 PO	S 2450 A	✗	
	some / alcuni	OM442.959A (OM442A)	260	354	08/90 >	05/94	S 5133 PE	S 2450 A	✗	
	some / alcuni	OM442.959A (OM442A)	260	354	06/94 >	09/96	S 5133 PE	S 2450 A	S 3056 C	
	dryer filter / filtro essiccatore	OM442.959A (OM442A)	260	354	10/89 >	09/96			S 7259 A	
	2 filters / N.2 filtri	OM442.959A (OM442A)	260	354	10/89 >	09/96		S 2162 N		
	series L (Silent) / Serie L (Silent)	OM442.959A (OM442A)	260	354	10/89 >	12/89	S 7261 PO		S 7185 A	✗
	series L (Silent) / Serie L (Silent)	OM442.959A (OM442A)	260	354	01/90 >	07/90	S 7261 PO		S 7185 A	✗
	series L (Silent) / Serie L (Silent)	OM442.959A (OM442A)	260	354	08/90 >	05/94	S 5133 PE		S 7185 A	✗
	series L (Silent) / Serie L (Silent)	OM442.959A (OM442A)	260	354	06/94 >	09/96	S 5133 PE		S 7185 A	S 3056 C
	power steering / servosterzo	OM442.959A (OM442A)	260	354	10/89 >	09/96				S 3081 PO
4435 K (SK)	OM442.959A (OM442A)	260	354	10/89 >	12/89	S 7261 PO		S 1670 A	✗	
	OM442.959A (OM442A)	260	354	10/89 >	08/96			S 7474 A		
	OM442.959A (OM442A)	260	354	01/90 >	07/90	S 7261 PO		S 1670 A	✗	
	OM442.959A (OM442A)	260	354	08/90 >	05/94	S 5133 PE		S 1670 A	✗	
	OM442.959A (OM442A)	260	354	06/94 >	09/96	S 5133 PE		S 1670 A		

**kW HP**

...MERCEDES BENZ - trucks/autocarri

some / alcuni	OM442.959A (OM442A)	260	354	01/90 >	07/90	S 5133 PE				
some / alcuni	OM442.959A (OM442A)	260	354	01/90 >	07/90	S 7261 PO				
some / alcuni	OM442.959A (OM442A)	260	354	08/90 >	05/94	S 5133 PE			S 2450 A	✗
some / alcuni	OM442.959A (OM442A)	260	354	06/94 >	09/96	S 5133 PE			S 2450 A	✗
dryer filter / filtro essiccatore	OM442.959A (OM442A)	260	354	10/89 >	09/96					S 7259 A
2 filters / N.2 filtri	OM442.959A (OM442A)	260	354	10/89 >	09/96		S 2162 N			
series L (Silent) / Serie L (Silent)	OM442.959A (OM442A)	260	354	10/89 >	12/89	S 7261 PO			S 7185 A	✗
series L (Silent) / Serie L (Silent)	OM442.959A (OM442A)	260	354	01/90 >	07/90	S 7261 PO			S 7185 A	✗
series L (Silent) / Serie L (Silent)	OM442.959A (OM442A)	260	354	08/90 >	05/94	S 5133 PE			S 7185 A	✗
series L (Silent) / Serie L (Silent)	OM442.959A (OM442A)	260	354	06/94 >	09/96	S 5133 PE			S 7185 A	
power steering / servosterzo	OM442.959A (OM442A)	260	354	10/89 >	09/96					S 3081 PO
4436	OM423	261	355	11/81 >	03/91	S 7261 PO	S 2162 N		S 3570 A	
power steering / servosterzo	OM423	261	355	11/81 >	03/91					S 3081 PO
4436	OM443A	261	355	01/90 >	03/91	S 7261 PO	S 2162 N		S 3570 A	
power steering / servosterzo	OM443A	261	355	01/90 >	03/91					S 3081 PO
48 t Serie										
4850 A	OM423.950LA	368	500	07/87 >	09/96	S 7261 PO	S 2162 N		S 3570 A	
dryer filter / filtro essiccatore	OM423.950LA	368	500	07/87 >	09/96					S 7259 A
power steering / servosterzo	OM423.950LA	368	500	07/87 >	09/96					S 3081 PO
5 t Serie										
507 D	OM616.914	53	72	04/86 >	04/89	S 2510 O	S 2610 NR		S 3030 A	
prefilter / prefiltrato	OM616.914	53	72	04/86 >	04/89		S 1013 B			
508 D	OM314	63	85	01/70 >	02/77	S 4000 O	S 2161 N			
	OM314	63	85	03/77 >	12/88	S 5099 PE	S 2161 N			
power steering / servosterzo	OM314	63	85	01/70 >	12/88					S 3081 PO
508 D	OM601.941	58	79	03/89 >	02/01	S 7510 O	S 9600 NR		S 3059 A	
508 I	OM314	63	85	01/85 >	02/01	S 5099 PE	S 2161 N			
510	M102.946	70	95	04/86 >	02/01	S 9080 PO			S 3030 A	
L 508 D	OM314	63	85	01/70 >	02/77	S 4000 O	S 2161 N			
	OM314	63	85	03/77 >	12/88	S 5099 PE	S 2161 N			
power steering / servosterzo	OM314	63	85	01/70 >	12/88					S 3081 PO
L 508 DG	OM314	63	85	01/70 >	02/77	S 4000 O	S 2161 N			
	OM314	63	85	03/77 >	12/88	S 5099 PE	S 2161 N			
power steering / servosterzo	OM314	63	85	01/70 >	12/88					S 3081 PO
6 t Serie										
608	OM314	63	85	10/69 >	02/77	S 4000 O	S 2161 N			
	OM314	63	85	03/77 >	10/77	S 5099 PE	S 2161 N			
power steering / servosterzo	OM314	63	85	10/69 >	10/77					S 3081 PO
608 D	OM314	63	85	01/70 >	02/77	S 4000 O	S 2161 N			
	OM314	63	85	03/77 >	12/88	S 5099 PE	S 2161 N			
power steering / servosterzo	OM314	63	85	01/70 >	12/88					S 3081 PO
609 D										
to engine No. 286114 / a motore N. 286114	OM364	63	85	04/86 >		S 5099 PE	S 2161 N		S 3030 A	
from engine No. 286115 / da motore N. 286115	OM364	63	85	>	09/01		S 2161 N		S 3030 A	
power steering / servosterzo	OM364	63	85	04/86 >	09/01					S 3081 PO
611 D	OM354LA (364)	77	105	06/94 >		S 5099 PE	S 2161 N		S 3059 A	
power steering / servosterzo	OM354LA (364)	77	105	06/94 >						S 3081 PO
613	OM353	96	130	04/77 >	12/78	S 0300 O	S 2161 N		S 7550 A	
	OM353	96	130	01/79 >	12/88	S 5124 PE	S 2161 N		S 7550 A	
613 D	OM353	96	130	04/77 >	12/78	S 0300 O	S 2161 N		S 7550 A	
	OM353	96	130	01/79 >	12/88	S 5124 PE	S 2161 N		S 7550 A	
L 608 D	OM314	63	85	01/70 >	02/77	S 4000 O	S 2161 N			
	OM314	63	85	03/77 >	12/88	S 5099 PE	S 2161 N			
power steering / servosterzo	OM314	63	85	01/70 >	12/88					S 3081 PO
L 613 D	OM353	96	130	04/77 >	12/78	S 0300 O	S 2161 N		S 7550 A	
	OM353	96	130	01/79 >	12/88	S 5124 PE	S 2161 N		S 7550 A	
LP 608	OM314	63	85	10/69 >	02/77	S 4000 O	S 2161 N			
	OM314	63	85	03/77 >	10/77	S 5099 PE	S 2161 N			
power steering / servosterzo	OM314	63	85	10/69 >	10/77					S 3081 PO
LPL 608	OM314	63	85	01/70 >	02/77	S 4000 O	S 2161 N			
	OM314	63	85	03/77 >	12/88	S 5099 PE	S 2161 N			
power steering / servosterzo	OM314	63	85	01/70 >	12/88					S 3081 PO
LPO 608	OM314	63	85	10/69 >	02/77	S 4000 O	S 2161 N			
	OM314	63	85	03/77 >	10/77	S 5099 PE	S 2161 N			
power steering / servosterzo	OM314	63	85	10/69 >	10/77					S 3081 PO
LPS 608	OM314	63	85	10/69 >	02/77	S 4000 O	S 2161 N			
	OM314	63	85	03/77 >	10/77	S 5099 PE	S 2161 N			

M



...MERCEDES BENZ - trucks/autocarri

M

power steering / servosterzo	OM314	63	85	10/69 >	10/77				S 3081 PO
7 t Serie									
709	OM314	63	85	11/77 >	03/84	S 5099 PE	S 2161 N		
power steering / servosterzo	OM314	63	85	11/77 >	03/84				S 3081 PO
709									
to engine No. 286114 / a motore N. 286114	OM364	63	86	03/84 >		S 5099 PE	S 2161 N	S 5250 A	✗
with R.H.D. to frame No. 5462572 / con guida a destra a telaio N. 5462572	OM364	63	86	03/84 >				S 2650 A	
with R.H.D. from frame No. 5462573 / con guida a destra da telaio N. 5462573	OM364	63	86	>	12/98			S 1070 A	
from engine No. 286115 / da motore N. 286115	OM364	63	86	>	12/98	S 5131 PE	S 2161 N	S 5250 A	✗
power steering / servosterzo	OM364	63	86	03/84 >	12/98				S 3081 PO
709 D									
to engine No. 286114 / a motore N. 286114	OM364	66	90	04/86 >		S 5099 PE	S 2161 N	S 3030 A	
from engine No. 286115 / da motore N. 286115	OM364	66	90	>	12/94		S 2161 N	S 3030 A	
710	OM352	81	110	10/69 >	12/70	S 0300 O	S 2162 N	S 2450 A	
	OM352	81	110	01/71 >	02/73	S 0300 O	S 2161 N	S 2450 A	
some / alcuni	OM352	81	110	10/69 >	12/70	S 0300 O	S 2162 N	S 5270 A	
some / alcuni	OM352	81	110	01/71 >	02/73	S 0300 O	S 2161 N	S 5270 A	
710									
to engine No. 286114 / a motore N. 286114	OM364A	81	110			S 5099 PE	S 2161 N	S 3059 A	
from engine No. 286115 / da motore N. 286115	OM364A	81	110				S 2161 N	S 3059 A	
711									
to engine No. 286114 / a motore N. 286114	OM354 (364) LA	77	105	03/94 >		S 5099 PE	S 2161 N	S 5250 A	
with R.H.D. / con guida a destra	OM354 (364) LA	77	105	03/94 >	12/98		S 2161 N	S 1070 A	
from engine No. 286115 / da motore N. 286115	OM354 (364) LA	77	105	>	12/98		S 2161 N	S 5250 A	
power steering / servosterzo	OM354 (364) LA	77	105	03/94 >	12/98				S 3081 PO
711	OM904.905LA	90	122	03/96 >		S 5007 PE	S 6017 NE	S 2650 A	
power steering / servosterzo	OM904.905LA	90	122	03/96 >					S 3081 PO
711 D	OM364A	85	115	04/86 >	12/94	S 5099 PE	S 2161 N	S 3059 A	
711 D	OM364LA	85	115	06/94 >		S 5099 PE	S 2161 N	S 3059 A	
712	OM364A	90	122	04/92 >		S 5099 PE	S 2161 N	S 3059 A	
714 D	OM354LA (364)	103	140	06/94 >		S 5099 PE	S 2161 N	S 3059 A	
power steering / servosterzo	OM354LA (364)	103	140	06/94 >					S 3081 PO
LP 709	OM314	63	85	11/77 >	03/84	S 5099 PE	S 2161 N		
power steering / servosterzo	OM314	63	85	11/77 >	03/84				S 3081 PO
LPKF 709	OM314	63	85	11/77 >	03/84	S 5099 PE	S 2161 N		
power steering / servosterzo	OM314	63	85	11/77 >	03/84				S 3081 PO
LPL 709	OM314	63	85	11/77 >	03/84	S 5099 PE	S 2161 N		
power steering / servosterzo	OM314	63	85	11/77 >	03/84				S 3081 PO
LPLS 709	OM314	63	85	11/77 >	03/84	S 5099 PE	S 2161 N		
power steering / servosterzo	OM314	63	85	11/77 >	03/84				S 3081 PO
LPO 709	OM314	63	85	11/77 >	03/84	S 5099 PE	S 2161 N		
power steering / servosterzo	OM314	63	85	11/77 >	03/84				S 3081 PO
LPS 709	OM314	63	85	11/77 >	03/84	S 5099 PE	S 2161 N		
power steering / servosterzo	OM314	63	85	11/77 >	03/84				S 3081 PO
8 t Serie									
808	OM314	63	85	10/69 >	02/77	S 4000 O	S 2161 N		
	OM314	63	85	03/77 >	10/77	S 5099 PE	S 2161 N		
power steering / servosterzo	OM314	63	85	10/69 >	10/77				S 3081 PO
808 D	OM314	63	85	10/69 >	02/77	S 4000 O	S 2161 N		
	OM314	63	85	03/77 >	10/77	S 5099 PE	S 2161 N		
power steering / servosterzo	OM314	63	85	10/69 >	10/77				S 3081 PO
809	OM314	63	85	11/77 >	03/84	S 5099 PE	S 2161 N		
power steering / servosterzo	OM314	63	85	11/77 >	03/84				S 3081 PO
809									
to engine No. 286114 / a motore N. 286114	OM364	63	85			S 5099 PE	S 2161 N	S 5250 A	
from engine No. 286115 / da motore N. 286115	OM364	63	85				S 2161 N	S 5250 A	
power steering / servosterzo	OM364	63	85	03/84 >	02/93				S 3081 PO
809									
to engine No. 286114 / a motore N. 286114	OM364.907	66	90	03/84 >		S 5099 PE	S 2161 N	S 5250 A	
to frame No. 5462572 (R.H.D.) / a telaio N. 5462572 (R.H.D.)	OM364.907	66	90					S 2650 A	
from engine No. 286115 / da motore N. 286115	OM364.907	66	90	>	03/93		S 2161 N	S 5250 A	
from frame No. 5462573 (R.H.D.) / da telaio N. 5462573 (R.H.D.)	OM364.907	66	90					S 1070 A	
power steering / servosterzo	OM364.907	66	90	03/84 >	03/93				S 3081 PO
809	OM904LA	100	136	01/96 >		S 5007 PE	S 6017 NE	S 2650 A	
power steering / servosterzo	OM904LA	100	136	01/96 >					S 3081 PO
809 D									
to engine No. 286114 / a motore N. 286114	OM364	66	90			S 5099 PE	S 2161 N	S 3030 A	

**kW HP****...MERCEDES BENZ - trucks/autocarri**

from engine No. 286115 / da motore N. 286115	OM364	66	90			S 2161 N	S 3030 A	
809 DT								
to engine No. 286114 / a motore N. 286114	OM364	66	90	04/86 >	S 5099 PE	S 2161 N	S 3030 A	
from engine No. 286115 / da motore N. 286115	OM364	66	90	> 12/94		S 2161 N	S 3030 A	
809 RHD								
to engine No. 286114 / a motore N. 286114	OM364.907	66	90		S 5099 PE	S 2161 N		
to frame No. 5462572 / a telaio N. 5462572	OM364.907	66	90				S 2650 A	
from engine No. 286115 / da motore N. 286115	OM364.907	66	90			S 2161 N		
from frame No. 5462573 / da telaio N. 5462573	OM364.907	66	90				S 1070 A	
power steering / servosterzo	OM364.907	66	90	03/84 > 03/93				S 3081 PO
810								
	OM352	81	110	10/69 > 12/70	S 0300 O	S 2162 N	S 2450 A	
	OM352	81	110	01/71 > 02/73	S 0300 O	S 2161 N	S 2450 A	
some / alcuni	OM352	81	110	10/69 > 12/70	S 0300 O	S 2162 N	S 5270 A	
some / alcuni	OM352	81	110	01/71 > 02/73	S 0300 O	S 2161 N	S 5270 A	
811								
	OM352	81	110	10/69 > 12/70	S 0300 O	S 2162 N	S 2450 A	
	OM352	81	110	01/71 > 02/73	S 0300 O	S 2161 N	S 2450 A	
some / alcuni	OM352	81	110	10/69 > 12/70	S 0300 O	S 2162 N	S 5270 A	
some / alcuni	OM352	81	110	10/69 > 12/70	S 0300 O	S 2162 N	S 7550 A	
some / alcuni	OM352	81	110	01/71 > 02/73	S 0300 O	S 2161 N	S 5270 A	
some / alcuni	OM352	81	110	01/71 > 02/73	S 0300 O	S 2161 N	S 7550 A	
811								
to engine No. 286114 / a motore N. 286114	OM354 (364) LA	77	105	03/94 >	S 5099 PE	S 2161 N	S 5250 A	
with R.H.D. / con guida a destra	OM354 (364) LA	77	105	03/94 >		S 2161 N	S 1070 A	
from engine No. 286115 / da motore N. 286115	OM354 (364) LA	77	105			S 2161 N	S 5250 A	
dryer filter / filtro essiccatore	OM354 (364) LA	77	105	03/94 >				S 7259 A
power steering / servosterzo	OM354 (364) LA	77	105	03/94 >				S 3081 PO
811								
dryer filter / filtro essiccatore	OM904LA	90	122	03/96 >	S 5007 PE	S 6017 NE	S 2650 A	
power steering / servosterzo	OM904LA	90	122	03/96 >				S 7259 A
	OM904LA	90	122	03/96 >				S 3081 PO
811 D								
dryer filter / filtro essiccatore	OM354LA (364)	85	115	06/94 >	S 5099 PE	S 2161 N	S 3059 A	
	OM354LA (364)	85	115	06/94 >				S 7259 A
811 D								
	OM364A	85	115	04/86 > 12/94	S 5099 PE	S 2161 N	S 3059 A	
811 DT								
dryer filter / filtro essiccatore	OM354LA (364)	77	105	06/94 >	S 5099 PE	S 2161 N	S 3059 A	
	OM354LA (364)	77	105	06/94 >				S 7259 A
813								
	OM353	96	130	03/73 > 12/77	S 0300 O	S 2161 N	S 1070 A	
	OM353	96	130	01/78 > 12/84	S 5124 PE	S 2161 N	S 1070 A	
power steering / servosterzo	OM353	96	130	03/73 > 12/84				S 3081 PO
power steering / servosterzo	OM353	96	130	03/73 > 12/84				S 8790 PO
814								
dryer filter / filtro essiccatore	OM354LA (364)			03/94 >	S 5099 PE	S 2161 N	S 3059 A	
power steering / servosterzo	OM354LA (364)			03/94 >				S 7259 A
	OM354LA (364)			03/94 >				S 3081 PO
814								
to engine No. 286114 / a motore N. 286114	OM356 (366)				S 5099 PE	S 2161 N	S 5250 A	
from engine No. 286115 / da motore N. 286115	OM356 (366)					S 2161 N	S 5250 A	
dryer filter / filtro essiccatore	OM356 (366)			02/92 >				S 7259 A
power steering / servosterzo	OM356 (366)			02/92 >				S 3081 PO
814								
dryer filter / filtro essiccatore	OM364LA			11/87 >	S 5099 PE	S 2161 N	S 3059 A	
power steering / servosterzo	OM364LA			11/87 >				S 7259 A
	OM364LA			11/87 >				S 3081 PO
814								
	OM366			04/84 > 09/88	S 5124 PE	S 2161 N	S 5250 A	
	OM366			10/88 > 02/93	S 5099 PE	S 2161 N	S 5250 A	
power steering / servosterzo	OM366			04/84 > 02/93				S 3081 PO
814								
	OM366.918			04/84 > 09/88	S 5124 PE	S 2161 N		
	OM366.918			10/88 > 02/93	S 5099 PE	S 2161 N		
power steering / servosterzo	OM366.918			04/84 > 02/93				S 3081 PO
814								
dryer filter / filtro essiccatore	OM904LA	103	140	03/96 >	S 5007 PE	S 6017 NE	S 2650 A	
power steering / servosterzo	OM904LA	103	140	03/96 >				S 7259 A
	OM904LA	103	140	03/96 >				S 3081 PO
814 D								
dryer filter / filtro essiccatore	OM354LA (364)			03/94 >	S 5099 PE	S 2161 N	S 3059 A	
power steering / servosterzo	OM354LA (364)			03/94 >				S 7259 A
	OM354LA (364)			03/94 >				S 3081 PO
814 D								
dryer filter / filtro essiccatore	OM364LA			11/87 >	S 5099 PE	S 2161 N	S 3059 A	
power steering / servosterzo	OM364LA			11/87 >				S 7259 A
	OM364LA			11/87 >				S 3081 PO
814 DA								
dryer filter / filtro essiccatore	OM354LA (364)			03/94 >	S 5099 PE	S 2161 N	S 3059 A	
power steering / servosterzo	OM354LA (364)			03/94 >				S 7259 A
	OM354LA (364)			03/94 >				S 3081 PO

M



kW HP



...MERCEDES BENZ - trucks/autocarri

M



814 DA	OM364LA			11/87 >	S 5099 PE	S 2161 N	S 3059 A	
dryer filter / filtro essiccatore	OM364LA			11/87 >				S 7259 A
power steering / servosterzo	OM364LA			11/87 >				S 3081 PO
814 L/LO								
to engine No. 286114 / a motore N. 286114	OM354.920/922	103	140	03/94 >	S 5099 PE	S 2161 N	S 5250 A	
with R.H.D. / con guida a destra	OM354.920/922	103	140	03/94 > 12/98		S 2161 N	S 1070 A	
from engine No. 286115 / da motore N. 286115	OM354.920/922	103	140	> 12/98		S 2161 N	S 5250 A	
dryer filter / filtro essiccatore	OM354.920/922	103	140	03/94 > 12/98				S 7259 A
power steering / servosterzo	OM354.920/922	103	140	03/94 > 12/98				S 3081 PO
814 LO								
to engine No. 286114 / a motore N. 286114	OM356 (366)				S 5099 PE	S 2161 N	S 5250 A	
from engine No. 286115 / da motore N. 286115	OM356 (366)					S 2161 N	S 5250 A	
dryer filter / filtro essiccatore	OM356 (366)			02/92 >				S 7259 A
power steering / servosterzo	OM356 (366)			02/92 >				S 3081 PO
814 LO	OM366			04/84 > 09/88	S 5124 PE	S 2161 N	S 5250 A	
	OM366			10/88 > 02/93	S 5099 PE	S 2161 N	S 5250 A	
power steering / servosterzo	OM366			04/84 > 02/93				S 3081 PO
814 LO	OM366.918			04/84 > 09/88	S 5124 PE	S 2161 N		
	OM366.918			10/88 > 02/93	S 5099 PE	S 2161 N		
power steering / servosterzo	OM366.918			04/84 > 02/93				S 3081 PO
814 LO	OM904LA	103	140	03/96 >	S 5007 PE	S 6017 NE	S 2650 A	
dryer filter / filtro essiccatore	OM904LA	103	140	03/96 >				S 7259 A
power steering / servosterzo	OM904LA	103	140	03/96 >				S 3081 PO
817	OM356A (366)			02/92 >		S 2161 N	S 2650 A	
to engine No. 286114 / a motore N. 286114	OM356A (366)				S 5099 PE	S 2161 N		
to engine No. 286114 / a motore N. 286114	OM356A (366)				S 5124 PE	S 2161 N		
some / alcuni	OM356A (366)			02/92 >		S 2161 N		
some / alcuni	OM356A (366)			02/92 >		S 2161 N	S 6370 A	
from engine No. 286115 / da motore N. 286115	OM356A (366)					S 2161 N		
from engine No. 286115 / da motore N. 286115	OM356A (366)					S 2161 N		
dryer filter / filtro essiccatore	OM356A (366)			02/92 >				S 7259 A
power steering / servosterzo	OM356A (366)			02/92 >				S 3081 PO
817	OM357LA (366)			03/94 >		S 2161 N	S 2650 A	
some / alcuni	OM357LA (366)			03/94 >		S 2161 N	S 2650 A	
dryer filter / filtro essiccatore	OM357LA (366)			03/94 >				S 7259 A
power steering / servosterzo	OM357LA (366)			03/94 >				S 3081 PO
817	OM366A	116	158	07/84 > 09/88	S 8260 PO	S 2161 N	S 2650 A	
	OM366A	116	158	10/88 > 02/93	S 5124 PE	S 2161 N	S 2650 A	
some / alcuni	OM366A	116	158	07/84 > 09/88	S 8260 PO	S 2161 N	S 6370 A	
some / alcuni	OM366A	116	158	10/88 > 02/93	S 5124 PE	S 2161 N	S 6370 A	
some / alcuni	OM366A	116	158	01/89 > 02/93	S 5124 PE	S 2161 N		
some / alcuni	OM366A	116	158	01/92 > 02/93		S 2161 N		
power steering / servosterzo	OM366A	116	158	07/84 > 02/93				S 3081 PO
817	OM904.907LA	125	170	03/96 >	S 5007 PE	S 6017 NE	S 2650 A	
dryer filter / filtro essiccatore	OM904.907LA	125	170	03/96 >				S 7259 A
power steering / servosterzo	OM904.907LA	125	170	03/96 >				S 3081 PO
817	OM904LA	100	136	03/96 >	S 5007 PE	S 6017 NE	S 2650 A	
dryer filter / filtro essiccatore	OM904LA	100	136	03/96 >				S 7259 A
power steering / servosterzo	OM904LA	100	136	03/96 >				S 3081 PO
817 F	OM356A (366)			02/92 >		S 2161 N	S 2650 A	
to engine No. 286114 / a motore N. 286114	OM356A (366)				S 5124 PE	S 2161 N		
to engine No. 286114 / a motore N. 286114	OM356A (366)				S 5099 PE	S 2161 N		
some / alcuni	OM356A (366)			02/92 >		S 2161 N		
some / alcuni	OM356A (366)			02/92 >		S 2161 N	S 6370 A	
from engine No. 286115 / da motore N. 286115	OM356A (366)					S 2161 N		
from engine No. 286115 / da motore N. 286115	OM356A (366)					S 2161 N		
dryer filter / filtro essiccatore	OM356A (366)			02/92 >				S 7259 A
power steering / servosterzo	OM356A (366)			02/92 >				S 3081 PO
817 LO	OM356A (366)			02/92 >		S 2161 N	S 2650 A	
to engine No. 286114 / a motore N. 286114	OM356A (366)				S 5124 PE	S 2161 N		
to engine No. 286114 / a motore N. 286114	OM356A (366)				S 5099 PE	S 2161 N		
some / alcuni	OM356A (366)			02/92 >		S 2161 N	S 6370 A	
from engine No. 286115 / da motore N. 286115	OM356A (366)					S 2161 N		
from engine No. 286115 / da motore N. 286115	OM356A (366)					S 2161 N		
dryer filter / filtro essiccatore	OM356A (366)			02/92 >				S 7259 A
power steering / servosterzo	OM356A (366)			02/92 >				S 3081 PO
817 LO	OM357LA (366)			03/94 >		S 2161 N	S 2650 A	

**kW HP****...MERCEDES BENZ - trucks/autocarri**

some / alcuni	OM357LA (366)			03/94 >		S 2161 N	S 2650 A		
dryer filter / filtro essiccatore	OM357LA (366)			03/94 >				S 7259 A	
power steering / servosterzo	OM357LA (366)			03/94 >				S 3081 PO	
817 LO	OM366A			07/84 > 09/88	S 8260 PO	S 2161 N	S 2650 A		
	OM366A			10/88 > 02/93	S 5124 PE	S 2161 N	S 2650 A		
some / alcuni	OM366A			07/84 > 09/88	S 8260 PO	S 2161 N	S 6370 A		
some / alcuni	OM366A			10/88 > 02/93	S 5124 PE	S 2161 N	S 6370 A		
some / alcuni	OM366A			01/89 > 02/93	S 5124 PE	S 2161 N			
some / alcuni	OM366A			01/92 > 02/93		S 2161 N			
power steering / servosterzo	OM366A			07/84 > 02/93				S 3081 PO	
820	OM366LA	155	211	09/96 >		S 2161 N	S 2650 A		
dryer filter / filtro essiccatore	OM366LA	155	211	09/96 >				S 7259 A	
power steering / servosterzo	OM366LA	155	211	09/96 >				S 3081 PO	
LP 808	OM314	63	85	10/69 > 02/77	S 4000 O	S 2161 N			
	OM314	63	85	03/77 > 10/77	S 5099 PE	S 2161 N			
power steering / servosterzo	OM314	63	85	10/69 > 10/77				S 3081 PO	
LP 809	OM314	63	85	11/77 > 03/84	S 5099 PE	S 2161 N			
power steering / servosterzo	OM314	63	85	11/77 > 03/84				S 3081 PO	
LP 811	OM352	81	110	10/69 > 12/70	S 0300 O	S 2162 N	S 2450 A		
	OM352	81	110	01/71 > 02/73	S 0300 O	S 2161 N	S 2450 A		
some / alcuni	OM352	81	110	10/69 > 12/70	S 0300 O	S 2162 N	S 7550 A		
some / alcuni	OM352	81	110	10/69 > 12/70	S 0300 O	S 2162 N	S 5270 A		
some / alcuni	OM352	81	110	01/71 > 02/73	S 0300 O	S 2161 N	S 7550 A		
some / alcuni	OM352	81	110	01/71 > 02/73	S 0300 O	S 2161 N	S 5270 A		
LP 813	OM353	96	130	03/73 > 12/77	S 0300 O	S 2161 N	S 1070 A		
	OM353	96	130	01/78 > 12/84	S 5124 PE	S 2161 N	S 1070 A		
power steering / servosterzo	OM353	96	130	03/73 > 12/84				S 3081 PO	
power steering / servosterzo	OM353	96	130	03/73 > 12/84				S 8790 PO	
LPL 809	OM314	63	85	11/77 > 03/84	S 5099 PE	S 2161 N			
power steering / servosterzo	OM314	63	85	11/77 > 03/84				S 3081 PO	
LPO 808	OM314	63	85	10/69 > 02/77	S 4000 O	S 2161 N			
	OM314	63	85	03/77 > 10/77	S 5099 PE	S 2161 N			
power steering / servosterzo	OM314	63	85	10/69 > 10/77				S 3081 PO	
LPS 811	OM352	81	110	10/69 > 12/70	S 0300 O	S 2162 N	S 2450 A		
	OM352	81	110	01/71 > 02/73	S 0300 O	S 2161 N	S 2450 A		
some / alcuni	OM352	81	110	10/69 > 12/70	S 0300 O	S 2162 N	S 7550 A		
some / alcuni	OM352	81	110	10/69 > 12/70	S 0300 O	S 2162 N	S 5270 A		
some / alcuni	OM352	81	110	01/71 > 02/73	S 0300 O	S 2161 N	S 7550 A		
some / alcuni	OM352	81	110	01/71 > 02/73	S 0300 O	S 2161 N	S 5270 A		
9 t Serie									
911	OM353.909	81	110	01/72 > 03/77	S 0300 O	S 2161 N			
some / alcuni	OM353.909	81	110	01/72 > 03/77	S 0300 O	S 2161 N	S 1070 A		
power steering / servosterzo	OM353.909	81	110	01/72 > 03/77				S 3081 PO	
power steering / servosterzo	OM353.909	81	110	01/72 > 03/77				S 8790 PO	
912	OM364A	90	122	03/88 >	S 5099 PE	S 2161 N	S 3059 A		
dryer filter / filtro essiccatore	OM364A	90	122	03/88 >				S 7259 A	
914	OM356 (366)	100	136		S 5099 PE	S 2161 N	S 5250 A		
to engine No. 286114 / a motore N. 286114	OM356 (366)	100	136			S 2161 N	S 5250 A		
from engine No. 286115 / da motore N. 286115	OM356 (366)	100	136						
dryer filter / filtro essiccatore	OM356 (366)	100	136	02/92 >				S 7259 A	
power steering / servosterzo	OM356 (366)	100	136	02/92 >				S 3081 PO	
914	OM364LA	103	140	12/94 >	S 5099 PE	S 2161 N	S 3059 A		
dryer filter / filtro essiccatore	OM364LA	103	140	12/94 >				S 7259 A	
power steering / servosterzo	OM364LA	103	140	12/94 >				S 3081 PO	
914	OM366	100	136	04/84 > 09/88	S 5124 PE	S 2161 N	S 5250 A		
to engine No. 916577 / a motore N. 916577	OM366	100	136	10/88 > 02/93	S 5099 PE	S 2161 N	S 5250 A		
from engine No. 916578 / da motore N. 916578	OM366	100	136	01/85 > 02/93				S 7259 A	
dryer filter / filtro essiccatore	OM366	100	136	04/84 > 02/93				S 3081 PO	
power steering / servosterzo	OM366	100	136	04/84 > 02/93					
914	OM904LA	100	136	01/96 >	S 5007 PE	S 6017 NE	S 2650 A		
dryer filter / filtro essiccatore	OM904LA	100	136	01/96 >				S 7259 A	
power steering / servosterzo	OM904LA	100	136	01/96 >				S 3081 PO	
914 A	OM366	100	136	04/84 > 09/88	S 5124 PE	S 2161 N	S 5250 A		
to engine No. 916577 / a motore N. 916577	OM366	100	136	10/88 > 02/93	S 5099 PE	S 2161 N	S 5250 A		
from engine No. 916578 / da motore N. 916578	OM366	100	136	01/85 > 02/93				S 7259 A	
dryer filter / filtro essiccatore	OM366	100	136	04/84 > 02/93				S 3081 PO	
power steering / servosterzo	OM366	100	136	04/84 > 02/93					

M

**KW HP****...MERCEDES BENZ - trucks/autocarri****M**

914 AK									
to engine No. 286114 / a motore N. 286114	OM356 (366)	100	136		S 5099 PE	S 2161 N	S 5250 A		
from engine No. 286115 / da motore N. 286115	OM356 (366)	100	136			S 2161 N	S 5250 A		
dryer filter / filtro essiccatore	OM356 (366)	100	136	02/92 >					S 7259 A
power steering / servosterzo	OM356 (366)	100	136	02/92 >					S 3081 PO
914 KO									
to engine No. 286114 / a motore N. 286114	OM356 (366)	100	136		S 5099 PE	S 2161 N	S 5250 A		
from engine No. 286115 / da motore N. 286115	OM356 (366)	100	136			S 2161 N	S 5250 A		
dryer filter / filtro essiccatore	OM356 (366)	100	136	02/92 >					S 7259 A
power steering / servosterzo	OM356 (366)	100	136	02/92 >					S 3081 PO
914 KO									
to engine No. 916577 / a motore N. 916577	OM366	100	136	04/84 > 09/88	S 5124 PE	S 2161 N	S 5250 A		
from engine No. 916578 / da motore N. 916578	OM366	100	136	10/88 > 02/93	S 5099 PE	S 2161 N	S 5250 A		
dryer filter / filtro essiccatore	OM366	100	136	01/85 > 02/93					S 7259 A
power steering / servosterzo	OM366	100	136	04/84 > 02/93					S 3081 PO
914 O									
to engine No. 916577 / a motore N. 916577	OM366	100	136	04/84 > 09/88	S 5124 PE	S 2161 N	S 5250 A		
from engine No. 916578 / da motore N. 916578	OM366	100	136	10/88 > 02/93	S 5099 PE	S 2161 N	S 5250 A		
dryer filter / filtro essiccatore	OM366	100	136	01/85 > 02/93					S 7259 A
power steering / servosterzo	OM366	100	136	04/84 > 02/93					S 3081 PO
917									
to engine No. 286114 / a motore N. 286114	OM356A (366)	125	170	12/92 >	S 5099 PE	S 2161 N	S 2650 A		
to engine No. 286114 / a motore N. 286114	OM356A (366)	125	170		S 5124 PE	S 2161 N			
some / alcuni	OM356A (366)	125	170	12/92 >		S 2161 N	S 6370 A		
some / alcuni	OM356A (366)	125	170	12/92 >		S 2161 N	S 9570 A		
from engine No. 286115 / da motore N. 286115	OM356A (366)	125	170			S 2161 N			
from engine No. 286115 / da motore N. 286115	OM356A (366)	125	170			S 2161 N			
dryer filter / filtro essiccatore	OM356A (366)	125	170	12/92 >					S 7259 A
power steering / servosterzo	OM356A (366)	125	170	12/92 >					S 3081 PO
917									
some / alcuni	OM357LA (366)	125	170	03/94 > 12/98	S 5132 PE	S 2161 N	S 2650 A		
dryer filter / filtro essiccatore	OM357LA (366)	125	170	03/94 > 12/98			S 4940 A		
power steering / servosterzo	OM357LA (366)	125	170	03/94 > 12/98					S 7259 A
	OM357LA (366)	125	170	03/94 > 12/98					S 3081 PO
917									
	OM366A	125	170	07/84 > 09/88	S 8260 PO	S 2161 N	S 2650 A		
	OM366A	125	170	10/88 > 02/93	S 5124 PE	S 2161 N	S 2650 A		
some / alcuni	OM366A	125	170	07/84 > 09/88	S 8260 PO	S 2161 N	S 6370 A		
some / alcuni	OM366A	125	170	10/88 > 02/93	S 5099 PE	S 2161 N	S 6370 A		
some / alcuni	OM366A	125	170	10/88 > 02/93	S 5124 PE	S 2161 N	S 6370 A		
some / alcuni	OM366A	125	170	01/89 > 02/93		S 2161 N	S 9570 A		
dryer filter / filtro essiccatore	OM366A	125	170	01/85 > 02/93					S 7259 A
power steering / servosterzo	OM366A	125	170	07/84 > 02/93					S 3081 PO
917									
dryer filter / filtro essiccatore	OM904LA	125	170	03/96 >	S 5007 PE	S 6017 NE	S 2650 A		
power steering / servosterzo	OM904LA	125	170	03/96 >					S 7259 A
	OM904LA	125	170	03/96 >					S 3081 PO
917 AF									
	OM356A (366)	125	170	12/92 >		S 2161 N	S 2650 A		
to engine No. 286114 / a motore N. 286114	OM356A (366)	125	170		S 5099 PE	S 2161 N			
to engine No. 286114 / a motore N. 286114	OM356A (366)	125	170		S 5124 PE	S 2161 N			
some / alcuni	OM356A (366)	125	170	12/92 >		S 2161 N	S 9570 A		
some / alcuni	OM356A (366)	125	170	12/92 >		S 2161 N	S 6370 A		
from engine No. 286115 / da motore N. 286115	OM356A (366)	125	170			S 2161 N			
from engine No. 286115 / da motore N. 286115	OM356A (366)	125	170			S 2161 N			
dryer filter / filtro essiccatore	OM356A (366)	125	170	12/92 >					S 7259 A
power steering / servosterzo	OM356A (366)	125	170	12/92 >					S 3081 PO
917 AF									
some / alcuni	OM357LA (366)	125	170	03/94 > 12/98	S 5132 PE	S 2161 N	S 2650 A		
dryer filter / filtro essiccatore	OM357LA (366)	125	170	03/94 > 12/98			S 4940 A		
power steering / servosterzo	OM357LA (366)	125	170	03/94 > 12/98					S 7259 A
	OM357LA (366)	125	170	03/94 > 12/98					S 3081 PO
917 AF									
	OM366A	125	170	07/84 > 09/88	S 8260 PO	S 2161 N	S 2650 A		
	OM366A	125	170	10/88 > 02/93	S 5124 PE	S 2161 N	S 2650 A		
some / alcuni	OM366A	125	170	07/84 > 09/88	S 8260 PO	S 2161 N	S 6370 A		
some / alcuni	OM366A	125	170	10/88 > 02/93	S 5099 PE	S 2161 N	S 6370 A		
some / alcuni	OM366A	125	170	10/88 > 02/93	S 5124 PE	S 2161 N	S 6370 A		
some / alcuni	OM366A	125	170	01/89 > 02/93		S 2161 N	S 9570 A		
dryer filter / filtro essiccatore	OM366A	125	170	01/85 > 02/93					S 7259 A
power steering / servosterzo	OM366A	125	170	07/84 > 02/93					S 3081 PO
917 AK									
some / alcuni	OM357LA (366)	125	170	03/94 > 12/98	S 5132 PE	S 2161 N	S 2650 A		
	OM357LA (366)	125	170	03/94 > 12/98			S 4940 A		

**kW HP****...MERCEDES BENZ - trucks/autocarri**

dryer filter / filtro essiccatore	OM357LA (366)	125	170	03/94 >	12/98				S 7259 A
power steering / servosterzo	OM357LA (366)	125	170	03/94 >	12/98				S 3081 PO
917 KO	OM357LA (366)	125	170	03/94 >	12/98	S 5132 PE	S 2161 N	S 2650 A	
some / alcuni	OM357LA (366)	125	170	03/94 >	12/98			S 4940 A	
dryer filter / filtro essiccatore	OM357LA (366)	125	170	03/94 >	12/98				S 7259 A
power steering / servosterzo	OM357LA (366)	125	170	03/94 >	12/98				S 3081 PO
917 KO	OM904LA	125	170	03/96 >		S 5007 PE	S 6017 NE	S 2650 A	
dryer filter / filtro essiccatore	OM904LA	125	170	03/96 >					S 7259 A
power steering / servosterzo	OM904LA	125	170	03/96 >					S 3081 PO
L 911 B	OM352	81	110	10/68 >	12/77	S 0300 O	S 2161 N	S 1070 A	
	OM352	81	110	01/78 >	02/01	S 5124 PE	S 2161 N	S 1070 A	
power steering / servosterzo	OM352	81	110	10/68 >	02/01				S 3081 PO
power steering / servosterzo	OM352	81	110	10/68 >	02/01				S 8790 PO
L 912	OM364A	90	122	03/88 >		S 5099 PE	S 2161 N	S 3059 A	
dryer filter / filtro essiccatore	OM364A	90	122	03/88 >					S 7259 A
L 914	OM364LA	103	140	12/94 >		S 5099 PE	S 2161 N	S 3059 A	
dryer filter / filtro essiccatore	OM364LA	103	140	12/94 >					S 7259 A
power steering / servosterzo	OM364LA	103	140	12/94 >					S 3081 PO
L 914	OM904LA	100	136	01/96 >		S 5007 PE	S 6017 NE	S 2650 A	
dryer filter / filtro essiccatore	OM904LA	100	136	01/96 >					S 7259 A
power steering / servosterzo	OM904LA	100	136	01/96 >					S 3081 PO
LA 911 B	OM352	81	110	10/68 >	12/77	S 0300 O	S 2161 N	S 1070 A	
	OM352	81	110	01/78 >	02/01	S 5124 PE	S 2161 N	S 1070 A	
power steering / servosterzo	OM352	81	110	10/68 >	02/01				S 3081 PO
power steering / servosterzo	OM352	81	110	10/68 >	02/01				S 8790 PO
LAKO 911 B	OM352	81	110	10/68 >	12/77	S 0300 O	S 2161 N	S 1070 A	
	OM352	81	110	01/78 >	02/01	S 5124 PE	S 2161 N	S 1070 A	
power steering / servosterzo	OM352	81	110	10/68 >	02/01				S 3081 PO
power steering / servosterzo	OM352	81	110	10/68 >	02/01				S 8790 PO
LP 911 B	OM353.909	81	110	01/72 >	03/77	S 0300 O	S 2161 N		
some / alcuni	OM353.909	81	110	01/72 >	03/77	S 0300 O	S 2161 N	S 1070 A	
power steering / servosterzo	OM353.909	81	110	01/72 >	03/77				S 3081 PO
power steering / servosterzo	OM353.909	81	110	01/72 >	03/77				S 8790 PO
LP 913	OM353	96	130	10/69 >	12/77	S 0300 O	S 2161 N	S 1070 A	
	OM353	96	130	01/78 >	12/84	S 5124 PE	S 2161 N	S 1070 A	
power steering / servosterzo	OM353	96	130	10/69 >	12/84				S 3081 PO
power steering / servosterzo	OM353	96	130	10/69 >	12/84				S 8790 PO
LPL 913	OM353	96	130	10/69 >	12/77	S 0300 O	S 2161 N	S 1070 A	
	OM353	96	130	01/78 >	12/84	S 5124 PE	S 2161 N	S 1070 A	
power steering / servosterzo	OM353	96	130	10/69 >	12/84				S 3081 PO
power steering / servosterzo	OM353	96	130	10/69 >	12/84				S 8790 PO
LPS 913	OM353	96	130	10/69 >	12/77	S 0300 O	S 2161 N	S 1070 A	
	OM353	96	130	01/78 >	12/84	S 5124 PE	S 2161 N	S 1070 A	
power steering / servosterzo	OM353	96	130	10/69 >	12/84				S 3081 PO
power steering / servosterzo	OM353	96	130	10/69 >	12/84				S 8790 PO
Actros I									
1831	OM501LA	230	313	09/96 >	12/03	S 5006 PE	S 6001 NE	S 7280 A	S 3072 C
some / alcuni	OM501LA	230	313	09/96 >	12/03			S 7469 A	
some / alcuni	OM501LA	230	313	09/96 >	12/03			S 7279 A	
with panel air filter / con filtro aria a pannello	OM501LA	230	313	09/96 >	12/03			S 3373 A	
with manual pump prefilter / con pompa manuale prefiltra	OM501LA	230	313	09/96 >	12/03		S 6089 NE		
dryer filter / filtro essiccatore	OM501LA	230	313	09/96 >	12/03				S 7259 A
power steering / servosterzo	OM501LA	230	313	09/96 >	12/03				S 3081 PO
1831 K/AK	OM501LA	230	313	09/96 >	12/03	S 5006 PE	S 6001 NE	S 7280 A	S 3221 C
some / alcuni	OM501LA	230	313	09/96 >	12/03			S 7469 A	
some / alcuni	OM501LA	230	313	09/96 >	12/03			S 7279 A	
with manual pump prefilter / con pompa manuale prefiltra	OM501LA	230	313	09/96 >	12/03		S 6089 NE		
dryer filter / filtro essiccatore	OM501LA	230	313	09/96 >	12/03				S 7259 A
power steering / servosterzo	OM501LA	230	313	09/96 >	12/03				S 3081 PO
1835	OM501LA	260	354	09/96 >	12/03	S 5006 PE	S 6001 NE	S 7280 A	S 3072 C
some / alcuni	OM501LA	260	354	09/96 >	12/03			S 7279 A	
some / alcuni	OM501LA	260	354	09/96 >	12/03			S 7469 A	
with panel air filter / con filtro aria a pannello	OM501LA	260	354	09/96 >	12/03			S 3373 A	
with manual pump prefilter / con pompa manuale prefiltra	OM501LA	260	354	09/96 >	12/03		S 6089 NE		
dryer filter / filtro essiccatore	OM501LA	260	354	09/96 >	12/03				S 7259 A
power steering / servosterzo	OM501LA	260	354	09/96 >	12/03				S 3081 PO
1840	OM501LA	290	394	09/96 >	12/03	S 5006 PE	S 6001 NE	S 7280 A	S 3072 C

M

**KW HP****...MERCEDES BENZ - trucks/autocarri****M**

some / alcuni	OM501LA	290	394	09/96	>	12/03			S 7469 A	
some / alcuni	OM501LA	290	394	09/96	>	12/03			S 7279 A	
with panel air filter / con filtro aria a pannello	OM501LA	290	394	09/96	>	12/03			S 3373 A	
with manual pump prefilter / con pompa manuale prefiltra	OM501LA	290	394	09/96	>	12/03		S 6089 NE		
dryer filter / filtro essiccatore	OM501LA	290	394	09/96	>	12/03				S 7259 A
power steering / servosterzo	OM501LA	290	394	09/96	>	12/03				S 3081 PO
1840 K	OM501LA/OM541LA	290	394	09/96	>	12/03	S 5006 PE	S 6001 NE	S 7280 A	S 3221 C
some / alcuni	OM501LA/OM541LA	290	394	09/96	>	12/03			S 7469 A	
some / alcuni	OM501LA/OM541LA	290	394	09/96	>	12/03			S 7279 A	
with panel air filter / con filtro aria a pannello	OM501LA/OM541LA	290	394	09/96	>	12/03			S 3373 A	
with manual pump prefilter / con pompa manuale prefiltra	OM501LA/OM541LA	290	394	09/96	>	12/03		S 6089 NE		
dryer filter / filtro essiccatore	OM501LA/OM541LA	290	394	09/96	>	12/03				S 7259 A
power steering / servosterzo	OM501LA/OM541LA	290	394	09/96	>	12/03				S 3081 PO
1843	OM501LA/OM541LA	315	428	09/96	>	12/03	S 5006 PE	S 6001 NE	S 7280 A	S 3072 C
some / alcuni	OM501LA/OM541LA	315	428	09/96	>	12/03			S 7469 A	
some / alcuni	OM501LA/OM541LA	315	428	09/96	>	12/03			S 7279 A	
with panel air filter / con filtro aria a pannello	OM501LA/OM541LA	315	428	09/96	>	12/03			S 3373 A	
with manual pump prefilter / con pompa manuale prefiltra	OM501LA/OM541LA	315	428	09/96	>	12/03		S 6089 NE		
dryer filter / filtro essiccatore	OM501LA/OM541LA	315	428	09/96	>	12/03				S 7259 A
power steering / servosterzo	OM501LA/OM541LA	315	428	09/96	>	12/03				S 3081 PO
1843 K	OM501LA/OM541LA	315	428	09/96	>	12/03	S 5006 PE	S 6001 NE	S 7280 A	S 3221 C
some / alcuni	OM501LA/OM541LA	315	428	09/96	>	12/03			S 7469 A	
some / alcuni	OM501LA/OM541LA	315	428	09/96	>	12/03			S 7279 A	
with panel air filter / con filtro aria a pannello	OM501LA/OM541LA	315	428	09/96	>	12/03			S 3373 A	
with manual pump prefilter / con pompa manuale prefiltra	OM501LA/OM541LA	315	428	09/96	>	12/03		S 6089 NE		
dryer filter / filtro essiccatore	OM501LA/OM541LA	315	428	09/96	>	12/03				S 7259 A
power steering / servosterzo	OM501LA/OM541LA	315	428	09/96	>	12/03				S 3081 PO
1846	OM501LA/OM541LA	335	456	09/01	>	12/03	S 5006 PE	S 6001 NE	S 7280 A	S 3072 C
some / alcuni	OM501LA/OM541LA	335	456	09/01	>	12/03			S 7469 A	
some / alcuni	OM501LA/OM541LA	335	456	09/01	>	12/03			S 7279 A	
with panel air filter / con filtro aria a pannello	OM501LA/OM541LA	335	456	09/01	>	12/03			S 3373 A	
with manual pump prefilter / con pompa manuale prefiltra	OM501LA/OM541LA	335	456	09/01	>	12/03		S 6089 NE		
dryer filter / filtro essiccatore	OM501LA/OM541LA	335	456	09/01	>	12/03				S 7259 A
power steering / servosterzo	OM501LA/OM541LA	335	456	09/01	>	12/03				S 3081 PO
1846 K/AK	OM501LA	335	456	09/01	>	12/03	S 5006 PE	S 6001 NE	S 7280 A	S 3221 C
some / alcuni	OM501LA	335	456	09/01	>	12/03			S 7469 A	
some / alcuni	OM501LA	335	456	09/01	>	12/03			S 7279 A	
with panel air filter / con filtro aria a pannello	OM501LA	335	456	09/01	>	12/03			S 3373 A	
with manual pump prefilter / con pompa manuale prefiltra	OM501LA	335	456	09/01	>	12/03		S 6089 NE		
dryer filter / filtro essiccatore	OM501LA	335	456	09/01	>	12/03				S 7259 A
power steering / servosterzo	OM501LA	335	456	09/01	>	12/03				S 3081 PO
1848	OM502LA	350	476	09/96	>	12/03	S 5006 PE	S 6001 NE	S 7279 A	S 3072 C
some 2 filters / alcuni N.2 filtri	OM502LA	350	476	09/96	>	12/03			S 0450 A	
with manual pump prefilter / con pompa manuale prefiltra	OM502LA	350	476	09/96	>	12/03		S 6089 NE		
dryer filter / filtro essiccatore	OM502LA	350	476	09/96	>	12/03				S 7259 A
power steering / servosterzo	OM502LA	350	476	09/96	>	12/03				S 3081 PO
1853	OM502LA/OM542LA	390	530	09/96	>	12/03	S 5006 PE	S 6001 NE	S 7279 A	S 3072 C
some 2 filters / alcuni N.2 filtri	OM502LA/OM542LA	390	530	09/96	>	12/03			S 0450 A	
with manual pump prefilter / con pompa manuale prefiltra	OM502LA/OM542LA	390	530	09/96	>	12/03		S 6089 NE		
dryer filter / filtro essiccatore	OM502LA/OM542LA	390	530	09/96	>	12/03				S 7259 A
power steering / servosterzo	OM502LA/OM542LA	390	530	09/96	>	12/03				S 3081 PO
1857	OM502LA/OM542LA	420	571	09/96	>	12/03	S 5006 PE	S 6001 NE	S 7279 A	S 3072 C
some 2 filters / alcuni N.2 filtri	OM502LA/OM542LA	420	571	09/96	>	12/03			S 0450 A	
with manual pump prefilter / con pompa manuale prefiltra	OM502LA/OM542LA	420	571	09/96	>	12/03		S 6089 NE		
dryer filter / filtro essiccatore	OM502LA/OM542LA	420	571	09/96	>	12/03				S 7259 A
power steering / servosterzo	OM502LA/OM542LA	420	571	09/96	>	12/03				S 3081 PO
1943	OM501LA	315	428	01/97	>	12/03	S 5006 PE	S 6001 NE	S 7280 A	S 3072 C
some / alcuni	OM501LA	315	428	01/97	>	12/03			S 7469 A	
some / alcuni	OM501LA	315	428	01/97	>	12/03			S 7279 A	
with panel air filter / con filtro aria a pannello	OM501LA	315	428	01/97	>	12/03			S 3373 A	
with manual pump prefilter / con pompa manuale prefiltra	OM501LA	315	428	01/97	>	12/03		S 6089 NE		
dryer filter / filtro essiccatore	OM501LA	315	428	01/97	>	12/03				S 7259 A
power steering / servosterzo	OM501LA	315	428	01/97	>	12/03				S 3081 PO
2031	OM501LA	230	313	11/97	>	12/03	S 5006 PE	S 6001 NE	S 7280 A	S 3072 C
some / alcuni	OM501LA	230	313	11/97	>	12/03			S 7469 A	
some / alcuni	OM501LA	230	313	11/97	>	12/03			S 7279 A	
with panel air filter / con filtro aria a pannello	OM501LA	230	313	11/97	>	12/03			S 3373 A	

**KW HP****...MERCEDES BENZ - trucks/autocarri**

with manual pump prefilter / con pompa manuale prefiltro	OM501LA	230	313	11/97	>	12/03		S 6089 NE		S 7259 A
dryer filter / filtro essiccatore	OM501LA	230	313	11/97	>	12/03				S 3081 PO
power steering / servosterzo	OM501LA	230	313	11/97	>	12/03				S 3221 C
2031 K/AK	OM501LA	230	313	11/97	>	12/03	S 5006 PE	S 6001 NE	S 7280 A	S 3221 C
some / alcuni	OM501LA	230	313	11/97	>	12/03			S 7469 A	
some / alcuni	OM501LA	230	313	11/97	>	12/03			S 7279 A	
with panel air filter / con filtro aria a pannello	OM501LA	230	313	11/97	>	12/03			S 3373 A	
with manual pump prefilter / con pompa manuale prefiltro	OM501LA	230	313	11/97	>	12/03		S 6089 NE		
dryer filter / filtro essiccatore	OM501LA	230	313	11/97	>	12/03				S 7259 A
power steering / servosterzo	OM501LA	230	313	11/97	>	12/03				S 3081 PO
2035 A	OM501LA	260	354	04/97	>	12/03	S 5006 PE	S 6001 NE	S 7280 A	S 3072 C
some / alcuni	OM501LA	260	354	04/97	>	12/03			S 7469 A	
some / alcuni	OM501LA	260	354	04/97	>	12/03			S 7279 A	
with panel air filter / con filtro aria a pannello	OM501LA	260	354	04/97	>	12/03			S 3373 A	
with manual pump prefilter / con pompa manuale prefiltro	OM501LA	260	354	04/97	>	12/03		S 6089 NE		
dryer filter / filtro essiccatore	OM501LA	260	354	04/97	>	12/03				S 7259 A
power steering / servosterzo	OM501LA	260	354	04/97	>	12/03				S 3081 PO
2038	OM501LA/OM541LA	279	380	09/96	>	12/03	S 5006 PE	S 6001 NE	S 7280 A	S 3072 C
some / alcuni	OM501LA/OM541LA	279	380	09/96	>	12/03			S 7469 A	
some / alcuni	OM501LA/OM541LA	279	380	09/96	>	12/03			S 7279 A	
with panel air filter / con filtro aria a pannello	OM501LA/OM541LA	279	380	09/96	>	12/03			S 3373 A	
with manual pump prefilter / con pompa manuale prefiltro	OM501LA/OM541LA	279	380	09/96	>	12/03		S 6089 NE		
dryer filter / filtro essiccatore	OM501LA/OM541LA	279	380	09/96	>	12/03				S 7259 A
power steering / servosterzo	OM501LA/OM541LA	279	380	09/96	>	12/03				S 3081 PO
2040	OM501LA	290	394	11/97	>	12/03	S 5006 PE	S 6001 NE	S 7280 A	S 3072 C
some / alcuni	OM501LA	290	394	11/97	>	12/03			S 7469 A	
some / alcuni	OM501LA	290	394	11/97	>	12/03			S 7279 A	
with panel air filter / con filtro aria a pannello	OM501LA	290	394	11/97	>	12/03			S 3373 A	
with manual pump prefilter / con pompa manuale prefiltro	OM501LA	290	394	11/97	>	12/03		S 6089 NE		
dryer filter / filtro essiccatore	OM501LA	290	394	11/97	>	12/03				S 7259 A
power steering / servosterzo	OM501LA	290	394	11/97	>	12/03				S 3081 PO
2040 AS	OM501LA	290	394	11/97	>	12/03	S 5006 PE	S 6001 NE	S 7280 A	S 3072 C
some / alcuni	OM501LA	290	394	11/97	>	12/03			S 7469 A	
some / alcuni	OM501LA	290	394	11/97	>	12/03			S 7279 A	
with panel air filter / con filtro aria a pannello	OM501LA	290	394	11/97	>	12/03			S 3373 A	
with manual pump prefilter / con pompa manuale prefiltro	OM501LA	290	394	11/97	>	12/03		S 6089 NE		
dryer filter / filtro essiccatore	OM501LA	290	394	11/97	>	12/03				S 7259 A
power steering / servosterzo	OM501LA	290	394	11/97	>	12/03				S 3081 PO
2040 K	OM501LA	290	394	11/97	>	12/03	S 5006 PE	S 6001 NE	S 7280 A	S 3221 C
some / alcuni	OM501LA	290	394	11/97	>	12/03			S 7469 A	
some / alcuni	OM501LA	290	394	11/97	>	12/03			S 7279 A	
with panel air filter / con filtro aria a pannello	OM501LA	290	394	11/97	>	12/03			S 3373 A	
with manual pump prefilter / con pompa manuale prefiltro	OM501LA	290	394	11/97	>	12/03		S 6089 NE		
dryer filter / filtro essiccatore	OM501LA	290	394	11/97	>	12/03				S 7259 A
power steering / servosterzo	OM501LA	290	394	11/97	>	12/03				S 3081 PO
2043	OM501LA	315	428	09/98	>	12/03	S 5006 PE	S 6001 NE	S 7280 A	S 3072 C
some / alcuni	OM501LA	315	428	09/98	>	12/03			S 7469 A	
some / alcuni	OM501LA	315	428	09/98	>	12/03			S 7279 A	
with panel air filter / con filtro aria a pannello	OM501LA	315	428	09/98	>	12/03			S 3373 A	
with manual pump prefilter / con pompa manuale prefiltro	OM501LA	315	428	09/98	>	12/03		S 6089 NE		
dryer filter / filtro essiccatore	OM501LA	315	428	09/98	>	12/03				S 7259 A
power steering / servosterzo	OM501LA	315	428	09/98	>	12/03				S 3081 PO
2046	OM501LA	335	456	09/01	>	12/03	S 5006 PE	S 6001 NE	S 7280 A	S 3072 C
some / alcuni	OM501LA	335	456	09/01	>	12/03			S 7469 A	
some / alcuni	OM501LA	335	456	09/01	>	12/03			S 7279 A	
with panel air filter / con filtro aria a pannello	OM501LA	335	456	09/01	>	12/03			S 3373 A	
with manual pump prefilter / con pompa manuale prefiltro	OM501LA	335	456	09/01	>	12/03		S 6089 NE		
dryer filter / filtro essiccatore	OM501LA	335	456	09/01	>	12/03				S 7259 A
power steering / servosterzo	OM501LA	335	456	09/01	>	12/03				S 3081 PO
2053 S	OM502LA	390	530	04/96	>	12/03	S 5006 PE	S 6001 NE	S 7279 A	S 3072 C
some 2 filters / alcuni N.2 filtri	OM502LA	390	530	04/96	>	12/03			S 0450 A	
with manual pump prefilter / con pompa manuale prefiltro	OM502LA	390	530	04/96	>	12/03		S 6089 NE		
dryer filter / filtro essiccatore	OM502LA	390	530	04/96	>	12/03				S 7259 A
power steering / servosterzo	OM502LA	390	530	04/96	>	12/03				S 3081 PO
2531	OM501LA	230	313	09/96	>	12/03	S 5006 PE	S 6001 NE	S 7280 A	S 3072 C
some / alcuni	OM501LA	230	313	09/96	>	12/03			S 7279 A	
some / alcuni	OM501LA	230	313	09/96	>	12/03			S 7469 A	

M

**KW HP****...MERCEDES BENZ - trucks/autocarri****M**

with panel air filter / con filtro aria a pannello	OM501LA	230	313	09/96	>	12/03			S 3373 A	
with manual pump prefilter / con pompa manuale prefiltrato	OM501LA	230	313	09/96	>	12/03		S 6089 NE		
dryer filter / filtro essiccatore	OM501LA	230	313	09/96	>	12/03				S 7259 A
power steering / servosterzo	OM501LA	230	313	09/96	>	12/03				S 3081 PO
2535	OM501LA	260	354	09/96	>	12/03	S 5006 PE	S 6001 NE	S 7280 A	S 3072 C
some / alcuni	OM501LA	260	354	09/96	>	12/03			S 7279 A	
some / alcuni	OM501LA	260	354	09/96	>	12/03			S 7469 A	
with panel air filter / con filtro aria a pannello	OM501LA	260	354	09/96	>	12/03			S 3373 A	
with manual pump prefilter / con pompa manuale prefiltrato	OM501LA	260	354	09/96	>	12/03		S 6089 NE		
dryer filter / filtro essiccatore	OM501LA	260	354	09/96	>	12/03				S 7259 A
power steering / servosterzo	OM501LA	260	354	09/96	>	12/03				S 3081 PO
2540	OM501LA	290	394	09/96	>	12/03	S 5006 PE	S 6001 NE	S 7280 A	S 3072 C
some / alcuni	OM501LA	290	394	09/96	>	12/03			S 7279 A	
some / alcuni	OM501LA	290	394	09/96	>	12/03			S 7469 A	
with panel air filter / con filtro aria a pannello	OM501LA	290	394	09/96	>	12/03			S 3373 A	
with manual pump prefilter / con pompa manuale prefiltrato	OM501LA	290	394	09/96	>	12/03		S 6089 NE		
dryer filter / filtro essiccatore	OM501LA	290	394	09/96	>	12/03				S 7259 A
power steering / servosterzo	OM501LA	290	394	09/96	>	12/03				S 3081 PO
2543	OM501LA	315	428	09/96	>	12/03	S 5006 PE	S 6001 NE	S 7280 A	S 3072 C
some / alcuni	OM501LA	315	428	09/96	>	12/03			S 7469 A	
some / alcuni	OM501LA	315	428	09/96	>	12/03			S 7279 A	
with panel air filter / con filtro aria a pannello	OM501LA	315	428	09/96	>	12/03			S 3373 A	
with manual pump prefilter / con pompa manuale prefiltrato	OM501LA	315	428	09/96	>	12/03		S 6089 NE		
dryer filter / filtro essiccatore	OM501LA	315	428	09/96	>	12/03				S 7259 A
power steering / servosterzo	OM501LA	315	428	09/96	>	12/03				S 3081 PO
2546	OM501LA	335	456	09/96	>	12/03	S 5006 PE	S 6001 NE	S 7280 A	S 3072 C
some / alcuni	OM501LA	335	456	09/96	>	12/03	S 5006 PE	S 6001 NE	S 7279 A	S 3072 C
with panel air filter / con filtro aria a pannello	OM501LA	335	456	09/96	>	12/03			S 3373 A	
with manual pump prefilter / con pompa manuale prefiltrato	OM501LA	335	456	09/96	>	12/03		S 6089 NE		
dryer filter / filtro essiccatore	OM501LA	335	456	09/96	>	12/03				S 7259 A
power steering / servosterzo	OM501LA	335	456	09/96	>	12/03				S 3081 PO
2548	OM502LA	350	476	09/96	>	12/03	S 5006 PE	S 6001 NE	S 7279 A	S 3072 C
some 2 filters / alcuni N.2 filtri	OM502LA	350	476	09/96	>	12/03			S 0450 A	
with manual pump prefilter / con pompa manuale prefiltrato	OM502LA	350	476	09/96	>	12/03		S 6089 NE		
dryer filter / filtro essiccatore	OM502LA	350	476	09/96	>	12/03				S 7259 A
power steering / servosterzo	OM502LA	350	476	09/96	>	12/03				S 3081 PO
2553	OM502LA	390	530	09/96	>	12/03	S 5006 PE	S 6001 NE	S 7279 A	S 3072 C
some 2 filters / alcuni N.2 filtri	OM502LA	390	530	09/96	>	12/03			S 0450 A	
with manual pump prefilter / con pompa manuale prefiltrato	OM502LA	390	530	09/96	>	12/03		S 6089 NE		
dryer filter / filtro essiccatore	OM502LA	390	530	09/96	>	12/03				S 7259 A
power steering / servosterzo	OM502LA	390	530	09/96	>	12/03				S 3081 PO
2557	OM502LA	420	571	09/96	>	12/03	S 5006 PE	S 6001 NE	S 7279 A	S 3072 C
some 2 filters / alcuni N.2 filtri	OM502LA	420	571	09/96	>	12/03			S 0450 A	
with manual pump prefilter / con pompa manuale prefiltrato	OM502LA	420	571	09/96	>	12/03		S 6089 NE		
dryer filter / filtro essiccatore	OM502LA	420	571	09/96	>	12/03				S 7259 A
power steering / servosterzo	OM502LA	420	571	09/96	>	12/03				S 3081 PO
2631	OM501LA	230	313	09/96	>	12/03	S 5006 PE	S 6001 NE		S 3072 C
some / alcuni	OM501LA	230	313	09/96	>	12/03	S 5006 PE	S 6001 NE	S 7280 A	S 3072 C
some / alcuni	OM501LA	230	313	09/96	>	12/03	S 5006 PE	S 6001 NE	S 7279 A	S 3072 C
with panel air filter / con filtro aria a pannello	OM501LA	230	313	09/96	>	12/03			S 3373 A	
with manual pump prefilter / con pompa manuale prefiltrato	OM501LA	230	313	09/96	>	12/03		S 6089 NE		
dryer filter / filtro essiccatore	OM501LA	230	313	09/96	>	12/03				S 7259 A
power steering / servosterzo	OM501LA	230	313	09/96	>	12/03				S 3081 PO
2635	OM501LA	260	354	09/96	>	12/03	S 5006 PE	S 6001 NE		S 3072 C
some / alcuni	OM501LA	260	354	09/96	>	12/03	S 5006 PE	S 6001 NE	S 7280 A	S 3072 C
some / alcuni	OM501LA	260	354	09/96	>	12/03	S 5006 PE	S 6001 NE	S 7279 A	S 3072 C
with panel air filter / con filtro aria a pannello	OM501LA	260	354	09/96	>	12/03			S 3373 A	
with manual pump prefilter / con pompa manuale prefiltrato	OM501LA	260	354	09/96	>	12/03		S 6089 NE		
dryer filter / filtro essiccatore	OM501LA	260	354	09/96	>	12/03				S 7259 A
power steering / servosterzo	OM501LA	260	354	09/96	>	12/03				S 3081 PO
2640	OM501LA	290	394	09/96	>	12/03	S 5006 PE	S 6001 NE	S 7280 A	S 3072 C
some / alcuni	OM501LA	290	394	09/96	>	12/03	S 5006 PE	S 6001 NE	S 7279 A	S 3072 C
with panel air filter / con filtro aria a pannello	OM501LA	290	394	09/96	>	12/03			S 3373 A	
with manual pump prefilter / con pompa manuale prefiltrato	OM501LA	290	394	09/96	>	12/03		S 6089 NE		
dryer filter / filtro essiccatore	OM501LA	290	394	09/96	>	12/03				S 7259 A

**KW HP****...MERCEDES BENZ - trucks/autocarri**

power steering / servosterzo	OM501LA	290	394	09/96	>	12/03				S 3081 PO
2643										
some / alcuni	OM501LA	315	428	09/96	>	12/03	S 5006 PE	S 6001 NE	S 7280 A	S 3072 C
some / alcuni	OM501LA	315	428	09/96	>	12/03	S 5006 PE	S 6001 NE	S 7279 A	S 3072 C
with panel air filter / con filtro aria a pannello	OM501LA	315	428	09/96	>	12/03			S 3373 A	
with manual pump prefilter / con pompa manuale prefiltra	OM501LA	315	428	09/96	>	12/03		S 6089 NE		
dryer filter / filtro essiccatore	OM501LA	315	428	09/96	>	12/03				S 7259 A
power steering / servosterzo	OM501LA	315	428	09/96	>	12/03				S 3081 PO
2646										
some / alcuni	OM501LA	335	456	09/01	>	12/03	S 5006 PE	S 6001 NE	S 7280 A	S 3072 C
some / alcuni	OM501LA	335	456	09/01	>	12/03	S 5006 PE	S 6001 NE	S 7279 A	S 3072 C
with panel air filter / con filtro aria a pannello	OM501LA	335	456	09/01	>	12/03			S 3373 A	
with manual pump prefilter / con pompa manuale prefiltra	OM501LA	335	456	09/01	>	12/03		S 6089 NE		
dryer filter / filtro essiccatore	OM501LA	335	456	09/01	>	12/03				S 7259 A
power steering / servosterzo	OM501LA	335	456	09/01	>	12/03				S 3081 PO
2648										
some / alcuni	OM502LA	350	476	09/96	>	12/03	S 5006 PE	S 6001 NE	S 7279 A	S 3072 C
some 2 filters / alcuni N.2 filtri	OM502LA	350	476	09/96	>	12/03			S 0450 A	
with manual pump prefilter / con pompa manuale prefiltra	OM502LA	350	476	09/96	>	12/03		S 6089 NE		
dryer filter / filtro essiccatore	OM502LA	350	476	09/96	>	12/03				S 7259 A
power steering / servosterzo	OM502LA	350	476	09/96	>	12/03				S 3081 PO
2653										
some 2 filters / alcuni N.2 filtri	OM502LA	390	530	09/96	>	12/03	S 5006 PE	S 6001 NE	S 7279 A	S 3072 C
with manual pump prefilter / con pompa manuale prefiltra	OM502LA	390	530	09/96	>	12/03		S 6089 NE	S 0450 A	
dryer filter / filtro essiccatore	OM502LA	390	530	09/96	>	12/03				S 7259 A
power steering / servosterzo	OM502LA	390	530	09/96	>	12/03				S 3081 PO
2657										
some 2 filters / alcuni N.2 filtri	OM502LA	420	571	09/96	>	12/03	S 5006 PE	S 6001 NE	S 7279 A	S 3072 C
with manual pump prefilter / con pompa manuale prefiltra	OM502LA	420	571	09/96	>	12/03		S 6089 NE	S 0450 A	
dryer filter / filtro essiccatore	OM502LA	420	571	09/96	>	12/03				S 7259 A
power steering / servosterzo	OM502LA	420	571	09/96	>	12/03				S 3081 PO
2831										
some / alcuni	OM501LA	230	313	09/96	>	12/03	S 5006 PE	S 6001 NE	S 7280 A	S 3072 C
some / alcuni	OM501LA	230	313	09/96	>	12/03	S 5006 PE	S 6001 NE	S 7279 A	S 3072 C
with panel air filter / con filtro aria a pannello	OM501LA	230	313	09/96	>	12/03			S 3373 A	
with manual pump prefilter / con pompa manuale prefiltra	OM501LA	230	313	09/96	>	12/03		S 6089 NE		
dryer filter / filtro essiccatore	OM501LA	230	313	09/96	>	12/03				S 7259 A
power steering / servosterzo	OM501LA	230	313	09/96	>	12/03				S 3081 PO
3231										
some / alcuni	OM501LA	230	313	09/96	>	12/03	S 5006 PE	S 6001 NE	S 7280 A	S 3072 C
some / alcuni	OM501LA	230	313	09/96	>	12/03	S 5006 PE	S 6001 NE	S 7279 A	S 3072 C
with panel air filter / con filtro aria a pannello	OM501LA	230	313	09/96	>	12/03			S 3373 A	
with manual pump prefilter / con pompa manuale prefiltra	OM501LA	230	313	09/96	>	12/03		S 6089 NE		
dryer filter / filtro essiccatore	OM501LA	230	313	09/96	>	12/03				S 7259 A
power steering / servosterzo	OM501LA	230	313	09/96	>	12/03				S 3081 PO
3235										
some / alcuni	OM501LA	260	354	09/96	>	12/03	S 5006 PE	S 6001 NE	S 7280 A	S 3072 C
some / alcuni	OM501LA	260	354	09/96	>	12/03	S 5006 PE	S 6001 NE	S 7279 A	S 3072 C
with panel air filter / con filtro aria a pannello	OM501LA	260	354	09/96	>	12/03			S 3373 A	
with manual pump prefilter / con pompa manuale prefiltra	OM501LA	260	354	09/96	>	12/03		S 6089 NE		
dryer filter / filtro essiccatore	OM501LA	260	354	09/96	>	12/03				S 7259 A
power steering / servosterzo	OM501LA	260	354	09/96	>	12/03				S 3081 PO
3240										
some / alcuni	OM501LA	290	394	09/96	>	12/03	S 5006 PE	S 6001 NE	S 7280 A	S 3072 C
some / alcuni	OM501LA	290	394	09/96	>	12/03	S 5006 PE	S 6001 NE	S 7279 A	S 3072 C
with panel air filter / con filtro aria a pannello	OM501LA	290	394	09/96	>	12/03			S 3373 A	
with manual pump prefilter / con pompa manuale prefiltra	OM501LA	290	394	09/96	>	12/03		S 6089 NE		
dryer filter / filtro essiccatore	OM501LA	290	394	09/96	>	12/03				S 7259 A
power steering / servosterzo	OM501LA	290	394	09/96	>	12/03				S 3081 PO
3243										
some / alcuni	OM501LA	315	428	09/96	>	12/03	S 5006 PE	S 6001 NE	S 7280 A	S 3072 C
some / alcuni	OM501LA	315	428	09/96	>	12/03	S 5006 PE	S 6001 NE	S 7279 A	S 3072 C
with panel air filter / con filtro aria a pannello	OM501LA	315	428	09/96	>	12/03			S 3373 A	
with manual pump prefilter / con pompa manuale prefiltra	OM501LA	315	428	09/96	>	12/03		S 6089 NE		
dryer filter / filtro essiccatore	OM501LA	315	428	09/96	>	12/03				S 7259 A
power steering / servosterzo	OM501LA	315	428	09/96	>	12/03				S 3081 PO
3246										

M

**KW HP****...MERCEDES BENZ - trucks/autocarri**

dryer filter / filtro essiccatore	OM501LA	290	394	09/96	>	12/03				S 7259 A
power steering / servosterzo	OM501LA	290	394	09/96	>	12/03				S 3081 PO
3343	OM501LA	315	428	09/96	>	12/03	S 5006 PE	S 6001 NE	S 7280 A	S 3072 C
some / alcuni	OM501LA	315	428	09/96	>	12/03			S 7469 A	
some / alcuni	OM501LA	315	428	09/96	>	12/03			S 7279 A	
with panel air filter / con filtro aria a pannello	OM501LA	315	428	09/96	>	12/03			S 3373 A	
with manual pump prefilter / con pompa manuale prefiltra	OM501LA	315	428	09/96	>	12/03		S 6089 NE		
dryer filter / filtro essiccatore	OM501LA	315	428	09/96	>	12/03				S 7259 A
power steering / servosterzo	OM501LA	315	428	09/96	>	12/03				S 3081 PO
3343 K	OM501LA	315	428	09/96	>	12/03	S 5006 PE	S 6001 NE	S 7280 A	S 3221 C
some / alcuni	OM501LA	315	428	09/96	>	12/03			S 7469 A	
some / alcuni	OM501LA	315	428	09/96	>	12/03			S 7279 A	
with panel air filter / con filtro aria a pannello	OM501LA	315	428	09/96	>	12/03			S 3373 A	
with manual pump prefilter / con pompa manuale prefiltra	OM501LA	315	428	09/96	>	12/03		S 6089 NE		
dryer filter / filtro essiccatore	OM501LA	315	428	09/96	>	12/03				S 7259 A
power steering / servosterzo	OM501LA	315	428	09/96	>	12/03				S 3081 PO
3343 S	OM501LA	315	428	09/96	>	12/03	S 5006 PE	S 6001 NE	S 7280 A	S 3072 C
some / alcuni	OM501LA	315	428	09/96	>	12/03			S 7469 A	
some / alcuni	OM501LA	315	428	09/96	>	12/03	S 5006 PE	S 6001 NE	S 7279 A	
with panel air filter / con filtro aria a pannello	OM501LA	315	428	09/96	>	12/03			S 3373 A	
with manual pump prefilter / con pompa manuale prefiltra	OM501LA	315	428	09/96	>	12/03		S 6089 NE		
dryer filter / filtro essiccatore	OM501LA	315	428	09/96	>	12/03				S 7259 A
power steering / servosterzo	OM501LA	315	428	09/96	>	12/03				S 3081 PO
3346	OM501LA	335	456	09/01	>	12/03	S 5006 PE	S 6001 NE	S 7280 A	S 3072 C
some / alcuni	OM501LA	335	456	09/01	>	12/03			S 7469 A	
some / alcuni	OM501LA	335	456	09/01	>	12/03			S 7279 A	
with panel air filter / con filtro aria a pannello	OM501LA	335	456	09/01	>	12/03			S 3373 A	
with manual pump prefilter / con pompa manuale prefiltra	OM501LA	335	456	09/01	>	12/03		S 6089 NE		
dryer filter / filtro essiccatore	OM501LA	335	456	09/01	>	12/03				S 7259 A
power steering / servosterzo	OM501LA	335	456	09/01	>	12/03				S 3081 PO
3346 K	OM501LA	335	456	09/01	>	12/03	S 5006 PE	S 6001 NE	S 7280 A	S 3221 C
some / alcuni	OM501LA	335	456	09/01	>	12/03			S 7469 A	
some / alcuni	OM501LA	335	456	09/01	>	12/03			S 7279 A	
with panel air filter / con filtro aria a pannello	OM501LA	335	456	09/01	>	12/03			S 3373 A	
with manual pump prefilter / con pompa manuale prefiltra	OM501LA	335	456	09/01	>	12/03		S 6089 NE		
dryer filter / filtro essiccatore	OM501LA	335	456	09/01	>	12/03				S 7259 A
power steering / servosterzo	OM501LA	335	456	09/01	>	12/03				S 3081 PO
3346 S	OM501LA	335	456	09/01	>	12/03	S 5006 PE	S 6001 NE	S 7280 A	S 3072 C
some / alcuni	OM501LA	335	456	09/01	>	12/03			S 7469 A	
some / alcuni	OM501LA	335	456	09/01	>	12/03			S 7279 A	
with panel air filter / con filtro aria a pannello	OM501LA	335	456	09/01	>	12/03			S 3373 A	
with manual pump prefilter / con pompa manuale prefiltra	OM501LA	335	456	09/01	>	12/03		S 6089 NE		
dryer filter / filtro essiccatore	OM501LA	335	456	09/01	>	12/03				S 7259 A
power steering / servosterzo	OM501LA	335	456	09/01	>	12/03				S 3081 PO
3348	OM502LA	350	476	09/96	>	12/03	S 5006 PE	S 6001 NE	S 7279 A	S 3072 C
some 2 filters / alcuni N.2 filtri	OM502LA	350	476	09/96	>	12/03			S 0450 A	
with manual pump prefilter / con pompa manuale prefiltra	OM502LA	350	476	09/96	>	12/03		S 6089 NE		
dryer filter / filtro essiccatore	OM502LA	350	476	09/96	>	12/03				S 7259 A
power steering / servosterzo	OM502LA	350	476	09/96	>	12/03				S 3081 PO
3348 K/AK	OM502LA	350	476	09/96	>	12/03	S 5006 PE	S 6001 NE	S 7279 A	S 3221 C
some 2 filters / alcuni N.2 filtri	OM502LA	350	476	09/96	>	12/03			S 0450 A	
with manual pump prefilter / con pompa manuale prefiltra	OM502LA	350	476	09/96	>	12/03		S 6089 NE		
dryer filter / filtro essiccatore	OM502LA	350	476	09/96	>	12/03				S 7259 A
power steering / servosterzo	OM502LA	350	476	09/96	>	12/03				S 3081 PO
3348 S	OM502LA	350	476	09/96	>	12/03	S 5006 PE	S 6001 NE	S 7279 A	S 3072 C
some 2 filters / alcuni N.2 filtri	OM502LA	350	476	09/96	>	12/03			S 0450 A	
with manual pump prefilter / con pompa manuale prefiltra	OM502LA	350	476	09/96	>	12/03		S 6089 NE		
dryer filter / filtro essiccatore	OM502LA	350	476	09/96	>	12/03				S 7259 A
power steering / servosterzo	OM502LA	350	476	09/96	>	12/03				S 3081 PO
3353	OM502LA	390	530	09/96	>	12/03	S 5006 PE	S 6001 NE	S 7279 A	S 3072 C
some 2 filters / alcuni N.2 filtri	OM502LA	390	530	09/96	>	12/03			S 0450 A	
with manual pump prefilter / con pompa manuale prefiltra	OM502LA	390	530	09/96	>	12/03		S 6089 NE		
dryer filter / filtro essiccatore	OM502LA	390	530	09/96	>	12/03				S 7259 A
power steering / servosterzo	OM502LA	390	530	09/96	>	12/03				S 3081 PO
3357	OM502LA	420	571	09/96	>	12/03	S 5006 PE	S 6001 NE	S 7279 A	S 3072 C
some 2 filters / alcuni N.2 filtri	OM502LA	420	571	09/96	>	12/03			S 0450 A	
with manual pump prefilter / con pompa manuale prefiltra	OM502LA	420	571	09/96	>	12/03		S 6089 NE		

M

**KW HP****...MERCEDES BENZ - trucks/autocarri****M**

dryer filter / filtro essiccatore	OM502LA	420	571	09/96	>	12/03				S 7259 A
power steering / servosterzo	OM502LA	420	571	09/96	>	12/03				S 3081 PO
4140	OM501LA	290	394	09/96	>	12/03	S 5006 PE	S 6001 NE	S 7280 A	S 3072 C
some / alcuni	OM501LA	290	394	09/96	>	12/03			S 7469 A	
some / alcuni	OM501LA	290	394	09/96	>	12/03			S 7279 A	
with panel air filter / con filtro aria a pannello	OM501LA	290	394	09/96	>	12/03			S 3373 A	
with manual pump prefilter / con pompa manuale prefiltrato	OM501LA	290	394	09/96	>	12/03		S 6089 NE		
dryer filter / filtro essiccatore	OM501LA	290	394	09/96	>	12/03				S 7259 A
power steering / servosterzo	OM501LA	290	394	09/96	>	12/03				S 3081 PO
4140 B	OM501LA	290	394	09/96	>	12/03	S 3081 PO	S 6001 NE	S 7280 A	S 3072 C
some / alcuni	OM501LA	290	394	09/96	>	12/03			S 7469 A	
some / alcuni	OM501LA	290	394	09/96	>	12/03			S 7279 A	
with panel air filter / con filtro aria a pannello	OM501LA	290	394	09/96	>	12/03			S 3373 A	
with manual pump prefilter / con pompa manuale prefiltrato	OM501LA	290	394	09/96	>	12/03		S 6089 NE		
dryer filter / filtro essiccatore	OM501LA	290	394	09/96	>	12/03				S 7259 A
power steering / servosterzo	OM501LA	290	394	09/96	>	12/03				S 3081 PO
4140 K	OM501LA	290	394	09/96	>	12/03	S 5006 PE	S 6001 NE	S 7280 A	S 3221 C
some / alcuni	OM501LA	290	394	09/96	>	12/03			S 7469 A	
some / alcuni	OM501LA	290	394	09/96	>	12/03			S 7279 A	
some 2 filters / alcuni N.2 filtri	OM501LA	290	394	09/96	>	12/03			S 0450 A	
with panel air filter / con filtro aria a pannello	OM501LA	290	394	09/96	>	12/03			S 3373 A	
with manual pump prefilter / con pompa manuale prefiltrato	OM501LA	290	394	09/96	>	12/03		S 6089 NE		
dryer filter / filtro essiccatore	OM501LA	290	394	09/96	>	12/03				S 7259 A
power steering / servosterzo	OM501LA	290	394	09/96	>	12/03				S 3081 PO
4143 K/AK	OM501LA	315	428	09/97	>	12/03	S 5006 PE	S 6001 NE	S 7280 A	S 3221 C
some / alcuni	OM501LA	315	428	09/97	>	12/03			S 7469 A	
some / alcuni	OM501LA	315	428	09/97	>	12/03			S 7279 A	
some 2 filters / alcuni N.2 filtri	OM501LA	315	428	09/97	>	12/03			S 0450 A	
with panel air filter / con filtro aria a pannello	OM501LA	315	428	09/97	>	12/03			S 3373 A	
with manual pump prefilter / con pompa manuale prefiltrato	OM501LA	315	428	09/97	>	12/03		S 6089 NE		
dryer filter / filtro essiccatore	OM501LA	315	428	09/97	>	12/03				S 7259 A
power steering / servosterzo	OM501LA	315	428	09/97	>	12/03				S 3081 PO
4146	OM501LA	335	456	09/01	>	12/03	S 5006 PE	S 6001 NE	S 7280 A	S 3072 C
some / alcuni	OM501LA	335	456	09/01	>	12/03			S 7469 A	
some / alcuni	OM501LA	335	456	09/01	>	12/03			S 7279 A	
with panel air filter / con filtro aria a pannello	OM501LA	335	456	09/01	>	12/03			S 3373 A	
with manual pump prefilter / con pompa manuale prefiltrato	OM501LA	335	456	09/01	>	12/03		S 6089 NE		
dryer filter / filtro essiccatore	OM501LA	335	456	09/01	>	12/03				S 7259 A
power steering / servosterzo	OM501LA	335	456	09/01	>	12/03				S 3081 PO
4146 K/AK	OM501LA	335	456	09/01	>	12/03	S 5006 PE	S 6001 NE	S 7280 A	S 3221 C
some / alcuni	OM501LA	335	456	09/01	>	12/03			S 7469 A	
some / alcuni	OM501LA	335	456	09/01	>	12/03			S 7279 A	
some 2 filters / alcuni N.2 filtri	OM501LA	335	456	09/01	>	12/03			S 0450 A	
with panel air filter / con filtro aria a pannello	OM501LA	335	456	09/01	>	12/03			S 3373 A	
with manual pump prefilter / con pompa manuale prefiltrato	OM501LA	335	456	09/01	>	12/03		S 6089 NE		
dryer filter / filtro essiccatore	OM501LA	335	456	09/01	>	12/03				S 7259 A
power steering / servosterzo	OM501LA	335	456	09/01	>	12/03				S 3081 PO
4148	OM502LA	350	476	04/97	>	12/03	S 5006 PE	S 6001 NE	S 7279 A	S 3072 C
some 2 filters / alcuni N.2 filtri	OM502LA	350	476	04/97	>	12/03			S 0450 A	
with manual pump prefilter / con pompa manuale prefiltrato	OM502LA	350	476	04/97	>	12/03		S 6089 NE		
dryer filter / filtro essiccatore	OM502LA	350	476	04/97	>	12/03				S 7259 A
power steering / servosterzo	OM502LA	350	476	04/97	>	12/03				S 3081 PO
4148 K/AK	OM502LA	350	476	04/97	>	12/03	S 5006 PE	S 6001 NE	S 7279 A	S 3221 C
some 2 filters / alcuni N.2 filtri	OM502LA	350	476	04/97	>	12/03			S 0450 A	
with manual pump prefilter / con pompa manuale prefiltrato	OM502LA	350	476	04/97	>	12/03		S 6089 NE		
dryer filter / filtro essiccatore	OM502LA	350	476	04/97	>	12/03				S 7259 A
power steering / servosterzo	OM502LA	350	476	04/97	>	12/03				S 3081 PO
Actros II MP2										
1832	OM501LA	235	320	04/03	>	12/08	S 5006 PE	S 6001 NE	S 7639 A	S 3072 C
with activated carbon air-conditioner / con climatizzatore, ai carboni attivi	OM501LA	235	320	04/03	>	12/08				S 4225 CA
with panel air filter / con filtro aria a pannello	OM501LA	235	320	04/03	>	12/08			S 3373 A	
with manual pump prefilter / con pompa manuale prefiltrato	OM501LA	235	320	04/03	>	12/08		S 6089 NE		
dryer filter / filtro essiccatore	OM501LA	235	320	04/03	>	12/08				S 7259 A
prefilter PARKER-RACOR / prefiltrato PARKER-RACOR	OM501LA	235	320	04/03	>	12/08		S 4121 NR		
power steering / servosterzo	OM501LA	235	320	04/03	>	12/08				S 3081 PO
1832 Blue Tec 4+5	OM501LA	235	320	02/05	>	12/08	S 5006 PE	S 6001 NE		S 3072 C
some AdBlue 145 l. / alcuni AdBlue 145 l.	OM501LA	235	320	02/05	>	12/08			S 7213 A	

**KW HP****...MERCEDES BENZ - trucks/autocarri**

with activated carbon air-conditioner / con climatizzatore, ai carboni attivi	OM501LA	235	320	02/05	>	12/08			S 4225 CA
with manual pump prefilter / con pompa manuale prefiltra	OM501LA	235	320	02/05	>	12/08		S 6089 NE	
dryer filter / filtro essiccatore	OM501LA	235	320	02/05	>	12/08			S 7259 A
assembly KNECHT-MAHLE / montaggio KNECHT-MAHLE	OM501LA	235	320	02/05	>	12/08			S 7639 A
assembly MANN+HUMMEL / montaggio MANN+HUMMEL	OM501LA	235	320	02/05	>	12/08			S 7A12 A
prefilter PARKER-RACOR / prefiltra PARKER-RACOR	OM501LA	235	320	02/05	>	12/08		S 4121 NR	
power steering / servosterzo	OM501LA	235	320	02/05	>	12/08			S 3081 PO
1832 K/AK	OM501LA	235	320	04/03	>	12/08	S 5006 PE	S 6001 NE	S 7639 A
with activated carbon air-conditioner / con climatizzatore, ai carboni attivi	OM501LA	235	320	04/03	>	12/08			S 4225 CA
with panel air filter / con filtro aria a pannello	OM501LA	235	320	04/03	>	12/08			S 3373 A
with manual pump prefilter / con pompa manuale prefiltra	OM501LA	235	320	04/03	>	12/08		S 6089 NE	
dryer filter / filtro essiccatore	OM501LA	235	320	04/03	>	12/08			S 7259 A
power steering / servosterzo	OM501LA	235	320	04/03	>	12/08			S 3081 PO
1836	OM501LA	265	360	04/03	>	12/08	S 5006 PE	S 6001 NE	S 7639 A
with activated carbon air-conditioner / con climatizzatore, ai carboni attivi	OM501LA	265	360	04/03	>	12/08			S 4225 CA
with panel air filter / con filtro aria a pannello	OM501LA	265	360	04/03	>	12/08			S 3373 A
with manual pump prefilter / con pompa manuale prefiltra	OM501LA	265	360	04/03	>	12/08		S 6089 NE	
dryer filter / filtro essiccatore	OM501LA	265	360	04/03	>	12/08			S 7259 A
power steering / servosterzo	OM501LA	265	360	04/03	>	12/08			S 3081 PO
1836 Blue Tec 4+5	OM501LA	265	360	02/05	>	12/08	S 5006 PE	S 6001 NE	S 3072 C
some AdBlue 145 l. / alcuni AdBlue 145 l.	OM501LA	265	360	02/05	>	12/08			S 7213 A
with activated carbon air-conditioner / con climatizzatore, ai carboni attivi	OM501LA	265	360	02/05	>	12/08			S 4225 CA
with manual pump prefilter / con pompa manuale prefiltra	OM501LA	265	360	02/05	>	12/08		S 6089 NE	
dryer filter / filtro essiccatore	OM501LA	265	360	02/05	>	12/08			S 7259 A
assembly KNECHT-MAHLE / montaggio KNECHT-MAHLE	OM501LA	265	360	02/05	>	12/08			S 7639 A
assembly MANN-HUMMEL / montaggio MANN-HUMMEL	OM501LA	265	360	02/05	>	12/08			S 7A12 A
prefilter PARKER-RACOR / prefiltra PARKER-RACOR	OM501LA	265	360	02/05	>	12/08		S 4121 NR	
power steering / servosterzo	OM501LA	265	360	02/05	>	12/08			S 3081 PO
1836 K/AK	OM501LA	265	360	04/03	>	12/08	S 5006 PE	S 6001 NE	S 7639 A
with activated carbon air-conditioner / con climatizzatore, ai carboni attivi	OM501LA	265	360	04/03	>	12/08			S 4225 CA
with panel air filter / con filtro aria a pannello	OM501LA	265	360	04/03	>	12/08			S 3373 A
with manual pump prefilter / con pompa manuale prefiltra	OM501LA	265	360	04/03	>	12/08		S 6089 NE	
dryer filter / filtro essiccatore	OM501LA	265	360	04/03	>	12/08			S 7259 A
power steering / servosterzo	OM501LA	265	360	04/03	>	12/08			S 3081 PO
1841	OM501LA	300	409	04/03	>	12/08	S 5006 PE	S 6001 NE	S 7639 A
with activated carbon air-conditioner / con climatizzatore, ai carboni attivi	OM501LA	300	409	04/03	>	12/08			S 4225 CA
with panel air filter / con filtro aria a pannello	OM501LA	300	409	04/03	>	12/08			S 3373 A
with manual pump prefilter / con pompa manuale prefiltra	OM501LA	300	409	04/03	>	12/08		S 6089 NE	
dryer filter / filtro essiccatore	OM501LA	300	409	04/03	>	12/08			S 7259 A
power steering / servosterzo	OM501LA	300	409	04/03	>	12/08			S 3081 PO
1841 Blue Tec 4+5	OM501LA	300	409	02/05	>	12/08	S 5006 PE	S 6001 NE	S 3072 C
some AdBlue 145 l. / alcuni AdBlue 145 l.	OM501LA	300	409	02/05	>	12/08			S 7213 A
with activated carbon air-conditioner / con climatizzatore, ai carboni attivi	OM501LA	300	409	02/05	>	12/08			S 4225 CA
with manual pump prefilter / con pompa manuale prefiltra	OM501LA	300	409	02/05	>	12/08		S 6089 NE	
dryer filter / filtro essiccatore	OM501LA	300	409	02/05	>	12/08			S 7259 A
assembly KNECHT-MAHLE / montaggio KNECHT-MAHLE	OM501LA	300	409	02/05	>	12/08			S 7639 A
assembly MANN-HUMMEL / montaggio MANN-HUMMEL	OM501LA	300	409	02/05	>	12/08			S 7A12 A
prefilter PARKER-RACOR / prefiltra PARKER-RACOR	OM501LA	300	409	02/05	>	12/08		S 4121 NR	
power steering / servosterzo	OM501LA	300	409	02/05	>	12/08			S 3081 PO
1841 K/AK	OM501LA	300	409	04/03	>	12/08	S 5006 PE	S 6001 NE	S 7639 A
with activated carbon air-conditioner / con climatizzatore, ai carboni attivi	OM501LA	300	409	04/03	>	12/08			S 4225 CA
with panel air filter / con filtro aria a pannello	OM501LA	300	409	04/03	>	12/08			S 3373 A
with manual pump prefilter / con pompa manuale prefiltra	OM501LA	300	409	04/03	>	12/08		S 6089 NE	
with manual pump prefilter / con pompa manuale prefiltra	OM501LA	300	409	04/03	>	12/08		S 6089 NE	
dryer filter / filtro essiccatore	OM501LA	300	409	04/03	>	12/08			S 7259 A
power steering / servosterzo	OM501LA	300	409	04/03	>	12/08			S 3081 PO
1844	OM501LA	320	435	04/03	>	12/08	S 5006 PE	S 6001 NE	S 3072 C
with activated carbon air-conditioner / con climatizzatore, ai carboni attivi	OM501LA	320	435	04/03	>	12/08			S 4225 CA
with panel air filter / con filtro aria a pannello	OM501LA	320	435	04/03	>	12/08			S 3373 A
with manual pump prefilter / con pompa manuale prefiltra	OM501LA	320	435	04/03	>	12/08		S 6089 NE	
dryer filter / filtro essiccatore	OM501LA	320	435	04/03	>	12/08			S 7259 A
power steering / servosterzo	OM501LA	320	435	04/03	>	12/08			S 3081 PO
1844 Blue Tec 4+5	OM501LA	320	435	02/05	>	12/08	S 5006 PE	S 6001 NE	S 3072 C
some AdBlue 145 l. / alcuni AdBlue 145 l.	OM501LA	320	435	02/05	>	12/08			S 7213 A
with activated carbon air-conditioner / con climatizzatore, ai carboni attivi	OM501LA	320	435	02/05	>	12/08			S 4225 CA
with manual pump prefilter / con pompa manuale prefiltra	OM501LA	320	435	02/05	>	12/08		S 6089 NE	
dryer filter / filtro essiccatore	OM501LA	320	435	02/05	>	12/08			S 7259 A

M



...MERCEDES BENZ - trucks/autocarri

M



assembly KNECHT-MAHLE / montaggio KNECHT-MAHLE	OM501LA	320	435	02/05	>	12/08			S 7639 A	
assembly MANN-HUMMEL / montaggio MANN-HUMMEL	OM501LA	320	435	02/05	>	12/08			S 7A12 A	
prefilter PARKER-RACOR / prefiltra PARKER-RACOR	OM501LA	320	435	02/05	>	12/08		S 4121 NR		
power steering / servosterzo	OM501LA	320	435	02/05	>	12/08				S 3081 PO
1846	OM501LA	335	456	04/03	>	12/08	S 5006 PE	S 6001 NE	S 7639 A	S 3072 C
with activated carbon air-conditioner / con climatizzatore, ai carboni attivi	OM501LA	335	456	04/03	>	12/08			S 3373 A	S 4225 CA
with panel air filter / con filtro aria a pannello	OM501LA	335	456	04/03	>	12/08				
with manual pump prefilter / con pompa manuale prefiltra	OM501LA	335	456	04/03	>	12/08		S 6089 NE		
dryer filter / filtro essiccatore	OM501LA	335	456	04/03	>	12/08				S 7259 A
power steering / servosterzo	OM501LA	335	456	04/03	>	12/08				S 3081 PO
1846 Blue Tec 4+5	OM501LA	335	456	02/05	>	12/08	S 5006 PE	S 6001 NE		S 3072 C
some AdBlue 145 l. / alcuni AdBlue 145 l.	OM501LA	335	456	02/05	>	12/08			S 7213 A	
with activated carbon air-conditioner / con climatizzatore, ai carboni attivi	OM501LA	335	456	02/05	>	12/08				S 4225 CA
with manual pump prefilter / con pompa manuale prefiltra	OM501LA	335	456	02/05	>	12/08		S 6089 NE		
dryer filter / filtro essiccatore	OM501LA	335	456	02/05	>	12/08				S 7259 A
assembly KNECHT-MAHLE / montaggio KNECHT-MAHLE	OM501LA	335	456	02/05	>	12/08			S 7639 A	
assembly MANN-HUMMEL / montaggio MANN-HUMMEL	OM501LA	335	456	02/05	>	12/08			S 7A12 A	
prefilter PARKER-RACOR / prefiltra PARKER-RACOR	OM501LA	335	456	02/05	>	12/08		S 4121 NR		
power steering / servosterzo	OM501LA	335	456	02/05	>	12/08				S 3081 PO
1848 Blue Tec 4+5	OM501LA	350	476	02/05	>	12/08	S 5006 PE	S 6001 NE		S 3072 C
some AdBlue 145 l. / alcuni AdBlue 145 l.	OM501LA	350	476	02/05	>	12/08			S 7213 A	
with activated carbon air-conditioner / con climatizzatore, ai carboni attivi	OM501LA	350	476	02/05	>	12/08				S 4225 CA
with manual pump prefilter / con pompa manuale prefiltra	OM501LA	350	476	02/05	>	12/08		S 6089 NE		
dryer filter / filtro essiccatore	OM501LA	350	476	02/05	>	12/08				S 7259 A
assembly KNECHT-MAHLE / montaggio KNECHT-MAHLE	OM501LA	350	476	02/05	>	12/08			S 7639 A	
assembly MANN-HUMMEL / montaggio MANN-HUMMEL	OM501LA	350	476	02/05	>	12/08			S 7A12 A	
prefilter PARKER-RACOR / prefiltra PARKER-RACOR	OM501LA	350	476	02/05	>	12/08		S 4121 NR		
power steering / servosterzo	OM501LA	350	476	02/05	>	12/08				S 3081 PO
1850	OM502LA	370	503	04/03	>	12/08	S 5006 PE	S 6001 NE	S 7639 A	S 3072 C
with activated carbon air-conditioner / con climatizzatore, ai carboni attivi	OM502LA	370	503	04/03	>	12/08			S 3373 A	S 4225 CA
with panel air filter / con filtro aria a pannello	OM502LA	370	503	04/03	>	12/08				
with manual pump prefilter / con pompa manuale prefiltra	OM502LA	370	503	04/03	>	12/08		S 6089 NE		
dryer filter / filtro essiccatore	OM502LA	370	503	04/03	>	12/08				S 7259 A
power steering / servosterzo	OM502LA	370	503	04/03	>	12/08				S 3081 PO
1851 Blue Tec 4+5	OM502LA	375	510	02/05	>	12/08	S 5006 PE	S 6001 NE		S 3072 C
some AdBlue 145 l. / alcuni AdBlue 145 l.	OM502LA	375	510	02/05	>	12/08			S 7213 A	
with activated carbon air-conditioner / con climatizzatore, ai carboni attivi	OM502LA	375	510	02/05	>	12/08				S 4225 CA
with manual pump prefilter / con pompa manuale prefiltra	OM502LA	375	510	02/05	>	12/08		S 6089 NE		
dryer filter / filtro essiccatore	OM502LA	375	510	02/05	>	12/08				S 7259 A
assembly KNECHT-MAHLE / montaggio KNECHT-MAHLE	OM502LA	375	510	02/05	>	12/08			S 7639 A	
assembly MANN-HUMMEL / montaggio MANN-HUMMEL	OM502LA	375	510	02/05	>	12/08			S 7A12 A	
prefilter PARKER-RACOR / prefiltra PARKER-RACOR	OM502LA	375	510	02/05	>	12/08		S 4121 NR		
power steering / servosterzo	OM502LA	375	510	02/05	>	12/08				S 3081 PO
1854	OM502LA	395	537	04/03	>	12/08	S 5006 PE	S 6001 NE	S 7639 A	S 3072 C
with activated carbon air-conditioner / con climatizzatore, ai carboni attivi	OM502LA	395	537	04/03	>	12/08			S 3373 A	S 4225 CA
with panel air filter / con filtro aria a pannello	OM502LA	395	537	04/03	>	12/08				
with manual pump prefilter / con pompa manuale prefiltra	OM502LA	395	537	04/03	>	12/08		S 6089 NE		
dryer filter / filtro essiccatore	OM502LA	395	537	04/03	>	08/08				S 7259 A
power steering / servosterzo	OM502LA	395	537	04/03	>	12/08				S 3081 PO
1855 Blue Tec 4+5	OM502LA	405	551	07/05	>	12/08	S 5006 PE	S 6001 NE		S 3072 C
some AdBlue 145 l. / alcuni AdBlue 145 l.	OM502LA	405	551	07/05	>	12/08			S 7213 A	
with activated carbon air-conditioner / con climatizzatore, ai carboni attivi	OM502LA	405	551	07/05	>	12/08				S 4225 CA
with manual pump prefilter / con pompa manuale prefiltra	OM502LA	405	551	07/05	>	12/08		S 6089 NE		
dryer filter / filtro essiccatore	OM502LA	405	551	07/05	>	12/08				S 7259 A
assembly KNECHT-MAHLE / montaggio KNECHT-MAHLE	OM502LA	405	551	07/05	>	12/08			S 7639 A	
assembly MANN-HUMMEL / montaggio MANN-HUMMEL	OM502LA	405	551	07/05	>	12/08			S 7A12 A	
prefilter / prefiltra	OM502LA	405	551	07/05	>	12/08		S 4121 NR		
power steering / servosterzo	OM502LA	405	551	07/05	>	12/08				S 3081 PO
1858	OM502LA	425	578	04/03	>	12/08	S 5006 PE	S 6001 NE	S 7639 A	S 3072 C
with activated carbon air-conditioner / con climatizzatore, ai carboni attivi	OM502LA	425	578	04/03	>	12/08			S 3373 A	S 4225 CA
with panel air filter / con filtro aria a pannello	OM502LA	425	578	04/03	>	12/08				
with manual pump prefilter / con pompa manuale prefiltra	OM502LA	425	578	04/03	>	12/08		S 6089 NE		
dryer filter / filtro essiccatore	OM502LA	425	578	04/03	>	12/08				S 7259 A
power steering / servosterzo	OM502LA	425	578	04/03	>	12/08				S 3081 PO
1860 Blue Tec 4+5	OM502LA	440	598	07/05	>	12/08	S 5006 PE	S 6001 NE		S 3072 C
some AdBlue 145 l. / alcuni AdBlue 145 l.	OM502LA	440	598	07/05	>	12/08			S 7213 A	
with activated carbon air-conditioner / con climatizzatore, ai carboni attivi	OM502LA	440	598	07/05	>	12/08				S 4225 CA

**KW HP****...MERCEDES BENZ - trucks/autocarri**

with manual pump prefilter / con pompa manuale prefiltra	OM502LA	440	598	07/05	>	12/08		S 6089 NE		S 7259 A
dryer filter / filtro essiccatore	OM502LA	440	598	07/05	>	12/08			S 7639 A	
assembly KNECHT-MAHLE / montaggio KNECHT-MAHLE	OM502LA	440	598	07/05	>	12/08			S 7A12 A	
assembly MANN-HUMMEL / montaggio MANN-HUMMEL	OM502LA	440	598	07/05	>	12/08				
prefilter PARKER-RACOR / prefiltra PARKER-RACOR	OM502LA	440	598	07/05	>	12/08		S 4121 NR		
power steering / servosterzo	OM502LA	440	598	07/05	>	12/08				S 3081 PO
1861 Black Edition	OM502LA	450	612	09/04	>	12/08	S 5006 PE	S 6001 NE	S 7639 A	S 3072 C
with activated carbon air-conditioner / con climatizzatore, ai carboni attivi	OM502LA	450	612	09/04	>	12/08				S 4225 CA
with manual pump prefilter / con pompa manuale prefiltra	OM502LA	450	612	09/04	>	12/08		S 6089 NE		
dryer filter / filtro essiccatore	OM502LA	450	612	09/04	>	12/08				S 7259 A
2032	OM501LA	235	320	04/03	>	12/08	S 5006 PE	S 6001 NE	S 7639 A	S 3072 C
with activated carbon air-conditioner / con climatizzatore, ai carboni attivi	OM501LA	235	320	04/03	>	12/08				S 4225 CA
with panel air filter / con filtro aria a pannello	OM501LA	235	320	04/03	>	12/08			S 3373 A	
with manual pump prefilter / con pompa manuale prefiltra	OM501LA	235	320	04/03	>	12/08		S 6089 NE		
dryer filter / filtro essiccatore	OM501LA	235	320	04/03	>	12/08				S 7259 A
power steering / servosterzo	OM501LA	235	320	04/03	>	12/08				S 3081 PO
2036	OM501LA	265	360	04/03	>	12/08	S 5006 PE	S 6001 NE	S 7639 A	S 3072 C
with activated carbon air-conditioner / con climatizzatore, ai carboni attivi	OM501LA	265	360	04/03	>	12/08				S 4225 CA
with panel air filter / con filtro aria a pannello	OM501LA	265	360	04/03	>	12/08			S 3373 A	
with manual pump prefilter / con pompa manuale prefiltra	OM501LA	265	360	04/03	>	12/08		S 6089 NE		
dryer filter / filtro essiccatore	OM501LA	265	360	04/03	>	12/08				S 7259 A
power steering / servosterzo	OM501LA	265	360	04/03	>	12/08				S 3081 PO
2041	OM501LA	300	409	04/03	>	12/08	S 5006 PE	S 6001 NE	S 7639 A	S 3072 C
with activated carbon air-conditioner / con climatizzatore, ai carboni attivi	OM501LA	300	409	04/03	>	12/08				S 4225 CA
with panel air filter / con filtro aria a pannello	OM501LA	300	409	04/03	>	12/08			S 3373 A	
with manual pump prefilter / con pompa manuale prefiltra	OM501LA	300	409	04/03	>	12/08		S 6089 NE		
dryer filter / filtro essiccatore	OM501LA	300	409	04/03	>	12/08				S 7259 A
power steering / servosterzo	OM501LA	300	409	04/03	>	12/08				S 3081 PO
2044	OM501LA	320	435	04/03	>	12/08	S 5006 PE	S 6001 NE	S 7639 A	S 3072 C
with activated carbon air-conditioner / con climatizzatore, ai carboni attivi	OM501LA	320	435	04/03	>	12/08				S 4225 CA
with panel air filter / con filtro aria a pannello	OM501LA	320	435	04/03	>	12/08			S 3373 A	
with manual pump prefilter / con pompa manuale prefiltra	OM501LA	320	435	04/03	>	12/08		S 6089 NE		
dryer filter / filtro essiccatore	OM501LA	320	435	04/03	>	12/08				S 7259 A
power steering / servosterzo	OM501LA	320	435	04/03	>	12/08				S 3081 PO
2046	OM501LA	335	456	04/03	>	12/08	S 5006 PE	S 6001 NE	S 7639 A	S 3072 C
with activated carbon air-conditioner / con climatizzatore, ai carboni attivi	OM501LA	335	456	04/03	>	12/08				S 4225 CA
with panel air filter / con filtro aria a pannello	OM501LA	335	456	04/03	>	12/08			S 3373 A	
with manual pump prefilter / con pompa manuale prefiltra	OM501LA	335	456	04/03	>	12/08		S 6089 NE		
dryer filter / filtro essiccatore	OM501LA	335	456	04/03	>	12/08				S 7259 A
power steering / servosterzo	OM501LA	335	456	04/03	>	12/08				S 3081 PO
2048	OM501LA	350	476	04/03	>	12/08	S 5006 PE	S 6001 NE	S 7639 A	S 3072 C
with activated carbon air-conditioner / con climatizzatore, ai carboni attivi	OM501LA	350	476	04/03	>	12/08				S 4225 CA
with panel air filter / con filtro aria a pannello	OM501LA	350	476	04/03	>	12/08			S 3373 A	
with manual pump prefilter / con pompa manuale prefiltra	OM501LA	350	476	04/03	>	12/08		S 6089 NE		
dryer filter / filtro essiccatore	OM501LA	350	476	04/03	>	12/08				S 7259 A
power steering / servosterzo	OM501LA	350	476	04/03	>	12/08				S 3081 PO
2050	OM502LA	370	503	04/03	>	12/08	S 5006 PE	S 6001 NE	S 7639 A	S 3072 C
with activated carbon air-conditioner / con climatizzatore, ai carboni attivi	OM502LA	370	503	04/03	>	12/08				S 4225 CA
with panel air filter / con filtro aria a pannello	OM502LA	370	503	04/03	>	12/08			S 3373 A	
with manual pump prefilter / con pompa manuale prefiltra	OM502LA	370	503	04/03	>	12/08		S 6089 NE		
dryer filter / filtro essiccatore	OM502LA	370	503	04/03	>	12/08				S 7259 A
power steering / servosterzo	OM502LA	370	503	04/03	>	12/08				S 3081 PO
2051 AS	OM502LA	375	510	04/03	>	12/08	S 5006 PE	S 6001 NE	S 7639 A	S 3072 C
with activated carbon air-conditioner / con climatizzatore, ai carboni attivi	OM502LA	375	510	04/03	>	12/08				S 4225 CA
with panel air filter / con filtro aria a pannello	OM502LA	375	510	04/03	>	12/08			S 3373 A	
with manual pump prefilter / con pompa manuale prefiltra	OM502LA	375	510	04/03	>	12/08		S 6089 NE		
dryer filter / filtro essiccatore	OM502LA	375	510	04/03	>	12/08				S 7259 A
power steering / servosterzo	OM502LA	375	510	04/03	>	12/08				S 3081 PO
2054	OM502LA	395	537	04/03	>	12/08	S 5006 PE	S 6001 NE	S 7639 A	S 3072 C
with activated carbon air-conditioner / con climatizzatore, ai carboni attivi	OM502LA	395	537	04/03	>	12/08				S 4225 CA
with panel air filter / con filtro aria a pannello	OM502LA	395	537	04/03	>	12/08			S 3373 A	
with manual pump prefilter / con pompa manuale prefiltra	OM502LA	395	537	04/03	>	12/08		S 6089 NE		
dryer filter / filtro essiccatore	OM502LA	395	537	04/03	>	12/08				S 7259 A
power steering / servosterzo	OM502LA	395	537	04/03	>	12/08				S 3081 PO
2058	OM502LA	425	578	04/03	>	12/08	S 5006 PE	S 6001 NE	S 7639 A	S 3072 C
with activated carbon air-conditioner / con climatizzatore, ai carboni attivi	OM502LA	425	578	04/03	>	12/08				S 4225 CA
with panel air filter / con filtro aria a pannello	OM502LA	425	578	04/03	>	12/08			S 3373 A	

M

**KW HP****...MERCEDES BENZ - trucks/autocarri**

with manual pump prefilter / con pompa manuale prefiltra	OM502LA	425	578	04/03	>	12/08		S 6089 NE		S 7259 A
dryer filter / filtro essiccatore	OM502LA	425	578	04/03	>	12/08				S 3081 PO
power steering / servosterzo	OM502LA	425	578	04/03	>	12/08				S 3072 C
2532	OM501LA	235	320	04/03	>	12/08	S 5006 PE	S 6001 NE	S 7639 A	S 4225 CA
with activated carbon air-conditioner / con climatizzatore, ai carboni attivi	OM501LA	235	320	04/03	>	12/08			S 3373 A	
with panel air filter / con filtro aria a pannello	OM501LA	235	320	04/03	>	12/08				
with manual pump prefilter / con pompa manuale prefiltra	OM501LA	235	320	04/03	>	12/08		S 6089 NE		S 7259 A
dryer filter / filtro essiccatore	OM501LA	235	320	04/03	>	12/08				S 3081 PO
power steering / servosterzo	OM501LA	235	320	04/03	>	12/08				S 3072 C
2532 Blue Tec 4+5	OM501LA	235	320	02/05	>	12/08	S 5006 PE	S 6001 NE		S 7213 A
some AdBlue 145 l. / alcuni AdBlue 145 l.	OM501LA	235	320	02/05	>	12/08				S 4225 CA
with activated carbon air-conditioner / con climatizzatore, ai carboni attivi	OM501LA	235	320	02/05	>	12/08				
with manual pump prefilter / con pompa manuale prefiltra	OM501LA	235	320	02/05	>	12/08		S 6089 NE		S 7259 A
dryer filter / filtro essiccatore	OM501LA	235	320	02/05	>	12/08				S 7639 A
assembly KNECHT-MAHLE / montaggio KNECHT-MAHLE	OM501LA	235	320	02/05	>	12/08			S 7A12 A	
assembly MANN-HUMMEL / montaggio MANN-HUMMEL	OM501LA	235	320	02/05	>	12/08				
prefilter PARKER-RACOR / prefiltra PARKER-RACOR	OM501LA	235	320	02/05	>	12/08		S 4121 NR		S 3081 PO
power steering / servosterzo	OM501LA	235	320	02/05	>	12/08				S 3072 C
2536	OM501LA	265	360	04/03	>	12/08	S 5006 PE	S 6001 NE	S 7639 A	S 4225 CA
with activated carbon air-conditioner / con climatizzatore, ai carboni attivi	OM501LA	265	360	04/03	>	12/08			S 3373 A	
with panel air filter / con filtro aria a pannello	OM501LA	265	360	04/03	>	12/08				
with manual pump prefilter / con pompa manuale prefiltra	OM501LA	265	360	04/03	>	12/08		S 6089 NE		S 7259 A
dryer filter / filtro essiccatore	OM501LA	265	360	04/03	>	12/08				S 3081 PO
power steering / servosterzo	OM501LA	265	360	04/03	>	12/08				S 3072 C
2536 Blue Tec 4+5	OM501LA	265	360	02/05	>	12/08	S 5006 PE	S 6001 NE		S 7213 A
some AdBlue 145 l. / alcuni AdBlue 145 l.	OM501LA	265	360	02/05	>	12/08				S 4225 CA
with activated carbon air-conditioner / con climatizzatore, ai carboni attivi	OM501LA	265	360	02/05	>	12/08				
with manual pump prefilter / con pompa manuale prefiltra	OM501LA	265	360	02/05	>	12/08		S 6089 NE		S 7259 A
dryer filter / filtro essiccatore	OM501LA	265	360	02/05	>	12/08				S 7639 A
assembly KNECHT-MAHLE / montaggio KNECHT-MAHLE	OM501LA	265	360	02/05	>	12/08			S 7A12 A	
assembly MANN-HUMMEL / montaggio MANN-HUMMEL	OM501LA	265	360	02/05	>	12/08				
prefilter PARKER-RACOR / prefiltra PARKER-RACOR	OM501LA	265	360	02/05	>	12/08		S 4121 NR		S 3081 PO
power steering / servosterzo	OM501LA	265	360	02/05	>	12/08				S 3072 C
2541	OM501LA	300	409	02/03	>	12/08	S 5006 PE	S 6001 NE	S 7639 A	S 4225 CA
with activated carbon air-conditioner / con climatizzatore, ai carboni attivi	OM501LA	300	409	02/03	>	12/08			S 3373 A	
with panel air filter / con filtro aria a pannello	OM501LA	300	409	04/03	>	12/08				
with manual pump prefilter / con pompa manuale prefiltra	OM501LA	300	409	04/03	>	12/08		S 6089 NE		S 7259 A
dryer filter / filtro essiccatore	OM501LA	300	409	02/03	>	12/08				S 3081 PO
power steering / servosterzo	OM501LA	300	409	02/03	>	12/08				S 3072 C
2541 Blue Tec 4+5	OM501LA	300	409	02/05	>	12/08	S 5006 PE	S 6001 NE		S 7213 A
some AdBlue 145 l. / alcuni AdBlue 145 l.	OM501LA	300	409	02/05	>	12/08				S 4225 CA
with activated carbon air-conditioner / con climatizzatore, ai carboni attivi	OM501LA	300	409	02/05	>	12/08				
with manual pump prefilter / con pompa manuale prefiltra	OM501LA	300	409	02/05	>	12/08		S 6089 NE		S 7259 A
dryer filter / filtro essiccatore	OM501LA	300	409	02/05	>	12/08				S 7639 A
assembly KNECHT-MAHLE / montaggio KNECHT-MAHLE	OM501LA	300	409	02/05	>	12/08			S 7A12 A	
assembly MANN-HUMMEL / montaggio MANN-HUMMEL	OM501LA	300	409	02/05	>	12/08				
prefilter PARKER-RACOR / prefiltra PARKER-RACOR	OM501LA	300	409	02/05	>	12/08		S 4121 NR		S 3081 PO
power steering / servosterzo	OM501LA	300	409	02/05	>	12/08				S 3072 C
2544	OM501LA	320	435	02/03	>	12/08	S 5006 PE	S 6001 NE	S 7639 A	S 4225 CA
some power steering / alcuni servosterzo	OM501LA	320	435	02/03	>	12/08				S 3081 PO
with activated carbon air-conditioner / con climatizzatore, ai carboni attivi	OM501LA	320	435	02/03	>	12/08			S 3373 A	
with panel air filter / con filtro aria a pannello	OM501LA	320	435	02/03	>	12/08				
with manual pump prefilter / con pompa manuale prefiltra	OM501LA	320	435	02/03	>	12/08		S 6089 NE		S 7259 A
dryer filter / filtro essiccatore	OM501LA	320	435	02/03	>	12/08				S 3072 C
2544 Blue Tec 4+5	OM501LA	320	435	02/05	>	12/08	S 5006 PE	S 6001 NE	S 7639 A	S 7213 A
some AdBlue 145 l. / alcuni AdBlue 145 l.	OM501LA	320	435	02/05	>	12/08				S 4225 CA
with activated carbon air-conditioner / con climatizzatore, ai carboni attivi	OM501LA	320	435	02/05	>	12/08				
with manual pump prefilter / con pompa manuale prefiltra	OM501LA	320	435	02/05	>	12/08		S 6089 NE		S 7259 A
dryer filter / filtro essiccatore	OM501LA	320	435	02/05	>	12/08				S 7639 A
assembly KNECHT-MAHLE / montaggio KNECHT-MAHLE	OM501LA	320	435	02/05	>	12/08			S 7A12 A	
assembly MANN-HUMMEL / montaggio MANN-HUMMEL	OM501LA	320	435	02/05	>	12/08				
prefilter PARKER-RACOR / prefiltra PARKER-RACOR	OM501LA	320	435	02/05	>	12/08		S 4121 NR		S 3081 PO
power steering / servosterzo	OM501LA	320	435	02/05	>	12/08				S 3072 C
2546	OM501LA	335	456	02/03	>	12/08	S 5006 PE	S 6001 NE	S 7639 A	S 4225 CA
some power steering / alcuni servosterzo	OM501LA	335	456	02/03	>	12/08				S 3081 PO
with activated carbon air-conditioner / con climatizzatore, ai carboni attivi	OM501LA	335	456	02/03	>	12/08				S 4225 CA
with panel air filter / con filtro aria a pannello	OM501LA	335	456	02/03	>	12/08			S 3373 A	



...MERCEDES BENZ - trucks/autocarri

with manual pump prefilter / con pompa manuale prefiltra	OM501LA	335	456	02/03	>	12/08		S 6089 NE		
dryer filter / filtro essiccatore	OM501LA	335	456	02/03	>	12/08				S 7259 A
2546 Blue Tec 4+5	OM501LA	335	456	02/05	>	12/08	S 5006 PE	S 6001 NE		S 3072 C
some AdBlue 145 l. / alcuni AdBlue 145 l.	OM501LA	335	456	02/05	>	12/08			S 7213 A	
with activated carbon air-conditioner / con climatizzatore, ai carboni attivi	OM501LA	335	456	02/05	>	12/08				S 4225 CA
with manual pump prefilter / con pompa manuale prefiltra	OM501LA	335	456	02/05	>	12/08		S 6089 NE		
dryer filter / filtro essiccatore	OM501LA	335	456	02/05	>	12/08				S 7259 A
assembly MANN-HUMMEL / montaggio MANN-HUMMEL	OM501LA	335	456	02/05	>	12/08			S 7A12 A	
prefilter PARKER-RACOR / prefiltra PARKER-RACOR	OM501LA	335	456	02/05	>	12/08		S 4121 NR		
power steering / servosterzo	OM501LA	335	456	02/05	>	12/08				S 3081 PO
2548	OM501LA	350	476	04/03	>	12/08	S 5006 PE	S 6001 NE	S 7639 A	S 3072 C
with activated carbon air-conditioner / con climatizzatore, ai carboni attivi	OM501LA	350	476	04/03	>	12/08				S 4225 CA
with panel air filter / con filtro aria a pannello	OM501LA	350	476	04/03	>	12/08			S 3373 A	
with manual pump prefilter / con pompa manuale prefiltra	OM501LA	350	476	04/03	>	12/08		S 6089 NE		
dryer filter / filtro essiccatore	OM501LA	350	476	04/03	>	12/08				S 7259 A
power steering / servosterzo	OM501LA	350	476	04/03	>	12/08				S 3081 PO
2548 Blue Tec 4+5	OM501LA	350	476	02/05	>	12/08	S 5006 PE	S 6001 NE		S 3072 C
some AdBlue 145 l. / alcuni AdBlue 145 l.	OM501LA	350	476	02/05	>	12/08			S 7213 A	
with activated carbon air-conditioner / con climatizzatore, ai carboni attivi	OM501LA	350	476	02/05	>	12/08				S 4225 CA
with manual pump prefilter / con pompa manuale prefiltra	OM501LA	350	476	02/05	>	12/08		S 6089 NE		
dryer filter / filtro essiccatore	OM501LA	350	476	02/05	>	12/08				S 7259 A
assembly KNECHT-MAHLE / montaggio KNECHT-MAHLE	OM501LA	350	476	02/05	>	12/08			S 7639 A	
assembly MANN-HUMMEL / montaggio MANN-HUMMEL	OM501LA	350	476	02/05	>	12/08			S 7A12 A	
prefilter PARKER-RACOR / prefiltra PARKER-RACOR	OM501LA	350	476	02/05	>	12/08		S 4121 NR		
power steering / servosterzo	OM501LA	350	476	02/05	>	12/08				S 3081 PO
2550	OM502LA	370	503	04/03	>	12/08	S 5006 PE	S 6001 NE	S 7639 A	S 3072 C
some power steering / alcuni servosterzo	OM502LA	370	503	04/03	>	12/08				S 3081 PO
with activated carbon air-conditioner / con climatizzatore, ai carboni attivi	OM502LA	370	503	04/03	>	12/08				S 4225 CA
with panel air filter / con filtro aria a pannello	OM502LA	370	503	04/03	>	12/08			S 3373 A	
with manual pump prefilter / con pompa manuale prefiltra	OM502LA	370	503	04/03	>	12/08		S 6089 NE		
dryer filter / filtro essiccatore	OM502LA	370	503	04/03	>	12/08				S 7259 A
2551 Blue Tec 4+5	OM502LA	375	503	07/05	>	12/08	S 5006 PE	S 6001 NE		S 3072 C
some AdBlue 145 l. / alcuni AdBlue 145 l.	OM502LA	375	503	07/05	>	12/08			S 7213 A	
with activated carbon air-conditioner / con climatizzatore, ai carboni attivi	OM502LA	375	503	07/05	>	12/08				S 4225 CA
with manual pump prefilter / con pompa manuale prefiltra	OM502LA	375	503	07/05	>	12/08		S 6089 NE		
dryer filter / filtro essiccatore	OM502LA	375	503	07/05	>	12/08				S 7259 A
assembly KNECHT-MAHLE / montaggio KNECHT-MAHLE	OM502LA	375	503	07/05	>	12/08			S 7639 A	
assembly MANN-HUMMEL / montaggio MANN-HUMMEL	OM502LA	375	503	07/05	>	12/08			S 7A12 A	
prefilter PARKER-RACOR / prefiltra PARKER-RACOR	OM502LA	375	503	07/05	>	12/08		S 4121 NR		
power steering / servosterzo	OM502LA	375	503	07/05	>	12/08				S 3081 PO
2554	OM502LA	395	537	02/03	>	12/08	S 5006 PE	S 6001 NE	S 7639 A	S 3072 C
some power steering / alcuni servosterzo	OM502LA	395	537	02/03	>	12/08				S 3081 PO
with activated carbon air-conditioner / con climatizzatore, ai carboni attivi	OM502LA	395	537	02/03	>	12/08				S 4225 CA
with manual pump prefilter / con pompa manuale prefiltra	OM502LA	395	537	02/03	>	12/08		S 6089 NE		
dryer filter / filtro essiccatore	OM502LA	395	537	02/03	>	12/08				S 7259 A
2555 Blue Tec 4+5	OM502LA	405	551	07/05	>	12/08	S 5006 PE	S 6001 NE		S 3072 C
some AdBlue 145 l. / alcuni AdBlue 145 l.	OM502LA	405	551	07/05	>	12/08			S 7213 A	
with activated carbon air-conditioner / con climatizzatore, ai carboni attivi	OM502LA	405	551	07/05	>	12/08				S 4225 CA
with manual pump prefilter / con pompa manuale prefiltra	OM502LA	405	551	07/05	>	12/08		S 6089 NE		
dryer filter / filtro essiccatore	OM502LA	405	551	07/05	>	12/08				S 7259 A
assembly KNECHT-MAHLE / montaggio KNECHT-MAHLE	OM502LA	405	551	07/05	>	12/08			S 7639 A	
assembly MANN-HUMMEL / montaggio MANN-HUMMEL	OM502LA	405	551	07/05	>	12/08			S 7A12 A	
prefilter PARKER-RACOR / prefiltra PARKER-RACOR	OM502LA	405	551	07/05	>	12/08		S 4121 NR		
power steering / servosterzo	OM502LA	405	551	07/05	>	12/08				S 3081 PO
2558	OM502LA	425	598	02/03	>	12/08	S 5006 PE	S 6001 NE	S 7639 A	S 3072 C
some power steering / alcuni servosterzo	OM502LA	425	598	02/03	>	12/08				S 3081 PO
with activated carbon air-conditioner / con climatizzatore, ai carboni attivi	OM502LA	425	598	02/03	>	12/08				S 4225 CA
with panel air filter / con filtro aria a pannello	OM502LA	425	598	02/03	>	12/08			S 3373 A	
with manual pump prefilter / con pompa manuale prefiltra	OM502LA	425	598	02/03	>	12/08		S 6089 NE		
dryer filter / filtro essiccatore	OM502LA	425	598	02/03	>	12/08				S 7259 A
2560 Blue Tec 4+5	OM502LA	440	598	07/05	>	12/08	S 5006 PE	S 6001 NE		S 3072 C
some AdBlue 145 l. / alcuni AdBlue 145 l.	OM502LA	440	598	07/05	>	12/08			S 7213 A	
with activated carbon air-conditioner / con climatizzatore, ai carboni attivi	OM502LA	440	598	07/05	>	12/08				S 4225 CA
with manual pump prefilter / con pompa manuale prefiltra	OM502LA	440	598	07/05	>	12/08		S 6089 NE		
dryer filter / filtro essiccatore	OM502LA	440	598	07/05	>	12/08				S 7259 A
assembly KNECHT-MAHLE / montaggio KNECHT-MAHLE	OM502LA	440	598	07/05	>	12/08			S 7639 A	
assembly MANN-HUMMEL / montaggio MANN-HUMMEL	OM502LA	440	598	07/05	>	12/08			S 7A12 A	

M



KW HP



...MERCEDES BENZ - trucks/autocarri

M



prefilter PARKER-RACOR / prefiltro PARKER-RACOR	OM502LA	440	598	07/05	>	12/08		S 4121 NR		
power steering / servosterzo	OM502LA	440	598	07/05	>	12/08				S 3081 PO
2632	OM501LA	235	320	04/03	>	12/08	S 5006 PE	S 6001 NE	S 7639 A	S 3072 C
with activated carbon air-conditioner / con climatizzatore, ai carboni attivi	OM501LA	235	320	04/03	>	12/08				S 4225 CA
with panel air filter / con filtro aria a pannello	OM501LA	235	320	04/03	>	12/08			S 3373 A	
with manual pump prefilter / con pompa manuale prefiltro	OM501LA	235	320	04/03	>	12/08		S 6089 NE		
dryer filter / filtro essiccatore	OM501LA	235	320	04/03	>	12/08				S 7259 A
prefilter PARKER-RACOR / prefiltro PARKER-RACOR	OM501LA	235	320	04/03	>	12/08		S 4121 NR		
power steering / servosterzo	OM501LA	235	320	04/03	>	12/08				S 3081 PO
variation 2 filters / variante N.2 filtri	OM501LA	235	320	09/03	>	12/08			S 7A12 A	
variation 2 filters (inner) / variante N.2 filtri (interno)	OM501LA	235	320	04/03	>	12/08			S 7649 A	
2636	OM501LA	265	360	04/03	>	12/08	S 5006 PE	S 6001 NE	S 7639 A	S 3072 C
with activated carbon air-conditioner / con climatizzatore, ai carboni attivi	OM501LA	265	360	04/03	>	12/08				S 4225 CA
with panel air filter / con filtro aria a pannello	OM501LA	265	360	04/03	>	12/08			S 3373 A	
with manual pump prefilter / con pompa manuale prefiltro	OM501LA	265	360	04/03	>	12/08		S 6089 NE		
dryer filter / filtro essiccatore	OM501LA	265	360	04/03	>	12/08				S 7259 A
prefilter PARKER-RACOR / prefiltro PARKER-RACOR	OM501LA	265	360	04/03	>	12/08		S 4121 NR		
power steering / servosterzo	OM501LA	265	360	04/03	>	12/08				S 3081 PO
variation 2 filters / variante N.2 filtri	OM501LA	265	360	09/03	>	12/08			S 7A12 A	
variation 2 filters (inner) / variante N.2 filtri (interno)	OM501LA	265	360	04/03	>	12/08			S 7649 A	
2641	OM501LA	300	409	04/03	>	12/08	S 5006 PE	S 6001 NE	S 7639 A	S 3072 C
with activated carbon air-conditioner / con climatizzatore, ai carboni attivi	OM501LA	300	409	04/03	>	12/08				S 4225 CA
with panel air filter / con filtro aria a pannello	OM501LA	300	409	04/03	>	12/08			S 3373 A	
with manual pump prefilter / con pompa manuale prefiltro	OM501LA	300	409	04/03	>	12/08		S 6089 NE		
dryer filter / filtro essiccatore	OM501LA	300	409	04/03	>	12/08				S 7259 A
power steering / servosterzo	OM501LA	300	409	04/03	>	12/08				S 3081 PO
variation 2 filters / variante N.2 filtri	OM501LA	300	409	09/03	>	12/08			S 7A12 A	
2644	OM501LA	320	435	04/03	>	12/08	S 5006 PE	S 6001 NE	S 7639 A	S 3072 C
with activated carbon air-conditioner / con climatizzatore, ai carboni attivi	OM501LA	320	435	04/03	>	12/08				S 4225 CA
with panel air filter / con filtro aria a pannello	OM501LA	320	435	04/03	>	12/08			S 3373 A	
with manual pump prefilter / con pompa manuale prefiltro	OM501LA	320	435	04/03	>	12/08		S 6089 NE		
dryer filter / filtro essiccatore	OM501LA	320	435	04/03	>	12/08				S 7259 A
power steering / servosterzo	OM501LA	320	435	04/03	>	12/08				S 3081 PO
variation 2 filters / variante N.2 filtri	OM501LA	320	435	09/03	>	12/08			S 7A12 A	
2646	OM501LA	335	456	04/03	>	12/08	S 5006 PE	S 6001 NE	S 7639 A	S 3072 C
with activated carbon air-conditioner / con climatizzatore, ai carboni attivi	OM501LA	335	456	04/03	>	12/08				S 4225 CA
with panel air filter / con filtro aria a pannello	OM501LA	335	456	04/03	>	12/08			S 3373 A	
with manual pump prefilter / con pompa manuale prefiltro	OM501LA	335	456	04/03	>	12/08		S 6089 NE		
dryer filter / filtro essiccatore	OM501LA	335	456	04/03	>	12/08				S 7259 A
power steering / servosterzo	OM501LA	335	456	04/03	>	12/08				S 3081 PO
2648	OM501LA	350	476	04/03	>	12/08	S 5006 PE	S 6001 NE	S 7639 A	S 3072 C
with activated carbon air-conditioner / con climatizzatore, ai carboni attivi	OM501LA	350	476	04/03	>	12/08				S 4225 CA
with panel air filter / con filtro aria a pannello	OM501LA	350	476	04/03	>	12/08			S 3373 A	
with manual pump prefilter / con pompa manuale prefiltro	OM501LA	350	476	04/03	>	12/08		S 6089 NE		
dryer filter / filtro essiccatore	OM501LA	350	476	04/03	>	12/08				S 7259 A
power steering / servosterzo	OM501LA	350	476	04/03	>	12/08				S 3081 PO
2648 Blue Tec 4+5	OM501LA	350	476	02/05	>	12/08	S 5006 PE	S 6001 NE		S 3072 C
some AdBlue 145 l. / alcuni AdBlue 145 l.	OM501LA	350	476	02/05	>	12/08			S 7213 A	
with activated carbon air-conditioner / con climatizzatore, ai carboni attivi	OM501LA	350	476	02/05	>	12/08				S 4225 CA
with manual pump prefilter / con pompa manuale prefiltro	OM501LA	350	476	02/05	>	12/08		S 6089 NE		
dryer filter / filtro essiccatore	OM501LA	350	476	02/05	>	12/08				S 7259 A
assembly KNECHT-MAHLE / montaggio KNECHT-MAHLE	OM501LA	350	476	02/05	>	12/08			S 7639 A	
assembly MANN-HUMMEL / montaggio MANN-HUMMEL	OM501LA	350	476	02/05	>	12/08			S 7A12 A	
prefilter PARKER-RACOR / prefiltro PARKER-RACOR	OM501LA	350	476	02/05	>	12/08		S 4121 NR		
power steering / servosterzo	OM501LA	350	476	02/05	>	12/08				S 3081 PO
2650	OM502LA	370	503	04/03	>	12/08	S 5006 PE	S 6001 NE	S 7639 A	S 3072 C
with activated carbon air-conditioner / con climatizzatore, ai carboni attivi	OM502LA	370	503	04/03	>	12/08				S 4225 CA
with panel air filter / con filtro aria a pannello	OM502LA	370	503	04/03	>	12/08			S 3373 A	
with manual pump prefilter / con pompa manuale prefiltro	OM502LA	370	503	04/03	>	12/08		S 6089 NE		
dryer filter / filtro essiccatore	OM502LA	370	503	04/03	>	12/08				S 7259 A
power steering / servosterzo	OM502LA	370	503	04/03	>	12/08				S 3081 PO
variation 2 filters / variante N.2 filtri	OM502LA	370	503	09/03	>	12/08			S 7A12 A	
2651 Blue Tec 4+5	OM501LA	375	510	02/05	>	12/08	S 5006 PE	S 6001 NE		S 3072 C
some AdBlue 145 l. / alcuni AdBlue 145 l.	OM501LA	375	510	02/05	>	12/08			S 7213 A	
with activated carbon air-conditioner / con climatizzatore, ai carboni attivi	OM501LA	375	510	02/05	>	12/08				S 4225 CA
with manual pump prefilter / con pompa manuale prefiltro	OM501LA	375	510	02/05	>	12/08		S 6089 NE		
dryer filter / filtro essiccatore	OM501LA	375	510	02/05	>	12/08				S 7259 A

**KW HP****...MERCEDES BENZ - trucks/autocarri**

assembly KNECHT-MAHLE / montaggio KNECHT-MAHLE	OM501LA	375	510	02/05	>	12/08			S 7639 A	
assembly MANN-HUMMEL / montaggio MANN-HUMMEL	OM501LA	375	510	02/05	>	12/08			S 7A12 A	
prefilter PARKER-RACOR / prefiltra PARKER-RACOR	OM501LA	375	510	02/05	>	12/08		S 4121 NR		
power steering / servosterzo	OM501LA	375	510	02/05	>	12/08				S 3081 PO
2654	OM502LA	395	537	04/03	>	12/08	S 5006 PE	S 6001 NE	S 7639 A	S 3072 C
with activated carbon air-conditioner / con climatizzatore, ai carboni attivi	OM502LA	395	537	04/03	>	12/08			S 3373 A	S 4225 CA
with panel air filter / con filtro aria a pannello	OM502LA	395	537	04/03	>	12/08				
with manual pump prefilter / con pompa manuale prefiltra	OM502LA	395	537	04/03	>	12/08		S 6089 NE		
dryer filter / filtro essiccatore	OM502LA	395	537	04/03	>	12/08				S 7259 A
power steering / servosterzo	OM502LA	395	537	04/03	>	12/08				S 3081 PO
2655 Blue Tec 4+5	OM502LA	405	551	07/05	>	12/08	S 5006 PE	S 6001 NE		S 3072 C
some AdBlue 145 l. / alcuni AdBlue 145 l.	OM502LA	405	551	07/05	>	12/08			S 7213 A	
with activated carbon air-conditioner / con climatizzatore, ai carboni attivi	OM502LA	405	551	07/05	>	12/08				S 4225 CA
with manual pump prefilter / con pompa manuale prefiltra	OM502LA	405	551	07/05	>	12/08		S 6089 NE		
dryer filter / filtro essiccatore	OM502LA	405	551	07/05	>	12/08				S 7259 A
assembly KNECHT-MAHLE / montaggio KNECHT-MAHLE	OM502LA	405	551	07/05	>	12/08			S 7639 A	
assembly MANN-HUMMEL / montaggio MANN-HUMMEL	OM502LA	405	551	07/05	>	12/08			S 7A12 A	
prefilter PARKER-RACOR / prefiltra PARKER-RACOR	OM502LA	405	551	07/05	>	12/08		S 4121 NR		
power steering / servosterzo	OM502LA	405	551	07/05	>	12/08				S 3081 PO
variation 2 filters / variante N.2 filtri	OM502LA	405	551	07/05	>	12/08			S 7A12 A	
2658	OM502LA	425	578	04/03	>	12/08	S 5006 PE	S 6001 NE	S 7639 A	S 3072 C
with activated carbon air-conditioner / con climatizzatore, ai carboni attivi	OM502LA	425	578	04/03	>	12/08			S 3373 A	S 4225 CA
with panel air filter / con filtro aria a pannello	OM502LA	425	578	04/03	>	12/08				
with manual pump prefilter / con pompa manuale prefiltra	OM502LA	425	578	04/03	>	12/08		S 6089 NE		
dryer filter / filtro essiccatore	OM502LA	425	578	04/03	>	12/08				S 7259 A
power steering / servosterzo	OM502LA	425	578	04/03	>	12/08				S 3081 PO
variation 2 filters / variante N.2 filtri	OM502LA	425	578	09/03	>	12/08			S 7A12 A	
2660 Blue Tec 4+5	OM502LA	440	598	09/06	>	12/08	S 5006 PE	S 6001 NE		S 3072 C
some AdBlue 145 l. / alcuni AdBlue 145 l.	OM502LA	440	598	09/06	>	12/08			S 7213 A	
with activated carbon air-conditioner / con climatizzatore, ai carboni attivi	OM502LA	440	598	09/06	>	12/08				S 4225 CA
with manual pump prefilter / con pompa manuale prefiltra	OM502LA	440	598	09/06	>	12/08		S 6089 NE		
dryer filter / filtro essiccatore	OM502LA	440	598	09/06	>	12/08				S 7259 A
assembly KNECHT-MAHLE / montaggio KNECHT-MAHLE	OM502LA	440	598	09/06	>	12/08			S 7639 A	
assembly MANN-HUMMEL / montaggio MANN-HUMMEL	OM502LA	440	598	09/06	>	12/08			S 7A12 A	
prefilter PARKER-RACOR / prefiltra PARKER-RACOR	OM502LA	440	598	09/06	>	12/08		S 4121 NR		
power steering / servosterzo	OM502LA	440	598	09/06	>	12/08				S 3081 PO
variation 2 filters / variante N.2 filtri	OM502LA	440	598	09/06	>	12/08			S 7A12 A	
3232	OM501LA	235	320	04/03	>	12/08	S 5006 PE	S 6001 NE	S 7639 A	S 3072 C
with activated carbon air-conditioner / con climatizzatore, ai carboni attivi	OM501LA	235	320	04/03	>	12/08			S 3373 A	S 4225 CA
with panel air filter / con filtro aria a pannello	OM501LA	235	320	04/03	>	12/08				
with manual pump prefilter / con pompa manuale prefiltra	OM501LA	235	320	04/03	>	12/08		S 6089 NE		
dryer filter / filtro essiccatore	OM501LA	235	320	04/03	>	12/08				S 7259 A
power steering / servosterzo	OM501LA	235	320	04/03	>	12/08				S 3081 PO
variation 2 filters / variante N.2 filtri	OM501LA	235	320	09/03	>	12/08			S 7A12 A	
3236	OM501LA	265	360	04/03	>	12/08	S 5006 PE	S 6001 NE	S 7639 A	S 3072 C
with activated carbon air-conditioner / con climatizzatore, ai carboni attivi	OM501LA	265	360	04/03	>	12/08			S 3373 A	S 4225 CA
with panel air filter / con filtro aria a pannello	OM501LA	265	360	04/03	>	12/08				
with manual pump prefilter / con pompa manuale prefiltra	OM501LA	265	360	04/03	>	12/08		S 6089 NE		
dryer filter / filtro essiccatore	OM501LA	265	360	04/03	>	12/08				S 7259 A
power steering / servosterzo	OM501LA	265	360	04/03	>	12/08				S 3081 PO
variation 2 filters / variante N.2 filtri	OM501LA	265	360	09/03	>	12/08			S 7A12 A	
3241	OM501LA	300	409	04/03	>	12/08	S 5006 PE	S 6001 NE	S 7639 A	S 3072 C
with activated carbon air-conditioner / con climatizzatore, ai carboni attivi	OM501LA	300	409	04/03	>	12/08			S 3373 A	S 4225 CA
with panel air filter / con filtro aria a pannello	OM501LA	300	409	04/03	>	12/08				
with manual pump prefilter / con pompa manuale prefiltra	OM501LA	300	409	04/03	>	12/08		S 6089 NE		
dryer filter / filtro essiccatore	OM501LA	300	409	04/03	>	12/08				S 7259 A
power steering / servosterzo	OM501LA	300	409	04/03	>	12/08				S 3081 PO
variation 2 filters / variante N.2 filtri	OM501LA	300	409	09/03	>	12/08			S 7A12 A	
3244	OM501LA	320	435	04/03	>	12/08	S 5006 PE	S 6001 NE	S 7639 A	S 3072 C
with activated carbon air-conditioner / con climatizzatore, ai carboni attivi	OM501LA	320	435	04/03	>	12/08			S 3373 A	S 4225 CA
with panel air filter / con filtro aria a pannello	OM501LA	320	435	04/03	>	12/08				
with manual pump prefilter / con pompa manuale prefiltra	OM501LA	320	435	04/03	>	12/08		S 6089 NE		
dryer filter / filtro essiccatore	OM501LA	320	435	04/03	>	12/08				S 7259 A
power steering / servosterzo	OM501LA	320	435	04/03	>	12/08				S 3081 PO
variation 2 filters / variante N.2 filtri	OM501LA	320	435	09/03	>	12/08			S 7A12 A	
3246	OM501LA	335	456	04/03	>	12/08	S 5006 PE	S 6001 NE	S 7639 A	S 3072 C
with activated carbon air-conditioner / con climatizzatore, ai carboni attivi	OM501LA	335	456	04/03	>	12/08				S 4225 CA

M



KW HP



...MERCEDES BENZ - trucks/autocarri

M



with panel air filter / con filtro aria a pannello	OM501LA	335	456	04/03	>	12/08			S 3373 A	
with manual pump prefilter / con pompa manuale prefiltra	OM501LA	335	456	04/03	>	12/08		S 6089 NE		
dryer filter / filtro essiccatore	OM501LA	335	456	04/03	>	12/08				S 7259 A
power steering / servosterzo	OM501LA	335	456	04/03	>	12/08				S 3081 PO
variation 2 filters / variante N.2 filtri	OM501LA	335	456	09/03	>	12/08			S 7A12 A	
3248	OM501LA	350	476	04/03	>	12/08	S 5006 PE	S 6001 NE	S 7639 A	S 3072 C
with activated carbon air-conditioner / con climatizzatore, ai carboni attivi	OM501LA	350	476	04/03	>	12/08			S 3373 A	S 4225 CA
with panel air filter / con filtro aria a pannello	OM501LA	350	476	04/03	>	12/08				
with manual pump prefilter / con pompa manuale prefiltra	OM501LA	350	476	04/03	>	12/08		S 6089 NE		
dryer filter / filtro essiccatore	OM501LA	350	476	04/03	>	12/08				S 7259 A
power steering / servosterzo	OM501LA	350	476	04/03	>	12/08				S 3081 PO
3248 Blue Tec 4+5	OM501LA	350	476	02/05	>	12/08	S 5006 PE	S 6001 NE		S 3072 C
some AdBlue 145 l. / alcuni AdBlue 145 l.	OM501LA	350	476	02/05	>	12/08			S 7213 A	
with activated carbon air-conditioner / con climatizzatore, ai carboni attivi	OM501LA	350	476	02/05	>	12/08				S 4225 CA
with manual pump prefilter / con pompa manuale prefiltra	OM501LA	350	476	02/05	>	12/08		S 6089 NE		
dryer filter / filtro essiccatore	OM501LA	350	476	02/05	>	12/08				S 7259 A
assembly KNECHT-MAHLE / montaggio KNECHT-MAHLE	OM501LA	350	476	02/05	>	12/08			S 7639 A	
assembly MANN-HUMMEL / montaggio MANN-HUMMEL	OM501LA	350	476	02/05	>	12/08			S 7A12 A	
prefilter PARKER-RACOR / prefiltra PARKER-RACOR	OM501LA	350	476	02/05	>	12/08		S 4121 NR		
power steering / servosterzo	OM501LA	350	476	02/05	>	12/08				S 3081 PO
variation 2 filters / variante N.2 filtri	OM501LA	350	476	02/05	>	12/08			S 7A12 A	
3250	OM502LA	370	503	04/03	>	12/08	S 5006 PE	S 6001 NE	S 7639 A	S 3072 C
with activated carbon air-conditioner / con climatizzatore, ai carboni attivi	OM502LA	370	503	04/03	>	12/08			S 3373 A	S 4225 CA
with panel air filter / con filtro aria a pannello	OM502LA	370	503	04/03	>	12/08				
with manual pump prefilter / con pompa manuale prefiltra	OM502LA	370	503	04/03	>	12/08		S 6089 NE		
dryer filter / filtro essiccatore	OM502LA	370	503	04/03	>	12/08				S 7259 A
power steering / servosterzo	OM502LA	370	503	04/03	>	12/08				S 3081 PO
variation 2 filters / variante N.2 filtri	OM502LA	370	503	09/03	>	12/08			S 7A12 A	
3331	OM501LA	230	313	04/03	>	12/08	S 5006 PE	S 6001 NE	S 7639 A	S 3072 C
with activated carbon air-conditioner / con climatizzatore, ai carboni attivi	OM501LA	230	313	04/03	>	12/08			S 3373 A	S 4225 CA
with panel air filter / con filtro aria a pannello	OM501LA	230	313	04/03	>	12/08				
with manual pump prefilter / con pompa manuale prefiltra	OM501LA	230	313	04/03	>	12/08		S 6089 NE		
dryer filter / filtro essiccatore	OM501LA	230	313	04/03	>	12/08				S 7259 A
power steering / servosterzo	OM501LA	230	313	04/03	>	12/08				S 3081 PO
variation 2 filters / variante N.2 filtri	OM501LA	230	313	09/03	>	12/08			S 7A12 A	
3332	OM501LA	235	320	04/03	>	12/08	S 5006 PE	S 6001 NE	S 7639 A	S 3072 C
with activated carbon air-conditioner / con climatizzatore, ai carboni attivi	OM501LA	235	320	04/03	>	12/08			S 3373 A	S 4225 CA
with panel air filter / con filtro aria a pannello	OM501LA	235	320	04/03	>	12/08				
with manual pump prefilter / con pompa manuale prefiltra	OM501LA	235	320	04/03	>	12/08		S 6089 NE		
dryer filter / filtro essiccatore	OM501LA	235	320	04/03	>	12/08				S 7259 A
power steering / servosterzo	OM501LA	235	320	04/03	>	12/08				S 3081 PO
variation 2 filters / variante N.2 filtri	OM501LA	235	320	09/03	>	12/08			S 7A12 A	
3336	OM501LA	265	360	04/03	>	12/08	S 5006 PE	S 6001 NE	S 7639 A	S 3072 C
with activated carbon air-conditioner / con climatizzatore, ai carboni attivi	OM501LA	265	360	04/03	>	12/08			S 3373 A	S 4225 CA
with panel air filter / con filtro aria a pannello	OM501LA	265	360	04/03	>	12/08				
with manual pump prefilter / con pompa manuale prefiltra	OM501LA	265	360	04/03	>	12/08		S 6089 NE		
dryer filter / filtro essiccatore	OM501LA	265	360	04/03	>	12/08				S 7259 A
power steering / servosterzo	OM501LA	265	360	04/03	>	12/08				S 3081 PO
variation 2 filters / variante N.2 filtri	OM501LA	265	360	09/03	>	12/08			S 7A12 A	
3341	OM501LA	300	409	04/03	>	12/08	S 5006 PE	S 6001 NE	S 7639 A	S 3072 C
with activated carbon air-conditioner / con climatizzatore, ai carboni attivi	OM501LA	300	409	04/03	>	12/08			S 3373 A	S 4225 CA
with panel air filter / con filtro aria a pannello	OM501LA	300	409	04/03	>	12/08				
with manual pump prefilter / con pompa manuale prefiltra	OM501LA	300	409	04/03	>	12/08		S 6089 NE		
dryer filter / filtro essiccatore	OM501LA	300	409	04/03	>	12/08				S 7259 A
power steering / servosterzo	OM501LA	300	409	04/03	>	12/08				S 3081 PO
3344	OM501LA	320	435	04/03	>	12/08	S 5006 PE	S 6001 NE	S 7639 A	S 3072 C
with activated carbon air-conditioner / con climatizzatore, ai carboni attivi	OM501LA	320	435	04/03	>	12/08			S 3373 A	S 4225 CA
with panel air filter / con filtro aria a pannello	OM501LA	320	435	04/03	>	12/08				
with manual pump prefilter / con pompa manuale prefiltra	OM501LA	320	435	04/03	>	12/08		S 6089 NE		
dryer filter / filtro essiccatore	OM501LA	320	435	04/03	>	12/08				S 7259 A
power steering / servosterzo	OM501LA	320	435	04/03	>	12/08				S 3081 PO
variation 2 filters / variante N.2 filtri	OM501LA	320	435	09/03	>	12/08			S 7A12 A	
3346	OM501LA	335	456	04/03	>	12/08	S 5006 PE	S 6001 NE	S 7639 A	S 3072 C
spin-on / avvitabile	OM501LA	335	456	09/03	>	12/08			S 7A12 A	
with activated carbon air-conditioner / con climatizzatore, ai carboni attivi	OM501LA	335	456	04/03	>	12/08				S 4225 CA
with panel air filter / con filtro aria a pannello	OM501LA	335	456	04/03	>	12/08			S 3373 A	
with manual pump prefilter / con pompa manuale prefiltra	OM501LA	335	456	04/03	>	12/08		S 6089 NE		

**KW HP****...MERCEDES BENZ - trucks/autocarri**

dryer filter / filtro essiccatore	OM501LA	335	456	04/03	>	12/08				S 7259 A
power steering / servosterzo	OM501LA	335	456	04/03	>	12/08				S 3081 PO
3348	OM501LA	350	476	04/03	>	12/08	S 5006 PE	S 6001 NE	S 7639 A	S 3072 C
with activated carbon air-conditioner / con climatizzatore, ai carboni attivi	OM501LA	350	476	04/03	>	12/08				S 4225 CA
with panel air filter / con filtro aria a pannello	OM501LA	350	476	04/03	>	12/08			S 3373 A	
with manual pump prefilter / con pompa manuale prefiltra	OM501LA	350	476	04/03	>	12/08		S 6089 NE		
dryer filter / filtro essiccatore	OM501LA	350	476	04/03	>	12/08				S 7259 A
power steering / servosterzo	OM501LA	350	476	04/03	>	12/08				S 3081 PO
3348 Blue Tec 4+5	OM501LA	350	476	02/05	>	12/08	S 5006 PE	S 6001 NE		S 3072 C
some AdBlue 145 l. / alcuni AdBlue 145 l.	OM501LA	350	476	02/05	>	12/08			S 7213 A	
with activated carbon air-conditioner / con climatizzatore, ai carboni attivi	OM501LA	350	476	02/05	>	12/08				S 4225 CA
with manual pump prefilter / con pompa manuale prefiltra	OM501LA	350	476	02/05	>	12/08		S 6089 NE		
dryer filter / filtro essiccatore	OM501LA	350	476	02/05	>	12/08				S 7259 A
assembly KNECHT-MAHLE / montaggio KNECHT-MAHLE	OM501LA	350	476	02/05	>	12/08			S 7639 A	
assembly MANN-HUMMEL / montaggio MANN-HUMMEL	OM501LA	350	476	02/05	>	12/08			S 7A12 A	
prefilter PARKER-RACOR / prefiltra PARKER-RACOR	OM501LA	350	476	02/05	>	12/08		S 4121 NR		
power steering / servosterzo	OM501LA	350	476	02/05	>	12/08				S 3081 PO
variation 2 filters / variante N.2 filtri	OM501LA	350	476	02/05	>	12/08			S 7A12 A	
3350	OM502LA	370	503	04/03	>	12/08	S 5006 PE	S 6001 NE	S 7639 A	S 3072 C
with activated carbon air-conditioner / con climatizzatore, ai carboni attivi	OM502LA	370	503	04/03	>	12/08				S 4225 CA
with panel air filter / con filtro aria a pannello	OM502LA	370	503	04/03	>	12/08			S 3373 A	
with manual pump prefilter / con pompa manuale prefiltra	OM502LA	370	503	04/03	>	12/08		S 6089 NE		
dryer filter / filtro essiccatore	OM502LA	370	503	04/03	>	12/08				S 7259 A
power steering / servosterzo	OM502LA	370	503	04/03	>	12/08				S 3081 PO
variation 2 filters / variante N.2 filtri	OM502LA	370	503	09/03	>	12/08			S 7A12 A	
3351	OM501LA	375	510	04/03	>	12/08	S 5006 PE	S 6001 NE	S 7639 A	S 3072 C
with activated carbon air-conditioner / con climatizzatore, ai carboni attivi	OM501LA	375	510	04/03	>	12/08				S 4225 CA
with panel air filter / con filtro aria a pannello	OM501LA	375	510	04/03	>	12/08			S 3373 A	
with manual pump prefilter / con pompa manuale prefiltra	OM501LA	375	510	04/03	>	12/08		S 6089 NE		
dryer filter / filtro essiccatore	OM501LA	375	510	04/03	>	12/08				S 7259 A
power steering / servosterzo	OM501LA	375	510	04/03	>	12/08				S 3081 PO
variation 2 filters / variante N.2 filtri	OM501LA	375	510	09/03	>	12/08			S 7A12 A	
3354	OM502LA	395	537	04/03	>	12/08	S 5006 PE	S 6001 NE	S 7639 A	S 3072 C
with activated carbon air-conditioner / con climatizzatore, ai carboni attivi	OM502LA	395	537	04/03	>	12/08				S 4225 CA
with panel air filter / con filtro aria a pannello	OM502LA	395	537	04/03	>	12/08			S 3373 A	
with manual pump prefilter / con pompa manuale prefiltra	OM502LA	395	537	04/03	>	12/08		S 6089 NE		
dryer filter / filtro essiccatore	OM502LA	395	537	04/03	>	12/08				S 7259 A
power steering / servosterzo	OM502LA	395	537	04/03	>	12/08				S 3081 PO
variation 2 filters / variante N.2 filtri	OM502LA	395	537	09/03	>	12/08			S 7A12 A	
3355 Blue Tec 4+5	OM502LA	405	551	07/05	>	12/08	S 5006 PE	S 6001 NE		S 3072 C
some AdBlue 145 l. / alcuni AdBlue 145 l.	OM502LA	405	551	07/05	>	12/08			S 7213 A	
with activated carbon air-conditioner / con climatizzatore, ai carboni attivi	OM502LA	405	551	07/05	>	12/08				S 4225 CA
with manual pump prefilter / con pompa manuale prefiltra	OM502LA	405	551	07/05	>	12/08		S 6089 NE		
dryer filter / filtro essiccatore	OM502LA	405	551	07/05	>	12/08				S 7259 A
assembly KNECHT-MAHLE / montaggio KNECHT-MAHLE	OM502LA	405	551	07/05	>	12/08			S 7639 A	
assembly MANN-HUMMEL / montaggio MANN-HUMMEL	OM502LA	405	551	07/05	>	12/08			S 7A12 A	
prefilter PARKER-RACOR / prefiltra PARKER-RACOR	OM502LA	405	551	07/05	>	12/08		S 4121 NR		
power steering / servosterzo	OM502LA	405	551	07/05	>	12/08				S 3081 PO
variation 2 filters / variante N.2 filtri	OM502LA	405	551	07/05	>	12/08			S 7A12 A	
3358	OM502LA	425	578	04/03	>	12/08	S 5006 PE	S 6001 NE	S 7639 A	S 3072 C
with activated carbon air-conditioner / con climatizzatore, ai carboni attivi	OM502LA	425	578	04/03	>	12/08				S 4225 CA
with panel air filter / con filtro aria a pannello	OM502LA	425	578	04/03	>	12/08			S 3373 A	
with manual pump prefilter / con pompa manuale prefiltra	OM502LA	425	578	04/03	>	12/08		S 6089 NE		
dryer filter / filtro essiccatore	OM502LA	425	578	04/03	>	12/08				S 7259 A
power steering / servosterzo	OM502LA	425	578	04/03	>	12/08				S 3081 PO
variation 2 filters / variante N.2 filtri	OM502LA	425	578	09/03	>	12/08			S 7A12 A	
3360 Blue Tec 4+5	OM502LA	440	598	07/05	>	12/08	S 5006 PE	S 6001 NE		S 3072 C
some AdBlue 145 l. / alcuni AdBlue 145 l.	OM502LA	440	598	07/05	>	12/08			S 7213 A	
with activated carbon air-conditioner / con climatizzatore, ai carboni attivi	OM502LA	440	598	07/05	>	12/08				S 4225 CA
with manual pump prefilter / con pompa manuale prefiltra	OM502LA	440	598	07/05	>	12/08		S 6089 NE		
dryer filter / filtro essiccatore	OM502LA	440	598	07/05	>	12/08				S 7259 A
assembly KNECHT-MAHLE / montaggio KNECHT-MAHLE	OM502LA	440	598	07/05	>	12/08			S 7639 A	
assembly MANN-HUMMEL / montaggio MANN-HUMMEL	OM502LA	440	598	07/05	>	12/08			S 7A12 A	
prefilter PARKER-RACOR / prefiltra PARKER-RACOR	OM502LA	440	598	07/05	>	12/08		S 4121 NR		
power steering / servosterzo	OM502LA	440	598	07/05	>	12/08				S 3081 PO
variation 2 filters / variante N.2 filtri	OM502LA	440	598	07/05	>	12/08			S 7A12 A	
4141 K/AK	OM501LA	300	409	04/03	>	12/08	S 5006 PE	S 6001 NE	S 7639 A	S 3221 C

M



...MERCEDES BENZ - trucks/autocarri

M

with activated carbon air-conditioner / con climatizzatore, ai carboni attivi	OM501LA	300	409	04/03	>	12/08			S 3373 A	S 4225 CA
with panel air filter / con filtro aria a pannello	OM501LA	300	409	04/03	>	12/08				
with manual pump prefilter / con pompa manuale prefiltra	OM501LA	300	409	04/03	>	12/08		S 6089 NE		
dryer filter / filtro essiccatore	OM501LA	300	409	04/03	>	12/08				S 7259 A
power steering / servosterzo	OM501LA	300	409	04/03	>	12/08				S 3081 PO
variation 2 filters / variante N.2 filtri	OM501LA	300	409	09/03	>	12/08			S 7A12 A	
variation 2 filters (inner) / variante N.2 filtri (interno)	OM501LA	300	409	04/03	>	12/08			S 7649 A	
4144 K/AK	OM501LA	320	435	04/03	>	12/08	S 5006 PE	S 6001 NE	S 7639 A	S 3221 C
with activated carbon air-conditioner / con climatizzatore, ai carboni attivi	OM501LA	320	435	04/03	>	12/08				S 4225 CA
with panel air filter / con filtro aria a pannello	OM501LA	320	435	04/03	>	12/08			S 3373 A	
with manual pump prefilter / con pompa manuale prefiltra	OM501LA	320	435	04/03	>	12/08		S 6089 NE		
dryer filter / filtro essiccatore	OM501LA	320	435	04/03	>	12/08				S 7259 A
power steering / servosterzo	OM501LA	320	435	04/03	>	12/08				S 3081 PO
variation 2 filters / variante N.2 filtri	OM501LA	320	435	09/03	>	12/08			S 7A12 A	
variation 2 filters (inner) / variante N.2 filtri (interno)	OM501LA	320	435	04/03	>	12/08			S 7649 A	
4146 K/AK	OM501LA	335	456	04/03	>	12/08	S 5006 PE	S 6001 NE	S 7639 A	S 3221 C
with activated carbon air-conditioner / con climatizzatore, ai carboni attivi	OM501LA	335	456	04/03	>	12/08				S 4225 CA
with panel air filter / con filtro aria a pannello	OM501LA	335	456	04/03	>	12/08			S 3373 A	
with manual pump prefilter / con pompa manuale prefiltra	OM501LA	335	456	04/03	>	12/08		S 6089 NE		
dryer filter / filtro essiccatore	OM501LA	335	456	04/03	>	12/08				S 7259 A
prefilter PARKER-RACOR / prefiltra PARKER-RACOR	OM501LA	335	456	04/03	>	12/08		S 4121 NR		
power steering / servosterzo	OM501LA	335	456	04/03	>	12/08				S 3081 PO
variation 2 filters / variante N.2 filtri	OM501LA	335	456	09/03	>	12/08			S 7A12 A	
variation 2 filters (inner) / variante N.2 filtri (interno)	OM501LA	335	456	04/03	>	12/08			S 7649 A	
4148	OM501LA	350	476	04/03	>	12/08	S 5006 PE	S 6001 NE		S 3072 C
with activated carbon air-conditioner / con climatizzatore, ai carboni attivi	OM501LA	350	476	04/03	>	12/08				S 4225 CA
with panel air filter / con filtro aria a pannello	OM501LA	350	476	04/03	>	12/08			S 3373 A	
with manual pump prefilter / con pompa manuale prefiltra	OM501LA	350	476	04/03	>	12/08		S 6089 NE		
dryer filter / filtro essiccatore	OM501LA	350	476	04/03	>	12/08				S 7259 A
assembly KNECHT-MAHLE / montaggio KNECHT-MAHLE	OM501LA	350	476	04/03	>	12/08			S 7639 A	
assembly MANN+HUMMEL / montaggio MANN+HUMMEL	OM501LA	350	476	04/03	>	12/08			S 7A12 A	
prefilter PARKER-RACOR / prefiltra PARKER-RACOR	OM501LA	350	476	04/03	>	12/08		S 4121 NR		
power steering / servosterzo	OM501LA	350	476	04/03	>	12/08				S 3081 PO
variation 2 filters / variante N.2 filtri	OM501LA	350	476	09/03	>	12/08			S 7A12 A	
variation 2 filters (inner) / variante N.2 filtri (interno)	OM501LA	350	476	04/03	>	12/08			S 7649 A	
4148 Blue Tec 4+5	OM541LA	350	476	02/05	>	12/08	S 5006 PE	S 6001 NE		S 3072 C
some AdBlue 145 l. / alcuni AdBlue 145 l.	OM541LA	350	476	02/05	>	12/08			S 7213 A	
with activated carbon air-conditioner / con climatizzatore, ai carboni attivi	OM541LA	350	476	02/05	>	12/08				S 4225 CA
with manual pump prefilter / con pompa manuale prefiltra	OM541LA	350	476	02/05	>	12/08		S 6089 NE		
dryer filter / filtro essiccatore	OM541LA	350	476	02/05	>	12/08				S 7259 A
assembly KNECHT-MAHLE / montaggio KNECHT-MAHLE	OM541LA	350	476	02/05	>	12/08			S 7639 A	
assembly MANN+HUMMEL / montaggio MANN+HUMMEL	OM541LA	350	476	02/05	>	12/08			S 7A12 A	
prefilter PARKER-RACOR / prefiltra PARKER-RACOR	OM541LA	350	476	02/05	>	12/08		S 4121 NR		
power steering / servosterzo	OM541LA	350	476	02/05	>	12/08				S 3081 PO
4150 K/AK	OM502LA	370	503	04/03	>	12/08	S 5006 PE	S 6001 NE	S 7639 A	S 3221 C
with activated carbon air-conditioner / con climatizzatore, ai carboni attivi	OM502LA	370	503	04/03	>	12/08				S 4225 CA
with panel air filter / con filtro aria a pannello	OM502LA	370	503	04/03	>	12/08			S 3373 A	
with manual pump prefilter / con pompa manuale prefiltra	OM502LA	370	503	04/03	>	12/08		S 6089 NE		
dryer filter / filtro essiccatore	OM502LA	370	503	04/03	>	12/08				S 7259 A
prefilter PARKER-RACOR / prefiltra PARKER-RACOR	OM502LA	370	503	04/03	>	12/08		S 4121 NR		
power steering / servosterzo	OM502LA	370	503	04/03	>	12/08				S 3081 PO
variation 2 filters / variante N.2 filtri	OM502LA	370	503	09/03	>	12/08			S 7A12 A	
variation 2 filters (inner) / variante N.2 filtri (interno)	OM502LA	370	503	04/03	>	12/08			S 7649 A	
4154 K/AK	OM502LA	395	537	10/03	>	11/08	S 5006 PE	S 6001 NE	S 7639 A	S 3221 C
with activated carbon air-conditioner / con climatizzatore, ai carboni attivi	OM502LA	395	537	10/03	>	11/08				S 4225 CA
with panel air filter / con filtro aria a pannello	OM502LA	395	537	10/03	>	11/08			S 3373 A	
with manual pump prefilter / con pompa manuale prefiltra	OM502LA	395	537	10/03	>	12/08		S 6089 NE		
dryer filter / filtro essiccatore	OM502LA	395	537	10/03	>	11/08				S 7259 A
prefilter PARKER-RACOR / prefiltra PARKER-RACOR	OM502LA	395	537	10/03	>	11/08		S 4121 NR		
power steering / servosterzo	OM502LA	395	537	10/03	>	11/08				S 3081 PO
variation 2 filters / variante N.2 filtri	OM502LA	395	537	10/03	>	11/08			S 7A12 A	
variation 2 filters (inner) / variante N.2 filtri (interno)	OM502LA	395	537	10/03	>	12/08			S 7649 A	
Actros III MP3										
1832 BlueTec 4+5	OM501LA	235	320	09/08	>		S 5006 PE	S 6001 NE		S 3072 C
some AdBlue 145 l. / alcuni AdBlue 145 l.	OM501LA	235	320	09/08	>				S 7213 A	
dryer filter / filtro essiccatore	OM501LA	235	320	09/08	>					S 7A66 A
assembly KNECHT-MAHLE / montaggio KNECHT-MAHLE	OM501LA	235	320	09/08	>				S 7639 A	



...MERCEDES BENZ - trucks/autocarri

assembly MANN+HUMMEL / montaggio MANN+HUMMEL	OM501LA	235	320	09/08	>			S 7A12 A	
prefilter PARKER-RACOR / prefiltro PARKER-RACOR	OM501LA	235	320	09/08	>		S 4121 NR		
power steering / servosterzo	OM501LA	235	320	09/08	>				S 3081 PO
1836 BlueTec 4+5	OM501LA	265	360	09/08	>	S 5006 PE	S 6001 NE		S 3072 C
some AdBlue 145 l. / alcuni AdBlue 145 l.	OM501LA	265	360	09/08	>			S 7213 A	
dryer filter / filtro essiccatore	OM501LA	265	360	09/08	>				S 7A66 A
assembly KNECHT-MAHLE / montaggio KNECHT-MAHLE	OM501LA	265	360	09/08	>			S 7639 A	
assembly MANN+HUMMEL / montaggio MANN+HUMMEL	OM501LA	265	360	09/08	>			S 7A12 A	
prefilter PARKER-RACOR / prefiltro PARKER-RACOR	OM501LA	265	360	09/08	>		S 4121 NR		
power steering / servosterzo	OM501LA	265	360	09/08	>				S 3081 PO
1841 BlueTec 4+5	OM501LA	300	408	09/08	>	S 5006 PE	S 6001 NE		S 3072 C
some AdBlue 145 l. / alcuni AdBlue 145 l.	OM501LA	300	408	09/08	>			S 7213 A	
dryer filter / filtro essiccatore	OM501LA	300	408	09/08	>				S 7A66 A
assembly KNECHT-MAHLE / montaggio KNECHT-MAHLE	OM501LA	300	408	09/08	>			S 7639 A	
assembly MANN+HUMMEL / montaggio MANN+HUMMEL	OM501LA	300	408	09/08	>			S 7A12 A	
prefilter PARKER-RACOR / prefiltro PARKER-RACOR	OM501LA	300	408	09/08	>		S 4121 NR		
power steering / servosterzo	OM501LA	300	408	09/08	>				S 3081 PO
1844 BlueTec 4+5	OM501LA	320	435	09/08	>	S 5006 PE	S 6001 NE		S 3072 C
some AdBlue 145 l. / alcuni AdBlue 145 l.	OM501LA	320	435	09/08	>			S 7213 A	
dryer filter / filtro essiccatore	OM501LA	320	435	09/08	>				S 7A66 A
assembly KNECHT-MAHLE / montaggio KNECHT-MAHLE	OM501LA	320	435	09/08	>			S 7639 A	
assembly MANN+HUMMEL / montaggio MANN+HUMMEL	OM501LA	320	435	09/08	>			S 7A12 A	
prefilter PARKER-RACOR / prefiltro PARKER-RACOR	OM501LA	320	435	09/08	>		S 4121 NR		
power steering / servosterzo	OM501LA	320	435	09/08	>				S 3081 PO
1846 BlueTec 4+5	OM501LA	335	456	09/08	>	S 5006 PE	S 6001 NE		S 3072 C
some AdBlue 145 l. / alcuni AdBlue 145 l.	OM501LA	335	456	09/08	>			S 7213 A	
dryer filter / filtro essiccatore	OM501LA	335	456	09/08	>				S 7A66 A
assembly KNECHT-MAHLE / montaggio KNECHT-MAHLE	OM501LA	335	456	09/08	>			S 7639 A	
assembly MANN+HUMMEL / montaggio MANN+HUMMEL	OM501LA	335	456	09/08	>			S 7A12 A	
prefilter PARKER-RACOR / prefiltro PARKER-RACOR	OM501LA	335	456	09/08	>		S 4121 NR		
power steering / servosterzo	OM501LA	335	456	09/08	>				S 3081 PO
1848 BlueTec 4+5	OM501LA	350	476	09/08	>	S 5006 PE	S 6001 NE		S 3072 C
some AdBlue 145 l. / alcuni AdBlue 145 l.	OM501LA	350	476	09/08	>			S 7213 A	
dryer filter / filtro essiccatore	OM501LA	350	476	09/08	>				S 7A66 A
assembly KNECHT-MAHLE / montaggio KNECHT-MAHLE	OM501LA	350	476	09/08	>			S 7639 A	
assembly MANN+HUMMEL / montaggio MANN+HUMMEL	OM501LA	350	476	09/08	>			S 7A12 A	
prefilter PARKER-RACOR / prefiltro PARKER-RACOR	OM501LA	350	476	09/08	>		S 4121 NR		
power steering / servosterzo	OM501LA	350	476	09/08	>				S 3081 PO
1851 BlueTec 4+5	OM502LA	375	510	09/08	>	S 5006 PE	S 6001 NE		S 3072 C
dryer filter / filtro essiccatore	OM502LA	375	510	09/08	>				S 7A66 A
assembly KNECHT-MAHLE / montaggio KNECHT-MAHLE	OM502LA	375	510	09/08	>			S 7639 A	
assembly MANN+HUMMEL / montaggio MANN+HUMMEL	OM502LA	375	510	09/08	>			S 7A12 A	
prefilter PARKER-RACOR / prefiltro PARKER-RACOR	OM502LA	375	510	09/08	>		S 4121 NR		
power steering / servosterzo	OM502LA	375	510	09/08	>				S 3081 PO
1855 BlueTec 4+5	OM502LA	405	551	09/08	>	S 5006 PE	S 6001 NE		S 3072 C
dryer filter / filtro essiccatore	OM502LA	405	551	09/08	>				S 7A66 A
assembly KNECHT-MAHLE / montaggio KNECHT-MAHLE	OM502LA	405	551	09/08	>			S 7639 A	
assembly MANN+HUMMEL / montaggio MANN+HUMMEL	OM502LA	405	551	09/08	>			S 7A12 A	
prefilter PARKER-RACOR / prefiltro PARKER-RACOR	OM502LA	405	551	09/08	>		S 4121 NR		
power steering / servosterzo	OM502LA	405	551	09/08	>				S 3081 PO
1860 BlueTec 4+5	OM502LA	440	598	09/08	>	S 5006 PE	S 6001 NE		S 3072 C
dryer filter / filtro essiccatore	OM502LA	440	598	09/08	>				S 7A66 A
assembly KNECHT-MAHLE / montaggio KNECHT-MAHLE	OM502LA	440	598	09/08	>			S 7639 A	
assembly MANN+HUMMEL / montaggio MANN+HUMMEL	OM502LA	440	598	09/08	>			S 7A12 A	
prefilter PARKER-RACOR / prefiltro PARKER-RACOR	OM502LA	440	598	09/08	>		S 4121 NR		
power steering / servosterzo	OM502LA	440	598	09/08	>				S 3081 PO
2032 BlueTec 4+5	OM501LA	235	320	09/08	>	S 5006 PE	S 6001 NE		S 3072 C
some AdBlue 145 l. / alcuni AdBlue 145 l.	OM501LA	235	320	09/08	>			S 7213 A	
dryer filter / filtro essiccatore	OM501LA	235	320	09/08	>				S 7A66 A
assembly KNECHT-MAHLE / montaggio KNECHT-MAHLE	OM501LA	235	320	09/08	>			S 7639 A	
assembly MANN+HUMMEL / montaggio MANN+HUMMEL	OM501LA	235	320	09/08	>			S 7A12 A	
prefilter PARKER-RACOR / prefiltro PARKER-RACOR	OM501LA	235	320	09/08	>		S 4121 NR		
power steering / servosterzo	OM501LA	235	320	09/08	>				S 3081 PO
2036 BlueTec 4+5	OM501LA	265	360	09/08	>	S 5006 PE	S 6001 NE		S 3072 C
some AdBlue 145 l. / alcuni AdBlue 145 l.	OM501LA	265	360	09/08	>			S 7213 A	
dryer filter / filtro essiccatore	OM501LA	265	360	09/08	>				S 7A66 A
assembly KNECHT-MAHLE / montaggio KNECHT-MAHLE	OM501LA	265	360	09/08	>			S 7639 A	

M



...MERCEDES BENZ - trucks/autocarri



assembly MANN+HUMMEL / montaggio MANN+HUMMEL	OM501LA	265	360	09/08	>			S 7A12 A	
prefilter PARKER-RACOR / prefiltro PARKER-RACOR	OM501LA	265	360	09/08	>		S 4121 NR		
power steering / servosterzo	OM501LA	265	360	09/08	>				S 3081 PO
2041 BlueTec 4+5	OM501LA	300	408	09/08	>	S 5006 PE	S 6001 NE		S 3072 C
some AdBlue 145 l. / alcuni AdBlue 145 l.	OM501LA	300	408	09/08	>			S 7213 A	
dryer filter / filtro essiccatore	OM501LA	300	408	09/08	>				S 7A66 A
assembly KNECHT-MAHLE / montaggio KNECHT-MAHLE	OM501LA	300	408	09/08	>			S 7639 A	
assembly MANN+HUMMEL / montaggio MANN+HUMMEL	OM501LA	300	408	09/08	>			S 7A12 A	
prefilter PARKER-RACOR / prefiltro PARKER-RACOR	OM501LA	300	408	09/08	>		S 4121 NR		
power steering / servosterzo	OM501LA	300	408	09/08	>				S 3081 PO
2044 BlueTec 4+5	OM501LA	320	435	09/08	>	S 5006 PE	S 6001 NE		S 3072 C
some AdBlue 145 l. / alcuni AdBlue 145 l.	OM501LA	320	435	09/08	>			S 7213 A	
dryer filter / filtro essiccatore	OM501LA	320	435	09/08	>				S 7A66 A
assembly KNECHT-MAHLE / montaggio KNECHT-MAHLE	OM501LA	320	435	09/08	>			S 7639 A	
assembly MANN+HUMMEL / montaggio MANN+HUMMEL	OM501LA	320	435	09/08	>			S 7A12 A	
prefilter PARKER-RACOR / prefiltro PARKER-RACOR	OM501LA	320	435	09/08	>		S 4121 NR		
power steering / servosterzo	OM501LA	320	435	09/08	>				S 3081 PO
2046 BlueTec 4+5	OM501LA	335	456	09/08	>	S 5006 PE	S 6001 NE		S 3072 C
some AdBlue 145 l. / alcuni AdBlue 145 l.	OM501LA	335	456	09/08	>			S 7213 A	
dryer filter / filtro essiccatore	OM501LA	335	456	09/08	>				S 7A66 A
assembly KNECHT-MAHLE / montaggio KNECHT-MAHLE	OM501LA	335	456	09/08	>			S 7639 A	
assembly MANN+HUMMEL / montaggio MANN+HUMMEL	OM501LA	335	456	09/08	>			S 7A12 A	
prefilter PARKER-RACOR / prefiltro PARKER-RACOR	OM501LA	335	456	09/08	>		S 4121 NR		
power steering / servosterzo	OM501LA	335	456	09/08	>				S 3081 PO
2048 BlueTec 4+5	OM501LA	350	476	09/08	>	S 5006 PE	S 6001 NE		S 3072 C
some AdBlue 145 l. / alcuni AdBlue 145 l.	OM501LA	350	476	09/08	>			S 7213 A	
dryer filter / filtro essiccatore	OM501LA	350	476	09/08	>				S 7A66 A
assembly KNECHT-MAHLE / montaggio KNECHT-MAHLE	OM501LA	350	476	09/08	>			S 7639 A	
assembly MANN+HUMMEL / montaggio MANN+HUMMEL	OM501LA	350	476	09/08	>			S 7A12 A	
prefilter PARKER-RACOR / prefiltro PARKER-RACOR	OM501LA	350	476	09/08	>		S 4121 NR		
power steering / servosterzo	OM501LA	350	476	09/08	>				S 3081 PO
2051 BlueTec 4+5	OM502LA	375	510	09/08	>	S 5006 PE	S 6001 NE		S 3072 C
dryer filter / filtro essiccatore	OM502LA	375	510	09/08	>				S 7A66 A
assembly KNECHT-MAHLE / montaggio KNECHT-MAHLE	OM502LA	375	510	09/08	>			S 7639 A	
assembly MANN+HUMMEL / montaggio MANN+HUMMEL	OM502LA	375	510	09/08	>			S 7A12 A	
prefilter PARKER-RACOR / prefiltro PARKER-RACOR	OM502LA	375	510	09/08	>		S 4121 NR		
power steering / servosterzo	OM502LA	375	510	09/08	>				S 3081 PO
2055 BlueTec 4+5	OM502LA	405	551	09/08	>	S 5006 PE	S 6001 NE		S 3072 C
dryer filter / filtro essiccatore	OM502LA	405	551	09/08	>				S 7A66 A
assembly KNECHT-MAHLE / montaggio KNECHT-MAHLE	OM502LA	405	551	09/08	>			S 7639 A	
assembly MANN+HUMMEL / montaggio MANN+HUMMEL	OM502LA	405	551	09/08	>			S 7A12 A	
prefilter PARKER-RACOR / prefiltro PARKER-RACOR	OM502LA	405	551	09/08	>		S 4121 NR		
power steering / servosterzo	OM502LA	405	551	09/08	>				S 3081 PO
2432 BlueTec 4+5	OM501LA	235	320	09/08	>	S 5006 PE	S 6001 NE		S 3072 C
some AdBlue 145 l. / alcuni AdBlue 145 l.	OM501LA	235	320	09/08	>			S 7213 A	
dryer filter / filtro essiccatore	OM501LA	235	320	09/08	>				S 7A66 A
assembly KNECHT-MAHLE / montaggio KNECHT-MAHLE	OM501LA	235	320	09/08	>			S 7639 A	
assembly MANN+HUMMEL / montaggio MANN+HUMMEL	OM501LA	235	320	09/08	>			S 7A12 A	
prefilter PARKER-RACOR / prefiltro PARKER-RACOR	OM501LA	235	320	09/08	>		S 4121 NR		
power steering / servosterzo	OM501LA	235	320	09/08	>				S 3081 PO
2436 BlueTec 4+5	OM501LA	265	360	09/08	>	S 5006 PE	S 6001 NE		S 3072 C
some AdBlue 145 l. / alcuni AdBlue 145 l.	OM501LA	265	360	09/08	>			S 7213 A	
dryer filter / filtro essiccatore	OM501LA	265	360	09/08	>				S 7A66 A
assembly KNECHT-MAHLE / montaggio KNECHT-MAHLE	OM501LA	265	360	09/08	>			S 7639 A	
assembly MANN+HUMMEL / montaggio MANN+HUMMEL	OM501LA	265	360	09/08	>			S 7A12 A	
prefilter PARKER-RACOR / prefiltro PARKER-RACOR	OM501LA	265	360	09/08	>		S 4121 NR		
power steering / servosterzo	OM501LA	265	360	09/08	>				S 3081 PO
2441 BlueTec 4+5	OM501LA	300	408	09/08	>	S 5006 PE	S 6001 NE		S 3072 C
some AdBlue 145 l. / alcuni AdBlue 145 l.	OM501LA	300	408	09/08	>			S 7213 A	
dryer filter / filtro essiccatore	OM501LA	300	408	09/08	>				S 7A66 A
assembly KNECHT-MAHLE / montaggio KNECHT-MAHLE	OM501LA	300	408	09/08	>			S 7639 A	
assembly MANN+HUMMEL / montaggio MANN+HUMMEL	OM501LA	300	408	09/08	>			S 7A12 A	
power steering / servosterzo	OM501LA	300	408	09/08	>				S 3081 PO
2444 BlueTec 4+5	OM501LA	320	435	09/08	>	S 5006 PE	S 6001 NE		S 3072 C
some AdBlue 145 l. / alcuni AdBlue 145 l.	OM501LA	320	435	09/08	>			S 7213 A	
dryer filter / filtro essiccatore	OM501LA	320	435	09/08	>				S 7A66 A
assembly KNECHT-MAHLE / montaggio KNECHT-MAHLE	OM501LA	320	435	09/08	>			S 7639 A	



...MERCEDES BENZ - trucks/autocarri

assembly MANN+HUMMEL / montaggio MANN+HUMMEL	OM501LA	320	435	09/08	>			S 7A12 A	
prefilter PARKER-RACOR / prefiltro PARKER-RACOR	OM501LA	320	435	09/08	>		S 4121 NR		
power steering / servosterzo	OM501LA	320	435	09/08	>				S 3081 PO
2446 BlueTec 4+5	OM501LA	335	456	09/08	>	S 5006 PE	S 6001 NE	S 7213 A	S 3072 C
some AdBlue 145 l. / alcuni AdBlue 145 l.	OM501LA	335	456	09/08	>				
dryer filter / filtro essiccatore	OM501LA	335	456	09/08	>				S 7A66 A
assembly KNECHT-MAHLE / montaggio KNECHT-MAHLE	OM501LA	335	456	09/08	>			S 7639 A	
assembly MANN+HUMMEL / montaggio MANN+HUMMEL	OM501LA	335	456	09/08	>			S 7A12 A	
prefilter PARKER-RACOR / prefiltro PARKER-RACOR	OM501LA	335	456	09/08	>		S 4121 NR		
power steering / servosterzo	OM501LA	335	456	09/08	>				S 3081 PO
2448 BlueTec 4+5	OM501LA	350	476	09/08	>	S 5006 PE	S 6001 NE	S 7213 A	S 3072 C
some AdBlue 145 l. / alcuni AdBlue 145 l.	OM501LA	350	476	09/08	>				
dryer filter / filtro essiccatore	OM501LA	350	476	09/08	>				S 7A66 A
assembly KNECHT-MAHLE / montaggio KNECHT-MAHLE	OM501LA	350	476	09/08	>			S 7639 A	
assembly MANN+HUMMEL / montaggio MANN+HUMMEL	OM501LA	350	476	09/08	>			S 7A12 A	
prefilter PARKER-RACOR / prefiltro PARKER-RACOR	OM501LA	350	476	09/08	>		S 4121 NR		
power steering / servosterzo	OM501LA	350	476	09/08	>				S 3081 PO
2532 BlueTec 4+5	OM501LA	235	320	09/08	>	S 5006 PE	S 6001 NE	S 7213 A	S 3072 C
some AdBlue 145 l. / alcuni AdBlue 145 l.	OM501LA	235	320	09/08	>				
dryer filter / filtro essiccatore	OM501LA	235	320	09/08	>				S 7A66 A
assembly KNECHT-MAHLE / montaggio KNECHT-MAHLE	OM501LA	235	320	09/08	>			S 7639 A	
assembly MANN+HUMMEL / montaggio MANN+HUMMEL	OM501LA	235	320	09/08	>			S 7A12 A	
prefilter PARKER-RACOR / prefiltro PARKER-RACOR	OM501LA	235	320	09/08	>		S 4121 NR		
power steering / servosterzo	OM501LA	235	320	09/08	>				S 3081 PO
2536 BlueTec 4+5	OM501LA	265	360	09/08	>	S 5006 PE	S 6001 NE	S 7213 A	S 3072 C
some AdBlue 145 l. / alcuni AdBlue 145 l.	OM501LA	265	360	09/08	>				
dryer filter / filtro essiccatore	OM501LA	265	360	09/08	>				S 7A66 A
assembly KNECHT-MAHLE / montaggio KNECHT-MAHLE	OM501LA	265	360	09/08	>			S 7639 A	
assembly MANN+HUMMEL / montaggio MANN+HUMMEL	OM501LA	265	360	09/08	>			S 7A12 A	
prefilter PARKER-RACOR / prefiltro PARKER-RACOR	OM501LA	265	360	09/08	>		S 4121 NR		
power steering / servosterzo	OM501LA	265	360	09/08	>				S 3081 PO
2541 BlueTec 4+5	OM501LA	300	408	09/08	>	S 5006 PE	S 6001 NE	S 7213 A	S 3072 C
some AdBlue 145 l. / alcuni AdBlue 145 l.	OM501LA	300	408	09/08	>				
dryer filter / filtro essiccatore	OM501LA	300	408	09/08	>				S 7A66 A
assembly KNECHT-MAHLE / montaggio KNECHT-MAHLE	OM501LA	300	408	09/08	>			S 7639 A	
assembly MANN+HUMMEL / montaggio MANN+HUMMEL	OM501LA	300	408	09/08	>			S 7A12 A	
prefilter PARKER-RACOR / prefiltro PARKER-RACOR	OM501LA	300	408	09/08	>		S 4121 NR		
power steering / servosterzo	OM501LA	300	408	09/08	>				S 3081 PO
2544 BlueTec 4+5	OM501LA	320	435	09/08	>	S 5006 PE	S 6001 NE	S 7213 A	S 3072 C
some AdBlue 145 l. / alcuni AdBlue 145 l.	OM501LA	320	435	09/08	>				
dryer filter / filtro essiccatore	OM501LA	320	435	09/08	>				S 7A66 A
assembly KNECHT-MAHLE / montaggio KNECHT-MAHLE	OM501LA	320	435	09/08	>			S 7639 A	
assembly MANN+HUMMEL / montaggio MANN+HUMMEL	OM501LA	320	435	09/08	>			S 7A12 A	
prefilter PARKER-RACOR / prefiltro PARKER-RACOR	OM501LA	320	435	09/08	>		S 4121 NR		
power steering / servosterzo	OM501LA	320	435	09/08	>				S 3081 PO
2546 BlueTec 4+5	OM501LA	335	456	09/08	>	S 5006 PE	S 6001 NE	S 7213 A	S 3072 C
some AdBlue 145 l. / alcuni AdBlue 145 l.	OM501LA	335	456	09/08	>				
dryer filter / filtro essiccatore	OM501LA	335	456	09/08	>				S 7A66 A
assembly KNECHT-MAHLE / montaggio KNECHT-MAHLE	OM501LA	335	456	09/08	>			S 7639 A	
assembly MANN+HUMMEL / montaggio MANN+HUMMEL	OM501LA	335	456	09/08	>			S 7A12 A	
prefilter PARKER-RACOR / prefiltro PARKER-RACOR	OM501LA	335	456	09/08	>		S 4121 NR		
power steering / servosterzo	OM501LA	335	456	09/08	>				S 3081 PO
2548 BlueTec 4+5	OM501LA	350	476	09/08	>	S 5006 PE	S 6001 NE	S 7213 A	S 3072 C
some AdBlue 145 l. / alcuni AdBlue 145 l.	OM501LA	350	476	09/08	>				
dryer filter / filtro essiccatore	OM501LA	350	476	09/08	>				S 7A66 A
assembly KNECHT-MAHLE / montaggio KNECHT-MAHLE	OM501LA	350	476	09/08	>			S 7639 A	
assembly MANN+HUMMEL / montaggio MANN+HUMMEL	OM501LA	350	476	09/08	>			S 7A12 A	
prefilter PARKER-RACOR / prefiltro PARKER-RACOR	OM501LA	350	476	09/08	>		S 4121 NR		
power steering / servosterzo	OM501LA	350	476	09/08	>				S 3081 PO
2551 BlueTec 4+5	OM502LA	375	510	09/08	>	S 5006 PE	S 6001 NE	S 7213 A	S 3072 C
dryer filter / filtro essiccatore	OM502LA	375	510	09/08	>				S 7A66 A
assembly KNECHT-MAHLE / montaggio KNECHT-MAHLE	OM502LA	375	510	09/08	>			S 7639 A	
assembly MANN+HUMMEL / montaggio MANN+HUMMEL	OM502LA	375	510	09/08	>			S 7A12 A	
prefilter PARKER-RACOR / prefiltro PARKER-RACOR	OM502LA	375	510	09/08	>		S 4121 NR		
power steering / servosterzo	OM502LA	375	510	09/08	>				S 3081 PO
2555 BlueTec 4+5	OM502LA	405	551	09/08	>	S 5006 PE	S 6001 NE		S 3072 C
dryer filter / filtro essiccatore	OM502LA	405	551	09/08	>				S 7A66 A

M

**KW HP****...MERCEDES BENZ - trucks/autocarri**

assembly KNECHT-MAHLE / montaggio KNECHT-MAHLE	OM502LA	405	551	09/08	>			S 7639 A	
assembly MANN+HUMMEL / montaggio MANN+HUMMEL	OM502LA	405	551	09/08	>			S 7A12 A	
prefilter PARKER-RACOR / prefiltro PARKER-RACOR	OM502LA	405	551	09/08	>		S 4121 NR		
power steering / servosterzo	OM502LA	405	551	09/08	>				S 3081 PO
2560 BlueTec 4+5	OM502LA	440	598	09/08	>	S 5006 PE	S 6001 NE		S 3072 C
dryer filter / filtro essiccatore	OM502LA	440	598	09/08	>				S 7A66 A
assembly KNECHT-MAHLE / montaggio KNECHT-MAHLE	OM502LA	440	598	09/08	>			S 7639 A	
assembly MANN+HUMMEL / montaggio MANN+HUMMEL	OM502LA	440	598	09/08	>			S 7A12 A	
prefilter PARKER-RACOR / prefiltro PARKER-RACOR	OM502LA	440	598	09/08	>		S 4121 NR		
power steering / servosterzo	OM502LA	440	598	09/08	>				S 3081 PO
2632 BlueTec 4+5	OM501LA	235	320	09/08	>	S 5006 PE	S 6001 NE		S 3072 C
some AdBlue 145 l. / alcuni AdBlue 145 l.	OM501LA	235	320	09/08	>			S 7213 A	
dryer filter / filtro essiccatore	OM501LA	235	320	09/08	>				S 7A66 A
assembly KNECHT-MAHLE / montaggio KNECHT-MAHLE	OM501LA	235	320	09/08	>			S 7639 A	
assembly MANN-HUMMEL / montaggio MANN-HUMMEL	OM501LA	235	320	09/08	>			S 7A12 A	
prefilter PARKER-RACOR / prefiltro PARKER-RACOR	OM501LA	235	320	09/08	>		S 4121 NR		
power steering / servosterzo	OM501LA	235	320	09/08	>				S 3081 PO
variation 2 filters / variante N.2 filtri	OM501LA	235	320	09/08	>			S 7A12 A	
2636 BlueTec 4+5	OM501LA/OM541LA	265	360	09/08	>	S 5006 PE	S 6001 NE		S 3072 C
some AdBlue 145 l. / alcuni AdBlue 145 l.	OM501LA/OM541LA	265	360	09/08	>			S 7213 A	
with activated carbon air-conditioner / con climatizzatore, ai carboni attivi	OM501LA/OM541LA	265	360	09/08	>				S 4225 CA
dryer filter / filtro essiccatore	OM501LA/OM541LA	265	360	09/08	>				S 7A66 A
assembly KNECHT-MAHLE / montaggio KNECHT-MAHLE	OM501LA/OM541LA	265	360	09/08	>			S 7639 A	
assembly MANN-HUMMEL / montaggio MANN-HUMMEL	OM501LA/OM541LA	265	360	09/08	>			S 7A12 A	
prefilter PARKER-RACOR / prefiltro PARKER-RACOR	OM501LA/OM541LA	265	360	09/08	>		S 4121 NR		
power steering / servosterzo	OM501LA/OM541LA	265	360	09/08	>				S 3081 PO
variation 2 filters / variante N.2 filtri	OM501LA/OM541LA	265	360	09/08	>			S 7A12 A	
variation 2 filters (inner) / variante N.2 filtri (interno)	OM501LA/OM541LA	265	360	09/08	>			S 7649 A	
2641 BlueTec 4+5	OM501LA	300	408	09/08	>	S 5006 PE	S 6001 NE		S 3072 C
some AdBlue 145 l. / alcuni AdBlue 145 l.	OM501LA	300	408	09/08	>			S 7213 A	
dryer filter / filtro essiccatore	OM501LA	300	408	09/08	>				S 7A66 A
assembly KNECHT-MAHLE / montaggio KNECHT-MAHLE	OM501LA	300	408	09/08	>			S 7639 A	
assembly MANN-HUMMEL / montaggio MANN-HUMMEL	OM501LA	300	408	09/08	>			S 7A12 A	
prefilter PARKER-RACOR / prefiltro PARKER-RACOR	OM501LA	300	408	09/08	>		S 4121 NR		
power steering / servosterzo	OM501LA	300	408	09/08	>				S 3081 PO
variation 2 filters / variante N.2 filtri	OM501LA	300	408	09/08	>			S 7A12 A	
2644 BlueTec 4+5	OM501LA	320	435	09/08	>	S 5006 PE	S 6001 NE		S 3072 C
some AdBlue 145 l. / alcuni AdBlue 145 l.	OM501LA	320	435	09/08	>			S 7213 A	
dryer filter / filtro essiccatore	OM501LA	320	435	09/08	>				S 7A66 A
assembly KNECHT-MAHLE / montaggio KNECHT-MAHLE	OM501LA	320	435	09/08	>			S 7639 A	
assembly MANN-HUMMEL / montaggio MANN-HUMMEL	OM501LA	320	435	09/08	>			S 7A12 A	
prefilter PARKER-RACOR / prefiltro PARKER-RACOR	OM501LA	320	435	09/08	>		S 4121 NR		
power steering / servosterzo	OM501LA	320	435	09/08	>				S 3081 PO
variation 2 filters / variante N.2 filtri	OM501LA	320	435	09/08	>			S 7A12 A	
2646 BlueTec 4+5	OM501LA	335	456	09/08	>	S 5006 PE	S 6001 NE		S 3072 C
some AdBlue 145 l. / alcuni AdBlue 145 l.	OM501LA	335	456	09/08	>			S 7213 A	
dryer filter / filtro essiccatore	OM501LA	335	456	09/08	>				S 7A66 A
assembly KNECHT-MAHLE / montaggio KNECHT-MAHLE	OM501LA	335	456	09/08	>			S 7639 A	
assembly MANN-HUMMEL / montaggio MANN-HUMMEL	OM501LA	335	456	09/08	>			S 7A12 A	
prefilter PARKER-RACOR / prefiltro PARKER-RACOR	OM501LA	335	456	09/08	>		S 4121 NR		
power steering / servosterzo	OM501LA	335	456	09/08	>				S 3081 PO
variation 2 filters / variante N.2 filtri	OM501LA	335	456	09/08	>			S 7A12 A	
2648 BlueTec 4+5	OM501LA	350	476	09/08	>	S 5006 PE	S 6001 NE		S 3072 C
some AdBlue 145 l. / alcuni AdBlue 145 l.	OM501LA	350	476	09/08	>			S 7213 A	
dryer filter / filtro essiccatore	OM501LA	350	476	09/08	>				S 7A66 A
assembly KNECHT-MAHLE / montaggio KNECHT-MAHLE	OM501LA	350	476	09/08	>			S 7639 A	
assembly MANN-HUMMEL / montaggio MANN-HUMMEL	OM501LA	350	476	09/08	>			S 7A12 A	
prefilter PARKER-RACOR / prefiltro PARKER-RACOR	OM501LA	350	476	09/08	>		S 4121 NR		
power steering / servosterzo	OM501LA	350	476	09/08	>				S 3081 PO
variation 2 filters / variante N.2 filtri	OM501LA	350	476	09/08	>			S 7A12 A	
2651 BlueTec 4+5	OM502LA	375	510	09/08	>	S 5006 PE	S 6001 NE		S 3072 C
some AdBlue 145 l. / alcuni AdBlue 145 l.	OM502LA	375	510	09/08	>			S 7213 A	
dryer filter / filtro essiccatore	OM502LA	375	510	09/08	>				S 7A66 A
assembly KNECHT-MAHLE / montaggio KNECHT-MAHLE	OM502LA	375	510	09/08	>			S 7639 A	
assembly MANN-HUMMEL / montaggio MANN-HUMMEL	OM502LA	375	510	09/08	>			S 7A12 A	
prefilter PARKER-RACOR / prefiltro PARKER-RACOR	OM502LA	375	510	09/08	>		S 4121 NR		
power steering / servosterzo	OM502LA	375	510	09/08	>				S 3081 PO



...MERCEDES BENZ - trucks/autocarri

variation 2 filters / variante N.2 filtri	OM502LA	375	510	09/08	>			S 7A12 A	
2655 BlueTec 4+5	OM502LA	405	551	09/08	>	S 5006 PE	S 6001 NE		S 3072 C
some AdBlue 145 l. / alcuni AdBlue 145 l.	OM502LA	405	551	09/08	>			S 7213 A	
dryer filter / filtro essiccatore	OM502LA	405	551	09/08	>				S 7A66 A
assembly KNECHT-MAHLE / montaggio KNECHT-MAHLE	OM502LA	405	551	09/08	>			S 7639 A	
assembly MANN-HUMMEL / montaggio MANN-HUMMEL	OM502LA	405	551	09/08	>			S 7A12 A	
prefilter PARKER-RACOR / prefiltro PARKER-RACOR	OM502LA	405	551	09/08	>		S 4121 NR		
power steering / servosterzo	OM502LA	405	551	09/08	>				S 3081 PO
variation 2 filters / variante N.2 filtri	OM502LA	405	551	09/08	>			S 7A12 A	
2660 BlueTec 4+5	OM502LA	440	598	09/08	>	S 5006 PE	S 6001 NE		S 3072 C
some AdBlue 145 l. / alcuni AdBlue 145 l.	OM502LA	440	598	09/08	>			S 7213 A	
dryer filter / filtro essiccatore	OM502LA	440	598	09/08	>				S 7A66 A
assembly KNECHT-MAHLE / montaggio KNECHT-MAHLE	OM502LA	440	598	09/08	>			S 7639 A	
assembly MANN-HUMMEL / montaggio MANN-HUMMEL	OM502LA	440	598	09/08	>			S 7A12 A	
prefilter PARKER-RACOR / prefiltro PARKER-RACOR	OM502LA	440	598	09/08	>		S 4121 NR		
power steering / servosterzo	OM502LA	440	598	09/08	>				S 3081 PO
variation 2 filters / variante N.2 filtri	OM502LA	440	598	09/08	>			S 7A12 A	
3232 BlueTec 4+5	OM501LA	235	320	09/08	>	S 5006 PE	S 6001 NE		S 3072 C
some AdBlue 145 l. / alcuni AdBlue 145 l.	OM501LA	235	320	09/08	>			S 7213 A	
dryer filter / filtro essiccatore	OM501LA	235	320	09/08	>				S 7A66 A
assembly KNECHT-MAHLE / montaggio KNECHT-MAHLE	OM501LA	235	320	09/08	>			S 7639 A	
assembly MANN-HUMMEL / montaggio MANN-HUMMEL	OM501LA	235	320	09/08	>			S 7A12 A	
prefilter PARKER-RACOR / prefiltro PARKER-RACOR	OM501LA	235	320	09/08	>		S 4121 NR		
power steering / servosterzo	OM501LA	235	320	09/08	>				S 3081 PO
variation 2 filters / variante N.2 filtri	OM501LA	235	320	09/08	>			S 7A12 A	
3236 BlueTec 4+5	OM501LA	265	360	09/08	>	S 5006 PE	S 6001 NE		S 3072 C
some / alcuni	OM501LA	265	360	09/08	>			S 7213 A	
dryer filter / filtro essiccatore	OM501LA	265	360	09/08	>				S 7A66 A
assembly KNECHT-MAHLE / montaggio KNECHT-MAHLE	OM501LA	265	360	09/08	>			S 7639 A	
assembly MANN-HUMMEL / montaggio MANN-HUMMEL	OM501LA	265	360	09/08	>			S 7A12 A	
prefilter / prefiltro	OM501LA	265	360	09/08	>		S 4121 NR		
power steering / servosterzo	OM501LA	265	360	09/08	>				S 3081 PO
variation / variante	OM501LA	265	360	09/08	>			S 7A12 A	
3241 BlueTec 4+5	OM501LA	300	408	09/08	>	S 5006 PE	S 6001 NE		S 3072 C
some AdBlue 145 l. / alcuni AdBlue 145 l.	OM501LA	300	408	09/08	>			S 7213 A	
dryer filter / filtro essiccatore	OM501LA	300	408	09/08	>				S 7A66 A
assembly KNECHT-MAHLE / montaggio KNECHT-MAHLE	OM501LA	300	408	09/08	>			S 7639 A	
assembly MANN-HUMMEL / montaggio MANN-HUMMEL	OM501LA	300	408	09/08	>			S 7A12 A	
prefilter PARKER-RACOR / prefiltro PARKER-RACOR	OM501LA	300	408	09/08	>		S 4121 NR		
power steering / servosterzo	OM501LA	300	408	09/08	>				S 3081 PO
variation 2 filters / variante N.2 filtri	OM501LA	300	408	09/08	>			S 7A12 A	
3244 BlueTec 4+5	OM501LA	320	435	09/08	>	S 5006 PE	S 6001 NE		S 3072 C
some AdBlue 145 l. / alcuni AdBlue 145 l.	OM501LA	320	435	09/08	>			S 7213 A	
dryer filter / filtro essiccatore	OM501LA	320	435	09/08	>				S 7A66 A
assembly KNECHT-MAHLE / montaggio KNECHT-MAHLE	OM501LA	320	435	09/08	>			S 7639 A	
assembly MANN-HUMMEL / montaggio MANN-HUMMEL	OM501LA	320	435	09/08	>			S 7A12 A	
prefilter PARKER-RACOR / prefiltro PARKER-RACOR	OM501LA	320	435	09/08	>		S 4121 NR		
power steering / servosterzo	OM501LA	320	435	09/08	>				S 3081 PO
variation 2 filters / variante N.2 filtri	OM501LA	320	435	09/08	>			S 7A12 A	
3246 BlueTec 4+5	OM501LA	335	456	09/08	>	S 5006 PE	S 6001 NE		S 3072 C
some AdBlue 145 l. / alcuni AdBlue 145 l.	OM501LA	335	456	09/08	>			S 7213 A	
dryer filter / filtro essiccatore	OM501LA	335	456	09/08	>				S 7A66 A
assembly KNECHT-MAHLE / montaggio KNECHT-MAHLE	OM501LA	335	456	09/08	>			S 7639 A	
assembly MANN-HUMMEL / montaggio MANN-HUMMEL	OM501LA	335	456	09/08	>			S 7A12 A	
prefilter PARKER-RACOR / prefiltro PARKER-RACOR	OM501LA	335	456	09/08	>		S 4121 NR		
power steering / servosterzo	OM501LA	335	456	09/08	>				S 3081 PO
variation 2 filters / variante N.2 filtri	OM501LA	335	456	09/08	>			S 7A12 A	
3248 BlueTec 4+5	OM501LA	350	476	09/08	>	S 5006 PE	S 6001 NE		S 3072 C
some AdBlue 145 l. / alcuni AdBlue 145 l.	OM501LA	350	476	09/08	>			S 7213 A	
dryer filter / filtro essiccatore	OM501LA	350	476	09/08	>				S 7A66 A
assembly KNECHT-MAHLE / montaggio KNECHT-MAHLE	OM501LA	350	476	09/08	>			S 7639 A	
assembly MANN-HUMMEL / montaggio MANN-HUMMEL	OM501LA	350	476	09/08	>			S 7A12 A	
prefilter PARKER-RACOR / prefiltro PARKER-RACOR	OM501LA	350	476	09/08	>		S 4121 NR		
power steering / servosterzo	OM501LA	350	476	09/08	>				S 3081 PO
variation 2 filters / variante N.2 filtri	OM501LA	350	476	09/08	>			S 7A12 A	
3332 BlueTec 4+5	OM501LA	235	320	09/08	>	S 5006 PE	S 6001 NE		S 3072 C
some AdBlue 145 l. / alcuni AdBlue 145 l.	OM501LA	235	320	09/08	>			S 7213 A	

M

**KW HP****...MERCEDES BENZ - trucks/autocarri****M**

dryer filter / filtro essiccatore	OM501LA	235	320	09/08	>				S 7A66 A
assembly KNECHT-MAHLE / montaggio KNECHT-MAHLE	OM501LA	235	320	09/08	>			S 7639 A	
assembly MANN-HUMMEL / montaggio MANN-HUMMEL	OM501LA	235	320	09/08	>			S 7A12 A	
prefilter PARKER-RACOR / prefiltro PARKER-RACOR	OM501LA	235	320	09/08	>		S 4121 NR		
power steering / servosterzo	OM501LA	235	320	09/08	>				S 3081 PO
variation 2 filters / variante N.2 filtri	OM501LA	235	320	09/08	>			S 7A12 A	
3336 BlueTec 4+5	OM501LA	265	360	09/08	>	S 5006 PE	S 6001 NE		S 3072 C
some AdBlue 145 l. / alcuni AdBlue 145 l.	OM501LA	265	360	09/08	>			S 7213 A	
dryer filter / filtro essiccatore	OM501LA	265	360	09/08	>				S 7A66 A
assembly KNECHT-MAHLE / montaggio KNECHT-MAHLE	OM501LA	265	360	09/08	>			S 7639 A	
assembly MANN-HUMMEL / montaggio MANN-HUMMEL	OM501LA	265	360	09/08	>			S 7A12 A	
prefilter PARKER-RACOR / prefiltro PARKER-RACOR	OM501LA	265	360	09/08	>		S 4121 NR		
power steering / servosterzo	OM501LA	265	360	09/08	>				S 3081 PO
variation 2 filters / variante N.2 filtri	OM501LA	265	360	09/08	>			S 7A12 A	
3341 BlueTec 4+5	OM501LA	300	408	09/08	>	S 5006 PE	S 6001 NE		S 3072 C
some AdBlue 145 l. / alcuni AdBlue 145 l.	OM501LA	300	408	09/08	>			S 7213 A	
dryer filter / filtro essiccatore	OM501LA	300	408	09/08	>				S 7A66 A
assembly KNECHT-MAHLE / montaggio KNECHT-MAHLE	OM501LA	300	408	09/08	>			S 7639 A	
assembly MANN-HUMMEL / montaggio MANN-HUMMEL	OM501LA	300	408	09/08	>			S 7A12 A	
prefilter PARKER-RACOR / prefiltro PARKER-RACOR	OM501LA	300	408	09/08	>		S 4121 NR		
power steering / servosterzo	OM501LA	300	408	09/08	>				S 3081 PO
variation 2 filters / variante N.2 filtri	OM501LA	300	408	09/08	>			S 7A12 A	
3344 BlueTec 4+5	OM501LA	320	435	09/08	>	S 5006 PE	S 6001 NE		S 3072 C
some AdBlue 145 l. / alcuni AdBlue 145 l.	OM501LA	320	435	09/08	>			S 7213 A	
dryer filter / filtro essiccatore	OM501LA	320	435	09/08	>				S 7A66 A
assembly KNECHT-MAHLE / montaggio KNECHT-MAHLE	OM501LA	320	435	09/08	>			S 7639 A	
assembly MANN-HUMMEL / montaggio MANN-HUMMEL	OM501LA	320	435	09/08	>			S 7A12 A	
prefilter PARKER-RACOR / prefiltro PARKER-RACOR	OM501LA	320	435	09/08	>		S 4121 NR		
power steering / servosterzo	OM501LA	320	435	09/08	>				S 3081 PO
variation 2 filters / variante N.2 filtri	OM501LA	320	435	09/08	>			S 7A12 A	
3346 BlueTec 4+5	OM501LA	335	456	09/08	>	S 5006 PE	S 6001 NE		S 3072 C
some AdBlue 145 l. / alcuni AdBlue 145 l.	OM501LA	335	456	09/08	>			S 7213 A	
dryer filter / filtro essiccatore	OM501LA	335	456	09/08	>				S 7A66 A
assembly KNECHT-MAHLE / montaggio KNECHT-MAHLE	OM501LA	335	456	09/08	>			S 7639 A	
assembly MANN-HUMMEL / montaggio MANN-HUMMEL	OM501LA	335	456	09/08	>			S 7A12 A	
prefilter PARKER-RACOR / prefiltro PARKER-RACOR	OM501LA	335	456	09/08	>		S 4121 NR		
power steering / servosterzo	OM501LA	335	456	09/08	>				S 3081 PO
variation 2 filters / variante N.2 filtri	OM501LA	335	456	09/08	>			S 7A12 A	
3348 BlueTec 4+5	OM501LA	350	476	09/08	>	S 5006 PE	S 6001 NE		S 3072 C
some AdBlue 145 l. / alcuni AdBlue 145 l.	OM501LA	350	476	09/08	>			S 7213 A	
dryer filter / filtro essiccatore	OM501LA	350	476	09/08	>				S 7A66 A
assembly KNECHT-MAHLE / montaggio KNECHT-MAHLE	OM501LA	350	476	09/08	>			S 7639 A	
assembly MANN-HUMMEL / montaggio MANN-HUMMEL	OM501LA	350	476	09/08	>			S 7A12 A	
prefilter PARKER-RACOR / prefiltro PARKER-RACOR	OM501LA	350	476	09/08	>		S 4121 NR		
power steering / servosterzo	OM501LA	350	476	09/08	>				S 3081 PO
variation 2 filters / variante N.2 filtri	OM501LA	350	476	09/08	>			S 7A12 A	
3351 BlueTec 4+5	OM502LA	375	510	09/08	>	S 5006 PE	S 6001 NE		S 3072 C
some AdBlue 145 l. / alcuni AdBlue 145 l.	OM502LA	375	510	09/08	>			S 7213 A	
dryer filter / filtro essiccatore	OM502LA	375	510	09/08	>				S 7A66 A
assembly KNECHT-MAHLE / montaggio KNECHT-MAHLE	OM502LA	375	510	09/08	>			S 7639 A	
assembly MANN-HUMMEL / montaggio MANN-HUMMEL	OM502LA	375	510	09/08	>			S 7A12 A	
prefilter PARKER-RACOR / prefiltro PARKER-RACOR	OM502LA	375	510	09/08	>		S 4121 NR		
power steering / servosterzo	OM502LA	375	510	09/08	>				S 3081 PO
variation 2 filters / variante N.2 filtri	OM502LA	375	510	09/08	>			S 7A12 A	
3355 BlueTec 4+5	OM502LA	405	551	09/08	>	S 5006 PE	S 6001 NE		S 3072 C
some AdBlue 145 l. / alcuni AdBlue 145 l.	OM502LA	405	551	09/08	>			S 7213 A	
dryer filter / filtro essiccatore	OM502LA	405	551	09/08	>				S 7A66 A
assembly KNECHT-MAHLE / montaggio KNECHT-MAHLE	OM502LA	405	551	09/08	>			S 7639 A	
assembly MANN-HUMMEL / montaggio MANN-HUMMEL	OM502LA	405	551	09/08	>			S 7A12 A	
prefilter PARKER-RACOR / prefiltro PARKER-RACOR	OM502LA	405	551	09/08	>		S 4121 NR		
power steering / servosterzo	OM502LA	405	551	09/08	>				S 3081 PO
variation 2 filters / variante N.2 filtri	OM502LA	405	551	09/08	>			S 7A12 A	
3360 BlueTec 4+5	OM502LA	440	598	09/08	>	S 5006 PE	S 6001 NE		S 3072 C
some AdBlue 145 l. / alcuni AdBlue 145 l.	OM502LA	440	598	09/08	>			S 7213 A	
dryer filter / filtro essiccatore	OM502LA	440	598	09/08	>				S 7A66 A
assembly KNECHT-MAHLE / montaggio KNECHT-MAHLE	OM502LA	440	598	09/08	>			S 7639 A	
assembly MANN-HUMMEL / montaggio MANN-HUMMEL	OM502LA	440	598	09/08	>			S 7A12 A	



...MERCEDES BENZ - trucks/autocarri

prefilter PARKER-RACOR / prefiltro PARKER-RACOR	OM502LA	440	598	09/08	>		S 4121 NR		
power steering / servosterzo	OM502LA	440	598	09/08	>				S 3081 PO
variation 2 filters / variante N.2 filtri	OM502LA	440	598	09/08	>			S 7A12 A	
4141 BlueTec 4+5	OM501LA	300	408	09/08	>	S 5006 PE	S 6001 NE		S 3072 C
some AdBlue 145 l. / alcuni AdBlue 145 l.	OM501LA	300	408	09/08	>			S 7213 A	
dryer filter / filtro essiccatore	OM501LA	300	408	09/08	>				S 7A66 A
assembly KNECHT-MAHLE / montaggio KNECHT-MAHLE	OM501LA	300	408	09/08	>			S 7639 A	
assembly MANN-HUMMEL / montaggio MANN-HUMMEL	OM501LA	300	408	09/08	>			S 7A12 A	
prefilter PARKER-RACOR / prefiltro PARKER-RACOR	OM501LA	300	408	09/08	>		S 4121 NR		
power steering / servosterzo	OM501LA	300	408	09/08	>				S 3081 PO
variation 2 filters / variante N.2 filtri	OM501LA	300	408	09/08	>			S 7A12 A	
4144 BlueTec 4+5	OM501LA	320	435	09/08	>	S 5006 PE	S 6001 NE		S 3072 C
some AdBlue 145 l. / alcuni AdBlue 145 l.	OM501LA	320	435	09/08	>			S 7213 A	
dryer filter / filtro essiccatore	OM501LA	320	435	09/08	>				S 7A66 A
assembly KNECHT-MAHLE / montaggio KNECHT-MAHLE	OM501LA	320	435	09/08	>			S 7639 A	
assembly MANN-HUMMEL / montaggio MANN-HUMMEL	OM501LA	320	435	09/08	>			S 7A12 A	
prefilter PARKER-RACOR / prefiltro PARKER-RACOR	OM501LA	320	435	09/08	>		S 4121 NR		
power steering / servosterzo	OM501LA	320	435	09/08	>				S 3081 PO
variation 2 filters / variante N.2 filtri	OM501LA	320	435	09/08	>			S 7A12 A	
4146 BlueTec 4+5	OM501LA	335	456	09/08	>	S 5006 PE	S 6001 NE		S 3072 C
some AdBlue 145 l. / alcuni AdBlue 145 l.	OM501LA	335	456	09/08	>			S 7213 A	
dryer filter / filtro essiccatore	OM501LA	335	456	09/08	>				S 7A66 A
assembly KNECHT-MAHLE / montaggio KNECHT-MAHLE	OM501LA	335	456	09/08	>			S 7639 A	
assembly MANN-HUMMEL / montaggio MANN-HUMMEL	OM501LA	335	456	09/08	>			S 7A12 A	
prefilter PARKER-RACOR / prefiltro PARKER-RACOR	OM501LA	335	456	09/08	>		S 4121 NR		
power steering / servosterzo	OM501LA	335	456	09/08	>				S 3081 PO
variation 2 filters / variante N.2 filtri	OM501LA	335	456	09/08	>			S 7A12 A	
4148 BlueTec 4+5	OM501LA	350	476	09/08	>	S 5006 PE	S 6001 NE		S 3072 C
some AdBlue 145 l. / alcuni AdBlue 145 l.	OM501LA	350	476	09/08	>			S 7213 A	
dryer filter / filtro essiccatore	OM501LA	350	476	09/08	>				S 7A66 A
assembly KNECHT-MAHLE / montaggio KNECHT-MAHLE	OM501LA	350	476	09/08	>			S 7639 A	
assembly MANN-HUMMEL / montaggio MANN-HUMMEL	OM501LA	350	476	09/08	>			S 7A12 A	
prefilter PARKER-RACOR / prefiltro PARKER-RACOR	OM501LA	350	476	09/08	>		S 4121 NR		
power steering / servosterzo	OM501LA	350	476	09/08	>				S 3081 PO
variation 2 filters / variante N.2 filtri	OM501LA	350	476	09/08	>			S 7A12 A	
4151 BlueTec 4+5	OM502LA	375	510	09/08	>	S 5006 PE	S 6001 NE		S 3072 C
some AdBlue 145 l. / alcuni AdBlue 145 l.	OM502LA	375	510	09/08	>			S 7213 A	
dryer filter / filtro essiccatore	OM502LA	375	510	09/08	>				S 7A66 A
assembly KNECHT-MAHLE / montaggio KNECHT-MAHLE	OM502LA	375	510	09/08	>			S 7639 A	
assembly MANN-HUMMEL / montaggio MANN-HUMMEL	OM502LA	375	510	09/08	>			S 7A12 A	
prefilter PARKER-RACOR / prefiltro PARKER-RACOR	OM502LA	375	510	09/08	>		S 4121 NR		
power steering / servosterzo	OM502LA	375	510	09/08	>				S 3081 PO
variation 2 filters / variante N.2 filtri	OM502LA	375	510	09/08	>			S 7A12 A	
4160 BlueTec 4+5 (SLT)	OM502LA	440	598	09/08	>	S 5006 PE	S 6001 NE		S 3072 C
some AdBlue 145 l. / alcuni AdBlue 145 l.	OM502LA	440	598	09/08	>			S 7213 A	
dryer filter / filtro essiccatore	OM502LA	440	598	09/08	>				S 7A66 A
assembly KNECHT-MAHLE / montaggio KNECHT-MAHLE	OM502LA	440	598	09/08	>			S 7639 A	
assembly MANN-HUMMEL / montaggio MANN-HUMMEL	OM502LA	440	598	09/08	>			S 7A12 A	
prefilter PARKER-RACOR / prefiltro PARKER-RACOR	OM502LA	440	598	09/08	>		S 4121 NR		
power steering / servosterzo	OM502LA	440	598	09/08	>				S 3081 PO
variation 2 filters / variante N.2 filtri	OM502LA	440	598	09/08	>			S 7A12 A	
4165 BlueTec 4+5 (SLT)	OM502LA	480	653	09/08	>	S 5006 PE	S 6001 NE		S 3072 C
some AdBlue 145 l. / alcuni AdBlue 145 l.	OM502LA	480	653	09/08	>			S 7213 A	
dryer filter / filtro essiccatore	OM502LA	480	653	09/08	>				S 7A66 A
assembly KNECHT-MAHLE / montaggio KNECHT-MAHLE	OM502LA	480	653	09/08	>			S 7639 A	
assembly MANN-HUMMEL / montaggio MANN-HUMMEL	OM502LA	480	653	09/08	>			S 7A12 A	
prefilter PARKER-RACOR / prefiltro PARKER-RACOR	OM502LA	480	653	09/08	>		S 4121 NR		
power steering / servosterzo	OM502LA	480	653	09/08	>				S 3081 PO
variation 2 filters / variante N.2 filtri	OM502LA	480	653	09/08	>			S 7A12 A	
5041 BlueTec 4+5	OM501LA	300	408	09/08	>	S 5006 PE	S 6001 NE		S 3072 C
some AdBlue 145 l. / alcuni AdBlue 145 l.	OM501LA	300	408	09/08	>			S 7213 A	
dryer filter / filtro essiccatore	OM501LA	300	408	09/08	>				S 7A66 A
assembly KNECHT-MAHLE / montaggio KNECHT-MAHLE	OM501LA	300	408	09/08	>			S 7639 A	
assembly MANN-HUMMEL / montaggio MANN-HUMMEL	OM501LA	300	408	09/08	>			S 7A12 A	
prefilter PARKER-RACOR / prefiltro PARKER-RACOR	OM501LA	300	408	09/08	>		S 4121 NR		
power steering / servosterzo	OM501LA	300	408	09/08	>				S 3081 PO
variation 2 filters / variante N.2 filtri	OM501LA	300	408	09/08	>			S 7A12 A	

M



...MERCEDES BENZ - trucks/autocarri



5044 BlueTec 4+5	OM501LA	320 435	09/08 >	S 5006 PE	S 6001 NE		S 3072 C
some AdBlue 145 l. / alcuni AdBlue 145 l.	OM501LA	320 435	09/08 >			S 7213 A	
dryer filter / filtro essiccatore	OM501LA	320 435	09/08 >				S 7A66 A
assembly KNECHT-MAHLE / montaggio KNECHT-MAHLE	OM501LA	320 435	09/08 >			S 7639 A	
assembly MANN-HUMMEL / montaggio MANN-HUMMEL	OM501LA	320 435	09/08 >			S 7A12 A	
prefilter PARKER-RACOR / prefiltro PARKER-RACOR	OM501LA	320 435	09/08 >		S 4121 NR		
power steering / servosterzo	OM501LA	320 435	09/08 >				S 3081 PO
variation 2 filters / variante N.2 filtri	OM501LA	320 435	09/08 >			S 7A12 A	
5046 BlueTec 4+5	OM501LA	335 456	09/08 >	S 5006 PE	S 6001 NE		S 3072 C
some AdBlue 145 l. / alcuni AdBlue 145 l.	OM501LA	335 456	09/08 >			S 7213 A	
dryer filter / filtro essiccatore	OM501LA	335 456	09/08 >				S 7A66 A
assembly KNECHT-MAHLE / montaggio KNECHT-MAHLE	OM501LA	335 456	09/08 >			S 7639 A	
assembly MANN-HUMMEL / montaggio MANN-HUMMEL	OM501LA	335 456	09/08 >			S 7A12 A	
prefilter PARKER-RACOR / prefiltro PARKER-RACOR	OM501LA	335 456	09/08 >		S 4121 NR		
power steering / servosterzo	OM501LA	335 456	09/08 >				S 3081 PO
variation 2 filters / variante N.2 filtri	OM501LA	335 456	09/08 >			S 7A12 A	
5048 BlueTec 4+5	OM501LA	350 476	09/08 >	S 5006 PE	S 6001 NE		S 3072 C
some AdBlue 145 l. / alcuni AdBlue 145 l.	OM501LA	350 476	09/08 >			S 7213 A	
dryer filter / filtro essiccatore	OM501LA	350 476	09/08 >				S 7A66 A
assembly KNECHT-MAHLE / montaggio KNECHT-MAHLE	OM501LA	350 476	09/08 >			S 7639 A	
assembly MANN-HUMMEL / montaggio MANN-HUMMEL	OM501LA	350 476	09/08 >			S 7A12 A	
prefilter PARKER-RACOR / prefiltro PARKER-RACOR	OM501LA	350 476	09/08 >		S 4121 NR		
power steering / servosterzo	OM501LA	350 476	09/08 >				S 3081 PO
variation 2 filters / variante N.2 filtri	OM501LA	350 476	09/08 >			S 7A12 A	
Actros MP4 (963)							
1824 BlueTec 5/6/EEV	OM936LA	175 238	09/12 >	S 5236 PE	S 6148 NE	S 7F22 A	S 3459 C
with activated carbons / ai carboni attivi	OM936LA	175 238	09/12 >				S 4349 CA
with outer front air intake / con presa aria frontale, esterno	OM936LA	175 238	09/12 >			S 7F20 A	
LONG LIFE	OM936LA	175 238	09/12 >			S 7F21 A	
power steering / servosterzo	OM936LA	175 238	09/12 >				S 3081 PO
cabin ventilation / ventilazione cabina	OM936LA	175 238	09/12 >				S 3448 C
dusty areas / zone polverose	OM936LA	175 238	09/12 >				S 3453 C
1827 BlueTec 5/6/EEV	OM936LA	200 272	09/12 >	S 5236 PE	S 6148 NE	S 7F22 A	S 3459 C
with activated carbons / ai carboni attivi	OM936LA	200 272	09/12 >				S 4349 CA
with outer front air intake / con presa aria frontale, esterno	OM936LA	200 272	09/12 >			S 7F20 A	
LONG LIFE	OM936LA	200 272	09/12 >			S 7F21 A	
power steering / servosterzo	OM936LA	200 272	09/12 >				S 3081 PO
cabin ventilation / ventilazione cabina	OM936LA	200 272	09/12 >				S 3448 C
dusty areas / zone polverose	OM936LA	200 272	09/12 >				S 3453 C
1830 BlueTec 5/6/EEV	OM936LA	220 299	09/12 >	S 5236 PE	S 6148 NE	S 7F22 A	S 3459 C
with activated carbons / ai carboni attivi	OM936LA	220 299	09/12 >				S 4349 CA
with outer front air intake / con presa aria frontale, esterno	OM936LA	220 299	09/12 >			S 7F20 A	
LONG LIFE	OM936LA	220 299	09/12 >			S 7F21 A	
power steering / servosterzo	OM936LA	220 299	09/12 >				S 3081 PO
cabin ventilation / ventilazione cabina	OM936LA	220 299	09/12 >				S 3448 C
dusty areas / zone polverose	OM936LA	220 299	09/12 >				S 3453 C
1832 BlueTec 5/6/EEV	OM936LA	235 320	09/12 >	S 5236 PE	S 6148 NE	S 7F22 A	S 3459 C
with activated carbons / ai carboni attivi	OM936LA	235 320	09/12 >				S 4349 CA
with outer front air intake / con presa aria frontale, esterno	OM936LA	235 320	09/12 >			S 7F20 A	
LONG LIFE	OM936LA	235 320	09/12 >			S 7F21 A	
power steering / servosterzo	OM936LA	235 320	09/12 >				S 3081 PO
cabin ventilation / ventilazione cabina	OM936LA	235 320	09/12 >				S 3448 C
dusty areas / zone polverose	OM936LA	235 320	09/12 >				S 3453 C
1833 BlueTec 5/6/EEV	OM470LA	240 326	09/12 >	S 5237 PE		S 7F22 A	S 3459 C
with activated carbons / ai carboni attivi	OM470LA	240 326	09/12 >				S 4349 CA
with outer front air intake / con presa aria frontale, esterno	OM470LA	240 326	09/12 >			S 7F20 A	
LONG LIFE	OM470LA	240 326	09/12 >			S 7F21 A	
power steering / servosterzo	OM470LA	240 326	09/12 >				S 3081 PO
cabin ventilation / ventilazione cabina	OM470LA	240 326	09/12 >				S 3448 C
dusty areas / zone polverose	OM470LA	240 326	09/12 >				S 3453 C
1835 BlueTec 5/6/EEV	OM936LA	260 353	09/12 >	S 5236 PE	S 6148 NE	S 7F22 A	S 3459 C
with activated carbons / ai carboni attivi	OM936LA	260 353	09/12 >				S 4349 CA
with outer front air intake / con presa aria frontale, esterno	OM936LA	260 353	09/12 >			S 7F20 A	
LONG LIFE	OM936LA	260 353	09/12 >			S 7F21 A	
power steering / servosterzo	OM936LA	260 353	09/12 >				S 3081 PO
cabin ventilation / ventilazione cabina	OM936LA	260 353	09/12 >				S 3448 C
dusty areas / zone polverose	OM936LA	260 353	09/12 >				S 3453 C

**KW HP****...MERCEDES BENZ - trucks/autocarri**

1836 BlueTec 5/6/EEV	OM470LA	265	360	09/12	>	S 5237 PE		S 7F22 A	S 3459 C
with activated carbons / ai carboni attivi	OM470LA	265	360	09/12	>				S 4349 CA
with outer front air intake / con presa aria frontale, esterno	OM470LA	265	360	09/12	>			S 7F20 A	
LONG LIFE	OM470LA	265	360	09/12	>			S 7F21 A	
power steering / servosterzo	OM470LA	265	360	09/12	>				S 3081 PO
cabin ventilation / ventilazione cabina	OM470LA	265	360	09/12	>				S 3448 C
dusty areas / zone polverose	OM470LA	265	360	09/12	>				S 3453 C
1840 BlueTec 5/6/EEV	OM470LA	290	394	09/12	>	S 5237 PE		S 7F22 A	S 3459 C
with activated carbons / ai carboni attivi	OM470LA	290	394	09/12	>				S 4349 CA
with outer front air intake / con presa aria frontale, esterno	OM470LA	290	394	09/12	>			S 7F20 A	
LONG LIFE	OM470LA	290	394	09/12	>			S 7F21 A	
power steering / servosterzo	OM470LA	290	394	09/12	>				S 3081 PO
cabin ventilation / ventilazione cabina	OM470LA	290	394	09/12	>				S 3448 C
dusty areas / zone polverose	OM470LA	290	394	09/12	>				S 3453 C
1842 BlueTec 5/6/EEV	OM471LA	310	421	09/11	>	S 5156 PE		S 7F22 A	S 3459 C
with activated carbons / ai carboni attivi	OM471LA	310	421	09/11	>				S 4349 CA
with outer front air intake / con presa aria frontale, esterno	OM471LA	310	421	09/11	>			S 7F20 A	
dryer filter / filtro essiccatore	OM471LA	310	421	09/11	>				S 7A66 A
LONG LIFE	OM471LA	310	421	09/11	>			S 7F21 A	
power steering / servosterzo	OM471LA	310	421	09/11	>				S 3081 PO
cabin ventilation / ventilazione cabina	OM471LA	310	421	09/11	>				S 3448 C
1843 BlueTec 5/6/EEV	OM470LA	315	428	09/12	>	S 5237 PE		S 7F22 A	S 3459 C
with activated carbons / ai carboni attivi	OM470LA	315	428	09/12	>				S 4349 CA
with outer front air intake / con presa aria frontale, esterno	OM470LA	315	428	09/12	>			S 7F20 A	
LONG LIFE	OM470LA	315	428	09/12	>			S 7F21 A	
power steering / servosterzo	OM470LA	315	428	09/12	>				S 3081 PO
cabin ventilation / ventilazione cabina	OM470LA	315	428	09/12	>				S 3448 C
dusty areas / zone polverose	OM470LA	315	428	09/12	>				S 3453 C
1845 BlueTec 5/6/EEV	OM471LA	330	449	09/11	>	S 5156 PE		S 7F22 A	S 3459 C
with activated carbons / ai carboni attivi	OM471LA	330	449	09/11	>				S 4349 CA
with outer front air intake / con presa aria frontale, esterno	OM471LA	330	449	09/11	>			S 7F20 A	
dryer filter / filtro essiccatore	OM471LA	330	449	09/11	>				S 7A66 A
LONG LIFE	OM471LA	330	449	09/11	>			S 7F21 A	
power steering / servosterzo	OM471LA	330	449	09/11	>				S 3081 PO
cabin ventilation / ventilazione cabina	OM471LA	330	449	09/11	>				S 3448 C
1848 BlueTec 5/6/EEV	OM471LA	350	476	09/11	>	S 5156 PE		S 7F22 A	S 3459 C
with activated carbons / ai carboni attivi	OM471LA	350	476	09/11	>				S 4314 CA
with outer front air intake / con presa aria frontale, esterno	OM471LA	350	476	09/11	>			S 7F20 A	
dryer filter / filtro essiccatore	OM471LA	350	476	09/11	>				S 7A66 A
LONG LIFE	OM471LA	350	476	09/11	>			S 7F21 A	
power steering / servosterzo	OM471LA	350	476	09/11	>				S 3081 PO
cabin ventilation / ventilazione cabina	OM471LA	350	476	09/11	>				S 3448 C
1851 BlueTec 5/6/EEV	OM471LA	375	510	09/11	>	S 5156 PE		S 7F22 A	S 3459 C
with activated carbons / ai carboni attivi	OM471LA	375	510	09/11	>				S 4349 CA
with outer front air intake / con presa aria frontale, esterno	OM471LA	375	510	09/11	>			S 7F20 A	
dryer filter / filtro essiccatore	OM471LA	375	510	09/11	>				S 7A66 A
LONG LIFE	OM471LA	375	510	09/11	>			S 7F21 A	
power steering / servosterzo	OM471LA	375	510	09/11	>				S 3081 PO
cabin ventilation / ventilazione cabina	OM471LA	375	510	09/11	>				S 3448 C
2024 BlueTec 5/6/EEV	OM936LA	175	238	09/12	>	S 5236 PE	S 6148 NE	S 7F22 A	S 3459 C
with activated carbons / ai carboni attivi	OM936LA	175	238	09/12	>				S 4349 CA
with outer front air intake / con presa aria frontale, esterno	OM936LA	175	238	09/12	>			S 7F20 A	
LONG LIFE	OM936LA	175	238	09/12	>			S 7F21 A	
power steering / servosterzo	OM936LA	175	238	09/12	>				S 3081 PO
cabin ventilation / ventilazione cabina	OM936LA	175	238	09/12	>				S 3448 C
dusty areas / zone polverose	OM936LA	175	238	09/12	>				S 3453 C
2027 BlueTec 5/6/EEV	OM936LA	200	272	09/12	>	S 5236 PE	S 6148 NE	S 7F22 A	S 3459 C
with activated carbons / ai carboni attivi	OM936LA	200	272	09/12	>				S 4349 CA
with outer front air intake / con presa aria frontale, esterno	OM936LA	200	272	09/12	>			S 7F20 A	
LONG LIFE	OM936LA	200	272	09/12	>			S 7F21 A	
power steering / servosterzo	OM936LA	200	272	09/12	>				S 3081 PO
cabin ventilation / ventilazione cabina	OM936LA	200	272	09/12	>				S 3448 C
dusty areas / zone polverose	OM936LA	200	272	09/12	>				S 3453 C
2030 BlueTec 5/6/EEV	OM936LA	220	299	09/12	>	S 5236 PE	S 6148 NE	S 7F22 A	S 3459 C
with activated carbons / ai carboni attivi	OM936LA	220	299	09/12	>				S 4349 CA
with outer front air intake / con presa aria frontale, esterno	OM936LA	220	299	09/12	>			S 7F20 A	
LONG LIFE	OM936LA	220	299	09/12	>			S 7F21 A	

M

**KW HP****...MERCEDES BENZ - trucks/autocarri****M**

power steering / servosterzo	OM936LA	220	299	09/12	>				S 3081 PO
cabin ventilation / ventilazione cabina	OM936LA	220	299	09/12	>				S 3448 C
dusty areas / zone polverose	OM936LA	220	299	09/12	>				S 3453 C
2032 BlueTec 5/6/EEV	OM936LA	235	320	09/12	>	S 5236 PE	S 6148 NE	S 7F22 A	S 3459 C
with activated carbons / ai carboni attivi	OM936LA	235	320	09/12	>				S 4349 CA
with outer front air intake / con presa aria frontale, esterno	OM936LA	235	320	09/12	>			S 7F20 A	
LONG LIFE	OM936LA	235	320	09/12	>			S 7F21 A	
power steering / servosterzo	OM936LA	235	320	09/12	>				S 3081 PO
cabin ventilation / ventilazione cabina	OM936LA	235	320	09/12	>				S 3448 C
dusty areas / zone polverose	OM936LA	235	320	09/12	>				S 3453 C
2033 BlueTec 5/6/EEV	OM470LA	240	326	09/12	>	S 5237 PE		S 7F22 A	S 3459 C
with activated carbons / ai carboni attivi	OM470LA	240	326	09/12	>				S 4349 CA
with outer front air intake / con presa aria frontale, esterno	OM470LA	240	326	09/12	>			S 7F20 A	
LONG LIFE	OM470LA	240	326	09/12	>			S 7F21 A	
power steering / servosterzo	OM470LA	240	326	09/12	>				S 3081 PO
cabin ventilation / ventilazione cabina	OM470LA	240	326	09/12	>				S 3448 C
dusty areas / zone polverose	OM470LA	240	326	09/12	>				S 3453 C
2035 BlueTec 5/6/EEV	OM936LA	260	353	09/12	>	S 5236 PE	S 6148 NE	S 7F22 A	S 3459 C
with activated carbons / ai carboni attivi	OM936LA	260	353	09/12	>				S 4349 CA
with outer front air intake / con presa aria frontale, esterno	OM936LA	260	353	09/12	>			S 7F20 A	
LONG LIFE	OM936LA	260	353	09/12	>			S 7F21 A	
power steering / servosterzo	OM936LA	260	353	09/12	>				S 3081 PO
cabin ventilation / ventilazione cabina	OM936LA	260	353	09/12	>				S 3448 C
dusty areas / zone polverose	OM936LA	260	353	09/12	>				S 3453 C
2036 BlueTec 5/6/EEV	OM470LA	265	360	09/12	>	S 5237 PE		S 7F22 A	S 3459 C
with activated carbons / ai carboni attivi	OM470LA	265	360	09/12	>				S 4349 CA
with outer front air intake / con presa aria frontale, esterno	OM470LA	265	360	09/12	>			S 7F20 A	
LONG LIFE	OM470LA	265	360	09/12	>			S 7F21 A	
power steering / servosterzo	OM470LA	265	360	09/12	>				S 3081 PO
cabin ventilation / ventilazione cabina	OM470LA	265	360	09/12	>				S 3448 C
dusty areas / zone polverose	OM470LA	265	360	09/12	>				S 3453 C
2040 BlueTec 5/6/EEV	OM470LA	290	394	09/12	>	S 5237 PE		S 7F22 A	S 3459 C
with activated carbons / ai carboni attivi	OM470LA	290	394	09/12	>				S 4349 CA
with outer front air intake / con presa aria frontale, esterno	OM470LA	290	394	09/12	>			S 7F20 A	
LONG LIFE	OM470LA	290	394	09/12	>			S 7F21 A	
power steering / servosterzo	OM470LA	290	394	09/12	>				S 3081 PO
cabin ventilation / ventilazione cabina	OM470LA	290	394	09/12	>				S 3448 C
dusty areas / zone polverose	OM470LA	290	394	09/12	>				S 3453 C
2042 BlueTec 5/6/EEV	OM471LA	310	421	09/11	>	S 5156 PE		S 7F22 A	S 3459 C
with activated carbons / ai carboni attivi	OM471LA	310	421	09/11	>				S 4349 CA
with outer front air intake / con presa aria frontale, esterno	OM471LA	310	421	09/11	>			S 7F20 A	
dryer filter / filtro essiccatore	OM471LA	310	421	09/11	>				S 7A66 A
LONG LIFE	OM471LA	310	421	09/11	>			S 7F21 A	
power steering / servosterzo	OM471LA	310	421	09/11	>				S 3081 PO
cabin ventilation / ventilazione cabina	OM471LA	310	421	09/11	>				S 3448 C
2043 BlueTec 5/6/EEV	OM470LA	315	428	09/12	>	S 5237 PE		S 7F22 A	S 3459 C
with activated carbons / ai carboni attivi	OM470LA	315	428	09/12	>				S 4349 CA
with outer front air intake / con presa aria frontale, esterno	OM470LA	315	428	09/12	>			S 7F20 A	
LONG LIFE	OM470LA	315	428	09/12	>			S 7F21 A	
power steering / servosterzo	OM470LA	315	428	09/12	>				S 3081 PO
cabin ventilation / ventilazione cabina	OM470LA	315	428	09/12	>				S 3448 C
dusty areas / zone polverose	OM470LA	315	428	09/12	>				S 3453 C
2045 BlueTec 5/6/EEV	OM471LA	330	449	09/11	>	S 5156 PE		S 7F22 A	S 3459 C
with activated carbons / ai carboni attivi	OM471LA	330	449	09/11	>				S 4349 CA
with outer front air intake / con presa aria frontale, esterno	OM471LA	330	449	09/11	>			S 7F20 A	
dryer filter / filtro essiccatore	OM471LA	330	449	09/11	>				S 7A66 A
LONG LIFE	OM471LA	330	449	09/11	>			S 7F21 A	
power steering / servosterzo	OM471LA	330	449	09/11	>				S 3081 PO
cabin ventilation / ventilazione cabina	OM471LA	330	449	09/11	>				S 3448 C
2048 BlueTec 5/6/EEV	OM471LA	350	476	09/11	>	S 5156 PE		S 7F22 A	S 3459 C
with activated carbons / ai carboni attivi	OM471LA	350	476	09/11	>				S 4349 CA
with outer front air intake / con presa aria frontale, esterno	OM471LA	350	476	09/11	>			S 7F20 A	
dryer filter / filtro essiccatore	OM471LA	350	476	09/11	>				S 7A66 A
LONG LIFE	OM471LA	350	476	09/11	>			S 7F21 A	
power steering / servosterzo	OM471LA	350	476	09/11	>				S 3081 PO
cabin ventilation / ventilazione cabina	OM471LA	350	476	09/11	>				S 3448 C
2051 BlueTec 5/6/EEV	OM471LA	375	510	09/11	>	S 5156 PE		S 7F22 A	S 3459 C



...MERCEDES BENZ - trucks/autocarri

with activated carbons / ai carboni attivi	OM471LA	375	510	09/11	>				S 4349 CA
with outer front air intake / con presa aria frontale, esterno	OM471LA	375	510	09/11	>			S 7F20 A	
dryer filter / filtro essiccatore	OM471LA	375	510	09/11	>				S 7A66 A
LONG LIFE	OM471LA	375	510	09/11	>			S 7F21 A	
power steering / servosterzo	OM471LA	375	510	09/11	>				S 3081 PO
cabin ventilation / ventilazione cabina	OM471LA	375	510	09/11	>				S 3448 C
2427 BlueTec 5/6/EEV	OM936LA	200	272	09/12	>	S 5236 PE	S 6148 NE	S 7F22 A	S 3459 C
with activated carbons / ai carboni attivi	OM936LA	200	272	09/12	>				S 4349 CA
with outer front air intake / con presa aria frontale, esterno	OM936LA	200	272	09/12	>			S 7F20 A	
LONG LIFE	OM936LA	200	272	09/12	>			S 7F21 A	
power steering / servosterzo	OM936LA	200	272	09/12	>				S 3081 PO
cabin ventilation / ventilazione cabina	OM936LA	200	272	09/12	>				S 3448 C
dusty areas / zone polverose	OM936LA	200	272	09/12	>				S 3453 C
2430 BlueTec 5/6/EEV	OM936LA	220	299	09/12	>	S 5236 PE	S 6148 NE	S 7F22 A	S 3459 C
with activated carbons / ai carboni attivi	OM936LA	220	299	09/12	>				S 4349 CA
with outer front air intake / con presa aria frontale, esterno	OM936LA	220	299	09/12	>			S 7F20 A	
LONG LIFE	OM936LA	220	299	09/12	>			S 7F21 A	
power steering / servosterzo	OM936LA	220	299	09/12	>				S 3081 PO
cabin ventilation / ventilazione cabina	OM936LA	220	299	09/12	>				S 3448 C
dusty areas / zone polverose	OM936LA	220	299	09/12	>				S 3453 C
2432 BlueTec 5/6/EEV	OM936LA	235	320	09/12	>	S 5236 PE	S 6148 NE	S 7F22 A	S 3459 C
with activated carbons / ai carboni attivi	OM936LA	235	320	09/12	>				S 4349 CA
with outer front air intake / con presa aria frontale, esterno	OM936LA	235	320	09/12	>			S 7F20 A	
LONG LIFE	OM936LA	235	320	09/12	>			S 7F21 A	
power steering / servosterzo	OM936LA	235	320	09/12	>				S 3081 PO
cabin ventilation / ventilazione cabina	OM936LA	235	320	09/12	>				S 3448 C
dusty areas / zone polverose	OM936LA	235	320	09/12	>				S 3453 C
2433 BlueTec 5/6/EEV	OM470LA	240	326	09/12	>	S 5237 PE		S 7F22 A	S 3459 C
with activated carbons / ai carboni attivi	OM470LA	240	326	09/12	>				S 4349 CA
with outer front air intake / con presa aria frontale, esterno	OM470LA	240	326	09/12	>			S 7F20 A	
LONG LIFE	OM470LA	240	326	09/12	>			S 7F21 A	
power steering / servosterzo	OM470LA	240	326	09/12	>				S 3081 PO
cabin ventilation / ventilazione cabina	OM470LA	240	326	09/12	>				S 3448 C
dusty areas / zone polverose	OM470LA	240	326	09/12	>				S 3453 C
2435 BlueTec 5/6/EEV	OM936LA	260	353	09/12	>	S 5236 PE	S 6148 NE	S 7F22 A	S 3459 C
with activated carbons / ai carboni attivi	OM936LA	260	353	09/12	>				S 4349 CA
with outer front air intake / con presa aria frontale, esterno	OM936LA	260	353	09/12	>			S 7F20 A	
LONG LIFE	OM936LA	260	353	09/12	>			S 7F21 A	
power steering / servosterzo	OM936LA	260	353	09/12	>				S 3081 PO
cabin ventilation / ventilazione cabina	OM936LA	260	353	09/12	>				S 3448 C
dusty areas / zone polverose	OM936LA	260	353	09/12	>				S 3453 C
2436 BlueTec 5/6/EEV	OM470LA	265	360	09/12	>	S 5237 PE		S 7F22 A	S 3459 C
with activated carbons / ai carboni attivi	OM470LA	265	360	09/12	>				S 4349 CA
with outer front air intake / con presa aria frontale, esterno	OM470LA	265	360	09/12	>			S 7F20 A	
LONG LIFE	OM470LA	265	360	09/12	>			S 7F21 A	
power steering / servosterzo	OM470LA	265	360	09/12	>				S 3081 PO
cabin ventilation / ventilazione cabina	OM470LA	265	360	09/12	>				S 3448 C
dusty areas / zone polverose	OM470LA	265	360	09/12	>				S 3453 C
2440 BlueTec 5/6/EEV	OM470LA	290	394	09/12	>	S 5237 PE		S 7F22 A	S 3459 C
with activated carbons / ai carboni attivi	OM470LA	290	394	09/12	>				S 4349 CA
with outer front air intake / con presa aria frontale, esterno	OM470LA	290	394	09/12	>			S 7F20 A	
LONG LIFE	OM470LA	290	394	09/12	>			S 7F21 A	
power steering / servosterzo	OM470LA	290	394	09/12	>				S 3081 PO
cabin ventilation / ventilazione cabina	OM470LA	290	394	09/12	>				S 3448 C
dusty areas / zone polverose	OM470LA	290	394	09/12	>				S 3453 C
2442 BlueTec 5/6/EEV	OM471LA	310	421	09/11	>	S 5156 PE		S 7F22 A	S 3459 C
with activated carbons / ai carboni attivi	OM471LA	310	421	09/11	>				S 4349 CA
with outer front air intake / con presa aria frontale, esterno	OM471LA	310	421	09/11	>			S 7F20 A	
dryer filter / filtro essiccatore	OM471LA	310	421	09/11	>				S 7A66 A
LONG LIFE	OM471LA	310	421	09/11	>			S 7F21 A	
power steering / servosterzo	OM471LA	310	421	09/11	>				S 3081 PO
cabin ventilation / ventilazione cabina	OM471LA	310	421	09/11	>				S 3448 C
2443 BlueTec 5/6/EEV	OM470LA	315	428	09/12	>	S 5237 PE		S 7F22 A	S 3459 C
with activated carbons / ai carboni attivi	OM470LA	315	428	09/12	>				S 4349 CA
with outer front air intake / con presa aria frontale, esterno	OM470LA	315	428	09/12	>			S 7F20 A	
LONG LIFE	OM470LA	315	428	09/12	>			S 7F21 A	
power steering / servosterzo	OM470LA	315	428	09/12	>				S 3081 PO

M



...MERCEDES BENZ - trucks/autocarri

M



cabin ventilation / ventilazione cabina	OM470LA	315	428	09/12	>				S 3448 C
dusty areas / zone polverose	OM470LA	315	428	09/12	>				S 3453 C
2445 BlueTec 5/6/EEV	OM471LA	330	449	09/11	>	S 5156 PE		S 7F22 A	S 3459 C
with activated carbons / ai carboni attivi	OM471LA	330	449	09/11	>			S 7F20 A	S 4349 CA
with outer front air intake / con presa aria frontale, esterno	OM471LA	330	449	09/11	>			S 7F20 A	
dryer filter / filtro essiccatore	OM471LA	330	449	09/11	>				S 7A66 A
LONG LIFE	OM471LA	330	449	09/11	>			S 7F21 A	
power steering / servosterzo	OM471LA	330	449	09/11	>				S 3081 PO
cabin ventilation / ventilazione cabina	OM471LA	330	449	09/11	>				S 3448 C
2448 BlueTec 5/6/EEV	OM471LA	350	476	09/11	>	S 5156 PE		S 7F22 A	
with activated carbons / ai carboni attivi	OM471LA	350	476	09/11	>				S 4349 CA
with outer front air intake / con presa aria frontale, esterno	OM471LA	350	476	09/11	>			S 7F20 A	
dryer filter / filtro essiccatore	OM471LA	350	476	09/11	>				S 7A66 A
LONG LIFE	OM471LA	350	476	09/11	>			S 7F21 A	
power steering / servosterzo	OM471LA	350	476	09/11	>				S 3081 PO
cabin ventilation / ventilazione cabina	OM471LA	350	476	09/11	>				S 3448 C
2451 BlueTec 5/6/EEV	OM471LA	375	510	09/11	>	S 5156 PE		S 7F22 A	S 3459 C
with activated carbons / ai carboni attivi	OM471LA	375	510	09/11	>			S 7F20 A	S 4349 CA
with outer front air intake / con presa aria frontale, esterno	OM471LA	375	510	09/11	>			S 7F20 A	
dryer filter / filtro essiccatore	OM471LA	375	510	09/11	>				S 7A66 A
LONG LIFE	OM471LA	375	510	09/11	>			S 7F21 A	
power steering / servosterzo	OM471LA	375	510	09/11	>				S 3081 PO
cabin ventilation / ventilazione cabina	OM471LA	375	510	09/11	>				S 3448 C
2527 BlueTec 5/6/EEV	OM936LA	200	272	09/12	>	S 5236 PE	S 6148 NE	S 7F22 A	S 3459 C
with activated carbons / ai carboni attivi	OM936LA	200	272	09/12	>				S 4349 CA
with outer front air intake / con presa aria frontale, esterno	OM936LA	200	272	09/12	>			S 7F20 A	
LONG LIFE	OM936LA	200	272	09/12	>			S 7F21 A	
power steering / servosterzo	OM936LA	200	272	09/12	>				S 3081 PO
dusty areas / zone polverose	OM936LA	200	272	09/12	>				S 3453 C
2530 BlueTec 5/6/EEV	OM936LA	220	299	09/12	>	S 5236 PE	S 6148 NE	S 7F22 A	S 3459 C
with activated carbons / ai carboni attivi	OM936LA	220	299	09/12	>				S 4349 CA
with outer front air intake / con presa aria frontale, esterno	OM936LA	220	299	09/12	>			S 7F20 A	
LONG LIFE	OM936LA	220	299	09/12	>			S 7F21 A	
power steering / servosterzo	OM936LA	220	299	09/12	>				S 3081 PO
cabin ventilation / ventilazione cabina	OM936LA	220	299	09/12	>				S 3448 C
dusty areas / zone polverose	OM936LA	220	299	09/12	>				S 3453 C
2532 BlueTec 5/6/EEV	OM936LA	235	320	09/12	>	S 5236 PE	S 6148 NE	S 7F22 A	S 3459 C
with activated carbons / ai carboni attivi	OM936LA	235	320	09/12	>				S 4349 CA
with outer front air intake / con presa aria frontale, esterno	OM936LA	235	320	09/12	>			S 7F20 A	
LONG LIFE	OM936LA	235	320	09/12	>			S 7F21 A	
power steering / servosterzo	OM936LA	235	320	09/12	>				S 3081 PO
cabin ventilation / ventilazione cabina	OM936LA	235	320	09/12	>				S 3448 C
dusty areas / zone polverose	OM936LA	235	320	09/12	>				S 3453 C
2533 BlueTec 5/6/EEV	OM470LA	240	326	09/12	>	S 5237 PE		S 7F22 A	S 3459 C
with activated carbons / ai carboni attivi	OM470LA	240	326	09/12	>				S 4349 CA
with outer front air intake / con presa aria frontale, esterno	OM470LA	240	326	09/12	>			S 7F20 A	
LONG LIFE	OM470LA	240	326	09/12	>			S 7F21 A	
power steering / servosterzo	OM470LA	240	326	09/12	>				S 3081 PO
cabin ventilation / ventilazione cabina	OM470LA	240	326	09/12	>				S 3448 C
dusty areas / zone polverose	OM470LA	240	326	09/12	>				S 3453 C
2535 BlueTec 5/6/EEV	OM936LA	260	353	09/12	>	S 5236 PE	S 6148 NE	S 7F22 A	S 3459 C
with activated carbons / ai carboni attivi	OM936LA	260	353	09/12	>				S 4349 CA
with outer front air intake / con presa aria frontale, esterno	OM936LA	260	353	09/12	>			S 7F20 A	
LONG LIFE	OM936LA	260	353	09/12	>			S 7F21 A	
power steering / servosterzo	OM936LA	260	353	09/12	>				S 3081 PO
cabin ventilation / ventilazione cabina	OM936LA	260	353	09/12	>				S 3448 C
dusty areas / zone polverose	OM936LA	260	353	09/12	>				S 3453 C
2536 BlueTec 5/6/EEV	OM470LA	265	360	09/12	>	S 5237 PE		S 7F22 A	S 3459 C
with activated carbons / ai carboni attivi	OM470LA	265	360	09/12	>				S 4349 CA
with outer front air intake / con presa aria frontale, esterno	OM470LA	265	360	09/12	>			S 7F20 A	
LONG LIFE	OM470LA	265	360	09/12	>			S 7F21 A	
power steering / servosterzo	OM470LA	265	360	09/12	>				S 3081 PO
cabin ventilation / ventilazione cabina	OM470LA	265	360	09/12	>				S 3448 C
dusty areas / zone polverose	OM470LA	265	360	09/12	>				S 3453 C
2540 BlueTec 5/6/EEV	OM470LA	290	394	09/12	>	S 5237 PE		S 7F22 A	S 3459 C
with activated carbons / ai carboni attivi	OM470LA	290	394	09/12	>				S 4349 CA
with outer front air intake / con presa aria frontale, esterno	OM470LA	290	394	09/12	>			S 7F20 A	



...MERCEDES BENZ - trucks/autocarri

LONG LIFE	OM470LA	290	394	09/12	>			S 7F21 A	
power steering / servosterzo	OM470LA	290	394	09/12	>				S 3081 PO
dusty areas / zone polverose	OM470LA	290	394	09/12	>				S 3453 C
2542 BlueTec 5/6/EEV	OM471LA	310	421	09/11	>	S 5156 PE		S 7F22 A	S 3459 C
with activated carbons / ai carboni attivi	OM471LA	310	421	09/11	>				S 4349 CA
with outer front air intake / con presa aria frontale, esterno	OM471LA	310	421	09/11	>			S 7F20 A	
dryer filter / filtro essiccatore	OM471LA	310	421	09/11	>				S 7A66 A
LONG LIFE	OM471LA	310	421	09/11	>			S 7F21 A	
power steering / servosterzo	OM471LA	310	421	09/11	>				S 3081 PO
cabin ventilation / ventilazione cabina	OM471LA	310	421	09/11	>				S 3448 C
2543 BlueTec 5/6/EEV	OM470LA	315	428	09/12	>	S 5237 PE		S 7F22 A	S 3459 C
with activated carbons / ai carboni attivi	OM470LA	315	428	09/12	>				S 4349 CA
with outer front air intake / con presa aria frontale, esterno	OM470LA	315	428	09/12	>			S 7F20 A	
LONG LIFE	OM470LA	315	428	09/12	>			S 7F21 A	
power steering / servosterzo	OM470LA	315	428	09/12	>				S 3081 PO
cabin ventilation / ventilazione cabina	OM470LA	315	428	09/12	>				S 3448 C
dusty areas / zone polverose	OM470LA	315	428	09/12	>				S 3453 C
2545 BlueTec 5/6/EEV	OM471LA	330	449	09/11	>	S 5156 PE		S 7F22 A	S 3459 C
with activated carbons / ai carboni attivi	OM471LA	330	449	09/11	>				S 4349 CA
with outer front air intake / con presa aria frontale, esterno	OM471LA	330	449	09/11	>			S 7F20 A	
dryer filter / filtro essiccatore	OM471LA	330	449	09/11	>				S 7A66 A
LONG LIFE	OM471LA	330	449	09/11	>			S 7F21 A	
power steering / servosterzo	OM471LA	330	449	09/11	>				S 3081 PO
cabin ventilation / ventilazione cabina	OM471LA	330	449	09/11	>				S 3448 C
2548 BlueTec 5/6/EEV	OM471LA	350	476	09/11	>	S 5156 PE		S 7F22 A	S 3459 C
with activated carbons / ai carboni attivi	OM471LA	350	476	09/11	>				S 4349 CA
with outer front air intake / con presa aria frontale, esterno	OM471LA	350	476	09/11	>			S 7F20 A	
dryer filter / filtro essiccatore	OM471LA	350	476	09/11	>				S 7A66 A
LONG LIFE	OM471LA	350	476	09/11	>			S 7F21 A	
power steering / servosterzo	OM471LA	350	476	09/11	>				S 3081 PO
cabin ventilation / ventilazione cabina	OM471LA	350	476	09/11	>				S 3448 C
2551 BlueTec 5/6/EEV	OM471LA	375	510	09/11	>	S 5156 PE		S 7F22 A	S 3459 C
with activated carbons / ai carboni attivi	OM471LA	375	510	09/11	>				S 4349 CA
with outer front air intake / con presa aria frontale, esterno	OM471LA	375	510	09/11	>			S 7F20 A	
dryer filter / filtro essiccatore	OM471LA	375	510	09/11	>				S 7A66 A
LONG LIFE	OM471LA	375	510	09/11	>			S 7F21 A	
power steering / servosterzo	OM471LA	375	510	09/11	>				S 3081 PO
cabin ventilation / ventilazione cabina	OM471LA	375	510	09/11	>				S 3448 C
2627 BlueTec 5/6/EEV	OM936LA	200	272	09/12	>	S 5236 PE	S 6148 NE	S 7F22 A	S 3459 C
with activated carbons / ai carboni attivi	OM936LA	200	272	09/12	>				S 4349 CA
with outer front air intake / con presa aria frontale, esterno	OM936LA	200	272	09/12	>			S 7F20 A	
LONG LIFE	OM936LA	200	272	09/12	>			S 7F21 A	
power steering / servosterzo	OM936LA	200	272	09/12	>				S 3081 PO
cabin ventilation / ventilazione cabina	OM936LA	200	272	09/12	>				S 3448 C
dusty areas / zone polverose	OM936LA	200	272	09/12	>				S 3453 C
2630 BlueTec 5/6/EEV	OM936LA	220	299	09/12	>	S 5236 PE	S 6148 NE	S 7F22 A	S 3459 C
with activated carbons / ai carboni attivi	OM936LA	220	299	09/12	>				S 4349 CA
with outer front air intake / con presa aria frontale, esterno	OM936LA	220	299	09/12	>			S 7F20 A	
LONG LIFE	OM936LA	220	299	09/12	>			S 7F21 A	
power steering / servosterzo	OM936LA	220	299	09/12	>				S 3081 PO
cabin ventilation / ventilazione cabina	OM936LA	220	299	09/12	>				S 3448 C
dusty areas / zone polverose	OM936LA	220	299	09/12	>				S 3453 C
2632 BlueTec 5/6/EEV	OM936LA	235	320	09/12	>	S 5236 PE	S 6148 NE	S 7F22 A	
with activated carbons / ai carboni attivi	OM936LA	235	320	09/12	>				S 4349 CA
with outer front air intake / con presa aria frontale, esterno	OM936LA	235	320	09/12	>			S 7F20 A	
LONG LIFE	OM936LA	235	320	09/12	>			S 7F21 A	
power steering / servosterzo	OM936LA	235	320	09/12	>				S 3081 PO
cabin ventilation / ventilazione cabina	OM936LA	235	320	09/12	>				S 3448 C
dusty areas / zone polverose	OM936LA	235	320	09/12	>				S 3453 C
2633 BlueTec 5/6/EEV	OM470LA	240	326	09/12	>	S 5237 PE		S 7F22 A	S 3459 C
with activated carbons / ai carboni attivi	OM470LA	240	326	09/12	>				S 4349 CA
with outer front air intake / con presa aria frontale, esterno	OM470LA	240	326	09/12	>			S 7F20 A	
dryer filter / filtro essiccatore	OM470LA	240	326	09/12	>				S 7A66 A
LONG LIFE	OM470LA	240	326	09/12	>			S 7F21 A	
power steering / servosterzo	OM470LA	240	326	09/12	>				S 3081 PO
cabin ventilation / ventilazione cabina	OM470LA	240	326	09/12	>				S 3448 C
dusty areas / zone polverose	OM470LA	240	326	09/12	>				S 3453 C

M



...MERCEDES BENZ - trucks/autocarri

M

2635 BlueTec 5/6/EEV	OM936LA	260	353	09/12	>	S 5236 PE	S 6148 NE	S 7F22 A	S 3459 C
with activated carbons / ai carboni attivi	OM936LA	260	353	09/12	>				S 4349 CA
with outer front air intake / con presa aria frontale, esterno	OM936LA	260	353	09/12	>			S 7F20 A	
LONG LIFE	OM936LA	260	353	09/12	>			S 7F21 A	
power steering / servosterzo	OM936LA	260	353	09/12	>				S 3081 PO
cabin ventilation / ventilazione cabina	OM936LA	260	353	09/12	>				S 3448 C
dusty areas / zone polverose	OM936LA	260	353	09/12	>				S 3453 C
2636 BlueTec 5/6/EEV	OM470LA	265	360	09/12	>	S 5237 PE		S 7F22 A	S 3459 C
with activated carbons / ai carboni attivi	OM470LA	265	360	09/12	>				S 4349 CA
with outer front air intake / con presa aria frontale, esterno	OM470LA	265	360	09/12	>			S 7F20 A	
dryer filter / filtro essiccatore	OM470LA	265	360	09/12	>				S 7A66 A
LONG LIFE	OM470LA	265	360	09/12	>			S 7F21 A	
power steering / servosterzo	OM470LA	265	360	09/12	>				S 3081 PO
cabin ventilation / ventilazione cabina	OM470LA	265	360	09/12	>				S 3448 C
dusty areas / zone polverose	OM470LA	265	360	09/12	>				S 3453 C
2640 BlueTec 5/6/EEV	OM470LA	290	394	09/12	>	S 5237 PE		S 7F22 A	S 3459 C
with activated carbons / ai carboni attivi	OM470LA	290	394	09/12	>				S 4349 CA
with outer front air intake / con presa aria frontale, esterno	OM470LA	290	394	09/12	>			S 7F20 A	
LONG LIFE	OM470LA	290	394	09/12	>			S 7F21 A	
power steering / servosterzo	OM470LA	290	394	09/12	>				S 3081 PO
cabin ventilation / ventilazione cabina	OM470LA	290	394	09/12	>				S 3448 C
dusty areas / zone polverose	OM470LA	290	394	09/12	>				S 3453 C
2642 BlueTec 5/6/EEV	OM471LA	310	421	09/11	>	S 5156 PE		S 7F22 A	S 3459 C
with activated carbons / ai carboni attivi	OM471LA	310	421	09/11	>				S 4349 CA
with outer front air intake / con presa aria frontale, esterno	OM471LA	310	421	09/11	>			S 7F20 A	
dryer filter / filtro essiccatore	OM471LA	310	421	09/11	>				S 7A66 A
LONG LIFE	OM471LA	310	421	09/11	>			S 7F21 A	
power steering / servosterzo	OM471LA	310	421	09/11	>				S 3081 PO
cabin ventilation / ventilazione cabina	OM471LA	310	421	09/11	>				S 3448 C
2643 BlueTec 5/6/EEV	OM470LA	315	428	09/12	>	S 5237 PE		S 7F22 A	S 3459 C
with activated carbons / ai carboni attivi	OM470LA	315	428	09/12	>				S 4349 CA
with outer front air intake / con presa aria frontale, esterno	OM470LA	315	428	09/12	>			S 7F20 A	
LONG LIFE	OM470LA	315	428	09/12	>			S 7F21 A	
cabin ventilation / ventilazione cabina	OM470LA	315	428	09/12	>				S 3448 C
dusty areas / zone polverose	OM470LA	315	428	09/12	>				S 3453 C
2645 BlueTec 5/6/EEV	OM471LA	330	449	09/11	>	S 5156 PE		S 7F22 A	S 3459 C
with activated carbons / ai carboni attivi	OM471LA	330	449	09/11	>				S 4349 CA
with outer front air intake / con presa aria frontale, esterno	OM471LA	330	449	09/11	>			S 7F20 A	
dryer filter / filtro essiccatore	OM471LA	330	449	09/11	>				S 7A66 A
LONG LIFE	OM471LA	330	449	09/11	>			S 7F21 A	
power steering / servosterzo	OM471LA	330	449	09/11	>				S 3081 PO
cabin ventilation / ventilazione cabina	OM471LA	330	449	09/11	>				S 3448 C
2648 BlueTec 5/6/EEV	OM471LA	350	476	09/11	>	S 5156 PE		S 7F22 A	S 3459 C
with activated carbons / ai carboni attivi	OM471LA	350	476	09/11	>				S 4349 CA
with outer front air intake / con presa aria frontale, esterno	OM471LA	350	476	09/11	>			S 7F20 A	
dryer filter / filtro essiccatore	OM471LA	350	476	09/11	>				S 7A66 A
LONG LIFE	OM471LA	350	476	09/11	>			S 7F21 A	
power steering / servosterzo	OM471LA	350	476	09/11	>				S 3081 PO
cabin ventilation / ventilazione cabina	OM471LA	350	476	09/11	>				S 3448 C
2651 BlueTec 5/6/EEV	OM471LA	375	510	09/11	>	S 5156 PE		S 7F22 A	S 3459 C
with activated carbons / ai carboni attivi	OM471LA	375	510	09/11	>				S 4349 CA
with outer front air intake / con presa aria frontale, esterno	OM471LA	375	510	09/11	>			S 7F20 A	
dryer filter / filtro essiccatore	OM471LA	375	510	09/11	>				S 7A66 A
LONG LIFE	OM471LA	375	510	09/11	>			S 7F21 A	
power steering / servosterzo	OM471LA	375	510	09/11	>				S 3081 PO
cabin ventilation / ventilazione cabina	OM471LA	375	510	09/11	>				S 3448 C
3333 BlueTec 5/6/EEV	OM470LA	240	326	09/12	>	S 5237 PE		S 7F22 A	S 3459 C
with activated carbons / ai carboni attivi	OM470LA	240	326	09/12	>				S 4349 CA
with outer front air intake / con presa aria frontale, esterno	OM470LA	240	326	09/12	>			S 7F20 A	
LONG LIFE	OM470LA	240	326	09/12	>			S 7F21 A	
power steering / servosterzo	OM470LA	240	326	09/12	>				S 3081 PO
cabin ventilation / ventilazione cabina	OM470LA	240	326	09/12	>				S 3448 C
dusty areas / zone polverose	OM470LA	240	326	09/12	>				S 3453 C
3336 BlueTec 5/6/EEV	OM470LA	265	360	09/12	>	S 5237 PE		S 7F22 A	S 3459 C
with activated carbons / ai carboni attivi	OM470LA	265	360	09/12	>				S 4349 CA
with outer front air intake / con presa aria frontale, esterno	OM470LA	265	360	09/12	>			S 7F20 A	
LONG LIFE	OM470LA	265	360	09/12	>			S 7F21 A	

**KW HP**

...MERCEDES BENZ - trucks/autocarri

power steering / servosterzo	OM470LA	265	360	09/12	>			S 3081 PO
cabin ventilation / ventilazione cabina	OM470LA	265	360	09/12	>			S 3448 C
dusty areas / zone polverose	OM470LA	265	360	09/12	>			S 3453 C
3340 BlueTec 5/6/EEV	OM470LA	290	394	09/12	>	S 5237 PE	S 7F22 A	S 3459 C
with activated carbons / ai carboni attivi	OM470LA	290	394	09/12	>			S 4349 CA
with outer front air intake / con presa aria frontale, esterno	OM470LA	290	394	09/12	>		S 7F20 A	
LONG LIFE	OM470LA	290	394	09/12	>		S 7F21 A	
power steering / servosterzo	OM470LA	290	394	09/12	>			S 3081 PO
cabin ventilation / ventilazione cabina	OM470LA	290	394	09/12	>			S 3448 C
dusty areas / zone polverose	OM470LA	290	394	09/12	>			S 3453 C
3342 BlueTec 5/6/EEV	OM471LA	310	421	09/11	>	S 5156 PE	S 7F22 A	S 3459 C
with activated carbons / ai carboni attivi	OM471LA	310	421	09/11	>			S 4349 CA
with outer front air intake / con presa aria frontale, esterno	OM471LA	310	421	09/11	>		S 7F20 A	
dryer filter / filtro essiccatore	OM471LA	310	421	09/11	>			S 7A66 A
LONG LIFE	OM471LA	310	421	09/11	>		S 7F21 A	
power steering / servosterzo	OM471LA	310	421	09/11	>			S 3081 PO
cabin ventilation / ventilazione cabina	OM471LA	310	421	09/11	>			S 3448 C
3343 BlueTec 5/6/EEV	OM470LA	315	428	09/12	>	S 5237 PE	S 7F22 A	S 3459 C
with activated carbons / ai carboni attivi	OM470LA	315	428	09/12	>			S 4349 CA
with outer front air intake / con presa aria frontale, esterno	OM470LA	315	428	09/12	>		S 7F20 A	
LONG LIFE	OM470LA	315	428	09/12	>		S 7F21 A	
power steering / servosterzo	OM470LA	315	428	09/12	>			S 3081 PO
cabin ventilation / ventilazione cabina	OM470LA	315	428	09/12	>			S 3448 C
dusty areas / zone polverose	OM470LA	315	428	09/12	>			S 3453 C
3345 BlueTec 5/6/EEV	OM471LA	330	449	09/11	>	S 5156 PE	S 7F22 A	S 3459 C
with activated carbons / ai carboni attivi	OM471LA	330	449	09/11	>			S 4349 CA
with outer front air intake / con presa aria frontale, esterno	OM471LA	330	449	09/11	>		S 7F20 A	
dryer filter / filtro essiccatore	OM471LA	330	449	09/11	>			S 7A66 A
LONG LIFE	OM471LA	330	449	09/11	>		S 7F21 A	
power steering / servosterzo	OM471LA	330	449	09/11	>			S 3081 PO
cabin ventilation / ventilazione cabina	OM471LA	330	449	09/11	>			S 3448 C
3348 BlueTec 5/6/EEV	OM471LA	350	476	09/11	>	S 5156 PE	S 7F22 A	S 3459 C
with activated carbons / ai carboni attivi	OM471LA	350	476	09/11	>			S 4349 CA
with outer front air intake / con presa aria frontale, esterno	OM471LA	350	476	09/11	>		S 7F20 A	
dryer filter / filtro essiccatore	OM471LA	350	476	09/11	>			S 7A66 A
LONG LIFE	OM471LA	350	476	09/11	>		S 7F21 A	
power steering / servosterzo	OM471LA	350	476	09/11	>			S 3081 PO
cabin ventilation / ventilazione cabina	OM471LA	350	476	09/11	>			S 3448 C
3351 BlueTec 5/6/EEV	OM471LA	375	510	09/11	>	S 5156 PE	S 7F22 A	S 3459 C
with activated carbons / ai carboni attivi	OM471LA	375	510	09/11	>			S 4349 CA
with outer front air intake / con presa aria frontale, esterno	OM471LA	375	510	09/11	>		S 7F20 A	
dryer filter / filtro essiccatore	OM471LA	375	510	09/11	>			S 7A66 A
LONG LIFE	OM471LA	375	510	09/11	>		S 7F21 A	
power steering / servosterzo	OM471LA	375	510	09/11	>			S 3081 PO
cabin ventilation / ventilazione cabina	OM471LA	375	510	09/11	>			S 3448 C
4152 BlueTec 5/6/EEV	OM473LA	380	517	01/14	>	S 5156 PE	S 7F22 A	S 3459 C
with activated carbons / ai carboni attivi	OM473LA	380	517	01/14	>			S 4349 CA
with outer front air intake / con presa aria frontale, esterno	OM473LA	380	517	01/14	>		S 7F20 A	
dryer filter / filtro essiccatore	OM473LA	380	517	01/14	>			S 7A66 A
LONG LIFE	OM473LA	380	517	01/14	>		S 7F21 A	
power steering / servosterzo	OM473LA	380	517	01/14	>			S 3081 PO
4158 BlueTec 5/6/EEV	OM473LA	425	578	01/14	>	S 5156 PE	S 7F22 A	S 3459 C
with activated carbons / ai carboni attivi	OM473LA	425	578	01/14	>			S 4349 CA
with outer front air intake / con presa aria frontale, esterno	OM473LA	425	578	01/14	>		S 7F20 A	
dryer filter / filtro essiccatore	OM473LA	425	578	01/14	>			S 7A66 A
LONG LIFE	OM473LA	425	578	01/14	>		S 7F21 A	
power steering / servosterzo	OM473LA	425	578	01/14	>			S 3081 PO
cabin ventilation / ventilazione cabina	OM473LA	425	578	01/14	>			S 3448 C
4163 BlueTec 5/6/EEV	OM473LA	460	625	01/14	>	S 5156 PE	S 7F22 A	S 3459 C
with activated carbons / ai carboni attivi	OM473LA	460	625	01/14	>			S 4349 CA
with outer front air intake / con presa aria frontale, esterno	OM473LA	460	625	01/14	>		S 7F20 A	
dryer filter / filtro essiccatore	OM473LA	460	625	01/14	>			S 7A66 A
LONG LIFE	OM473LA	460	625	01/14	>		S 7F21 A	
power steering / servosterzo	OM473LA	460	625	01/14	>			S 3081 PO
cabin ventilation / ventilazione cabina	OM473LA	460	625	01/14	>			S 3448 C
Antos (963)								
1824 BlueTec 5/6/EEV								

M

**KW HP****...MERCEDES BENZ - trucks/autocarri****M**

with activated carbons / ai carboni attivi	OM936LA	175	238	09/12	>				S 4349 CA
with outer front air intake / con presa aria frontale, esterno	OM936LA	175	238	09/12	>			S 7F20 A	
LONG LIFE	OM936LA	175	238	09/12	>			S 7F21 A	
power steering / servosterzo	OM936LA	175	238	09/12	>				S 3081 PO
cabin ventilation / ventilazione cabina	OM936LA	175	238	09/12	>				S 3448 C
1827 BlueTec 5/6/EEV									
with activated carbons / ai carboni attivi	OM936LA	200	272	09/12	>				S 4349 CA
with outer front air intake / con presa aria frontale, esterno	OM936LA	200	272	09/12	>			S 7F20 A	
LONG LIFE	OM936LA	200	272	09/12	>			S 7F21 A	
power steering / servosterzo	OM936LA	200	272	09/12	>				S 3081 PO
cabin ventilation / ventilazione cabina	OM936LA	200	272	09/12	>				S 3448 C
1830 BlueTec 5/6/EEV									
with activated carbons / ai carboni attivi	OM936LA	220	299	09/12	>				S 4349 CA
with outer front air intake / con presa aria frontale, esterno	OM936LA	220	299	09/12	>			S 7F20 A	
LONG LIFE	OM936LA	220	299	09/12	>			S 7F21 A	
power steering / servosterzo	OM936LA	220	299	09/12	>				S 3081 PO
cabin ventilation / ventilazione cabina	OM936LA	220	299	09/12	>				S 3448 C
1832 BlueTec 5/6/EEV									
with activated carbons / ai carboni attivi	OM936LA	235	320	09/12	>				S 4349 CA
with outer front air intake / con presa aria frontale, esterno	OM936LA	235	320	09/12	>			S 7F20 A	
LONG LIFE	OM936LA	235	320	09/12	>			S 7F21 A	
power steering / servosterzo	OM936LA	235	320	09/12	>				S 3081 PO
cabin ventilation / ventilazione cabina	OM936LA	235	320	09/12	>				S 3448 C
1833 BlueTec 5/6/EEV									
with activated carbons / ai carboni attivi	OM470LA	240	326	09/12	>			S 7F22 A	S 3459 C
with outer front air intake / con presa aria frontale, esterno	OM470LA	240	326	09/12	>			S 7F20 A	S 4349 CA
LONG LIFE	OM470LA	240	326	09/94	>			S 7F21 A	
cabin ventilation / ventilazione cabina	OM470LA	240	326	09/12	>				S 3448 C
1835 BlueTec 5/6/EEV									
with activated carbons / ai carboni attivi	OM936LA	260	353	09/12	>				S 4349 CA
with outer front air intake / con presa aria frontale, esterno	OM936LA	260	353	09/12	>			S 7F20 A	
LONG LIFE	OM936LA	260	353	09/12	>			S 7F21 A	
power steering / servosterzo	OM936LA	260	353	09/12	>				S 3081 PO
cabin ventilation / ventilazione cabina	OM936LA	260	353	09/12	>				S 3448 C
1836 BlueTec 5/6/EEV									
with activated carbons / ai carboni attivi	OM470LA	265	360	09/12	>			S 7F22 A	S 3459 C
with outer front air intake / con presa aria frontale, esterno	OM470LA	265	360	09/12	>			S 7F20 A	S 4349 CA
LONG LIFE	OM470LA	265	360	09/12	>			S 7F21 A	
cabin ventilation / ventilazione cabina	OM470LA	265	360	09/12	>				S 3448 C
1840 BlueTec 5/6/EEV									
with activated carbons / ai carboni attivi	OM470LA	290	394	09/12	>			S 7F22 A	S 3459 C
with outer front air intake / con presa aria frontale, esterno	OM470LA	290	394	09/12	>			S 7F20 A	S 4349 CA
LONG LIFE	OM470LA	290	394	09/12	>			S 7F21 A	
cabin ventilation / ventilazione cabina	OM470LA	290	394	09/12	>				S 3448 C
1842 BlueTec 5/6/EEV									
with activated carbons / ai carboni attivi	OM471LA	310	421	09/12	>	S 5156 PE		S 7F22 A	S 3459 C
with outer front air intake / con presa aria frontale, esterno	OM471LA	310	421	09/12	>			S 7F20 A	S 4349 CA
LONG LIFE	OM471LA	310	421	09/12	>			S 7F21 A	
power steering / servosterzo	OM471LA	310	421	09/12	>				S 3081 PO
cabin ventilation / ventilazione cabina	OM471LA	310	421	09/12	>				S 3448 C
1843 BlueTec 5/6/EEV									
with activated carbons / ai carboni attivi	OM470LA	315	428	09/12	>			S 7F22 A	S 3459 C
with outer front air intake / con presa aria frontale, esterno	OM470LA	315	428	09/12	>			S 7F20 A	S 4349 CA
LONG LIFE	OM470LA	315	428	09/12	>			S 7F21 A	
cabin ventilation / ventilazione cabina	OM470LA	315	428	09/12	>				S 3448 C
1845 BlueTec 5/6/EEV									
with activated carbons / ai carboni attivi	OM471LA	330	449	09/12	>	S 5156 PE		S 7F22 A	S 3459 C
with outer front air intake / con presa aria frontale, esterno	OM471LA	330	449	09/12	>			S 7F20 A	S 4349 CA
LONG LIFE	OM471LA	330	449	09/12	>			S 7F21 A	
power steering / servosterzo	OM471LA	330	449	09/12	>				S 3081 PO
cabin ventilation / ventilazione cabina	OM471LA	330	449	09/12	>				S 3448 C
1848 BlueTec 5/6/EEV									
with activated carbons / ai carboni attivi	OM471LA	350	476	09/12	>	S 5156 PE		S 7F22 A	S 3459 C
with outer front air intake / con presa aria frontale, esterno	OM471LA	350	476	09/12	>			S 7F20 A	S 4349 CA
LONG LIFE	OM471LA	350	476	09/12	>			S 7F21 A	
power steering / servosterzo	OM471LA	350	476	09/12	>				S 3081 PO
cabin ventilation / ventilazione cabina	OM471LA	350	476	09/12	>				S 3448 C



...MERCEDES BENZ - trucks/autocarri

1851 BlueTec 5/6/EEV	OM471LA	375	510	09/12	>	S 5156 PE		S 7F22 A	S 3459 C
with activated carbons / ai carboni attivi	OM471LA	375	510	09/12	>				S 4349 CA
with outer front air intake / con presa aria frontale, esterno	OM471LA	375	510	09/12	>			S 7F20 A	
LONG LIFE	OM471LA	375	510	09/12	>			S 7F21 A	
power steering / servosterzo	OM471LA	375	510	09/12	>				S 3081 PO
cabin ventilation / ventilazione cabina	OM471LA	375	510	09/12	>				S 3448 C
2024 BlueTec 5/6/EEV									
with activated carbons / ai carboni attivi	OM936LA	175	238	09/12	>				S 4349 CA
with outer front air intake / con presa aria frontale, esterno	OM936LA	175	238	09/12	>			S 7F20 A	
LONG LIFE	OM936LA	175	238	09/12	>			S 7F21 A	
power steering / servosterzo	OM936LA	175	238	09/12	>				S 3081 PO
cabin ventilation / ventilazione cabina	OM936LA	175	238	09/12	>				S 3448 C
2027 BlueTec 5/6/EEV									
with activated carbons / ai carboni attivi	OM936LA	200	272	09/12	>				S 4349 CA
with outer front air intake / con presa aria frontale, esterno	OM936LA	200	272	09/12	>			S 7F20 A	
LONG LIFE	OM936LA	200	272	09/12	>			S 7F21 A	
power steering / servosterzo	OM936LA	200	272	09/12	>				S 3081 PO
cabin ventilation / ventilazione cabina	OM936LA	200	272	09/12	>				S 3448 C
2030 BlueTec 5/6/EEV									
with activated carbons / ai carboni attivi	OM936LA	220	299	09/12	>				S 4349 CA
with outer front air intake / con presa aria frontale, esterno	OM936LA	220	299	09/12	>			S 7F20 A	
LONG LIFE	OM936LA	220	299	09/12	>			S 7F21 A	
power steering / servosterzo	OM936LA	220	299	09/12	>				S 3081 PO
cabin ventilation / ventilazione cabina	OM936LA	220	299	09/12	>				S 3448 C
2032 BlueTec 5/6/EEV									
with activated carbons / ai carboni attivi	OM936LA	235	320	09/12	>				S 4349 CA
with outer front air intake / con presa aria frontale, esterno	OM936LA	235	320	09/12	>			S 7F20 A	
LONG LIFE	OM936LA	235	320	09/12	>			S 7F21 A	
power steering / servosterzo	OM936LA	235	320	09/12	>				S 3081 PO
cabin ventilation / ventilazione cabina	OM936LA	235	320	09/12	>				S 3448 C
2033 BlueTec 5/6/EEV	OM470LA	240	326	09/12	>			S 7F22 A	S 3459 C
with activated carbons / ai carboni attivi	OM470LA	240	326	09/12	>				S 4349 CA
with outer front air intake / con presa aria frontale, esterno	OM470LA	240	326	09/12	>			S 7F20 A	
LONG LIFE	OM470LA	240	326	09/12	>			S 7F21 A	
cabin ventilation / ventilazione cabina	OM470LA	240	326	09/12	>				S 3448 C
2035 BlueTec 5/6/EEV									
with activated carbons / ai carboni attivi	OM936LA	260	353	09/12	>				S 4349 CA
with outer front air intake / con presa aria frontale, esterno	OM936LA	260	353	09/12	>			S 7F20 A	
LONG LIFE	OM936LA	260	353	09/12	>			S 7F21 A	
power steering / servosterzo	OM936LA	260	353	09/12	>				S 3081 PO
cabin ventilation / ventilazione cabina	OM936LA	260	353	09/12	>				S 3448 C
2036 BlueTec 5/6/EEV	OM470LA	265	360	09/12	>			S 7F22 A	S 3459 C
with activated carbons / ai carboni attivi	OM470LA	265	360	09/12	>				S 4349 CA
with outer front air intake / con presa aria frontale, esterno	OM470LA	265	360	09/12	>			S 7F20 A	
LONG LIFE	OM470LA	265	360	09/12	>			S 7F21 A	
cabin ventilation / ventilazione cabina	OM470LA	265	360	09/12	>				S 3448 C
2040 BlueTec 5/6/EEV	OM470LA	290	394	09/12	>			S 7F22 A	S 3459 C
with activated carbons / ai carboni attivi	OM470LA	290	394	09/12	>				S 4349 CA
with outer front air intake / con presa aria frontale, esterno	OM470LA	290	394	09/12	>			S 7F20 A	
LONG LIFE	OM470LA	290	394	09/12	>			S 7F21 A	
cabin ventilation / ventilazione cabina	OM470LA	290	394	09/12	>				S 3448 C
2042 BlueTec 5/6/EEV	OM471LA	310	421	09/12	>	S 5156 PE		S 7F22 A	S 3459 C
with activated carbons / ai carboni attivi	OM471LA	310	421	09/12	>				S 4349 CA
with outer front air intake / con presa aria frontale, esterno	OM471LA	310	421	09/12	>			S 7F20 A	
LONG LIFE	OM471LA	310	421	09/12	>			S 7F21 A	
power steering / servosterzo	OM471LA	310	421	09/12	>				S 3081 PO
cabin ventilation / ventilazione cabina	OM471LA	310	421	09/12	>				S 3448 C
2043 BlueTec 5/6/EEV	OM470LA	315	428	09/12	>			S 7F22 A	S 3459 C
with activated carbons / ai carboni attivi	OM470LA	315	428	09/12	>				S 4349 CA
with outer front air intake / con presa aria frontale, esterno	OM470LA	315	428	09/12	>			S 7F20 A	
LONG LIFE	OM470LA	315	428	09/12	>			S 7F21 A	
cabin ventilation / ventilazione cabina	OM470LA	315	428	09/12	>				S 3448 C
2045 BlueTec 5/6/EEV	OM471LA	330	449	09/12	>	S 5156 PE		S 7F22 A	S 3459 C
with activated carbons / ai carboni attivi	OM471LA	330	449	09/12	>				S 4349 CA
with outer front air intake / con presa aria frontale, esterno	OM471LA	330	449	09/12	>			S 7F20 A	
LONG LIFE	OM471LA	330	449	09/12	>			S 7F21 A	
power steering / servosterzo	OM471LA	330	449	09/12	>				S 3081 PO

M

**kW HP****...MERCEDES BENZ - trucks/autocarri****M**

cabin ventilation / ventilazione cabina	OM471LA	330	449	09/12 >				S 3448 C
2048 BlueTec 5/6/EEV	OM471LA	350	476	09/12 >	S 5156 PE		S 7F22 A	S 3459 C
with activated carbons / ai carboni attivi	OM471LA	350	476	09/12 >				S 4349 CA
with outer front air intake / con presa aria frontale, esterno	OM471LA	350	476	09/12 >			S 7F20 A	
LONG LIFE	OM471LA	350	476	09/12 >			S 7F21 A	
power steering / servosterzo	OM471LA	350	476	09/12 >				S 3081 PO
cabin ventilation / ventilazione cabina	OM471LA	350	476	09/12 >				S 3448 C
2051 BlueTec 5/6/EEV	OM471LA	375	510	09/12 >	S 5156 PE		S 7F22 A	S 3459 C
with activated carbons / ai carboni attivi	OM471LA	375	510	09/12 >				S 4349 CA
with outer front air intake / con presa aria frontale, esterno	OM471LA	375	510	09/12 >			S 7F20 A	
LONG LIFE	OM471LA	375	510	09/12 >			S 7F21 A	
power steering / servosterzo	OM471LA	375	510	09/12 >				S 3081 PO
cabin ventilation / ventilazione cabina	OM471LA	375	510	09/12 >				S 3448 C
2427 BlueTec 5/6/EEV								
with activated carbons / ai carboni attivi	OM936LA	200	272	09/12 >				S 4349 CA
with outer front air intake / con presa aria frontale, esterno	OM936LA	200	272	09/12 >			S 7F20 A	
LONG LIFE	OM936LA	200	272	09/12 >			S 7F21 A	
power steering / servosterzo	OM936LA	200	272	09/12 >				S 3081 PO
cabin ventilation / ventilazione cabina	OM936LA	200	272	09/12 >				S 3448 C
2430 BlueTec 5/6/EEV								
with activated carbons / ai carboni attivi	OM936LA	220	299	09/12 >				S 4349 CA
with outer front air intake / con presa aria frontale, esterno	OM936LA	220	299	09/12 >			S 7F20 A	
LONG LIFE	OM936LA	220	299	09/12 >			S 7F21 A	
power steering / servosterzo	OM936LA	220	299	09/12 >				S 3081 PO
cabin ventilation / ventilazione cabina	OM936LA	220	299	09/12 >				S 3448 C
2432 BlueTec 5/6/EEV								
with activated carbons / ai carboni attivi	OM936LA	235	320	09/12 >				S 4349 CA
with outer front air intake / con presa aria frontale, esterno	OM936LA	235	320	09/12 >			S 7F20 A	
LONG LIFE	OM936LA	235	320	09/12 >			S 7F21 A	
power steering / servosterzo	OM936LA	235	320	09/12 >				S 3081 PO
cabin ventilation / ventilazione cabina	OM936LA	235	320	09/12 >				S 3448 C
2433 BlueTec 5/6/EEV	OM470LA	240	326	09/12 >			S 7F22 A	S 3459 C
with activated carbons / ai carboni attivi	OM470LA	240	326	09/12 >				S 4349 CA
with outer front air intake / con presa aria frontale, esterno	OM470LA	240	326	09/12 >			S 7F20 A	
LONG LIFE	OM470LA	240	326	09/12 >			S 7F21 A	
cabin ventilation / ventilazione cabina	OM470LA	240	326	09/12 >				S 3448 C
2435 BlueTec 5/6/EEV								
with activated carbons / ai carboni attivi	OM936LA	260	353	09/12 >				S 4349 CA
with outer front air intake / con presa aria frontale, esterno	OM936LA	260	353	09/12 >			S 7F20 A	
LONG LIFE	OM936LA	260	353	09/12 >			S 7F21 A	
power steering / servosterzo	OM936LA	260	353	09/12 >				S 3081 PO
cabin ventilation / ventilazione cabina	OM936LA	260	353	09/12 >				S 3448 C
2436 BlueTec 5/6/EEV	OM470LA	265	360	09/12 >			S 7F22 A	S 3459 C
with activated carbons / ai carboni attivi	OM470LA	265	360	09/12 >				S 4349 CA
with outer front air intake / con presa aria frontale, esterno	OM470LA	265	360	09/12 >			S 7F20 A	
LONG LIFE	OM470LA	265	360	09/12 >			S 7F21 A	
cabin ventilation / ventilazione cabina	OM470LA	265	360	09/12 >				S 3448 C
2440 BlueTec 5/6/EEV	OM470LA	290	394	09/12 >			S 7F22 A	S 3459 C
with activated carbons / ai carboni attivi	OM470LA	290	394	09/12 >				S 4349 CA
with outer front air intake / con presa aria frontale, esterno	OM470LA	290	394	09/12 >			S 7F20 A	
LONG LIFE	OM470LA	290	394	09/12 >			S 7F21 A	
cabin ventilation / ventilazione cabina	OM470LA	290	394	09/12 >				S 3448 C
2442 BlueTec 5/6/EEV	OM471LA	310	421	09/12 >	S 5156 PE		S 7F22 A	S 3459 C
with activated carbons / ai carboni attivi	OM471LA	310	421	09/12 >				S 4349 CA
with outer front air intake / con presa aria frontale, esterno	OM471LA	310	421	09/12 >			S 7F20 A	
LONG LIFE	OM471LA	310	421	09/12 >			S 7F21 A	
power steering / servosterzo	OM471LA	310	421	09/12 >				S 3081 PO
cabin ventilation / ventilazione cabina	OM471LA	310	421	09/12 >				S 3448 C
2443 BlueTec 5/6/EEV	OM470LA	315	428	09/12 >			S 7F22 A	S 3459 C
with activated carbons / ai carboni attivi	OM470LA	315	428	09/12 >				S 4349 CA
with outer front air intake / con presa aria frontale, esterno	OM470LA	315	428	09/12 >			S 7F20 A	
LONG LIFE	OM470LA	315	428	09/12 >			S 7F21 A	
cabin ventilation / ventilazione cabina	OM470LA	315	428	09/12 >				S 3448 C
2445 BlueTec 5/6/EEV	OM471LA	330	449	09/12 >	S 5156 PE		S 7F22 A	S 3459 C
with activated carbons / ai carboni attivi	OM471LA	330	449	09/12 >				S 4349 CA
with outer front air intake / con presa aria frontale, esterno	OM471LA	330	449	09/12 >			S 7F20 A	
LONG LIFE	OM471LA	330	449	09/12 >			S 7F21 A	

**KW HP****...MERCEDES BENZ - trucks/autocarri**

power steering / servosterzo	OM471LA	330	449	09/12	>			S 3081 PO
cabin ventilation / ventilazione cabina	OM471LA	330	449	09/12	>			S 3448 C
2448 BlueTec 5/6/EEV	OM471LA	350	476	09/12	>	S 5156 PE	S 7F22 A	S 3459 C
with activated carbons / ai carboni attivi	OM471LA	350	476	09/12	>			S 4349 CA
with outer front air intake / con presa aria frontale, esterno	OM471LA	350	476	09/12	>		S 7F20 A	
LONG LIFE	OM471LA	350	476	09/12	>		S 7F21 A	
power steering / servosterzo	OM471LA	350	476	09/12	>			S 3081 PO
cabin ventilation / ventilazione cabina	OM471LA	350	476	09/12	>			S 3448 C
2451 BlueTec 5/6/EEV	OM471LA	375	510	09/12	>	S 5156 PE	S 7F22 A	S 3459 C
with activated carbons / ai carboni attivi	OM471LA	375	510	09/12	>			S 4349 CA
with outer front air intake / con presa aria frontale, esterno	OM471LA	375	510	09/12	>		S 7F20 A	
LONG LIFE	OM471LA	375	510	09/12	>		S 7F21 A	
power steering / servosterzo	OM471LA	375	510	09/12	>			S 3081 PO
cabin ventilation / ventilazione cabina	OM471LA	375	510	09/12	>			S 3448 C
2527 BlueTec 5/6/EEV								
with activated carbons / ai carboni attivi	OM936LA	200	272	09/12	>			S 4349 CA
with outer front air intake / con presa aria frontale, esterno	OM936LA	200	272	09/12	>		S 7F20 A	
LONG LIFE	OM936LA	200	272	09/12	>		S 7F21 A	
power steering / servosterzo	OM936LA	200	272	09/12	>			S 3081 PO
cabin ventilation / ventilazione cabina	OM936LA	200	272	09/12	>			S 3448 C
2530 BlueTec 5/6/EEV								
with activated carbons / ai carboni attivi	OM936LA	220	299	09/12	>			S 4349 CA
with outer front air intake / con presa aria frontale, esterno	OM936LA	220	299	09/12	>		S 7F20 A	
LONG LIFE	OM936LA	220	299	09/12	>		S 7F21 A	
power steering / servosterzo	OM936LA	220	299	09/12	>			S 3081 PO
cabin ventilation / ventilazione cabina	OM936LA	220	299	09/12	>			S 3448 C
2532 BlueTec 5/6/EEV								
with activated carbons / ai carboni attivi	OM936LA	235	320	09/12	>			S 4349 CA
with outer front air intake / con presa aria frontale, esterno	OM936LA	235	320	09/12	>		S 7F20 A	
LONG LIFE	OM936LA	235	320	09/12	>		S 7F21 A	
power steering / servosterzo	OM936LA	235	320	09/12	>			S 3081 PO
cabin ventilation / ventilazione cabina	OM936LA	235	320	09/12	>			S 3448 C
2533 BlueTec 5/6/EEV	OM470LA	240	326	09/12	>		S 7F22 A	S 3459 C
with activated carbons / ai carboni attivi	OM470LA	240	326	09/12	>			S 4349 CA
with outer front air intake / con presa aria frontale, esterno	OM470LA	240	326	09/12	>		S 7F20 A	
LONG LIFE	OM470LA	240	326	09/12	>		S 7F21 A	
cabin ventilation / ventilazione cabina	OM470LA	240	326	09/12	>			S 3448 C
2535 BlueTec 5/6/EEV								
with activated carbons / ai carboni attivi	OM936LA	260	353	09/12	>			S 4349 CA
with outer front air intake / con presa aria frontale, esterno	OM936LA	260	353	09/12	>		S 7F20 A	
LONG LIFE	OM936LA	260	353	09/12	>		S 7F21 A	
power steering / servosterzo	OM936LA	260	353	09/12	>			S 3081 PO
cabin ventilation / ventilazione cabina	OM936LA	260	353	09/12	>			S 3448 C
2536 BlueTec 5/6/EEV	OM470LA	265	360	09/12	>		S 7F22 A	S 3459 C
with activated carbons / ai carboni attivi	OM470LA	265	360	09/12	>			S 4349 CA
with outer front air intake / con presa aria frontale, esterno	OM470LA	265	360	09/12	>		S 7F20 A	
LONG LIFE	OM470LA	265	360	09/12	>		S 7F21 A	
cabin ventilation / ventilazione cabina	OM470LA	265	360	09/12	>			S 3448 C
2540 BlueTec 5/6/EEV	OM470LA	290	394	09/12	>		S 7F22 A	S 3459 C
with activated carbons / ai carboni attivi	OM470LA	290	394	09/12	>			S 4349 CA
with outer front air intake / con presa aria frontale, esterno	OM470LA	290	394	09/12	>		S 7F20 A	
LONG LIFE	OM470LA	290	394	09/12	>		S 7F21 A	
cabin ventilation / ventilazione cabina	OM470LA	290	394	09/12	>			S 3448 C
2542 BlueTec 5/6/EEV	OM471LA	310	421	09/12	>	S 5156 PE	S 7F22 A	S 3459 C
with activated carbons / ai carboni attivi	OM471LA	310	421	09/12	>			S 4349 CA
with outer front air intake / con presa aria frontale, esterno	OM471LA	310	421	09/12	>		S 7F20 A	
LONG LIFE	OM471LA	310	421	09/12	>		S 7F21 A	
power steering / servosterzo	OM471LA	310	421	09/12	>			S 3081 PO
2543 BlueTec 5/6/EEV	OM470LA	315	428	09/12	>		S 7F22 A	S 3459 C
with activated carbons / ai carboni attivi	OM470LA	315	428	09/12	>			S 4349 CA
with outer front air intake / con presa aria frontale, esterno	OM470LA	315	428	09/12	>		S 7F20 A	
LONG LIFE	OM470LA	315	428	09/12	>		S 7F21 A	
cabin ventilation / ventilazione cabina	OM470LA	315	428	09/12	>			S 3448 C
2545 BlueTec 5/6/EEV	OM471LA	330	449	09/12	>	S 5156 PE	S 7F22 A	S 3459 C
with activated carbons / ai carboni attivi	OM471LA	330	449	09/12	>			S 4349 CA
with outer front air intake / con presa aria frontale, esterno	OM471LA	330	449	09/12	>		S 7F20 A	
LONG LIFE	OM471LA	330	449	09/12	>		S 7F21 A	

M

**KW HP****...MERCEDES BENZ - trucks/autocarri****M**

power steering / servosterzo	OM471LA	330	449	09/12	>			S 3081 PO
cabin ventilation / ventilazione cabina	OM471LA	330	449	09/12	>			S 3448 C
2548 BlueTec 5/6/EEV	OM471LA	350	476	09/12	>	S 5156 PE	S 7F22 A	S 3459 C
with activated carbons / ai carboni attivi	OM471LA	350	476	09/12	>			S 4349 CA
with outer front air intake / con presa aria frontale, esterno	OM471LA	350	476	09/12	>		S 7F20 A	
dryer filter KNORR-WABCO / filtro essiccatore KNORR-WABCO	OM471LA	350	476	09/12	>			S 3448 C
LONG LIFE	OM471LA	350	476	09/12	>		S 7F21 A	
power steering / servosterzo	OM471LA	350	476	09/12	>			S 3081 PO
2551 BlueTec 5/6/EEV	OM471LA	375	510	09/12	>	S 5156 PE	S 7F22 A	S 3459 C
with activated carbons / ai carboni attivi	OM471LA	375	510	09/12	>			S 4349 CA
with outer front air intake / con presa aria frontale, esterno	OM471LA	375	510	09/12	>		S 7F20 A	
LONG LIFE	OM471LA	375	510	09/12	>		S 7F21 A	
power steering / servosterzo	OM471LA	375	510	09/12	>			S 3081 PO
cabin ventilation / ventilazione cabina	OM471LA	375	510	09/12	>			S 3448 C
2627 BlueTec 5/6/EEV								
with activated carbons / ai carboni attivi	OM936LA	200	272	09/12	>			S 3439 C
with outer front air intake / con presa aria frontale, esterno	OM936LA	200	272	09/12	>		S 7F20 A	
LONG LIFE	OM936LA	200	272	09/12	>		S 7F21 A	
power steering / servosterzo	OM936LA	200	272	09/12	>			S 3081 PO
cabin ventilation / ventilazione cabina	OM936LA	200	272	09/12	>			S 3448 C
2630 BlueTec 5/6/EEV								
with activated carbons / ai carboni attivi	OM936LA	220	299	09/12	>			S 4349 CA
with outer front air intake / con presa aria frontale, esterno	OM936LA	220	299	09/12	>		S 7F20 A	
LONG LIFE	OM936LA	220	299	09/12	>		S 7F21 A	
power steering / servosterzo	OM936LA	220	299	09/12	>			S 3081 PO
cabin ventilation / ventilazione cabina	OM936LA	220	299	09/12	>			S 3448 C
2632 BlueTec 5/6/EEV								
with activated carbons / ai carboni attivi	OM936LA	235	320	09/12	>			S 4349 CA
with outer front air intake / con presa aria frontale, esterno	OM936LA	235	320	09/12	>		S 7F20 A	
LONG LIFE	OM936LA	235	320	09/12	>		S 7F21 A	
power steering / servosterzo	OM936LA	235	320	09/12	>			S 3081 PO
cabin ventilation / ventilazione cabina	OM936LA	235	320	09/12	>			S 3448 C
2633 BlueTec 5/6/EEV	OM470LA	240	326	09/12	>		S 7F22 A	S 3459 C
with activated carbons / ai carboni attivi	OM470LA	240	326	09/12	>			S 4349 CA
with outer front air intake / con presa aria frontale, esterno	OM470LA	240	326	09/12	>		S 7F20 A	
LONG LIFE	OM470LA	240	326	09/12	>		S 7F20 A	
cabin ventilation / ventilazione cabina	OM470LA	240	326	09/12	>			S 3448 C
2635 BlueTec 5/6/EEV								
with activated carbons / ai carboni attivi	OM936LA	260	353	09/12	>			S 4349 CA
with outer front air intake / con presa aria frontale, esterno	OM936LA	260	353	09/12	>		S 7F20 A	
LONG LIFE	OM936LA	260	353	09/12	>		S 7F21 A	
power steering / servosterzo	OM936LA	260	353	09/12	>			S 3081 PO
cabin ventilation / ventilazione cabina	OM936LA	260	353	09/12	>			S 3448 C
2636 BlueTec 5/6/EEV	OM470LA	265	360	09/12	>			S 3459 C
with activated carbons / ai carboni attivi	OM470LA	265	360	09/12	>			S 4349 CA
with outer front air intake / con presa aria frontale, esterno	OM470LA	265	360	09/12	>		S 7F20 A	
LONG LIFE	OM470LA	265	360	09/12	>		S 7F21 A	
cabin ventilation / ventilazione cabina	OM470LA	265	360	09/12	>			S 3448 C
2640 BlueTec 5/6/EEV	OM470LA	290	394	09/12	>		S 7F22 A	S 3459 C
with activated carbons / ai carboni attivi	OM470LA	290	394	09/12	>			S 4349 CA
with outer front air intake / con presa aria frontale, esterno	OM470LA	290	394	09/12	>		S 7F20 A	
with outer front air intake / con presa aria frontale, esterno	OM470LA	290	394	09/12	>		S 7F20 A	
LONG LIFE	OM470LA	290	394	09/12	>		S 7F21 A	
2642 BlueTec 5/6/EEV	OM471LA	310	421	09/12	>	S 5156 PE	S 7F22 A	S 3459 C
with activated carbons / ai carboni attivi	OM471LA	310	421	09/12	>			S 4349 CA
with outer front air intake / con presa aria frontale, esterno	OM471LA	310	421	09/12	>		S 7F20 A	
power steering / servosterzo	OM471LA	310	421	09/12	>			S 3081 PO
cabin ventilation / ventilazione cabina	OM471LA	310	421	09/12	>			S 3448 C
2643 BlueTec 5/6/EEV	OM470LA	315	428	09/12	>		S 7F22 A	S 3459 C
with activated carbons / ai carboni attivi	OM470LA	315	428	09/12	>			S 4349 CA
with outer front air intake / con presa aria frontale, esterno	OM470LA	315	428	09/12	>		S 7F20 A	
LONG LIFE	OM470LA	315	428	09/12	>		S 7F21 A	
cabin ventilation / ventilazione cabina	OM470LA	315	428	09/12	>			S 3448 C
2645 BlueTec 5/6/EEV	OM471LA	330	449	09/12	>	S 5156 PE	S 7F22 A	S 3459 C
with activated carbons / ai carboni attivi	OM471LA	330	449	09/12	>			S 4349 CA
with outer front air intake / con presa aria frontale, esterno	OM471LA	330	449	09/12	>		S 7F20 A	
LONG LIFE	OM471LA	330	449	09/12	>		S 7F21 A	



kW HP



...MERCEDES BENZ - trucks/autocarri

power steering / servosterzo	OM471LA	330	449	09/12	>			S 3081 PO
cabin ventilation / ventilazione cabina	OM471LA	330	449	09/12	>			S 3448 C
2648 BlueTec 5/6/EEV	OM471LA	350	476	09/12	>	S 5156 PE	S 7F22 A	S 3459 C
with activated carbons / ai carboni attivi	OM471LA	350	476	09/12	>			S 4349 CA
with outer front air intake / con presa aria frontale, esterno	OM471LA	350	476	09/12	>		S 7F20 A	
LONG LIFE	OM471LA	350	476	09/12	>		S 7F21 A	
power steering / servosterzo	OM471LA	350	476	09/12	>			S 3081 PO
cabin ventilation / ventilazione cabina	OM471LA	350	476	09/12	>			S 3448 C
2651 BlueTec 5/6/EEV	OM471LA	375	510	09/12	>	S 5156 PE	S 7F22 A	S 3459 C
with activated carbons / ai carboni attivi	OM471LA	375	510	09/12	>			S 4349 CA
with outer front air intake / con presa aria frontale, esterno	OM471LA	375	510	09/12	>		S 7F20 A	
LONG LIFE	OM471LA	375	510	09/12	>		S 7F21 A	
power steering / servosterzo	OM471LA	375	510	09/12	>			S 3081 PO
cabin ventilation / ventilazione cabina	OM471LA	375	510	09/12	>			S 3448 C
3333 BlueTec 5/6/EEV	OM470LA	240	326	09/12	>		S 7F22 A	S 3459 C
with activated carbons / ai carboni attivi	OM470LA	240	326	09/12	>			S 4349 CA
with outer front air intake / con presa aria frontale, esterno	OM470LA	240	326	09/12	>		S 7F20 A	
LONG LIFE	OM470LA	240	326	09/12	>		S 7F21 A	
cabin ventilation / ventilazione cabina	OM470LA	240	326	09/12	>			S 3448 C
3336 BlueTec 5/6/EEV	OM470LA	265	360	09/12	>		S 7F22 A	S 3459 C
with activated carbons / ai carboni attivi	OM470LA	265	360	09/12	>			S 4349 CA
with outer front air intake / con presa aria frontale, esterno	OM470LA	265	360	09/12	>		S 7F20 A	
LONG LIFE	OM470LA	265	360	09/12	>		S 7F21 A	
3340 BlueTec 5/6/EEV	OM470LA	290	394	09/12	>		S 7F22 A	S 3459 C
with activated carbons / ai carboni attivi	OM470LA	290	394	09/12	>			S 4349 CA
with outer front air intake / con presa aria frontale, esterno	OM470LA	290	394	09/12	>		S 7F20 A	
LONG LIFE	OM470LA	290	394	09/12	>		S 7F21 A	
cabin ventilation / ventilazione cabina	OM470LA	290	394	09/12	>			S 3448 C
3342 BlueTec 5/6/EEV	OM471LA	310	421	09/12	>	S 5156 PE	S 7F22 A	S 3459 C
with activated carbons / ai carboni attivi	OM471LA	310	421	09/12	>			S 4349 CA
with outer front air intake / con presa aria frontale, esterno	OM471LA	310	421	09/12	>		S 7F20 A	
LONG LIFE	OM471LA	310	421	09/12	>		S 7F21 A	
power steering / servosterzo	OM471LA	310	421	09/12	>			S 3081 PO
cabin ventilation / ventilazione cabina	OM471LA	310	421	09/12	>			S 3448 C
3343 BlueTec 5/6/EEV	OM470LA	315	428	09/12	>		S 7F22 A	S 3459 C
with activated carbons / ai carboni attivi	OM470LA	315	428	09/12	>			S 4349 CA
with outer front air intake / con presa aria frontale, esterno	OM470LA	315	428	09/12	>		S 7F20 A	
LONG LIFE	OM470LA	315	428	09/12	>		S 7F21 A	
cabin ventilation / ventilazione cabina	OM470LA	315	428	09/12	>			S 3448 C
3345 BlueTec 5/6/EEV	OM471LA	330	449	09/12	>	S 5156 PE	S 7F22 A	S 3459 C
with activated carbons / ai carboni attivi	OM471LA	330	449	09/12	>			S 4349 CA
with outer front air intake / con presa aria frontale, esterno	OM471LA	330	449	09/12	>		S 7F20 A	
LONG LIFE	OM471LA	330	449	09/12	>		S 7F21 A	
power steering / servosterzo	OM471LA	330	449	09/12	>			S 3081 PO
cabin ventilation / ventilazione cabina	OM471LA	330	449	09/12	>			S 3448 C
3348 BlueTec 5/6/EEV	OM471LA	350	476	09/12	>	S 5156 PE	S 7F22 A	S 3459 C
with activated carbons / ai carboni attivi	OM471LA	350	476	09/12	>			S 4349 CA
with outer front air intake / con presa aria frontale, esterno	OM471LA	350	476	09/12	>		S 7F20 A	
LONG LIFE	OM471LA	350	476	09/12	>		S 7F21 A	
power steering / servosterzo	OM471LA	350	476	09/12	>			S 3081 PO
cabin ventilation / ventilazione cabina	OM471LA	350	476	09/12	>			S 3448 C
3351 BlueTec 5/6/EEV	OM471LA	375	510	09/12	>	S 5156 PE	S 7F22 A	S 3459 C
with activated carbons / ai carboni attivi	OM471LA	375	510	09/12	>			S 4349 CA
with outer front air intake / con presa aria frontale, esterno	OM471LA	375	510	09/12	>		S 7F20 A	
LONG LIFE	OM471LA	375	510	09/12	>		S 7F21 A	
power steering / servosterzo	OM471LA	375	510	09/12	>			S 3081 PO
Arocs (964)								
1824 BlueTec 5/6/EEV								
with activated carbons / ai carboni attivi	OM936LA	175	238	04/13	>			S 4349 CA
with outer front air intake / con presa aria frontale, esterno	OM936LA	175	238	04/13	>		S 7F20 A	
LONG LIFE	OM936LA	175	238	04/13	>		S 7F21 A	
power steering / servosterzo	OM936LA	175	238	04/13	>			S 3081 PO
1827 BlueTec 5/6/EEV								
with activated carbons / ai carboni attivi	OM936LA	200	272	04/13	>			S 4349 CA
with outer front air intake / con presa aria frontale, esterno	OM936LA	200	272	04/13	>		S 7F20 A	
LONG LIFE	OM936LA	200	272	04/13	>		S 7F21 A	
power steering / servosterzo	OM936LA	200	272	04/13	>			S 3081 PO

M





...MERCEDES BENZ - trucks/autocarri



cabin ventilation / ventilazione cabina	OM936LA	200	272	04/13	>				S 3448 C
1830 BlueTec 5/6/EEV									
with activated carbons / ai carboni attivi	OM936LA	220	299	04/13	>				S 4349 CA
with outer front air intake / con presa aria frontale, esterno	OM936LA	220	299	04/13	>			S 7F20 A	
LONG LIFE	OM936LA	220	299	04/13	>			S 7F21 A	
power steering / servosterzo	OM936LA	220	299	04/13	>				S 3081 PO
cabin ventilation / ventilazione cabina	OM936LA	220	299	04/13	>				S 3448 C
1832 BlueTec 5/6/EEV									
with activated carbons / ai carboni attivi	OM936LA	235	320	04/13	>				S 4349 CA
with outer front air intake / con presa aria frontale, esterno	OM936LA	235	320	04/13	>			S 7F20 A	
LONG LIFE	OM936LA	235	320	04/13	>			S 7F21 A	
power steering / servosterzo	OM936LA	235	320	04/13	>				S 3081 PO
cabin ventilation / ventilazione cabina	OM936LA	235	320	04/13	>				S 3448 C
1833 BlueTec 5/6/EEV	OM470LA	240	326	04/13	>			S 7F22 A	S 3459 C
with activated carbons / ai carboni attivi	OM470LA	240	326	04/13	>				S 4349 CA
with outer front air intake / con presa aria frontale, esterno	OM470LA	240	326	04/13	>			S 7F20 A	
LONG LIFE	OM470LA	240	326	04/13	>			S 7F21 A	
cabin ventilation / ventilazione cabina	OM470LA	240	326	04/13	>				S 3448 C
1835 BlueTec 5/6/EEV									
with activated carbons / ai carboni attivi	OM936LA	260	353	04/13	>				S 4349 CA
with outer front air intake / con presa aria frontale, esterno	OM936LA	260	353	04/13	>			S 7F20 A	
LONG LIFE	OM936LA	260	353	04/13	>			S 7F21 A	
power steering / servosterzo	OM936LA	260	353	04/13	>				S 3081 PO
cabin ventilation / ventilazione cabina	OM936LA	260	353	04/13	>				S 3448 C
1836 BlueTec 5/6/EEV	OM470LA	265	360	04/13	>			S 7F22 A	S 3459 C
with activated carbons / ai carboni attivi	OM470LA	265	360	04/13	>				S 4349 CA
with outer front air intake / con presa aria frontale, esterno	OM470LA	265	360	04/13	>			S 7F20 A	
LONG LIFE	OM470LA	265	360	04/13	>			S 7F21 A	
cabin ventilation / ventilazione cabina	OM470LA	265	360	04/13	>				S 3448 C
1840 BlueTec 5/6/EEV	OM470LA	290	394	04/13	>			S 7F22 A	S 3459 C
with activated carbons / ai carboni attivi	OM470LA	290	394	04/13	>				S 4349 CA
with outer front air intake / con presa aria frontale, esterno	OM470LA	290	394	04/13	>			S 7F20 A	
LONG LIFE	OM470LA	290	394	04/13	>			S 7F21 A	
cabin ventilation / ventilazione cabina	OM470LA	290	394	04/13	>				S 3448 C
1842 BlueTec 5/6/EEV	OM471LA	310	421	04/13	>	S 5156 PE		S 7F22 A	S 3459 C
with activated carbons / ai carboni attivi	OM471LA	310	421	04/13	>				S 4349 CA
with outer front air intake / con presa aria frontale, esterno	OM471LA	310	421	04/13	>			S 7F20 A	
LONG LIFE	OM471LA	310	421	04/13	>			S 7F21 A	
power steering / servosterzo	OM471LA	310	421	04/13	>				S 3081 PO
cabin ventilation / ventilazione cabina	OM471LA	310	421	04/13	>				S 3448 C
1843 BlueTec 5/6/EEV	OM470LA	315	428	04/13	>			S 7F22 A	S 3459 C
with activated carbons / ai carboni attivi	OM470LA	315	428	04/13	>				S 4349 CA
with outer front air intake / con presa aria frontale, esterno	OM470LA	315	428	04/13	>			S 7F20 A	
LONG LIFE	OM470LA	315	428	04/13	>			S 7F21 A	
cabin ventilation / ventilazione cabina	OM470LA	315	428	04/13	>				S 3448 C
1845 BlueTec 5/6/EEV	OM471LA	330	449	04/13	>	S 5156 PE		S 7F22 A	S 3459 C
with activated carbons / ai carboni attivi	OM471LA	330	449	04/13	>				S 4349 CA
with outer front air intake / con presa aria frontale, esterno	OM471LA	330	449	04/13	>			S 7F20 A	
LONG LIFE	OM471LA	330	449	04/13	>			S 7F21 A	
power steering / servosterzo	OM471LA	330	449	04/13	>				S 3081 PO
cabin ventilation / ventilazione cabina	OM471LA	330	449	04/13	>				S 3448 C
1848 BlueTec 5/6/EEV	OM471LA	350	476	04/13	>	S 5156 PE		S 7F22 A	S 3459 C
with activated carbons / ai carboni attivi	OM471LA	350	476	04/13	>				S 4349 CA
with outer front air intake / con presa aria frontale, esterno	OM471LA	350	476	04/13	>			S 7F20 A	
LONG LIFE	OM471LA	350	476	04/13	>			S 7F21 A	
power steering / servosterzo	OM471LA	350	476	04/13	>				S 3081 PO
cabin ventilation / ventilazione cabina	OM471LA	350	476	04/13	>				S 3448 C
1851 BlueTec 5/6/EEV	OM471LA	375	510	04/13	>	S 5156 PE		S 7F22 A	S 3459 C
with activated carbons / ai carboni attivi	OM471LA	375	510	04/13	>				S 4349 CA
with outer front air intake / con presa aria frontale, esterno	OM471LA	375	510	04/13	>			S 7F20 A	
LONG LIFE	OM471LA	375	510	04/13	>			S 7F21 A	
power steering / servosterzo	OM471LA	375	510	04/13	>				S 3081 PO
cabin ventilation / ventilazione cabina	OM471LA	375	510	04/13	>				S 3448 C
2024 BlueTec 5/6/EEV									
with activated carbons / ai carboni attivi	OM936LA	175	238	04/13	>				S 4349 CA
with outer front air intake / con presa aria frontale, esterno	OM936LA	175	238	04/13	>			S 7F20 A	
LONG LIFE	OM936LA	175	238	04/13	>			S 7F21 A	

**KW HP****...MERCEDES BENZ - trucks/autocarri**

power steering / servosterzo	OM936LA	175	238	04/13	>			S 3081 PO
cabin ventilation / ventilazione cabina	OM936LA	175	238	04/13	>			S 3448 C
2027 BlueTec 5/6/EEV								
with activated carbons / ai carboni attivi	OM936LA	200	272	04/13	>			S 4349 CA
with outer front air intake / con presa aria frontale, esterno	OM936LA	200	272	04/13	>		S 7F20 A	
LONG LIFE	OM936LA	200	272	04/13	>		S 7F21 A	
power steering / servosterzo	OM936LA	200	272	04/13	>			S 3081 PO
2030 BlueTec 5/6/EEV								
with activated carbons / ai carboni attivi	OM936LA	220	299	04/13	>			S 4349 CA
with outer front air intake / con presa aria frontale, esterno	OM936LA	220	299	04/13	>		S 7F20 A	
LONG LIFE	OM936LA	220	299	04/13	>		S 7F21 A	
power steering / servosterzo	OM936LA	220	299	04/13	>			S 3081 PO
cabin ventilation / ventilazione cabina	OM936LA	220	299	04/13	>			S 3448 C
2032 BlueTec 5/6/EEV								
with activated carbons / ai carboni attivi	OM936LA	235	320	04/13	>			S 4349 CA
with outer front air intake / con presa aria frontale, esterno	OM936LA	235	320	04/13	>		S 7F20 A	
LONG LIFE	OM936LA	235	320	04/13	>		S 7F21 A	
power steering / servosterzo	OM936LA	235	320	04/13	>			S 3081 PO
cabin ventilation / ventilazione cabina	OM936LA	235	320	04/13	>			S 3448 C
2033 BlueTec 5/6/EEV								
with activated carbons / ai carboni attivi	OM470LA	240	326	04/13	>		S 7F22 A	S 3459 C
with outer front air intake / con presa aria frontale, esterno	OM470LA	240	326	04/13	>		S 7F20 A	S 4349 CA
LONG LIFE	OM470LA	240	326	04/13	>		S 7F21 A	
cabin ventilation / ventilazione cabina	OM470LA	240	326	04/13	>			S 3448 C
2035 BlueTec 5/6/EEV								
with activated carbons / ai carboni attivi	OM936LA	260	353	04/13	>			S 4349 CA
with outer front air intake / con presa aria frontale, esterno	OM936LA	260	353	04/13	>		S 7F20 A	
LONG LIFE	OM936LA	260	353	04/13	>		S 7F21 A	
power steering / servosterzo	OM936LA	260	353	04/13	>			S 3081 PO
cabin ventilation / ventilazione cabina	OM936LA	260	353	04/13	>			S 3448 C
2036 BlueTec 5/6/EEV								
with activated carbons / ai carboni attivi	OM470LA	265	360	04/13	>			S 3459 C
with outer front air intake / con presa aria frontale, esterno	OM470LA	265	360	04/13	>		S 7F20 A	S 4349 CA
LONG LIFE	OM470LA	265	360	04/13	>		S 7F21 A	
cabin ventilation / ventilazione cabina	OM470LA	265	360	04/13	>			S 3448 C
2040 BlueTec 5/6/EEV								
with activated carbons / ai carboni attivi	OM470LA	290	394	04/13	>		S 7F22 A	S 3459 C
with outer front air intake / con presa aria frontale, esterno	OM470LA	290	394	04/13	>		S 7F20 A	S 4349 CA
LONG LIFE	OM470LA	290	394	04/13	>		S 7F21 A	
cabin ventilation / ventilazione cabina	OM470LA	290	394	04/13	>			S 3448 C
2042 BlueTec 5/6/EEV								
with activated carbons / ai carboni attivi	OM471LA	310	421	04/13	>	S 5156 PE	S 7F22 A	S 3459 C
with outer front air intake / con presa aria frontale, esterno	OM471LA	310	421	04/13	>		S 7F20 A	S 4349 CA
LONG LIFE	OM471LA	310	421	04/13	>		S 7F21 A	
power steering / servosterzo	OM471LA	310	421	04/13	>			S 3081 PO
cabin ventilation / ventilazione cabina	OM471LA	310	421	04/13	>			S 3448 C
2043 BlueTec 5/6/EEV								
with activated carbons / ai carboni attivi	OM470LA	315	428	04/13	>		S 7F22 A	S 3459 C
with outer front air intake / con presa aria frontale, esterno	OM470LA	315	428	04/13	>		S 7F20 A	S 4349 CA
LONG LIFE	OM470LA	315	428	04/13	>		S 7F21 A	
cabin ventilation / ventilazione cabina	OM470LA	315	428	04/13	>			S 3448 C
2045 BlueTec 5/6/EEV								
with activated carbons / ai carboni attivi	OM471LA	330	449	04/13	>	S 5156 PE	S 7F22 A	S 3459 C
with outer front air intake / con presa aria frontale, esterno	OM471LA	330	449	04/13	>	S 5156 PE		S 4349 CA
LONG LIFE	OM471LA	330	449	04/13	>		S 7F20 A	
power steering / servosterzo	OM471LA	330	449	04/13	>		S 7F21 A	
power steering / servosterzo	OM471LA	330	449	04/13	>			S 3081 PO
power steering / servosterzo	OM471LA	330	449	04/13	>			S 3081 PO
cabin ventilation / ventilazione cabina	OM471LA	330	449	04/13	>			S 3448 C
2048 BlueTec 5/6/EEV								
with activated carbons / ai carboni attivi	OM471LA	350	476	04/13	>	S 5156 PE	S 7F22 A	S 3459 C
with outer front air intake / con presa aria frontale, esterno	OM471LA	350	476	04/13	>	S 5156 PE		S 4349 CA
LONG LIFE	OM471LA	350	476	04/13	>		S 7F20 A	
power steering / servosterzo	OM471LA	350	476	04/13	>		S 7F21 A	
power steering / servosterzo	OM471LA	350	476	04/13	>			S 3081 PO
power steering / servosterzo	OM471LA	350	476	04/13	>			S 3081 PO
cabin ventilation / ventilazione cabina	OM471LA	350	476	04/13	>			S 3448 C

M



KW HP



...MERCEDES BENZ - trucks/autocarri

M



2051 BlueTec 5/6/EEV	OM471LA	375 510	04/13 >	S 5156 PE	S 7F22 A	S 3459 C
	OM471LA	375 510	04/13 >	S 5156 PE		
with activated carbons / ai carboni attivi	OM471LA	375 510	04/13 >			S 4349 CA
with outer front air intake / con presa aria frontale, esterno	OM471LA	375 510	04/13 >		S 7F20 A	
LONG LIFE	OM471LA	375 510	04/13 >		S 7F21 A	
power steering / servosterzo	OM471LA	375 510	04/13 >			S 3081 PO
power steering / servosterzo	OM471LA	375 510	04/13 >			S 3081 PO
cabin ventilation / ventilazione cabina	OM471LA	375 510	04/13 >			S 3448 C
2527 BlueTec 5/6/EEV						
with activated carbons / ai carboni attivi	OM936LA	200 272	04/13 >			S 4349 CA
with outer front air intake / con presa aria frontale, esterno	OM936LA	200 272	04/13 >		S 7F20 A	
LONG LIFE	OM936LA	200 272	04/13 >		S 7F21 A	
power steering / servosterzo	OM936LA	200 272	04/13 >			S 3081 PO
cabin ventilation / ventilazione cabina	OM936LA	200 272	04/13 >			S 3448 C
2530 BlueTec 5/6/EEV						
with activated carbons / ai carboni attivi	OM936LA	220 299	04/13 >			S 4349 CA
with outer front air intake / con presa aria frontale, esterno	OM936LA	220 299	04/13 >		S 7F20 A	
LONG LIFE	OM936LA	220 299	04/13 >		S 7F21 A	
power steering / servosterzo	OM936LA	220 299	04/13 >			S 3081 PO
cabin ventilation / ventilazione cabina	OM936LA	220 299	04/13 >			S 3448 C
2532 BlueTec 5/6/EEV						
with activated carbons / ai carboni attivi	OM936LA	235 320	04/13 >			S 4349 CA
with outer front air intake / con presa aria frontale, esterno	OM936LA	235 320	04/13 >		S 7F20 A	
LONG LIFE	OM936LA	235 320	04/13 >		S 7F21 A	
power steering / servosterzo	OM936LA	235 320	04/13 >			S 3081 PO
cabin ventilation / ventilazione cabina	OM936LA	235 320	04/13 >			S 3448 C
2533 BlueTec 5/6/EEV	OM470LA	240 326	04/13 >		S 7F22 A	S 3459 C
with activated carbons / ai carboni attivi	OM470LA	240 326	04/13 >			S 4349 CA
with outer front air intake / con presa aria frontale, esterno	OM470LA	240 326	04/13 >		S 7F20 A	
LONG LIFE	OM470LA	240 326	04/13 >		S 7F21 A	
cabin ventilation / ventilazione cabina	OM470LA	240 326	04/13 >			S 3448 C
2535 BlueTec 5/6/EEV						
with activated carbons / ai carboni attivi	OM936LA	260 353	04/13 >			S 4349 CA
with outer front air intake / con presa aria frontale, esterno	OM936LA	260 353	04/13 >		S 7F20 A	
LONG LIFE	OM936LA	260 353	04/13 >		S 7F21 A	
power steering / servosterzo	OM936LA	260 353	04/13 >			S 3081 PO
cabin ventilation / ventilazione cabina	OM936LA	260 353	04/13 >			S 3448 C
2536 BlueTec 5/6/EEV	OM470LA	265 360	04/13 >		S 7F22 A	S 3459 C
with activated carbons / ai carboni attivi	OM470LA	265 360	04/13 >			S 4349 CA
with outer front air intake / con presa aria frontale, esterno	OM470LA	265 360	04/13 >		S 7F20 A	
LONG LIFE	OM470LA	265 360	04/13 >		S 7F21 A	
cabin ventilation / ventilazione cabina	OM470LA	265 360	04/13 >			S 3448 C
2540 BlueTec 5/6/EEV	OM470LA	290 394	04/13 >		S 7F22 A	S 3459 C
with activated carbons / ai carboni attivi	OM470LA	290 394	04/13 >			S 4349 CA
with outer front air intake / con presa aria frontale, esterno	OM470LA	290 394	04/13 >		S 7F20 A	
LONG LIFE	OM470LA	290 394	04/13 >		S 7F21 A	
cabin ventilation / ventilazione cabina	OM470LA	290 394	04/13 >			S 3448 C
2542 BlueTec 5/6/EEV	OM471LA	310 421	04/13 >	S 5156 PE	S 7F22 A	S 3459 C
with activated carbons / ai carboni attivi	OM471LA	310 421	04/13 >			S 4349 CA
with outer front air intake / con presa aria frontale, esterno	OM471LA	310 421	04/13 >		S 7F20 A	
LONG LIFE	OM471LA	310 421	04/13 >		S 7F21 A	
power steering / servosterzo	OM471LA	310 421	04/13 >			S 3081 PO
cabin ventilation / ventilazione cabina	OM471LA	310 421	04/13 >			S 3448 C
2543 BlueTec 5/6/EEV	OM470LA	315 428	04/13 >		S 7F22 A	S 3459 C
with activated carbons / ai carboni attivi	OM470LA	315 428	04/13 >			S 4349 CA
with outer front air intake / con presa aria frontale, esterno	OM470LA	315 428	04/13 >		S 7F20 A	
LONG LIFE	OM470LA	315 428	04/13 >		S 7F22 A	
cabin ventilation / ventilazione cabina	OM470LA	315 428	04/13 >			S 3448 C
2545 BlueTec 5/6/EEV	OM471LA	330 449	04/13 >	S 5156 PE	S 7F22 A	S 3459 C
with activated carbons / ai carboni attivi	OM471LA	330 449	04/13 >			S 4349 CA
with outer front air intake / con presa aria frontale, esterno	OM471LA	330 449	04/13 >		S 7F20 A	
LONG LIFE	OM471LA	330 449	04/13 >		S 7F22 A	
power steering / servosterzo	OM471LA	330 449	04/13 >			S 3081 PO
cabin ventilation / ventilazione cabina	OM471LA	330 449	04/13 >			S 3448 C
2548 BlueTec 5/6/EEV	OM471LA	350 476	04/13 >	S 5156 PE	S 7F22 A	S 3459 C
with activated carbons / ai carboni attivi	OM471LA	350 476	04/13 >			S 4349 CA
with outer front air intake / con presa aria frontale, esterno	OM471LA	350 476	04/13 >		S 7F20 A	



...MERCEDES BENZ - trucks/autocarri

LONG LIFE	OM471LA	350	476	04/13	>			S 7F22 A	
power steering / servosterzo	OM471LA	350	476	04/13	>				S 3081 PO
cabin ventilation / ventilazione cabina	OM471LA	350	476	04/13	>				S 3448 C
2551 BlueTec 5/6/EEV	OM471LA	375	510	04/13	>	S 5156 PE		S 7F22 A	S 3459 C
with activated carbons / ai carboni attivi	OM471LA	375	510	04/13	>				S 4349 CA
with outer front air intake / con presa aria frontale, esterno	OM471LA	375	510	04/13	>			S 7F20 A	
LONG LIFE	OM471LA	375	510	04/13	>			S 7F21 A	
power steering / servosterzo	OM471LA	375	510	04/13	>				S 3081 PO
cabin ventilation / ventilazione cabina	OM471LA	375	510	04/13	>				S 3448 C
2627 BlueTec 5/6/EEV	OM936LA	200	272	04/13	>				S 4349 CA
with activated carbons / ai carboni attivi	OM936LA	200	272	04/13	>			S 7F20 A	
with outer front air intake / con presa aria frontale, esterno	OM936LA	200	272	04/13	>			S 7F21 A	
LONG LIFE	OM936LA	200	272	04/13	>				S 3081 PO
power steering / servosterzo	OM936LA	200	272	04/13	>				S 3448 C
cabin ventilation / ventilazione cabina	OM936LA	200	272	04/13	>				
2630 BlueTec 5/6/EEV	OM936LA	220	299	04/13	>				S 4349 CA
with activated carbons / ai carboni attivi	OM936LA	220	299	04/13	>			S 7F20 A	
with outer front air intake / con presa aria frontale, esterno	OM936LA	220	299	04/13	>			S 7F21 A	
LONG LIFE	OM936LA	220	299	04/13	>				S 3081 PO
power steering / servosterzo	OM936LA	220	299	04/13	>				S 3448 C
cabin ventilation / ventilazione cabina	OM936LA	220	299	04/13	>				
2632 BlueTec 5/6/EEV	OM936LA	235	320	04/13	>				S 4349 CA
with activated carbons / ai carboni attivi	OM936LA	235	320	04/13	>			S 7F20 A	
with outer front air intake / con presa aria frontale, esterno	OM936LA	235	320	04/13	>			S 7F21 A	
LONG LIFE	OM936LA	235	320	04/13	>				S 3081 PO
power steering / servosterzo	OM936LA	235	320	04/13	>				S 3448 C
cabin ventilation / ventilazione cabina	OM936LA	235	320	04/13	>				
2633 BlueTec 5/6/EEV	OM470LA	240	326	04/13	>			S 7F22 A	S 3459 C
with activated carbons / ai carboni attivi	OM470LA	240	326	04/13	>				S 4349 CA
with outer front air intake / con presa aria frontale, esterno	OM470LA	240	326	04/13	>			S 7F20 A	
LONG LIFE	OM470LA	240	326	04/13	>			S 7F21 A	
cabin ventilation / ventilazione cabina	OM470LA	240	326	04/13	>				S 3448 C
2635 BlueTec 5/6/EEV	OM936LA	260	353	04/13	>				S 4349 CA
with activated carbons / ai carboni attivi	OM936LA	260	353	04/13	>			S 7F20 A	
with outer front air intake / con presa aria frontale, esterno	OM936LA	260	353	04/13	>			S 7F21 A	
LONG LIFE	OM936LA	260	353	04/13	>				S 3081 PO
power steering / servosterzo	OM936LA	260	353	04/13	>				S 3448 C
cabin ventilation / ventilazione cabina	OM936LA	260	353	04/13	>				
2636 BlueTec 5/6/EEV	OM470LA	265	360	04/13	>			S 7F22 A	S 3459 C
with activated carbons / ai carboni attivi	OM470LA	265	360	04/13	>				S 4349 CA
with outer front air intake / con presa aria frontale, esterno	OM470LA	265	360	04/13	>			S 7F20 A	
LONG LIFE	OM470LA	265	360	04/13	>			S 7F21 A	
cabin ventilation / ventilazione cabina	OM470LA	265	360	04/13	>				S 3448 C
2640 BlueTec 5/6/EEV	OM470LA	290	394	04/13	>			S 7F22 A	S 3459 C
with activated carbons / ai carboni attivi	OM470LA	290	394	04/13	>				S 4349 CA
with outer front air intake / con presa aria frontale, esterno	OM470LA	290	394	04/13	>			S 7F20 A	
LONG LIFE	OM470LA	290	394	04/13	>			S 7F21 A	
cabin ventilation / ventilazione cabina	OM470LA	290	394	04/13	>				S 3448 C
2642 BlueTec 5/6/EEV	OM471LA	310	421	04/13	>	S 5156 PE		S 7F22 A	S 3459 C
with activated carbons / ai carboni attivi	OM471LA	310	421	04/13	>				S 4349 CA
with outer front air intake / con presa aria frontale, esterno	OM471LA	310	421	04/13	>			S 7F20 A	
LONG LIFE	OM471LA	310	421	04/13	>			S 7F21 A	
power steering / servosterzo	OM471LA	310	421	04/13	>				S 3081 PO
cabin ventilation / ventilazione cabina	OM471LA	310	421	04/13	>				S 3448 C
2643 BlueTec 5/6/EEV	OM470LA	315	428	04/13	>			S 7F22 A	S 3459 C
with activated carbons / ai carboni attivi	OM470LA	315	428	04/13	>				S 4349 CA
with outer front air intake / con presa aria frontale, esterno	OM470LA	315	428	04/13	>			S 7F20 A	
LONG LIFE	OM470LA	315	428	04/13	>			S 7F21 A	
cabin ventilation / ventilazione cabina	OM470LA	315	428	04/13	>				S 3448 C
2645 BlueTec 5/6/EEV	OM471LA	330	449	04/13	>	S 5156 PE		S 7F22 A	S 3459 C
with activated carbons / ai carboni attivi	OM471LA	330	449	04/13	>				S 4349 CA
with outer front air intake / con presa aria frontale, esterno	OM471LA	330	449	04/13	>			S 7F20 A	
LONG LIFE	OM471LA	330	449	04/13	>			S 7F21 A	
power steering / servosterzo	OM471LA	330	449	04/13	>				S 3081 PO
cabin ventilation / ventilazione cabina	OM471LA	330	449	04/13	>				S 3448 C
2648 BlueTec 5/6/EEV	OM471LA	350	476	04/13	>	S 5156 PE		S 7F22 A	S 3459 C
with activated carbons / ai carboni attivi	OM471LA	350	476	04/13	>				S 4349 CA

M



kW HP



...MERCEDES BENZ - trucks/autocarri

M



with outer front air intake / con presa aria frontale, esterno	OM471LA	350	476	04/13	>			S 7F20 A	
LONG LIFE	OM471LA	350	476	04/13	>			S 7F21 A	
power steering / servosterzo	OM471LA	350	476	04/13	>				S 3081 PO
cabin ventilation / ventilazione cabina	OM471LA	350	476	04/13	>				S 3448 C
2651 BlueTec 5/6/EEV	OM471LA	375	510	04/13	>	S 5156 PE		S 7F22 A	S 3459 C
with activated carbons / ai carboni attivi	OM471LA	375	510	04/13	>				S 4349 CA
with outer front air intake / con presa aria frontale, esterno	OM471LA	375	510	04/13	>			S 7F20 A	
LONG LIFE	OM471LA	375	510	04/13	>			S 7F21 A	
power steering / servosterzo	OM471LA	375	510	04/13	>				S 3081 PO
cabin ventilation / ventilazione cabina	OM471LA	375	510	04/13	>				S 3448 C
3227 BlueTec 5/6/EEV	OM936LA	200	272	04/13	>				S 4349 CA
with activated carbons / ai carboni attivi	OM936LA	200	272	04/13	>			S 7F20 A	
with outer front air intake / con presa aria frontale, esterno	OM936LA	200	272	04/13	>			S 7F21 A	
LONG LIFE	OM936LA	200	272	04/13	>				S 3081 PO
power steering / servosterzo	OM936LA	200	272	04/13	>				S 3448 C
cabin ventilation / ventilazione cabina	OM936LA	200	272	04/13	>				
3230 BlueTec 5/6/EEV	OM936LA	220	299	04/13	>				S 4349 CA
with activated carbons / ai carboni attivi	OM936LA	220	299	04/13	>			S 7F20 A	
with outer front air intake / con presa aria frontale, esterno	OM936LA	220	299	04/13	>			S 7F21 A	
LONG LIFE	OM936LA	220	299	04/13	>				S 3081 PO
power steering / servosterzo	OM936LA	220	299	04/13	>				S 3448 C
cabin ventilation / ventilazione cabina	OM936LA	220	299	04/13	>				
3232 BlueTec 5/6/EEV	OM936LA	235	320	04/13	>				S 4349 CA
with activated carbons / ai carboni attivi	OM936LA	235	320	04/13	>			S 7F20 A	
with outer front air intake / con presa aria frontale, esterno	OM936LA	235	320	04/13	>			S 7F21 A	
LONG LIFE	OM936LA	235	320	04/13	>				S 3081 PO
power steering / servosterzo	OM936LA	235	320	04/13	>				S 3448 C
cabin ventilation / ventilazione cabina	OM936LA	235	320	04/13	>				
3233 BlueTec 5/6/EEV	OM470LA	240	326	04/13	>			S 7F22 A	S 3459 C
with activated carbons / ai carboni attivi	OM470LA	240	326	04/13	>				S 4349 CA
with outer front air intake / con presa aria frontale, esterno	OM470LA	240	326	04/13	>			S 7F20 A	
LONG LIFE	OM470LA	240	326	04/13	>			S 7F21 A	
cabin ventilation / ventilazione cabina	OM470LA	240	326	04/13	>				S 3448 C
3235 BlueTec 5/6/EEV	OM936LA	260	353	04/13	>				S 4349 CA
with activated carbons / ai carboni attivi	OM936LA	260	353	04/13	>			S 7F20 A	
with outer front air intake / con presa aria frontale, esterno	OM936LA	260	353	04/13	>			S 7F21 A	
LONG LIFE	OM936LA	260	353	04/13	>				S 3081 PO
power steering / servosterzo	OM936LA	260	353	04/13	>				S 3448 C
cabin ventilation / ventilazione cabina	OM936LA	260	353	04/13	>				
3236 BlueTec 5/6/EEV	OM470LA	265	360	04/13	>			S 7F22 A	S 3459 C
with activated carbons / ai carboni attivi	OM470LA	265	360	04/13	>				S 4349 CA
with outer front air intake / con presa aria frontale, esterno	OM470LA	265	360	04/13	>			S 7F20 A	
LONG LIFE	OM470LA	265	360	04/13	>			S 7F21 A	
cabin ventilation / ventilazione cabina	OM470LA	265	360	04/13	>				S 3448 C
3240 BlueTec 5/6/EEV	OM470LA	290	394	04/13	>			S 7F22 A	S 3459 C
with activated carbons / ai carboni attivi	OM470LA	290	394	04/13	>				S 4349 CA
with outer front air intake / con presa aria frontale, esterno	OM470LA	290	394	04/13	>			S 7F20 A	
LONG LIFE	OM470LA	290	394	04/13	>			S 7F21 A	
cabin ventilation / ventilazione cabina	OM470LA	290	394	04/13	>				S 3448 C
3242 BlueTec 5/6/EEV	OM471LA	310	421	04/13	>	S 5156 PE		S 7F22 A	S 3459 C
with activated carbons / ai carboni attivi	OM471LA	310	421	04/13	>				S 4349 CA
with outer front air intake / con presa aria frontale, esterno	OM471LA	310	421	04/13	>			S 7F20 A	
LONG LIFE	OM471LA	310	421	04/13	>			S 7F21 A	
power steering / servosterzo	OM471LA	310	421	04/13	>				S 3081 PO
cabin ventilation / ventilazione cabina	OM471LA	310	421	04/13	>				S 3448 C
3243 BlueTec 5/6/EEV	OM470LA	315	428	04/13	>			S 7F22 A	S 3459 C
with activated carbons / ai carboni attivi	OM470LA	315	428	04/13	>				S 4349 CA
with outer front air intake / con presa aria frontale, esterno	OM470LA	315	428	04/13	>			S 7F20 A	
LONG LIFE	OM470LA	315	428	04/13	>			S 7F21 A	
cabin ventilation / ventilazione cabina	OM470LA	315	428	04/13	>				S 3448 C
3245 BlueTec 5/6/EEV	OM471LA	330	449	04/13	>	S 5156 PE		S 7F22 A	S 3459 C
with activated carbons / ai carboni attivi	OM471LA	330	449	04/13	>				S 4349 CA
with outer front air intake / con presa aria frontale, esterno	OM471LA	330	449	04/13	>			S 7F20 A	
dryer filter KNORR-WABCO / filtro essiccatore KNORR-WABCO	OM471LA	330	449	04/13	>				S 3448 C
LONG LIFE	OM471LA	330	449	04/13	>			S 7F21 A	
power steering / servosterzo	OM471LA	330	449	04/13	>				S 3081 PO
3248 BlueTec 5/6/EEV	OM471LA	350	476	04/13	>	S 5156 PE		S 7F22 A	S 3459 C

**kW HP****...MERCEDES BENZ - trucks/autocarri**

with activated carbons / ai carboni attivi	OM471LA	350	476	04/13	>			S 7F20 A	S 4349 CA
with outer front air intake / con presa aria frontale, esterno	OM471LA	350	476	04/13	>			S 7F21 A	
LONG LIFE	OM471LA	350	476	04/13	>				
power steering / servosterzo	OM471LA	350	476	04/13	>				S 3081 PO
cabin ventilation / ventilazione cabina	OM471LA	350	476	04/13	>				S 3448 C
3251 BlueTec 5/6/EEV	OM471LA	375	510	04/13	>		S 5156 PE	S 7F22 A	S 3459 C
with activated carbons / ai carboni attivi	OM471LA	375	510	04/13	>				S 4349 CA
with outer front air intake / con presa aria frontale, esterno	OM471LA	375	510	04/13	>			S 7F20 A	
LONG LIFE	OM471LA	375	510	04/13	>			S 7F21 A	
power steering / servosterzo	OM471LA	375	510	04/13	>				S 3081 PO
cabin ventilation / ventilazione cabina	OM471LA	375	510	04/13	>				S 3448 C
3333 BlueTec 5/6/EEV	OM470LA	240	326	04/13	>			S 7F22 A	S 3459 C
with activated carbons / ai carboni attivi	OM470LA	240	326	04/13	>				S 4349 CA
with outer front air intake / con presa aria frontale, esterno	OM470LA	240	326	04/13	>			S 7F20 A	
LONG LIFE	OM470LA	240	326	04/13	>			S 7F21 A	
cabin ventilation / ventilazione cabina	OM470LA	240	326	04/13	>				S 3448 C
3336 BlueTec 5/6/EEV	OM470LA	265	360	04/13	>			S 7F22 A	S 3459 C
with activated carbons / ai carboni attivi	OM470LA	265	360	04/13	>				S 4349 CA
with outer front air intake / con presa aria frontale, esterno	OM470LA	265	360	04/13	>			S 7F20 A	
LONG LIFE	OM470LA	265	360	04/13	>			S 7F21 A	
cabin ventilation / ventilazione cabina	OM470LA	265	360	04/13	>				S 3448 C
3340 BlueTec 5/6/EEV	OM470LA	290	394	04/13	>			S 7F22 A	S 3459 C
with activated carbons / ai carboni attivi	OM470LA	290	394	04/13	>				S 4349 CA
with outer front air intake / con presa aria frontale, esterno	OM470LA	290	394	04/13	>			S 7F20 A	
LONG LIFE	OM470LA	290	394	04/13	>			S 7F21 A	
cabin ventilation / ventilazione cabina	OM470LA	290	394	04/13	>				S 3448 C
3342 BlueTec 5/6/EEV	OM471LA	310	421	04/13	>		S 5156 PE	S 7F22 A	S 3459 C
with activated carbons / ai carboni attivi	OM471LA	310	421	04/13	>				S 4349 CA
with outer front air intake / con presa aria frontale, esterno	OM471LA	310	421	04/13	>			S 7F20 A	
LONG LIFE	OM471LA	310	421	04/13	>			S 7F21 A	
power steering / servosterzo	OM471LA	310	421	04/13	>				S 3081 PO
cabin ventilation / ventilazione cabina	OM471LA	310	421	04/13	>				S 3448 C
3343 BlueTec 5/6/EEV	OM470LA	315	428	04/13	>			S 7F22 A	S 3459 C
with activated carbons / ai carboni attivi	OM470LA	315	428	04/13	>				S 4349 CA
with outer front air intake / con presa aria frontale, esterno	OM470LA	315	428	04/13	>			S 7F20 A	
LONG LIFE	OM470LA	315	428	04/13	>			S 7F21 A	
cabin ventilation / ventilazione cabina	OM470LA	315	428	04/13	>				S 3448 C
3345 BlueTec 5/6/EEV	OM471LA	330	449	04/13	>		S 5156 PE	S 7F22 A	S 3459 C
with activated carbons / ai carboni attivi	OM471LA	330	449	04/13	>				S 4349 CA
with outer front air intake / con presa aria frontale, esterno	OM471LA	330	449	04/13	>			S 7F20 A	
LONG LIFE	OM471LA	330	449	04/13	>			S 7F21 A	
power steering / servosterzo	OM471LA	330	449	04/13	>				S 3081 PO
cabin ventilation / ventilazione cabina	OM471LA	330	449	04/13	>				S 3448 C
3348 BlueTec 5/6/EEV	OM471LA	350	476	04/13	>		S 5156 PE	S 7F22 A	S 3459 C
with activated carbons / ai carboni attivi	OM471LA	350	476	04/13	>				S 4349 CA
with outer front air intake / con presa aria frontale, esterno	OM471LA	350	476	04/13	>			S 7F20 A	
LONG LIFE	OM471LA	350	476	04/13	>			S 7F21 A	
power steering / servosterzo	OM471LA	350	476	04/13	>				S 3081 PO
cabin ventilation / ventilazione cabina	OM471LA	350	476	04/13	>				S 3448 C
3351 BlueTec 5/6/EEV	OM471LA	375	510	04/13	>		S 5156 PE	S 7F22 A	S 3459 C
with activated carbons / ai carboni attivi	OM471LA	375	510	04/13	>				S 4349 CA
with outer front air intake / con presa aria frontale, esterno	OM471LA	375	510	04/13	>			S 7F20 A	
power steering / servosterzo	OM471LA	375	510	04/13	>				S 3081 PO
cabin ventilation / ventilazione cabina	OM471LA	375	510	04/13	>				S 3448 C
4133 BlueTec 5/6/EEV	OM470LA	240	326	04/13	>			S 7F22 A	S 3459 C
with activated carbons / ai carboni attivi	OM470LA	240	326	04/13	>				S 4349 CA
with outer front air intake / con presa aria frontale, esterno	OM470LA	240	326	04/13	>			S 7F20 A	
LONG LIFE	OM470LA	240	326	04/13	>			S 7F21 A	
cabin ventilation / ventilazione cabina	OM470LA	240	326	04/13	>				S 3448 C
4136 BlueTec 5/6/EEV	OM470LA	265	360	04/13	>			S 7F22 A	S 3459 C
with activated carbons / ai carboni attivi	OM470LA	265	360	04/13	>				S 4349 CA
with outer front air intake / con presa aria frontale, esterno	OM470LA	265	360	04/13	>			S 7F20 A	
LONG LIFE	OM470LA	265	360	04/13	>			S 7F21 A	
cabin ventilation / ventilazione cabina	OM470LA	265	360	04/13	>				S 3448 C
4140 BlueTec 5/6/EEV	OM470LA	290	394	04/13	>			S 7F22 A	S 3459 C
with activated carbons / ai carboni attivi	OM470LA	290	394	04/13	>				S 4349 CA
with outer front air intake / con presa aria frontale, esterno	OM470LA	290	394	04/13	>			S 7F20 A	

M

**KW HP****...MERCEDES BENZ - trucks/autocarri****M**

LONG LIFE	OM470LA	290	394	04/13	>			S 7F21 A		
4142 BlueTec 5/6/EEV	OM471LA	310	421	04/13	>	S 5156 PE		S 7F22 A	S 3459 C	
with activated carbons / ai carboni attivi	OM471LA	310	421	04/13	>				S 4349 CA	
with outer front air intake / con presa aria frontale, esterno	OM471LA	310	421	04/13	>			S 7F20 A		
LONG LIFE	OM471LA	310	421	04/13	>			S 7F21 A		
power steering / servosterzo	OM471LA	310	421	04/13	>				S 3081 PO	
cabin ventilation / ventilazione cabina	OM471LA	310	421	04/13	>				S 3448 C	
4143 BlueTec 5/6/EEV	OM470LA	315	428	04/13	>			S 7F22 A	S 3459 C	
with activated carbons / ai carboni attivi	OM470LA	315	428	04/13	>				S 4349 CA	
with outer front air intake / con presa aria frontale, esterno	OM470LA	315	428	04/13	>			S 7F20 A		
LONG LIFE	OM470LA	315	428	04/13	>			S 7F21 A		
cabin ventilation / ventilazione cabina	OM470LA	315	428	04/13	>				S 3448 C	
4145 BlueTec 5/6/EEV	OM471LA	330	449	04/13	>	S 5156 PE		S 7F22 A	S 3459 C	
with activated carbons / ai carboni attivi	OM471LA	330	449	04/13	>				S 4349 CA	
with outer front air intake / con presa aria frontale, esterno	OM471LA	330	449	04/13	>			S 7F20 A		
LONG LIFE	OM471LA	330	449	04/13	>			S 7F21 A		
power steering / servosterzo	OM471LA	330	449	04/13	>				S 3081 PO	
4148 BlueTec 5/6/EEV	OM471LA	350	476	04/13	>	S 5156 PE		S 7F22 A	S 3459 C	
with activated carbons / ai carboni attivi	OM471LA	350	476	04/13	>				S 4349 CA	
with outer front air intake / con presa aria frontale, esterno	OM471LA	350	476	04/13	>			S 7F20 A		
LONG LIFE	OM471LA	350	476	04/13	>			S 7F21 A		
power steering / servosterzo	OM471LA	350	476	04/13	>				S 3081 PO	
cabin ventilation / ventilazione cabina	OM471LA	350	476	04/13	>				S 3448 C	
4151 BlueTec 5/6/EEV	OM471LA	375	510	04/13	>	S 5156 PE		S 7F22 A	S 3459 C	
with activated carbons / ai carboni attivi	OM471LA	375	510	04/13	>				S 4349 CA	
with outer front air intake / con presa aria frontale, esterno	OM471LA	375	510	04/13	>			S 7F20 A		
LONG LIFE	OM471LA	375	510	04/13	>			S 7F21 A		
power steering / servosterzo	OM471LA	375	510	04/13	>				S 3081 PO	
cabin ventilation / ventilazione cabina	OM471LA	375	510	04/13	>				S 3448 C	
4152 BlueTec 5/6/EEV	OM473LA	380	517	04/13	>	S 5156 PE		S 7F22 A	S 3459 C	
with activated carbons / ai carboni attivi	OM473LA	380	517	04/13	>				S 4349 CA	
with outer front air intake / con presa aria frontale, esterno	OM473LA	380	517	04/13	>			S 7F20 A		
LONG LIFE	OM473LA	380	517	04/13	>			S 7F21 A		
power steering / servosterzo	OM473LA	380	517	04/13	>				S 3081 PO	
cabin ventilation / ventilazione cabina	OM473LA	380	517	04/13	>				S 3448 C	
4158 BlueTec 5/6/EEV	OM473LA	425	578	04/13	>	S 5156 PE		S 7F22 A	S 3459 C	
with activated carbons / ai carboni attivi	OM473LA	425	578	04/13	>				S 4349 CA	
with outer front air intake / con presa aria frontale, esterno	OM473LA	425	578	04/13	>			S 7F20 A		
LONG LIFE	OM473LA	425	578	04/13	>			S 7F21 A		
power steering / servosterzo	OM473LA	425	578	04/13	>				S 3081 PO	
cabin ventilation / ventilazione cabina	OM473LA	425	578	04/13	>				S 3448 C	
4163 BlueTec 5/6/EEV	OM473LA	460	625	04/13	>	S 5156 PE		S 7F22 A	S 3459 C	
with activated carbons / ai carboni attivi	OM473LA	460	625	04/13	>				S 4349 CA	
with outer front air intake / con presa aria frontale, esterno	OM473LA	460	625	04/13	>			S 7F20 A		
LONG LIFE	OM473LA	460	625	04/13	>			S 7F21 A		
power steering / servosterzo	OM473LA	460	625	04/13	>				S 3081 PO	
cabin ventilation / ventilazione cabina	OM473LA	460	625	04/13	>				S 3448 C	
4448 BlueTec 5/6/EEV	OM471LA	350	476	10/13	>	S 5156 PE		S 7F22 A	S 3459 C	
with activated carbons / ai carboni attivi	OM471LA	350	476	10/13	>				S 4349 CA	
with outer front air intake / con presa aria frontale, esterno	OM471LA	350	476	10/13	>			S 7F20 A		
LONG LIFE	OM471LA	350	476	10/13	>			S 7F21 A		
power steering / servosterzo	OM471LA	350	476	10/13	>				S 3081 PO	
cabin ventilation / ventilazione cabina	OM471LA	350	476	10/13	>				S 3448 C	
4451 BlueTec 5/6/EEV	OM471LA	375	510	10/13	>	S 5156 PE		S 7F22 A	S 3459 C	
with activated carbons / ai carboni attivi	OM471LA	375	510	10/13	>				S 4349 CA	
with outer front air intake / con presa aria frontale, esterno	OM471LA	375	510	10/13	>			S 7F20 A		
LONG LIFE	OM471LA	375	510	10/13	>			S 7F21 A		
power steering / servosterzo	OM471LA	375	510	10/13	>				S 3081 PO	
cabin ventilation / ventilazione cabina	OM471LA	375	510	10/13	>				S 3448 C	
4458 BlueTec 5/6/EEV	OM473LA	425	578	10/13	>	S 5156 PE		S 7F22 A	S 3459 C	
with activated carbons / ai carboni attivi	OM473LA	425	578	10/13	>				S 4349 CA	
with outer front air intake / con presa aria frontale, esterno	OM473LA	425	578	10/13	>			S 7F20 A		
LONG LIFE	OM473LA	425	578	10/13	>			S 7F21 A		
power steering / servosterzo	OM473LA	425	578	10/13	>				S 3081 PO	
cabin ventilation / ventilazione cabina	OM473LA	425	578	10/13	>				S 3448 C	
Atego I										
1017	OM904LA	125	170	02/98	>	12/04	S 5007 PE	S 6017 NE	S 7383 A	S 3054 C

**KW HP****...MERCEDES BENZ - trucks/autocarri****M**

power steering / servosterzo	OM906LA	170	231	02/98	>	12/04				S 3081 PO
1525	OM906LA	180	245	02/98	>	12/04	S 5036 PE	S 6017 NE	S 7383 A	S 3054 C
dryer filter / filtro essiccatore	OM906LA	180	245	02/98	>	12/04				S 7259 A
power steering / servosterzo	OM906LA	180	245	02/98	>	12/04				S 3081 PO
1528	OM906LA	205	279	02/98	>	12/04	S 5036 PE	S 6017 NE	S 7383 A	S 3054 C
dryer filter / filtro essiccatore	OM906LA	205	279	02/98	>	12/04				S 7259 A
power steering / servosterzo	OM906LA	205	279	02/98	>	12/04				S 3081 PO
1533	OM926LA	240	327	10/02	>	12/04	S 5036 PE	S 6017 NE	S 7383 A	S 3054 C
dryer filter / filtro essiccatore	OM926LA	240	327	10/02	>	12/04				S 7259 A
power steering / servosterzo	OM926LA	240	327	10/02	>	12/04				S 3081 PO
1823	OM906LA	170	231	07/98	>	12/04	S 5036 PE	S 6017 NE	S 7383 A	S 3054 C
some / alcuni	OM906LA	170	231	07/98	>	12/04	S 5036 PE	S 6017 NE	S 7279 A	S 3054 C
with panel air filter / con filtro aria a pannello	OM906LA	170	231	07/98	>	12/04			S 3373 A	
dryer filter / filtro essiccatore	OM906LA	170	231	07/98	>	12/04				S 7259 A
power steering / servosterzo	OM906LA	170	231	07/98	>	12/04				S 3081 PO
1828	OM906LA	205	279	07/98	>	12/04	S 5036 PE	S 6017 NE	S 7383 A	S 3054 C
some / alcuni	OM906LA	205	279	07/98	>	12/04	S 5036 PE	S 6017 NE	S 7279 A	S 3054 C
with panel air filter / con filtro aria a pannello	OM906LA	205	279	07/98	>	12/04			S 3373 A	
dryer filter / filtro essiccatore	OM906LA	205	279	07/98	>	12/04				S 7259 A
power steering / servosterzo	OM906LA	205	279	07/98	>	12/04				S 3081 PO
1833	OM926LA	240	327	10/02	>	12/04	S 5036 PE	S 6017 NE	S 7383 A	S 3054 C
with panel air filter / con filtro aria a pannello	OM926LA	240	327	07/98	>	12/04			S 3373 A	
dryer filter / filtro essiccatore	OM926LA	240	327	10/02	>	12/04				S 7259 A
power steering / servosterzo	OM926LA	240	327	10/02	>	12/04				S 3081 PO
1923	OM906LA	170	231	07/98	>	12/04	S 5036 PE	S 6017 NE	S 7383 A	S 3054 C
dryer filter / filtro essiccatore	OM906LA	170	231	07/98	>	12/04				S 7259 A
power steering / servosterzo	OM906LA	170	231	07/98	>	12/04				S 3081 PO
spare part only / solo ricambio	OM906LA	170	231	07/98	>	12/04			S 7F13 A	
1928	OM906LA	205	279	02/98	>	12/04	S 5036 PE	S 6017 NE	S 7383 A	S 3054 C
dryer filter / filtro essiccatore	OM906LA	205	279	02/98	>	12/04				S 7259 A
power steering / servosterzo	OM906LA	205	279	02/98	>	12/04				S 3081 PO
spare part only / solo ricambio	OM906LA	205	279	02/98	>	12/04			S 7F13 A	
2223	OM906LA	170	231	07/98	>	12/04	S 5036 PE	S 6017 NE	S 7383 A	S 3054 C
dryer filter / filtro essiccatore	OM906LA	170	231	07/98	>	12/04				S 7259 A
power steering / servosterzo	OM906LA	170	231	07/98	>	12/04				S 3081 PO
spare part only / solo ricambio	OM906LA	170	231	07/98	>	12/04			S 7F13 A	
2228	OM906LA	205	279	07/98	>	12/04	S 5036 PE	S 6017 NE	S 7383 A	S 3054 C
dryer filter / filtro essiccatore	OM906LA	205	279	07/98	>	12/04				S 7259 A
power steering / servosterzo	OM906LA	205	279	07/98	>	12/04				S 3081 PO
spare part only / solo ricambio	OM906LA	205	279	07/98	>	12/04			S 7F13 A	
2523	OM906LA	170	231	09/98	>	12/04	S 5036 PE	S 6017 NE	S 7383 A	S 3054 C
with panel air filter / con filtro aria a pannello	OM906LA	170	231	07/98	>	12/04			S 3373 A	
dryer filter / filtro essiccatore	OM906LA	170	231	09/98	>	12/04				S 7259 A
power steering / servosterzo	OM906LA	170	231	09/98	>	12/04				S 3081 PO
2528	OM906LA	205	279	09/98	>	12/04	S 5036 PE	S 6017 NE	S 7383 A	S 3054 C
with panel air filter / con filtro aria a pannello	OM906LA	205	279	07/98	>	12/04			S 3373 A	
dryer filter / filtro essiccatore	OM906LA	205	279	09/98	>	12/04				S 7259 A
power steering / servosterzo	OM906LA	205	279	09/98	>	12/04				S 3081 PO
2533	OM926LA	240	327	10/02	>	12/04	S 5036 PE	S 6017 NE	S 7383 A	S 3054 C
with panel air filter / con filtro aria a pannello	OM926LA	240	327	07/98	>	12/04			S 3373 A	
dryer filter / filtro essiccatore	OM926LA	240	327	10/02	>	12/04				S 7259 A
power steering / servosterzo	OM926LA	240	327	10/02	>	12/04				S 3081 PO
2628	OM906LA	205	279	07/98	>	12/04	S 5036 PE	S 6017 NE	S 7383 A	S 3054 C
some / alcuni	OM906LA	205	279	07/98	>	12/04	S 5036 PE	S 6017 NE	S 7279 A	S 3054 C
with panel air filter / con filtro aria a pannello	OM906LA	205	279	07/98	>	12/04			S 3373 A	
dryer filter / filtro essiccatore	OM906LA	205	279	07/98	>	12/04				S 7259 A
power steering / servosterzo	OM906LA	205	279	07/98	>	12/04				S 3081 PO
2633	OM926LA	240	327	10/02	>	12/04	S 5036 PE	S 6017 NE	S 7383 A	S 3054 C
with panel air filter / con filtro aria a pannello	OM926LA	240	327	07/98	>	12/04			S 3373 A	
dryer filter / filtro essiccatore	OM926LA	240	327	10/02	>	12/04				S 7259 A
power steering / servosterzo	OM926LA	240	327	10/02	>	12/04				S 3081 PO
712	OM904LA	90	122	02/98	>	12/04	S 5007 PE	S 6017 NE	S 7383 A	S 3054 C
dryer filter / filtro essiccatore	OM904LA	90	122	02/98	>	12/04				S 7259 A
power steering / servosterzo	OM904LA	90	122	02/98	>	12/04				S 3081 PO

**KW HP****...MERCEDES BENZ - trucks/autocarri**

714	OM904LA	100	136	02/98	>	12/04	S 5007 PE	S 6017 NE	S 7383 A	S 3054 C
dryer filter / filtro essiccatore	OM904LA	100	136	02/98	>	12/04				S 7259 A
power steering / servosterzo	OM904LA	100	136	02/98	>	12/04				S 3081 PO
715	OM904LA	112	152	02/98	>	12/04	S 5007 PE	S 6017 NE	S 7383 A	S 3054 C
dryer filter / filtro essiccatore	OM904LA	112	152	02/98	>	12/04				S 7259 A
power steering / servosterzo	OM904LA	112	152	02/98	>	12/04				S 3081 PO
717	OM904LA	125	170	02/98	>	12/04	S 5007 PE	S 6017 NE	S 7383 A	S 3054 C
dryer filter / filtro essiccatore	OM904LA	125	170	02/98	>	12/04				S 7259 A
power steering / servosterzo	OM904LA	125	170	02/98	>	12/04				S 3081 PO
812	OM904LA	90	122	02/98	>	12/04	S 5007 PE	S 6017 NE	S 7383 A	S 3054 C
dryer filter / filtro essiccatore	OM904LA	90	122	02/98	>	12/04				S 7259 A
power steering / servosterzo	OM904LA	90	122	02/98	>	12/04				S 3081 PO
814	OM904LA	100	136	02/98	>	12/04	S 5007 PE	S 6017 NE	S 7383 A	S 3054 C
dryer filter / filtro essiccatore	OM904LA	100	136	02/98	>	12/04				S 7259 A
power steering / servosterzo	OM904LA	100	136	02/98	>	12/04				S 3081 PO
815	OM904LA	112	152	02/98	>	12/04	S 5007 PE	S 6017 NE	S 7383 A	S 3054 C
dryer filter / filtro essiccatore	OM904LA	112	152	02/98	>	12/04				S 7259 A
power steering / servosterzo	OM904LA	112	152	02/98	>	12/04				S 3081 PO
817	OM904LA	125	170	02/98	>	12/04	S 5007 PE	S 6017 NE	S 7383 A	S 3054 C
dryer filter / filtro essiccatore	OM904LA	125	170	02/98	>	12/04				S 7259 A
power steering / servosterzo	OM904LA	125	170	02/98	>	12/04				S 3081 PO
818	OM904LA	130	177	09/00	>	12/04	S 5007 PE	S 6017 NE	S 7383 A	S 3054 C
dryer filter / filtro essiccatore	OM904LA	130	177	09/00	>	12/04				S 7259 A
power steering / servosterzo	OM904LA	130	177	09/00	>	12/04				S 3081 PO
823	OM906LA	170	231	02/98	>	12/04	S 5036 PE	S 6017 NE	S 7383 A	S 3054 C
dryer filter / filtro essiccatore	OM906LA	170	231	02/98	>	12/04				S 7259 A
power steering / servosterzo	OM906LA	170	231	02/98	>	12/04				S 3081 PO
828 F	OM906LA	205	279	02/98	>	12/04	S 5036 PE	S 6017 NE	S 7383 A	S 3054 C
dryer filter / filtro essiccatore	OM906LA	205	279	02/98	>	12/04				S 7259 A
power steering / servosterzo	OM906LA	205	279	02/98	>	12/04				S 3081 PO
914	OM904LA	100	136	02/98	>	12/04	S 5007 PE	S 6017 NE	S 7383 A	S 3054 C
dryer filter / filtro essiccatore	OM904LA	100	136	02/98	>	12/04				S 7259 A
power steering / servosterzo	OM904LA	100	136	02/98	>	12/04				S 3081 PO
917	OM904LA	125	170	02/98	>	12/04	S 5007 PE	S 6017 NE	S 7383 A	S 3054 C
dryer filter / filtro essiccatore	OM904LA	125	170	02/98	>	12/04				S 7259 A
power steering / servosterzo	OM904LA	125	170	02/98	>	12/04				S 3081 PO
918	OM904LA	130	177	09/00	>	12/04	S 5007 PE	S 6017 NE	S 7383 A	S 3054 C
dryer filter / filtro essiccatore	OM904LA	130	177	09/00	>	12/04				S 7259 A
power steering / servosterzo	OM904LA	130	177	09/00	>	12/04				S 3081 PO
923	OM906LA	170	231	02/98	>	12/04	S 5036 PE	S 6017 NE	S 7383 A	S 3054 C
dryer filter / filtro essiccatore	OM906LA	170	231	02/98	>	12/04				S 7259 A
power steering / servosterzo	OM906LA	170	231	02/98	>	12/04				S 3081 PO
925	OM906LA	180	245	02/98	>	12/04	S 5036 PE	S 6017 NE	S 7383 A	S 3054 C
dryer filter / filtro essiccatore	OM906LA	180	245	02/98	>	12/04				S 7259 A
power steering / servosterzo	OM906LA	180	245	02/98	>	12/04				S 3081 PO
928	OM906LA	205	279	02/98	>	12/04	S 5036 PE	S 6017 NE	S 7383 A	S 3054 C
dryer filter / filtro essiccatore	OM906LA	205	279	02/98	>	12/04				S 7259 A
power steering / servosterzo	OM906LA	205	279	02/98	>	12/04				S 3081 PO

Atego II

1015	OM904LA	110	150	09/04	>		S 5007 PE	S 6017 NE	S 7383 A	S 3054 C
dryer filter / filtro essiccatore	OM904LA	110	150	09/04	>					S 7259 A
filter PARKER-RACOR / filtro PARKER-RACOR	OM904LA	110	150	09/04	>			S 4479 NR		
power steering / servosterzo	OM904LA	110	150	09/04	>					S 3081 PO
1016 Blue Tec 4+5	OM904LA	115	156	09/05	>		S 5007 PE	S 6017 NE	S 7383 A	S 3054 C
dryer filter / filtro essiccatore	OM904LA	115	156	09/05	>					S 7259 A
filter PARKER-RACOR / filtro PARKER-RACOR	OM904LA	115	156	09/05	>			S 4479 NR		
power steering / servosterzo	OM904LA	115	156	09/05	>					S 3081 PO
1018	OM904LA	130	177	09/04	>		S 5007 PE	S 6017 NE	S 7383 A	S 3054 C
dryer filter / filtro essiccatore	OM904LA	130	177	09/04	>					S 7259 A
filter PARKER-RACOR / filtro PARKER-RACOR	OM904LA	130	177	09/04	>			S 4479 NR		
power steering / servosterzo	OM904LA	130	177	09/04	>					S 3081 PO
1022	OM924LA	160	218	09/04	>		S 5007 PE	S 6017 NE	S 7383 A	S 3054 C
dryer filter / filtro essiccatore	OM924LA	160	218	09/04	>					S 7259 A
filter PARKER-RACOR / filtro PARKER-RACOR	OM924LA	160	218	09/04	>			S 4479 NR		
power steering / servosterzo	OM924LA	160	218	09/04	>					S 3081 PO
1023	OM906LA	170	231	09/04	>		S 5036 PE	S 6017 NE	S 7383 A	S 3054 C
dryer filter / filtro essiccatore	OM906LA	170	231	09/04	>					S 7259 A

M

**kW HP****...MERCEDES BENZ - trucks/autocarri**

filter PARKER-RACOR / filtro PARKER-RACOR	OM904LA	130	177	09/04	>		S 4479 NR		
power steering / servosterzo	OM904LA	130	177	09/04	>				S 3081 PO
1522	OM924LA	160	218	09/04	>	S 5007 PE	S 6017 NE	S 7383 A	S 3054 C
dryer filter / filtro essiccatore	OM924LA	160	218	09/04	>				S 7259 A
filter PARKER-RACOR / filtro PARKER-RACOR	OM924LA	160	218	09/04	>		S 4479 NR		
power steering / servosterzo	OM924LA	160	218	09/04	>				S 3081 PO
1523	OM906LA	170	231	09/04	>	S 5036 PE	S 6017 NE	S 7383 A	S 3054 C
dryer filter / filtro essiccatore	OM906LA	170	231	09/04	>				S 7259 A
filter PARKER-RACOR / filtro PARKER-RACOR	OM906LA	170	231	09/04	>		S 4479 NR		
power steering / servosterzo	OM906LA	170	231	09/04	>				S 3081 PO
1524 Blue Tec 4+5	OM906LA	175	238	09/05	>	S 5036 PE	S 6017 NE	S 7383 A	S 3054 C
dryer filter / filtro essiccatore	OM906LA	175	238	09/05	>				S 7259 A
filter PARKER-RACOR / filtro PARKER-RACOR	OM906LA	175	238	09/05	>		S 4479 NR		
power steering / servosterzo	OM906LA	175	238	09/05	>				S 3081 PO
1526 Blue Tec 4+5	OM906LA	188	256	09/05	>	S 5036 PE	S 6017 NE	S 7383 A	S 3054 C
dryer filter / filtro essiccatore	OM906LA	188	256	09/05	>				S 7259 A
filter PARKER-RACOR / filtro PARKER-RACOR	OM906LA	188	256	09/05	>		S 4479 NR		
power steering / servosterzo	OM906LA	188	256	09/05	>				S 3081 PO
1528	OM906LA	205	279	09/04	>	S 5036 PE	S 6017 NE	S 7383 A	S 3054 C
dryer filter / filtro essiccatore	OM906LA	205	279	09/04	>				S 7259 A
filter PARKER-RACOR / filtro PARKER-RACOR	OM906LA	205	279	09/04	>		S 4479 NR		
power steering / servosterzo	OM906LA	205	279	09/04	>				S 3081 PO
1529 Blue Tec 4+5	OM906LA	210	286	09/05	>	S 5036 PE	S 6017 NE	S 7383 A	S 3054 C
dryer filter / filtro essiccatore	OM906LA	210	286	09/05	>				S 7259 A
filter PARKER-RACOR / filtro PARKER-RACOR	OM906LA	210	286	09/05	>		S 4479 NR		
power steering / servosterzo	OM906LA	210	286	09/05	>				S 3081 PO
712	OM904LA	90	122	09/04	>	S 5007 PE	S 6017 NE	S 7383 A	S 3054 C
dryer filter / filtro essiccatore	OM904LA	90	122	09/04	>				S 7259 A
filter PARKER-RACOR / filtro PARKER-RACOR	OM904LA	90	122	09/04	>		S 4479 NR		
power steering / servosterzo	OM904LA	90	122	09/04	>				S 3081 PO
713 Blue Tec 4+5	OM904LA	95	129	09/05	>	S 5007 PE	S 6017 NE	S 7383 A	S 3054 C
dryer filter / filtro essiccatore	OM904LA	95	129	09/05	>				S 7259 A
filter PARKER-RACOR / filtro PARKER-RACOR	OM904LA	95	129	09/05	>		S 4479 NR		
power steering / servosterzo	OM904LA	95	129	09/05	>				S 3081 PO
715	OM904LA	110	150	09/04	>	S 5007 PE	S 6017 NE	S 7383 A	S 3054 C
dryer filter / filtro essiccatore	OM904LA	110	150	09/04	>				S 7259 A
filter PARKER-RACOR / filtro PARKER-RACOR	OM904LA	110	150	09/04	>		S 4479 NR		
power steering / servosterzo	OM904LA	110	150	09/04	>				S 3081 PO
812	OM904LA	90	122	09/04	>	S 5007 PE	S 6017 NE	S 7383 A	S 3054 C
dryer filter / filtro essiccatore	OM904LA	90	122	09/04	>				S 7259 A
filter PARKER-RACOR / filtro PARKER-RACOR	OM904LA	90	122	09/04	>		S 4479 NR		
power steering / servosterzo	OM904LA	90	122	09/04	>				S 3081 PO
813 Blue Tec 4+5	OM904LA	95	129	09/05	>	S 5007 PE	S 6017 NE	S 7383 A	S 3054 C
dryer filter / filtro essiccatore	OM904LA	95	129	09/05	>				S 7259 A
filter PARKER-RACOR / filtro PARKER-RACOR	OM904LA	95	129	09/05	>		S 4479 NR		
power steering / servosterzo	OM904LA	95	129	09/05	>				S 3081 PO
815	OM904LA	110	150	09/04	>	S 5007 PE	S 6017 NE	S 7383 A	S 3054 C
dryer filter / filtro essiccatore	OM904LA	110	150	09/04	>				S 7259 A
filter PARKER-RACOR / filtro PARKER-RACOR	OM904LA	110	150	09/04	>		S 4479 NR		
power steering / servosterzo	OM904LA	110	150	09/04	>				S 3081 PO
816 Blue Tec 4+5	OM904LA	115	156	09/05	>	S 5007 PE	S 6017 NE	S 7383 A	S 3054 C
dryer filter / filtro essiccatore	OM904LA	115	156	09/05	>				S 7259 A
filter PARKER-RACOR / filtro PARKER-RACOR	OM904LA	115	156	09/05	>		S 4479 NR		
power steering / servosterzo	OM904LA	115	156	09/05	>				S 3081 PO
818	OM904LA	130	177	09/04	>	S 5007 PE	S 6017 NE	S 7383 A	S 3054 C
dryer filter / filtro essiccatore	OM904LA	130	177	09/04	>				S 7259 A
filter PARKER-RACOR / filtro PARKER-RACOR	OM904LA	130	177	09/04	>		S 4479 NR		
power steering / servosterzo	OM904LA	130	177	09/04	>				S 3081 PO
822	OM924LA	160	218	09/04	>	S 5007 PE	S 6017 NE	S 7383 A	S 3054 C
dryer filter / filtro essiccatore	OM924LA	160	218	09/04	>				S 7259 A
filter PARKER-RACOR / filtro PARKER-RACOR	OM924LA	160	218	09/04	>		S 4479 NR		
power steering / servosterzo	OM924LA	160	218	09/04	>				S 3081 PO
823	OM906LA	170	231	09/04	>	S 5036 PE	S 6017 NE	S 7383 A	S 3054 C
dryer filter / filtro essiccatore	OM906LA	170	231	09/04	>				S 7259 A
power steering / servosterzo	OM906LA	170	231	09/04	>				S 3081 PO
824 Blue Tec 4+5	OM906LA	175	238	09/05	>	S 5036 PE	S 6017 NE	S 7383 A	S 3054 C
dryer filter / filtro essiccatore	OM906LA	175	238	09/05	>				S 7259 A

M

**KW HP****...MERCEDES BENZ - trucks/autocarri****M**

filter PARKER-RACOR / filtro PARKER-RACOR	OM906LA	175	238	09/05	>		S 4479 NR		
power steering / servosterzo	OM906LA	175	238	09/05	>				S 3081 PO
915	OM904LA	110	150	09/04	>	S 5007 PE	S 6017 NE	S 7383 A	S 3054 C
filter / filtro	OM904LA	110	150	09/04	>		S 4479 NR		
dryer filter / filtro essiccatore	OM904LA	110	150	09/04	>				S 7259 A
power steering / servosterzo	OM904LA	110	150	09/04	>				S 3081 PO
916 Blue Tec 4+5	OM904LA	115	156	09/05	>	S 5007 PE	S 6017 NE	S 7383 A	S 3054 C
dryer filter / filtro essiccatore	OM904LA	115	156	09/05	>				S 7259 A
filter PARKER-RACOR / filtro PARKER-RACOR	OM904LA	115	156	09/05	>		S 4479 NR		
power steering / servosterzo	OM904LA	115	156	09/05	>				S 3081 PO
918	OM904LA	130	177	09/04	>	S 5007 PE	S 6017 NE	S 7383 A	S 3054 C
dryer filter / filtro essiccatore	OM904LA	130	177	09/04	>				S 7259 A
filter PARKER-RACOR / filtro PARKER-RACOR	OM904LA	130	177	09/04	>		S 4479 NR		
power steering / servosterzo	OM904LA	130	177	09/04	>				S 3081 PO
922	OM924LA	160	218	09/04	>	S 5007 PE	S 6017 NE	S 7383 A	S 3054 C
dryer filter / filtro essiccatore	OM924LA	160	218	09/04	>				S 7259 A
filter PARKER-RACOR / filtro PARKER-RACOR	OM924LA	160	218	09/04	>		S 4479 NR		
power steering / servosterzo	OM924LA	160	218	09/04	>				S 3081 PO
923	OM906LA	170	231	09/04	>	S 5036 PE	S 6017 NE	S 7383 A	S 3054 C
dryer filter / filtro essiccatore	OM906LA	170	231	09/04	>				S 7259 A
filter PARKER-RACOR / filtro PARKER-RACOR	OM906LA	170	231	09/04	>		S 4479 NR		
power steering / servosterzo	OM906LA	170	231	09/04	>				S 3081 PO
924 Blue Tec 4+5	OM906LA	175	238	09/05	>	S 5036 PE	S 6017 NE	S 7383 A	S 3054 C
dryer filter / filtro essiccatore	OM906LA	175	238	09/05	>				S 7259 A
filter PARKER-RACOR / filtro PARKER-RACOR	OM906LA	175	238	09/05	>		S 4476 NR		
power steering / servosterzo	OM906LA	175	238	09/05	>				S 3081 PO
Atego III (967)									
1016	OM934LA	115	156	05/13	>		S 6148 NE	S 7F13 A	S 3054 C
dryer filter / filtro essiccatore	OM934LA	115	156	05/13	>				S 7A66 A
power steering / servosterzo	OM934LA	115	156	05/13	>				S 3081 PO
1018	OM934LA	130	177	05/13	>		S 6148 NE	S 7F13 A	S 3054 C
dryer filter / filtro essiccatore	OM934LA	130	177	05/13	>				S 7A66 A
power steering / servosterzo	OM934LA	130	177	05/13	>				S 3081 PO
1021	OM934LA	155	211	05/13	>		S 6148 NE	S 7F13 A	S 3054 C
dryer filter / filtro essiccatore	OM934LA	155	211	05/13	>				S 7A66 A
power steering / servosterzo	OM934LA	155	211	05/13	>				S 3081 PO
1023	OM934LA	170	231	05/13	>		S 6148 NE	S 7F13 A	S 3054 C
dryer filter / filtro essiccatore	OM934LA	170	231	05/13	>				S 7A66 A
power steering / servosterzo	OM934LA	170	231	05/13	>				S 3081 PO
1024	OM936LA	175	238	05/13	>	S 5236 PE	S 6148 NE	S 7F13 A	S 3054 C
dryer filter / filtro essiccatore	OM936LA	175	238	05/13	>				S 7A66 A
power steering / servosterzo	OM936LA	175	238	05/13	>				S 3081 PO
1216	OM934LA	115	156	05/13	>		S 6148 NE	S 7F13 A	S 3054 C
dryer filter / filtro essiccatore	OM934LA	115	156	05/13	>				S 7A66 A
power steering / servosterzo	OM934LA	115	156	05/13	>				S 3081 PO
1218	OM934LA	130	177	05/13	>		S 6148 NE	S 7F13 A	S 3054 C
dryer filter / filtro essiccatore	OM934LA	130	177	05/13	>				S 7A66 A
power steering / servosterzo	OM934LA	130	177	05/13	>				S 3081 PO
1221	OM934LA	155	211	05/13	>		S 6148 NE	S 7F13 A	S 3054 C
dryer filter / filtro essiccatore	OM934LA	155	211	05/13	>				S 7A66 A
power steering / servosterzo	OM934LA	155	211	05/13	>				S 3081 PO
1223	OM934LA	170	231	05/13	>		S 6148 NE	S 7F13 A	S 3054 C
dryer filter / filtro essiccatore	OM934LA	170	231	05/13	>				S 7A66 A
power steering / servosterzo	OM934LA	170	231	05/13	>				S 3081 PO
1224	OM936LA	175	238	05/13	>	S 5236 PE	S 6148 NE	S 7F13 A	S 3054 C
dryer filter / filtro essiccatore	OM936LA	175	238	05/13	>				S 7A66 A
power steering / servosterzo	OM936LA	175	238	05/13	>				S 3081 PO
1227	OM936LA	200	272	05/13	>	S 5236 PE	S 6148 NE	S 7F13 A	S 3054 C
dryer filter / filtro essiccatore	OM936LA	200	272	05/13	>				S 7A66 A
power steering / servosterzo	OM936LA	200	272	05/13	>				S 3081 PO
1230	OM936LA	220	299	05/13	>	S 5236 PE	S 6148 NE	S 7F13 A	S 3054 C
dryer filter / filtro essiccatore	OM936LA	220	299	05/13	>				S 7A66 A
power steering / servosterzo	OM936LA	220	299	05/13	>				S 3081 PO
1318	OM934LA	130	177	05/13	>		S 6148 NE	S 7F13 A	S 3054 C
dryer filter / filtro essiccatore	OM934LA	130	177	05/13	>				S 7A66 A
power steering / servosterzo	OM934LA	130	177	05/13	>				S 3081 PO
dusty areas / zone polverose	OM934LA	130	177	05/13	>				S 3437 C

**KW HP****...MERCEDES BENZ - trucks/autocarri****M**

dryer filter / filtro essiccatore	OM934LA	170	231	05/13	>				S 7A66 A
power steering / servosterzo	OM934LA	170	231	05/13	>				S 3081 PO
dusty areas / zone polverose	OM934LA	170	231	05/13	>				S 3437 C
824	OM936LA	175	238	05/13	>	S 5236 PE	S 6148 NE	S 7F13 A	S 3054 C
dryer filter / filtro essiccatore	OM936LA	175	238	05/13	>				S 7A66 A
power steering / servosterzo	OM936LA	175	238	05/13	>				S 3081 PO
916	OM934LA	115	156	05/13	>		S 6148 NE		
dryer filter / filtro essiccatore	OM934LA	115	156	05/13	>				S 7A66 A
power steering / servosterzo	OM934LA	115	156	05/13	>				S 3081 PO
dusty areas / zone polverose	OM934LA	115	156	05/13	>				S 3437 C
918	OM934LA	130	177	05/13	>		S 6148 NE	S 7F13 A	S 3054 C
dryer filter / filtro essiccatore	OM934LA	130	177	05/13	>				S 7A66 A
power steering / servosterzo	OM934LA	130	177	05/13	>				S 3081 PO
dusty areas / zone polverose	OM934LA	130	177	05/13	>				S 3437 C
921	OM934LA	155	211	05/13	>		S 6148 NE	S 7F13 A	S 3054 C
dryer filter / filtro essiccatore	OM934LA	155	211	05/13	>				S 7A66 A
power steering / servosterzo	OM934LA	155	211	05/13	>				S 3081 PO
dusty areas / zone polverose	OM934LA	155	211	05/13	>				S 3437 C
923	OM934LA	170	231	05/13	>		S 6148 NE	S 7F13 A	S 3054 C
dryer filter / filtro essiccatore	OM934LA	170	231	05/13	>				S 7A66 A
power steering / servosterzo	OM934LA	170	231	05/13	>				S 3081 PO
dusty areas / zone polverose	OM934LA	170	231	05/13	>				S 3437 C
924	OM936LA	175	238	05/13	>	S 5236 PE	S 6148 NE	S 7F13 A	S 3054 C
dryer filter / filtro essiccatore	OM936LA	175	238	05/13	>				S 7A66 A
power steering / servosterzo	OM936LA	175	238	05/13	>				S 3081 PO
927	OM936LA	200	272	05/13	>	S 5236 PE	S 6148 NE	S 7F13 A	S 3054 C
dryer filter / filtro essiccatore	OM936LA	200	272	05/13	>				S 7A66 A
power steering / servosterzo	OM936LA	200	272	05/13	>				S 3081 PO

Axor I

1835	OM457LA	260	353	10/01	>	02/03	S 5062 PE	S 6001 NE		S 3436 C
	OM457LA	260	353	03/03	>	12/04	S 5062 PE	S 6001 NE	S 7639 A	S 3436 C
with activated carbons / ai carboni attivi	OM457LA	260	353	10/01	>	12/04				S 4345 CA
some / alcuni	OM457LA	260	353	10/01	>	02/03			S 7280 A	
some / alcuni	OM457LA	260	353	10/01	>	02/03			S 7279 A	
with manual pump prefilter / con pompa manuale prefiltro	OM457LA	260	353	10/01	>	12/04		S 6089 NE		
dryer filter / filtro essiccatore	OM457LA	260	353	10/01	>	12/04				S 7259 A
power steering / servosterzo	OM457LA	260	353	10/01	>	12/04				S 3081 PO
dusty areas / zone polverose	OM457LA	260	353	10/01	>	12/04				S 3438 C
1840	OM457LA	295	401	10/01	>	02/03	S 5062 PE	S 6001 NE		S 3436 C
	OM457LA	295	401	03/03	>	12/04	S 5062 PE	S 6001 NE	S 7639 A	S 3436 C
with activated carbons / ai carboni attivi	OM457LA	295	401	10/01	>	12/04				S 4345 CA
some / alcuni	OM457LA	295	401	10/01	>	02/03	S 5062 PE	S 6001 NE	S 7280 A	
some / alcuni	OM457LA	295	401	10/01	>	02/03	S 5062 PE	S 6001 NE	S 7279 A	
some / alcuni	OM457LA	295	401	10/01	>	02/03			S 7280 A	
some / alcuni	OM457LA	295	401	10/01	>	02/03			S 7279 A	
some / alcuni	OM457LA	295	401	03/03	>	12/04	S 5062 PE	S 6001 NE		
some / alcuni	OM457LA	295	401	03/03	>	12/04	S 5062 PE	S 6001 NE		
with manual pump prefilter / con pompa manuale prefiltro	OM457LA	295	401	10/01	>	12/04		S 6089 NE		
dryer filter / filtro essiccatore	OM457LA	295	401	10/01	>	12/04				S 7259 A
dryer filter / filtro essiccatore	OM457LA	295	401	10/01	>	12/04				S 7259 A
power steering / servosterzo	OM457LA	295	401	10/01	>	12/04				S 3081 PO
power steering / servosterzo	OM457LA	295	401	10/01	>	12/04				S 3081 PO
dusty areas / zone polverose	OM457LA	295	401	10/01	>	12/04				S 3438 C
1843	OM457LA	315	428	10/01	>	02/03	S 5062 PE	S 6001 NE		S 3436 C
	OM457LA	315	428	03/03	>	12/04	S 5062 PE	S 6001 NE	S 7639 A	S 3436 C
with activated carbons / ai carboni attivi	OM457LA	315	428	10/01	>	12/04				S 4345 CA
some / alcuni	OM457LA	315	428	10/01	>	02/03	S 5062 PE	S 6001 NE	S 7280 A	
some / alcuni	OM457LA	315	428	10/01	>	02/03	S 5062 PE	S 6001 NE	S 7279 A	
some / alcuni	OM457LA	315	428	10/01	>	02/03			S 7280 A	
some / alcuni	OM457LA	315	428	10/01	>	02/03			S 7279 A	
some / alcuni	OM457LA	315	428	03/03	>	12/04	S 5062 PE	S 6001 NE		
some / alcuni	OM457LA	315	428	03/03	>	12/04	S 5062 PE	S 6001 NE		
with manual pump prefilter / con pompa manuale prefiltro	OM457LA	315	428	10/01	>	12/04		S 6089 NE		
dryer filter / filtro essiccatore	OM457LA	315	428	10/01	>	12/04				S 7259 A
dryer filter / filtro essiccatore	OM457LA	315	428	10/01	>	12/04				S 7259 A
power steering / servosterzo	OM457LA	315	428	10/01	>	12/04				S 3081 PO
power steering / servosterzo	OM457LA	315	428	10/01	>	12/04				S 3081 PO



...MERCEDES BENZ - trucks/autocarri

dusty areas / zone polverose	OM457LA	315	428	10/01	>	12/04				S 3438 C
2535	OM457LA	260	353	10/01	>	02/03	S 5062 PE	S 6001 NE		S 3436 C
	OM457LA	260	353	03/03	>	12/04	S 5062 PE	S 6001 NE	S 7639 A	S 3436 C
with activated carbons / ai carboni attivi	OM457LA	260	353	10/01	>	12/04				S 4345 CA
some / alcuni	OM457LA	260	353	10/01	>	02/03	S 5062 PE	S 6001 NE	S 7280 A	
some / alcuni	OM457LA	260	353	10/01	>	02/03	S 5062 PE	S 6001 NE	S 7279 A	
some / alcuni	OM457LA	260	353	10/01	>	02/03			S 7280 A	
some / alcuni	OM457LA	260	353	10/01	>	02/03			S 7279 A	
some / alcuni	OM457LA	260	353	03/03	>	12/04	S 5062 PE	S 6001 NE		
some / alcuni	OM457LA	260	353	03/03	>	12/04	S 5062 PE	S 6001 NE		
with manual pump prefilter / con pompa manuale prefiltra	OM457LA	260	353	10/01	>	12/04		S 6089 NE		
dryer filter / filtro essiccatore	OM457LA	260	353	10/01	>	12/04				S 7259 A
dryer filter / filtro essiccatore	OM457LA	260	353	10/01	>	12/04				S 7259 A
power steering / servosterzo	OM457LA	260	353	10/01	>	12/04				S 3081 PO
power steering / servosterzo	OM457LA	260	353	10/01	>	12/04				S 3081 PO
dusty areas / zone polverose	OM457LA	260	353	10/01	>	12/04				S 3438 C
2540	OM457LA	295	401	01/02	>	02/03	S 5062 PE	S 6001 NE		S 3436 C
	OM457LA	295	401	03/03	>	12/04	S 5062 PE	S 6001 NE	S 7639 A	S 3436 C
with activated carbons / ai carboni attivi	OM457LA	295	401	01/02	>	12/04				S 4345 CA
some / alcuni	OM457LA	295	401	01/02	>	02/03			S 7280 A	
some / alcuni	OM457LA	295	401	01/02	>	02/03			S 7279 A	
with manual pump prefilter / con pompa manuale prefiltra	OM457LA	295	401	01/02	>	12/04		S 6089 NE		
dryer filter / filtro essiccatore	OM457LA	295	401	01/02	>	12/04				S 7259 A
power steering / servosterzo	OM457LA	295	401	01/02	>	12/04				S 3081 PO
dusty areas / zone polverose	OM457LA	295	401	01/02	>	12/04				S 3438 C
2543	OM457LA	315	428	10/01	>	02/03	S 5062 PE	S 6001 NE		S 3436 C
	OM457LA	315	428	03/03	>	12/04	S 5062 PE	S 6001 NE	S 7639 A	S 3436 C
with activated carbons / ai carboni attivi	OM457LA	315	428	10/01	>	12/04				S 4345 CA
some / alcuni	OM457LA	315	428	10/01	>	02/03			S 7280 A	
some / alcuni	OM457LA	315	428	10/01	>	02/03			S 7279 A	
with manual pump prefilter / con pompa manuale prefiltra	OM457LA	315	428	10/01	>	12/04		S 6089 NE		
dryer filter / filtro essiccatore	OM457LA	315	428	10/01	>	12/04				S 7259 A
power steering / servosterzo	OM457LA	315	428	10/01	>	12/04				S 3081 PO
dusty areas / zone polverose	OM457LA	315	428	10/01	>	12/04				S 3438 C
Axor II										
1823	OM906LA	170	231	09/04	>		S 5036 PE	S 6017 NE	S 7383 A	
dryer filter / filtro essiccatore	OM906LA	170	231	09/04	>					S 7259 A
filter PARKER-RACOR / filtro PARKER-RACOR	OM906LA	170	231	09/04	>			S 4479 NR		
power steering / servosterzo	OM906LA	170	231	09/04	>					S 3081 PO
Vehicles for building site with panel air filter / veicoli da cantiere con filtro aria a pannello	OM906LA	170	231	09/04	>				S 3373 A	
1824 Blue Tec 4+5	OM906LA	175	238	09/05	>		S 5036 PE	S 6017 NE	S 7383 A	
dryer filter / filtro essiccatore	OM906LA	175	238	09/05	>					S 7259 A
filter PARKER-RACOR / filtro PARKER-RACOR	OM906LA	175	238	09/05	>			S 4479 NR		
power steering / servosterzo	OM906LA	175	238	09/05	>					S 3081 PO
Vehicles for building site with panel air filter / veicoli da cantiere con filtro aria a pannello	OM906LA	175	238	09/05	>				S 3373 A	
1826 Blue Tec 4+5	OM906LA	188	256	09/05	>		S 5036 PE	S 6017 NE	S 7383 A	
dryer filter / filtro essiccatore	OM906LA	188	256	09/05	>					S 7259 A
filter PARKER-RACOR / filtro PARKER-RACOR	OM906LA	188	256	09/05	>			S 4479 NR		
power steering / servosterzo	OM906LA	188	256	09/05	>					S 3081 PO
Vehicles for building site with panel air filter / veicoli da cantiere con filtro aria a pannello	OM906LA	188	256	09/05	>				S 3373 A	
1828	OM906LA	205	279	09/04	>		S 5036 PE	S 6017 NE	S 7383 A	
dryer filter / filtro essiccatore	OM906LA	205	279	09/04	>					S 7259 A
filter PARKER-RACOR / filtro PARKER-RACOR	OM906LA	205	279	09/04	>			S 4479 NR		
power steering / servosterzo	OM906LA	205	279	09/04	>					S 3081 PO
Vehicles for building site with panel air filter / veicoli da cantiere con filtro aria a pannello	OM906LA	205	279	09/04	>				S 3373 A	
1829 Blue Tec 4+5/EEV	OM906LA	210	286	09/05	>		S 5036 PE	S 6017 NE	S 7383 A	
dryer filter / filtro essiccatore	OM906LA	210	286	09/05	>					S 7259 A
filter PARKER-RACOR / filtro PARKER-RACOR	OM906LA	210	286	09/05	>			S 4479 NR		
power steering / servosterzo	OM906LA	210	286	09/05	>					S 3081 PO
Vehicles for building site with panel air filter / veicoli da cantiere con filtro aria a pannello	OM906LA	210	286	09/05	>				S 3373 A	
1833	OM926LA	240	326	09/04	>		S 5036 PE	S 6017 NE	S 7383 A	
dryer filter / filtro essiccatore	OM926LA	240	326	09/04	>					S 7259 A
filter PARKER-RACOR / filtro PARKER-RACOR	OM926LA	240	326	09/04	>			S 4479 NR		
power steering / servosterzo	OM926LA	240	326	09/04	>					S 3081 PO
Vehicles for building site with panel air filter / veicoli da cantiere con filtro aria a pannello	OM926LA	240	326	09/04	>				S 3373 A	
1833 Blue Tec 4+5	OM926LA	240	326	09/05	>		S 5036 PE	S 6017 NE	S 7383 A	
dryer filter / filtro essiccatore	OM926LA	240	326	09/05	>					S 7259 A

M

**KW HP****...MERCEDES BENZ - trucks/autocarri**

filter PARKER-RACOR / filtro PARKER-RACOR	OM926LA	240	326	09/05	>		S 4479 NR		S 3081 PO
power steering / servosterzo	OM926LA	240	326	09/05	>				
Vehicles for building site with panel air filter / veicoli da cantiere con filtro aria a pannello	OM926LA	240	326	09/05	>			S 3373 A	
1835	OM457LA	260	353	09/04	>	S 5062 PE	S 6001 NE		S 3436 C
with activated carbons / ai carboni attivi	OM457LA	260	353	09/04	>				S 4345 CA
with manual pump prefilter / con pompa manuale prefiltra	OM457LA	260	353	09/04	>		S 6089 NE		
dryer filter / filtro essiccatore	OM457LA	260	353	09/04	>				S 7259 A
filter PARKER-RACOR / filtro PARKER-RACOR	OM457LA	260	353	09/04	>		S 4479 NR		
assembly KNECHT-MAHLE / montaggio KNECHT-MAHLE	OM457LA	260	353	09/04	>			S 7639 A	
assembly MANN-HUMMEL / montaggio MANN-HUMMEL	OM457LA	260	353	09/04	>			S 7A12 A	
prefilter PARKER-RACOR / prefiltra PARKER-RACOR	OM457LA	260	353	09/04	>		S 4121 NR		
power steering / servosterzo	OM457LA	260	353	09/04	>				S 3081 PO
Vehicles for building site with panel air filter / veicoli da cantiere con filtro aria a pannello	OM457LA	260	353	09/04	>			S 3373 A	
dusty areas / zone polverose	OM457LA	260	353	09/04	>				S 3438 C
1836 Blue Tec 4+5	OM457LA	265	360	09/05	>	S 5062 PE	S 6001 NE		S 3436 C
with activated carbons / ai carboni attivi	OM457LA	265	360	09/05	>				S 4345 CA
with manual pump prefilter / con pompa manuale prefiltra	OM457LA	265	360	09/05	>		S 6089 NE		
dryer filter / filtro essiccatore	OM457LA	265	360	09/05	>				S 7259 A
filter PARKER-RACOR / filtro PARKER-RACOR	OM457LA	265	360	09/05	>		S 4479 NR		
assembly KNECHT-MAHLE / montaggio KNECHT-MAHLE	OM457LA	265	360	09/05	>			S 7639 A	
assembly MANN-HUMMEL / montaggio MANN-HUMMEL	OM457LA	265	360	09/05	>			S 7A12 A	
prefilter PARKER-RACOR / prefiltra PARKER-RACOR	OM457LA	265	360	09/05	>		S 4121 NR		
power steering / servosterzo	OM457LA	265	360	09/05	>				S 3081 PO
Vehicles for building site with panel air filter / veicoli da cantiere con filtro aria a pannello	OM457LA	265	360	09/05	>			S 3373 A	
dusty areas / zone polverose	OM457LA	265	360	09/05	>				S 3438 C
1840	OM457LA	295	401	09/04	>	S 5062 PE	S 6001 NE		S 3436 C
with activated carbons / ai carboni attivi	OM457LA	295	401	09/04	>				S 4345 CA
with manual pump prefilter / con pompa manuale prefiltra	OM457LA	295	401	09/04	>		S 6089 NE		
dryer filter / filtro essiccatore	OM457LA	295	401	09/04	>				S 7259 A
filter PARKER-RACOR / filtro PARKER-RACOR	OM457LA	295	401	09/04	>		S 4479 NR		
assembly KNECHT-MAHLE / montaggio KNECHT-MAHLE	OM457LA	295	401	09/04	>			S 7639 A	
assembly MANN-HUMMEL / montaggio MANN-HUMMEL	OM457LA	295	401	09/04	>			S 7A12 A	
prefilter PARKER-RACOR / prefiltra PARKER-RACOR	OM457LA	295	401	09/04	>		S 4121 NR		
power steering / servosterzo	OM457LA	295	401	09/04	>				S 3081 PO
Vehicles for building site with panel air filter / veicoli da cantiere con filtro aria a pannello	OM457LA	295	401	09/04	>			S 3373 A	
dusty areas / zone polverose	OM457LA	295	401	09/04	>				S 3438 C
1843	OM457LA	315	428	09/04	>	S 5062 PE	S 6001 NE		S 3436 C
with activated carbons / ai carboni attivi	OM457LA	315	428	09/04	>				S 4345 CA
with manual pump prefilter / con pompa manuale prefiltra	OM457LA	315	428	09/04	>		S 6089 NE		
dryer filter / filtro essiccatore	OM457LA	315	428	09/04	>				S 7259 A
filter PARKER-RACOR / filtro PARKER-RACOR	OM457LA	315	428	09/04	>		S 4479 NR		
assembly KNECHT-MAHLE / montaggio KNECHT-MAHLE	OM457LA	315	428	09/04	>			S 7639 A	
prefilter PARKER-RACOR / prefiltra PARKER-RACOR	OM457LA	315	428	09/04	>		S 4121 NR		
power steering / servosterzo	OM457LA	315	428	09/04	>				S 3081 PO
Vehicles for building site with panel air filter / veicoli da cantiere con filtro aria a pannello	OM457LA	315	428	09/04	>			S 3373 A	
dusty areas / zone polverose	OM457LA	315	428	09/04	>				S 3438 C
1843 Blue Tec 4+5	OM457LA	315	428	05/06	>	S 5062 PE	S 6001 NE		S 3436 C
with activated carbons / ai carboni attivi	OM457LA	315	428	05/06	>				S 4345 CA
with manual pump prefilter / con pompa manuale prefiltra	OM457LA	315	428	05/06	>		S 6089 NE		
dryer filter / filtro essiccatore	OM457LA	315	428	05/06	>				S 7259 A
filter PARKER-RACOR / filtro PARKER-RACOR	OM457LA	315	428	05/06	>		S 4479 NR		
assembly KNECHT-MAHLE / montaggio KNECHT-MAHLE	OM457LA	315	428	05/06	>			S 7639 A	
assembly MANN-HUMMEL / montaggio MANN-HUMMEL	OM457LA	315	428	05/06	>			S 7A12 A	
prefilter PARKER-RACOR / prefiltra PARKER-RACOR	OM457LA	315	428	05/06	>		S 4121 NR		
power steering / servosterzo	OM457LA	315	428	05/06	>				S 3081 PO
Vehicles for building site with panel air filter / veicoli da cantiere con filtro aria a pannello	OM457LA	315	428	05/06	>			S 3373 A	
dusty areas / zone polverose	OM457LA	315	428	05/06	>				S 3438 C
2523	OM906LA	170	231	09/04	>	S 5036 PE	S 6017 NE	S 7383 A	
dryer filter / filtro essiccatore	OM906LA	170	231	09/04	>				S 7259 A
filter PARKER-RACOR / filtro PARKER-RACOR	OM906LA	170	231	09/04	>		S 4479 NR		
power steering / servosterzo	OM906LA	170	231	09/04	>				S 3081 PO
Vehicles for building site with panel air filter / veicoli da cantiere con filtro aria a pannello	OM906LA	170	231	09/04	>			S 3373 A	
2528	OM906LA	205	279	09/04	>	S 5036 PE	S 6017 NE	S 7383 A	
dryer filter / filtro essiccatore	OM906LA	205	279	09/04	>				S 7259 A
filter PARKER-RACOR / filtro PARKER-RACOR	OM906LA	205	279	09/04	>		S 4479 NR		
power steering / servosterzo	OM906LA	205	279	09/04	>				S 3081 PO
Vehicles for building site with panel air filter / veicoli da cantiere con filtro aria a pannello	OM906LA	205	279	09/04	>			S 3373 A	

**KW HP****...MERCEDES BENZ - trucks/autocarri**

2529 Blue Tec 4+5/EEV	OM906LA	210	286	09/05	>	S 5036 PE	S 6017 NE	S 7383 A	
dryer filter / filtro essiccatore	OM906LA	210	286	09/05	>				S 7259 A
filter PARKER-RACOR / filtro PARKER-RACOR	OM906LA	210	286	09/05	>		S 4479 NR		
power steering / servosterzo	OM906LA	210	286	09/05	>				S 3081 PO
Vehicles for building site with panel air filter / veicoli da cantiere con filtro aria a pannello	OM906LA	210	286	09/05	>			S 3373 A	
2533	OM926LA	240	326	09/04	>	S 5036 PE	S 6017 NE	S 7383 A	
dryer filter / filtro essiccatore	OM926LA	240	326	09/04	>				S 7259 A
filter PARKER-RACOR / filtro PARKER-RACOR	OM926LA	240	326	09/04	>		S 4479 NR		
power steering / servosterzo	OM926LA	240	326	09/04	>				S 3081 PO
Vehicles for building site with panel air filter / veicoli da cantiere con filtro aria a pannello	OM926LA	240	326	09/04	>			S 3373 A	
2535	OM457LA	260	353	09/04	>	S 5062 PE	S 6001 NE		S 3436 C
with activated carbons / ai carboni attivi	OM457LA	260	353	09/04	>				S 4345 CA
with manual pump prefilter / con pompa manuale prefiltra	OM457LA	260	353	09/04	>		S 6089 NE		
dryer filter / filtro essiccatore	OM457LA	260	353	09/04	>				S 7259 A
filter PARKER-RACOR / filtro PARKER-RACOR	OM457LA	260	353	09/04	>		S 4479 NR		
assembly KNECHT-MAHLE / montaggio KNECHT-MAHLE	OM457LA	260	353	09/04	>			S 7639 A	
assembly MANN-HUMMEL / montaggio MANN-HUMMEL	OM457LA	260	353	09/04	>			S 7A12 A	
prefilter PARKER-RACOR / prefiltra PARKER-RACOR	OM457LA	260	353	09/04	>		S 4121 NR		
power steering / servosterzo	OM457LA	260	353	09/04	>				S 3081 PO
Vehicles for building site with panel air filter / veicoli da cantiere con filtro aria a pannello	OM457LA	260	353	09/04	>			S 3373 A	
dusty areas / zone polverose	OM457LA	260	353	09/04	>				S 3438 C
2536 Blue Tec 4+5	OM457LA	265	360	09/05	>	S 5062 PE	S 6001 NE		S 3436 C
with activated carbons / ai carboni attivi	OM457LA	265	360	09/05	>				S 4345 CA
with manual pump prefilter / con pompa manuale prefiltra	OM457LA	265	360	09/05	>		S 6089 NE		
dryer filter / filtro essiccatore	OM457LA	265	360	09/05	>				S 7259 A
filter PARKER-RACOR / filtro PARKER-RACOR	OM457LA	265	360	09/05	>		S 4479 NR		
assembly KNECHT-MAHLE / montaggio KNECHT-MAHLE	OM457LA	265	360	09/05	>			S 7639 A	
assembly MANN-HUMMEL / montaggio MANN-HUMMEL	OM457LA	265	360	09/05	>			S 7A12 A	
prefilter PARKER-RACOR / prefiltra PARKER-RACOR	OM457LA	265	360	09/05	>		S 4121 NR		
power steering / servosterzo	OM457LA	265	360	09/05	>				S 3081 PO
Vehicles for building site with panel air filter / veicoli da cantiere con filtro aria a pannello	OM457LA	265	360	09/05	>			S 3373 A	
dusty areas / zone polverose	OM457LA	265	360	09/05	>				S 3438 C
2540	OM457LA	295	401	09/04	>	S 5062 PE	S 6001 NE		S 3436 C
with activated carbons / ai carboni attivi	OM457LA	295	401	09/04	>				S 4345 CA
with manual pump prefilter / con pompa manuale prefiltra	OM457LA	295	401	09/04	>		S 6089 NE		
dryer filter / filtro essiccatore	OM457LA	295	401	09/04	>				S 7259 A
filter PARKER-RACOR / filtro PARKER-RACOR	OM457LA	295	401	09/04	>		S 4479 NR		
assembly KNECHT-MAHLE / montaggio KNECHT-MAHLE	OM457LA	295	401	09/04	>			S 7639 A	
assembly MANN-HUMMEL / montaggio MANN-HUMMEL	OM457LA	295	401	09/04	>			S 7A12 A	
prefilter PARKER-RACOR / prefiltra PARKER-RACOR	OM457LA	295	401	09/04	>		S 4121 NR		
power steering / servosterzo	OM457LA	295	401	09/04	>				S 3081 PO
Vehicles for building site with panel air filter / veicoli da cantiere con filtro aria a pannello	OM457LA	295	401	09/04	>			S 3373 A	
dusty areas / zone polverose	OM457LA	295	401	09/04	>				S 3438 C
2543	OM457LA	315	428	09/04	>	S 5062 PE	S 6001 NE		S 3436 C
with activated carbons / ai carboni attivi	OM457LA	315	428	09/04	>				S 4345 CA
with manual pump prefilter / con pompa manuale prefiltra	OM457LA	315	428	09/04	>		S 6089 NE		
dryer filter / filtro essiccatore	OM457LA	315	428	09/04	>				S 7259 A
filter PARKER-RACOR / filtro PARKER-RACOR	OM457LA	315	428	09/04	>		S 4479 NR		
assembly KNECHT-MAHLE / montaggio KNECHT-MAHLE	OM457LA	315	428	09/04	>			S 7639 A	
assembly MANN-HUMMEL / montaggio MANN-HUMMEL	OM457LA	315	428	09/04	>			S 7A12 A	
prefilter PARKER-RACOR / prefiltra PARKER-RACOR	OM457LA	315	428	09/04	>		S 4121 NR		
power steering / servosterzo	OM457LA	315	428	09/04	>				S 3081 PO
Vehicles for building site with panel air filter / veicoli da cantiere con filtro aria a pannello	OM457LA	315	428	09/04	>			S 3373 A	
dusty areas / zone polverose	OM457LA	315	428	09/04	>				S 3438 C
2628	OM906LA	205	279	09/04	>	S 5036 PE	S 6017 NE	S 7383 A	
dryer filter / filtro essiccatore	OM906LA	205	279	09/04	>				S 7259 A
filter PARKER-RACOR / filtro PARKER-RACOR	OM906LA	205	279	09/04	>		S 4479 NR		
power steering / servosterzo	OM906LA	205	279	09/04	>				S 3081 PO
Vehicles for building site with panel air filter / veicoli da cantiere con filtro aria a pannello	OM906LA	205	279	09/04	>			S 3373 A	
2629 Blue Tec 4+5/EEV	OM906LA	210	286	09/05	>	S 5036 PE	S 6017 NE	S 7383 A	
dryer filter / filtro essiccatore	OM906LA	210	286	09/05	>				S 7259 A
filter PARKER-RACOR / filtro PARKER-RACOR	OM906LA	210	286	09/05	>		S 4479 NR		
power steering / servosterzo	OM906LA	210	286	09/05	>				S 3081 PO
Vehicles for building site with panel air filter / veicoli da cantiere con filtro aria a pannello	OM906LA	210	286	09/05	>			S 3373 A	
2633	OM926LA	240	326	09/04	>	S 5036 PE	S 6017 NE	S 7383 A	
dryer filter / filtro essiccatore	OM926LA	240	326	09/04	>				S 7259 A
filter PARKER-RACOR / filtro PARKER-RACOR	OM926LA	240	326	09/04	>		S 4479 NR		





...MERCEDES BENZ - trucks/autocarri

M



power steering / servosterzo	OM926LA	240	326	09/04	>				S 3081 PO
Vehicles for building site with panel air filter / veicoli da cantiere con filtro aria a pannello	OM926LA	240	326	09/04	>			S 3373 A	
2633 Blue Tec 4+5/EEV	OM926LA	240	326	09/05	>	S 5036 PE	S 6017 NE	S 7383 A	
dryer filter / filtro essiccatore	OM926LA	240	326	09/05	>				S 7259 A
filter PARKER-RACOR / filtro PARKER-RACOR	OM926LA	240	326	09/05	>		S 4479 NR		
power steering / servosterzo	OM926LA	240	326	09/05	>				S 3081 PO
Vehicles for building site with panel air filter / veicoli da cantiere con filtro aria a pannello	OM926LA	240	326	09/05	>			S 3373 A	
2636 Blue Tec 4+5	OM457LA	265	360	09/05	>	S 5062 PE	S 6001 NE		S 3436 C
with activated carbons / ai carboni attivi	OM457LA	265	360	09/05	>				S 4345 CA
with manual pump prefilter / con pompa manuale prefiltra	OM457LA	265	360	09/05	>		S 6089 NE		
dryer filter / filtro essiccatore	OM457LA	265	360	09/05	>				S 7259 A
filter PARKER-RACOR / filtro PARKER-RACOR	OM457LA	265	360	09/05	>		S 4479 NR		
assembly KNECHT-MAHLE / montaggio KNECHT-MAHLE	OM457LA	265	360	09/05	>			S 7639 A	
assembly MANN-HUMMEL / montaggio MANN-HUMMEL	OM457LA	265	360	09/05	>			S 7A12 A	
prefilter PARKER-RACOR / prefiltra PARKER-RACOR	OM457LA	265	360	09/05	>		S 4121 NR		
power steering / servosterzo	OM457LA	265	360	09/05	>				S 3081 PO
Vehicles for building site with panel air filter / veicoli da cantiere con filtro aria a pannello	OM457LA	265	360	09/05	>			S 3373 A	
dusty areas / zone polverose	OM457LA	265	360	09/05	>				S 3438 C
2640	OM457LA	295	401	09/04	>	S 5062 PE	S 6001 NE		S 3436 C
with activated carbons / ai carboni attivi	OM457LA	295	401	09/04	>				S 4345 CA
with manual pump prefilter / con pompa manuale prefiltra	OM457LA	295	401	09/04	>		S 6089 NE		
dryer filter / filtro essiccatore	OM457LA	295	401	09/04	>				S 7259 A
filter PARKER-RACOR / filtro PARKER-RACOR	OM457LA	295	401	09/04	>		S 4479 NR		
assembly KNECHT-MAHLE / montaggio KNECHT-MAHLE	OM457LA	295	401	09/04	>			S 7639 A	
assembly MANN-HUMMEL / montaggio MANN-HUMMEL	OM457LA	295	401	09/04	>			S 7A12 A	
prefilter PARKER-RACOR / prefiltra PARKER-RACOR	OM457LA	295	401	09/04	>		S 4121 NR		
power steering / servosterzo	OM457LA	295	401	09/04	>				S 3081 PO
Vehicles for building site with panel air filter / veicoli da cantiere con filtro aria a pannello	OM457LA	295	401	09/04	>			S 3373 A	
dusty areas / zone polverose	OM457LA	295	401	09/04	>				S 3438 C
2640 Blue Tec 4+5	OM457LA	295	401	09/05	>	S 5062 PE	S 6001 NE		S 3436 C
with activated carbons / ai carboni attivi	OM457LA	295	401	09/05	>				S 4345 CA
with manual pump prefilter / con pompa manuale prefiltra	OM457LA	295	401	09/05	>		S 6089 NE		
dryer filter / filtro essiccatore	OM457LA	295	401	09/05	>				S 7259 A
filter PARKER-RACOR / filtro PARKER-RACOR	OM457LA	295	401	09/05	>		S 4479 NR		
assembly KNECHT-MAHLE / montaggio KNECHT-MAHLE	OM457LA	295	401	09/05	>			S 7639 A	
assembly MANN-HUMMEL / montaggio MANN-HUMMEL	OM457LA	295	401	09/05	>			S 7A12 A	
prefilter PARKER-RACOR / prefiltra PARKER-RACOR	OM457LA	295	401	09/05	>		S 4121 NR		
power steering / servosterzo	OM457LA	295	401	09/05	>				S 3081 PO
Vehicles for building site with panel air filter / veicoli da cantiere con filtro aria a pannello	OM457LA	295	401	09/05	>			S 3373 A	
dusty areas / zone polverose	OM457LA	295	401	09/05	>				S 3438 C
2643	OM457LA	315	428	09/04	>	S 5062 PE	S 6001 NE		S 3436 C
with activated carbons / ai carboni attivi	OM457LA	315	428	09/04	>				S 4345 CA
with manual pump prefilter / con pompa manuale prefiltra	OM457LA	315	428	09/04	>		S 6089 NE		
dryer filter / filtro essiccatore	OM457LA	315	428	09/04	>				S 7259 A
filter PARKER-RACOR / filtro PARKER-RACOR	OM457LA	315	428	09/04	>		S 4479 NR		
assembly KNECHT-MAHLE / montaggio KNECHT-MAHLE	OM457LA	315	428	09/04	>			S 7639 A	
assembly MANN-HUMMEL / montaggio MANN-HUMMEL	OM457LA	315	428	09/04	>			S 7A12 A	
prefilter PARKER-RACOR / prefiltra PARKER-RACOR	OM457LA	315	428	09/04	>		S 4121 NR		
power steering / servosterzo	OM457LA	315	428	09/04	>				S 3081 PO
Vehicles for building site with panel air filter / veicoli da cantiere con filtro aria a pannello	OM457LA	315	428	09/04	>			S 3373 A	
dusty areas / zone polverose	OM457LA	315	428	09/04	>				S 3438 C
2643 Blue Tec 4+5	OM457LA	295	401	09/05	>	S 5062 PE	S 6001 NE		S 3436 C
with activated carbons / ai carboni attivi	OM457LA	295	401	09/05	>				S 4345 CA
with manual pump prefilter / con pompa manuale prefiltra	OM457LA	295	401	09/05	>		S 6089 NE		
dryer filter / filtro essiccatore	OM457LA	295	401	09/05	>				S 7259 A
filter PARKER-RACOR / filtro PARKER-RACOR	OM457LA	295	401	09/05	>		S 4479 NR		
assembly KNECHT-MAHLE / montaggio KNECHT-MAHLE	OM457LA	295	401	09/05	>			S 7639 A	
assembly MANN-HUMMEL / montaggio MANN-HUMMEL	OM457LA	295	401	09/05	>			S 7A12 A	
prefilter PARKER-RACOR / prefiltra PARKER-RACOR	OM457LA	295	401	09/05	>		S 4121 NR		
power steering / servosterzo	OM457LA	295	401	09/05	>				S 3081 PO
Vehicles for building site with panel air filter / veicoli da cantiere con filtro aria a pannello	OM457LA	295	401	09/05	>			S 3373 A	
dusty areas / zone polverose	OM457LA	295	401	09/05	>				S 3438 C
3228	OM906LA	205	279	09/04	>	S 5036 PE	S 6017 NE	S 7383 A	
dryer filter / filtro essiccatore	OM906LA	205	279	09/04	>				S 7259 A
filter PARKER-RACOR / filtro PARKER-RACOR	OM906LA	205	279	09/04	>		S 4479 NR		
power steering / servosterzo	OM906LA	205	279	09/04	>				S 3081 PO
Vehicles for building site with panel air filter / veicoli da cantiere con filtro aria a pannello	OM906LA	205	279	09/04	>			S 3373 A	

**KW HP****...MERCEDES BENZ - trucks/autocarri**

3235	OM457LA	260	353	09/04	>	S 5062 PE	S 6001 NE		S 3436 C
with activated carbons / ai carboni attivi	OM457LA	260	353	09/04	>				S 4345 CA
with manual pump prefilter / con pompa manuale prefiltra	OM457LA	260	353	09/04	>		S 6089 NE		
dryer filter / filtro essiccatore	OM457LA	260	353	09/04	>				S 7259 A
filter PARKER-RACOR / filtro PARKER-RACOR	OM457LA	260	353	09/04	>		S 4479 NR		
assembly KNECHT-MAHLE / montaggio KNECHT-MAHLE	OM457LA	260	353	09/04	>			S 7639 A	
assembly MANN-HUMMEL / montaggio MANN-HUMMEL	OM457LA	260	353	09/04	>			S 7A12 A	
prefilter PARKER-RACOR / prefiltra PARKER-RACOR	OM457LA	260	353	09/04	>		S 4121 NR		
power steering / servosterzo	OM457LA	260	353	09/04	>				S 3081 PO
Vehicles for building site with panel air filter / veicoli da cantiere con filtro aria a pannello	OM457LA	260	353	09/04	>			S 3373 A	
dusty areas / zone polverose	OM457LA	260	353	09/04	>				S 3438 C
3236 Blue Tec 4+5	OM457LA	265	360	09/05	>	S 5062 PE	S 6001 NE		S 3436 C
with activated carbons / ai carboni attivi	OM457LA	265	360	09/05	>				S 4345 CA
with manual pump prefilter / con pompa manuale prefiltra	OM457LA	265	360	09/05	>		S 6089 NE		
dryer filter / filtro essiccatore	OM457LA	265	360	09/05	>				S 7259 A
filter PARKER-RACOR / filtro PARKER-RACOR	OM457LA	265	360	09/05	>		S 4479 NR		
assembly KNECHT-MAHLE / montaggio KNECHT-MAHLE	OM457LA	265	360	09/05	>			S 7639 A	
assembly MANN-HUMMEL / montaggio MANN-HUMMEL	OM457LA	265	360	09/05	>			S 7A12 A	
prefilter PARKER-RACOR / prefiltra PARKER-RACOR	OM457LA	265	360	09/05	>		S 4121 NR		
power steering / servosterzo	OM457LA	265	360	09/05	>				S 3081 PO
Vehicles for building site with panel air filter / veicoli da cantiere con filtro aria a pannello	OM457LA	265	360	09/05	>			S 3373 A	
dusty areas / zone polverose	OM457LA	265	360	09/05	>				S 3438 C
3240	OM457LA	295	401	09/04	>	S 5062 PE	S 6001 NE		S 3436 C
with activated carbons / ai carboni attivi	OM457LA	295	401	09/04	>				S 4345 CA
with manual pump prefilter / con pompa manuale prefiltra	OM457LA	295	401	09/04	>		S 6089 NE		
dryer filter / filtro essiccatore	OM457LA	295	401	09/04	>				S 7259 A
filter PARKER-RACOR / filtro PARKER-RACOR	OM457LA	295	401	09/04	>		S 4479 NR		
assembly KNECHT-MAHLE / montaggio KNECHT-MAHLE	OM457LA	295	401	09/04	>			S 7639 A	
assembly MANN-HUMMEL / montaggio MANN-HUMMEL	OM457LA	295	401	09/04	>			S 7A12 A	
prefilter PARKER-RACOR / prefiltra PARKER-RACOR	OM457LA	295	401	09/04	>		S 4121 NR		
power steering / servosterzo	OM457LA	295	401	09/04	>				S 3081 PO
Vehicles for building site with panel air filter / veicoli da cantiere con filtro aria a pannello	OM457LA	295	401	09/04	>			S 3373 A	
dusty areas / zone polverose	OM457LA	295	401	09/04	>				S 3438 C
3240 Blue Tec 4+5	OM457LA	295	401	09/05	>	S 5062 PE	S 6001 NE		S 3436 C
with activated carbons / ai carboni attivi	OM457LA	295	401	09/05	>				S 4345 CA
with manual pump prefilter / con pompa manuale prefiltra	OM457LA	295	401	09/05	>		S 6089 NE		
dryer filter / filtro essiccatore	OM457LA	295	401	09/05	>				S 7259 A
filter PARKER-RACOR / filtro PARKER-RACOR	OM457LA	295	401	09/05	>		S 4479 NR		
assembly KNECHT-MAHLE / montaggio KNECHT-MAHLE	OM457LA	295	401	09/05	>			S 7639 A	
assembly MANN-HUMMEL / montaggio MANN-HUMMEL	OM457LA	295	401	09/05	>			S 7A12 A	
prefilter PARKER-RACOR / prefiltra PARKER-RACOR	OM457LA	295	401	09/05	>		S 4121 NR		
power steering / servosterzo	OM457LA	295	401	09/05	>				S 3081 PO
Vehicles for building site with panel air filter / veicoli da cantiere con filtro aria a pannello	OM457LA	295	401	09/05	>			S 3373 A	
dusty areas / zone polverose	OM457LA	295	401	09/05	>				S 3438 C
3243	OM457LA	315	428	09/04	>	S 5062 PE	S 6001 NE		S 3436 C
with activated carbons / ai carboni attivi	OM457LA	315	428	09/04	>				S 4345 CA
with manual pump prefilter / con pompa manuale prefiltra	OM457LA	315	428	09/04	>		S 6089 NE		
dryer filter / filtro essiccatore	OM457LA	315	428	09/04	>				S 7259 A
filter PARKER-RACOR / filtro PARKER-RACOR	OM457LA	315	428	09/04	>		S 4479 NR		
assembly KNECHT-MAHLE / montaggio KNECHT-MAHLE	OM457LA	315	428	09/04	>			S 7639 A	
assembly MANN-HUMMEL / montaggio MANN-HUMMEL	OM457LA	315	428	09/04	>			S 7A12 A	
prefilter PARKER-RACOR / prefiltra PARKER-RACOR	OM457LA	315	428	09/04	>		S 4121 NR		
power steering / servosterzo	OM457LA	315	428	09/04	>				S 3081 PO
Vehicles for building site with panel air filter / veicoli da cantiere con filtro aria a pannello	OM457LA	315	428	09/04	>			S 3373 A	
dusty areas / zone polverose	OM457LA	315	428	09/04	>				S 3438 C
3243 Blue Tec 4+5	OM457LA	315	428	09/05	>	S 5062 PE	S 6001 NE		S 3436 C
with activated carbons / ai carboni attivi	OM457LA	315	428	09/05	>				S 4345 CA
with manual pump prefilter / con pompa manuale prefiltra	OM457LA	315	428	09/05	>		S 6089 NE		
dryer filter / filtro essiccatore	OM457LA	315	428	09/05	>				S 7259 A
filter PARKER-RACOR / filtro PARKER-RACOR	OM457LA	315	428	09/05	>		S 4479 NR		
assembly KNECHT-MAHLE / montaggio KNECHT-MAHLE	OM457LA	315	428	09/05	>			S 7639 A	
assembly MANN-HUMMEL / montaggio MANN-HUMMEL	OM457LA	315	428	09/05	>			S 7A12 A	
prefilter PARKER-RACOR / prefiltra PARKER-RACOR	OM457LA	315	428	09/05	>		S 4121 NR		
power steering / servosterzo	OM457LA	315	428	09/05	>				S 3081 PO
Vehicles for building site with panel air filter / veicoli da cantiere con filtro aria a pannello	OM457LA	315	428	09/05	>			S 3373 A	
dusty areas / zone polverose	OM457LA	315	428	09/05	>				S 3438 C
3335	OM457LA	260	353	09/04	>	S 5062 PE	S 6001 NE		S 3436 C

M

**KW HP****...MERCEDES BENZ - trucks/autocarri****M**

with activated carbons / ai carboni attivi	OM457LA	260	353	09/04	>			S 4345 CA
with manual pump prefilter / con pompa manuale prefiltra	OM457LA	260	353	09/04	>		S 6089 NE	
dryer filter / filtro essiccatore	OM457LA	260	353	09/04	>			S 7259 A
filter PARKER-RACOR / filtro PARKER-RACOR	OM457LA	260	353	09/04	>		S 4479 NR	
assembly KNECHT-MAHLE / montaggio KNECHT-MAHLE	OM457LA	260	353	09/04	>			S 7639 A
assembly MANN-HUMMEL / montaggio MANN-HUMMEL	OM457LA	260	353	09/04	>			S 7A12 A
prefilter PARKER-RACOR / prefiltra PARKER-RACOR	OM457LA	260	353	09/04	>		S 4121 NR	
power steering / servosterzo	OM457LA	260	353	09/04	>			S 3081 PO
Vehicles for building site with panel air filter / veicoli da cantiere con filtro aria a pannello	OM457LA	260	353	09/04	>			S 3373 A
dusty areas / zone polverose	OM457LA	260	353	09/04	>			S 3438 C
3340	OM457LA	295	401	09/04	>	S 5062 PE	S 6001 NE	S 3436 C
with activated carbons / ai carboni attivi	OM457LA	295	401	09/04	>			S 4345 CA
with manual pump prefilter / con pompa manuale prefiltra	OM457LA	295	401	09/04	>		S 6089 NE	
dryer filter / filtro essiccatore	OM457LA	295	401	09/04	>			S 7259 A
filter PARKER-RACOR / filtro PARKER-RACOR	OM457LA	295	401	09/04	>		S 4479 NR	
assembly KNECHT-MAHLE / montaggio KNECHT-MAHLE	OM457LA	295	401	09/04	>			S 7639 A
assembly MANN-HUMMEL / montaggio MANN-HUMMEL	OM457LA	295	401	09/04	>			S 7A12 A
prefilter PARKER-RACOR / prefiltra PARKER-RACOR	OM457LA	295	401	09/04	>		S 4121 NR	
power steering / servosterzo	OM457LA	295	401	09/04	>			S 3081 PO
Vehicles for building site with panel air filter / veicoli da cantiere con filtro aria a pannello	OM457LA	295	401	09/04	>			S 3373 A
dusty areas / zone polverose	OM457LA	295	401	09/04	>			S 3438 C
3343	OM457LA	315	428	09/04	>	S 5062 PE	S 6001 NE	S 3436 C
with activated carbons / ai carboni attivi	OM457LA	315	428	09/04	>			S 4345 CA
with manual pump prefilter / con pompa manuale prefiltra	OM457LA	315	428	09/04	>		S 6089 NE	
dryer filter / filtro essiccatore	OM457LA	315	428	09/04	>			S 7259 A
filter PARKER-RACOR / filtro PARKER-RACOR	OM457LA	315	428	09/04	>		S 4479 NR	
assembly KNECHT-MAHLE / montaggio KNECHT-MAHLE	OM457LA	315	428	09/04	>			S 7639 A
assembly MANN-HUMMEL / montaggio MANN-HUMMEL	OM457LA	315	428	09/04	>			S 7A12 A
prefilter PARKER-RACOR / prefiltra PARKER-RACOR	OM457LA	315	428	09/04	>		S 4121 NR	
power steering / servosterzo	OM457LA	315	428	09/04	>			S 3081 PO
Vehicles for building site with panel air filter / veicoli da cantiere con filtro aria a pannello	OM457LA	315	428	09/04	>			S 3373 A
dusty areas / zone polverose	OM457LA	315	428	09/04	>			S 3438 C
4135	OM457LA	260	353	06/09	>	S 5062 PE	S 6001 NE	S 3436 C
with activated carbons / ai carboni attivi	OM457LA	260	353	06/09	>			S 4345 CA
with manual pump prefilter / con pompa manuale prefiltra	OM457LA	260	353	06/09	>		S 6089 NE	
dryer filter / filtro essiccatore	OM457LA	260	353	06/09	>			S 7259 A
filter PARKER-RACOR / filtro PARKER-RACOR	OM457LA	260	353	06/09	>		S 4479 NR	
assembly KNECHT-MAHLE / montaggio KNECHT-MAHLE	OM457LA	260	353	06/09	>			S 7639 A
assembly MANN-HUMMEL / montaggio MANN-HUMMEL	OM457LA	260	353	06/09	>			S 7A12 A
prefilter PARKER-RACOR / prefiltra PARKER-RACOR	OM457LA	260	353	06/09	>		S 4121 NR	
power steering / servosterzo	OM457LA	260	353	06/09	>			S 3081 PO
Vehicles for building site with panel air filter / veicoli da cantiere con filtro aria a pannello	OM457LA	260	353	06/09	>			S 3373 A
dusty areas / zone polverose	OM457LA	260	353	06/09	>			S 3438 C
4140	OM457LA	295	401	09/04	>	S 5062 PE	S 6001 NE	S 3436 C
with activated carbons / ai carboni attivi	OM457LA	295	401	09/04	>			S 4345 CA
with manual pump prefilter / con pompa manuale prefiltra	OM457LA	295	401	09/04	>		S 6089 NE	
dryer filter / filtro essiccatore	OM457LA	295	401	09/04	>			S 7259 A
filter PARKER-RACOR / filtro PARKER-RACOR	OM457LA	295	401	09/04	>		S 4479 NR	
assembly KNECHT-MAHLE / montaggio KNECHT-MAHLE	OM457LA	295	401	09/04	>			S 7639 A
assembly MANN-HUMMEL / montaggio MANN-HUMMEL	OM457LA	295	401	09/04	>			S 7A12 A
prefilter PARKER-RACOR / prefiltra PARKER-RACOR	OM457LA	295	401	09/04	>		S 4121 NR	
power steering / servosterzo	OM457LA	295	401	09/04	>			S 3081 PO
Vehicles for building site with panel air filter / veicoli da cantiere con filtro aria a pannello	OM457LA	295	401	09/04	>			S 3373 A
dusty areas / zone polverose	OM457LA	295	401	09/04	>			S 3438 C
4143	OM457LA	315	428	09/04	>	S 5062 PE	S 6001 NE	S 3436 C
with activated carbons / ai carboni attivi	OM457LA	315	428	09/04	>			S 4345 CA
with manual pump prefilter / con pompa manuale prefiltra	OM457LA	315	428	09/04	>		S 6089 NE	
dryer filter / filtro essiccatore	OM457LA	315	428	09/04	>			S 7259 A
filter PARKER-RACOR / filtro PARKER-RACOR	OM457LA	315	428	09/04	>		S 4479 NR	
assembly KNECHT-MAHLE / montaggio KNECHT-MAHLE	OM457LA	315	428	09/04	>			S 7639 A
assembly MANN-HUMMEL / montaggio MANN-HUMMEL	OM457LA	315	428	09/04	>			S 7A12 A
prefilter PARKER-RACOR / prefiltra PARKER-RACOR	OM457LA	315	428	09/04	>		S 4121 NR	
power steering / servosterzo	OM457LA	315	428	09/04	>			S 3081 PO
Vehicles for building site with panel air filter / veicoli da cantiere con filtro aria a pannello	OM457LA	315	428	09/04	>			S 3373 A
dusty areas / zone polverose	OM457LA	315	428	09/04	>			S 3438 C
4144 Blue Tec 4+5	OM457LA(OM457.937)	315	428	01/11	>	S 5062 PE	S 6001 NE	S 3436 C
with activated carbons / ai carboni attivi	OM457LA(OM457.937)	315	428	01/11	>			S 4345 CA

**kW HP****...MERCEDES BENZ - trucks/autocarri**

with manual pump prefilter / con pompa manuale prefiltra	OM457LA (OM457.937)	315	428	01/11	>		S 6089 NE		S 7A66 A
dryer filter / filtro essiccatore	OM457LA (OM457.937)	315	428	01/11	>				
filter PARKER-RACOR / filtro PARKER-RACOR	OM457LA (OM457.937)	315	428	01/11	>		S 4479 NR	S 7639 A	
assembly KNECHT-MAHLE / montaggio KNECHT-MAHLE	OM457LA (OM457.937)	315	428	01/11	>			S 7A12 A	
assembly MANN-HUMMEL / montaggio MANN-HUMMEL	OM457LA (OM457.937)	315	428	01/11	>				
prefilter PARKER-RACOR / prefiltra PARKER-RACOR	OM457LA (OM457.937)	315	428	01/11	>		S 4121 NR		
power steering / servosterzo	OM457LA (OM457.937)	315	428	01/11	>				S 3081 PO
Vehicles for building site with panel air filter / veicoli da cantiere con filtro aria a pannello	OM457LA (OM457.937)	315	428	01/11	>			S 3373 A	
dusty areas / zone polverose	OM457LA (OM457.937)	315	428	01/11	>				S 3438 C
Econic (957)									
1823									
dryer filter / filtro essiccatore	OM906LA	170	231	07/98	>				S 7259 A
assembly DONALDSON / montaggio DONALDSON	OM906LA	170	231	07/98	>	S 5036 PE	S 6017 NE		
assembly MANN+HUMMEL / montaggio MANN+HUMMEL	OM906LA	170	231	07/98	>	S 5036 PE	S 6017 NE	S 7383 A	
power steering / servosterzo	OM906LA	170	231	07/98	>				S 3081 PO
1824									
assembly DONALDSON / montaggio DONALDSON	OM906LA Euro4	175	238	09/06	>	S 5036 PE	S 6017 NE		
power steering / servosterzo	OM906LA Euro4	175	238	09/06	>				S 3081 PO
1828									
dryer filter / filtro essiccatore	OM906LA	205	279	07/98	>				S 7259 A
assembly DONALDSON / montaggio DONALDSON	OM906LA	205	279	07/98	>	S 5036 PE	S 6017 NE		
assembly MANN+HUMMEL / montaggio MANN+HUMMEL	OM906LA	205	279	07/98	>	S 5036 PE	S 6017 NE	S 7383 A	
power steering / servosterzo	OM906LA	205	279	07/98	>				S 3081 PO
1828 NTG									
dryer filter / filtro essiccatore	M906LAG	205	279	09/02	>				S 7259 A
assembly DONALDSON / montaggio DONALDSON	M906LAG	205	279	09/02	>	S 5036 PE			
assembly MANN+HUMMEL / montaggio MANN+HUMMEL	M906LAG	205	279	09/02	>	S 5036 PE		S 7383 A	
power steering / servosterzo	M906LAG	205	279	09/02	>				S 3081 PO
1829									
assembly DONALDSON / montaggio DONALDSON	OM906LA Euro4	210	286	09/06	>	S 5036 PE	S 6017 NE		
power steering / servosterzo	OM906LA Euro4	210	286	09/06	>				S 3081 PO
1833									
dryer filter / filtro essiccatore	OM926LA	240	326	05/04	>				S 7259 A
assembly DONALDSON / montaggio DONALDSON	OM926LA	240	326	05/04	>	S 5036 PE	S 6017 NE		
assembly MANN+HUMMEL / montaggio MANN+HUMMEL	OM926LA	240	326	05/04	>	S 5036 PE	S 6017 NE	S 7383 A	
power steering / servosterzo	OM926LA	240	326	05/04	>				S 3081 PO
2628									
dryer filter / filtro essiccatore	OM906LA	205	279	07/98	>				S 7259 A
assembly DONALDSON / montaggio DONALDSON	OM906LA	205	279	07/98	>	S 5036 PE	S 6017 NE		
assembly MANN+HUMMEL / montaggio MANN+HUMMEL	OM906LA	205	279	07/98	>	S 5036 PE	S 6017 NE	S 7383 A	
power steering / servosterzo	OM906LA	205	279	07/98	>				S 3081 PO
2628 NTG									
dryer filter / filtro essiccatore	M906LAG	205	279	09/02	>				S 7259 A
assembly DONALDSON / montaggio DONALDSON	M906LAG	205	279	09/02	>	S 5036 PE			
assembly MANN+HUMMEL / montaggio MANN+HUMMEL	M906LAG	205	279	09/02	>	S 5036 PE		S 7383 A	
power steering / servosterzo	M906LAG	205	279	09/02	>				S 3081 PO
2629									
assembly DONALDSON / montaggio DONALDSON	OM906LA Euro4	210	286	09/06	>	S 5036 PE	S 6017 NE		
power steering / servosterzo	OM906LA Euro4	210	286	09/06	>				S 3081 PO
2633									
dryer filter / filtro essiccatore	OM926LA	240	326	05/04	>				S 7259 A
assembly DONALDSON / montaggio DONALDSON	OM926LA	240	326	05/04	>	S 5036 PE	S 6017 NE		
assembly MANN+HUMMEL / montaggio MANN+HUMMEL	OM926LA	240	326	05/04	>	S 5036 PE	S 6017 NE	S 7383 A	
power steering / servosterzo	OM926LA	240	326	05/04	>				S 3081 PO
3233									
dryer filter / filtro essiccatore	OM926LA	240	326	05/05	>				S 7259 A
assembly DONALDSON / montaggio DONALDSON	OM926LA	240	326	05/05	>	S 5036 PE	S 6017 NE		
assembly MANN+HUMMEL / montaggio MANN+HUMMEL	OM926LA	240	326	05/05	>	S 5036 PE	S 6017 NE	S 7383 A	
power steering / servosterzo	OM926LA	240	326	05/05	>				S 3081 PO
LP/LPS 300 Serie									
321									
some / alcuni							S 2162 N	S 7813 A	
power steering / servosterzo							S 2162 N		S 8790 PO
322									
some / alcuni							S 2162 N	S 7813 A	
power steering / servosterzo							S 2162 N		S 8790 PO
323									
							S 2162 N		

M



kW HP



...MERCEDES BENZ - trucks/autocarri

M



some / alcuni power steering / servosterzo						S 2162 N	S 7813 A	S 8790 PO	
326						S 2162 N			
some / alcuni power steering / servosterzo						S 2162 N	S 7813 A	S 8790 PO	
329						S 2162 N			
some / alcuni power steering / servosterzo						S 2162 N	S 7813 A	S 8790 PO	
331						S 2162 N			
some / alcuni power steering / servosterzo						S 2162 N	S 7813 A	S 8790 PO	
332						S 2162 N			
some / alcuni power steering / servosterzo						S 2162 N	S 7813 A	S 8790 PO	
333						S 2162 N			
some / alcuni power steering / servosterzo						S 2162 N	S 7813 A	S 8790 PO	
Sprinter (905)									
616 CDI	OM612 DE27LA	115	156	01/01 >	06/06	S 5013 PE	S 4416 NR	S 3080 A	S 3059 C
with activated carbon air-conditioner / con climatizzatore, ai carboni attivi	OM612 DE27LA	115	156	01/01 >	06/06				S 4281 CA
with water presence sensor / con sensore presenza acqua	OM612 DE27LA	115	156	01/01 >	12/03	S 5013 PE	S 4006 NR	S 3080 A	S 3059 C
with water presence sensor / con sensore presenza acqua	OM612 DE27LA	115	156	01/04 >	06/06	S 5013 PE	S 4107 NR	S 3080 A	S 3059 C
dusty areas / zone polverose	OM612 DE27LA	115	156	01/01 >	06/06	S 5013 PE	S 4416 NR	S 3082 A	S 3059 C
Vario									
512 D	OM602DA29LA	85	115	10/96 >		S 5095 PE	S 9600 NR	S 3059 A	
power steering / servosterzo	OM602DA29LA	85	115	10/96 >					S 3081 PO
612 D	OM602DE29LA	85	115	10/96 >		S 5095 PE	S 9600 NR	S 3059 A	
power steering / servosterzo	OM602DE29LA	85	115	10/96 >					S 3081 PO
613 D Blue Tec	OM904LA Euro4	95	129	03/06 >		S 5007 PE	S 6017 NE	S 3059 A	
dryer filter / filtro essiccatore	OM904LA Euro4	95	129	03/06 >					S 7259 A
power steering / servosterzo	OM904LA Euro4	95	129	03/06 >					S 3081 PO
614 D	OM904LA	100	136	10/96 >		S 5007 PE	S 6017 NE	S 3059 A	
power steering / servosterzo	OM904LA	100	136	10/96 >					S 3081 PO
615 D	OM904LA	110	150	10/96 >		S 5007 PE	S 6017 NE	S 3059 A	
power steering / servosterzo	OM904LA	110	150	10/96 >					S 3081 PO
616 D Blue Tec	OM904LA Euro4	115	156	03/06 >		S 5007 PE	S 6017 NE	S 3059 A	
dryer filter / filtro essiccatore	OM904LA Euro4	115	156	03/06 >					S 7259 A
power steering / servosterzo	OM904LA Euro4	115	156	03/06 >					S 3081 PO
618 D	OM904LA	130	177	11/02 >		S 5007 PE	S 6017 NE	S 3059 A	
dryer filter / filtro essiccatore	OM904LA	130	177	11/02 >					S 7259 A
power steering / servosterzo	OM904LA	130	177	11/02 >					S 3081 PO
618 D Blue Tec	OM904LA Euro4	130	177	03/06 >		S 5007 PE	S 6017 NE	S 3059 A	
dryer filter / filtro essiccatore	OM904LA Euro4	130	177	03/06 >					S 7259 A
power steering / servosterzo	OM904LA Euro4	130	177	03/06 >					S 3081 PO
714 D	OM904LA	100	136	10/96 >		S 5007 PE	S 6017 NE	S 3059 A	
power steering / servosterzo	OM904LA	100	136	10/96 >					S 3081 PO
812 D	OM602DE29LA	85	115	10/96 >		S 5095 PE	S 9600 NR	S 3059 A	
dryer filter / filtro essiccatore	OM602DE29LA	85	115	10/96 >					S 7259 A
power steering / servosterzo	OM602DE29LA	85	115	10/96 >					S 3081 PO
813 D Blue Tec	OM904LA Euro4	95	129	03/06 >		S 5007 PE	S 6017 NE	S 3059 A	
dryer filter / filtro essiccatore	OM904LA Euro4	95	129	03/06 >					S 7259 A
power steering / servosterzo	OM904LA Euro4	95	129	03/06 >					S 3081 PO
813 DA Blue Tec	OM904LA Euro4	95	129	03/06 >		S 5007 PE	S 6017 NE	S 3059 A	
dryer filter / filtro essiccatore	OM904LA Euro4	95	129	03/06 >					S 7259 A
power steering / servosterzo	OM904LA Euro4	95	129	03/06 >					S 3081 PO
814 D	OM904LA	100	136	10/96 >		S 5007 PE	S 6017 NE	S 3059 A	
dryer filter / filtro essiccatore	OM904LA	100	136	10/96 >					S 7259 A
power steering / servosterzo	OM904LA	100	136	10/96 >					S 3081 PO
814 DA	OM904LA	100	136	10/96 >		S 5007 PE	S 6017 NE	S 3059 A	
dryer filter / filtro essiccatore	OM904LA	100	136	10/96 >					S 7259 A
power steering / servosterzo	OM904LA	100	136	10/96 >					S 3081 PO
815 D	OM904LA	110	150	10/96 >		S 5007 PE	S 6017 NE	S 3059 A	
dryer filter / filtro essiccatore	OM904LA	110	150	10/96 >					S 7259 A
power steering / servosterzo	OM904LA	110	150	10/96 >					S 3081 PO
815 DA	OM904LA	110	150	10/96 >		S 5007 PE	S 6017 NE	S 3059 A	
dryer filter / filtro essiccatore	OM904LA	110	150	10/96 >					S 7259 A
power steering / servosterzo	OM904LA	110	150	10/96 >					S 3081 PO

**KW HP****...MERCEDES BENZ - trucks/autocarri**

816 D Blue Tec	OM904LA Euro4	115	156	03/06 >	S 5007 PE	S 6017 NE	S 3059 A	S 7259 A
dryer filter / filtro essiccatore	OM904LA Euro4	115	156	03/06 >				S 3081 PO
power steering / servosterzo	OM904LA Euro4	115	156	03/06 >				
816 DA Blue Tec	OM904LA Euro4	115	156	03/06 >	S 5007 PE	S 6017 NE	S 3059 A	S 7259 A
dryer filter / filtro essiccatore	OM904LA Euro4	115	156	03/06 >				S 3081 PO
power steering / servosterzo	OM904LA Euro4	115	156	03/06 >				
818 D	OM904LA	130	177	11/02 >	S 5007 PE	S 6017 NE	S 3059 A	S 7259 A
dryer filter / filtro essiccatore	OM904LA	130	177	11/02 >				S 3081 PO
power steering / servosterzo	OM904LA	130	177	11/02 >				
818 D Blue Tec	OM904LA Euro4	130	177	03/06 >	S 5007 PE	S 6017 NE	S 3059 A	S 7259 A
dryer filter / filtro essiccatore	OM904LA Euro4	130	177	03/06 >				S 3081 PO
power steering / servosterzo	OM904LA Euro4	130	177	03/06 >				
818 DA Blue Tec	OM904LA Euro4	130	177	03/06 >	S 5007 PE	S 6017 NE	S 3059 A	S 7259 A
dryer filter / filtro essiccatore	OM904LA Euro4	130	177	03/06 >				S 3081 PO
power steering / servosterzo	OM904LA Euro4	130	177	03/06 >				

Zetros

1833A 4x4	OM926LA	240	326	05/09 >	S 5036 PE	S 6017 NE	S 7546 A	S 3221 C
with activated carbons / ai carboni attivi	OM926LA	240	326	05/09 >				S 4225 CA
dryer filter / filtro essiccatore	OM926LA	240	326	05/09 >				S 7259 A
inner / interno	OM926LA	240	326	05/09 >			S 1307 A	
power steering / servosterzo	OM926LA	240	326	05/09 >				S 3081 PO
2733A 6x6	OM926LA	240	326	05/09 >	S 5036 PE	S 6017 NE	S 7546 A	S 3221 C
with activated carbons / ai carboni attivi	OM926LA	240	326	05/09 >				S 4225 CA
dryer filter / filtro essiccatore	OM926LA	240	326	05/09 >				S 7259 A
inner / interno	OM926LA	240	326	05/09 >			S 1307 A	
power steering / servosterzo	OM926LA	240	326	05/09 >				S 3081 PO

MERCEDES BENZ**buses/autobus**

311								
311						S 2162 N	S 7813 A	
312						S 2162 N	S 7813 A	
312						S 2162 N	S 7813 A	
Citaro								
O 530	OM457HLA	185	252	10/98 >				S 3440 C
with air-conditioner / con climatizzatore	OM457HLA	185	252	10/98 >				S 3443 C
spheros aeroshere world / con climatizzatore sul tetto	OM457HLA	185	252	10/98 >				S 3451 C
with air-conditioner WEBASTO Aerosphere / con climatizzatore WEBASTO Aerosphere	OM457HLA	185	252	10/98 > 05/01		S 6001 NE	S 7387 A	S 3081 C
with air-conditioner WEBASTO Aerosphere / con climatizzatore WEBASTO Aerosphere	OM457HLA	185	252	06/01 >		S 6001 NE		S 3081 C
with manual pump prefilter / con pompa manuale prefiltra	OM457HLA	185	252	10/98 >		S 6089 NE		
dryer filter / filtro essiccatore	OM457HLA	185	252	10/98 >				S 7259 A
2 filters / N.2 filtri	OM457HLA	185	252	10/98 >	S 5036 PE			
prefilter RACOR / prefiltra RACOR	OM457HLA	185	252	10/98 >		S 4479 NR		
power steering / servosterzo	OM457HLA	185	252	10/98 >				S 3081 PO
O 530	OM457HLA	220	300	10/98 >				S 3440 C
with air-conditioner / con climatizzatore	OM457HLA	220	300	10/98 >				S 3443 C
spheros aeroshere world / con climatizzatore sul tetto	OM457HLA	220	300	10/98 >				S 3451 C
with air-conditioner WEBASTO Aerosphere / con climatizzatore WEBASTO Aerosphere	OM457HLA	220	300	10/98 > 05/01		S 6001 NE	S 7387 A	S 3081 C
with air-conditioner WEBASTO Aerosphere / con climatizzatore WEBASTO Aerosphere	OM457HLA	220	300	06/01 >		S 6001 NE		S 3081 C
with manual pump prefilter / con pompa manuale prefiltra	OM457HLA	220	300	10/98 >		S 6089 NE		
dryer filter / filtro essiccatore	OM457HLA	220	300	10/98 >				S 7259 A
2 filters / N.2 filtri	OM457HLA	220	300	10/98 >	S 5036 PE			
prefilter RACOR / prefiltra RACOR	OM457HLA	220	300	10/98 >		S 4479 NR		
power steering / servosterzo	OM457HLA	220	300	10/98 >				S 3081 PO
O 530	OM457HLA	260	354	10/98 >				S 3440 C
with air-conditioner / con climatizzatore	OM457HLA	260	354	10/98 >				S 3443 C
with air-conditioner WEBASTO Aerosphere / con climatizzatore WEBASTO Aerosphere	OM457HLA	260	354	10/98 > 05/01		S 6001 NE	S 7387 A	S 3081 C
with air-conditioner WEBASTO Aerosphere / con climatizzatore WEBASTO Aerosphere	OM457HLA	260	354	06/01 >		S 6001 NE		S 3081 C
with manual pump prefilter / con pompa manuale prefiltra	OM457HLA	260	354	10/98 >		S 6089 NE		
dryer filter / filtro essiccatore	OM457HLA	260	354	10/98 >				S 7259 A
2 filters / N.2 filtri	OM457HLA	260	354	10/98 >	S 5036 PE			
prefilter RACOR / prefiltra RACOR	OM457HLA	260	354	10/98 >		S 4479 NR		
power steering / servosterzo	OM457HLA	260	354	10/98 >				S 3081 PO
O 530	OM457HLA Euro3	220	300	09/04 >				S 3443 C
with air-conditioner / con climatizzatore	OM457HLA Euro3	220	300	09/04 >				S 3451 C
spheros aeroshere world / con climatizzatore sul tetto	OM457HLA Euro3	220	300	09/04 >				S 3081 C
with air-conditioner WEBASTO Aerosphere / con climatizzatore WEBASTO Aerosphere	OM457HLA Euro3	220	300	09/04 >		S 6001 NE		
with manual pump prefilter / con pompa manuale prefiltra	OM457HLA Euro3	220	300	09/04 >		S 6089 NE		



kW HP



...MERCEDES BENZ - buses/autobus

M



dryer filter / filtro essiccatore	OM457HLA Euro3	220	300	09/04	>				S 7259 A
2 filters / N.2 filtri	OM457HLA Euro3	220	300	09/04	>	S 5036 PE			
power steering / servosterzo	OM457HLA Euro3	220	300	09/04	>				S 3081 PO
O 530	OM457HLA Euro4	220	300	09/06	>				S 3440 C
spheros aeroshere world / con climatizzatore sul tetto	OM457HLA Euro4	220	300	09/06	>				S 3451 C
with air-conditioner WEBASTO Aerosphere / con climatizzatore WEBASTO Aerosphere	OM457HLA Euro4	220	300	09/06	>		S 6001 NE		S 3081 C
with manual pump prefilter / con pompa manuale prefiltra	OM457HLA Euro4	220	300	09/06	>		S 6089 NE		
dryer filter / filtro essiccatore	OM457HLA Euro4	220	300	09/06	>				S 7259 A
2 filters / N.2 filtri	OM457HLA Euro4	220	300	09/06	>	S 5036 PE			
power steering / servosterzo	OM457HLA Euro4	220	300	09/06	>				S 3081 PO
O 530	OM457HLA Euro4	260	353	09/06	>				S 3440 C
spheros aeroshere world / con climatizzatore sul tetto	OM457HLA Euro4	260	353	09/06	>				S 3451 C
with air-conditioner WEBASTO Aerosphere / con climatizzatore WEBASTO Aerosphere	OM457HLA Euro4	260	353	09/06	>		S 6001 NE		S 3081 C
with manual pump prefilter / con pompa manuale prefiltra	OM457HLA Euro4	260	353	09/06	>		S 6089 NE		
dryer filter / filtro essiccatore	OM457HLA Euro4	260	353	09/06	>				S 7259 A
2 filters / N.2 filtri	OM457HLA Euro4	260	353	09/06	>	S 5036 PE			
power steering / servosterzo	OM457HLA Euro4	260	353	09/06	>				S 3081 PO
O 530	OM906LA/HLA	170	231	03/98	>				S 3440 C
with air-conditioner / con climatizzatore	OM906LA/HLA	170	231	03/98	>				S 3443 C
spheros aeroshere world / con climatizzatore sul tetto	OM906LA/HLA	170	231	03/98	>				S 3451 C
with air-conditioner WEBASTO Aerosphere / con climatizzatore WEBASTO Aerosphere	OM906LA/HLA	170	231	03/98	>	05/01	S 5036 PE	S 6017 NE	S 7387 A
with air-conditioner WEBASTO Aerosphere / con climatizzatore WEBASTO Aerosphere	OM906LA/HLA	170	231	06/01	>		S 5036 PE	S 6017 NE	
dryer filter / filtro essiccatore	OM906LA/HLA	170	231	03/98	>				S 7259 A
power steering / servosterzo	OM906LA/HLA	170	231	03/98	>				S 3081 PO
O 530	OM906LA/HLA	205	279	03/98	>				S 3439 C
with air-conditioner / con climatizzatore	OM906LA/HLA	205	279	03/98	>				S 3443 C
spheros aeroshere world / con climatizzatore sul tetto	OM906LA/HLA	205	279	03/98	>				S 3451 C
with air-conditioner WEBASTO Aerosphere / con climatizzatore WEBASTO Aerosphere	OM906LA/HLA	205	279	03/98	>	05/01	S 5036 PE	S 6017 NE	S 7387 A
with air-conditioner WEBASTO Aerosphere / con climatizzatore WEBASTO Aerosphere	OM906LA/HLA	205	279	06/01	>		S 5036 PE	S 6017 NE	
dryer filter / filtro essiccatore	OM906LA/HLA	205	279	03/98	>				S 7259 A
power steering / servosterzo	OM906LA/HLA	205	279	03/98	>				S 3081 PO
O 530	OM906LA/HLA Euro3	205	279	09/04	>				S 3440 C
with air-conditioner / con climatizzatore	OM906LA/HLA Euro3	205	279	09/04	>				S 3443 C
spheros aeroshere world / con climatizzatore sul tetto	OM906LA/HLA Euro3	205	279	09/04	>				S 3451 C
with air-conditioner WEBASTO Aerosphere / con climatizzatore WEBASTO Aerosphere	OM906LA/HLA Euro3	205	279	09/04	>		S 5036 PE	S 6017 NE	S 3081 C
dryer filter / filtro essiccatore	OM906LA/HLA Euro3	205	279	09/04	>				S 7259 A
power steering / servosterzo	OM906LA/HLA Euro3	205	279	09/04	>				S 3081 PO

Citaro K

10.5 m									
with air-conditioner WEBASTO Aerosphere / con climatizzatore WEBASTO Aerosphere	OM457HLA Euro4	220	299	09/06	>			S 6001 NE	S 7573 A
with manual pump prefilter / con pompa manuale prefiltra	OM457HLA Euro4	220	299	09/06	>			S 6089 NE	
2 filters / N.2 filtri	OM457HLA Euro4	220	299	09/06	>	S 5036 PE			
power steering / servosterzo	OM457HLA Euro4	220	299	09/06	>				S 3081 PO
10.5 m									
with air-conditioner WEBASTO Aerosphere / con climatizzatore WEBASTO Aerosphere	OM457HLA Euro4	260	353	09/06	>			S 6001 NE	S 7573 A
with manual pump prefilter / con pompa manuale prefiltra	OM457HLA Euro4	260	353	09/06	>			S 6089 NE	
2 filters / N.2 filtri	OM457HLA Euro4	260	353	09/06	>	S 5036 PE			
power steering / servosterzo	OM457HLA Euro4	260	353	09/06	>				S 3081 PO
10.5 m									
spheros aeroshere world / con climatizzatore sul tetto	OM906hLA Euro4/5	210	286	09/06	>				S 3451 C
spheros aeroshere world REVO / con climatizzatore sul tetto REVO	OM906hLA Euro4/5	210	286	09/06	>				S 3457 C
with air-conditioner WEBASTO Aerosphere / con climatizzatore WEBASTO Aerosphere	OM906hLA Euro4/5	210	286	09/06	>		S 5036 PE	S 6017 NE	S 7573 A
power steering / servosterzo	OM906hLA Euro4/5	210	286	09/06	>				S 3081 PO

Citaro LE

MUE									
spheros aeroshere world SPHEROS / con climatizzatore sul tetto SPHEROS	OM457HLA	220	299	11/05	>				S 3457 C
with air-conditioner WEBASTO Aerosphere / con climatizzatore WEBASTO Aerosphere	OM457HLA	220	299	11/05	>			S 6001 NE	S 7573 A
with manual pump prefilter / con pompa manuale prefiltra	OM457HLA	220	299	11/05	>			S 6089 NE	
2 filters / N.2 filtri	OM457HLA	220	299	11/05	>	S 5036 PE			
power steering / servosterzo	OM457HLA	220	299	11/05	>				S 3081 PO
MUE									
spheros aeroshere world SPHEROS / con climatizzatore sul tetto SPHEROS	OM457HLA	260	353	11/05	>				S 3457 C
with air-conditioner WEBASTO Aerosphere / con climatizzatore WEBASTO Aerosphere	OM457HLA	260	353	11/05	>			S 6001 NE	S 7573 A
with manual pump prefilter / con pompa manuale prefiltra	OM457HLA	260	353	11/05	>			S 6089 NE	
2 filters / N.2 filtri	OM457HLA	260	353	11/05	>	S 5036 PE			
power steering / servosterzo	OM457HLA	260	353	11/05	>				S 3081 PO
UE									



kW HP



...MERCEDES BENZ - buses/autobus

spheros aeroshere world / con climatizzatore sul tetto	OM457HLA	220	299	11/05	>			S 3457 C
with air-conditioner WEBASTO Aerosphere / con climatizzatore WEBASTO Aerosphere	OM457HLA	220	299	11/05	>		S 6001 NE	S 3081 C
with manual pump prefilter / con pompa manuale prefiltra	OM457HLA	220	299	11/05	>		S 6089 NE	
2 filters / N.2 filtri	OM457HLA	220	299	11/05	>	S 5036 PE		
power steering / servosterzo	OM457HLA	220	299	11/05	>			S 3081 PO
UE								
spheros aeroshere world / con climatizzatore sul tetto	OM457HLA	260	353	11/05	>			S 3457 C
with air-conditioner WEBASTO Aerosphere / con climatizzatore WEBASTO Aerosphere	OM457HLA	260	353	11/05	>	S 5036 PE	S 6001 NE	S 3081 C
2 filters / N.2 filtri	OM457HLA	260	353	11/05	>	S 5036 PE		
power steering / servosterzo	OM457HLA	260	353	11/05	>			S 3081 PO
Cito								
O 520	OM904LA	125	170	07/98	>	S 5007 PE	S 6017 NE	S 3440 C
dryer filter / filtro essiccatore	OM904LA	125	170	07/98	>			S 7259 A
power steering / servosterzo	OM904LA	125	170	07/98	>			S 3081 PO
O 520	OM904LA Euro 3	130	177	09/02	>	S 5007 PE	S 6017 NE	S 3440 C
some / alcuni	OM904LA Euro 3	130	177	09/02	>		S 7506 A	
dryer filter / filtro essiccatore	OM904LA Euro 3	130	177	09/02	>			S 7259 A
power steering / servosterzo	OM904LA Euro 3	130	177	09/02	>			S 3081 PO
Conecto								
Conecto C	OM447HLA Euro 2	185	252	01/98	>	S 7261 PO		S 0450 A
with automatic gearbox ZF HP500/590 / con cambio automatico ZF HP500/590	OM447HLA Euro 2	185	252	01/98	>			S 2234 Z
dryer filter / filtro essiccatore	OM447HLA Euro 2	185	252	01/98	>			S 7259 A
2 filters / N.2 filtri	OM447HLA Euro 2	185	252	01/98	>		S 2162 N	
prefilter PARKER-RACOR R90D / prefiltra PARKER-RACOR R90D	OM447HLA Euro 2	185	252	01/98	>		S 4472 NR	
prefilter PARKER-RACOR R90P / prefiltra PARKER-RACOR R90P	OM447HLA Euro 2	185	252	01/98	>		S 4143 NR	
power steering / servosterzo	OM447HLA Euro 2	185	252	01/98	>			S 3081 PO
Conecto C	OM457HLA	183	250	11/01	>		S 6001 NE	
with automatic gearbox ZF 6HP592 / con cambio automatico ZF 6HP592	OM457HLA	183	250	11/01	>			S 2234 Z
with air-conditioner WEBASTO Aerosphere, N.6 PCS / con climatizzatore WEBASTO Aerosphere, N.6 PZ	OM457HLA	183	250	11/01	>			S 3081 C
dryer filter / filtro essiccatore	OM457HLA	183	250	11/01	>			S 7259 A
2 filters / N.2 filtri	OM457HLA	183	250	11/01	>	S 5036 PE		
prefilter PARKER-RACOR / prefiltra PARKER-RACOR	OM457HLA	183	250	11/01	>		S 4121 NR	
power steering / servosterzo	OM457HLA	183	250	11/01	>			S 3081 PO
Conecto C	OM457HLA	220	299	01/03	>		S 6001 NE	
with automatic gearbox ZF 6HP592 / con cambio automatico ZF 6HP592	OM457HLA	220	299	01/03	>			S 2234 Z
with air-conditioner WEBASTO Aerosphere, N.6 PCS / con climatizzatore WEBASTO Aerosphere, N.6 PZ	OM457HLA	220	299	01/03	>			S 3081 C
dryer filter / filtro essiccatore	OM457HLA	220	299	01/03	>			S 7259 A
2 filters / N.2 filtri	OM457HLA	220	299	01/03	>	S 5036 PE		
prefilter PARKER-RACOR / prefiltra PARKER-RACOR	OM457HLA	220	299	01/03	>		S 4121 NR	
power steering / servosterzo	OM457HLA	220	299	01/03	>			S 3081 PO
Conecto C	OM457HLA	260	353	11/01	>		S 6001 NE	
with automatic gearbox ZF 6HP592 / con cambio automatico ZF 6HP592	OM457HLA	260	353	11/01	>			S 2234 Z
with air-conditioner WEBASTO Aerosphere, N.6 PCS / con climatizzatore WEBASTO Aerosphere, N.6 PZ	OM457HLA	260	353	11/01	>			S 3081 C
dryer filter / filtro essiccatore	OM457HLA	260	353	11/01	>			S 7259 A
2 filters / N.2 filtri	OM457HLA	260	353	11/01	>	S 5036 PE		
prefilter PARKER-RACOR / prefiltra PARKER-RACOR	OM457HLA	260	353	11/01	>		S 4121 NR	
power steering / servosterzo	OM457HLA	260	353	11/01	>			S 3081 PO
Conecto C	OM906.960LA	205	279	09/01	>	S 5036 PE	S 6017 NE	
with automatic gearbox ZF 6HP592 / con cambio automatico ZF 6HP592	OM906.960LA	205	279	09/01	>			S 2234 Z
with air-conditioner WEBASTO Aerosphere, N.6 PCS / con climatizzatore WEBASTO Aerosphere, N.6 PZ	OM906.960LA	205	279	09/01	>			S 3081 C
dryer filter / filtro essiccatore	OM906.960LA	205	279	09/01	>			S 7259 A
prefilter PARKER-RACOR / prefiltra PARKER-RACOR	OM906.960LA	205	279	09/01	>		S 4121 NR	
power steering / servosterzo	OM906.960LA	205	279	09/01	>			S 3081 PO
Conecto E	OM447HLA Euro 2	185	252	01/98	>	S 7261 PO		S 0450 A
with automatic gearbox ZF HP500/590 / con cambio automatico ZF HP500/590	OM447HLA Euro 2	185	252	01/98	>			S 2234 Z
dryer filter / filtro essiccatore	OM447HLA Euro 2	185	252	01/98	>			S 7259 A
2 filters / N.2 filtri	OM447HLA Euro 2	185	252	01/98	>		S 2162 N	
prefilter PARKER-RACOR R90D / prefiltra PARKER-RACOR R90D	OM447HLA Euro 2	185	252	01/98	>		S 4472 NR	
prefilter PARKER-RACOR R90P / prefiltra PARKER-RACOR R90P	OM447HLA Euro 2	185	252	01/98	>		S 4143 NR	
power steering / servosterzo	OM447HLA Euro 2	185	252	01/98	>			S 3081 PO
Conecto G	OM447HLA Euro 2	220	300	06/99	>	S 7261 PO		S 0450 A
with automatic gearbox ZF HP500/590 / con cambio automatico ZF HP500/590	OM447HLA Euro 2	220	300	06/99	>			S 2234 Z
dryer filter / filtro essiccatore	OM447HLA Euro 2	220	300	06/99	>			S 7259 A
2 filters / N.2 filtri	OM447HLA Euro 2	220	300	06/99	>		S 2162 N	
prefilter PARKER-RACOR R90D / prefiltra PARKER-RACOR R90D	OM447HLA Euro 2	220	300	06/99	>		S 4472 NR	
prefilter PARKER-RACOR R90P / prefiltra PARKER-RACOR R90P	OM447HLA Euro 2	220	300	06/99	>		S 4143 NR	
power steering / servosterzo	OM447HLA Euro 2	220	300	06/99	>			S 3081 PO

M



**KW HP****...MERCEDES BENZ - buses/autobus****M**

Conecto H	OM447HLA Euro 2 185 252 01/98 >	S 7261 PO	S 0450 A	S 2234 Z
with automatic gearbox ZF HP500/590 / con cambio automatico ZF HP500/590	OM447HLA Euro 2 185 252 01/98 >			S 7259 A
dryer filter / filtro essiccatore	OM447HLA Euro 2 185 252 01/98 >			
2 filters / N.2 filtri	OM447HLA Euro 2 185 252 01/98 >	S 2162 N		
prefilter PARKER-RACOR R90D / prefiltro PARKER-RACOR R90D	OM447HLA Euro 2 185 252 01/98 >	S 4472 NR		
prefilter PARKER-RACOR R90P / prefiltro PARKER-RACOR R90P	OM447HLA Euro 2 185 252 01/98 >	S 4143 NR		
power steering / servosterzo	OM447HLA Euro 2 185 252 01/98 >			S 3081 PO
Conecto H	OM906.960LA 205 279 09/01 >	S 5036 PE	S 6017 NE	
with automatic gearbox ZF 6HP592 / con cambio automatico ZF 6HP592	OM906.960LA 205 279 09/01 >			S 2234 Z
with air-conditioner WEBASTO Aerosphere, N.6 PCS / con climatizzatore WEBASTO Aerosphere, N.6 PZ	OM906.960LA 205 279 09/01 >			S 3081 C
dryer filter / filtro essiccatore	OM906.960LA 205 279 09/01 >			S 7259 A
prefilter PARKER-RACOR / prefiltro PARKER-RACOR	OM906.960LA 205 279 09/01 >	S 4121 NR		
power steering / servosterzo	OM906.960LA 205 279 09/01 >			S 3081 PO
Conecto S	OM447HLA Euro 2 185 252 01/98 >	S 7261 PO	S 0450 A	
with automatic gearbox ZF HP500/590 / con cambio automatico ZF HP500/590	OM447HLA Euro 2 185 252 01/98 >			S 2234 Z
dryer filter / filtro essiccatore	OM447HLA Euro 2 185 252 01/98 >			S 7259 A
2 filters / N.2 filtri	OM447HLA Euro 2 185 252 01/98 >	S 2162 N		
prefilter PARKER-RACOR R90D / prefiltro PARKER-RACOR R90D	OM447HLA Euro 2 185 252 01/98 >	S 4472 NR		
prefilter PARKER-RACOR R90P / prefiltro PARKER-RACOR R90P	OM447HLA Euro 2 185 252 01/98 >	S 4143 NR		
power steering / servosterzo	OM447HLA Euro 2 185 252 01/98 >			S 3081 PO
Conecto U	OM447HLA Euro 2 185 252 01/98 >	S 7261 PO	S 0450 A	
with automatic gearbox ZF HP500/590 / con cambio automatico ZF HP500/590	OM447HLA Euro 2 185 252 01/98 >			S 2234 Z
dryer filter / filtro essiccatore	OM447HLA Euro 2 185 252 01/98 >			S 7259 A
2 filters / N.2 filtri	OM447HLA Euro 2 185 252 01/98 >	S 2162 N		
prefilter PARKER-RACOR R90D / prefiltro PARKER-RACOR R90D	OM447HLA Euro 2 185 252 01/98 >	S 4472 NR		
prefilter PARKER-RACOR R90P / prefiltro PARKER-RACOR R90P	OM447HLA Euro 2 185 252 01/98 >	S 4143 NR		
power steering / servosterzo	OM447HLA Euro 2 185 252 01/98 >			S 3081 PO
Conecto UE	OM447HLA Euro 2 185 252 01/98 >	S 7261 PO	S 0450 A	
with automatic gearbox ZF HP500/590 / con cambio automatico ZF HP500/590	OM447HLA Euro 2 185 252 01/98 >			S 2234 Z
dryer filter / filtro essiccatore	OM447HLA Euro 2 185 252 01/98 >			S 7259 A
2 filters / N.2 filtri	OM447HLA Euro 2 185 252 01/98 >	S 2162 N		
prefilter PARKER-RACOR R90D / prefiltro PARKER-RACOR R90D	OM447HLA Euro 2 185 252 01/98 >	S 4472 NR		
prefilter PARKER-RACOR R90P / prefiltro PARKER-RACOR R90P	OM447HLA Euro 2 185 252 01/98 >	S 4143 NR		
power steering / servosterzo	OM447HLA Euro 2 185 252 01/98 >			S 3081 PO
Conecto UE	OM906.960LA 205 279 09/01 >	S 5036 PE	S 6017 NE	
with automatic gearbox ZF 6HP592 / con cambio automatico ZF 6HP592	OM906.960LA 205 279 09/01 >			S 2234 Z
with air-conditioner WEBASTO Aerosphere, N.6 PCS / con climatizzatore WEBASTO Aerosphere, N.6 PZ	OM906.960LA 205 279 09/01 >			S 3081 C
dryer filter / filtro essiccatore	OM906.960LA 205 279 09/01 >			S 7259 A
prefilter PARKER-RACOR / prefiltro PARKER-RACOR	OM906.960LA 205 279 09/01 >	S 4121 NR		
power steering / servosterzo	OM906.960LA 205 279 09/01 >			S 3081 PO
Integro				
O 550	OM447/HLA	01/97 > 03/06	S 7261 PO	S 2162 N
spin-on / avvitabile	OM447/HLA	01/97 > 03/06	S 7261 PO	S 4378 NR
spheros aeroshere world WEBASTO / con climatizzatore sul tetto WEBASTO	OM447/HLA	01/97 > 03/06		S 7575 A
dryer filter / filtro essiccatore	OM447/HLA	01/97 > 03/06		S 3444 C
power steering / servosterzo	OM447/HLA	01/97 > 03/06		S 7259 A
				S 3081 PO
O 550 M	OM457HLA Euro 3 260 354	09/02 > 03/06		S 6001 NE
spheros aeroshere world WEBASTO / con climatizzatore sul tetto WEBASTO	OM457HLA Euro 3 260 354	09/02 > 03/06		S 7573 A
dryer filter / filtro essiccatore	OM457HLA Euro 3 260 354	09/02 > 03/06		S 3444 C
2 filters / N.2 filtri	OM457HLA Euro 3 260 354	09/02 > 03/06	S 5036 PE	S 7259 A
power steering / servosterzo	OM457HLA Euro 3 260 354	09/02 > 03/06		S 3081 PO
Integro (663)				
12.1 m	OM457hLA Euro4/5 220 299	03/06 >		S 6001 NE
additional WEBASTO / addizionale WEBASTO	OM457hLA Euro4/5 220 299	03/06 >		S 4378 NR
spheros aeroshere world WEBASTO / con climatizzatore sul tetto WEBASTO	OM457hLA Euro4/5 220 299	03/06 >		
2 filters / N.2 filtri	OM457hLA Euro4/5 220 299	03/06 >	S 5036 PE	S 3444 C
power steering / servosterzo	OM457hLA Euro4/5 220 299	03/06 >		S 3081 PO
12.1 m	OM457hLA Euro4/5 260 353	03/06 >		S 6001 NE
additional WEBASTO / addizionale WEBASTO	OM457hLA Euro4/5 260 353	03/06 >		S 4378 NR
spheros aeroshere world / con climatizzatore sul tetto	OM457hLA Euro4/5 260 353	03/06 >		S 3444 C
2 filters / N.2 filtri	OM457hLA Euro4/5 260 353	03/06 >	S 5036 PE	
power steering / servosterzo	OM457hLA Euro4/5 260 353	03/06 >		S 3081 PO
Integro L (663)				
15 m	OM457hLA Euro4/5 260 353	03/06 >		S 6001 NE
additional WEBASTO / addizionale WEBASTO	OM457hLA Euro4/5 260 353	03/06 >		S 4378 NR
2 filters / N.2 filtri	OM457hLA Euro4/5 260 353	03/06 >	S 5036 PE	
power steering / servosterzo	OM457hLA Euro4/5 260 353	03/06 >		S 3081 PO

**kW HP****...MERCEDES BENZ - buses/autobus**

15 m	OM457hLA Euro4/5	300	408	03/06	>		S 6001 NE	S 7573 A	
additional WEBASTO / addizionale WEBASTO	OM457hLA Euro4/5	300	408	03/06	>		S 4378 NR		
2 filters / N.2 filtri	OM457hLA Euro4/5	300	408	03/06	>	S 5036 PE			
power steering / servosterzo	OM457hLA Euro4/5	300	408	03/06	>				S 3081 PO
15 m	OM470LA Euro6	265	360	04/13	>			S 7A14 A	
additional filter compressor filter / filtro supplementare filtro compressore	OM470LA Euro6	290	394	04/13	>			S 7A14 A	
Integro M (663)									
13 m	OM457hLA Euro4/5	220	299	03/06	>		S 6001 NE	S 7573 A	
additional WEBASTO / addizionale WEBASTO	OM457hLA Euro4/5	220	299	03/06	>		S 4378 NR		
2 filters / N.2 filtri	OM457hLA Euro4/5	220	299	03/06	>	S 5036 PE			
power steering / servosterzo	OM457hLA Euro4/5	220	299	03/06	>				S 3081 PO
13 m	OM457hLA Euro4/5	260	353	03/06	>		S 6001 NE	S 7573 A	
additional WEBASTO / addizionale WEBASTO	OM457hLA Euro4/5	260	353	03/06	>		S 4378 NR		
2 filters / N.2 filtri	OM457hLA Euro4/5	260	353	03/06	>	S 5036 PE			
power steering / servosterzo	OM457hLA Euro4/5	260	353	03/06	>				S 3081 PO
Intercity (634)									
Intercity	OM457LA	265	360	09/08	>	S 5062 PE	S 6001 NE	S 7608 A	
dryer filter / filtro essiccatore	OM457LA	265	360	09/08	>				S 7259 A
power steering / servosterzo	OM457LA	265	360	09/08	>				S 3081 PO
Intouro									
12.1	OM926.939 Euro4/5/EEV	210	285	03/07	>	12/09	S 5036 PE	S 6017 NE	S 7423 A
	OM926.939 Euro4/5/EEV	210	285	01/10	>		S 5036 PE	S 6017 NE	
additional WEBASTO THERMO 300 / addizionale WEBASTO THERMO 300	OM926.939 Euro4/5/EEV	210	285	03/07	>				S 4378 NR
with air-conditioner KONVEKTA P600/800, N. 8 pcs / con climatizzatore KONVEKTA P600/800,N. 8 PZ	OM926.939 Euro4/5/EEV	210	285	03/07	>				S 3279 C
with air-conditioner WEBASTO Aerosphere World NCI, N.6 PCS / con climatizzatore WEBASTO Aerosphere World NCI, N.6 PZ	OM926.939 Euro4/5/EEV	210	285	03/07	>				S 3283 C
dryer filter / filtro essiccatore	OM926.939 Euro4/5/EEV	210	285	03/07	>				S 7A66 A
power steering / servosterzo	OM926.939 Euro4/5/EEV	210	285	03/07	>				S 3081 PO
L	OM470LA	265	360	09/13	>			S 7A14 A	
additional filter compressor filter / filtro supplementare filtro compressore	OM470LA	290	394	09/13	>			S 7A14 A	
L	OM936LA	220	299	09/13	>	S 5236 PE			
L	OM936LA	260	354	09/13	>	S 5236 PE			
M	OM470LA	265	360	09/13	>			S 7A14 A	
additional filter compressor filter / filtro supplementare filtro compressore	OM470LA	290	394	09/13	>			S 7A14 A	
M	OM936LA	220	299	09/13	>	S 5236 PE			
M	OM936LA	260	354	09/13	>	S 5236 PE			
M 12.9	OM926.939 Euro4/5/EEV	210	285	03/07	>	12/09	S 5036 PE	S 6017 NE	S 7423 A
	OM926.939 Euro4/5/EEV	210	285	01/10	>		S 5036 PE	S 6017 NE	
additional WEBASTO THERMO 300 / addizionale WEBASTO THERMO 300	OM926.939 Euro4/5/EEV	210	285	03/07	>				S 4378 NR
with air-conditioner Konvekta P600/800, N. 8 pcs / con climatizzatore KONVEKTA P600/800,N. 8 PZ	OM926.939 Euro4/5/EEV	210	285	03/07	>				S 3279 C
with air-conditioner WEBASTO Aerosphere World NCI, N.6 PCS / con climatizzatore WEBASTO Aerosphere World NCI,N.6 PZ	OM926.939 Euro4/5/EEV	210	285	03/07	>				S 3283 C
dryer filter / filtro essiccatore	OM926.939 Euro4/5/EEV	210	285	03/07	>				S 7A66 A
power steering / servosterzo	OM926.939 Euro4/5/EEV	210	285	03/07	>				S 3081 PO
O 560 RH/RHD									
dryer filter / filtro essiccatore	OM441LA	250	340	02/00	>	03/07			S 7259 A
assembly DONALDSON / montaggio DONALDSON	OM441LA	250	340	02/00	>	03/07	S 5133 PE		
assembly MANN+HUMMEL / montaggio MANN+HUMMEL	OM441LA	250	340	02/00	>	03/07		S 7608 A	
2 filters / N.2 filtri	OM441LA	250	340	02/00	>	03/07		S 7546 A	
2 filters spin-on / N.2 filtri avvitabile	OM441LA	250	340	02/00	>	03/07	S 2162 N		
power steering / servosterzo	OM441LA	250	340	02/00	>	03/07	S 4378 NR		S 3081 PO
O 560 RH/RHD									
dryer filter / filtro essiccatore	OM457HLA	260	354	11/01	>	03/07		S 6001 NE	
assembly MANN+HUMMEL / montaggio MANN+HUMMEL	OM457HLA	260	354	11/01	>	03/07			S 7259 A
2 filters / N.2 filtri	OM457HLA	260	354	11/01	>	03/07	S 5036 PE		S 7546 A
prefilter PARKER-RACOR / prefiltro PARKER-RACOR	OM457HLA	260	354	11/01	>	03/07		S 4121 NR	
power steering / servosterzo	OM457HLA	260	354	11/01	>	03/07			S 3081 PO
O 560 RH/RHD									
dryer filter / filtro essiccatore	OM457LA	260	354	11/01	>	03/07	S 5062 PE	S 6001 NE	
assembly MANN+HUMMEL / montaggio MANN+HUMMEL	OM457LA	260	354	11/01	>	03/07			S 7259 A
prefilter PARKER-RACOR / prefiltro PARKER-RACOR	OM457LA	260	354	11/01	>	03/07		S 4121 NR	S 7546 A
power steering / servosterzo	OM457LA	260	354	11/01	>	03/07			S 3081 PO

Medio**M**



KW HP



...MERCEDES BENZ - buses/autobus

M



O 815	OM904LA	110	150	10/00	>	S 5007 PE	S 6017 NE	S 3059 A	
dryer filter / filtro essiccatore	OM904LA	110	150	10/00	>				S 7259 A
power steering / servosterzo	OM904LA	110	150	10/00	>				S 3081 PO
O 818	OM904LA Euro3	130	177	09/05	>	S 5007 PE	S 6017 NE	S 3059 A	
dryer filter / filtro essiccatore	OM904LA Euro3	130	177	09/05	>				S 7259 A
power steering / servosterzo	OM904LA Euro3	130	177	09/05	>				S 3081 PO
O 100 Serie									
O 100 City	OM602.940			01/94	>	05/96	S 7510 O	S 9600 NR	
to frame No. 941505 / a telaio N. 941505	OM602.940			01/94	>	05/96	S 7510 O	S 1013 B	
O 301 Serie									
O 301 (697.006)	OM366A, OM366.965A			02/86	>	05/87	S 8260 PO	S 2161 N	S 2450 A
O 301 F	OM366.917, OM366.965A			06/86	>	05/87	S 8260 PO	S 2161 N	S 2450 A
O 302 Serie									
O 302	OM360			05/69	>	12/74	S 0300 O	S 2162 N	S 5270 A
some / alcuni	OM360			05/69	>	12/74	S 0300 O	S 2162 N	
power steering / servosterzo	OM360			05/69	>	12/74			S 8790 PO
O 303 Serie									
O 303	OM401, OM401.912			10/74	>	06/83	S 8260 PO	S 2161 N	S 2450 A
some / alcuni	OM401, OM401.912			10/74	>	06/83	S 8260 PO	S 2162 N	S 2650 A
power steering / servosterzo	OM401, OM401.912			10/74	>	06/83			S 8790 PO
O 303	OM402, OM402.907			03/75	>	06/83	S 8260 PO	S 2161 N	S 2650 A
some / alcuni	OM402, OM402.907			03/75	>	06/83	S 7261 PO	S 2162 N	S 0450 A
power steering / servosterzo	OM402, OM402.907			03/75	>	06/83			S 8790 PO
O 303	OM403 (serie 403.905)			07/75	>	06/83		S 2161 N	S 0450 A
some / alcuni	OM403 (serie 403.905)			07/75	>	06/83		S 2162 N	S 0450 A
power steering / servosterzo	OM403 (serie 403.905)			07/75	>	06/83			S 8790 PO
O 303	OM403, OM403.918			07/75	>	06/83	S 7261 PO	S 2161 N	S 0450 A
some / alcuni	OM403, OM403.918			07/75	>	06/83	S 7261 PO	S 2162 N	S 0450 A
power steering / servosterzo	OM403, OM403.918			07/75	>	06/83			S 8790 PO
O 303	OM421, OM421.908			01/80	>	04/89	S 8260 PO	S 2161 N	S 2650 A
some / alcuni	OM421, OM421.908			01/80	>	04/89	S 7261 PO	S 2162 N	S 0450 A
power steering / servosterzo	OM421, OM421.908			01/80	>	04/89			S 8790 PO
O 303	OM422, OM422.908			01/80	>	09/87	S 7261 PO	S 2161 N	S 2650 A
some / alcuni	OM422, OM422.908			01/80	>	09/87	S 7261 PO	S 2162 N	S 0450 A
power steering / servosterzo	OM422, OM422.908			01/80	>	09/87			S 8790 PO
O 303	OM441, OM441A			09/87	>	09/92	S 8260 PO	S 2161 N	S 0450 A
some / alcuni	OM441, OM441A			09/87	>	09/92	S 8260 PO	S 2162 N	S 0450 A
power steering / servosterzo	OM441, OM441A			09/87	>	09/92			S 8790 PO
O 303	OM442A, OM442.910/939			09/87	>	09/92	S 7261 PO	S 2161 N	S 0450 A
some / alcuni	OM442A, OM442.910/939			09/87	>	09/92	S 7261 PO	S 2162 N	S 0450 A
power steering / servosterzo	OM442A, OM442.910/939			09/87	>	09/92			S 8790 PO
O 303 (300.210/300.290)	OM422.951A			11/85	>	04/89	S 7261 PO	S 2161 N	S 2650 A
some / alcuni	OM422.951A			11/85	>	04/89	S 8260 PO	S 2162 N	S 0450 A
power steering / servosterzo	OM422.951A			11/85	>	04/89			S 8790 PO
O 303 (300.485/300.495)	OM422A, OM422.951A			08/80	>	09/87	S 7261 PO	S 2161 N	S 0450 A
some / alcuni	OM422A, OM422.951A			08/80	>	09/87	S 7261 PO	S 2162 N	S 0450 A
power steering / servosterzo	OM422A, OM422.951A			08/80	>	09/87			S 8790 PO
O 304 Serie									
O 304	OM402.984	280	382	08/92	>	12/96	S 5133 PE		S 7546 A
additional WEBASTO / addizionale WEBASTO	OM402.984	280	382	08/92	>	12/96		S 2161 N	
dryer filter / filtro essiccatore	OM402.984	280	382	08/92	>	12/96			S 7259 A
2 filters / N.2 filtri	OM402.984	280	382	08/92	>	12/96		S 2162 N	
power steering / servosterzo	OM402.984	280	382	08/92	>	12/96			S 3081 PO
O 304	OM441.994	250	340	08/92	>	12/96	S 5133 PE		S 7546 A
additional WEBASTO / addizionale WEBASTO	OM441.994	250	340	08/92	>	12/96		S 2161 N	
dryer filter / filtro essiccatore	OM441.994	250	340	08/92	>	12/96			S 7259 A
2 filters / N.2 filtri	OM441.994	250	340	08/92	>	12/96		S 2162 N	
power steering / servosterzo	OM441.994	250	340	08/92	>	12/96			S 3081 PO
O 305 Serie									
O 305 G	OM407H			11/76	>	05/87		S 2162 N	S 5270 A
some / alcuni	OM407H			11/76	>	05/87	S 7261 PO	S 2161 N	S 6370 A
power steering / servosterzo	OM407H			11/76	>	05/87			S 8790 PO
O 305 G	OM407HA			02/78	>	05/87		S 2162 N	S 3570 A
some / alcuni	OM407HA			02/78	>	05/87	S 7261 PO	S 2161 N	S 3570 A
power steering / servosterzo	OM407HA			02/78	>	05/87			S 8790 PO
O 305 ST	OM407H			11/76	>	05/87		S 2162 N	S 5270 A
some / alcuni	OM407H			11/76	>	05/87	S 7261 PO	S 2162 N	S 6370 A



kW HP



...MERCEDES BENZ - buses/autobus

power steering / servosterzo	OM407H			11/76 > 05/87				S 8790 PO
O 305-13							S 2162 N	
O 307 Serie								
O 307	OM407H			04/73 > 07/87			S 2162 N	S 5270 A
some / alcuni	OM407H			04/73 > 07/87	S 7261 PO		S 2161 N	S 6370 A
power steering / servosterzo	OM407H			04/73 > 07/87				S 8790 PO
O 309 Serie								
O 309	M102			08/82 > 02/89	S 9080 PO			S 2810 A
O 309 B							S 2161 N	
O 309 B	M102			08/82 > 02/89	S 9080 PO			S 2810 A
O 309 D	OM314			01/70 > 12/77	S 4000 O		S 2162 N	
	OM314			01/78 > 12/86	S 5099 PE		S 2162 N	
O 309 D	OM352			05/77 > 12/77	S 0300 O		S 2161 N	S 7550 A
	OM352			01/78 > 02/89	S 5124 PE		S 2161 N	S 7550 A
O 309 D	OM353.966			05/77 > 12/77	S 0300 O		S 2161 N	S 7550 A
	OM353.966			01/78 > 02/89	S 5124 PE		S 2161 N	S 7550 A
O 309 D	OM615				S 0122 O		S 2161 N	
O 309 D	OM616			09/82 > 02/89	S 2510 O		S 2610 NR	S 7940 A
prefilter / prefiltra	OM616			09/82 > 02/89			S 1013 B	
O 309 D	OM617			09/82 > 02/89	S 2510 O		S 2610 NR	S 7940 A
prefilter / prefiltra	OM617			09/82 > 02/89			S 1013 B	
O 317 Serie								
O 317	OM326			01/66 > 01/78	S 2530 PO		S 2162 N	
some / alcuni	OM326			01/66 > 01/78	S 2530 PO		S 2162 N	
power steering / servosterzo	OM326			01/66 > 01/78				S 8790 PO
O 317	OM346			01/66 > 01/78	S 2530 PO		S 2162 N	
some / alcuni	OM346			01/66 > 01/78	S 2530 PO		S 2162 N	
power steering / servosterzo	OM346			01/66 > 01/78				S 8790 PO
O 317	OM355HA				S 9490 PO		S 2162 N	S 3570 A
power steering / servosterzo	OM355HA							S 8790 PO
O 319 Serie								
O 319 B							S 2161 N	
O 319 D				> 12/64	S 4000 O		S 2161 N	
				01/65 >	S 0122 O		S 2161 N	
O 321 Serie								
O 321							S 2162 N	S 7813 A
O 321 H	OM322				S 2530 PO		S 2162 N	
power steering / servosterzo	OM322							S 8790 PO
O 321 H	OM346				S 2530 PO		S 2162 N	
power steering / servosterzo	OM346							S 8790 PO
O 321 H	OM352				S 0300 O		S 2162 N	
O 322 Serie								
O 322	OM322				S 2530 PO		S 2162 N	
power steering / servosterzo	OM322							S 8790 PO
O 322	OM346				S 2530 PO		S 2162 N	
power steering / servosterzo	OM346							S 8790 PO
O 322	OM352				S 0300 O		S 2162 N	
O 330 Serie								
O 330	OM442.939	213 290		01/90 > 12/96				S 7546 A
additional WEBASTO / addizionale WEBASTO	OM442.939	213 290		01/90 > 12/96			S 2161 N	
dryer filter / filtro essiccatore	OM442.939	213 290		01/90 > 12/96				S 7259 A
2 filters / N.2 filtri	OM442.939	213 290		01/90 > 12/96			S 2162 N	
power steering / servosterzo	OM442.939	213 290		01/90 > 12/96				S 3081 PO
O 340 Serie								
O 340	OM441LA	250 340		01/91 > 09/95	S 5133 PE			S 7546 A
2 filters / N.2 filtri	OM441LA	250 340		01/91 > 09/95			S 2162 N	
power steering / servosterzo	OM441LA	250 340		01/91 > 09/95				S 3081 PO
O 345 Serie								
O 345	OM447HLA	184 251		01/95 >	S 7261 PO		S 2162 N	S 0450 A
with automatic gearbox ZF HP500/590 / con cambio automatico ZF HP500/590	OM447HLA	184 251		01/95 >				S 2234 Z
dryer filter / filtro essiccatore	OM447HLA	184 251		01/95 >				S 7259 A
power steering / servosterzo	OM447HLA	184 251		01/95 >				S 3081 PO
O 345 K	OM447HLA	220 300		01/95 >	S 7261 PO		S 2162 N	S 0450 A
with automatic gearbox ZF HP500/590 / con cambio automatico ZF HP500/590	OM447HLA	220 300		01/95 >				S 2234 Z
dryer filter / filtro essiccatore	OM447HLA	220 300		01/95 >				S 7259 A
power steering / servosterzo	OM447HLA	220 300		01/95 >				S 3081 PO
O 345 S	OM447HLA	184 251		01/95 >	S 7261 PO		S 2162 N	S 0450 A

M



**KW HP****...MERCEDES BENZ - buses/autobus****M**

with automatic gearbox ZF HP500/590 / con cambio automatico ZF HP500/590	OM447HLA	184	251	01/95	>				S 2234 Z
dryer filter / filtro essiccatore	OM447HLA	184	251	01/95	>				S 7259 A
power steering / servosterzo	OM447HLA	184	251	01/95	>				S 3081 PO
O 400 Serie									
O 400 R (BR)	OM449A	180	245	03/93	>	S 8260 PO	S 2162 N	S 0450 A	
inner / interno	OM449A	180	245	03/93	>			S 1450 A	
power steering / servosterzo	OM449A	180	245	03/93	>				S 3081 PO
O 400 RS	OM447LA	260	354	01/92	>	S 8260 PO	S 2162 N	S 0450 A	
inner / interno	OM447LA	260	354	01/92	>			S 1450 A	
power steering / servosterzo	OM447LA	260	354	01/92	>				S 3081 PO
O 400 RSD/RSE/MP (BR)	OM457LA			01/05	>	S 5062 PE	S 6001 NE		
power steering / servosterzo	OM457LA			01/05	>				S 3081 PO
O 402 Serie									
O 402	OM366.917	100	136	02/86	>	12/91	S 5124 PE	S 2161 N	S 2450 A
O 402	OM366.965/OM366.965A	125	170	02/86	>	12/91	S 5124 PE	S 2161 N	S 2450 A
O 404 Serie									
O 404	OM401.974 (OM401LA)	200	272	09/91	>	S 5133 PE		S 1670 A	
with automatic gearbox ZF 5HP590 / con cambio automatico ZF 5HP590	OM401.974 (OM401LA)	200	272	09/91	>				S 2234 Z
with air-conditioner / con climatizzatore	OM401.974 (OM401LA)	200	272	09/91	>				S 3442 C
spheros aeroshere world / con climatizzatore sul tetto	OM401.974 (OM401LA)	200	272	09/91	>				S 3441 C
dryer filter / filtro essiccatore	OM401.974 (OM401LA)	200	272	09/91	>				S 7259 A
2 filters / N.2 filtri	OM401.974 (OM401LA)	200	272	09/91	>		S 2162 N		
power steering / servosterzo	OM401.974 (OM401LA)	200	272	09/91	>				S 3081 PO
O 404	OM402.970 (OM402A)	280	381	09/91	>	S 5133 PE		S 1670 A	
with automatic gearbox ZF 5HP590 / con cambio automatico ZF 5HP590	OM402.970 (OM402A)	280	381	09/91	>				S 2234 Z
with air-conditioner / con climatizzatore	OM402.970 (OM402A)	280	381	09/91	>				S 3442 C
spheros aeroshere world / con climatizzatore sul tetto	OM402.970 (OM402A)	280	381	09/91	>				S 3441 C
dryer filter / filtro essiccatore	OM402.970 (OM402A)	280	381	09/91	>				S 7259 A
2 filters / N.2 filtri	OM402.970 (OM402A)	280	381	09/91	>		S 2162 N		
power steering / servosterzo	OM402.970 (OM402A)	280	381	09/91	>				S 3081 PO
O 404	OM441.921/922 (OM441LA)	165	224	09/91	>	01/92	S 5133 PE		S 1670 A
with automatic gearbox ZF 5HP590 / con cambio automatico ZF 5HP590	OM441.921/922 (OM441LA)	165	224	09/91	>	01/92			S 2234 Z
with air-conditioner / con climatizzatore	OM441.921/922 (OM441LA)	165	224	09/91	>	01/92			S 3442 C
spheros aeroshere world / con climatizzatore sul tetto	OM441.921/922 (OM441LA)	165	224	09/91	>	01/92			S 3441 C
dryer filter / filtro essiccatore	OM441.921/922 (OM441LA)	165	224	09/91	>	01/92			S 7259 A
2 filters / N.2 filtri	OM441.921/922 (OM441LA)	165	224	09/91	>	01/92		S 2162 N	
power steering / servosterzo	OM441.921/922 (OM441LA)	165	224	09/91	>	01/92			S 3081 PO
O 404	OM441.980	250	340	09/91	>	S 5133 PE		S 1670 A	
with automatic gearbox ZF 5HP590 / con cambio automatico ZF 5HP590	OM441.980	250	340	09/91	>				S 2234 Z
with air-conditioner / con climatizzatore	OM441.980	250	340	09/91	>				S 3442 C
spheros aeroshere world / con climatizzatore sul tetto	OM441.980	250	340	09/91	>				S 3441 C
dryer filter / filtro essiccatore	OM441.980	250	340	09/91	>				S 7259 A
2 filters / N.2 filtri	OM441.980	250	340	09/91	>		S 2162 N		
power steering / servosterzo	OM441.980	250	340	09/91	>				S 3081 PO
O 404	OM442.930 (OM442LA)	213	290	09/91	>			S 1670 A	
with automatic gearbox ZF 5HP590 / con cambio automatico ZF 5HP590	OM442.930 (OM442LA)	213	290	09/91	>				S 2234 Z
with air-conditioner / con climatizzatore	OM442.930 (OM442LA)	213	290	09/91	>				S 3442 C
spheros aeroshere world / con climatizzatore sul tetto	OM442.930 (OM442LA)	213	290	09/91	>				S 3441 C
dryer filter / filtro essiccatore	OM442.930 (OM442LA)	213	290	09/91	>				S 7259 A
2 filters / N.2 filtri	OM442.930 (OM442LA)	213	290	09/91	>		S 2162 N		
power steering / servosterzo	OM442.930 (OM442LA)	213	290	09/91	>				S 3081 PO
O 404	OM442.996	370	503			S 8260 PO		S 1670 A	
some / alcuni	OM442.996	370	503						S 7259 A
dryer filter / filtro essiccatore	OM442.996	370	503						
2 filters / N.2 filtri	OM442.996	370	503				S 2162 N		
2 filters / N.2 filtri	OM442.996	370	503					S 2450 A	
O 404	OM445.934	250	340	09/91	>	S 5133 PE		S 1670 A	
with automatic gearbox ZF 5HP590 / con cambio automatico ZF 5HP590	OM445.934	250	340	09/91	>				S 2234 Z
with air-conditioner / con climatizzatore	OM445.934	250	340	09/91	>				S 3442 C
spheros aeroshere world / con climatizzatore sul tetto	OM445.934	250	340	09/91	>				S 3441 C
dryer filter / filtro essiccatore	OM445.934	250	340	09/91	>				S 7259 A
2 filters / N.2 filtri	OM445.934	250	340	09/91	>		S 2162 N		
power steering / servosterzo	OM445.934	250	340	09/91	>				S 3081 PO
O 404	OM445.935	213	290	09/94	>	S 5133 PE		S 1670 A	
with automatic gearbox ZF 5HP590 / con cambio automatico ZF 5HP590	OM445.935	213	290	09/94	>				S 2234 Z
with air-conditioner / con climatizzatore	OM445.935	213	290	09/94	>				S 3442 C
spheros aeroshere world / con climatizzatore sul tetto	OM445.935	213	290	09/94	>				S 3441 C



kW HP



...MERCEDES BENZ - buses/autobus

dryer filter / filtro essiccatore	OM445.935	213	290	09/94	>			S 2162 N		S 7259 A
2 filters / N.2 filtri	OM445.935	213	290	09/94	>					
power steering / servosterzo	OM445.935	213	290	09/94	>					S 3081 PO
O 404	OM446.934/938	280	381	09/94	>	S 5133 PE			S 1670 A	
some / alcuni	OM446.934/938	280	381	09/94	>				S 7187 A	
with automatic gearbox ZF 5HP590 / con cambio automatico ZF 5HP590	OM446.934/938	280	381	09/94	>					S 2234 Z
with air-conditioner / con climatizzatore	OM446.934/938	280	381	09/94	>					S 3442 C
spheros aerosphere world / con climatizzatore sul tetto	OM446.934/938	280	381	09/94	>					S 3441 C
dryer filter / filtro essiccatore	OM446.934/938	280	381	09/94	>					S 7259 A
2 filters / N.2 filtri	OM446.934/938	280	381	09/94	>			S 2162 N		
power steering / servosterzo	OM446.934/938	280	381	09/94	>					S 3081 PO
O 405 Serie										
O 405	OM427H/HA			11/85	> 12/86	S 7261 PO		S 2162 N	S 0450 A	
with automatic gearbox ZF HP500/590 / con cambio automatico ZF HP500/590	OM427H/HA			11/85	> 12/86					S 2234 Z
power steering / servosterzo	OM427H/HA			11/85	> 12/86					S 3081 PO
O 405	OM447H			11/86	>	S 7261 PO		S 2162 N	S 0450 A	
with automatic gearbox ZF HP500/590 / con cambio automatico ZF HP500/590	OM447H			11/86	>					S 2234 Z
power steering / servosterzo	OM447H			11/86	>					S 3081 PO
O 405 E	OM427H			10/84	> 12/91	S 7261 PO		S 2162 N	S 0450 A	
with automatic gearbox ZF HP500/590 / con cambio automatico ZF HP500/590	OM427H			10/84	> 12/91					S 2234 Z
power steering / servosterzo	OM427H			10/84	> 12/91					S 3081 PO
O 405 E	OM447H			10/84	> 12/91	S 7261 PO		S 2162 N	S 0450 A	
with automatic gearbox ZF HP500/590 / con cambio automatico ZF HP500/590	OM447H			10/84	> 12/91					S 2234 Z
power steering / servosterzo	OM447H			10/84	> 12/91					S 3081 PO
O 405 G	OM427H/HA			11/85	>	S 7261 PO		S 2162 N	S 0450 A	
with automatic gearbox ZF HP500/590 / con cambio automatico ZF HP500/590	OM427H/HA			11/85	>					S 2234 Z
power steering / servosterzo	OM427H/HA			11/85	>					S 3081 PO
O 405 G	OM447H			11/85	>	S 7261 PO		S 2162 N	S 0450 A	
with automatic gearbox ZF HP500/590 / con cambio automatico ZF HP500/590	OM447H			11/85	>					S 2234 Z
power steering / servosterzo	OM447H			11/85	>					S 3081 PO
O 405 GN	OM447HA/HLA			09/91	>	S 7261 PO		S 2162 N	S 0450 A	
with automatic gearbox ZF HP500/590 / con cambio automatico ZF HP500/590	OM447HA/HLA			09/91	>					S 2234 Z
power steering / servosterzo	OM447HA/HLA			09/91	>					S 3081 PO
O 405 N	OM447H/HA/HLA			10/89	>	S 7261 PO		S 2162 N	S 0450 A	
some / alcuni	OM447H/HA/HLA			10/89	> 10/91	S 8260 PO		S 2162 N	S 0450 A	
some / alcuni	OM447H/HA/HLA			11/91	>	S 8260 PO		S 2161 N	S 0450 A	
with automatic gearbox ZF HP500/590 / con cambio automatico ZF HP500/590	OM447H/HA/HLA			10/89	>					S 2234 Z
power steering / servosterzo	OM447H/HA/HLA			10/89	>					S 3081 PO
O 407 Serie										
O 407	OM447H/HII/HLA			03/87	> 06/01	S 7261 PO		S 2162 N	S 0450 A	
some / alcuni	OM447H/HII/HLA			03/87	> 06/01	S 7261 PO		S 2161 N	S 0450 A	
with automatic gearbox ZF HP500/590 / con cambio automatico ZF HP500/590	OM447H/HII/HLA			03/87	> 06/01					S 2234 Z
dryer filter / filtro essiccatore	OM447H/HII/HLA			03/87	> 06/01					S 7259 A
power steering / servosterzo	OM447H/HII/HLA			03/87	> 06/01					S 3081 PO
O 407 E	OM447H/HII/HLA			03/87	> 06/01	S 7261 PO		S 2162 N	S 0450 A	
some / alcuni	OM447H/HII/HLA			03/87	> 06/01	S 7261 PO		S 2161 N	S 0450 A	
with automatic gearbox ZF HP500/590 / con cambio automatico ZF HP500/590	OM447H/HII/HLA			03/87	> 06/01					S 2234 Z
dryer filter / filtro essiccatore	OM447H/HII/HLA			03/87	> 06/01					S 7259 A
power steering / servosterzo	OM447H/HII/HLA			03/87	> 06/01					S 3081 PO
O 408 Serie										
O 408	OM447H/HA/HLA			01/91	>	S 7261 PO		S 2162 N	S 0450 A	
with automatic gearbox ZF HP500/590 / con cambio automatico ZF HP500/590	OM447H/HA/HLA			01/91	>					S 2234 Z
dryer filter / filtro essiccatore	OM447H/HA/HLA			01/91	>					S 7259 A
power steering / servosterzo	OM447H/HA/HLA			01/91	>					S 3081 PO
O 530 Serie										
O 530 GL CapaCity	OM457hLA Euro4	220	300	04/07	>			S 6001 NE		
with automatic gearbox VOITH D864.3E / con cambio automatico VOITH D864.3E	OM457hLA Euro4	220	300	04/07	>					S 5663 PO
with automatic gearbox ZF 6HP502C/592C/602C / con cambio automatico ZF 6HP502C/592C/602C	OM457hLA Euro4	220	300	04/07	>					S 2234 Z
with air-conditioner KONVEKTA P600/P800, N.8 PCS / con climatizzatore KONVEKTA P600/P800, N.8 PZ	OM457hLA Euro4	220	300	04/07	>					S 3279 C
with air-conditioner WEBASTO Aerosphere World NCI, N.6 PCS / con climatizzatore WEBASTO Aerosphere World NCI, N.6 PZ	OM457hLA Euro4	220	300	04/07	>					S 3283 C
with air-conditioner WEBASTO Spheros (frontbox) / con climatizzatore WEBASTO Spheros (frontbox)	OM457hLA Euro4	220	300	04/07	>					S 3451 C
with manual pump prefilter / con pompa manuale prefiltro	OM457hLA Euro4	220	300	04/07	>			S 6089 NE		
dryer filter / filtro essiccatore	OM457hLA Euro4	220	300	04/07	>					S 7A66 A
2 filters / N.2 filtri	OM457hLA Euro4	220	300	04/07	>	S 5036 PE				
prefilter PARKER-RACOR / prefiltro PARKER-RACOR	OM457hLA Euro4	220	300	04/07	>			S 4472 NR		
power steering / servosterzo	OM457hLA Euro4	220	300	04/07	>					S 3081 PO
O 530 GL CapaCity	OM457hLA Euro4	260	354	04/07	>			S 6001 NE		

M





kW HP



...MERCEDES BENZ - buses/autobus

M



with automatic gearbox VOITH D864.3E / con cambio automatico VOITH D864.3E	OM457hLA Euro4	260	354	04/07	>				S 5663 PO
with automatic gearbox ZF 6HP502C/592C/602C / con cambio automatico ZF 6HP502C/592C/602C	OM457hLA Euro4	260	354	04/07	>				S 2234 Z
with air-conditioner KONVEKTA P600/P800, N.8 PCS / con climatizzatore KONVEKTA P600/P800, N.8 PZ	OM457hLA Euro4	260	354	04/07	>				S 3279 C
with air-conditioner WEBASTO Aerosphere World NCI, N.6 PCS / con climatizzatore WEBASTO Aerosphere World NCI, N.6 PZ	OM457hLA Euro4	260	354	04/07	>				S 3283 C
with air-conditioner WEBASTO Spheros (frontbox) / con climatizzatore WEBASTO Spheros (frontbox)	OM457hLA Euro4	260	354	04/07	>				S 3451 C
with manual pump prefilter / con pompa manuale prefiltra	OM457hLA Euro4	260	354	04/07	>		S 6089 NE		
dryer filter / filtro essiccatore	OM457hLA Euro4	260	354	04/07	>				S 7A66 A
2 filters / N.2 filtri	OM457hLA Euro4	260	354	04/07	>	S 5036 PE			
prefilter PARKER-RACOR / prefiltra PARKER-RACOR	OM457hLA Euro4	260	354	04/07	>		S 4472 NR		
power steering / servosterzo	OM457hLA Euro4	260	354	04/07	>				S 3081 PO
O 530 L CapaCity									
with automatic gearbox VOITH D864.3E / con cambio automatico VOITH D864.3E	OM470LA	265	360	12/14	>				S 5663 PO
with automatic gearbox ZF 6HP502C/592C/602C / con cambio automatico ZF 6HP502C/592C/602C	OM470LA	265	360	12/14	>				S 2234 Z
with air-conditioner KONVEKTA P600/P800, N.8 PCS / con climatizzatore KONVEKTA P600/P800, N.8 PZ	OM470LA	265	360	12/14	>				S 3279 C
with air-conditioner WEBASTO Aerosphere World NCI, N.6 PCS / con climatizzatore WEBASTO Aerosphere World NCI, N.6 PZ	OM470LA	265	360	12/14	>				S 3283 C
with air-conditioner WEBASTO Spheros (frontbox) / con climatizzatore WEBASTO Spheros (frontbox)	OM470LA	265	360	12/14	>				S 3451 C
dryer filter / filtro essiccatore	OM470LA	265	360	12/14	>				S 7A66 A
power steering / servosterzo	OM470LA	265	360	12/14	>				S 3081 PO
O 530 L CapaCity									
with automatic gearbox VOITH D864.3E / con cambio automatico VOITH D864.3E	OM470LA	290	394	12/14	>				S 5663 PO
with automatic gearbox ZF 6HP502C/592C/602C / con cambio automatico ZF 6HP502C/592C/602C	OM470LA	290	394	12/14	>				S 2234 Z
with air-conditioner KONVEKTA P600/P800, N.8 PCS / con climatizzatore KONVEKTA P600/P800, N.8 PZ	OM470LA	290	394	12/14	>				S 3279 C
with air-conditioner WEBASTO Aerosphere World NCI, N.6 PCS / con climatizzatore WEBASTO Aerosphere World NCI, N.6 PZ	OM470LA	290	394	12/14	>				S 3283 C
with air-conditioner WEBASTO Spheros (frontbox) / con climatizzatore WEBASTO Spheros (frontbox)	OM470LA	290	394	12/14	>				S 3451 C
dryer filter / filtro essiccatore	OM470LA	290	394	12/14	>				S 7A66 A
power steering / servosterzo	OM470LA	290	394	12/14	>				S 3081 PO
O 609 Serie									
O 609 D	OM364			07/87	>	12/92	S 5099 PE	S 2161 N	S 3030 A
with threaded case cover (MERCEDES 3661800609) / con il coperchio del contenitore filettato (MERCEDES 3661800609)	OM364							S 2161 N	S 3030 A
power steering / servosterzo	OM364			07/87	>	12/92			S 3081 PO
O 611 Serie									
O 611 D	OM364A			07/87	>		S 5099 PE	S 2161 N	S 3059 A
with threaded case cover (MERCEDES 3661800609) / con il coperchio del contenitore filettato (MERCEDES 3661800609)	OM364A			07/87	>			S 2161 N	S 3059 A
power steering / servosterzo	OM364A			07/87	>				S 3081 PO
O 614 Serie									
O 614 D	OM364LA			07/87	>	12/92	S 5099 PE	S 2161 N	S 3059 A
with threaded case cover (MERCEDES 3661800609) / con il coperchio del contenitore filettato (MERCEDES 3661800609)	OM364LA			07/87	>	12/92		S 2161 N	S 3059 A
power steering / servosterzo	OM364LA			07/87	>	12/92			S 3081 PO
O 810 Serie									
O 810 D	OM904	75	102	10/96	>		S 5007 PE	S 6017 NE	S 3059 A
dryer filter / filtro essiccatore	OM904	75	102	10/96	>				S 7259 A
power steering / servosterzo	OM904	75	102	10/96	>				S 3081 PO
O 812 Serie									
O 812 D	OM602.980DELA	90	122	10/96	>		S 5095 PE	S 9600 NR	S 3059 A
dryer filter / filtro essiccatore	OM602.980DELA	90	122	10/96	>				S 7259 A
power steering / servosterzo	OM602.980DELA	90	122	10/96	>				S 3081 PO
O 813 Serie									
O 813 D Vario	OM904LA BlueTec4	95	129	09/06	>		S 5007 PE	S 6017 NE	S 3059 A
power steering / servosterzo	OM904LA BlueTec4	95	129	09/06	>				S 3081 PO
O 814 Serie									
O 814 D	OM904.906LA	100	136	10/96	>		S 5007 PE	S 6017 NE	S 3059 A
dryer filter / filtro essiccatore	OM904.906LA	100	136	10/96	>				S 7259 A
power steering / servosterzo	OM904.906LA	100	136	10/96	>				S 3081 PO
O 815 Serie									
O 815 D	OM904LA	112	152	10/96	>		S 5007 PE	S 6017 NE	S 3059 A
dryer filter / filtro essiccatore	OM904LA	112	152	10/96	>				S 7259 A
power steering / servosterzo	OM904LA	112	152	10/96	>				S 3081 PO
O 816 Serie									
O 816 D Vario	OM904LA BlueTec4	115	156	09/06	>		S 5007 PE	S 6017 NE	S 3059 A
power steering / servosterzo	OM904LA BlueTec4	115	156	09/06	>				S 3081 PO
O 818 Serie									
O 818 D Vario	OM904LA BlueTec4	130	177	09/06	>		S 5007 PE	S 6017 NE	S 3059 A
power steering / servosterzo	OM904LA BlueTec4	130	177	09/06	>				S 3081 PO
OC Serie									
OC 500 (RF2542)									
dryer filter / filtro essiccatore	OM457LA	310	423	09/02	>				S 7259 A
assembly DONALDSON / montaggio DONALDSON	OM457LA	310	423	09/02	>		S 5062 PE	S 6001 NE	S 7608 A

**kW HP**

...MERCEDES BENZ - buses/autobus

assembly MANN+HUMMEL / montaggio MANN+HUMMEL	OM457LA	310	423	09/02 >	S 5062 PE	S 6001 NE	S 7573 A	
prefilter PARKER-RACOR / prefiltro PARKER-RACOR	OM457LA	310	423	09/02 >		S 4121 NR		
power steering / servosterzo	OM457LA	310	423	09/02 >				S 3081 PO
OC 500 (RF2542)	OM457LA (Serie 634.300/301 NAFTA)	310	423	09/02 >	S 5062 PE	S 6001 NE	S 7A21 A	✗
dryer filter / filtro essiccatore	OM457LA (Serie 634.300/301 NAFTA)	310	423	09/02 >			S 7646 A	S 7259 A
inner / interno	OM457LA (Serie 634.300/301 NAFTA)	310	423	09/02 >				
prefilter PARKER-RACOR / prefiltro PARKER-RACOR	OM457LA (Serie 634.300/301 NAFTA)	310	423	09/02 >		S 4121 NR		
power steering / servosterzo	OM457LA (Serie 634.300/301 NAFTA)	310	423	09/02 >				S 3081 PO
Sprinter City (906)								
35	OM646DE22LA	80	109	09/06 >	S 5013 PE	S 2320 NR	S 3340 A	S 3137 C
with activated carbons / ai carboni attivi	OM646DE22LA	80	109	09/06 >				S 4161 CA
with facility for water sensor / con predisposizione per sensore acqua	OM646DE22LA	80	109	09/06 >		S 4107 NR		
35	OM651LA Euro5/EEV	95	129	09/10 >	S 5159 PE		S 3340 A	S 3137 C
with activated carbons / ai carboni attivi	OM651LA Euro5/EEV	95	129	09/10 >				S 4161 CA
with fuel oil heater with connection for water suction / con riscaldatore nafta con collegamento per aspirazione acqua	OM651LA Euro5/EEV	95	129	09/10 >		S 4149 NR		
with fuel oil heater without connection for water suction / con riscaldatore nafta senza collegamento per aspirazione acqua	OM651LA Euro5/EEV	95	129	09/10 >		S 4150 NR		
without fuel oil heater KNECHT-MAHLE / senza riscaldatore nafta KNECHT-MAHLE	OM651LA Euro5/EEV	95	129	09/10 >		S 4112 NR		
without fuel oil heater MANN+HUMMEL / senza riscaldatore nafta MANN+HUMMEL	OM651LA Euro5/EEV	95	129	09/10 >		S 4077 NR		
65	OM646DE22LA	110	150	09/06 >	S 5013 PE	S 2320 NR	S 3340 A	S 3137 C
with activated carbons / ai carboni attivi	OM646DE22LA	110	150	09/06 >				S 4161 CA
with facility for water sensor / con predisposizione per sensore acqua	OM646DE22LA	110	150	09/06 >		S 4107 NR		
65	OM651LA Euro5/EEV	120	163	09/10 >	S 5159 PE		S 3340 A	S 3137 C
with activated carbons / ai carboni attivi	OM651LA Euro5/EEV	120	163	09/10 >				S 4161 CA
with fuel oil heater with connection for water suction / con riscaldatore nafta con collegamento per aspirazione acqua	OM651LA Euro5/EEV	120	163	09/10 >		S 4149 NR		
with fuel oil heater without connection for water suction / con riscaldatore nafta senza collegamento per aspirazione acqua	OM651LA Euro5/EEV	120	163	09/10 >		S 4150 NR		
without fuel oil heater KNECHT-MAHLE / senza riscaldatore nafta KNECHT-MAHLE	OM651LA Euro5/EEV	120	163	09/10 >		S 4112 NR		
without fuel oil heater MANN+HUMMEL / senza riscaldatore nafta MANN+HUMMEL	OM651LA Euro5/EEV	120	163	09/10 >		S 4077 NR		
77	OM651LA Euro5/EEV	120	163	09/10 >	S 5159 PE		S 3340 A	S 3137 C
with activated carbons / ai carboni attivi	OM651LA Euro5/EEV	120	163	09/10 >				S 4161 CA
with fuel oil heater with connection for water suction / con riscaldatore nafta con collegamento per aspirazione acqua	OM651LA Euro5/EEV	120	163	09/10 >		S 4149 NR		
with fuel oil heater without connection for water suction / con riscaldatore nafta senza collegamento per aspirazione acqua	OM651LA Euro5/EEV	120	163	09/10 >		S 4150 NR		
without fuel oil heater KNECHT-MAHLE / senza riscaldatore nafta KNECHT-MAHLE	OM651LA Euro5/EEV	120	163	09/10 >		S 4112 NR		
without fuel oil heater MANN+HUMMEL / senza riscaldatore nafta MANN+HUMMEL	OM651LA Euro5/EEV	120	163	09/10 >		S 4077 NR		
Sprinter Mobility (906)								
23	OM646DE22LA	65	88	09/06 >	S 5013 PE	S 2320 NR	S 3340 A	S 3137 C
with activated carbons / ai carboni attivi	OM646DE22LA	65	88	09/06 >				S 4161 CA
with facility for water sensor / con predisposizione per sensore acqua	OM646DE22LA	65	88	09/06 >		S 4107 NR		
33	OM646DE22LA	65	88	09/06 >	S 5013 PE	S 2320 NR	S 3340 A	S 3137 C
with activated carbons / ai carboni attivi	OM646DE22LA	65	88	09/06 >				S 4161 CA
with facility for water sensor / con predisposizione per sensore acqua	OM646DE22LA	65	88	09/06 >		S 4107 NR		
Sprinter Transfer (906)								
23	OM646DE22LA	65	88	09/06 >	S 5013 PE	S 2320 NR	S 3340 A	S 3137 C
with activated carbons / ai carboni attivi	OM646DE22LA	65	88	09/06 >				S 4161 CA
with facility for water sensor / con predisposizione per sensore acqua	OM646DE22LA	65	88	09/06 >		S 4107 NR		
23	OM651LA Euro5/EEV	120	163	09/10 >	S 5159 PE		S 3340 A	S 3137 C
with activated carbons / ai carboni attivi	OM651LA Euro5/EEV	120	163	09/10 >				S 4161 CA
with fuel oil heater with connection for water suction / con riscaldatore nafta con collegamento per aspirazione acqua	OM651LA Euro5/EEV	120	163	09/10 >		S 4149 NR		
with fuel oil heater without connection for water suction / con riscaldatore nafta senza collegamento per aspirazione acqua	OM651LA Euro5/EEV	120	163	09/10 >		S 4150 NR		
without fuel oil heater KNECHT-MAHLE / senza riscaldatore nafta KNECHT-MAHLE	OM651LA Euro5/EEV	120	163	09/10 >		S 4112 NR		
without fuel oil heater MANN+HUMMEL / senza riscaldatore nafta MANN+HUMMEL	OM651LA Euro5/EEV	120	163	09/10 >		S 4077 NR		
23	OM651LA Euro5/EEV	95	129	09/10 >	S 5159 PE		S 3340 A	S 3137 C
with activated carbons / ai carboni attivi	OM651LA Euro5/EEV	95	129	09/10 >				S 4161 CA
with fuel oil heater with connection for water suction / con riscaldatore nafta con collegamento per aspirazione acqua	OM651LA Euro5/EEV	95	129	09/10 >		S 4149 NR		
with fuel oil heater without connection for water suction / con riscaldatore nafta senza collegamento per aspirazione acqua	OM651LA Euro5/EEV	95	129	09/10 >		S 4150 NR		
without fuel oil heater KNECHT-MAHLE / senza riscaldatore nafta KNECHT-MAHLE	OM651LA Euro5/EEV	95	129	09/10 >		S 4112 NR		
without fuel oil heater MANN+HUMMEL / senza riscaldatore nafta MANN+HUMMEL	OM651LA Euro5/EEV	95	129	09/10 >		S 4077 NR		
34	OM646DE22LA	80	109	09/06 >	S 5013 PE	S 2320 NR	S 3340 A	S 3137 C
with activated carbons / ai carboni attivi	OM646DE22LA	80	109	09/06 >				S 4161 CA
with facility for water sensor / con predisposizione per sensore acqua	OM646DE22LA	80	109	09/06 >		S 4107 NR		
34	OM651LA Euro5/EEV	120	163	09/10 >	S 5159 PE		S 3340 A	S 3137 C
with activated carbons / ai carboni attivi	OM651LA Euro5/EEV	120	163	09/10 >				S 4161 CA
with fuel oil heater with connection for water suction / con riscaldatore nafta con collegamento per aspirazione acqua	OM651LA Euro5/EEV	120	163	09/10 >		S 4149 NR		
with fuel oil heater without connection for water suction / con riscaldatore nafta senza collegamento per aspirazione acqua	OM651LA Euro5/EEV	120	163	09/10 >		S 4150 NR		
without fuel oil heater KNECHT-MAHLE / senza riscaldatore nafta KNECHT-MAHLE	OM651LA Euro5/EEV	120	163	09/10 >		S 4112 NR		
without fuel oil heater MANN+HUMMEL / senza riscaldatore nafta MANN+HUMMEL	OM651LA Euro5/EEV	120	163	09/10 >		S 4077 NR		
34	OM651LA Euro5/EEV	95	129	09/10 >	S 5159 PE		S 3340 A	S 3137 C
with activated carbons / ai carboni attivi	OM651LA Euro5/EEV	95	129	09/10 >				S 4161 CA

M



kW HP



...MERCEDES BENZ - buses/autobus

55	OM651LA Euro5/EEV	120	163	09/10	>	S 5159 PE		S 3340 A	S 3137 C
with activated carbons / ai carboni attivi	OM651LA Euro5/EEV	120	163	09/10	>				S 4161 CA
with fuel oil heater with connection for water suction / con riscaldatore nafta con collegamento per aspirazione acqua	OM651LA Euro5/EEV	120	163	09/10	>		S 4149 NR		
with fuel oil heater without connection for water suction / con riscaldatore nafta senza collegamento per aspirazione acqua	OM651LA Euro5/EEV	120	163	09/10	>		S 4150 NR		
without fuel oil heater KNECHT-MAHLE / senza riscaldatore nafta KNECHT-MAHLE	OM651LA Euro5/EEV	120	163	09/10	>		S 4112 NR		
without fuel oil heater MANN+HUMMEL / senza riscaldatore nafta MANN+HUMMEL	OM651LA Euro5/EEV	120	163	09/10	>		S 4077 NR		
55	OM651LA Euro5/EEV	95	129	09/10	>	S 5159 PE		S 3340 A	S 3137 C
with activated carbons / ai carboni attivi	OM651LA Euro5/EEV	95	129	09/10	>				S 4161 CA
with fuel oil heater with connection for water suction / con riscaldatore nafta con collegamento per aspirazione acqua	OM651LA Euro5/EEV	95	129	09/10	>		S 4149 NR		
with fuel oil heater without connection for water suction / con riscaldatore nafta senza collegamento per aspirazione acqua	OM651LA Euro5/EEV	95	129	09/10	>		S 4150 NR		
without fuel oil heater KNECHT-MAHLE / senza riscaldatore nafta KNECHT-MAHLE	OM651LA Euro5/EEV	95	129	09/10	>		S 4112 NR		
without fuel oil heater MANN+HUMMEL / senza riscaldatore nafta MANN+HUMMEL	OM651LA Euro5/EEV	95	129	09/10	>		S 4077 NR		
65	OM646DE22LA	110	150	09/06	>	S 5013 PE	S 2320 NR	S 3340 A	S 3137 C
with activated carbons / ai carboni attivi	OM646DE22LA	110	150	09/06	>				S 4161 CA
with facility for water sensor / con predisposizione per sensore acqua	OM646DE22LA	110	150	09/06	>		S 4107 NR		
65	OM651LA Euro5/EEV	120	163	09/10	>	S 5159 PE		S 3340 A	S 3137 C
with activated carbons / ai carboni attivi	OM651LA Euro5/EEV	120	163	09/10	>				S 4161 CA
with fuel oil heater with connection for water suction / con riscaldatore nafta con collegamento per aspirazione acqua	OM651LA Euro5/EEV	120	163	09/10	>		S 4149 NR		
with fuel oil heater without connection for water suction / con riscaldatore nafta senza collegamento per aspirazione acqua	OM651LA Euro5/EEV	120	163	09/10	>		S 4150 NR		
without fuel oil heater KNECHT-MAHLE / senza riscaldatore nafta KNECHT-MAHLE	OM651LA Euro5/EEV	120	163	09/10	>		S 4112 NR		
without fuel oil heater MANN+HUMMEL / senza riscaldatore nafta MANN+HUMMEL	OM651LA Euro5/EEV	120	163	09/10	>		S 4077 NR		
65	OM651LA Euro5/EEV	95	129	09/10	>	S 5159 PE		S 3340 A	S 3137 C
with activated carbons / ai carboni attivi	OM651LA Euro5/EEV	95	129	09/10	>				S 4161 CA
with fuel oil heater with connection for water suction / con riscaldatore nafta con collegamento per aspirazione acqua	OM651LA Euro5/EEV	95	129	09/10	>		S 4149 NR		
with fuel oil heater without connection for water suction / con riscaldatore nafta senza collegamento per aspirazione acqua	OM651LA Euro5/EEV	95	129	09/10	>		S 4150 NR		
without fuel oil heater KNECHT-MAHLE / senza riscaldatore nafta KNECHT-MAHLE	OM651LA Euro5/EEV	95	129	09/10	>		S 4112 NR		
without fuel oil heater MANN+HUMMEL / senza riscaldatore nafta MANN+HUMMEL	OM651LA Euro5/EEV	95	129	09/10	>		S 4077 NR		
Tourino									
O 510	OM906LA	180	245	10/03	>	S 5036 PE	S 6017 NE	S 7423 A	
additional WEBASTO THERMO 300 / addizionale WEBASTO THERMO 300	OM906LA	180	245	10/03	>				S 4378 NR
dryer filter / filtro essiccatore	OM906LA	180	245	10/03	>				S 7259 A
dryer filter WABCO, right-hand thread / filtro essiccatore WABCO, filetto destro	OM906LA	180	245	10/03	>				S 7A66 A
power steering / servosterzo	OM906LA	180	245	10/03	>				S 3081 PO
O 510	OM906LA	205	280	10/03	>	S 5036 PE	S 6017 NE	S 7423 A	
additional WEBASTO THERMO 300 / addizionale WEBASTO THERMO 300	OM906LA	205	280	10/03	>				S 4378 NR
dryer filter / filtro essiccatore	OM906LA	205	280	10/03	>				S 7259 A
dryer filter WABCO, right-hand thread / filtro essiccatore WABCO, filetto destro	OM906LA	205	280	10/03	>				S 7A66 A
power steering / servosterzo	OM906LA	205	280	10/03	>				S 3081 PO
O 510	OM926.939 Euro4/5/EEV	210	285	03/07	>	S 5036 PE	S 6017 NE	S 7423 A	
additional WEBASTO THERMO 300 / addizionale WEBASTO THERMO 300	OM926.939 Euro4/5/EEV	210	285	03/07	>				S 4378 NR
dryer filter / filtro essiccatore	OM926.939 Euro4/5/EEV	210	285	03/07	>				S 7259 A
power steering / servosterzo	OM926.939 Euro4/5/EEV	210	285	03/07	>				S 3081 PO
Tourismo									
O 340.15 SHD	OM457LA Euro3	260	353	09/03	>	S 5062 PE	S 6001 NE	S 1670 A	
additional WEBASTO / addizionale WEBASTO	OM457LA Euro3	260	353	09/03	>		S 7411 N		
dryer filter / filtro essiccatore	OM457LA Euro3	260	353	09/03	>				S 7259 A
power steering / servosterzo	OM457LA Euro3	260	353	09/03	>				S 3081 PO
O 340.15 SHD	OM457LA Euro3	310	422	09/02	>	S 5062 PE	S 6001 NE	S 1670 A	
additional WEBASTO / addizionale WEBASTO	OM457LA Euro3	310	422	09/02	>		S 7411 N		
dryer filter / filtro essiccatore	OM457LA Euro3	310	422	09/02	>				S 7259 A
power steering / servosterzo	OM457LA Euro3	310	422	09/02	>				S 3081 PO
O 350 RHD	OM446.938	280	382	09/95	>	S 5133 PE		S 7546 A	
additional WEBASTO / addizionale WEBASTO	OM446.938	280	382	09/95	>		S 2161 N		
dryer filter / filtro essiccatore	OM446.938	280	382	09/95	>				S 7259 A
2 filters / N.2 filtri	OM446.938	280	382	09/95	>		S 2162 N		
power steering / servosterzo	OM446.938	280	382	09/95	>				S 3081 PO
O 350 RHD/SHD	OM441.980/445.934	250	340	09/95	>	S 5133 PE		S 7546 A	
additional WEBASTO / addizionale WEBASTO	OM441.980/445.934	250	340	09/95	>		S 2161 N		
with air-conditioner / con climatizzatore	OM441.980/445.934	250	340	09/95	>				S 3442 C
spheros aeroshere world / con climatizzatore sul tetto	OM441.980/445.934	250	340	09/95	>				S 3441 C
dryer filter / filtro essiccatore	OM441.980/445.934	250	340	09/95	>				S 7259 A
2 filters / N.2 filtri	OM441.980/445.934	250	340	09/95	>		S 2162 N		
power steering / servosterzo	OM441.980/445.934	250	340	09/95	>				S 3081 PO
O 350 RHD/SHD	OM457.944	260	354	01/03	>	S 5062 PE	S 6001 NE	S 1670 A	
additional WEBASTO / addizionale WEBASTO	OM457.944	260	354	01/03	>		S 7411 N		
dryer filter / filtro essiccatore	OM457.944	260	354	01/03	>				S 7259 A
prefilter PARKER-RACOR / prefiltro PARKER-RACOR	OM457.944	260	354	01/03	>		S 4121 NR		

M



**KW HP****...MERCEDES BENZ - buses/autobus****M**

power steering / servosterzo	OM457.944	260	354	01/03	>				S 3081 PO
O 350 SHD	OM446.938	280	382	09/95	>	S 5133 PE		S 7546 A	
additional WEBASTO / addizionale WEBASTO	OM446.938	280	382	09/95	>		S 2161 N		
dryer filter / filtro essiccatore	OM446.938	280	382	09/95	>				S 7259 A
2 filters / N.2 filtri	OM446.938	280	382	09/95	>		S 2162 N		
power steering / servosterzo	OM446.938	280	382	09/95	>				S 3081 PO
O 350 Turismo	OM402.984/995	280	382	09/92	> 09/95	S 5133 PE		S 7546 A	
dryer filter / filtro essiccatore	OM402.984/995	280	382	09/92	> 09/95				S 7259 A
2 filters / N.2 filtri	OM402.984/995	280	382	09/92	> 09/95		S 2162 N		
power steering / servosterzo	OM402.984/995	280	382	09/92	> 09/95				S 3081 PO
O 350 Turismo	OM442.970	280	381	09/95	>	S 5133 PE		S 7546 A	
additional WEBASTO / addizionale WEBASTO	OM442.970	280	381	09/95	>		S 2161 N		
dryer filter / filtro essiccatore	OM442.970	280	381	09/95	>				S 7259 A
2 filters / N.2 filtri	OM442.970	280	381	09/95	>		S 2162 N		
power steering / servosterzo	OM442.970	280	381	09/95	>				S 3081 PO
O 350 Turismo	OM442LA			09/92	> 09/95	S 5133 PE		S 7546 A	
dryer filter / filtro essiccatore	OM442LA			09/92	> 09/95				S 7259 A
2 filters / N.2 filtri	OM442LA			09/92	> 09/95		S 2162 N		
power steering / servosterzo	OM442LA			09/92	> 09/95				S 3081 PO
O 350.15 RHD	OM457.941	185	252	01/03	>	S 5062 PE	S 6001 NE	S 1670 A	
additional WEBASTO / addizionale WEBASTO	OM457.941	185	252	01/03	>		S 7411 N		
dryer filter / filtro essiccatore	OM457.941	185	252	01/03	>				S 7259 A
prefilter PARKER-RACOR / prefiltro PARKER-RACOR	OM457.941	185	252	01/03	>		S 4121 NR		
power steering / servosterzo	OM457.941	185	252	01/03	>				S 3081 PO
O 350.15 RHD	OM457.941/952/965	220	299	01/03	>	S 5062 PE	S 6001 NE	S 1670 A	
additional WEBASTO / addizionale WEBASTO	OM457.941/952/965	220	299	01/03	>		S 7411 N		
dryer filter / filtro essiccatore	OM457.941/952/965	220	299	01/03	>				S 7259 A
prefilter PARKER-RACOR / prefiltro PARKER-RACOR	OM457.941/952/965	220	299	01/03	>		S 4121 NR		
power steering / servosterzo	OM457.941/952/965	220	299	01/03	>				S 3081 PO
O 350.15 RHD	OM457.941/953/961/965	260	354	01/03	>	S 5062 PE	S 6001 NE	S 1670 A	
additional WEBASTO / addizionale WEBASTO	OM457.941/953/961/965	260	354	01/03	>		S 7411 N		
dryer filter / filtro essiccatore	OM457.941/953/961/965	260	354	01/03	>				S 7259 A
prefilter PARKER-RACOR / prefiltro PARKER-RACOR	OM457.941/953/961/965	260	354	01/03	>		S 4121 NR		
power steering / servosterzo	OM457.941/953/961/965	260	354	01/03	>				S 3081 PO
O 350.15 RHD	OM457.952/965	300	408	01/03	>	S 5062 PE	S 6001 NE	S 1670 A	
additional WEBASTO / addizionale WEBASTO	OM457.952/965	300	408	01/03	>		S 7411 N		
dryer filter / filtro essiccatore	OM457.952/965	300	408	01/03	>				S 7259 A
prefilter PARKER-RACOR / prefiltro PARKER-RACOR	OM457.952/965	300	408	01/03	>		S 4121 NR		
power steering / servosterzo	OM457.952/965	300	408	01/03	>				S 3081 PO
O 350.15 SHD	OM457LA Euro3	260	353	09/03	>	S 5062 PE	S 6001 NE	S 1670 A	
additional WEBASTO / addizionale WEBASTO	OM457LA Euro3	260	353	09/03	>		S 7411 N		
with air-conditioner / con climatizzatore	OM457LA Euro3	260	353	09/03	>				S 3442 C
spheros aeroshere world / con climatizzatore sul tetto	OM457LA Euro3	260	353	09/03	>				S 3442 C
dryer filter / filtro essiccatore	OM457LA Euro3	260	353	09/03	>				S 7259 A
power steering / servosterzo	OM457LA Euro3	260	353	09/03	>				S 3081 PO
O 350.15 SHD	OM457LA Euro3	310	422	09/02	>	S 5062 PE	S 6001 NE	S 1670 A	
additional WEBASTO / addizionale WEBASTO	OM457LA Euro3	310	422	09/02	>		S 7411 N		
with air-conditioner / con climatizzatore	OM457LA Euro3	310	422	09/02	>				S 3442 C
spheros aeroshere world / con climatizzatore sul tetto	OM457LA Euro3	310	422	09/02	>				S 3441 C
dryer filter / filtro essiccatore	OM457LA Euro3	310	422	09/02	>				S 7259 A
power steering / servosterzo	OM457LA Euro3	310	422	09/02	>				S 3081 PO
O 403	OM441.980/445.934	250	340	09/95	>	S 5133 PE		S 7546 A	
additional WEBASTO / addizionale WEBASTO	OM441.980/445.934	250	340	09/95	>		S 2161 N		
with air-conditioner / con climatizzatore	OM441.980/445.934	250	340	09/95	>				S 3442 C
spheros aeroshere world / con climatizzatore sul tetto	OM441.980/445.934	250	340	09/95	>				S 3441 C
dryer filter / filtro essiccatore	OM441.980/445.934	250	340	09/95	>				S 7259 A
2 filters / N.2 filtri	OM441.980/445.934	250	340	09/95	>		S 2162 N		
power steering / servosterzo	OM441.980/445.934	250	340	09/95	>				S 3081 PO
O 403	OM446.938	280	382	09/95	>	S 5133 PE		S 7546 A	
additional WEBASTO / addizionale WEBASTO	OM446.938	280	382	09/95	>		S 2161 N		
spheros aeroshere world / con climatizzatore sul tetto	OM446.938	280	382	09/95	>				S 3442 C
dryer filter / filtro essiccatore	OM446.938	280	382	09/95	>				S 7259 A
2 filters / N.2 filtri	OM446.938	280	382	09/95	>		S 2162 N		
power steering / servosterzo	OM446.938	280	382	09/95	>				S 3081 PO
Tourismo II (632)									
12.1 m	OM457hLA Euro4/5/EEV	260	354	09/06	>		S 6001 NE	S 7573 A	
additional WEBASTO / addizionale WEBASTO	OM457hLA Euro4/5/EEV	260	354	09/06	>		S 4378 NR		



kW HP



...MERCEDES BENZ - buses/autobus

spheros aeroshere world / con climatizzatore sul tetto	OM457hLA Euro4/5/EEV	260	354	09/06	>				S 3444 C
2 filters / N.2 filtri	OM457hLA Euro4/5/EEV	260	354	09/06	>	S 5036 PE			
prefilter PARKER-RACOR / prefiltra PARKER-RACOR	OM457hLA Euro4/5/EEV	260	354	09/06	>		S 4121 NR		
power steering / servosterzo	OM457hLA Euro4/5/EEV	260	354	09/06	>				S 8790 PO
12.1 m	OM457hLA Euro4/5/EEV	300	408	09/06	>		S 6001 NE	S 7573 A	
additional WEBASTO / addizionale WEBASTO	OM457hLA Euro4/5/EEV	300	408	09/06	>		S 4378 NR		
2 filters / N.2 filtri	OM457hLA Euro4/5/EEV	300	408	09/06	>	S 5036 PE			
power steering / servosterzo	OM457hLA Euro4/5/EEV	300	408	09/06	>				S 8790 PO
L 14 m	OM457LA Euro4/5/EEV	315	428	09/06	>	S 5062 PE	S 6001 NE		
additional WEBASTO / addizionale WEBASTO	OM457LA Euro4/5/EEV	315	428	09/06	>		S 4378 NR		
spheros aeroshere world WEBASTO / con climatizzatore sul tetto WEBASTO	OM457LA Euro4/5/EEV	315	428	09/06	>				S 3444 C
additional filter compressor filter / filtro supplementare filtro compressore	OM457LA Euro4/5/EEV	315	428	09/06	>			S 7A14 A	
5 filters / N.5 filtri	OM457LA Euro4/5/EEV	315	428	09/06	>	08/08		S 7695 A	
5 filters / N.5 filtri	OM457LA Euro4/5/EEV	315	428	09/08	>			S 7F31 A	
prefilter PARKER-RACOR / prefiltra PARKER-RACOR	OM457LA Euro4/5/EEV	315	428	09/06	>		S 4121 NR		
power steering / servosterzo	OM457LA Euro4/5/EEV	315	428	09/06	>				S 8790 PO
M 13 m	OM457LA Euro4/5/EEV	315	428	09/06	>	S 5062 PE	S 6001 NE		
additional WEBASTO / addizionale WEBASTO	OM457LA Euro4/5/EEV	315	428	09/06	>		S 4378 NR		
spheros aeroshere world WEBASTO / con climatizzatore sul tetto WEBASTO	OM457LA Euro4/5/EEV	315	428	09/06	>				S 3444 C
additional filter compressor filter / filtro supplementare filtro compressore	OM457LA Euro4/5/EEV	315	428	09/06	>			S 7A14 A	
5 filters / N.5 filtri	OM457LA Euro4/5/EEV	315	428	09/06	>	08/08		S 7695 A	
5 filters / N.5 filtri	OM457LA Euro4/5/EEV	315	428	09/08	>			S 7F31 A	
prefilter PARKER-RACOR / prefiltra PARKER-RACOR	OM457LA Euro4/5/EEV	315	428	09/06	>		S 4121 NR		
power steering / servosterzo	OM457LA Euro4/5/EEV	315	428	09/06	>				S 8790 PO
M/2 13 m	OM457hLA Euro4/5/EEV	260	354	09/06	>		S 6001 NE	S 7573 A	
additional WEBASTO / addizionale WEBASTO	OM457hLA Euro4/5/EEV	260	354	09/06	>		S 4378 NR		
2 filters / N.2 filtri	OM457hLA Euro4/5/EEV	260	354	09/06	>	S 5036 PE			
power steering / servosterzo	OM457hLA Euro4/5/EEV	260	354	09/06	>				S 8790 PO
M/2 13 m	OM457hLA Euro4/5/EEV	300	408	09/06	>		S 6001 NE	S 7573 A	
additional WEBASTO / addizionale WEBASTO	OM457hLA Euro4/5/EEV	300	408	09/06	>		S 4378 NR		
spheros aeroshere world WEBASTO / con climatizzatore sul tetto WEBASTO	OM457hLA Euro4/5/EEV	300	408	09/06	>				S 3444 C
2 filters / N.2 filtri	OM457hLA Euro4/5/EEV	300	408	09/06	>	S 5036 PE			
power steering / servosterzo	OM457hLA Euro4/5/EEV	300	408	09/06	>				S 8790 PO
RH									
additional WEBASTO / addizionale WEBASTO	OM470LA Euro6	265	360	07/13	>		S 4378 NR		
spheros aeroshere world WEBASTO / con climatizzatore sul tetto WEBASTO	OM470LA Euro6	265	360	07/13	>				S 3444 C
RH									
additional WEBASTO / addizionale WEBASTO	OM470LA Euro6	290	394	07/13	>		S 4378 NR		
spheros aeroshere world / con climatizzatore sul tetto	OM470LA Euro6	290	394	07/13	>				S 3444 C
RH-M									
additional WEBASTO / addizionale WEBASTO	OM470LA Euro6	265	360	07/13	>		S 4378 NR		
spheros aeroshere world WEBASTO / con climatizzatore sul tetto WEBASTO	OM470LA Euro6	265	360	07/13	>				S 3444 C
RH-M									
additional WEBASTO / addizionale WEBASTO	OM470LA Euro6	294	390	07/13	>		S 4378 NR		
spheros aeroshere world WEBASTO / con climatizzatore sul tetto WEBASTO	OM470LA Euro6	294	390	07/13	>				S 3444 C
Touro (634)									
Touro	OM457.944LA	265	360	01/03	>				S 3440 C
dryer filter / filtro essiccatore	OM457.944LA	265	360	01/03	>				S 7259 A
assembly DONALDSON / montaggio DONALDSON	OM457.944LA	265	360	01/03	>	S 5062 PE	S 6001 NE	S 7608 A	
assembly MANN+HUMMEL / montaggio MANN+HUMMEL	OM457.944LA	265	360	01/03	>	S 5062 PE	S 6001 NE	S 7573 A	
power steering / servosterzo	OM457.944LA	265	360	01/03	>				S 3081 PO
automatic drive ZF 5HP602C/6HP602C / trasmissione automatica ZF 5HP602C/6HP602C	OM457.944LA	265	360	01/03	>				S 2234 Z
Touro	OM457.944LA	310	423	01/03	>				S 3440 C
dryer filter / filtro essiccatore	OM457.944LA	310	423	01/03	>				S 7259 A
assembly DONALDSON / montaggio DONALDSON	OM457.944LA	310	423	01/03	>	S 5062 PE	S 6001 NE	S 7608 A	
assembly MANN+HUMMEL / montaggio MANN+HUMMEL	OM457.944LA	310	423	01/03	>	S 5062 PE	S 6001 NE	S 7573 A	
power steering / servosterzo	OM457.944LA	310	423	01/03	>				S 3081 PO
automatic drive ZF 5HP602C/6HP602C / trasmissione automatica ZF 5HP602C/6HP602C	OM457.944LA	310	423	01/03	>				S 2234 Z
Travego									
L (632)									
additional WEBASTO / addizionale WEBASTO	OM471.902	350	476	02/12	>		S 4378 NR		
M Edition 1 (632)									
additional WEBASTO / addizionale WEBASTO	OM471.902	350	476	02/12	>		S 4378 NR		
O 580.15 RH/RHD (629)	OM457LA	260	354	11/99	>	12/06	S 5062 PE	S 6001 NE	
additional WEBASTO / addizionale WEBASTO	OM457LA	260	354	11/99	>	12/06		S 4378 NR	
some / alcuni	OM457LA	260	354	11/99	>	12/06			S 1670 A
some / alcuni	OM457LA	260	354	11/99	>	12/06			S 7573 A

M





KW HP



...MERCEDES BENZ - buses/autobus

M



spheros aeroshere world / con climatizzatore sul tetto	OM457LA	260	354	11/99	>	12/06				S 3444 C
with air-conditioner WEBASTO Aerosphere / con climatizzatore WEBASTO Aerosphere	OM457LA	260	354	11/99	>	12/06	S 5062 PE	S 6001 NE		S 3081 C
dryer filter / filtro essiccatore	OM457LA	260	354	11/99	>	12/06				S 7259 A
power steering / servosterzo	OM457LA	260	354	11/99	>	12/06				S 3081 PO
O 580.15 RH/RHD (629)	OM457LA	300	408	11/99	>	12/06	S 5062 PE	S 6001 NE		
additional WEBASTO / addizionale WEBASTO	OM457LA	300	408	11/99	>	12/06		S 4378 NR		
some / alcuni	OM457LA	300	408	11/99	>	12/06			S 1670 A	
spheros aeroshere world / con climatizzatore sul tetto	OM457LA	300	408	11/99	>	12/06				S 3444 C
with air-conditioner WEBASTO Aerosphere / con climatizzatore WEBASTO Aerosphere	OM457LA	300	408	11/99	>	12/06	S 5062 PE	S 6001 NE		S 3081 C
dryer filter / filtro essiccatore	OM457LA	300	408	11/99	>	12/06				S 7259 A
power steering / servosterzo	OM457LA	300	408	11/99	>	12/06				S 3081 PO
O 580.15 RH/RHD (629)	OM457LA	310	420	11/99	>	12/06	S 5062 PE	S 6001 NE		
additional WEBASTO / addizionale WEBASTO	OM457LA	310	420	11/99	>	12/06		S 4378 NR		
some / alcuni	OM457LA	310	420	11/99	>	12/06			S 1670 A	
spheros aeroshere world WEBASTO / con climatizzatore sul tetto WEBASTO	OM457LA	310	420	11/99	>	12/06				S 3444 C
with air-conditioner WEBASTO Aerosphere / con climatizzatore WEBASTO Aerosphere	OM457LA	310	420	11/99	>	12/06	S 5062 PE	S 6001 NE		S 3081 C
dryer filter / filtro essiccatore	OM457LA	310	420	11/99	>	12/06				S 7259 A
power steering / servosterzo	OM457LA	310	420	11/99	>	12/06				S 3081 PO
O 580.15 RHD (632)	OM457LA Euro4/5/EEV	315	428	09/06	>		S 5006 PE	S 6001 NE		
additional WEBASTO / addizionale WEBASTO	OM457LA Euro4/5/EEV	315	428	09/06	>			S 4378 NR		
spheros aeroshere world WEBASTO / con climatizzatore sul tetto WEBASTO	OM457LA Euro4/5/EEV	315	428	09/06	>					S 3444 C
additional filter compressor filter / filtro supplementare filtro compressore	OM457LA Euro4/5/EEV	315	428	09/06	>				S 7A14 A	
5 filters / N.5 filtri	OM457LA Euro4/5/EEV	315	428	09/06	>	08/08			S 7695 A	
5 filters / N.5 filtri	OM457LA Euro4/5/EEV	315	428	09/08	>				S 7F31 A	
prefilter PARKER-RACOR / prefilto PARKER-RACOR	OM457LA Euro4/5/EEV	315	428	09/06	>			S 4121 NR		
power steering / servosterzo	OM457LA Euro4/5/EEV	315	428	09/06	>					S 3081 PO
O 580.16 RHD (632)	OM457LA Euro4/5/EEV	315	428	09/06	>		S 5062 PE	S 6001 NE		
additional WEBASTO / addizionale WEBASTO	OM457LA Euro4/5/EEV	315	428	09/06	>			S 4378 NR		
additional filter compressor filter / filtro supplementare filtro compressore	OM457LA Euro4/5/EEV	315	428	09/06	>				S 7A14 A	
5 filters / N.5 filtri	OM457LA Euro4/5/EEV	315	428	09/06	>	08/08			S 7695 A	
5 filters / N.5 filtri	OM457LA Euro4/5/EEV	315	428	09/08	>				S 7F31 A	
prefilter PARKER-RACOR / prefilto PARKER-RACOR	OM457LA Euro4/5/EEV	315	428	09/06	>			S 4121 NR		
power steering / servosterzo	OM457LA Euro4/5/EEV	315	428	09/06	>					S 3081 PO
O 580.16 RHD (632)	OM502LA Euro4/5/EEV	350	476	09/06	>		S 5006 PE	S 6001 NE		
additional WEBASTO / addizionale WEBASTO	OM502LA Euro4/5/EEV	350	476	09/06	>			S 4378 NR		
spheros aeroshere world WEBASTO / con climatizzatore sul tetto WEBASTO	OM502LA Euro4/5/EEV	350	476	09/06	>				S 7695 A	S 3444 C
5 filters / N.5 filtri	OM502LA Euro4/5/EEV	350	476	09/06	>	08/08			S 7F31 A	
5 filters / N.5 filtri	OM502LA Euro4/5/EEV	350	476	09/08	>					
prefilter PARKER-RACOR / prefilto PARKER-RACOR	OM502LA Euro4/5/EEV	350	476	09/06	>			S 4121 NR		
power steering / servosterzo	OM502LA Euro4/5/EEV	350	476	09/06	>					S 3081 PO
O 580.17 RHD (629)	OM502LA	300	408	11/99	>	12/06	S 5006 PE	S 6001 NE	S 7213 A	
additional WEBASTO / addizionale WEBASTO	OM502LA	300	408	11/99	>	12/06		S 4378 NR		
spheros aeroshere world WEBASTO / con climatizzatore sul tetto WEBASTO	OM502LA	300	408	11/99	>	12/06				S 3444 C
with air-conditioner WEBASTO Aerosphere / con climatizzatore WEBASTO Aerosphere	OM502LA	300	408	01/04	>	12/06				S 3081 C
dryer filter / filtro essiccatore	OM502LA	300	408	11/99	>	12/06				S 7259 A
power steering / servosterzo	OM502LA	300	408	11/99	>	12/06				S 3081 PO
O 580.17 RHD (629)	OM502LA	320	436	11/99	>	12/06	S 5006 PE	S 6001 NE	S 7213 A	
additional WEBASTO / addizionale WEBASTO	OM502LA	320	436	11/99	>	12/06		S 4378 NR		
spheros aeroshere world WEBASTO / con climatizzatore sul tetto WEBASTO	OM502LA	320	436	11/99	>	12/06				S 3444 C
with air-conditioner WEBASTO Aerosphere / con climatizzatore WEBASTO Aerosphere	OM502LA	320	436	01/04	>	12/06				S 3081 C
dryer filter / filtro essiccatore	OM502LA	320	436	11/99	>	12/06				S 7259 A
power steering / servosterzo	OM502LA	320	436	11/99	>	12/06				S 3081 PO
O 580.17 RHD (629)	OM502LA	350	476	11/99	>	12/06	S 5006 PE	S 6001 NE	S 7213 A	
additional WEBASTO / addizionale WEBASTO	OM502LA	350	476	11/99	>	12/06		S 4378 NR		
spheros aeroshere world WEBASTO / con climatizzatore sul tetto WEBASTO	OM502LA	350	476	11/99	>	12/06				S 3444 C
with air-conditioner WEBASTO Aerosphere / con climatizzatore WEBASTO Aerosphere	OM502LA	350	476	01/04	>	12/06				S 3081 C
dryer filter / filtro essiccatore	OM502LA	350	476	11/99	>	12/06				S 7259 A
power steering / servosterzo	OM502LA	350	476	11/99	>	12/06				S 3081 PO
O 580.17 RHD (632)	OM457LA Euro4/5/EEV	315	428	09/06	>		S 5062 PE	S 6001 NE		
additional WEBASTO / addizionale WEBASTO	OM457LA Euro4/5/EEV	315	428	09/06	>			S 4378 NR		
spheros aeroshere world WEBASTO / con climatizzatore sul tetto WEBASTO	OM457LA Euro4/5/EEV	315	428	09/06	>					S 3444 C
additional filter compressor filter / filtro supplementare filtro compressore	OM457LA Euro4/5/EEV	315	428	09/06	>				S 7A14 A	
5 filters / N.5 filtri	OM457LA Euro4/5/EEV	315	428	09/06	>	08/08			S 7695 A	
5 filters / N.5 filtri	OM457LA Euro4/5/EEV	315	428	09/08	>				S 7F31 A	
prefilter PARKER-RACOR / prefilto PARKER-RACOR	OM457LA Euro4/5/EEV	315	428	09/06	>			S 4121 NR		
power steering / servosterzo	OM457LA Euro4/5/EEV	315	428	09/06	>					S 3081 PO
O 580.17 RHD (632)	OM502LA Euro4/5/EEV	350	476	09/06	>		S 5006 PE	S 6001 NE		



kW HP



...MERCEDES BENZ - buses/autobus

additional WEBASTO / addizionale WEBASTO	OM502LA Euro4/5/EEV	350	476	09/06 >		S 4378 NR		
spheros aeroshere world / con climatizzatore sul tetto	OM502LA Euro4/5/EEV	350	476	09/06 >				S 3444 C
5 filters / N.5 filtri	OM502LA Euro4/5/EEV	350	476	09/06 >	08/08		S 7695 A	
5 filters / N.5 filtri	OM502LA Euro4/5/EEV	350	476	09/08 >			S 7F31 A	
prefilter PARKER-RACOR / prefiltro PARKER-RACOR	OM502LA Euro4/5/EEV	350	476	09/06 >		S 4121 NR		
power steering / servosterzo	OM502LA Euro4/5/EEV	350	476	09/06 >				S 3081 PO

MERCEDES BENZ UNIMOG

trucks/autocarri

U Serie (403)

U 54	OM314			04/66 >	12/76	S 4000 O	S 2161 N	
some / alcuni	OM314			04/66 >	12/76	S 4000 O	S 2161 N	S 1070 A
U 66	OM314			04/69 >	12/75	S 4000 O	S 2161 N	
some / alcuni	OM314			04/69 >	12/75	S 4000 O	S 2161 N	S 1070 A
U 72	OM314			01/76 >	12/76	S 4000 O	S 2161 N	
some / alcuni	OM314			01/76 >	12/76	S 4000 O	S 2161 N	S 1070 A
U 800	OM314			01/77 >	12/77	S 4000 O	S 2161 N	
some / alcuni	OM314			01/78 >	05/88	S 5099 PE	S 2161 N	
some / alcuni	OM314			01/77 >	12/77	S 4000 O	S 2161 N	S 1070 A
U 800 L	OM314			01/77 >	12/77	S 4000 O	S 2161 N	
some / alcuni	OM314			01/78 >	05/88	S 5099 PE	S 2161 N	
some / alcuni	OM314			01/77 >	12/77	S 4000 O	S 2161 N	S 1070 A
some / alcuni	OM314			01/78 >	05/88	S 5099 PE	S 2161 N	S 1070 A

U Serie (404.1)

U 60	OM615			01/55 >	12/70	S 4000 O		
some / alcuni	OM615			01/55 >	12/70	S 4000 O	S 2161 N	
U 80	M180			01/55 >	12/58	S 3081 PO		
U 82	M180			01/55 >	12/58	S 3081 PO		

U Serie (405)

U 20	OM904LA	110	150	01/06 >		S 5007 PE	S 6017 NE	S 7694 A
dryer filter / filtro essiccatore	OM904LA	110	150	01/06 >				S 7F24 A
power steering / servosterzo	OM904LA	110	150	01/06 >				S 3081 PO
U 216	OM934LA	115	156	05/13 >			S 6148 NE	
dryer filter / filtro essiccatore	OM934LA	115	156	05/13 >				S 7F24 A
power steering / servosterzo	OM934LA	115	156	05/13 >				S 3081 PO
U 218	OM934LA	130	177	05/13 >			S 6148 NE	
dryer filter / filtro essiccatore	OM934LA	130	177	05/13 >				S 7F24 A
power steering / servosterzo	OM934LA	130	177	05/13 >				S 3081 PO
U 300	OM904LA	110	150	04/00 >		S 5007 PE	S 6017 NE	S 8502 A
with manual pump prefilter / con pompa manuale prefiltro	OM904LA	110	150	04/00 >			S 6089 NE	
dryer filter / filtro essiccatore	OM904LA	110	150	04/00 >				S 7F24 A
dryer filter / filtro essiccatore	OM904LA	110	150	04/00 >				S 7259 A
U 300	OM904LA	130	177	04/00 >		S 5007 PE	S 6017 NE	S 8502 A
dryer filter / filtro essiccatore	OM904LA	130	177	04/00 >				S 7259 A
U 318	OM934LA	130	177	05/13 >			S 6148 NE	
dryer filter / filtro essiccatore	OM934LA	130	177	05/13 >				S 7F24 A
power steering / servosterzo	OM934LA	130	177	05/13 >				S 3081 PO
U 400	OM904LA	130	177	04/00 >		S 5007 PE	S 6017 NE	S 8502 A
with manual pump prefilter / con pompa manuale prefiltro	OM904LA	130	177	04/00 >			S 6089 NE	
dryer filter / filtro essiccatore	OM904LA	130	177	04/00 >				S 7259 A
dryer filter / filtro essiccatore	OM904LA	130	177	04/00 >				S 7F24 A
U 400	OM906LA	170	230	04/00 >		S 5036 PE	S 6017 NE	S 0450 A
with manual pump prefilter / con pompa manuale prefiltro	OM906LA	170	230	04/00 >			S 6089 NE	
dryer filter / filtro essiccatore	OM906LA	170	230	04/00 >				S 7259 A
dryer filter / filtro essiccatore	OM906LA	170	230	04/00 >				S 7F24 A
inner / interno	OM906LA	170	230	04/00 >				S 1450 A
U 423	OM934LA	170	231	05/13 >			S 6148 NE	
dryer filter / filtro essiccatore	OM934LA	170	231	05/13 >				S 7F24 A
power steering / servosterzo	OM934LA	170	231	05/13 >				S 3081 PO
U 423 L	OM934LA	170	231	05/13 >			S 6148 NE	
dryer filter / filtro essiccatore	OM934LA	170	231	05/13 >				S 7F24 A
power steering / servosterzo	OM934LA	170	231	05/13 >				S 3081 PO
U 500	OM906LA	170	230	10/00 >		S 5036 PE	S 6017 NE	S 0450 A
with manual pump prefilter / con pompa manuale prefiltro	OM906LA	170	230	10/00 >			S 6089 NE	
dryer filter / filtro essiccatore	OM906LA	170	230	10/00 >				S 7259 A
inner / interno	OM906LA	170	230	10/00 >				S 1450 A
U 500	OM906LA	205	280	10/00 >		S 5036 PE	S 6017 NE	S 0450 A

M





kW HP



...MERCEDES BENZ UNIMOG - trucks/autocarri

M



with manual pump prefilter / con pompa manuale prefiltro	OM906LA	205 280	10/00 >		S 6089 NE		S 7259 A
dryer filter / filtro essiccatore	OM906LA	205 280	10/00 >				
inner / interno	OM906LA	205 280	10/00 >			S 1450 A	
U Serie (406)							
U 70	OM352		05/66 > 04/69	S 4000 O	S 2161 N		
some / alcuni	OM352		05/66 > 04/69	S 4000 O	S 2161 N	S 1070 A	
U 80	OM352		05/69 > 12/75	S 4000 O	S 2161 N		
some / alcuni	OM352		05/69 > 12/75	S 4000 O	S 2161 N	S 1070 A	
U 84	OM353.902 (352)		05/69 > 12/76	S 4000 O	S 2161 N		
some / alcuni	OM353.902 (352)		05/69 > 12/76	S 4000 O	S 2161 N	S 1070 A	
U 900	OM353.902 (OM352)		01/75 > 05/88		S 2161 N	S 1070 A	
some / alcuni	OM353.902 (OM352)		01/79 > 05/88	S 5124 PE	S 2161 N	S 1070 A	
U 900	OM353.940 (OM352)		01/77 > 05/88		S 2161 N	S 1070 A	
some / alcuni	OM353.940 (OM352)		01/79 > 05/88	S 5124 PE	S 2161 N	S 1070 A	
U Serie (407)							
U 600	OM616		06/88 >	S 2510 O	S 2161 N	S 1070 A	
U 600 L	OM616		06/88 >	S 2510 O	S 2161 N	S 1070 A	
U 600 T	OM616		06/88 >	S 2510 O	S 2161 N	S 1070 A	
U 650	OM616		06/88 >	S 2510 O	S 2161 N	S 1070 A	
U Serie (408)							
U 100	OM602D29		11/92 >	S 7510 O	S 9600 NR	S 0950 A	
dryer filter / filtro essiccatore	OM602D29		01/92 >			S 7F24 A	
inner / interno	OM602D29		11/92 >			S 1940 A	
U 100 L	OM602D29		11/92 >	S 7510 O	S 9600 NR	S 0950 A	
dryer filter / filtro essiccatore	OM602D29		11/92 >			S 7F24 A	
inner / interno	OM602D29		11/92 >			S 1940 A	
U 100 L Turbo	OM602D29LA		01/97 >	S 5095 PE	S 9600 NR	S 0950 A	
dryer filter / filtro essiccatore	OM602D29LA		01/97 >			S 7F24 A	
inner / interno	OM602D29LA		01/97 >			S 1940 A	
U 90	OM602D29		11/92 >	S 7510 O	S 9600 NR	S 0950 A	
dryer filter / filtro essiccatore	OM602D29		11/92 >			S 7F24 A	
inner / interno	OM602D29		11/92 >			S 1940 A	
U 90 Turbo	OM602D29LA		01/97 >	S 5095 PE	S 9600 NR	S 0950 A	
dryer filter / filtro essiccatore	OM602D29LA		01/97 >			S 7F24 A	
inner / interno	OM602D29LA		01/97 >			S 1940 A	
U Serie (409.100)							
UX 100 H	OM602DE29LA		08/96 >	S 5095 PE	S 9600 NR	S 7516 A	
U Serie (409.101)							
UX 100 M	OM602DE29LA		01/99 >	S 5095 PE	S 9600 NR	S 7516 A	
U Serie (411)							
U 32	OM636		08/56 > 10/74		S 2161 N		
U 34	OM636		08/56 > 09/75		S 2161 N		
UL 32	OM636		08/56 > 10/74		S 2161 N		
UL 34	OM636		08/56 > 09/75		S 2161 N		
U Serie (413)							
U 72	OM314		04/69 > 12/76	S 4000 O	S 2161 N		
some / alcuni	OM314		04/69 > 12/76	S 4000 O	S 2161 N	S 1070 A	
U 80	OM314		04/69 > 12/76	S 4000 O	S 2161 N		
some / alcuni	OM314		04/69 > 12/76	S 4000 O	S 2161 N	S 1070 A	
U 800	OM314		01/77 > 12/77	S 4000 O	S 2161 N		
some / alcuni	OM314		01/78 > 05/88	S 5099 PE	S 2161 N		
some / alcuni	OM314		01/77 > 12/77	S 4000 O	S 2161 N	S 1070 A	
some / alcuni	OM314		01/78 > 05/88	S 5099 PE	S 2161 N	S 1070 A	
U 800 L	OM314		01/77 > 12/77	S 4000 O	S 2161 N		
some / alcuni	OM314		01/78 > 05/88	S 5099 PE	S 2161 N		
some / alcuni	OM314		01/77 > 12/77	S 4000 O	S 2161 N	S 1070 A	
some / alcuni	OM314		01/78 > 05/88	S 5099 PE	S 2161 N	S 1070 A	
U Serie (416)							
U 100	OM353.901 (OM352)		05/69 > 12/76	S 4000 O	S 2161 N		
some / alcuni	OM353.901 (OM352)		05/69 > 12/76	S 4000 O	S 2161 N	S 1070 A	
U 100	OM353.940 (OM352)		05/69 > 12/76	S 4000 O	S 2161 N		
some / alcuni	OM353.940 (OM352)		05/69 > 12/76	S 4000 O	S 2161 N	S 1070 A	
U 100 T	OM353.901 (OM352)		05/69 > 12/76	S 4000 O	S 2161 N		
some / alcuni	OM353.901 (OM352)		05/69 > 12/76	S 4000 O	S 2161 N	S 1070 A	
U 100 T	OM353.940 (OM352)		05/69 > 12/76	S 4000 O	S 2161 N		
some / alcuni	OM353.940 (OM352)		05/69 > 12/76	S 4000 O	S 2161 N	S 1070 A	
U 110	OM353.940 (OM352)		06/72 > 12/76	S 4000 O	S 2161 N		

**kw HP****...MERCEDES BENZ UNIMOG - trucks/autocarri**

some / alcuni	OM353.940 (OM352)	06/72 > 12/76	S 4000 O	S 2161 N	S 1070 A	
U 110 T	OM353.940 (OM352)	06/72 > 12/76	S 4000 O	S 2161 N		
some / alcuni	OM353.940 (OM352)	06/72 > 12/76	S 4000 O	S 2161 N	S 1070 A	
U 1100	OM353.940 (OM352)	01/77 > 05/88		S 2161 N	S 1070 A	
some / alcuni	OM353.940 (OM352)	01/78 > 05/88	S 5124 PE	S 2161 N	S 1070 A	
U 1100 L	OM353.907 (OM352)	01/77 > 01/88		S 2161 N	S 1070 A	
some / alcuni	OM353.907 (OM352)	01/78 > 01/88	S 5124 PE	S 2161 N	S 1070 A	
U 1100 L	OM353.940 (OM352)	01/77 > 05/88		S 2161 N	S 1070 A	
some / alcuni	OM353.940 (OM352)	01/78 > 05/88	S 5124 PE	S 2161 N	S 1070 A	
U 1100 T	OM353.940 (OM352)	01/77 > 05/88		S 2161 N	S 1070 A	
some / alcuni	OM353.940 (OM352)	01/78 > 05/88	S 5124 PE	S 2161 N	S 1070 A	
U 125	OM353.907 (OM352)	10/70 > 12/76	S 4000 O	S 2161 N		
some / alcuni	OM353.907 (OM352)	10/70 > 12/76	S 4000 O	S 2161 N	S 1070 A	
U 80	OM352	05/69 > 12/76	S 4000 O	S 2161 N		
some / alcuni	OM352	05/69 > 12/76	S 4000 O	S 2161 N	S 1070 A	
U 80 T	OM352	05/69 > 12/76	S 4000 O	S 2161 N		
some / alcuni	OM352	05/69 > 12/76	S 4000 O	S 2161 N	S 1070 A	
U 90	OM352	05/69 > 12/76	S 4000 O	S 2161 N		
some / alcuni	OM352	05/69 > 12/76	S 4000 O	S 2161 N	S 1070 A	
U 90 T	OM352	05/69 > 12/76	S 4000 O	S 2161 N		
some / alcuni	OM352	05/69 > 12/76	S 4000 O	S 2161 N	S 1070 A	
U Serie (417)						
U 1150	OM353.940 (OM352)	05/88 >		S 2161 N	S 1070 A	
some / alcuni	OM353.940 (OM352)	05/88 >	S 5124 PE	S 2161 N	S 1070 A	
U 1150 L	OM353.940 (OM352)	05/88 >		S 2161 N	S 1070 A	
some / alcuni	OM353.940 (OM352)	05/88 >	S 5124 PE	S 2161 N	S 1070 A	
U 1150 T	OM353.940 (OM352)	05/88 >		S 2161 N	S 1070 A	
some / alcuni	OM353.940 (OM352)	05/88 >	S 5124 PE	S 2161 N	S 1070 A	
U 800	OM314	01/77 > 12/77	S 4000 O	S 2161 N		
	OM314	01/78 > 05/88	S 5099 PE	S 2161 N		
some / alcuni	OM314	01/77 > 12/77	S 4000 O	S 2161 N	S 1070 A	
some / alcuni	OM314	01/78 > 05/88	S 5099 PE	S 2161 N	S 1070 A	
U 800 L	OM314	01/77 > 12/77	S 4000 O	S 2161 N		
	OM314	01/78 > 05/88	S 5099 PE	S 2161 N		
some / alcuni	OM314	01/77 > 12/77	S 4000 O	S 2161 N	S 1070 A	
some / alcuni	OM314	01/78 > 05/88	S 5099 PE	S 2161 N	S 1070 A	
U 900	OM366.939 81 110	11/88 >		S 2161 N	S 1070 A	
to engine No. 127492-286114 / a motore N. 127492-286114	OM366.939 81 110	11/88 >	S 5099 PE			
from engine No. 286115 / da motore N. 286115	OM366.939 81 110	11/88 >	S 5131 PE			
U Serie (418)						
U 110	OM364.955 (OM364A)	07/92 >	S 5099 PE	S 2161 N	S 2450 A	
dryer filter / filtro essiccatore	OM364.955 (OM364A)	07/92 >			S 7F24 A	
inner / interno	OM364.955 (OM364A)	07/92 >			S 3940 A	
U 110 L	OM364.955 (OM364A)	07/92 >	S 5099 PE	S 2161 N	S 2450 A	
inner / interno	OM364.955 (OM364A)	07/92 >			S 3940 A	
U 130	OM364.982 (OM364LA)	07/92 >	S 5099 PE	S 2161 N	S 2450 A	
inner / interno	OM364.982 (OM364LA)	07/92 >			S 3940 A	
U 130 T	OM364.982 (OM364LA)	07/92 >	S 5099 PE	S 2161 N	S 2450 A	
inner / interno	OM364.982 (OM364LA)	07/92 >			S 3940 A	
U 140	OM364.982 (OM364LA)	07/92 >	S 5099 PE	S 2161 N	S 2450 A	
dryer filter / filtro essiccatore	OM364.982 (OM364LA)	07/92 >			S 7F24 A	
inner / interno	OM364.982 (OM364LA)	07/92 >			S 3940 A	
U 140 L	OM364.982 (OM364LA)	07/92 >	S 5099 PE	S 2161 N	S 2450 A	
inner / interno	OM364.982 (OM364LA)	07/92 >			S 3940 A	
U Serie (421)						
U 40	OM615	01/66 > 04/71	S 4000 O	S 2161 N		
U 40	OM621	01/66 > 04/71	S 4000 O	S 2161 N		
U 40 A	OM615	01/66 > 04/71	S 4000 O	S 2161 N		
U 40 A	OM621	01/66 > 04/71	S 4000 O	S 2161 N		
U 40 T	OM615	01/66 > 04/71	S 4000 O	S 2161 N		
U 45	OM615	02/66 > 12/71	S 4000 O	S 2161 N		
U 45	OM621	02/66 > 12/71	S 4000 O	S 2161 N		
U 52	OM616	05/69 > 12/76	S 4000 O	S 2161 N		
U 55	OM615	01/68 > 12/71	S 4000 O	S 2161 N		
U 55 T	OM615	01/68 > 12/71	S 4000 O	S 2161 N		
U 60	OM616	05/69 > 12/76	S 4000 O	S 2161 N		
U 60 T	OM616	05/69 > 12/76	S 4000 O	S 2161 N		

M



kW HP



...MERCEDES BENZ UNIMOG - trucks/autocarri

U 600	OM616			01/77 > 06/79	S 4000 O	S 2161 N		
	OM616			07/79 > 05/88	S 2510 O	S 2161 N		
U 600 L	OM616			01/77 > 06/79	S 4000 O	S 2161 N		
	OM616			07/79 > 05/88	S 2510 O	S 2161 N		
U 600 T	OM616			01/77 > 06/79	S 4000 O	S 2161 N		
	OM616			07/79 > 05/88	S 2510 O	S 2161 N		
UO 40	OM615			01/66 > 04/71	S 4000 O	S 2161 N		
UO 40	OM621			01/66 > 04/71	S 4000 O	S 2161 N		
U Serie (424)								
U 1000	OM353.962 (OM352)			01/77 > 05/88	S 5124 PE	S 2161 N	S 7998 A	
	some / alcuni	OM353.962 (OM352)		01/77 > 05/88	S 5124 PE	S 2161 N	S 1070 A	
	prefilter / prefiltrato	OM353.962 (OM352)		01/77 > 05/88		S 1013 B		
U 1000 T	OM353.962 (OM352)			01/77 > 05/88	S 5124 PE	S 2161 N	S 7998 A	
	some / alcuni	OM353.962 (OM352)		01/77 > 05/88	S 5124 PE	S 2161 N	S 1070 A	
	prefilter / prefiltrato	OM353.962 (OM352)		01/77 > 05/88		S 1013 B		
U 1200	OM353.958 (OM352/3)			04/83 > 05/88	S 5099 PE	S 2161 N	S 7998 A	
U 1200	OM353.961 (OM352)			04/83 > 05/88	S 5099 PE	S 2161 N	S 7998 A	
	some / alcuni	OM353.961 (OM352)		04/83 > 05/88	S 5124 PE	S 2161 N	S 7998 A	
U 1200	OM353.995 (OM352A)			02/82 > 05/88	S 5099 PE	S 2161 N	S 7998 A	
U 1200 L	OM353.958 (OM352/3)			04/83 > 05/88	S 5099 PE	S 2161 N	S 7998 A	
	some / alcuni	OM353.961 (OM352)		04/83 > 05/88	S 5124 PE	S 2161 N	S 7998 A	
U 1200 L	OM353.995 (OM352A)			02/82 > 05/88	S 5099 PE	S 2161 N	S 7998 A	
U 1200 T	OM353.961 (OM352)			04/83 > 05/88	S 5099 PE	S 2161 N	S 7998 A	
	some / alcuni	OM353.961 (OM352)		04/83 > 05/88	S 5124 PE	S 2161 N	S 7998 A	
U 1200 T	OM353.995 (OM352A)			02/82 > 05/88	S 5099 PE	S 2161 N	S 7998 A	
U 1250	OM353.995 (OM352A)			12/84 > 05/88	S 5099 PE	S 2161 N	S 7998 A	
U 1550	OM353.958 (OM352/3)			04/86 > 05/88	S 5124 PE	S 2161 N	S 7998 A	
	some / alcuni	OM353.958 (OM352/3)		04/86 > 05/88	S 2530 PO	S 2161 N	S 7998 A	
U 95	OM353.962 (OM352)			10/76 > 12/76	S 5124 PE	S 2161 N	S 7998 A	
	some / alcuni	OM353.962 (OM352)		10/76 > 12/76	S 5124 PE	S 2161 N	S 1070 A	
U Serie (425)								
U 120	OM353.960 (OM352)			01/76 > 12/76	S 5099 PE	S 2161 N	S 7998 A	
U 120	OM353.973 (OM352A)			07/76 > 12/76	S 5099 PE	S 2161 N	S 7998 A	
U 1300	OM353.960 (OM352)			01/77 > 06/78	S 5099 PE	S 2161 N	S 7998 A	
U 1300	OM353.973 (OM352A)			01/77 > 01/79	S 5099 PE	S 2161 N	S 7998 A	
	some / alcuni	OM353.973 (OM352A)		02/79 > 05/88	S 5124 PE	S 2161 N	S 7998 A	
		OM353.973 (OM352A)		02/79 > 05/88	S 2530 PO	S 2161 N	S 7998 A	
U 1300	OM353.995 (OM352A)			01/77 > 12/84	S 5099 PE	S 2161 N	S 7998 A	
some / alcuni	OM353.995 (OM352A)			01/77 > 12/84	S 5124 PE	S 2161 N	S 7998 A	
U 1300 L	OM353.960 (OM352)			01/77 > 06/78	S 5099 PE	S 2161 N	S 7998 A	
U 1300 L	OM353.973 (OM352A)			01/77 > 01/79		S 2161 N	S 7998 A	
	some / alcuni	OM353.973 (OM352A)		02/79 > 05/88	S 5124 PE	S 2161 N	S 7998 A	
		OM353.973 (OM352A)		02/79 > 05/88	S 2530 PO	S 2161 N	S 7998 A	
U 1300 L	OM353.995 (OM352A)			01/77 > 12/84	S 5099 PE	S 2161 N	S 7998 A	
some / alcuni	OM353.995 (OM352A)			01/77 > 12/84	S 5124 PE	S 2161 N	S 7998 A	
U 150	OM353.958 (OM352/3)			04/76 > 12/76	S 5099 PE	S 2161 N	S 7998 A	
U 1500	OM353.958 (OM352/3)			01/77 > 01/79	S 5099 PE	S 2161 N	S 7998 A	
	some / alcuni	OM353.958 (OM352/3)		02/79 > 05/88	S 5124 PE	S 2161 N	S 7998 A	
		OM353.958 (OM352/3)		02/79 > 05/88	S 2530 PO	S 2161 N	S 7998 A	
U 1500 L	OM353.958 (OM352/3)			01/77 > 01/79	S 5099 PE	S 2161 N	S 7998 A	
	some / alcuni	OM353.958 (OM352/3)		02/79 > 05/88	S 5124 PE	S 2161 N	S 7998 A	
		OM353.958 (OM352/3)		02/79 > 05/88	S 2530 PO	S 2161 N	S 7998 A	
U 1500 T	OM353.958 (OM352/3)			01/77 > 01/79	S 5099 PE	S 2161 N	S 7998 A	
	some / alcuni	OM353.958 (OM352/3)		02/79 > 05/88	S 5124 PE	S 2161 N	S 7998 A	
	OM353.958 (OM352/3)			02/79 > 05/88	S 2530 PO	S 2161 N	S 7998 A	
U Serie (427)								
U 1000	OM356.914 (OM366)	75	102	09/91 > 12/92	S 5099 PE	S 2161 N	S 7998 A	
	some / alcuni	OM356.914 (OM366)	75	102	09/91 > 12/92	S 5099 PE	S 2161 N	S 1070 A
	prefilter / prefiltrato	OM356.914 (OM366)	75	102	09/91 > 12/92		S 1013 B	
U 1000	OM366.915 (OM366)	75	102		S 5124 PE	S 2161 N	S 7998 A	
some / alcuni	OM366.915 (OM366)	75	102	01/88 > 12/92		S 2161 N	S 1070 A	
from engine No. 933908 / da motore N. 933908	OM366.915 (OM366)	75	102		S 5099 PE	S 2161 N	S 7998 A	
prefilter / prefiltrato	OM366.915 (OM366)	75	102	01/88 > 12/92		S 1013 B		
U 1000 T	OM356.914 (OM366)	75	102	09/91 > 12/92	S 5099 PE	S 2161 N	S 7998 A	
	some / alcuni	OM356.914 (OM366)	75	102	09/91 > 12/92	S 5099 PE	S 2161 N	S 1070 A

**KW HP****...MERCEDES BENZ UNIMOG - trucks/autocarri**

prefilter / prefiltrro	OM356.914 (OM366)	75	102	09/91 >	12/92		S 1013 B		
U 1000 T									
to engine No. 933907 / a motore N. 933907	OM366.915 (OM366)	75	102			S 5124 PE	S 2161 N	S 7998 A	
some / alcuni	OM366.915 (OM366)	75	102	01/88 >	12/92		S 2161 N	S 1070 A	
from engine No. 933908 / da motore N. 933908	OM366.915 (OM366)	75	102			S 5099 PE	S 2161 N	S 7998 A	
prefilter / prefiltrro	OM366.915 (OM366)	75	102	01/88 >	12/92		S 1013 B		
U 1200									
to engine No. 933907 / a motore N. 933907	OM366.949 (OM366A)	75	102	01/88 >		S 5124 PE	S 2161 N	S 7998 A	
from engine No. 933908 / da motore N. 933908	OM366.949 (OM366A)	75	102	01/88 >		S 5099 PE	S 2161 N	S 7998 A	
U 1200 T									
to engine No. 933907 / a motore N. 933907	OM366.949 (OM366A)	110	150	01/88 >		S 5124 PE	S 2161 N	S 7998 A	
from engine No. 933908 / da motore N. 933908	OM366.949 (OM366A)	110	150	01/88 >		S 5099 PE	S 2161 N	S 7998 A	
U 1250									
to engine No. 286114 / a motore N. 286114	OM356 (OM366A)	110	150	01/92 >		S 5099 PE	S 2161 N	S 7998 A	
from engine No. 286115 / da motore N. 286115	OM356 (OM366A)	110	150	01/92 >		S 5131 PE	S 2161 N	S 7998 A	
dryer filter / filtro essiccatore	OM356 (OM366A)	110	150	01/92 >				S 7F24 A	
prefilter / prefiltrro	OM356 (OM366A)	110	150	01/92 >			S 1013 B		
U 1250									
to engine No. 933907 / a motore N. 933907	OM366.949 (OM366A)	92	125	01/88 >	06/00		S 2161 N	S 7998 A	
from engine No. 933908 / da motore N. 933908	OM366.949 (OM366A)	92	125	01/88 >		S 5124 PE			
	OM366.949 (OM366A)	92	125		06/00	S 5099 PE			
U 1250 L									
to engine No. 933907 / a motore N. 933907	OM366.949 (OM366A)	92	125	01/88 >		S 5124 PE	S 2161 N	S 7998 A	
from engine No. 933908 / da motore N. 933908	OM366.949 (OM366A)	92	125	01/88 >		S 5099 PE			
U 1400									
to engine No. 286114 / a motore N. 286114	OM356.950 (OM366A)	100	136	09/91 >	06/00		S 2161 N	S 7998 A	
from engine No. 286115 / da motore N. 286115	OM356.950 (OM366A)	100	136	09/91 >		S 5099 PE			
	OM356.950 (OM366A)	100	136		06/00	S 5131 PE			
dryer filter / filtro essiccatore	OM356.950 (OM366A)	100	136	09/91 >	06/00			S 7F24 A	
U 1400									
to engine No. 286114 / a motore N. 286114	OM356.956 (OM366A)	100	136	09/91 >	06/00		S 2161 N	S 7998 A	
from engine No. 286115 / da motore N. 286115	OM356.956 (OM366A)	100	136	09/91 >		S 5099 PE			
	OM356.956 (OM366A)	100	136		06/00	S 5131 PE			
dryer filter / filtro essiccatore	OM356.956 (OM366A)	100	136	09/91 >	06/00			S 7F24 A	
prefilter / prefiltrro	OM356.956 (OM366A)	100	136	09/91 >	06/00		S 1013 B		
U 1400									
to engine No. 933907 / a motore N. 933907	OM366.947 (OM366A)	100	136	01/88 >	06/00	S 5124 PE	S 2161 N	S 7998 A	
from engine No. 933908 / da motore N. 933908	OM366.947 (OM366A)	100	136		06/00	S 5099 PE			
prefilter / prefiltrro	OM366.947 (OM366A)	100	136	01/88 >	06/00		S 1013 B		
U 1450									
to engine No. 286114 / a motore N. 286114	OM356.950 (OM366A)	100	136	09/91 >	06/00	S 5099 PE	S 2161 N		
from engine No. 286115 / da motore N. 286115	OM356.950 (OM366A)	100	136		06/00	S 5131 PE			
dryer filter / filtro essiccatore	OM356.950 (OM366A)	100	136	01/92 >	06/00			S 7F24 A	
prefilter / prefiltrro	OM356.950 (OM366A)	100	136	09/91 >	06/00		S 1013 B		
U 1450									
to engine No. 286114 / a motore N. 286114	OM356.956 (OM366A)	100	136	09/91 >	06/00	S 5099 PE	S 2161 N	S 7998 A	
from engine No. 286115 / da motore N. 286115	OM356.956 (OM366A)	100	136		06/00	S 5131 PE			
dryer filter / filtro essiccatore	OM356.956 (OM366A)	100	136	09/91 >	06/00			S 7F24 A	
prefilter / prefiltrro	OM356.956 (OM366A)	100	136	09/91 >	06/00		S 1013 B		
U 1450									
to engine No. 933907 / a motore N. 933907	OM366.947 (OM366A)	100	136			S 5124 PE	S 2161 N	S 7998 A	
from engine No. 933908 / da motore N. 933908	OM366.947 (OM366A)	100	136			S 5099 PE	S 2161 N	S 7998 A	
prefilter / prefiltrro	OM366.947 (OM366A)	100	136	01/88 >	06/00		S 1013 B		
U 1450 L									
to engine No. 286114 / a motore N. 286114	OM356.956 (OM366A)	100	136	09/91 >	06/00		S 2161 N	S 7998 A	
from engine No. 286115 / da motore N. 286115	OM356.956 (OM366A)	100	136			S 5099 PE			
	OM356.956 (OM366A)	100	136			S 5131 PE			
prefilter / prefiltrro	OM356.956 (OM366A)	100	136	09/91 >	06/00		S 1013 B		
U 1450 L									
to engine No. 933907 / a motore N. 933907	OM366.947 (OM366A)	100	136			S 5124 PE	S 2161 N	S 7998 A	
from engine No. 933908 / da motore N. 933908	OM366.947 (OM366A)	100	136			S 5099 PE	S 2161 N	S 7998 A	
prefilter / prefiltrro	OM366.947 (OM366A)	100	136	01/88 >	06/00		S 1013 B		
U 1600									
to engine No. 286114 / a motore N. 286114	OM356A (366)	115	156	01/92 >	06/00		S 2161 N	S 7998 A	
from engine No. 286115 / da motore N. 286115	OM356A (366)	115	156			S 5124 PE			
	OM356A (366)	115	156			S 5132 PE			
prefilter / prefiltrro	OM356A (366)	115	156	01/92 >	06/00		S 1013 B		
U 1600									
to engine No. 286114 / a motore N. 286114	OM357.924 (OM366LA)	150	204	09/89 >	06/00		S 2161 N	S 7998 A	
from engine No. 286115 / da motore N. 286115	OM357.924 (OM366LA)	150	204	09/89 >		S 5124 PE			
	OM357.924 (OM366LA)	150	204		06/00	S 5132 PE			
prefilter / prefiltrro	OM357.924 (OM366LA)	150	204	09/89 >	06/00		S 1013 B		
U 1600									

M

**KW HP****...MERCEDES BENZ UNIMOG - trucks/autocarri**

to engine No. 286114 / a motore N. 286114	OM366.948 (OM366A)	115	156		S 5124 PE	S 2161 N	S 7998 A	
from engine No. 286115 / da motore N. 286115	OM366.948 (OM366A)	115	156			S 2161 N	S 7998 A	
prefilter / prefiltrro	OM366.948 (OM366A)	115	156	01/88 > 06/00		S 1013 B		
U 1600	OM366LA	120	164	01/97 > 06/00	S 5132 PE	S 2161 N	S 7998 A	
U 1600 L	OM356A (366)	115	156	01/92 > 06/00		S 2161 N	S 7998 A	
to engine No. 286114 / a motore N. 286114	OM356A (366)	115	156		S 5124 PE			
from engine No. 286115 / da motore N. 286115	OM356A (366)	115	156		S 5132 PE			
prefilter / prefiltrro	OM356A (366)	115	156	01/92 > 06/00		S 1013 B		
U 1600 L	OM357.924 (OM366LA)	150	204	09/89 > 06/00		S 2161 N	S 7998 A	
to engine No. 286114 / a motore N. 286114	OM357.924 (OM366LA)	150	204		S 5124 PE			
from engine No. 286115 / da motore N. 286115	OM357.924 (OM366LA)	150	204	> 06/00	S 5132 PE			
prefilter / prefiltrro	OM357.924 (OM366LA)	150	204	09/89 > 06/00		S 1013 B		
U 1600 L								
to engine No. 286114 / a motore N. 286114	OM366.948 (OM366A)	115	156		S 5124 PE	S 2161 N	S 7998 A	
from engine No. 286115 / da motore N. 286115	OM366.948 (OM366A)	115	156			S 2161 N	S 7998 A	
prefilter / prefiltrro	OM366.948 (OM366A)	115	156	01/88 > 06/00		S 1013 B		
U 1650	OM356A (OM366A)	115	156	01/92 > 06/00		S 2161 N	S 7998 A	
to engine No. 286114 / a motore N. 286114	OM356A (OM366A)	115	156	01/92 >	S 5124 PE			
from engine No. 286115 / da motore N. 286115	OM356A (OM366A)	115	156	> 06/00	S 5132 PE			
prefilter / prefiltrro	OM356A (OM366A)	115	156	01/92 > 06/00		S 1013 B		
U 1650								
to engine No. 286114 / a motore N. 286114	OM357.924 (OM366LA)	155	211		S 5124 PE	S 2161 N	S 7998 A	
from engine No. 286115 / da motore N. 286115	OM357.924 (OM366LA)	155	211			S 2161 N	S 7998 A	
prefilter / prefiltrro	OM357.924 (OM366LA)	155	211	09/89 > 06/00		S 1013 B		
U 1650								
to engine No. 286114 / a motore N. 286114	OM366.948 (OM366A)	115	156		S 5124 PE	S 2161 N	S 7998 A	
from engine No. 286115 / da motore N. 286115	OM366.948 (OM366A)	115	156			S 2161 N	S 7998 A	
prefilter / prefiltrro	OM366.948 (OM366A)	115	156	01/88 > 06/00		S 1013 B		
U 1650	OM366LA	120	164	01/97 > 06/00		S 2161 N	S 7998 A	
U 1650 L								
to engine No. 286114 / a motore N. 286114	OM356A (OM366A)	115	156		S 5124 PE	S 2161 N	S 7998 A	
from engine No. 286115 / da motore N. 286115	OM356A (OM366A)	115	156			S 2161 N	S 7998 A	
prefilter / prefiltrro	OM356A (OM366A)	115	156	01/92 > 06/00		S 1013 B		
U 1650 L	OM357.924 (OM366LA)	155	211	09/89 > 06/00		S 2161 N	S 7998 A	
to engine No. 286114 / a motore N. 286114	OM357.924 (OM366LA)	155	211	09/89 >	S 5124 PE			
from engine No. 286115 / da motore N. 286115	OM357.924 (OM366LA)	155	211	> 06/00	S 5132 PE			
prefilter / prefiltrro	OM357.924 (OM366LA)	155	211	09/89 > 06/00		S 1013 B		
U 1650 L								
to engine No. 286114 / a motore N. 286114	OM366.948 (OM366A)			01/88 >	S 5124 PE	S 2161 N	S 7998 A	
from engine No. 286115 / da motore N. 286115	OM366.948 (OM366A)			> 06/00		S 2161 N	S 7998 A	
prefilter / prefiltrro	OM366.948 (OM366A)			01/88 > 06/00		S 1013 B		
U Serie (435)								
U 1300 L	OM353.961 (OM325)			01/77 > 01/79	S 5099 PE	S 2161 N	S 7998 A	
	OM353.961 (OM325)			02/79 > 05/88	S 5124 PE	S 2161 N	S 7998 A	
U 1300 L	OM356 (OM366A)	100	136	01/92 >		S 2161 N	S 7998 A	
to engine No. 286114 / a motore N. 286114	OM356 (OM366A)	100	136		S 5099 PE			
from engine No. 286115 / da motore N. 286115	OM356 (OM366A)	100	136		S 5131 PE			
dryer filter / filtro essiccatore	OM356 (OM366A)	100	136	01/92 >			S 7F24 A	
prefilter / prefiltrro	OM356 (OM366A)	100	136	01/92 >		S 1013 B		
U 1300 L								
to engine No. 933907 / a motore N. 933907	OM366.955 (OM366A)			11/86 >	S 5124 PE	S 2161 N	S 7998 A	
from engine No. 933908 / da motore N. 933908	OM366.955 (OM366A)			11/86 >	S 5099 PE	S 2161 N	S 7998 A	
U 1300 LL	OM353.961 (OM352)			01/77 > 01/79	S 5099 PE	S 2161 N	S 7998 A	
	OM353.961 (OM352)			02/79 > 05/88	S 5124 PE	S 2161 N	S 7998 A	
U 1700	OM353.959 (OM352A)	125	170	05/78 > 09/88		S 2161 N	S 7998 A	
to engine No. 857430 / a motore N. 857430	OM353.959 (OM352A)	125	170	05/78 >	S 5099 PE			
from engine No. 857431 / da motore N. 857431	OM353.959 (OM352A)	125	170	> 09/88	S 5124 PE			
U 1700 L	OM353.959 (OM352A)	125	170	05/78 > 09/88		S 2161 N	S 7998 A	
to engine No. 857430 / a motore N. 857430	OM353.959 (OM352A)	125	170	05/78 >	S 5099 PE			
from engine No. 857431 / da motore N. 857431	OM353.959 (OM352A)	125	170	> 09/88	S 5124 PE			
U 1700 LL	OM353.959 (OM352A)	125	170	05/78 > 09/88		S 2161 N	S 7998 A	
to engine No. 857430 / a motore N. 857430	OM353.959 (OM352A)	125	170	05/78 >	S 5099 PE			
from engine No. 857431 / da motore N. 857431	OM353.959 (OM352A)	125	170	> 09/88	S 5124 PE			
U 1700 T	OM353.959 (OM352A)	125	170	05/78 > 09/88		S 2161 N	S 7998 A	
to engine No. 857430 / a motore N. 857430	OM353.959 (OM352A)	125	170	05/78 >	S 5099 PE			
from engine No. 857431 / da motore N. 857431	OM353.959 (OM352A)	125	170	> 09/88	S 5124 PE			
U Serie (437)								



kW HP



...MERCEDES BENZ UNIMOG - trucks/autocarri

U 1350 L	OM356 (OM366A) 100 136	09/91 >		S 2161 N	S 7998 A	
to engine No. 286114 / a motore N. 286114	OM356 (OM366A) 100 136		S 5099 PE			
from engine No. 286115 / da motore N. 286115	OM356 (OM366A) 100 136		S 5131 PE			
dryer filter / filtro essiccatore	OM356 (OM366A) 100 136	09/91 >			S 7F24 A	
prefilter / prefiltra	OM356 (OM366A) 100 136	09/91 >		S 1013 B		
U 1350 L	OM366.955 (OM366A) 100 136	05/88 >		S 2161 N	S 7998 A	
to engine No. 933907 / a motore N. 933907	OM366.955 (OM366A) 100 136		S 5124 PE			
from engine No. 933908 / da motore N. 933908	OM366.955 (OM366A) 100 136		S 5099 PE			
U 1550	OM356A (366)	03/90 > 06/00	S 5124 PE	S 2161 N	S 7998 A	
to engine No. 286114 / a motore N. 286114	OM356A (366)	03/90 > 06/00		S 2161 N	S 7998 A	
from engine No. 286115 / da motore N. 286115	OM356A (366)					
U 1550	OM366A	05/88 > 06/00	S 5124 PE	S 2161 N	S 7998 A	
to engine No. 286114 / a motore N. 286114	OM366A	05/88 > 06/00		S 2161 N	S 7998 A	
from engine No. 286115 / da motore N. 286115	OM366A					
U 1550 L	OM356A (366)	03/90 > 06/00	S 5124 PE	S 2161 N	S 7998 A	
to engine No. 286114 / a motore N. 286114	OM356A (366)	03/90 > 06/00		S 2161 N	S 7998 A	
from engine No. 286115 / da motore N. 286115	OM356A (366)					
dryer filter / filtro essiccatore	OM356A (366)	03/90 > 06/00			S 7F24 A	
U 1550 L	OM366A	05/88 > 06/00	S 5124 PE	S 2161 N	S 7998 A	
to engine No. 286114 / a motore N. 286114	OM366A	05/88 > 06/00		S 2161 N	S 7998 A	
from engine No. 286115 / da motore N. 286115	OM366A					
U 1700	OM356A (OM366A)	01/92 >	S 5124 PE			
to engine No. 286114 / a motore N. 286114	OM356A (OM366A)		S 5132 PE			
from engine No. 286115 / da motore N. 286115	OM356A (OM366A)			S 2161 N	S 7998 A	
dryer filter / filtro essiccatore	OM356A (OM366A)	01/92 >			S 7F24 A	
U 1700	OM366.963 (OM366A)	09/88 >	S 5124 PE	S 2161 N	S 7998 A	
to engine No. 286114 / a motore N. 286114	OM366.963 (OM366A)	09/88 >		S 2161 N	S 7998 A	
from engine No. 286115 / da motore N. 286115	OM366.963 (OM366A)					
U 1700 L	OM356A (OM366A)	01/92 >	S 5124 PE	S 2161 N	S 7998 A	
to engine No. 286114 / a motore N. 286114	OM356A (OM366A)	01/92 >		S 2161 N	S 7998 A	
from engine No. 286115 / da motore N. 286115	OM356A (OM366A)					
U 1700 L	OM366.963 (OM366A)	09/88 >	S 5124 PE	S 2161 N	S 7998 A	
to engine No. 286114 / a motore N. 286114	OM366.963 (OM366A)	09/88 >		S 2161 N	S 7998 A	
from engine No. 286115 / da motore N. 286115	OM366.963 (OM366A)					
U 1700 T	OM366.963 (OM366A)	09/88 >	S 5124 PE	S 2161 N	S 7998 A	
to engine No. 286114 / a motore N. 286114	OM366.963 (OM366A)	09/88 >		S 2161 N	S 7998 A	
from engine No. 286115 / da motore N. 286115	OM366.963 (OM366A)					
U 1750	OM356LA (OM366LA)	01/92 >	S 5124 PE	S 2161 N	S 7998 A	
to engine No. 286114 / a motore N. 286114	OM356LA (OM366LA)	01/92 >		S 2161 N	S 7998 A	
from engine No. 286115 / da motore N. 286115	OM356LA (OM366LA)					
dryer filter / filtro essiccatore	OM356LA (OM366LA)	01/92 >			S 7F24 A	
U 1750	OM366LA	09/88 >	S 5124 PE	S 2161 N	S 7998 A	
to engine No. 286114 / a motore N. 286114	OM366LA	09/88 >		S 2161 N	S 7998 A	
from engine No. 286115 / da motore N. 286115	OM366LA					
U 1750 L	OM356LA (OM366LA)	01/92 >	S 5124 PE	S 2161 N	S 7998 A	
to engine No. 286114 / a motore N. 286114	OM356LA (OM366LA)	01/92 >		S 2161 N	S 7998 A	
from engine No. 286115 / da motore N. 286115	OM356LA (OM366LA)					
U 1750 L	OM366LA	09/88 >	S 5124 PE	S 2161 N	S 7998 A	
to engine No. 286114 / a motore N. 286114	OM366LA	09/88 >		S 2161 N	S 7998 A	
from engine No. 286115 / da motore N. 286115	OM366LA					
U 1800	OM356.998 (OM366LA)		S 5124 PE	S 2161 N	S 2650 A	
to engine No. 286114 / a motore N. 286114	OM356.998 (OM366LA)			S 2161 N	S 2650 A	
from engine No. 286115 / da motore N. 286115	OM356.998 (OM366LA)					
dryer filter / filtro essiccatore	OM356.998 (OM366LA)	04/92 >			S 7F24 A	
inner / interno	OM356.998 (OM366LA)	04/92 >			S 7129 A	
U 1800 T	OM356.998 (OM366LA)		S 5124 PE	S 2161 N	S 2650 A	
to engine No. 286114 / a motore N. 286114	OM356.998 (OM366LA)			S 2161 N	S 2650 A	
from engine No. 286115 / da motore N. 286115	OM356.998 (OM366LA)					
inner / interno	OM356.998 (OM366LA)	04/92 >			S 7129 A	
U 1850	OM356.998 (OM366LA)		S 5124 PE	S 2161 N	S 2650 A	
to engine No. 286114 / a motore N. 286114	OM356.998 (OM366LA)			S 2161 N	S 2650 A	
from engine No. 286115 / da motore N. 286115	OM356.998 (OM366LA)					
dryer filter / filtro essiccatore	OM356.998 (OM366LA)	04/92 >			S 7F24 A	
inner / interno	OM356.998 (OM366LA)	04/92 >			S 7129 A	
U 1850 L						
to engine No. 286114 / a motore N. 286114	OM356.998 (OM366LA)		S 5124 PE	S 2161 N	S 2650 A	

M





kW HP



...MERCEDES BENZ UNIMOG - trucks/autocarri

M



from engine No. 286115 / da motore N. 286115 inner / interno	OM356.998 (OM366LA) OM356.998 (OM366LA)			04/92 >		S 2161 N S 2650 A S 7129 A	
U 2000					S 5124 PE	S 2161 N S 2650 A S 2650 A S 7129 A	
to engine No. 286114 / a motore N. 286114 from engine No. 286115 / da motore N. 286115 inner / interno	OM356LA (OM366LA) OM356LA (OM366LA) OM356LA (OM366LA)			04/92 >		S 2161 N S 2650 A S 7129 A	
U 2100					S 5124 PE	S 2161 N S 2650 A S 2650 A S 7F24 A S 7129 A	
to engine No. 286114 / a motore N. 286114 from engine No. 286115 / da motore N. 286115 dryer filter / filtro essiccatore inner / interno	OM356LA (366) OM356LA (366) OM356LA (366) OM356LA (366)			05/91 > 05/91 >		S 2161 N S 2650 A S 7129 A	
U 2100					S 5124 PE	S 2161 N S 2650 A S 2650 A S 7129 A	
to engine No. 286114 / a motore N. 286114 from engine No. 286115 / da motore N. 286115 inner / interno	OM366LA OM366LA OM366LA			09/89 > 02/01		S 2161 N S 2650 A S 7129 A	
U 2100 T						S 2161 N S 2650 A	S 7259 A
dryer filter / filtro essiccatore inner / interno	OM357LA (366) OM357LA (366) OM357LA (366)			09/89 > 02/01 09/89 > 02/01 09/89 > 02/01		S 7129 A	
U 2150					S 5124 PE	S 2161 N S 2650 A S 2650 A S 7129 A	
to engine No. 286114 / a motore N. 286114 from engine No. 286115 / da motore N. 286115 inner / interno	OM356.980 (OM366LA) OM356.980 (OM366LA) OM356.980 (OM366LA)			09/89 >		S 2161 N S 2650 A S 7129 A	
U 2150					S 5124 PE	S 2161 N S 2650 A S 2650 A S 7129 A	
to engine No. 286114 / a motore N. 286114 from engine No. 286115 / da motore N. 286115 inner / interno	OM356.997 (OM366LA) OM356.997 (OM366LA) OM356.997 (OM366LA)			09/89 >		S 2161 N S 2650 A S 7129 A	
U 2150					S 5124 PE	S 2161 N S 2650 A S 2650 A S 7F24 A S 7129 A	
to engine No. 286114 / a motore N. 286114 from engine No. 286115 / da motore N. 286115 inner / interno	OM356LA (366) OM356LA (366) OM356LA (366) OM356LA (366)			05/91 > 05/91 >		S 2161 N S 2650 A S 7129 A	
U 2150 L					S 5124 PE	S 2161 N S 2650 A S 2650 A S 7129 A	
to engine No. 286114 / a motore N. 286114 from engine No. 286115 / da motore N. 286115 inner / interno	OM356.980 (OM366LA) OM356.980 (OM366LA) OM356.980 (OM366LA)			09/89 >		S 2161 N S 2650 A S 7129 A	
U 2150 L					S 5124 PE	S 2161 N S 2650 A S 2650 A S 7129 A	
to engine No. 286114 / a motore N. 286114 from engine No. 286115 / da motore N. 286115 inner / interno	OM356.997 (OM366LA) OM356.997 (OM366LA) OM356.997 (OM366LA)			09/89 >		S 2161 N S 2650 A S 7129 A	
U 2400						S 2161 N S 2650 A S 7F24 A	S 7259 A
dryer filter / filtro essiccatore dryer filter / filtro essiccatore inner / interno	OM356.980 (OM366LA) OM356.980 (OM366LA) OM356.980 (OM366LA)			05/91 > 05/91 > 05/91 >		S 7129 A	
U 2400						S 2161 N S 2650 A	S 7259 A
dryer filter / filtro essiccatore inner / interno	OM366LA OM366LA OM366LA			04/92 > 12/00 04/92 > 12/00 04/92 > 12/00		S 7129 A	
U 2400 TG						S 2161 N S 2650 A	S 7259 A
dryer filter / filtro essiccatore inner / interno	OM357LA (366) OM357LA (366) OM357LA (366)			07/93 > 07/93 > 07/93 >		S 7129 A	
U 2450						S 2161 N S 2650 A	S 7259 A
dryer filter / filtro essiccatore inner / interno	OM356.980 (OM366LA) OM356.980 (OM366LA) OM356.980 (OM366LA)			05/91 > 05/91 > 05/91 >		S 7129 A	
U 2450						S 2161 N S 2650 A	S 7259 A
dryer filter / filtro essiccatore inner / interno	OM357LA (366) OM357LA (366) OM357LA (366)			07/93 > 07/93 > 07/93 >		S 7129 A	
U 2450						S 2161 N S 2650 A	S 7259 A
dryer filter / filtro essiccatore dryer filter / filtro essiccatore inner / interno	OM366LA OM366LA OM366LA			04/92 > 12/00 04/92 > 12/00 04/92 > 12/00		S 7F24 A S 7129 A	
U 2450 L						S 2161 N S 2650 A	S 7259 A
dryer filter / filtro essiccatore inner / interno	OM356.980 (OM366LA) OM356.980 (OM366LA) OM356.980 (OM366LA)			05/91 > 05/91 > 05/91 >		S 7129 A	
U 3000					S 5007 PE	S 6017 NE S 6089 NE	S 2650 A
with manual pump prefilter / con pompa manuale prefiltra dryer filter / filtro essiccatore dryer filter / filtro essiccatore inner / interno	OM904LA OM904LA OM904LA OM904LA	110 150 110 150 110 150 110 150		11/02 > 11/02 > 11/02 > 11/02 >		S 7F24 A S 7129 A	S 7259 A



kW HP



...MERCEDES BENZ UNIMOG - trucks/autocarri

U 4000	OM904LA	130 177	11/02 >	S 5007 PE	S 6017 NE	S 2650 A	
with manual pump prefilter / con pompa manuale prefiltrato	OM904LA	130 177	11/02 >		S 6089 NE		
dryer filter / filtro essiccatore	OM904LA	130 177	11/02 >				S 7259 A
dryer filter / filtro essiccatore	OM904LA	130 177	11/02 >			S 7F24 A	
inner / interno	OM904LA	130 177	11/02 >			S 7129 A	
U 4023	OM934.974	170 231	05/13 >		S 6148 NE		
power steering / servosterzo	OM934.974	170 231	05/13 >				S 3081 PO
U 5000	OM906.935 (OM906LA)	170 231	11/02 >	S 5036 PE	S 6017 NE	S 2650 A	
with manual pump prefilter / con pompa manuale prefiltrato	OM906.935 (OM906LA)	170 231	11/02 >		S 6089 NE		
dryer filter / filtro essiccatore	OM906.935 (OM906LA)	170 231	11/02 >			S 7F24 A	S 7259 A
dryer filter / filtro essiccatore	OM906.935 (OM906LA)	170 231	11/02 >			S 7129 A	
inner / interno	OM906.935 (OM906LA)	170 231	11/02 >				
U 5000	OM924LA	160 218	11/02 >	S 5007 PE	S 6017 NE	S 2650 A	
dryer filter / filtro essiccatore	OM924LA	160 218	11/02 >			S 7F24 A	
dryer filter / filtro essiccatore	OM924LA	160 218	11/02 >				S 7259 A
inner / interno	OM924LA	160 218	11/02 >			S 7129 A	
U 5023	OM934.974	170 231	05/13 >		S 6148 NE		
power steering / servosterzo	OM934.974	170 231	05/13 >				S 3081 PO

MITSUBISHI-FUSO

trucks/autocarri

FP Serie

FP547	Mitsubishi 6D24-0AT2		01/98 > 12/03			S 7617 A	
KC-FP410	Mitsubishi 6D40T		01/94 > 12/00			S 7617 A	
KC-FP411	Mitsubishi 8M20		01/94 > 12/00			S 7617 A	
KC-FP412	Mitsubishi 8M21		01/95 > 12/00			S 7617 A	
KC-FP415	Mitsubishi 8DC9		01/95 > 12/96			S 7617 A	
KC-FP415	Mitsubishi 8DC9T		01/95 > 12/96			S 7617 A	
KC-FP415 FD	Mitsubishi 8DC9		01/94 > 12/00			S 7617 A	
KC-FP419	Mitsubishi 8DC11		01/94 > 12/00			S 7617 A	
KC-FP424	Mitsubishi 10M20		01/95 > 12/00			S 7617 A	
KC-FP440	Mitsubishi 6D40T		01/95 > 12/96			S 7617 A	
KC-FP440 DR	Mitsubishi 6D40T		01/94 > 12/96			S 7617 A	
KC-FP441	Mitsubishi 8M20		01/94 > 12/00			S 7617 A	
KC-FP442	Mitsubishi 8M21		01/95 > 12/00			S 7617 A	
KC-FP444	Mitsubishi 10M20		01/95 > 12/00			S 7617 A	
KC-FP445	Mitsubishi 8DC9T		01/94 > 12/96			S 7617 A	
KC-FP50 J	Mitsubishi 6M70T		01/00 > 12/00			S 7617 A	
KC-FP510	Mitsubishi 6D40T		01/94 > 12/00			S 7617 A	
KC-FP512	Mitsubishi 8M21		01/95 > 12/00			S 7617 A	
KC-FP540	Mitsubishi 6D40T		01/94 > 12/00			S 7617 A	
KC-FP541	Mitsubishi 8M20		01/94 > 12/00			S 7617 A	
KC-FP542	Mitsubishi 8M21		01/95 > 12/00			S 7617 A	
W-FP410	Mitsubishi 6D40T		01/90 > 12/95			S 7617 A	
W-FP411	Mitsubishi 8M20		01/91 > 12/95			S 7617 A	
W-FP440	Mitsubishi 6D40T		01/91 > 12/95			S 7617 A	
W-FP441	Mitsubishi 8M20		01/91 > 12/95			S 7617 A	

FS Serie

FS50	Mitsubishi 6M70T		01/00 >			S 7617 A	
FS527	Mitsubishi 6D24-0AT2		01/98 > 12/03			S 7617 A	
KC-FS410	Mitsubishi 6D40T		01/94 > 12/00			S 7617 A	
KC-FS510	Mitsubishi 6D40T		01/94 > 12/00			S 7617 A	
KC-FS511	Mitsubishi 8M20		01/94 > 12/00			S 7617 A	
KC-FS540	Mitsubishi 6D40T		01/94 > 12/00			S 7617 A	
KC-FS570	Mitsubishi 6D40T		01/94 > 12/00			S 7617 A	
U-FS410	Mitsubishi 6D40T		01/93 > 12/95			S 7617 A	
U-FS411	Mitsubishi 8M20		01/93 > 12/95			S 7617 A	

FT Serie

FT50	Mitsubishi 6M70T		01/00 >			S 7617 A	
KC-FT410	Mitsubishi 6D40T		01/94 > 12/00			S 7617 A	
KC-FT50 J	Mitsubishi 6M70T		01/00 > 12/00			S 7617 A	
KC-FT510	Mitsubishi 6D40T		01/94 > 12/00			S 7617 A	
KC-FT520	Mitsubishi 6D40T		01/94 > 12/00			S 7617 A	
U-FT410	Mitsubishi 6D40T		01/89 > 12/93			S 7617 A	

FU Serie

KC-FU410	Mitsubishi 6D40T		01/94 > 12/96			S 7617 A	
KC-FU411	Mitsubishi 8M20		01/94 > 12/00			S 7617 A	
KC-FU415	Mitsubishi 8DC9		01/95 > 12/00			S 7617 A	

M





kW HP



...MITSUBISHI-FUSO - trucks/autocarri

M



KC-FU415	Mitsubishi 8DC9T	01/94 > 12/96			S 7617 A	
KC-FU415J	Mitsubishi 8DC9	01/94 > 12/00			S 7617 A	
KC-FU511	Mitsubishi 8M20	01/94 > 12/00			S 7617 A	
KC-FU540	Mitsubishi 6D40T	01/96 > 12/00			S 7617 A	
U-FU410	Mitsubishi 6D40T	01/89 > 12/95			S 7617 A	
U-FU411	Mitsubishi 8M20	01/91 > 12/95			S 7617 A	
U-FU440	Mitsubishi 6D40T	01/93 > 12/95			S 7617 A	
U-FU470	Mitsubishi 6D40T	01/93 > 12/95			S 7617 A	
FV Serie						
KC-FV410	Mitsubishi 6D40T	01/94 > 12/00			S 7617 A	
KC-FV411J	Mitsubishi 8M20	01/94 > 12/96			S 7617 A	
KC-FV50	Mitsubishi 6D40T	01/98 > 12/98			S 7617 A	
KC-FV500	Mitsubishi 6D40T	01/94 > 12/00			S 7617 A	
KC-FV501	Mitsubishi 6D40T	01/94 > 12/00			S 7617 A	
KC-FV511	Mitsubishi 8M20	01/96 > 12/99			S 7617 A	
KC-FV540	Mitsubishi 6D40T	01/94 > 12/00			S 7617 A	
U-FV411	Mitsubishi 8M20	01/91 > 12/95			S 7617 A	
U-FV411J	Mitsubishi 8M20	01/91 > 12/95			S 7617 A	
W-FV411	Mitsubishi 8M20	01/91 > 12/95			S 7617 A	
W-FV411J	Mitsubishi 8M20	01/91 > 12/95			S 7617 A	
FW Serie						
KC-FW451	Mitsubishi 8M20	01/94 > 12/00			S 7617 A	
KC-FW455	Mitsubishi 8M20	01/94 > 12/00			S 7617 A	
Super Great						
350	6R10T2	257 350	04/10 >	S 5156 PE		
380	6R10T3	279 380	04/10 >	S 5156 PE		
420	6R10T4	309 420	04/10 >	S 5156 PE		
460	6R10T6	338 460	04/10 >	S 5156 PE		
520	6R10T7	382 520	04/10 >	S 5156 PE		
MOXY dump trucks/autocarri ribaltabili						
3000 Serie						
3216	Ford 8210			S 8111 NC		
5000 Serie						
5220 B	Scania DS 9			S 4323 NR		
some / alcuni	Scania DS 9	01/84 >		S 8501 NR		
turbocompressor / turbocompressore	Scania DS 9			S 2329 R		
5222	Scania DS 8			S 4323 NR		
turbocompressor / turbocompressore	Scania DS 8			S 2329 R		
5222 B	Scania DS 9			S 4323 NR		
some / alcuni	Scania DS 9	01/84 >		S 8501 NR		
turbocompressor / turbocompressore	Scania DS 9			S 2329 R		
6000 Serie						
6200 S	Scania			S 4323 NR	S 0150 A	
inner / interno	Scania				S 8940 A	
power steering / servosterzo	Scania					S 3081 PO
turbocompressor / turbocompressore	Scania			S 2329 R		
6225 B	Scania DS 9			S 4323 NR		
some / alcuni	Scania DS 9	01/84 >		S 8501 NR		
turbocompressor / turbocompressore	Scania DS 9			S 2329 R		
6225 S	Scania DSI 8			S 4323 NR		
turbocompressor / turbocompressore	Scania DSI 8			S 2329 R		
6226 B	Scania DS 9			S 4323 NR		
some / alcuni	Scania DS 9	01/84 >		S 8501 NR		
turbocompressor / turbocompressore	Scania DS 9			S 2329 R		
6227 B	Scania DS 9			S 4323 NR		
some / alcuni	Scania DS 9	01/84 >		S 8501 NR		
turbocompressor / turbocompressore	Scania DS 9			S 2329 R		
6227 S	Scania DSI 8			S 4323 NR		
turbocompressor / turbocompressore	Scania DSI 8			S 2329 R		
7000 Serie						
7235 S	Scania DS 14			S 4323 NR		
turbocompressor / turbocompressore	Scania DS 14			S 2329 R		
D Serie						
D 15 S	Scania			S 4323 NR		
some / alcuni	Scania			S 7111 NC		
power steering / servosterzo	Scania					S 3081 PO



kW HP



...MOXY - dump trucks/autocarri ribaltabili

turbocompressor / turbocompressore	Scania			S 2329 R			
D 16 B	Scania				S 4323 NR	S 0150 A	
inner / interno	Scania					S 8940 A	
power steering / servosterzo	Scania						S 3081 PO
turbocompressor / turbocompressore	Scania			S 2329 R			

MT Serie

MT26	Scania DC9	234	318		S 4402 R	S 4341 NR	S 7558 A
inner / interno	Scania DC9	234	318				S 7559 A
MT31	Scania DC9	250	340		S 4402 R	S 4341 NR	S 7558 A
inner / interno	Scania DC9	250	340				S 7559 A
MT41	Scania DC12	330	449		S 4402 R	S 4341 NR	
prefilter / prefilto	Scania DC12	330	449			S 4143 NR	

MULTICAR

special trucks/autocarri speciali

Fumo

2.8 TDI	Iveco 8140.43B	78	105	09/01 >	S 3003 DR	S 4394 NR	
3.0 TDI	Iveco F1C Euro4	107	146	07/06 >	S 0920 R	S 1071 B	S 7356 A

M25 Serie

M25 1.9 D	028.B M344/841	40	54	01/91 > 07/96	S 5601 R	S 8500 NR	S 4940 A
	028.B M344/841	40	54	08/96 >	S 5601 R	S 8500 NR	
some / alcuni	028.B M344/841	40	54	01/91 > 07/96	S 5601 R	S 7600 NR	S 4940 A
some / alcuni	028.B M344/841	40	54	08/96 >	S 5601 R	S 7600 NR	
or / oppure	028.B M344/841	40	54	01/91 > 07/96	S 5603 R	S 8500 NR	S 4940 A
or / oppure	028.B M344/841	40	54	08/96 >	S 5603 R	S 8500 NR	
M25 2.2 D	4VD 8.8/9-1 SRF	34	46	01/85 > 12/91	S 8310 R	S 6311 N	

M26 Serie

M26 1.9 D	028.B M344/841	40	54	06/92 > 07/96	S 5601 R	S 8500 NR	S 4940 A
	028.B M344/841	40	54	08/96 >	S 5601 R	S 8500 NR	
or / oppure	028.B M344/841	40	54	06/92 > 07/96	S 5603 R	S 8500 NR	S 4940 A
or / oppure	028.B M344/841	40	54	08/96 >	S 5603 R	S 8500 NR	
M26 1.9 D	Volkswagen 1Y	52	70	07/92 > 07/96	S 3425 R	S 8500 NR	S 4940 A
	Volkswagen 1Y	52	70	08/96 >	S 3425 R	S 8500 NR	
inner / interno	Volkswagen 1Y	52	70	07/92 > 07/96			S 7165 A
M26 2.5 TD	Iveco 8140SC27.02	62	84	01/94 > 08/96	S 3003 DR	S 8500 NR	S 4940 A
inner / interno	Iveco 8140SC27.02	62	84	01/94 > 08/96			S 7165 A
M26 2.8 TD	Iveco 8140.23.2585	78	106	01/96 > 07/96	S 3003 DR	S 8500 NR	S 4940 A
	Iveco 8140.23.2585	78	106	08/96 > 12/02	S 3003 DR	S 8500 NR	
inner / interno	Iveco 8140.23.2585	78	106	01/96 > 07/96			S 7165 A
M26 2.8 TD	Iveco 8140.43R	66	90	01/03 >	S 3003 DR		

Tremo

501	Volkswagen AFD	60	82	09/98 > 05/05	S 5601 R	S 8500 NR	
or / oppure	Volkswagen AFD	60	82	09/98 > 05/05	S 5603 R	S 8500 NR	
601 2.3 TD	Mercedes Benz OM601.900	62	85	09/98 > 05/05	S 5095 PE	S 9600 NR	
Carrier 1.9 TDI	Volkswagen AVM	63	86	06/05 >	S 5011 PE	S 4391 NR	
with complete filter / con filtro completo	Volkswagen AVM	63	86	06/05 >		S 5427 GC	

UX Serie

100	Mercedes Benz OM602DELA	85	115	01/99 >	S 5095 PE	S 9600 NR	S 7516 A
------------	-------------------------	----	-----	---------	-----------	-----------	----------

NAVISTAR

off-highway trucks/autocarri fuoristrada

4000 Series

4900	DT466						S 7359 A
-------------	-------	--	--	--	--	--	----------

5000 Series

5400	Cummins N14						S 7359 A
5600	Caterpillar C12						S 7359 A

NEOPLAN

buses/autobus

Centroliner

N 4407	MAN D0826LOH17	162	220	10/98 >	S 3292 R	S 4378 NR	S 3439 C
with automatic gearbox ZF HP500 / con cambio automatico ZF HP500	MAN D0826LOH17	162	220	10/98 >			S 2234 Z
with automatic air-conditioner, recirculation filter / con climatizzatore automatico, filtro ricircolo	MAN D0826LOH17	162	220	10/79 >			S 3448 C
spheros aeroshere world / con climatizzatore sul tetto	MAN D0826LOH17	162	220	10/98 >			S 3440 C
with air-conditioner WEBASTO Aerosphere (6 filters) / con climatizzatore WEBASTO Aerosphere (N.6 filtri)	MAN D0826LOH17	162	220	10/98 >			S 3081 C
dryer filter / filtro essiccatore	MAN D0826LOH17	162	220	10/98 >			S 7259 A
power steering / servosterzo	MAN D0826LOH17	162	220	10/98 >			S 3081 PO
N 4407	Mercedes Benz OM906LA	180	245	01/00 >			S 3439 C
with automatic air-conditioner, recirculation filter / con climatizzatore automatico, filtro ricircolo	Mercedes Benz OM906LA	180	245	01/00 >			S 3448 C
spheros aeroshere world / con climatizzatore sul tetto	Mercedes Benz OM906LA	180	245	01/00 >			S 3440 C

N



**KW HP****...NEOPLAN - buses/autobus****N**

with air-conditioner WEBASTO Aerosphere / con climatizzatore WEBASTO Aerosphere dryer filter / filtro essiccatore	Mercedes Benz OM906LA	180	245	01/00	>	S 5036 PE	S 6017 NE	S 0450 A	S 3081 C S 7259 A
power steering / servosterzo	Mercedes Benz OM906LA	180	245	01/00	>				S 3081 PO
N 4411	MAN D0826LOH17/LUH12	162	220	10/98	>				S 3439 C
with automatic gearbox / con cambio automatico	MAN D0826LOH17/LUH12	162	220	10/98	>				S 2234 Z
with automatic air-conditioner, recirculation filter / con climatizzatore automatico, filtro ricircolo	MAN D0826LOH17/LUH12	162	220	10/98	>				S 3448 C
spheros aeroshere world / con climatizzatore sul tetto	MAN D0826LOH17/LUH12	162	220	10/98	>				S 3440 C
with air-conditioner WEBASTO Aerosphere / con climatizzatore WEBASTO Aerosphere dryer filter / filtro essiccatore	MAN D0826LOH17/LUH12	162	220	10/98	>	S 3292 R	S 4378 NR		S 3081 C S 7259 A
power steering / servosterzo	MAN D0826LOH17/LUH12	162	220	10/98	>				S 3081 PO
N 4411	MAN D0836LOH03	206	280	10/98	>				S 3439 C
with automatic gearbox / con cambio automatico	MAN D0836LOH03	206	280	10/98	>				S 2234 Z
with automatic air-conditioner, recirculation filter / con climatizzatore automatico, filtro ricircolo	MAN D0836LOH03	206	280	10/98	>				S 3448 C
spheros aeroshere world / con climatizzatore sul tetto	MAN D0836LOH03	206	280	10/98	>				S 3440 C
with air-conditioner WEBASTO Aerosphere / con climatizzatore WEBASTO Aerosphere dryer filter / filtro essiccatore	MAN D0836LOH03	206	280	10/98	>	S 3292 R	S 4378 NR		S 3081 C S 7259 A
power steering / servosterzo	MAN D0836LOH03	206	280	10/98	>				S 3081 PO
N 4416	MAN D0826LOH17/LUH12	162	220	10/98	>				S 3439 C
with automatic gearbox / con cambio automatico	MAN D0826LOH17/LUH12	162	220	10/98	>				S 2234 Z
with automatic air-conditioner, recirculation filter / con climatizzatore automatico, filtro ricircolo	MAN D0826LOH17/LUH12	162	220	10/98	>				S 3448 C
spheros aeroshere world / con climatizzatore sul tetto	MAN D0826LOH17/LUH12	162	220	10/98	>				S 3440 C
with air-conditioner WEBASTO Aerosphere / con climatizzatore WEBASTO Aerosphere dryer filter / filtro essiccatore	MAN D0826LOH17/LUH12	162	220	10/98	>	S 3292 R	S 4378 NR		S 3081 C S 7259 A
power steering / servosterzo	MAN D0826LOH17/LUH12	162	220	10/98	>				S 3081 PO
N 4416	MAN D0836LOH03	206	280	10/98	>				S 3439 C
with automatic gearbox ZF HP500 / con cambio automatico ZF HP500	MAN D0836LOH03	206	280	10/98	>				S 2234 Z
with automatic air-conditioner, recirculation filter / con climatizzatore automatico, filtro ricircolo	MAN D0836LOH03	206	280	10/98	>				S 3448 C
spheros aeroshere world / con climatizzatore sul tetto	MAN D0836LOH03	206	280	10/98	>				S 3440 C
with air-conditioner WEBASTO Aerosphere / con climatizzatore WEBASTO Aerosphere dryer filter / filtro essiccatore	MAN D0836LOH03	206	280	10/98	>	S 3292 R	S 4378 NR		S 3081 C S 7259 A
power steering / servosterzo	MAN D0836LOH03	206	280	10/98	>				S 3081 PO
N 4416	MAN D0836LUH13	191	260	01/99	> 12/01				S 3439 C
with automatic gearbox ZF HP500 / con cambio automatico ZF HP500	MAN D0836LUH13	191	260	01/99	> 12/01				S 2234 Z
with automatic air-conditioner, recirculation filter / con climatizzatore automatico, filtro ricircolo	MAN D0836LUH13	191	260	01/99	> 12/01				S 3448 C
spheros aeroshere world / con climatizzatore sul tetto	MAN D0836LUH13	191	260	01/99	> 12/01				S 3440 C
with air-conditioner WEBASTO Aerosphere / con climatizzatore WEBASTO Aerosphere dryer filter / filtro essiccatore	MAN D0836LUH13	191	260	01/99	> 12/01	S 3292 R	S 4378 NR		S 3081 C S 7259 A
power steering / servosterzo	MAN D0836LUH13	191	260	01/99	> 12/01				S 3081 PO
N 4416	MAN D2866LUH	191	260	01/99	> 12/01				S 3439 C
with automatic gearbox ZF HP500 / con cambio automatico ZF HP500	MAN D2866LUH	191	260	01/99	> 12/01				S 2234 Z
with automatic air-conditioner, recirculation filter / con climatizzatore automatico, filtro ricircolo	MAN D2866LUH	191	260	01/99	> 12/01				S 3448 C
spheros aeroshere world / con climatizzatore sul tetto	MAN D2866LUH	191	260	01/99	> 12/01				S 3440 C
with air-conditioner WEBASTO Aerosphere / con climatizzatore WEBASTO Aerosphere dryer filter / filtro essiccatore	MAN D2866LUH	191	260	01/99	> 12/01	S 7260 PO	S 4378 NR		S 3081 C S 7259 A
power steering / servosterzo	MAN D2866LUH	191	260	01/99	> 12/01				S 3081 PO
N 4416	MAN D2866LUH20	228	310	01/99	> 12/01				S 3439 C
with automatic gearbox ZF HP500 / con cambio automatico ZF HP500	MAN D2866LUH20	228	310	01/99	> 12/01				S 2234 Z
with automatic air-conditioner, recirculation filter / con climatizzatore automatico, filtro ricircolo	MAN D2866LUH20	228	310	01/99	> 12/01				S 3448 C
spheros aeroshere world / con climatizzatore sul tetto	MAN D2866LUH20	228	310	01/99	> 12/01				S 3440 C
with air-conditioner WEBASTO Aerosphere / con climatizzatore WEBASTO Aerosphere dryer filter / filtro essiccatore	MAN D2866LUH20	228	310	01/99	> 12/01	S 7260 PO	S 4378 NR		S 3081 C S 7259 A
power steering / servosterzo	MAN D2866LUH20	228	310	01/99	> 12/01				S 3081 PO
N 4420	MAN D2866LOH25/LUH20	228	310	01/99	>				S 3439 C
with automatic gearbox ZF HP500 / con cambio automatico ZF HP500	MAN D2866LOH25/LUH20	228	310	01/99	>				S 2234 Z
with automatic air-conditioner, recirculation filter / con climatizzatore automatico, filtro ricircolo	MAN D2866LOH25/LUH20	228	310	01/99	>				S 3448 C
spheros aeroshere world / con climatizzatore sul tetto	MAN D2866LOH25/LUH20	228	310	01/99	>				S 3440 C
with air-conditioner WEBASTO Aerosphere / con climatizzatore WEBASTO Aerosphere dryer filter / filtro essiccatore	MAN D2866LOH25/LUH20	228	310	01/99	>	S 7260 PO	S 4378 NR		S 3081 C S 7259 A
power steering / servosterzo	MAN D2866LOH25/LUH20	228	310	01/99	>				S 3081 PO
N 4420	MAN D2866LUH21	257	349	01/99	>				S 3439 C
with automatic gearbox ZF HP500 / con cambio automatico ZF HP500	MAN D2866LUH21	257	349	01/99	>				S 2234 Z
with automatic air-conditioner, recirculation filter / con climatizzatore automatico, filtro ricircolo	MAN D2866LUH21	257	349	01/99	>				S 3448 C
spheros aeroshere world / con climatizzatore sul tetto	MAN D2866LUH21	257	349	01/99	>				S 3440 C
with air-conditioner WEBASTO Aerosphere / con climatizzatore WEBASTO Aerosphere dryer filter / filtro essiccatore	MAN D2866LUH21	257	349	01/99	>	S 5016 PE	S 4378 NR	S 1050 A	S 3081 C S 7259 A
power steering / servosterzo	MAN D2866LUH21	257	349	01/99	>				S 3081 PO
N 4420	MAN D2866LUH22	191	260	01/99	>				S 3439 C

**KW HP****...NEOPLAN - buses/autobus**

with automatic gearbox ZF HP500 / con cambio automatico ZF HP500	MAN D2866LUH22	191	260	01/99	>				S 2234 Z
with automatic air-conditioner, recirculation filter / con climatizzatore automatico, filtro ricircolo	MAN D2866LUH22	191	260	01/99	>				S 3448 C
spheros aeroshere world / con climatizzatore sul tetto	MAN D2866LUH22	191	260	01/99	>				S 3440 C
with air-conditioner WEBASTO Aerosphere / con climatizzatore WEBASTO Aerosphere	MAN D2866LUH22	191	260	01/99	>	S 7260 PO	S 4378 NR		S 3081 C
dryer filter / filtro essiccatore	MAN D2866LUH22	191	260	01/99	>				S 7259 A
power steering / servosterzo	MAN D2866LUH22	191	260	01/99	>				S 3081 PO
N 4421	MAN D2866LOH25/LUH20	228	310	01/99	>				S 3439 C
with automatic gearbox / con cambio automatico	MAN D2866LOH25/LUH20	228	310	01/99	>				S 2234 Z
with automatic air-conditioner, recirculation filter / con climatizzatore automatico, filtro ricircolo	MAN D2866LOH25/LUH20	228	310	01/99	>				S 3448 C
spheros aeroshere world / con climatizzatore sul tetto	MAN D2866LOH25/LUH20	228	310	01/99	>				S 3440 C
with air-conditioner WEBASTO Aerosphere / con climatizzatore WEBASTO Aerosphere	MAN D2866LOH25/LUH20	228	310	01/99	>	S 7260 PO	S 4378 NR		S 3081 C
dryer filter / filtro essiccatore	MAN D2866LOH25/LUH20	228	310	01/99	>				S 7259 A
power steering ZF HP500 / servosterzo ZF HP500	MAN D2866LOH25/LUH20	228	310	01/99	>				S 3081 PO
N 4421	MAN D2866LUH21	257	349	01/99	>				S 3439 C
with automatic gearbox / con cambio automatico	MAN D2866LUH21	257	349	01/99	>				S 2234 Z
with automatic air-conditioner, recirculation filter / con climatizzatore automatico, filtro ricircolo	MAN D2866LUH21	257	349	01/99	>				S 3448 C
spheros aeroshere world / con climatizzatore sul tetto	MAN D2866LUH21	257	349	01/99	>				S 3440 C
with air-conditioner WEBASTO Aerosphere / con climatizzatore WEBASTO Aerosphere	MAN D2866LUH21	257	349	01/99	>	S 5016 PE	S 4378 NR	S 1050 A	S 3081 C
dryer filter / filtro essiccatore	MAN D2866LUH21	257	349	01/99	>				S 7259 A
power steering ZF HP500 / servosterzo ZF HP500	MAN D2866LUH21	257	349	01/99	>				S 3081 PO
N 4421	MAN D2866LUH22	191	260	01/99	>				S 3439 C
with automatic gearbox ZF HP500 / con cambio automatico ZF HP500	MAN D2866LUH22	191	260	01/99	>				S 2234 Z
with automatic air-conditioner, recirculation filter / con climatizzatore automatico, filtro ricircolo	MAN D2866LUH22	191	260	01/99	>				S 3448 C
spheros aeroshere world / con climatizzatore sul tetto	MAN D2866LUH22	191	260	01/99	>				S 3440 C
with air-conditioner WEBASTO Aerosphere / con climatizzatore WEBASTO Aerosphere	MAN D2866LUH22	191	260	01/99	>	S 7260 PO	S 4378 NR		S 3081 C
dryer filter / filtro essiccatore	MAN D2866LUH22	191	260	01/99	>				S 7259 A
power steering / servosterzo	MAN D2866LUH22	191	260	01/99	>				S 3081 PO
N 4426/3	MAN D2866LOH	265	360	05/02	>				S 3439 C
with automatic air-conditioner, recirculation filter / con climatizzatore automatico, filtro ricircolo	MAN D2866LOH	265	360	05/02	>				S 3448 C
spheros aeroshere world / con climatizzatore sul tetto	MAN D2866LOH	265	360	05/02	>				S 3440 C
with air-conditioner WEBASTO Aerosphere / con climatizzatore WEBASTO Aerosphere	MAN D2866LOH	265	360	05/02	>	S 5016 PE	S 4378 NR	S 1050 A	S 3081 C
dryer filter / filtro essiccatore	MAN D2866LOH	265	360	05/02	>				S 7259 A
power steering / servosterzo	MAN D2866LOH	265	360	05/02	>				S 3081 PO
N 4516	MAN D2066LUH21	199	271	08/06	>	S 5046 PE	S 6011 NE	S 7A11 A	S 3439 C
with automatic gearbox VOITH D864.3E / con cambio automatico VOITH D864.3E	MAN D2066LUH21	199	271	08/06	>				S 5663 PO
with automatic gearbox ZF 4HP500 / con cambio automatico ZF 4HP500	MAN D2066LUH21	199	271	08/06	>				S 2234 Z
with automatic air-conditioner, recirculation filter / con climatizzatore automatico, filtro ricircolo	MAN D2066LUH21	199	271	08/06	>				S 3448 C
spheros aeroshere world / con climatizzatore sul tetto	MAN D2066LUH21	199	271	08/06	>				S 3440 C
power steering / servosterzo	MAN D2066LUH21	199	271	08/06	>				S 3081 PO
N 4516	MAN D2066LUH22	228	310	08/06	>	S 5046 PE	S 6011 NE	S 7A11 A	S 3439 C
with automatic gearbox VOITH D864.3E / con cambio automatico VOITH D864.3E	MAN D2066LUH22	228	310	08/06	>				S 5663 PO
with automatic gearbox ZF 4HP500 / con cambio automatico ZF 4HP500	MAN D2066LUH22	228	310	08/06	>				S 2234 Z
with automatic air-conditioner, recirculation filter / con climatizzatore automatico, filtro ricircolo	MAN D2066LUH22	228	310	08/06	>				S 3448 C
spheros aeroshere world / con climatizzatore sul tetto	MAN D2066LUH22	228	310	08/06	>				S 3440 C
power steering / servosterzo	MAN D2066LUH22	228	310	08/06	>				S 3081 PO
N 4516	MAN D2066LUH33	265	360	08/06	>	S 5046 PE	S 6011 NE	S 7A11 A	S 3439 C
with automatic gearbox VOITH D864.3E / con cambio automatico VOITH D864.3E	MAN D2066LUH33	265	360	08/06	>				S 5663 PO
with automatic gearbox ZF 4HP500 / con cambio automatico ZF 4HP500	MAN D2066LUH33	265	360	08/06	>				S 2234 Z
with automatic air-conditioner, recirculation filter / con climatizzatore automatico, filtro ricircolo	MAN D2066LUH33	265	360	08/06	>				S 3448 C
spheros aeroshere world / con climatizzatore sul tetto	MAN D2066LUH33	265	360	08/06	>				S 3440 C
power steering / servosterzo	MAN D2066LUH33	265	360	08/06	>				S 3081 PO
N 4516	MAN D2066LUH46	206	280	08/06	>	S 5046 PE	S 6011 NE	S 7A11 A	S 3439 C
with automatic gearbox VOITH D864.3E / con cambio automatico VOITH D864.3E	MAN D2066LUH46	206	280	08/06	>				S 5663 PO
with automatic gearbox ZF 4HP500 / con cambio automatico ZF 4HP500	MAN D2066LUH46	206	280	08/06	>				S 2234 Z
with automatic air-conditioner, recirculation filter / con climatizzatore automatico, filtro ricircolo	MAN D2066LUH46	206	280	08/06	>				S 3448 C
spheros aeroshere world / con climatizzatore sul tetto	MAN D2066LUH46	206	280	08/06	>				S 3440 C
power steering / servosterzo	MAN D2066LUH46	206	280	08/06	>				S 3081 PO
N 4516	MAN D2066LUH47	235	320	08/06	>	S 5046 PE	S 6011 NE	S 7A11 A	S 3439 C
with automatic gearbox VOITH D864.3E / con cambio automatico VOITH D864.3E	MAN D2066LUH47	235	320	08/06	>				S 5663 PO
with automatic gearbox ZF 4HP500 / con cambio automatico ZF 4HP500	MAN D2066LUH47	235	320	08/06	>				S 2234 Z
with automatic air-conditioner, recirculation filter / con climatizzatore automatico, filtro ricircolo	MAN D2066LUH47	235	320	08/06	>				S 3448 C
spheros aeroshere world / con climatizzatore sul tetto	MAN D2066LUH47	235	320	08/06	>				S 3440 C
power steering / servosterzo	MAN D2066LUH47	235	320	08/06	>				S 3081 PO
N 4516	MAN D2866LUH24	228	310	03/02	>				S 3439 C
with automatic gearbox ZF HP500 / con cambio automatico ZF HP500	MAN D2866LUH24	228	310	03/02	>				S 2234 Z
with automatic air-conditioner, recirculation filter / con climatizzatore automatico, filtro ricircolo	MAN D2866LUH24	228	310	03/02	>				S 3448 C
spheros aeroshere world / con climatizzatore sul tetto	MAN D2866LUH24	228	310	03/02	>				S 3440 C

N



kW HP



...NEOPLAN - buses/autobus

N



with air-conditioner WEBASTO Aerosphere / con climatizzatore WEBASTO Aerosphere	MAN D2866LUH24	228	310	03/02	>	S 7260 PO	S 4378 NR		S 3081 C
dryer filter / filtro essiccatore	MAN D2866LUH24	228	310	03/02	>				S 7259 A
power steering / servosterzo	MAN D2866LUH24	228	310	03/02	>				S 3081 PO
N 4521	MAN D2866LUH25	265	360	03/02	>				S 3439 C
with automatic gearbox ZF HP500 / con cambio automatico ZF HP500	MAN D2866LUH25	265	360	03/02	>				S 2234 Z
with automatic air-conditioner, recirculation filter / con climatizzatore automatico, filtro ricircolo	MAN D2866LUH25	265	360	03/02	>				S 3448 C
spheros aeroshere world / con climatizzatore sul tetto	MAN D2866LUH25	265	360	03/02	>				S 3440 C
with air-conditioner WEBASTO Aerosphere / con climatizzatore WEBASTO Aerosphere	MAN D2866LUH25	265	360	03/02	>	S 5016 PE	S 4378 NR	S 1050 A	S 3081 C
dryer filter / filtro essiccatore	MAN D2866LUH25	265	360	03/02	>				S 7259 A
power steering / servosterzo	MAN D2866LUH25	265	360	03/02	>				S 3081 PO
N 4522	MAN D2066LUH22	228	310	08/06	>	S 5046 PE	S 6011 NE	S 7A11 A	S 3439 C
with automatic gearbox VOITH D864.3E / con cambio automatico VOITH D864.3E	MAN D2066LUH22	228	310	08/06	>				S 5663 PO
with automatic gearbox ZF 4HP500 / con cambio automatico ZF 4HP500	MAN D2066LUH22	228	310	08/06	>				S 2234 Z
with automatic air-conditioner, recirculation filter / con climatizzatore automatico, filtro ricircolo	MAN D2066LUH22	228	310	08/06	>				S 3448 C
spheros aeroshere world / con climatizzatore sul tetto	MAN D2066LUH22	228	310	08/06	>				S 3440 C
power steering / servosterzo	MAN D2066LUH22	228	310	08/06	>				S 3081 PO
N 4522	MAN D2066LUH23	257	349	08/06	>	S 5046 PE	S 6011 NE	S 7A11 A	S 3439 C
with automatic gearbox VOITH D864.3E / con cambio automatico VOITH D864.3E	MAN D2066LUH23	257	349	08/06	>				S 5663 PO
with automatic gearbox ZF 4HP500 / con cambio automatico ZF 4HP500	MAN D2066LUH23	257	349	08/06	>				S 2234 Z
with automatic air-conditioner, recirculation filter / con climatizzatore automatico, filtro ricircolo	MAN D2066LUH23	257	349	08/06	>				S 3448 C
spheros aeroshere world / con climatizzatore sul tetto	MAN D2066LUH23	257	349	08/06	>				S 3440 C
power steering / servosterzo	MAN D2066LUH23	257	349	08/06	>				S 3081 PO
N 4522	MAN D2066LUH33	265	360	08/06	>	S 5046 PE	S 6011 NE	S 7A11 A	S 3439 C
with automatic gearbox VOITH D864.3E / con cambio automatico VOITH D864.3E	MAN D2066LUH33	265	360	08/06	>				S 5663 PO
with automatic gearbox ZF 4HP500 / con cambio automatico ZF 4HP500	MAN D2066LUH33	265	360	08/06	>				S 2234 Z
with automatic air-conditioner, recirculation filter / con climatizzatore automatico, filtro ricircolo	MAN D2066LUH33	265	360	08/06	>				S 3448 C
spheros aeroshere world / con climatizzatore sul tetto	MAN D2066LUH33	265	360	08/06	>				S 3440 C
power steering / servosterzo	MAN D2066LUH33	265	360	08/06	>				S 3081 PO
N 4522	MAN D2066LUH47	235	320	08/06	>	S 5046 PE	S 6011 NE	S 7A11 A	S 3439 C
with automatic gearbox VOITH D864.3E / con cambio automatico VOITH D864.3E	MAN D2066LUH47	235	320	08/06	>				S 5663 PO
with automatic gearbox ZF 4HP500 / con cambio automatico ZF 4HP500	MAN D2066LUH47	235	320	08/06	>				S 2234 Z
with automatic air-conditioner, recirculation filter / con climatizzatore automatico, filtro ricircolo	MAN D2066LUH47	235	320	08/06	>				S 3448 C
spheros aeroshere world / con climatizzatore sul tetto	MAN D2066LUH47	235	320	08/06	>				S 3440 C
power steering / servosterzo	MAN D2066LUH47	235	320	08/06	>				S 3081 PO

Cityliner HD

12.24 m	MAN D2066LOH03	294	400	05/07	>	S 5046 PE	S 6011 NE		
power steering / servosterzo	MAN D2066LOH03	294	400	05/07	>				S 3081 PO
12.24 m	MAN D2066LOH04	324	440	05/07	>	S 5046 PE	S 6011 NE		
power steering / servosterzo	MAN D2066LOH04	324	440	05/07	>				S 3081 PO

Cityliner HDC

12.99 m	MAN D2066LOH04	324	440	05/07	>	S 5046 PE	S 6011 NE		
power steering / servosterzo	MAN D2066LOH04	324	440	05/07	>				S 3081 PO
12.99 m	MAN D2676LOH02	353	480	05/07	>	S 5046 PE	S 6011 NE		
power steering / servosterzo	MAN D2676LOH02	353	480	05/07	>				S 3081 PO

Cityliner HDL

13.99 m	MAN D2066LOH04	324	440	05/07	>	S 5046 PE	S 6011 NE		
power steering / servosterzo	MAN D2066LOH04	324	440	05/07	>				S 3081 PO
13.99 m	MAN D2676LOH02	353	480	05/07	>	S 5046 PE	S 6011 NE		
power steering / servosterzo	MAN D2676LOH02	353	480	05/07	>				S 3081 PO

Cityliner I

N 1116/3 HC	MAN D2876LOH2	338	460	09/02	> 06/06	S 5016 PE	S 6016 NE	S 7A23 A	
spheros aeroshere world / con climatizzatore sul tetto	MAN D2876LOH2	338	460	09/02	> 06/06				S 3440 C
dryer filter / filtro essiccatore	MAN D2876LOH2	338	460	09/02	> 06/06				S 7259 A
inner / interno	MAN D2876LOH2	338	460	09/02	> 06/06			S 7616 A	
power steering / servosterzo	MAN D2876LOH2	338	460	09/02	> 06/06				S 3081 PO
N 116	Mercedes Benz OM402LA	280	381	01/90	>	S 7261 PO	S 2161 N		
dryer filter / filtro essiccatore	Mercedes Benz OM402LA	280	381	01/90	>				S 7259 A
power steering / servosterzo	Mercedes Benz OM402LA	280	381	01/90	>				S 3081 PO

Cityliner II

N 1216 HD	MAN D2066LOH03	294	400	07/06	>	S 5046 PE	S 6011 NE	S 7644 A	S 3165 C
with activated carbons / ai carboni attivi	MAN D2066LOH03	294	400	07/06	>				S 4177 CA
with air-conditioner Webasto Aerosphere World / con climatizzatore Webasto Aerosphere World	MAN D2066LOH03	294	400	07/06	>				S 3283 C
dryer filter / filtro essiccatore	MAN D2066LOH03	294	400	07/06	>				S 7A66 A
inner / interno	MAN D2066LOH03	294	400	07/06	>			S 7646 A	
power steering / servosterzo	MAN D2066LOH03	294	400	07/06	>				S 3081 PO
N 1216 HD	MAN D2066LOH04/20	324	440	07/06	>	S 5046 PE	S 6011 NE	S 7644 A	S 3165 C
with activated carbons / ai carboni attivi	MAN D2066LOH04/20	324	440	07/06	>				S 4177 CA



kW HP



...NEOPLAN - buses/autobus

with air-conditioner Webasto Aerosphere World / con climatizzatore Webasto Aerosphere World	MAN D2066LOH04/20	324	440	07/06	>				S 3283 C
dryer filter / filtro essiccatore	MAN D2066LOH04/20	324	440	07/06	>				S 7A66 A
inner / interno	MAN D2066LOH04/20	324	440	07/06	>			S 7646 A	
power steering / servosterzo	MAN D2066LOH04/20	324	440	07/06	>				S 3081 PO
N 1216 HD (P16)	MAN D2066LOH03	294	400	09/07	>	S 5046 PE	S 6011 NE	S 7644 A	S 3165 C
with activated carbons / ai carboni attivi	MAN D2066LOH03	294	400	09/07	>				S 4177 CA
with air-conditioner Webasto Aerosphere World / con climatizzatore Webasto Aerosphere World	MAN D2066LOH03	294	400	09/07	>				S 3283 C
dryer filter / filtro essiccatore	MAN D2066LOH03	294	400	09/07	>				S 7A66 A
inner / interno	MAN D2066LOH03	294	400	09/07	>			S 7646 A	
power steering / servosterzo	MAN D2066LOH03	294	400	09/07	>				S 3081 PO
N 1217 HDC	MAN D2066LOH04	324	440	07/06	>	S 5046 PE	S 6011 NE	S 7644 A	S 3165 C
with activated carbons / ai carboni attivi	MAN D2066LOH04	324	440	07/06	>				S 4177 CA
with air-conditioner Webasto Aerosphere World / con climatizzatore Webasto Aerosphere World	MAN D2066LOH04	324	440	07/06	>				S 3283 C
dryer filter / filtro essiccatore	MAN D2066LOH04	324	440	07/06	>				S 7A66 A
inner / interno	MAN D2066LOH04	324	440	07/06	>			S 7646 A	
power steering / servosterzo	MAN D2066LOH04	324	440	07/06	>				S 3081 PO
N 1217 HDC	MAN D2676LOH02	353	480	07/06	>	S 5046 PE	S 6011 NE		
power steering / servosterzo	MAN D2676LOH02	353	480	07/06	>				S 3081 PO
N 1217 HDC (P16)	MAN D2066LOH04 EVV	324	440	09/07	>	S 5046 PE	S 6011 NE	S 7644 A	
with air-conditioner Webasto Aerosphere World / con climatizzatore Webasto Aerosphere World	MAN D2066LOH04 EVV	324	440	09/07	>				S 3283 C
dryer filter / filtro essiccatore	MAN D2066LOH04 EVV	324	440	09/07	>				S 7A66 A
inner / interno	MAN D2066LOH04 EVV	324	440	09/07	>			S 7646 A	
power steering / servosterzo	MAN D2066LOH04 EVV	324	440	09/07	>				S 3081 PO
N 1217 HDC (P16)	MAN D2676LOH26 EVV	324	440	09/07	>	S 5046 PE	S 6011 NE	S 7644 A	
with air-conditioner Webasto Aerosphere World / con climatizzatore Webasto Aerosphere World	MAN D2676LOH26 EVV	324	440	09/07	>				S 3283 C
dryer filter / filtro essiccatore	MAN D2676LOH26 EVV	324	440	09/07	>				S 7A66 A
inner / interno	MAN D2676LOH26 EVV	324	440	09/07	>			S 7646 A	
power steering / servosterzo	MAN D2676LOH26 EVV	324	440	09/07	>				S 3081 PO
N 1218 HDL	MAN D2066LOH04	324	440	07/06	>	S 5046 PE	S 6011 NE	S 7644 A	S 3165 C
with activated carbons / ai carboni attivi	MAN D2066LOH04	324	440	07/06	>				S 4177 CA
with air-conditioner Webasto Aerosphere World / con climatizzatore Webasto Aerosphere World	MAN D2066LOH04	324	440	07/06	>				S 3283 C
inner / interno	MAN D2066LOH04	324	440	07/06	>			S 7646 A	
power steering / servosterzo	MAN D2066LOH04	324	440	07/06	>				S 3081 PO
N 1218 HDL	MAN D2676LOH02	353	480	07/06	>	S 5046 PE	S 6011 NE	S 7644 A	S 3165 C
with activated carbons / ai carboni attivi	MAN D2676LOH02	353	480	07/06	>				S 4177 CA
with air-conditioner Webasto Aerosphere World / con climatizzatore Webasto Aerosphere World	MAN D2676LOH02	353	480	07/06	>				S 3283 C
inner / interno	MAN D2676LOH02	353	480	07/06	>			S 7646 A	
power steering / servosterzo	MAN D2676LOH02	353	480	07/06	>				S 3081 PO
N 1218 HDL (P16)	MAN D2676LOH2	363	494	09/07	>	S 5046 PE	S 6011 NE	S 7644 A	
with air-conditioner Webasto Aerosphere World / con climatizzatore Webasto Aerosphere World	MAN D2676LOH2	363	494	09/07	>				S 3283 C
dryer filter / filtro essiccatore	MAN D2676LOH2	363	494	09/07	>				S 7A66 A
inner / interno	MAN D2676LOH2	363	494	09/07	>			S 7646 A	
power steering / servosterzo	MAN D2676LOH2	363	494	09/07	>				S 3081 PO
N 1218 HDL (P16)	MAN D2676LOH27 EVV	353	480	09/08	>	S 5046 PE	S 6011 NE	S 7644 A	
spheros aerosphere world / con climatizzatore sul tetto	MAN D2676LOH27 EVV	353	480	09/08	>				S 3440 C
with air-conditioner Webasto Aerosphere World / con climatizzatore Webasto Aerosphere World	MAN D2676LOH27 EVV	353	480	09/08	>				S 3283 C
dryer filter / filtro essiccatore	MAN D2676LOH27 EVV	353	480	09/08	>				S 7A66 A
inner / interno	MAN D2676LOH27 EVV	353	480	09/08	>			S 7646 A	
power steering / servosterzo	MAN D2676LOH27 EVV	353	480	09/08	>				S 3081 PO
Euroliner									
N 316/3 (UEL)	MAN D2876LUH01	294	400	01/97	>	S 7260 PO	S 4378 NR	S 7213 A	
dryer filter / filtro essiccatore	MAN D2876LUH01	294	400	01/97	>				S 7259 A
power steering / servosterzo	MAN D2876LUH01	294	400	01/97	>				S 3081 PO
N 3316 K/UE	MAN D2866LUH30	301	410	09/98	>	S 7260 PO	S 4378 NR	S 1050 A	
dryer filter / filtro essiccatore	MAN D2866LUH30	301	410	09/98	>				S 7259 A
power steering / servosterzo	MAN D2866LUH30	301	410	09/98	>				S 3081 PO
N 3316 KL/UEL	MAN D2866LUH25	265	360	09/98	>	S 7260 PO	S 4378 NR	S 1050 A	
dryer filter / filtro essiccatore	MAN D2866LUH25	265	360	09/98	>				S 7259 A
power steering / servosterzo	MAN D2866LUH25	265	360	09/98	>				S 3081 PO
N 3318/3 UE	MAN D2866LUH30	301	410	09/98	>	S 7260 PO	S 4378 NR	S 1050 A	
dryer filter / filtro essiccatore	MAN D2866LUH30	301	410	09/98	>				S 7259 A
power steering / servosterzo	MAN D2866LUH30	301	410	09/98	>				S 3081 PO
Jetliner									
N 208	MAN D0826	150	204	01/89	>		S 1411 N	S 2650 A	
N 208	Mercedes Benz OM352A	150	204	01/83	>	S 2530 PO	S 2161 N	S 2650 A	
N 208	Mercedes Benz OM366LA	150	204	01/88	>	S 5124 PE	S 2161 N	S 2650 A	
Jetliner II									

N



**KW HP****...NEOPLAN - buses/autobus****N**

12 m (P26)	D2066LUH Euro 5/6/EEV	294	400	09/12	>		S 6011 NE	S 7A11 A	S 3165 C
with activated carbons / ai carboni attivi	D2066LUH Euro 5/6/EEV	294	400	09/12	>				S 4177 CA
with automatic gearbox ZF / con cambio automatico ZF	D2066LUH Euro 5/6/EEV	294	400	09/12	>				S 2234 Z
with air-conditioner KONVEKTA P700, N.8 pcs / con climatizzatore KONVEKTA P700, N.8 PZ	D2066LUH Euro 5/6/EEV	294	400	09/12	>				S 3279 C
with air-conditioner SPHEROS/WEBASTO 33 kW, N.6 PCS / con climatizzatore SPHEROS/WEBASTO 33 kW, N.6 PZ	D2066LUH Euro 5/6/EEV	294	400	09/12	>				S 3447 C
inner / interno	D2066LUH Euro 5/6/EEV	294	400	09/12	>			S 7649 A	
assembly HENGST Euro 5/EEV / montaggio HENGST Euro 5/EEV	D2066LUH Euro 5/6/EEV	294	400	09/12	>	S 5046 PE			
assembly MANN+HUMMEL Euro 6 / montaggio MANN+HUMMEL Euro 6	D2066LUH Euro 5/6/EEV	294	400	09/12	>	S 5235 PE			
prefilter / prefiltra	D2066LUH Euro 5/6/EEV	294	400	09/12	>		S 6088 NE		
power steering / servosterzo	D2066LUH Euro 5/6/EEV	294	400	09/12	>				S 3081 PO
12 m (P26)	D2066LUH34 EEV	264	360	09/12	>		S 6011 NE	S 7A11 A	S 3165 C
with activated carbons / ai carboni attivi	D2066LUH34 EEV	264	360	09/12	>				S 4177 CA
with automatic gearbox ZF / con cambio automatico ZF	D2066LUH34 EEV	264	360	09/12	>				S 2234 Z
with air-conditioner KONVEKTA P700, N.8 pcs / con climatizzatore KONVEKTA P700, N.8 PZ	D2066LUH34 EEV	264	360	09/12	>				S 3279 C
with air-conditioner SPHEROS/WEBASTO 33 kW, N.6 PCS / con climatizzatore SPHEROS/WEBASTO 33 kW, N.6 PZ	D2066LUH34 EEV	264	360	09/12	>				S 3447 C
dryer filter / filtro essiccatore	D2066LUH34 EEV	264	360	09/12	>			S 7649 A	S 7A66 A
inner / interno	D2066LUH34 EEV	264	360	09/12	>				
assembly HENGST / montaggio HENGST	D2066LUH34 EEV	264	360	09/12	>	S 5046 PE			
prefilter / prefiltra	D2066LUH34 EEV	264	360	09/12	>		S 6088 NE		
power steering / servosterzo	D2066LUH34 EEV	264	360	09/12	>				S 3081 PO
12 m (P26)	D2066LUH34 Euro6	264	360	09/12	>		S 6011 NE	S 7A11 A	S 3165 C
with activated carbons / ai carboni attivi	D2066LUH34 Euro6	264	360	09/12	>				S 4177 CA
with automatic gearbox ZF / con cambio automatico ZF	D2066LUH34 Euro6	264	360	09/12	>				S 2234 Z
with air-conditioner KONVEKTA P700, N.8 pcs / con climatizzatore KONVEKTA P700, N.8 PZ	D2066LUH34 Euro6	264	360	09/12	>				S 3279 C
with air-conditioner SPHEROS/WEBASTO 33 kW, N.6 PCS / con climatizzatore SPHEROS/WEBASTO 33 kW, N.6 PZ	D2066LUH34 Euro6	264	360	09/12	>				S 3447 C
dryer filter / filtro essiccatore	D2066LUH34 Euro6	264	360	09/12	>			S 7649 A	S 7A66 A
inner / interno	D2066LUH34 Euro6	264	360	09/12	>				
assembly MANN+HUMMEL / montaggio MANN+HUMMEL	D2066LUH34 Euro6	264	360	09/12	>	S 5235 PE			
prefilter / prefiltra	D2066LUH34 Euro6	264	360	09/12	>		S 6088 NE		
power steering / servosterzo	D2066LUH34 Euro6	264	360	09/12	>				S 3081 PO
13 m (P27)	D2066LUH Euro 5/6/EEV	294	400	09/12	>		S 6011 NE	S 7A11 A	S 3165 C
with activated carbons / ai carboni attivi	D2066LUH Euro 5/6/EEV	294	400	09/12	>				S 4177 CA
with automatic gearbox ZF / con cambio automatico ZF	D2066LUH Euro 5/6/EEV	294	400	09/12	>				S 2234 Z
with air-conditioner KONVEKTA P700, N.8 pcs / con climatizzatore KONVEKTA P700, N.8 PZ	D2066LUH Euro 5/6/EEV	294	400	09/12	>				S 3279 C
with air-conditioner SPHEROS/WEBASTO 33 kW, N.6 PCS / con climatizzatore SPHEROS/WEBASTO 33 kW, N.6 PZ	D2066LUH Euro 5/6/EEV	294	400	09/12	>				S 3447 C
inner / interno	D2066LUH Euro 5/6/EEV	294	400	09/12	>			S 7649 A	
assembly HENGST Euro 5/EEV / montaggio HENGST Euro 5/EEV	D2066LUH Euro 5/6/EEV	294	400	09/12	>	S 5046 PE			
assembly MANN+HUMMEL Euro 6 / montaggio MANN+HUMMEL Euro 6	D2066LUH Euro 5/6/EEV	294	400	09/12	>	S 5235 PE			
prefilter / prefiltra	D2066LUH Euro 5/6/EEV	294	400	09/12	>		S 6088 NE		
power steering / servosterzo	D2066LUH Euro 5/6/EEV	294	400	09/12	>				S 3081 PO
13 m (P27)	D2066LUH34 EEV	264	360	09/12	>		S 6011 NE	S 7A11 A	S 3165 C
with activated carbons / ai carboni attivi	D2066LUH34 EEV	264	360	09/12	>				S 4177 CA
with automatic gearbox ZF / con cambio automatico ZF	D2066LUH34 EEV	264	360	09/12	>				S 2234 Z
with air-conditioner KONVEKTA P700, N.8 pcs / con climatizzatore KONVEKTA P700, N.8 PZ	D2066LUH34 EEV	264	360	09/12	>				S 3279 C
with air-conditioner SPHEROS/WEBASTO 33 kW, N.6 PCS / con climatizzatore SPHEROS/WEBASTO 33 kW, N.6 PZ	D2066LUH34 EEV	264	360	09/12	>				S 3447 C
dryer filter / filtro essiccatore	D2066LUH34 EEV	264	360	09/12	>			S 7649 A	S 7A66 A
inner / interno	D2066LUH34 EEV	264	360	09/12	>				
assembly HENGST / montaggio HENGST	D2066LUH34 EEV	264	360	09/12	>	S 5046 PE			
prefilter / prefiltra	D2066LUH34 EEV	264	360	09/12	>		S 6088 NE		
power steering / servosterzo	D2066LUH34 EEV	264	360	09/12	>				S 3081 PO
13 m (P27)	D2066LUH34 Euro6	264	360	09/12	>		S 6011 NE	S 7A11 A	S 3165 C
with activated carbons / ai carboni attivi	D2066LUH34 Euro6	264	360	09/12	>				S 4177 CA
with automatic gearbox ZF / con cambio automatico ZF	D2066LUH34 Euro6	264	360	09/12	>				S 2234 Z
with air-conditioner KONVEKTA P700, N.8 pcs / con climatizzatore KONVEKTA P700, N.8 PZ	D2066LUH34 Euro6	264	360	09/12	>				S 3279 C
with air-conditioner SPHEROS/WEBASTO 33 kW, N.6 PCS / con climatizzatore SPHEROS/WEBASTO 33 kW, N.6 PZ	D2066LUH34 Euro6	264	360	09/12	>				S 3447 C
inner / interno	D2066LUH34 Euro6	264	360	09/12	>			S 7649 A	
assembly MANN+HUMMEL / montaggio MANN+HUMMEL	D2066LUH34 Euro6	264	360	09/12	>	S 5235 PE			
prefilter / prefiltra	D2066LUH34 Euro6	264	360	09/12	>		S 6088 NE		
power steering / servosterzo	D2066LUH34 Euro6	264	360	09/12	>				S 3081 PO
Megaliner									
N 128/4	Mercedes Benz OM442.998	370	503	01/93	>	S 5133 PE		S 7213 A	
dryer filter / filtro essiccatore	Mercedes Benz OM442.998	370	503	01/93	>				S 7259 A
2 filters / N.2 filtri	Mercedes Benz OM442.998	370	503	01/93	>		S 2162 N		
power steering / servosterzo	Mercedes Benz OM442.998	370	503	01/93	>				S 3081 PO
N 40 Serie									
N 4016 NF	KHD F8L513	150	204	05/86	>	S 8600 R	S 5400 NR		
with automatic gearbox ZF HP500/590 / con cambio automatico ZF HP500/590	KHD F8L513	150	204	05/86	>				S 2234 Z

**KW HP****...NEOPLAN - buses/autobus**

Skyliner									
C	D2676LOH28 EEV	371	505	10/11	>	S 5046 PE	S 6011 NE	S 7644 A	
with activated carbons frontbox / ai carboni attivi frontbox	D2676LOH28 EEV	371	505	10/11	>				S 4177 CA
spheros aeroshere world / con climatizzatore sul tetto	D2676LOH28 EEV	371	505	10/11	> 05/14				S 3440 C
with air-conditioner Webasto Aerosphere World / con climatizzatore Webasto Aerosphere World	D2676LOH28 EEV	371	505	10/11	>				S 3283 C
dryer filter / filtro essiccatore	D2676LOH28 EEV	371	505	10/11	>				S 7A66 A
inner / interno	D2676LOH28 EEV	371	505	10/11	>			S 7646 A	
power steering / servosterzo	D2676LOH28 EEV	371	505	10/11	>				S 3081 PO
C (N 1122/3 C/L)	D2876LOH21	390	530	09/02	> 03/06	S 5016 PE	S 6016 NE	S 7A23 A	
	D2876LOH21	390	530	04/06	> 06/10	S 5016 PE	S 6016 NE	S 7644 A	
spheros aeroshere world / con climatizzatore sul tetto	D2876LOH21	390	530	09/02	> 06/10				S 3440 C
dryer filter / filtro essiccatore	D2876LOH21	390	530	09/02	> 06/10				S 7259 A
inner / interno	D2876LOH21	390	530	09/02	> 03/06			S 7616 A	
power steering / servosterzo	D2876LOH21	390	530	09/02	> 06/10				S 3081 PO
L	D2676LOH28 EEV	371	505	10/11	>	S 5046 PE	S 6011 NE	S 7644 A	
with activated carbons frontbox / ai carboni attivi frontbox	D2676LOH28 EEV	371	505	10/11	>				S 4177 CA
spheros aeroshere world / con climatizzatore sul tetto	D2676LOH28 EEV	371	505	10/11	> 05/14				S 3440 C
with air-conditioner Webasto Aerosphere World / con climatizzatore Webasto Aerosphere World	D2676LOH28 EEV	371	505	10/11	>				S 3283 C
dryer filter / filtro essiccatore	D2676LOH28 EEV	371	505	10/11	>				S 7A66 A
inner / interno	D2676LOH28 EEV	371	505	10/11	>			S 7646 A	
power steering / servosterzo	D2676LOH28 EEV	371	505	10/11	>				S 3081 PO
L	D2676LOH32 Euro6	371	505	09/12	>	S 5235 PE	S 6011 NE	S 7644 A	
with air-conditioner / con climatizzatore	D2676LOH32 Euro6	371	505	09/12	>				S 3440 C
dryer filter / filtro essiccatore	D2676LOH32 Euro6	371	505	09/12	>				S 7A66 A
inner / interno	D2676LOH32 Euro6	371	505	09/12	>			S 7646 A	
prefilter / prefiltra	D2676LOH32 Euro6	371	505	09/12	>		S 6088 NE		
prefilter SEPAR 2000 / prefiltra SEPAR 2000	D2676LOH32 Euro6	371	505	09/12	>		S 6059 NE		
power steering / servosterzo	D2676LOH32 Euro6	371	505	09/12	>				S 3081 PO
L (N 1122/3 C/L)	D2876LOH21	390	530	09/02	> 03/06	S 5016 PE	S 6016 NE	S 7A23 A	
	D2876LOH21	390	530	04/06	> 06/10	S 5016 PE	S 6016 NE	S 7644 A	
spheros aeroshere world / con climatizzatore sul tetto	D2876LOH21	390	530	09/02	> 06/10				S 3440 C
dryer filter / filtro essiccatore	D2876LOH21	390	530	09/02	> 06/10				S 7259 A
inner / interno	D2876LOH21	390	530	09/02	> 03/06			S 7616 A	
power steering / servosterzo	D2876LOH21	390	530	09/02	> 06/10				S 3081 PO
N 1122/3 C	D2676LOH2	353	480	09/02	> 03/06	S 5046 PE	S 6011 NE	S 7A23 A	
	D2676LOH2	353	480	04/06	> 06/10	S 5046 PE	S 6011 NE	S 7644 A	
spheros aeroshere world / con climatizzatore sul tetto	D2676LOH2	353	480	09/02	> 06/10				S 3440 C
dryer filter / filtro essiccatore	D2676LOH2	353	480	09/02	> 06/10				S 7A66 A
inner / interno	D2676LOH2	353	480	09/02	> 03/06			S 7616 A	
inner / interno	D2676LOH2	353	480	04/06	> 06/10			S 7646 A	
power steering / servosterzo	D2676LOH2	353	480	09/02	> 06/10				S 3081 PO
N 1122/3 L	D2676LOH2	353	480	09/02	> 03/06	S 5046 PE	S 6011 NE	S 7A23 A	
	D2676LOH2	353	480	04/06	> 06/10	S 5046 PE	S 6011 NE	S 7644 A	
spheros aeroshere world / con climatizzatore sul tetto	D2676LOH2	353	480	09/02	> 06/10				S 3440 C
dryer filter / filtro essiccatore	D2676LOH2	353	480	09/02	> 06/10				S 7A66 A
inner / interno	D2676LOH2	353	480	09/02	> 03/06			S 7616 A	
inner / interno	D2676LOH2	353	480	04/06	> 06/10			S 7646 A	
power steering / servosterzo	D2676LOH2	353	480	09/02	> 06/10				S 3081 PO
N 122/3	Mercedes Benz OM442.979	250	340	09/79	>	S 5133 PE		S 1050 A	
spheros aeroshere world / con climatizzatore sul tetto	Mercedes Benz OM442.979	250	340	09/79	>				S 3440 C
dryer filter / filtro essiccatore	Mercedes Benz OM442.979	250	340	09/79	>				S 7259 A
2 filters / N.2 filtri	Mercedes Benz OM442.979	250	340	09/79	>		S 2162 N		
power steering / servosterzo	Mercedes Benz OM442.979	250	340	09/79	>				S 3081 PO
N 122/3	Mercedes Benz OM442LA	370	503	09/95	> 12/04	S 5133 PE			
spheros aeroshere world / con climatizzatore sul tetto	Mercedes Benz OM442LA	370	503	09/95	> 12/04				S 3440 C
dryer filter / filtro essiccatore	Mercedes Benz OM442LA	370	503	09/95	> 12/04				S 7259 A
2 filters / N.2 filtri	Mercedes Benz OM442LA	370	503	09/95	> 12/04		S 2162 N	S 7187 A	
power steering / servosterzo	Mercedes Benz OM442LA	370	503	09/95	> 12/04				S 3081 PO
N 122/3 L	D2876LOH21	390	530	09/04	>	S 5016 PE	S 6016 NE		
spheros aeroshere world / con climatizzatore sul tetto	D2876LOH21	390	530	09/02	> 06/10				S 3440 C
dryer filter / filtro essiccatore	D2876LOH21	390	530	09/04	>				S 7259 A
power steering / servosterzo	D2876LOH21	390	530	09/04	>				S 3081 PO
Spaceliner									
N 117/2	Mercedes Benz OM422A	243	330	08/83	>	S 7261 PO	S 2162 N		
Starliner									
N 516	MAN D2866LOH23	294	401	09/96	>	S 7260 PO	S 4378 NR	S 1050 A	
with rear air-conditioner / con climatizzatore posteriore	MAN D2866LOH23	294	401	09/96	> 12/04				S 3446 C

N

**KW HP****...NEOPLAN - buses/autobus****N**

dryer filter / filtro essiccatore	MAN D2866LOH23	294	401	09/96	>				S 7259 A
power steering / servosterzo	MAN D2866LOH23	294	401	09/96	>				S 3081 PO
N 516	MAN D2876LOH01	338	461	09/96	>	S 5016 PE	S 4378 NR	S 1050 A	
with rear air-conditioner / con climatizzatore posteriore	MAN D2876LOH01	338	461	09/96	> 12/04				S 3446 C
dryer filter / filtro essiccatore	MAN D2876LOH01	338	461	09/96	>				S 7259 A
power steering / servosterzo	MAN D2876LOH01	338	461	09/96	>				S 3081 PO
N 516	Mercedes Benz OM442LA	280	382	09/96	>	S 5133 PE		S 1050 A	
with rear air-conditioner / con climatizzatore posteriore	Mercedes Benz OM442LA	280	382	09/96	> 12/04				S 3446 C
dryer filter / filtro essiccatore	Mercedes Benz OM442LA	280	382	09/96	>				S 7259 A
2 filters / N.2 filtri	Mercedes Benz OM442LA	280	382	09/96	>		S 2162 N		
power steering / servosterzo	Mercedes Benz OM442LA	280	382	09/96	>				S 3081 PO
N 516/3	MAN D2866LOH23	294	401	09/96	>	S 7260 PO	S 4378 NR	S 1050 A	
with rear air-conditioner / con climatizzatore posteriore	MAN D2866LOH23	294	401	09/96	>				S 3446 C
dryer filter / filtro essiccatore	MAN D2866LOH23	294	401	09/96	>				S 7259 A
power steering / servosterzo	MAN D2866LOH23	294	401	09/96	>				S 3081 PO
N 516/3	MAN D2866LOH29	301	410	09/02	>	S 7260 PO	S 4378 NR	S 1050 A	
with rear air-conditioner / con climatizzatore posteriore	MAN D2866LOH29	301	410	09/02	> 12/04				S 3446 C
dryer filter / filtro essiccatore	MAN D2866LOH29	301	410	09/02	>				S 7259 A
power steering / servosterzo	MAN D2866LOH29	301	410	09/02	>				S 3081 PO
N 516/3	MAN D2876LOH01	338	461	09/96	>	S 5016 PE	S 4378 NR	S 1050 A	
with rear air-conditioner / con climatizzatore posteriore	MAN D2876LOH01	338	461	09/96	> 12/04				S 3446 C
dryer filter / filtro essiccatore	MAN D2876LOH01	338	461	09/96	>				S 7259 A
power steering / servosterzo	MAN D2876LOH01	338	461	09/96	>				S 3081 PO
N 516/3	Mercedes Benz OM442LA	280	382	09/96	>	S 5133 PE		S 1050 A	
with rear air-conditioner / con climatizzatore posteriore	Mercedes Benz OM442LA	280	382	09/96	> 12/04				S 3446 C
dryer filter / filtro essiccatore	Mercedes Benz OM442LA	280	382	09/96	>				S 7259 A
2 filters / N.2 filtri	Mercedes Benz OM442LA	280	382	09/96	>		S 2162 N		
power steering / servosterzo	Mercedes Benz OM442LA	280	382	09/96	>				S 3081 PO
N 5217 SHD	MAN D2676LOHCR EEV	371	505	09/08	>	S 5046 PE	S 6011 NE	S 7644 A	S 3165 C
with activated carbons / ai carboni attivi	MAN D2676LOHCR EEV	371	505	09/08	>				S 4177 CA
with air-conditioner Webasto Aerosphere World / con climatizzatore Webasto Aerosphere World	MAN D2676LOHCR EEV	371	505	09/08	>				S 3283 C
dryer filter / filtro essiccatore	MAN D2676LOHCR EEV	371	505	09/08	>				S 7A66 A
inner / interno	MAN D2676LOHCR EEV	371	505	09/08	>			S 7646 A	
power steering / servosterzo	MAN D2676LOHCR EEV	371	505	09/08	>				S 3081 PO
N 5217 SHD	MAN D2876LOH20	353	480	05/05	>	S 5016 PE	S 6016 NE	S 7644 A	S 3165 C
with activated carbons / ai carboni attivi	MAN D2876LOH20	353	480	05/05	>				S 4177 CA
with air-conditioner Webasto Aerosphere World / con climatizzatore Webasto Aerosphere World	MAN D2876LOH20	353	480	05/05	>				S 3283 C
dryer filter / filtro essiccatore	MAN D2876LOH20	353	480	05/05	>				S 7A66 A
inner / interno	MAN D2876LOH20	353	480	05/05	>			S 7646 A	
power steering / servosterzo	MAN D2876LOH20	353	480	05/05	>				S 3081 PO
N 5218 SHD	MAN D2676LOH Euro4	353	480	07/06	>	S 5046 PE	S 6011 NE	S 7644 A	S 3165 C
with activated carbons / ai carboni attivi	MAN D2676LOH Euro4	353	480	07/06	>				S 4177 CA
with air-conditioner Webasto Aerosphere World / con climatizzatore Webasto Aerosphere World	MAN D2676LOH Euro4	353	480	07/06	>				S 3283 C
dryer filter / filtro essiccatore	MAN D2676LOH Euro4	353	480	07/06	>				S 7A66 A
inner / interno	MAN D2676LOH Euro4	353	480	07/06	>			S 7646 A	
power steering / servosterzo	MAN D2676LOH Euro4	353	480	07/06	>				S 3081 PO
N 5218 SHD	MAN D2676LOHCR EEV	371	505	09/08	>	S 5046 PE	S 6011 NE	S 7644 A	S 3165 C
with activated carbons / ai carboni attivi	MAN D2676LOHCR EEV	371	505	09/08	>				S 4177 CA
with air-conditioner Webasto Aerosphere World / con climatizzatore Webasto Aerosphere World	MAN D2676LOHCR EEV	371	505	09/08	>				S 3283 C
dryer filter / filtro essiccatore	MAN D2676LOHCR EEV	371	505	09/08	>				S 7A66 A
inner / interno	MAN D2676LOHCR EEV	371	505	09/08	>			S 7646 A	
power steering / servosterzo	MAN D2676LOHCR EEV	371	505	09/08	>				S 3081 PO
N 5218 SHD	MAN D2876LOH20	353	480	05/05	>	S 5016 PE	S 6016 NE	S 7644 A	S 3165 C
with activated carbons / ai carboni attivi	MAN D2876LOH20	353	480	05/05	>				S 4177 CA
with air-conditioner Webasto Aerosphere World / con climatizzatore Webasto Aerosphere World	MAN D2876LOH20	353	480	05/05	>				S 3283 C
dryer filter / filtro essiccatore	MAN D2876LOH20	353	480	05/05	>				S 7A66 A
inner / interno	MAN D2876LOH20	353	480	05/05	>			S 7646 A	
power steering / servosterzo	MAN D2876LOH20	353	480	05/05	>				S 3081 PO
N 5218 SHD	MAN D2876LOH21	390	530	05/05	>	S 5016 PE	S 6016 NE	S 7644 A	S 3165 C
with activated carbons / ai carboni attivi	MAN D2876LOH21	390	530	05/05	>				S 4177 CA
with air-conditioner Webasto Aerosphere World / con climatizzatore Webasto Aerosphere World	MAN D2876LOH21	390	530	05/05	>				S 3283 C
dryer filter / filtro essiccatore	MAN D2876LOH21	390	530	05/05	>				S 7A66 A
inner / interno	MAN D2876LOH21	390	530	05/05	>			S 7646 A	
power steering / servosterzo	MAN D2876LOH21	390	530	05/05	>				S 3081 PO
Tourliner									
N 2216 SHD	MAN D2866LOH034	301	410	09/03	>	S 5016 PE	S 6004 NE	S 1050 A	
with automatic air-conditioner, recirculation filter / con climatizzatore automatico, filtro ricircolo	MAN D2866LOH034	301	410	09/03	>				S 3448 C

**KW HP****...NEOPLAN - buses/autobus**

spheros aeroshere world / con climatizzatore sul tetto	MAN D2866LOH034	301	410	09/03	>			S 3440 C	
dryer filter / filtro essiccatore	MAN D2866LOH034	301	410	09/03	>			S 7259 A	
inner / interno	MAN D2866LOH034	301	410	09/03	>				
2 filters / N.2 filtri	MAN D2866LOH034	301	410	09/03	>		S 4378 NR	S 1307 A	
power steering / servosterzo	MAN D2866LOH034	301	410	09/03	>			S 3081 PO	
N 2216 SHD	MAN D2876LOH03	338	460	09/03	>	S 5016 PE	S 6004 NE	S 1050 A	
with automatic air-conditioner, recirculation filter / con climatizzatore automatico, filtro ricircolo	MAN D2876LOH03	338	460	09/03	>			S 3448 C	
dryer filter / filtro essiccatore	MAN D2876LOH03	338	460	09/03	>			S 7259 A	
inner / interno	MAN D2876LOH03	338	460	09/03	>			S 1307 A	
power steering / servosterzo	MAN D2876LOH03	338	460	09/03	>			S 3081 PO	
N 2216 SHD/SHD-L (P21/P22)	D2066LOH04	324	441	06/06	>	S 5046 PE	S 6011 NE	S 7644 A	
with automatic air-conditioner, recirculation filter / con climatizzatore automatico, filtro ricircolo	D2066LOH04	324	441	06/06	>			S 3448 C	
spheros aeroshere world / con climatizzatore sul tetto	D2066LOH04	324	441	06/06	>			S 3440 C	
dryer filter / filtro essiccatore	D2066LOH04	324	441	06/06	>			S 7259 A	
inner / interno	D2066LOH04	324	441	06/06	>			S 7646 A	
power steering / servosterzo	D2066LOH04	324	441	06/06	>			S 3081 PO	
N 2216 SHD/SHD-L (P21/P22)	D2676LOH26 EEV	324	441	06/06	>	S 5046 PE	S 6011 NE	S 7644 A	
with automatic air-conditioner, recirculation filter / con climatizzatore automatico, filtro ricircolo	D2676LOH26 EEV	324	441	06/06	>			S 3448 C	
dryer filter / filtro essiccatore	D2676LOH26 EEV	324	441	06/06	>			S 7259 A	
inner / interno	D2676LOH26 EEV	324	441	06/06	>			S 7646 A	
power steering / servosterzo	D2676LOH26 EEV	324	441	06/06	>			S 3081 PO	
N 2216 SHD/SHD-L (P21/P22)	MAN D2066LOH03/CR EEV	294	400	06/06	>	S 5046 PE	S 6011 NE	S 7644 A	
with automatic air-conditioner, recirculation filter / con climatizzatore automatico, filtro ricircolo	MAN D2066LOH03/CR EEV	294	400	06/06	>			S 3448 C	
dryer filter / filtro essiccatore	MAN D2066LOH03/CR EEV	294	400	06/06	>			S 7259 A	
inner / interno	MAN D2066LOH03/CR EEV	294	400	06/06	>			S 7646 A	
power steering / servosterzo	MAN D2066LOH03/CR EEV	294	400	06/06	>			S 3081 PO	
N 2216/3 SHD-L	MAN D2866LOH034	301	410	09/03	>	S 5016 PE	S 6004 NE	S 1050 A	
with automatic air-conditioner, recirculation filter / con climatizzatore automatico, filtro ricircolo	MAN D2866LOH034	301	410	09/03	>			S 3448 C	
dryer filter / filtro essiccatore	MAN D2866LOH034	301	410	09/03	>			S 7259 A	
inner / interno	MAN D2866LOH034	301	410	09/03	>			S 1307 A	
2 filters / N.2 filtri	MAN D2866LOH034	301	410	09/03	>		S 4378 NR		
power steering / servosterzo	MAN D2866LOH034	301	410	09/03	>			S 3081 PO	
N 2216/3 SHD-L	MAN D2876LOH03	338	460	09/03	>	S 5016 PE	S 6004 NE	S 1050 A	
with automatic air-conditioner, recirculation filter / con climatizzatore automatico, filtro ricircolo	MAN D2876LOH03	338	460	09/03	>			S 3448 C	
dryer filter / filtro essiccatore	MAN D2876LOH03	338	460	09/03	>			S 7259 A	
inner / interno	MAN D2876LOH03	338	460	09/03	>			S 1307 A	
2 filters / N.2 filtri	MAN D2876LOH03	338	460	09/03	>		S 4378 NR		
power steering / servosterzo	MAN D2876LOH03	338	460	09/03	>			S 3081 PO	
Transliner									
316 H	MAN D2866	221	300	11/90	>	S 7260 PO	S 4378 NR	S 1050 A	
some / alcuni	MAN D2866	221	300	11/90	>	S 7260 PO	S 1411 N	S 1050 A	
with automatic gearbox ZF HP500/590 / con cambio automatico ZF HP500/590	MAN D2866	221	300	11/90	>			S 2234 Z	
dryer filter / filtro essiccatore	MAN D2866	221	300	11/90	>			S 7259 A	
N 316 H	DAF DKV 1160	247	373	11/90	>	S 8600 R	S 8110 NR	S 1050 A	
with automatic gearbox ZF HP500/590 / con cambio automatico ZF HP500/590	DAF DKV 1160	247	373	11/90	>			S 2234 Z	
dryer filter / filtro essiccatore	DAF DKV 1160	247	373	11/90	>			S 7259 A	
power steering / servosterzo	DAF DKV 1160	247	373	11/90	>			S 3081 PO	
N 316 H	MAN D2866	199	271	11/90	>	S 7260 PO	S 4378 NR	S 1050 A	
some / alcuni	MAN D2866	199	271	11/90	>	S 7260 PO	S 1411 N	S 1050 A	
with automatic gearbox ZF HP500/590 / con cambio automatico ZF HP500/590	MAN D2866	199	271	11/90	>			S 2234 Z	
dryer filter / filtro essiccatore	MAN D2866	199	271	11/90	>			S 7259 A	
N 316 H	MAN D2866KOH	294	400	11/90	>	S 7260 PO	S 4378 NR	S 1050 A	
some / alcuni	MAN D2866KOH	294	400	11/90	>	S 7260 PO	S 1411 N	S 1050 A	
with automatic gear ZF HP500/590 / con cambio automatico ZF HP500/590	MAN D2866KOH	294	400	11/90	>			S 2234 Z	
dryer filter / filtro essiccatore	MAN D2866KOH	294	400	11/90	>			S 7259 A	
N 316 H	MAN D2866LOH	294	400	11/90	>	S 7260 PO	S 4378 NR	S 1050 A	
some / alcuni	MAN D2866LOH	294	400	11/90	>	S 7260 PO	S 1411 N	S 1050 A	
with automatic gear ZF HP500/590 / con cambio automatico ZF HP500/590	MAN D2866LOH	294	400	11/90	>			S 2234 Z	
dryer filter / filtro essiccatore	MAN D2866LOH	294	400	11/90	>			S 7259 A	
N 316 H	Mercedes Benz OM441.980	250	340	12/88	>	S 5133 PE		S 1050 A	
with automatic gear ZF HP500/590 / con cambio automatico ZF HP500/590	Mercedes Benz OM441.980	250	340	12/88	>			S 2234 Z	
dryer filter / filtro essiccatore	Mercedes Benz OM441.980	250	340	12/88	>			S 7259 A	
2 filters / N.2 filtri	Mercedes Benz OM441.980	250	340	12/88	>		S 2161 N		
power steering / servosterzo	Mercedes Benz OM441.980	250	340	12/88	>			S 3081 PO	
N 316 H	Mercedes Benz OM441.997	230	313	12/88	>	S 5133 PE		S 1050 A	
with automatic gear ZF HP500/590 / con cambio automatico ZF HP500/590	Mercedes Benz OM441.997	230	313	12/88	>			S 2234 Z	
dryer filter / filtro essiccatore	Mercedes Benz OM441.997	230	313	12/88	>			S 7259 A	

N



KW HP



...NEOPLAN - buses/autobus

2 filters / N.2 filtri	Mercedes Benz OM441.997	230	313	12/88	>		S 2161 N		
power steering / servosterzo	Mercedes Benz OM441.997	230	313	12/88	>				S 3081 PO
N 316 H	Mercedes Benz OM442A	235	320	11/90	>	S 7261 PO	S 2162 N	S 1050 A	
with automatic gear ZF HP500/590 / con cambio automatico ZF HP500/590	Mercedes Benz OM442A	235	320	11/90	>				S 2234 Z
dryer filter / filtro essiccatore	Mercedes Benz OM442A	235	320	11/90	>				S 7259 A
power steering / servosterzo	Mercedes Benz OM442A	235	320	11/90	>				S 3081 PO
Trendliner									
N 3516 UE	MAN D2866LUH	228	310	09/04	>	S 7260 PO	S 6016 NE	S 7A23 A	S 3165 C
with activated carbons / ai carboni attivi	MAN D2866LUH	228	310	09/04	>				S 4177 CA
dryer filter / filtro essiccatore	MAN D2866LUH	228	310	09/04	>				S 7259 A
inner / interno	MAN D2866LUH	228	310	09/04	>			S 7616 A	
power steering / servosterzo	MAN D2866LUH	228	310	09/04	>				S 3081 PO
N 3516 UE	MAN D2866LUH	265	360	09/04	>	S 7260 PO	S 6016 NE	S 7A23 A	S 3165 C
with activated carbons / ai carboni attivi	MAN D2866LUH	265	360	09/04	>				S 4177 CA
dryer filter / filtro essiccatore	MAN D2866LUH	265	360	09/04	>				S 7259 A
inner / interno	MAN D2866LUH	265	360	09/04	>			S 7616 A	
power steering / servosterzo	MAN D2866LUH	265	360	09/04	>				S 3081 PO
N 3516 UE	MAN D2866LUH	301	409	09/04	>	S 7260 PO	S 6016 NE	S 7A23 A	S 3165 C
with activated carbons / ai carboni attivi	MAN D2866LUH	301	409	09/04	>				S 4177 CA
dryer filter / filtro essiccatore	MAN D2866LUH	301	409	09/04	>				S 7259 A
inner / interno	MAN D2866LUH	301	409	09/04	>			S 7616 A	
power steering / servosterzo	MAN D2866LUH	301	409	09/04	>				S 3081 PO
N 3516/3 UE	MAN D2866LUH	301	409	09/04	>	S 7260 PO	S 6016 NE	S 7A23 A	S 3165 C
with activated carbons / ai carboni attivi	MAN D2866LUH	301	409	09/04	>				S 4177 CA
dryer filter / filtro essiccatore	MAN D2866LUH	301	409	09/04	>				S 7259 A
inner / interno	MAN D2866LUH	301	409	09/04	>			S 7616 A	
power steering / servosterzo	MAN D2866LUH	301	409	09/04	>				S 3081 PO
N 3517 UE	MAN D2066LUH	287	390	07/06	>	S 5046 PE	S 6011 NE	S 7A11 A	S 3165 C
with activated carbons / ai carboni attivi	MAN D2066LUH	287	390	07/06	>				S 4177 CA
inner / interno	MAN D2066LUH	287	390	07/06	>			S 7649 A	
power steering / servosterzo	MAN D2066LUH	287	390	07/06	>				S 3081 PO

NISSAN

trucks/autocarri

Atleon									
110.35	BD30Ti	81	110	02/00	>	05/01	S 3102 R	S 1410 NR	S 7516 A
	BD30Ti	81	110	06/01	>	10/06	S 3102 R	S 4444 NR	S 7516 A
110.45	BD30Ti	81	110	02/00	>	05/01	S 3102 R	S 1410 NR	S 7516 A
	BD30Ti	81	110	06/01	>	10/06	S 3102 R	S 4444 NR	S 7516 A
110.56	BD30Ti	81	110	02/00	>	05/01	S 3102 R	S 1410 NR	S 7516 A
	BD30Ti	81	110	06/01	>	10/06	S 3102 R	S 4444 NR	S 7516 A
12.035	BD30Ti/Ti E	92	125	07/04	>	10/06	S 3102 R	S 4444 NR	S 7679 A
12.056	BD30Ti/Ti E	92	125	07/04	>	10/06	S 3102 R	S 4444 NR	S 7679 A
12.35H	BD30Ti/Ti E	92	125	07/04	>	10/06	S 3102 R	S 4444 NR	S 7679 A
120.035	BD30Ti	88	120	01/01	>	05/01	S 3102 R	S 1410 NR	S 7516 A
	BD30Ti	88	120	06/01	>	10/06	S 3102 R	S 4444 NR	S 7516 A
120.035H	BD30Ti	88	120	01/01	>	05/01	S 3102 R	S 1410 NR	S 7516 A
	BD30Ti	88	120	06/01	>	10/06	S 3102 R	S 4444 NR	S 7516 A
120.05	BD30Ti	88	120	01/01	>	05/01	S 3102 R	S 1410 NR	S 7516 A
	BD30Ti	88	120	06/01	>	10/06	S 3102 R	S 4444 NR	S 7516 A
120.056	BD30Ti	88	120	01/01	>	05/01	S 3102 R	S 1410 NR	S 7516 A
	BD30Ti	88	120	06/01	>	10/06	S 3102 R	S 4444 NR	S 7516 A
120.22	Cummins ISB4-6L	165	224	11/06	>		S 0620 R	S 2220 NR	
130.22	Cummins ISB4-6L	165	224	11/06	>		S 0620 R	S 2220 NR	
130.25	Cummins ISB4-6H	184	250	11/06	>		S 0620 R	S 2220 NR	
14.080	B4.40Ti	101	137	07/04	>	10/06	S 9400 R	S 4444 NR	S 7516 A
140.080	B4.40Ti	103	140	01/01	>	05/01	S 9400 R	S 1410 NR	S 7516 A
	B4.40Ti	103	140	06/01	>	10/06	S 9400 R	S 4444 NR	S 7516 A
140.75	B4.40Ti	100	136	09/00	>	05/01	S 9400 R	S 1410 NR	S 7516 A
	B4.40Ti	100	136	06/01	>	10/06	S 9400 R	S 4444 NR	S 7516 A
140.80	B4.40Ti	103	140	02/00	>	05/01	S 9400 R	S 1410 NR	S 7516 A
	B4.40Ti	103	140	06/01	>	10/06	S 9400 R	S 4444 NR	S 7516 A
150.25	Cummins ISB4-6H	184	250	11/06	>		S 0620 R	S 2220 NR	
150.25D	Cummins ISB4-6H	184	250	11/06	>		S 0620 R	S 2220 NR	
16.095	B6.60TiL	117	159	07/04	>	10/06	S 0420 R	S 4444 NR	S 2650 A
16.120	B6.60TiL	117	159	07/04	>	10/06	S 0420 R	S 4444 NR	S 2650 A
16.130	B6.60TiL	117	159	07/04	>	10/06	S 0420 R	S 4444 NR	S 2650 A
165.095	B60.60Ti (H)	120	163	07/04	>	10/06	S 0420 R	S 4444 NR	S 2650 A



KW HP



...NISSAN - trucks/autocarri

165.120	BD6.60Ti	121	165	02/00 >	05/01	S 0420 R	S 1410 NR	S 2650 A	
	BD6.60Ti	121	165	06/01 >	10/06	S 0420 R	S 4444 NR	S 2650 A	
165.130	BD6.60Ti	121	165	02/00 >	05/01	S 0420 R	S 1410 NR	S 2650 A	
	BD6.60Ti	121	165	06/01 >	10/06	S 0420 R	S 4444 NR	S 2650 A	
165.75	B60.60Ti (N)	117	159	02/00 >	05/01	S 0420 R	S 1410 NR	S 2650 A	
	B60.60Ti (N)	117	159	06/01 >	10/06	S 0420 R	S 4444 NR	S 2650 A	
210.130	B60.60Ti (H)	154	210	02/00 >	05/01	S 0420 R	S 1410 NR	S 2650 A	
	B60.60Ti (H)	154	210	06/01 >	10/06	S 0420 R	S 4444 NR	S 2650 A	
210.150	B60.60Ti (H)	154	210	02/00 >	05/01	S 0420 R	S 1410 NR	S 2650 A	
	B60.60Ti (H)	154	210	06/01 >	10/06	S 0420 R	S 4444 NR	S 2650 A	
35.13	BD30Ti/Ti E	92	125	07/04 >	10/06	S 3102 R	S 4444 NR	S 7679 A	
35.15	ZD30	110	150	08/06 >		S 5026 PE	S 4444 NR	S 9380 A	✗
35H.15	ZD30	110	150	08/06 >		S 5026 PE	S 4444 NR	S 9380 A	✗
56.13	BD30Ti/Ti E	92	125	07/04 >	10/06	S 3102 R	S 4444 NR	S 7679 A	
56.15	ZD30	110	150	08/06 >		S 5026 PE	S 4444 NR	S 9380 A	✗
70.14	Cummins ISB4-4L	103	140	11/06 >		S 0620 R	S 2220 NR		
80.14	B4.40Ti	101	137	07/04 >	10/06	S 9400 R	S 4444 NR	S 7516 A	
80.19	Cummins ISB4-4H	136	185	11/06 >		S 0620 R	S 2220 NR		
95.16	B6.60TiL	117	159	07/04 >	10/06	S 0420 R	S 4444 NR	S 2650 A	
95.19	Cummins ISB4-4H	136	185	11/06 >		S 0620 R	S 2220 NR		
95.22	Cummins ISB4-6L	165	224	11/06 >		S 0620 R	S 2220 NR		
ECO-T									
100.35	BD30Ti	80	108	07/96 >		S 3102 R	S 1410 NR	S 7516 A	✗
100.56	BD30Ti	79	108	07/96 >		S 3102 R	S 1410 NR	S 7516 A	✗
135.80	B4.40Ti	102	138	07/96 >		S 3102 R	S 1410 NR	S 7516 A	✗
160.110	B6.60Ti	119	162	07/96 >		S 0420 R	S 1410 NR	S 2650 A	✗
160.130	B6.60Ti	119	162	07/96 >		S 0420 R	S 1410 NR	S 2650 A	✗
160.90	B6.60Ti	119	162	07/96 >		S 0420 R	S 1410 NR	S 2650 A	✗
200.150	B6.60Ti	154	209	07/96 >		S 0420 R	S 1410 NR	S 2650 A	✗
F Serie									
F 45	BD 30			04/93 >		S 3102 R	S 1410 NR	S 0650 A	
L Serie									
L 35	A 4.28						S 7111 NC	S 0650 A	
L 35	Perkins 4.165					S 0420 R	S 7111 NC	S 0650 A	
L 35 S	Perkins 4.236						S 7111 NC	S 0650 A	
L 35 SF	Perkins 4.236						S 7111 NC	S 0650 A	
L 35.08	A 4.28 II						S 7111 NC	S 0650 A	
L 35.08 F	A 4.28 II						S 7111 NC	S 0650 A	
L 35.085	BD 30			04/93 >		S 3102 R	S 1410 NR		
L 35.09	B 4.40						S 1410 NR	S 4940 A	
L 45	BD 30			04/93 >		S 3102 R	S 1410 NR		
L 45	Perkins 4.236					S 9610 R	S 7111 NC	S 0650 A	
L 45.08	A 4.28 II						S 7111 NC	S 0650 A	
L 45.08 F	A 4.28 II						S 7111 NC	S 0650 A	
L 50.09	B 4.40						S 1410 NR	S 4940 A	
L 50.09 F	B 4.40						S 1410 NR	S 4940 A	
L 60	Perkins 4.236						S 7111 NC	S 0650 A	
L 60.09	B 4.40						S 1410 NR	S 4940 A	
L 70.09	B 4.40						S 1410 NR	S 4940 A	
L 80	Perkins 4.236						S 7111 NC	S 0650 A	
L 80	Perkins 6.345.3					S 9610 R	S 8111 NC	S 0950 A	
L 80 Turbo	Perkins T 4.236					S 0420 R	S 7111 NC		
L 80.09	B 4.40						S 1410 NR	S 4940 A	
L 80.09 DC	B 4.40						S 1410 NR	S 4940 A	
L 80.09 F	B 4.40						S 1410 NR	S 4940 A	
L 80.14	B 6.60					S 0420 R	S 1410 NR	S 2450 A	
M Serie									
M 110.14	B 6.60					S 0420 R	S 1410 NR	S 2450 A	
M 110.14 DC	B 6.60					S 0420 R	S 1410 NR	S 2450 A	
M 125.14	B 6.60					S 0420 R	S 1410 NR	S 2450 A	
M 125.14 BC	B 6.60					S 0420 R	S 1410 NR	S 2450 A	
M 125.17 Turbo	B 6.60					S 0420 R	S 1410 NR	S 2450 A	
M 130.17	Nissan ND FE6 B							S 2450 A	
M 140.17	Nissan ND FE 6 B							S 2450 A	
M 140.230 Turbo Intercooler	Nissan FE 6 TA							S 2650 A	
NT500									
56.15	ZD30	110	150	04/14 >		S 5026 PE	S 1411 GC	S 9380 A	

N





kW HP



...NISSAN - trucks/autocarri

65.15	ZD30	110	150	04/14	>	S 5026 PE	S 1411 GC	S 9380 A	
75.18	ZD30	130	177	04/14	>	S 5026 PE	S 1411 GC	S 9380 A	
Quon									
ADG-CD4ZA									
with filter Urea/Adblue / con filtro Urea/Adblue	GE13TA	257	349	02/05	>				S 4401 U
ADG-CD4ZA									
with filter Urea/Adblue / con filtro Urea/Adblue	GE13TB	279	380	02/05	>				S 4401 U
ADG-CD4ZA									
with filter Urea/Adblue / con filtro Urea/Adblue	GE13TC	302	410	02/05	>				S 4401 U
ADG-CG4ZA									
with filter Urea/Adblue / con filtro Urea/Adblue	GE13TB	279	380	02/05	>				S 4401 U
LDG-CD5ZA	GH11TB	279	380	04/10	>		S 4120 NR		
LDG-CD5ZE	GH11TB	279	380	04/10	>		S 4120 NR		
LDG-CG5ZA	GH11TB	279	380	04/10	>		S 4120 NR		
LDG-CW5XL	GH11TB	279	380	04/10	>		S 4120 NR		
LKG-CD5ZE	GH11TC	302	410	04/10	>		S 4120 NR		
LKG-CD5ZL	GH11TA	257	350	04/10	>		S 4120 NR		
LKG-CG5ZE	GH11TC	302	410	04/10	>		S 4120 NR		
LKG-CW5YL	GH11TC	302	410	04/10	>		S 4120 NR		
LKG-CW5ZL	GH11TC	302	410	04/10	>		S 4120 NR		
OPTARE GROUP									
buses/autobus									
Alero									
2.8 Turbodiesel	Iveco 8140.43	92	125	04/01	>	S 3003 DR		S 7356 A	
Alero Plus									
AL01	Iveco F1C Euro4	107	146	09/06	>	S 0920 R		S 7356 A	
AL02	Iveco F1C Euro4	107	146	09/06	>	S 0920 R		S 7356 A	
AL03	Iveco F1C Euro4	107	146	09/06	>	S 0920 R		S 7356 A	
AL04	Iveco F1C Euro4	107	146	09/06	>	S 0920 R		S 7356 A	
Olympus (B9TL)									
11 m	Volvo D9B260	191	260	11/06	>		S 9320 NR		S 9006 AR
by-pass	Volvo D9B260	191	260	11/06	>	S 4120 R			
with automatic gearbox / con cambio automatico	Volvo D9B260	191	260	11/06	>				S 5238 PE
LONG LIFE	Volvo D9B260	191	260	11/06	>		S 4120 NR		
2 filters / N.2 filtri	Volvo D9B260	191	260	11/06	>	S 4402 R			
11 m	Volvo D9B310	228	310	11/06	>		S 9320 NR		S 9006 AR
by-pass	Volvo D9B310	228	310	11/06	>	S 4120 R			
with automatic gearbox / con cambio automatico	Volvo D9B310	228	310	11/06	>				S 5238 PE
LONG LIFE	Volvo D9B310	228	310	11/06	>		S 4120 NR		
2 filters / N.2 filtri	Volvo D9B310	228	310	11/06	>	S 4402 R			
12 m	Volvo D9B260	191	260	11/06	>		S 9320 NR		S 9006 AR
by-pass	Volvo D9B260	191	260	11/06	>	S 4120 R			
with automatic gearbox / con cambio automatico	Volvo D9B260	191	260	11/06	>				S 5238 PE
LONG LIFE	Volvo D9B260	191	260	11/06	>		S 4120 NR		
2 filters / N.2 filtri	Volvo D9B260	191	260	11/06	>	S 4402 R			
12 m	Volvo D9B310	228	310	11/06	>		S 9320 NR		S 9006 AR
by-pass	Volvo D9B310	228	310	11/06	>	S 4120 R			
with automatic gearbox / con cambio automatico	Volvo D9B310	228	310	11/06	>				S 5238 PE
LONG LIFE	Volvo D9B310	228	310	11/06	>		S 4120 NR		
2 filters / N.2 filtri	Volvo D9B310	228	310	11/06	>	S 4402 R			
Solo/Solo SE/Solo SR									
M1020	Cummins ISBe Euro4	150	205	09/06	>	S 0620 R	S 2220 NR		
with filter Urea/Adblue / con filtro Urea/Adblue	Cummins ISBe Euro4	150	205	09/06	>				S 4401 U
power steering / servosterzo	Cummins ISBe Euro4	150	205	09/06	>				S 3081 PO
M1020	MAN D0834 Euro4	132	180	09/06	>	S 5095 PE	S 6011 NE		
power steering / servosterzo	MAN D0834 Euro4	132	180	09/06	>				S 3081 PO
M1020	Mercedes Benz OM904LA Euro4	115	156	09/06	>	S 5007 PE	S 6017 NE		
power steering / servosterzo	Mercedes Benz OM904LA Euro4	115	156	09/06	>				S 3081 PO
M710SE	Cummins ISBe Euro4	150	205	09/06	>	S 0620 R	S 2220 NR		
with filter Urea/Adblue / con filtro Urea/Adblue	Cummins ISBe Euro4	150	205	09/06	>				S 4401 U
power steering / servosterzo	Cummins ISBe Euro4	150	205	09/06	>				S 3081 PO
M710SE	MAN D0834 Euro4	132	180	09/06	>	S 5095 PE	S 6011 NE		
power steering / servosterzo	MAN D0834 Euro4	132	180	09/06	>				S 3081 PO
M710SE	Mercedes Benz OM904LA Euro4	115	156	09/06	>	S 5007 PE	S 6017 NE		
power steering / servosterzo	Mercedes Benz OM904LA Euro4	115	156	09/06	>				S 3081 PO
M710SE	Mercedes Benz OM904LA Euro4/5	95	129	09/06	>	S 5007 PE	S 6017 NE		
power steering / servosterzo	Mercedes Benz OM904LA Euro4/5	95	129	09/06	>				S 3081 PO

**KW HP****...OPTARE GROUP - buses/autobus**

M780SE	Cummins ISBe Euro4	150	205	09/06	>	S 0620 R	S 2220 NR		
with filter Urea/Adblue / con filtro Urea/Adblue	Cummins ISBe Euro4	150	205	09/06	>				S 4401 U
power steering / servosterzo	Cummins ISBe Euro4	150	205	09/06	>				S 3081 PO
M780SE	MAN D0834 Euro4	132	180	09/06	>	S 5095 PE	S 6011 NE		
power steering / servosterzo	MAN D0834 Euro4	132	180	09/06	>				S 3081 PO
M780SE	Mercedes Benz OM904LA Euro4	115	156	09/06	>	S 5007 PE	S 6017 NE		
power steering / servosterzo	Mercedes Benz OM904LA Euro4	115	156	09/06	>				S 3081 PO
M780SE	Mercedes Benz OM904LA Euro4/5	95	129	09/06	>	S 5007 PE	S 6017 NE		
power steering / servosterzo	Mercedes Benz OM904LA Euro4/5	95	129	09/06	>				S 3081 PO
M810	Cummins ISBe Euro4	150	205	09/06	>	S 0620 R	S 2220 NR		
with filter Urea/Adblue / con filtro Urea/Adblue	Cummins ISBe Euro4	150	205	09/06	>				S 4401 U
power steering / servosterzo	Cummins ISBe Euro4	150	205	09/06	>				S 3081 PO
M810	MAN D0834 Euro4	132	180	09/06	>	S 5095 PE	S 6011 NE		
power steering / servosterzo	MAN D0834 Euro4	132	180	09/06	>				S 3081 PO
M810	Mercedes Benz OM904LA Euro4	115	156	09/06	>	S 5007 PE	S 6017 NE		
power steering / servosterzo	Mercedes Benz OM904LA Euro4	115	156	09/06	>				S 3081 PO
M880	Cummins ISBe Euro4	150	205	09/06	>	S 0620 R	S 2220 NR		
with filter Urea/Adblue / con filtro Urea/Adblue	Cummins ISBe Euro4	150	205	09/06	>				S 4401 U
power steering / servosterzo	Cummins ISBe Euro4	150	205	09/06	>				S 3081 PO
M880	MAN D0834 Euro4	132	180	09/06	>	S 5095 PE	S 6011 NE		
power steering / servosterzo	MAN D0834 Euro4	132	180	09/06	>				S 3081 PO
M880	Mercedes Benz OM904LA Euro4	115	156	09/06	>	S 5007 PE	S 6017 NE		
power steering / servosterzo	Mercedes Benz OM904LA Euro4	115	156	09/06	>				S 3081 PO
M950	Cummins ISBe4 Euro4	150	205	09/06	>	S 0620 R	S 2220 NR		
with filter Urea/Adblue / con filtro Urea/Adblue	Cummins ISBe4 Euro4	150	205	09/06	>				S 4401 U
power steering / servosterzo	Cummins ISBe4 Euro4	150	205	09/06	>				S 3081 PO
M950	MAN D0834 Euro4	132	180	09/06	>	S 5095 PE	S 6011 NE		
power steering / servosterzo	MAN D0834 Euro4	132	180	09/06	>				S 3081 PO
M950	Mercedes Benz OM904LA Euro4	115	156	09/06	>	S 5007 PE	S 6017 NE		
power steering / servosterzo	Mercedes Benz OM904LA Euro4	115	156	09/06	>				S 3081 PO
Soroco									
515 CDI									
with water presence sensor / con sensore presenza acqua	Mercedes Benz OM646LA Euro4	110	150	05/06	>	S 5013 PE	S 4107 NR	S 3340 A	
without water presence sensor / senza sensore presenza acqua	Mercedes Benz OM646LA Euro4	110	150	05/06	>	S 5013 PE	S 2320 NR	S 3340 A	
Tempo									
X1060	Mercedes Benz OM906LA Euro4	210	286	05/06	>	S 5036 PE	S 6017 NE		
with automatic gearbox and hydraulic retarder ZF 6HP500 / con cambio automatico e rallentatore idraulico ZF 6HP500	Mercedes Benz OM906LA Euro4	210	286	05/06	>				S 2234 Z
power steering / servosterzo	Mercedes Benz OM906LA Euro4	210	286	05/06	>				S 3081 PO
X1130	Mercedes Benz OM906LA Euro4	210	286	05/06	>	S 5036 PE	S 6017 NE		
with automatic gearbox and hydraulic retarder ZF 6HP500 / con cambio automatico e rallentatore idraulico ZF 6HP500	Mercedes Benz OM906LA Euro4	210	286	05/06	>				S 2234 Z
power steering / servosterzo	Mercedes Benz OM906LA Euro4	210	286	05/06	>				S 3081 PO
X1200	Mercedes Benz OM906LA Euro4	210	286	05/06	>	S 5036 PE	S 6017 NE		
with automatic gearbox and hydraulic retarder ZF 6HP500 / con cambio automatico e rallentatore idraulico ZF 6HP500	Mercedes Benz OM906LA Euro4	210	286	05/06	>				S 2234 Z
power steering / servosterzo	Mercedes Benz OM906LA Euro4	210	286	05/06	>				S 3081 PO
X1260	Mercedes Benz OM906LA Euro4	210	286	05/06	>	S 5036 PE	S 6017 NE		
with automatic gearbox and hydraulic retarder ZF 6HP500 / con cambio automatico e rallentatore idraulico ZF 6HP500	Mercedes Benz OM906LA Euro4	210	286	05/06	>				S 2234 Z
power steering / servosterzo	Mercedes Benz OM906LA Euro4	210	286	05/06	>				S 3081 PO
Toro									
816D	Mercedes Benz OM904LA Euro4	115	156	03/06	>	S 5007 PE	S 6017 NE	S 3059 A	
power steering / servosterzo	Mercedes Benz OM904LA Euro4	115	156	03/06	>				S 3081 PO
PADANE							buses/autobus		
Opera									
Opera	Renault MIDR06.20.45			09/91	>	S 0900 R	S 4323 NR		
with automatic gearbox ZF HP500/590 / con cambio automatico ZF HP500/590	Renault MIDR06.20.45			09/91	>				S 2234 Z
X Serie									
X 303	Mercedes Benz OM422			05/84	>	S 7261 PO	S 2162 N		
with automatic gearbox ZF HP500/590 / con cambio automatico ZF HP500/590	Mercedes Benz OM422			05/84	>				S 2234 Z
X 370.12.30	Aifo-Iveco 8210.22			01/84	>	S 5003 DR	S 0710 NR		
with automatic gearbox ZF HP500/590 / con cambio automatico ZF HP500/590	Aifo-Iveco 8210.22			01/84	>				S 2234 Z
X B10	Volvo THD101KC			01/88	>	S 0900 R	S 4323 NR		
by-pass	Volvo THD101KC			01/88	>	S 4120 R			
with automatic gearbox ZF HP500/590 / con cambio automatico ZF HP500/590	Volvo THD101KC			01/88	>				S 2234 Z
Z Serie									
303	Mercedes Benz OM422			05/84	>	S 7261 PO	S 2162 N		
with automatic gearbox ZF HP500/590 / con cambio automatico ZF HP500/590	Mercedes Benz OM422			05/84	>				S 2234 Z
309	Mercedes Benz OM421			05/84	>	S 8260 PO	S 2162 N		

P



kW HP



...PADANE - buses/autobus

some / alcuni	Mercedes Benz OM421	05/84 >	S 7261 PO	S 2162 N		
with automatic gearbox ZF HP500/590 / con cambio automatico ZF HP500/590	Mercedes Benz OM421	05/84 >				S 2234 Z
370.10.24	Aifo-Iveco 8220.22	04/84 > 12/88	S 8600 R	S 0710 NR		S 8410 AR
some / alcuni	Aifo-Iveco 8220.22	04/84 > 12/88	S 0230 R	S 5401 NR		
some / alcuni	Aifo-Iveco 8220.22	04/84 > 12/88	S 5003 DR	S 0710 NR		
with automatic gearbox ZF HP500/590 / con cambio automatico ZF HP500/590	Aifo-Iveco 8220.22	04/84 > 12/88				S 2234 Z
or / oppure	Aifo-Iveco 8220.22	04/84 > 12/88		S 5400 NR		
370.12.30	Aifo-Iveco 8210.22	01/84 > 12/85	S 0230 R	S 0710 NR		
	Aifo-Iveco 8210.22	01/86 >	S 5003 DR	S 0710 NR		
with automatic gearbox ZF HP500/590 / con cambio automatico ZF HP500/590	Aifo-Iveco 8210.22	01/84 >				S 2234 Z

PEGASO

trucks/autocarri

100 Serie

100.28			S 1563 R	S 8500 NR	S 0950 A	
with hexagonal release nut / con dado di smontaggio esagonale						
100.32			S 1563 R	S 8500 NR	S 0950 A	
with hexagonal release nut / con dado di smontaggio esagonale						
100.35			S 1563 R	S 8500 NR	S 0950 A	
with hexagonal release nut / con dado di smontaggio esagonale						
100.40			S 1563 R	S 8500 NR	S 0950 A	
with hexagonal release nut / con dado di smontaggio esagonale						
100.46			S 1563 R	S 8500 NR	S 0950 A	
with hexagonal release nut / con dado di smontaggio esagonale						
100.50			S 1563 R	S 8500 NR	S 0950 A	
with hexagonal release nut / con dado di smontaggio esagonale						
100.56			S 1563 R	S 8500 NR	S 0950 A	
with hexagonal release nut / con dado di smontaggio esagonale						

1000 Serie

1061				S 6645 N		
2nd passage / 2.passaggio				S 7111 NC		
1061 A				S 6645 N		
2nd passage / 2.passaggio				S 7111 NC		
1061 BL/50				S 6645 N		
2nd passage / 2.passaggio				S 7111 NC		
1061 EL				S 6645 N		
2nd passage / 2.passaggio				S 7111 NC		
1061 L				S 6645 N		
2nd passage / 2.passaggio				S 7111 NC		
1061 L/50				S 6645 N		
2nd passage / 2.passaggio				S 7111 NC		
1061 LA				S 6645 N		
2nd passage / 2.passaggio				S 7111 NC		
1061/50				S 6645 N		
2nd passage / 2.passaggio				S 7111 NC		
1063				S 6645 N		
2nd passage / 2.passaggio				S 7111 NC		
1063 LA				S 6645 N		
2nd passage / 2.passaggio				S 7111 NC		
1063/50				S 6645 N		
2nd passage / 2.passaggio				S 7111 NC		
1064				S 6645 N		
2nd passage / 2.passaggio				S 7111 NC		
1064 A2				S 6645 N		
2nd passage / 2.passaggio				S 7111 NC		
1064/1				S 6645 N		
2nd passage / 2.passaggio				S 7111 NC		
1064/2				S 6645 N		
2nd passage / 2.passaggio				S 7111 NC		
1065				S 6645 N		
2nd passage / 2.passaggio				S 7111 NC		
1065 A				S 6645 N		
2nd passage / 2.passaggio				S 7111 NC		
1065 A/1C				S 6645 N		
2nd passage / 2.passaggio				S 7111 NC		
1065 A1				S 6645 N		
2nd passage / 2.passaggio				S 7111 NC		
1065 B				S 6645 N		



kW HP



...PEGASO - trucks/autocarri

2nd passage / 2.passaggio				S 7111 NC		
1065 B/1				S 6645 N		
2nd passage / 2.passaggio				S 7111 NC		
1065 B/3				S 6645 N		
2nd passage / 2.passaggio				S 7111 NC		
1065 B/4				S 6645 N		
2nd passage / 2.passaggio				S 7111 NC		
1065 B/5				S 6645 N		
2nd passage / 2.passaggio				S 7111 NC		
1065 B/6				S 6645 N		
2nd passage / 2.passaggio				S 7111 NC		
1065 B/8				S 6645 N		
2nd passage / 2.passaggio				S 7111 NC		
1065 BL				S 6645 N		
2nd passage / 2.passaggio				S 7111 NC		
1065 BL/1				S 6645 N		
2nd passage / 2.passaggio				S 7111 NC		
1065 BL/6				S 6645 N		
2nd passage / 2.passaggio				S 7111 NC		
1065 BL/8				S 6645 N		
2nd passage / 2.passaggio				S 7111 NC		
1065 BV				S 6645 N		
2nd passage / 2.passaggio				S 7111 NC		
1065 BV/3				S 6645 N		
2nd passage / 2.passaggio				S 7111 NC		
1065 BV/5				S 6645 N		
2nd passage / 2.passaggio				S 7111 NC		
1065 BV/6				S 6645 N		
2nd passage / 2.passaggio				S 7111 NC		
1065 L				S 6645 N		
2nd passage / 2.passaggio				S 7111 NC		
1065 LA				S 6645 N		
2nd passage / 2.passaggio				S 7111 NC		
1065 LA 1				S 6645 N		
2nd passage / 2.passaggio				S 7111 NC		
1065 LB3				S 6645 N		
2nd passage / 2.passaggio				S 7111 NC		
1065 LB4				S 6645 N		
2nd passage / 2.passaggio				S 7111 NC		
1065 LB5				S 6645 N		
2nd passage / 2.passaggio				S 7111 NC		
1065 V				S 6645 N		
2nd passage / 2.passaggio				S 7111 NC		
1065/1				S 6645 N		
2nd passage / 2.passaggio				S 7111 NC		
1065/1 L				S 6645 N		
2nd passage / 2.passaggio				S 7111 NC		
1065/32				S 6645 N		
2nd passage / 2.passaggio				S 7111 NC		
1065/35				S 6645 N		
2nd passage / 2.passaggio				S 7111 NC		
1065/40				S 6645 N		
2nd passage / 2.passaggio				S 7111 NC		
1066 A1				S 6645 N		
2nd passage / 2.passaggio				S 7111 NC		
1066 A2				S 6645 N		
2nd passage / 2.passaggio				S 7111 NC		
1066/1				S 6645 N		
2nd passage / 2.passaggio				S 7111 NC		
1066/2				S 6645 N		
2nd passage / 2.passaggio				S 7111 NC		
1066/3				S 6645 N		
2nd passage / 2.passaggio				S 7111 NC		
1066/51				S 6645 N		
2nd passage / 2.passaggio				S 7111 NC		
1066/52				S 6645 N		
2nd passage / 2.passaggio				S 7111 NC		





kW HP



...PEGASO - trucks/autocarri

P



1067 2nd passage / 2.passaggio			S 6645 N S 7111 NC		
1080 2nd passage / 2.passaggio			S 6645 N S 7111 NC		
1080 L 2nd passage / 2.passaggio			S 6645 N S 7111 NC		
1080 L/3 2nd passage / 2.passaggio			S 6645 N S 7111 NC		
1080 L/50 2nd passage / 2.passaggio			S 6645 N S 7111 NC		
1080 L/53 2nd passage / 2.passaggio			S 6645 N S 7111 NC		
1080 L/60 2nd passage / 2.passaggio			S 6645 N S 7111 NC		
1080 L/63 2nd passage / 2.passaggio			S 6645 N S 7111 NC		
1080/11 2nd passage / 2.passaggio			S 6645 N S 7111 NC		
1080/14 2nd passage / 2.passaggio			S 6645 N S 7111 NC		
1080/20 2nd passage / 2.passaggio			S 6645 N S 7111 NC		
1080/21 2nd passage / 2.passaggio			S 6645 N S 7111 NC		
1080/23 2nd passage / 2.passaggio			S 6645 N S 7111 NC		
1080/24 2nd passage / 2.passaggio			S 6645 N S 7111 NC		
1080/3 2nd passage / 2.passaggio			S 6645 N S 7111 NC		
1080/50 2nd passage / 2.passaggio			S 6645 N S 7111 NC		
1080/53 2nd passage / 2.passaggio			S 6645 N S 7111 NC		
1080/60 2nd passage / 2.passaggio			S 6645 N S 7111 NC		
1080/61 2nd passage / 2.passaggio			S 6645 N S 7111 NC		
1080/63 2nd passage / 2.passaggio			S 6645 N S 7111 NC		
1080/65 2nd passage / 2.passaggio			S 6645 N S 7111 NC		
1083 2nd passage / 2.passaggio			S 6645 N S 7111 NC		
1083/10 2nd passage / 2.passaggio			S 6645 N S 7111 NC		
1083/3 2nd passage / 2.passaggio			S 6645 N S 7111 NC		
1083/30 2nd passage / 2.passaggio			S 6645 N S 7111 NC		
1083/50 2nd passage / 2.passaggio			S 6645 N S 7111 NC		
1083/53 2nd passage / 2.passaggio			S 6645 N S 7111 NC		
1083/60 2nd passage / 2.passaggio			S 6645 N S 7111 NC		
1083/61 2nd passage / 2.passaggio			S 6645 N S 7111 NC		
1084 2nd passage / 2.passaggio			S 6645 N S 7111 NC	S 2650 A	
1084/5 2nd passage / 2.passaggio			S 6645 N S 7111 NC	S 2650 A	
1084/8 2nd passage / 2.passaggio			S 6645 N S 7111 NC	S 2650 A	
1086 2nd passage / 2.passaggio			S 6645 N S 7111 NC		
1086/2 2nd passage / 2.passaggio			S 6645 N		



KW HP



...PEGASO - trucks/autocarri

2nd passage / 2.passaggio			S 7111 NC	
1086/3			S 6645 N	
2nd passage / 2.passaggio			S 7111 NC	
1086/51			S 6645 N	
2nd passage / 2.passaggio			S 7111 NC	
1086/52			S 6645 N	
2nd passage / 2.passaggio			S 7111 NC	
1086/53			S 6645 N	
2nd passage / 2.passaggio			S 7111 NC	
1086/62			S 6645 N	
2nd passage / 2.passaggio			S 7111 NC	
1086/64			S 6645 N	
2nd passage / 2.passaggio			S 7111 NC	
1087/10		S 1220 R	S 6645 N	S 0450 A
2nd passage / 2.passaggio			S 7111 NC	
1088			S 6645 N	
2nd passage / 2.passaggio			S 7111 NC	
1088 GL			S 6645 N	
2nd passage / 2.passaggio			S 7111 NC	
1088 V			S 6645 N	
2nd passage / 2.passaggio			S 7111 NC	
1088/50			S 6645 N	
2nd passage / 2.passaggio			S 7111 NC	
1088/53			S 6645 N	
2nd passage / 2.passaggio			S 7111 NC	
1088/60			S 6645 N	
2nd passage / 2.passaggio			S 7111 NC	
1088/63			S 6645 N	
2nd passage / 2.passaggio			S 7111 NC	
1088/64			S 6645 N	
2nd passage / 2.passaggio			S 7111 NC	
1089		S 1220 R	S 6645 N	S 0450 A
2nd passage / 2.passaggio			S 7111 NC	
1090		S 0420 R	S 6645 N	
2nd passage / 2.passaggio			S 7111 NC	
1090 L		S 0420 R	S 6645 N	
2nd passage / 2.passaggio			S 7111 NC	
1090 L/1		S 0420 R	S 6645 N	
2nd passage / 2.passaggio			S 7111 NC	
1090 LDR		S 0420 R	S 6645 N	
2nd passage / 2.passaggio			S 7111 NC	
1090 S		S 0420 R	S 6645 N	
2nd passage / 2.passaggio			S 7111 NC	
1090 V		S 0420 R	S 6645 N	
2nd passage / 2.passaggio			S 7111 NC	
1090 VDR		S 0420 R	S 6645 N	
2nd passage / 2.passaggio			S 7111 NC	
1091		S 0420 R	S 6645 N	
2nd passage / 2.passaggio			S 7111 NC	
1091 EL		S 0420 R	S 6645 N	
2nd passage / 2.passaggio			S 7111 NC	
1091 EL/1		S 0420 R	S 6645 N	
2nd passage / 2.passaggio			S 7111 NC	
1091 V		S 0420 R	S 6645 N	
2nd passage / 2.passaggio			S 7111 NC	
1091 V/1		S 0420 R	S 6645 N	
2nd passage / 2.passaggio			S 7111 NC	
1091/1		S 0420 R	S 6645 N	
2nd passage / 2.passaggio			S 7111 NC	
1091/3		S 0420 R	S 6645 N	S 0950 A
2nd passage / 2.passaggio			S 7111 NC	
1095		S 0420 R	S 6645 N	
2nd passage / 2.passaggio			S 7111 NC	
1095 A		S 0420 R	S 6645 N	
2nd passage / 2.passaggio			S 7111 NC	
1095 ADR		S 0420 R	S 6645 N	
2nd passage / 2.passaggio			S 7111 NC	





kW HP



...PEGASO - trucks/autocarri

P



1095 DR 2nd passage / 2.passaggio		S 0420 R	S 6645 N S 7111 NC		
1095 DR/1 2nd passage / 2.passaggio		S 0420 R	S 6645 N S 7111 NC		
1095 L 2nd passage / 2.passaggio		S 0420 R	S 6645 N S 7111 NC		
1095 L/1 2nd passage / 2.passaggio		S 0420 R	S 6645 N S 7111 NC		
1095 LA 2nd passage / 2.passaggio		S 0420 R	S 6645 N S 7111 NC		
1095 LADR 2nd passage / 2.passaggio		S 0420 R	S 6645 N S 7111 NC		
1095 LDR 2nd passage / 2.passaggio		S 0420 R	S 6645 N S 7111 NC		
1095 LDR/1 2nd passage / 2.passaggio		S 0420 R	S 6645 N S 7111 NC		
1095 VDR 2nd passage / 2.passaggio		S 0420 R	S 6645 N S 7111 NC		
1095/1 2nd passage / 2.passaggio		S 0420 R	S 6645 N S 7111 NC		
1095/40 2nd passage / 2.passaggio		S 0420 R	S 6645 N S 7111 NC		
1096 2nd passage / 2.passaggio		S 0420 R	S 6645 N S 7111 NC		
1096 DR 2nd passage / 2.passaggio			S 6645 N S 7111 NC		
1096 DR/1 2nd passage / 2.passaggio			S 6645 N S 7111 NC		
1096 L 2nd passage / 2.passaggio		S 0420 R	S 6645 N S 7111 NC		
1096 L/1 2nd passage / 2.passaggio		S 0420 R	S 6645 N S 7111 NC		
1096 LDR 2nd passage / 2.passaggio		S 0420 R	S 6645 N S 7111 NC		
1096 LDR/1 2nd passage / 2.passaggio			S 6645 N S 7111 NC		
1096/1 2nd passage / 2.passaggio		S 0420 R	S 6645 N S 7111 NC		
1098 2nd passage / 2.passaggio			S 6645 N S 7111 NC		
1098 DR 2nd passage / 2.passaggio			S 6645 N S 7111 NC		
1098 DR/1 2nd passage / 2.passaggio			S 6645 N S 7111 NC		
1098 L 2nd passage / 2.passaggio			S 6645 N S 7111 NC		
1098 L/1 2nd passage / 2.passaggio			S 6645 N S 7111 NC		
1098 LDR 2nd passage / 2.passaggio			S 6645 N S 7111 NC		
1098 LDR/1 2nd passage / 2.passaggio			S 6645 N S 7111 NC		
1098/1 2nd passage / 2.passaggio			S 6645 N S 7111 NC		
1098/3 2nd passage / 2.passaggio		S 0420 R	S 6645 N S 7111 NC	S 0950 A	
1135 EL/50 2nd passage / 2.passaggio			S 6645 N S 7111 NC	S 2650 A	
1135 L/50 2nd passage / 2.passaggio			S 6645 N S 7111 NC	S 2650 A	
1135 L/60 2nd passage / 2.passaggio			S 6645 N S 7111 NC	S 2650 A	
1135/50 2nd passage / 2.passaggio			S 6645 N S 7111 NC	S 2650 A	
1135/55 2nd passage / 2.passaggio			S 6645 N S 7111 NC	S 2650 A	
1135/60 2nd passage / 2.passaggio			S 6645 N S 7111 NC	S 2650 A	



kW HP



...PEGASO - trucks/autocarri

2nd passage / 2.passaggio				S 7111 NC		
1180 L/53				S 6645 N	S 2650 A	
2nd passage / 2.passaggio				S 7111 NC		
1180 L/60				S 6645 N	S 2650 A	
2nd passage / 2.passaggio				S 7111 NC		
1180/50				S 6645 N	S 2650 A	
2nd passage / 2.passaggio				S 7111 NC		
1180/60				S 6645 N	S 2650 A	
2nd passage / 2.passaggio				S 7111 NC		
1183/50				S 6645 N	S 2650 A	
2nd passage / 2.passaggio				S 7111 NC		
1183/53				S 6645 N	S 2650 A	
2nd passage / 2.passaggio				S 7111 NC		
1183/60				S 6645 N	S 2650 A	
2nd passage / 2.passaggio				S 7111 NC		
1183/70				S 6645 N	S 2650 A	
2nd passage / 2.passaggio				S 7111 NC		
1183/80				S 6645 N	S 2650 A	
2nd passage / 2.passaggio				S 7111 NC		
1186/52				S 6645 N	S 2650 A	
2nd passage / 2.passaggio				S 7111 NC		
1186/54				S 6645 N	S 2650 A	
2nd passage / 2.passaggio				S 7111 NC		
1186/62				S 6645 N	S 2650 A	
2nd passage / 2.passaggio				S 7111 NC		
1186/64				S 6645 N	S 2650 A	
2nd passage / 2.passaggio				S 7111 NC		
1186/70				S 6645 N	S 2650 A	
2nd passage / 2.passaggio				S 7111 NC		
1186/80				S 6645 N	S 2650 A	
2nd passage / 2.passaggio				S 7111 NC		
1100 Serie						
1100 L				S 6645 N		
2nd passage / 2.passaggio				S 7111 NC		
1100 L/1				S 6645 N		
2nd passage / 2.passaggio				S 7111 NC		
1100/1				S 6645 N		
2nd passage / 2.passaggio				S 7111 NC		
1101 L/1				S 6645 N		
2nd passage / 2.passaggio				S 7111 NC		
1101/1				S 6645 N		
2nd passage / 2.passaggio				S 7111 NC		
1120			S 0420 R	S 6645 N	S 0950 A	
2nd passage / 2.passaggio				S 7111 NC		
1120 EL			S 0420 R	S 6645 N	S 0950 A	
2nd passage / 2.passaggio				S 7111 NC		
1120 L			S 0420 R	S 6645 N	S 0950 A	
2nd passage / 2.passaggio				S 7111 NC		
1120 V			S 0420 R	S 6645 N	S 0950 A	
2nd passage / 2.passaggio				S 7111 NC		
1121			S 0420 R	S 6645 N	S 0950 A	
2nd passage / 2.passaggio				S 7111 NC		
1121 EL			S 0420 R	S 6645 N	S 0950 A	
2nd passage / 2.passaggio				S 7111 NC		
1121 EL/5			S 0420 R	S 6645 N	S 0950 A	
2nd passage / 2.passaggio				S 7111 NC		
1121 L			S 0420 R	S 6645 N	S 0950 A	
2nd passage / 2.passaggio				S 7111 NC		
1121 L/5			S 0420 R	S 6645 N	S 0950 A	
2nd passage / 2.passaggio				S 7111 NC		
1121/5			S 0420 R	S 6645 N	S 0950 A	
2nd passage / 2.passaggio				S 7111 NC		
1125			S 0420 R	S 6645 N	S 0950 A	
2nd passage / 2.passaggio				S 7111 NC		
1125 EL			S 0420 R	S 6645 N	S 0950 A	
2nd passage / 2.passaggio				S 7111 NC		
1125 L			S 0420 R	S 6645 N	S 0950 A	





KW HP



...PEGASO - trucks/autocarri

P

2nd passage / 2.passaggio			S 0420 R	S 7111 NC S 6645 N	S 0950 A
1126					
2nd passage / 2.passaggio				S 7111 NC	
1126 L			S 0420 R	S 6645 N	S 0950 A
2nd passage / 2.passaggio				S 7111 NC	
1127				S 6645 N	S 2450 A
2nd passage / 2.passaggio				S 7111 NC	
1127 L				S 6645 N	S 2450 A
2nd passage / 2.passaggio				S 7111 NC	
1127 L/5				S 6645 N	S 2450 A
2nd passage / 2.passaggio				S 7111 NC	
1130				S 6645 N	S 2450 A
2nd passage / 2.passaggio				S 7111 NC	
1130 EL				S 6645 N	S 2450 A
2nd passage / 2.passaggio				S 7111 NC	
1130 L				S 6645 N	S 2450 A
2nd passage / 2.passaggio				S 7111 NC	
1135				S 6645 N	S 2450 A
2nd passage / 2.passaggio				S 7111 NC	
1135 L				S 6645 N	S 2450 A
2nd passage / 2.passaggio				S 7111 NC	
1135 L/1				S 6645 N	S 2450 A
2nd passage / 2.passaggio				S 7111 NC	
some / alcuni			S 1220 R	S 6645 N	S 2450 A
1135 L/30				S 6645 N	S 2450 A
2nd passage / 2.passaggio				S 7111 NC	
some / alcuni			S 1220 R	S 6645 N	S 2450 A
1135/1				S 6645 N	S 2450 A
2nd passage / 2.passaggio				S 7111 NC	
some / alcuni			S 1220 R	S 6645 N	S 2450 A
1135/15				S 6645 N	S 2450 A
2nd passage / 2.passaggio				S 7111 NC	
some / alcuni			S 1220 R	S 6645 N	S 2450 A
1135/30				S 6645 N	S 2450 A
2nd passage / 2.passaggio				S 7111 NC	
some / alcuni			S 1220 R	S 6645 N	S 2450 A
1136				S 6645 N	S 2450 A
2nd passage / 2.passaggio				S 7111 NC	
some / alcuni			S 1220 R	S 6645 N	S 2450 A
1136 L				S 6645 N	S 2450 A
2nd passage / 2.passaggio				S 7111 NC	
some / alcuni			S 1220 R	S 6645 N	S 2450 A
1140				S 6645 N	
2nd passage / 2.passaggio				S 7111 NC	
1145				S 6645 N	S 2450 A
2nd passage / 2.passaggio				S 7111 NC	
1145 L				S 6645 N	S 2450 A
2nd passage / 2.passaggio				S 7111 NC	
1180				S 6645 N	S 2450 A
2nd passage / 2.passaggio				S 7111 NC	
some / alcuni			S 1220 R	S 6645 N	S 2450 A
1180/11				S 6645 N	S 2450 A
2nd passage / 2.passaggio				S 7111 NC	
some / alcuni			S 1220 R	S 6645 N	S 2450 A
1180/21				S 6645 N	S 2450 A
2nd passage / 2.passaggio				S 7111 NC	
some / alcuni			S 1220 R	S 6645 N	S 2450 A
1180/53				S 6645 N	S 2650 A
2nd passage / 2.passaggio				S 7111 NC	
1181 L				S 6645 N	S 0450 A
2nd passage / 2.passaggio				S 7111 NC	
some / alcuni			S 1220 R	S 6645 N	S 0450 A
1183				S 6645 N	S 2450 A
2nd passage / 2.passaggio				S 7111 NC	
some / alcuni			S 1220 R	S 6645 N	S 2450 A
1183/10				S 6645 N	S 2450 A
2nd passage / 2.passaggio				S 7111 NC	



kW HP



...PEGASO - trucks/autocarri

some / alcuni			S 1220 R	S 6645 N	S 2450 A	
1183/3				S 6645 N	S 2450 A	
2nd passage / 2.passaggio				S 7111 NC		
some / alcuni			S 1220 R	S 6645 N	S 2450 A	
1184/10				S 6645 N	S 0450 A	
2nd passage / 2.passaggio				S 7111 NC		
some / alcuni			S 1220 R	S 6645 N	S 0450 A	
1187/10				S 6645 N	S 0450 A	
2nd passage / 2.passaggio				S 7111 NC		
some / alcuni			S 1220 R	S 6645 N	S 0450 A	
1190				S 6645 N	S 0450 A	
2nd passage / 2.passaggio				S 7111 NC		
some / alcuni			S 1220 R	S 6645 N	S 0450 A	
1200 Serie						
1210.6	MAN D 0224, D 0226		S 5536 PO	S 8500 NR	S 0950 A	
1210.6	MAN D 0824GF/D 0826GF		S 3292 R	S 5400 NR	S 2450 A	
2nd passage / 2.passaggio	MAN D 0824GF/D 0826GF			S 8500 NR		
1214			S 0420 R	S 6645 N	S 0950 A	
2nd passage / 2.passaggio				S 7111 NC		
1215.10	MAN D 0824GF/D 0826GF		S 3292 R	S 5400 NR	S 2450 A	
2nd passage / 2.passaggio	MAN D 0824GF/D 0826GF			S 8500 NR		
1215.8	MAN D 0224, D 0226		S 5536 PO	S 8500 NR	S 0950 A	
1215.8	MAN D 0824GF/D 0826GF		S 3292 R	S 5400 NR	S 2450 A	
2nd passage / 2.passaggio	MAN D 0824GF/D 0826GF			S 8500 NR		
1215.9	MAN D 0224, D 0226		S 5536 PO	S 8500 NR	S 0950 A	
1215.9	MAN D 0824GF/D 0826GF		S 3292 R	S 5400 NR	S 2450 A	
2nd passage / 2.passaggio	MAN D 0824GF/D 0826GF			S 8500 NR		
1216				S 6645 N	S 2450 A	
2nd passage / 2.passaggio				S 7111 NC		
1217				S 6645 N	S 2450 A	
2nd passage / 2.passaggio				S 7111 NC		
some / alcuni			S 1220 R	S 6645 N	S 2450 A	
1217.14	94T1BX		S 9710 R	S 7111 NC	S 2650 A	
inner / interno	94T1BX				S 7129 A	
1217.17	94T1BX		S 9710 R	S 7111 NC	S 2650 A	
inner / interno	94T1BX				S 7129 A	
1217.20	95A1BX		S 1220 R	S 7111 NC	S 2450 A	
1223			S 1220 R	S 7111 NC	S 2650 A	
1223.20	95T1BX (9222.11)		S 1220 R	S 7111 NC	S 2650 A	
inner / interno	95T1BX (9222.11)				S 7129 A	
1226.20	95R1AX		S 1220 R	S 7111 NC	S 0450 A	
1226.38 T	95R1AX		S 1220 R	S 7111 NC	S 0450 A	
1228 T	96T1CX (9156.73)		S 1220 R	S 7111 NC	S 0450 A	
some / alcuni	96T1CX (9156.73)		S 1220 R	S 8111 NC	S 0450 A	
1228.38 T	96T1CX (9156.73)		S 1220 R	S 7111 NC	S 0450 A	
some / alcuni	96T1CX (9156.73)		S 1220 R	S 8111 NC	S 0450 A	
1231 R	96T1CX (9156.73)		S 1220 R	S 7111 NC	S 0450 A	
some / alcuni	96T1CX (9156.73)		S 1220 R	S 8111 NC	S 0450 A	
1231 T	96T1CX (9156.73)		S 1220 R	S 7111 NC	S 0450 A	
some / alcuni	96T1CX (9156.73)		S 1220 R	S 8111 NC	S 0450 A	
1231.38 T	96T1CX (9156.73)		S 1220 R	S 7111 NC	S 0450 A	
some / alcuni	96T1CX (9156.73)		S 1220 R	S 8111 NC	S 0450 A	
1232.38 R	96R1EX, 96T1EX		S 1220 R	S 8111 NC		
1234 R	96R1AX (9180.03)		S 1220 R	S 8111 NC	S 1050 A	
inner / interno	96R1AX (9180.03)				S 1307 A	
1234 T	96R1AX (9180.03)		S 1220 R	S 8111 NC	S 1050 A	
inner / interno	96R1AX (9180.03)				S 1307 A	
1234.38 R	96R1AX (9180.03)		S 1220 R	S 8111 NC	S 1050 A	
inner / interno	96R1AX (9180.03)				S 1307 A	
1234.38 T	96R1AX (9180.03)		S 1220 R	S 8111 NC	S 1050 A	
inner / interno	96R1AX (9180.03)				S 1307 A	
1236.38 R	96R1EX, 96T1EX		S 1220 R	S 8111 NC		
1236.38 T	96R1EX, 96T1EX		S 1220 R	S 8111 NC		
1300 Serie						
1323.26 G	95T1BX (9222.11)		S 1220 R	S 7111 NC	S 2650 A	
inner / interno	95T1BX (9222.11)				S 7129 A	
1326.26 G	95R1AX		S 1220 R	S 7111 NC	S 0450 A	

P



**KW HP****...PEGASO - trucks/autocarri****P**

1331 some / alcuni	96T1CX (9156.73) 96T1CX (9156.73)		S 1220 R S 1220 R	S 7111 NC S 8111 NC	S 0450 A S 0450 A	
1331 R some / alcuni	96T1CX (9156.73) 96T1CX (9156.73)		S 1220 R S 1220 R	S 7111 NC S 8111 NC	S 0450 A S 0450 A	
1331.26 some / alcuni	96T1CX (9156.73) 96T1CX (9156.73)		S 1220 R S 1220 R	S 7111 NC S 8111 NC	S 0450 A S 0450 A	
1331.38 R some / alcuni	96T1CX (9156.73) 96T1CX (9156.73)		S 1220 R S 1220 R	S 7111 NC S 8111 NC	S 0450 A S 0450 A	
1334.38 R inner / interno	96R1AX (9180.03) 96R1AX (9180.03)		S 1220 R	S 8111 NC	S 1050 A S 1307 A	
1334.38 RG inner / interno	96R1AX (9180.03) 96R1AX (9180.03)		S 1220 R	S 8111 NC	S 1050 A S 1307 A	
1336.38 R	96R1EX, 96T1EX		S 1220 R	S 8111 NC		
1400 Serie						
1431 some / alcuni	96T1CX (9156.73) 96T1CX (9156.73)		S 1220 R S 1220 R	S 7111 NC S 8111 NC	S 0450 A S 0450 A	
1431 G some / alcuni	96T1CX (9156.73) 96T1CX (9156.73)		S 1220 R S 1220 R	S 7111 NC S 8111 NC	S 0450 A S 0450 A	
1434 inner / interno	96R1AX (9180.03) 96R1AX (9180.03)		S 1220 R	S 8111 NC	S 1050 A S 1307 A	
1434 G inner / interno	96R1AX (9180.03) 96R1AX (9180.03)		S 1220 R	S 8111 NC	S 1050 A S 1307 A	
1434.38 G inner / interno	96R1AX (9180.03) 96R1AX (9180.03)		S 1220 R	S 8111 NC	S 1050 A S 1307 A	
1436.38 G	96R1EX, 96T1EX		S 1220 R	S 8111 NC		
2000 Serie						
2011 2nd passage / 2.passaggio				S 6645 N S 7111 NC		
2011 A 2nd passage / 2.passaggio				S 6645 N S 7111 NC		
2011/1 2nd passage / 2.passaggio				S 6645 N S 7111 NC		
2011/50 2nd passage / 2.passaggio				S 6645 N S 7111 NC		
2012 2nd passage / 2.passaggio				S 6645 N S 7111 NC		
2020 2nd passage / 2.passaggio				S 6645 N S 7111 NC		
2020 B 2nd passage / 2.passaggio				S 6645 N S 7111 NC		
2020 B4 2nd passage / 2.passaggio				S 6645 N S 7111 NC		
2022 2nd passage / 2.passaggio				S 6645 N S 7111 NC		
2030 DR 2nd passage / 2.passaggio				S 6645 N S 7111 NC		
2031 DR 2nd passage / 2.passaggio				S 6645 N S 7111 NC		
2040 2nd passage / 2.passaggio				S 6645 N S 7111 NC		
2040/1 2nd passage / 2.passaggio				S 6645 N S 7111 NC		
2040/50 2nd passage / 2.passaggio				S 6645 N S 7111 NC		
2040/51 2nd passage / 2.passaggio				S 6645 N S 7111 NC	S 2650 A	
2041 2nd passage / 2.passaggio				S 6645 N S 7111 NC		
2041 T 2nd passage / 2.passaggio				S 6645 N S 7111 NC		
2045 2nd passage / 2.passaggio				S 6645 N S 7111 NC		
2080 2nd passage / 2.passaggio				S 6645 N S 7111 NC		
2080/1 2nd passage / 2.passaggio				S 6645 N S 7111 NC		
2080/11				S 6645 N		



kW HP



...PEGASO - trucks/autocarri

2nd passage / 2.passaggio			S 7111 NC		
2080/4			S 6645 N		
2nd passage / 2.passaggio			S 7111 NC		
2080/50			S 6645 N		
2nd passage / 2.passaggio			S 7111 NC		
2080/51			S 6645 N		
2nd passage / 2.passaggio			S 7111 NC		
2080/54			S 6645 N		
2nd passage / 2.passaggio			S 7111 NC		
2080/60			S 6645 N		
2nd passage / 2.passaggio			S 7111 NC		
2080/61			S 6645 N		
2nd passage / 2.passaggio			S 7111 NC		
2080/63			S 6645 N		
2nd passage / 2.passaggio			S 7111 NC		
2080/64			S 6645 N		
2nd passage / 2.passaggio			S 7111 NC		
2081 C			S 6645 N	S 0450 A	
2nd passage / 2.passaggio			S 7111 NC		
some / alcuni		S 1220 R	S 6645 N	S 0450 A	
2081 LC			S 6645 N	S 0450 A	
2nd passage / 2.passaggio			S 7111 NC		
some / alcuni		S 1220 R	S 6645 N	S 0450 A	
2081/60			S 6645 N	S 0450 A	
2nd passage / 2.passaggio			S 7111 NC		
some / alcuni		S 1220 R	S 6645 N	S 0450 A	
2082/60			S 6645 N	S 0450 A	
2nd passage / 2.passaggio			S 7111 NC		
some / alcuni		S 1220 R	S 6645 N	S 0450 A	
2082/80			S 6645 N	S 0450 A	
2nd passage / 2.passaggio			S 7111 NC		
some / alcuni		S 1220 R	S 6645 N	S 0450 A	
2088/50			S 6645 N		
2nd passage / 2.passaggio			S 7111 NC		
2088/60			S 6645 N		
2nd passage / 2.passaggio			S 7111 NC		
2089/60			S 6645 N	S 0450 A	
2nd passage / 2.passaggio			S 7111 NC		
some / alcuni		S 1220 R	S 6645 N	S 0450 A	
2089/80			S 6645 N	S 0450 A	
2nd passage / 2.passaggio			S 7111 NC		
some / alcuni		S 1220 R	S 6645 N	S 0450 A	
2090			S 6645 N	S 0450 A	
2nd passage / 2.passaggio			S 7111 NC		
some / alcuni		S 1220 R	S 6645 N	S 0450 A	
2091			S 6645 N	S 0450 A	
2nd passage / 2.passaggio			S 7111 NC		
some / alcuni		S 1220 R	S 6645 N	S 0450 A	
2100 Serie					
2135			S 6645 N	S 2450 A	
2nd passage / 2.passaggio			S 7111 NC		
some / alcuni		S 1220 R	S 6645 N	S 2450 A	
2135/50			S 6645 N	S 2650 A	
2nd passage / 2.passaggio			S 7111 NC		
2180/11			S 6645 N	S 2450 A	
2nd passage / 2.passaggio			S 7111 NC		
some / alcuni		S 1220 R	S 6645 N	S 2450 A	
2180/51			S 6645 N	S 2650 A	
2nd passage / 2.passaggio			S 7111 NC		
2180/54			S 6645 N	S 2650 A	
2nd passage / 2.passaggio			S 7111 NC		
2180/61			S 6645 N	S 2650 A	
2nd passage / 2.passaggio			S 7111 NC		
2180/64			S 6645 N	S 2650 A	
2nd passage / 2.passaggio			S 7111 NC		
2180/70			S 6645 N	S 2650 A	
2nd passage / 2.passaggio			S 7111 NC		





kW HP



...PEGASO - trucks/autocarri

P



2180/80 2nd passage / 2.passaggio			S 6645 N S 7111 NC	S 2650 A	
2181/60 2nd passage / 2.passaggio some / alcuni			S 6645 N S 7111 NC	S 0450 A	
2182/60 2nd passage / 2.passaggio some / alcuni		S 1220 R	S 6645 N S 7111 NC	S 0450 A	
2189/60 2nd passage / 2.passaggio some / alcuni		S 1220 R	S 6645 N S 7111 NC	S 0450 A	
2190 2nd passage / 2.passaggio some / alcuni		S 1220 R	S 6645 N S 7111 NC	S 0450 A	
2200 Serie					
2217 inner / interno		S 1220 R	S 7111 NC	S 2650 A S 7129 A	
2217.15 inner / interno		S 1220 R	S 7111 NC	S 2650 A S 7129 A	
2300 Serie					
2321 K		S 1220 R	S 7111 NC	S 2650 A	
2323 K inner / interno	95T1BX (9222.11) 95T1BX (9222.11)	S 1220 R	S 7111 NC	S 2650 A S 7129 A	
2323.26 K inner / interno	95T1BX (9222.11) 95T1BX (9222.11)	S 1220 R	S 7111 NC	S 2650 A S 7129 A	
2331 K some / alcuni	96T1CX (9156.73) 96T1CX (9156.73)	S 1220 R S 1220 R	S 7111 NC S 8111 NC	S 0450 A S 0450 A	
2331 R some / alcuni	96T1CX (9156.73) 96T1CX (9156.73)	S 1220 R S 1220 R	S 7111 NC S 8111 NC	S 0450 A S 0450 A	
2331 T some / alcuni	96T1CX (9156.73) 96T1CX (9156.73)	S 1220 R S 1220 R	S 7111 NC S 8111 NC	S 0450 A S 0450 A	
2331.26 K some / alcuni	96T1CX (9156.73) 96T1CX (9156.73)	S 1220 R S 1220 R	S 7111 NC S 8111 NC	S 0450 A S 0450 A	
2331.38 R some / alcuni	96T1CX (9156.73) 96T1CX (9156.73)	S 1220 R S 1220 R	S 7111 NC S 8111 NC	S 0450 A S 0450 A	
2331.38 T some / alcuni	96T1CX (9156.73) 96T1CX (9156.73)	S 1220 R S 1220 R	S 7111 NC S 8111 NC	S 0450 A S 0450 A	
2334.26 K inner / interno	96R1AX (9180.03) 96R1AX (9180.03)	S 1220 R	S 8111 NC	S 1050 A S 1307 A	
2334.38 T inner / interno	96R1AX (9180.03) 96R1AX (9180.03)	S 1220 R	S 8111 NC	S 1050 A S 1307 A	
2400 Serie					
2431 K some / alcuni	96T1CX (9156.73) 96T1CX (9156.73)	S 1220 R S 1220 R	S 7111 NC S 8111 NC	S 0450 A S 0450 A	
2431.36 K some / alcuni	96T1CX (9156.73) 96T1CX (9156.73)	S 1220 R S 1220 R	S 7111 NC S 8111 NC	S 0450 A S 0450 A	
2434.36 K inner / interno	96R1AX (9180.03) 96R1AX (9180.03)	S 1220 R	S 8111 NC	S 1050 A S 1307 A	
3000 Serie					
3040 2nd passage / 2.passaggio			S 6645 N S 7111 NC		
3040 A 2nd passage / 2.passaggio			S 6645 N S 7111 NC		
3040/22 2nd passage / 2.passaggio			S 6645 N S 7111 NC		
3041 2nd passage / 2.passaggio			S 6645 N S 7111 NC		
3041/1 2nd passage / 2.passaggio			S 6645 N S 7111 NC		
3045 D 2nd passage / 2.passaggio			S 6645 N S 7111 NC		
3045/20 2nd passage / 2.passaggio			S 6645 N S 7111 NC		
3045/21 2nd passage / 2.passaggio			S 6645 N S 7111 NC		
3045/22 2nd passage / 2.passaggio			S 6645 N S 7111 NC		



kW HP



...PEGASO - trucks/autocarri

3045/23 2nd passage / 2.passaggio			S 6645 N S 7111 NC	
3045/24 2nd passage / 2.passaggio			S 6645 N S 7111 NC	
3045/40 2nd passage / 2.passaggio			S 6645 N S 7111 NC	
3045/42 2nd passage / 2.passaggio			S 6645 N S 7111 NC	
3046 2nd passage / 2.passaggio			S 6645 N S 7111 NC	S 2450 A
3046 T 2nd passage / 2.passaggio			S 6645 N S 7111 NC	S 2450 A
3046/10 2nd passage / 2.passaggio inner / interno			S 6645 N S 7111 NC	S 2650 A S 7129 A
3046/50 2nd passage / 2.passaggio			S 6645 N S 7111 NC	S 2450 A
3046/51 2nd passage / 2.passaggio			S 6645 N S 7111 NC	S 2450 A
3046/52 2nd passage / 2.passaggio			S 6645 N S 7111 NC	S 2450 A
3047 TC 2nd passage / 2.passaggio			S 6645 N S 7111 NC	S 2450 A
3050 2nd passage / 2.passaggio			S 6645 N S 7111 NC	
3050 DV 2nd passage / 2.passaggio			S 6645 N S 7111 NC	
3050 M 2nd passage / 2.passaggio			S 6645 N S 7111 NC	
3050 T 2nd passage / 2.passaggio			S 6645 N S 7111 NC	
3050/23 2nd passage / 2.passaggio			S 6645 N S 7111 NC	
3050/7 2nd passage / 2.passaggio			S 6645 N S 7111 NC	
3050/8 2nd passage / 2.passaggio			S 6645 N S 7111 NC	
3052 2nd passage / 2.passaggio			S 6645 N S 7111 NC	
3054 2nd passage / 2.passaggio			S 6645 N S 7111 NC	S 2650 A S 2650 A
3060 2nd passage / 2.passaggio			S 6645 N S 7111 NC	
3060 G 2nd passage / 2.passaggio			S 6645 N S 7111 NC	
3060 GL 2nd passage / 2.passaggio			S 6645 N S 7111 NC	
3060 GL/50 2nd passage / 2.passaggio			S 6645 N S 7111 NC	S 2650 A
3060 GLA 2nd passage / 2.passaggio some / alcuni			S 6645 N S 7111 NC	S 2450 A
3060 GLA/50 2nd passage / 2.passaggio		S 1220 R	S 6645 N S 7111 NC	S 2450 A S 2650 A
3060 L 2nd passage / 2.passaggio			S 6645 N S 7111 NC	
3060 L/50 2nd passage / 2.passaggio			S 6645 N S 7111 NC	
3060 LA 2nd passage / 2.passaggio some / alcuni			S 6645 N S 7111 NC	S 2450 A
3060 LA/50 2nd passage / 2.passaggio		S 1220 R	S 6645 N S 7111 NC	S 2450 A S 2650 A
3065 2nd passage / 2.passaggio			S 6645 N S 7111 NC	S 2650 A
3065/10 2nd passage / 2.passaggio			S 6645 N S 7111 NC	S 2650 A





| kW | HP |

**...PEGASO - trucks/autocarri****P**

3070 2nd passage / 2.passaggio			S 6645 N S 7111 NC		
3075 2nd passage / 2.passaggio			S 6645 N S 7111 NC		
3075/50 2nd passage / 2.passaggio			S 6645 N S 7111 NC		
3076 2nd passage / 2.passaggio			S 6645 N S 7111 NC		
3076 D 2nd passage / 2.passaggio			S 6645 N S 7111 NC	S 2650 A	
3076/60 2nd passage / 2.passaggio			S 6645 N S 7111 NC	S 2650 A	
3078 2nd passage / 2.passaggio inner / interno			S 6645 N S 7111 NC	S 2650 A S 7129 A	
3080 2nd passage / 2.passaggio inner / interno			S 6645 N S 7111 NC	S 2450 A S 3940 A	
3080/50 2nd passage / 2.passaggio inner / interno			S 6645 N S 7111 NC	S 2650 A S 7129 A	
3080/63 2nd passage / 2.passaggio inner / interno			S 6645 N S 7111 NC	S 2650 A S 7129 A	
3088 2nd passage / 2.passaggio			S 6645 N S 7111 NC		
3088/10 2nd passage / 2.passaggio			S 6645 N S 7111 NC		
3088/12 2nd passage / 2.passaggio			S 6645 N S 7111 NC		
3088/2 2nd passage / 2.passaggio			S 6645 N S 7111 NC		
3088/22 2nd passage / 2.passaggio			S 6645 N S 7111 NC		
3088/92 2nd passage / 2.passaggio some / alcuni		S 1220 R	S 6645 N S 7111 NC	S 0450 A S 0450 A	
3089/1 2nd passage / 2.passaggio some / alcuni		S 1220 R	S 6645 N S 7111 NC	S 0450 A S 0450 A	
3089/2 2nd passage / 2.passaggio some / alcuni		S 1220 R	S 6645 N S 7111 NC	S 0450 A S 0450 A	
3100 Serie					
3180/50 2nd passage / 2.passaggio inner / interno			S 6645 N S 7111 NC	S 2650 A S 7129 A	
3180/70 2nd passage / 2.passaggio inner / interno			S 6645 N S 7111 NC	S 2650 A S 7129 A	
3180/80 2nd passage / 2.passaggio inner / interno			S 6645 N S 7111 NC	S 2650 A S 7129 A	
3181 2nd passage / 2.passaggio some / alcuni		S 1220 R	S 6645 N S 7111 NC	S 0450 A S 0450 A	
3188/2 2nd passage / 2.passaggio			S 6645 N S 7111 NC	S 2650 A S 2650 A	
3188/92 2nd passage / 2.passaggio some / alcuni		S 1220 R	S 6645 N S 7111 NC	S 0450 A S 0450 A	
3189 2nd passage / 2.passaggio some / alcuni		S 1220 R	S 6645 N S 7111 NC	S 0450 A S 0450 A	
3500 Serie					
3500 2nd passage / 2.passaggio			S 6645 N S 7111 NC	S 0450 A	



kW HP



...PEGASO - trucks/autocarri

some / alcuni		S 1220 R	S 6645 N	S 0450 A	
3545			S 6645 N	S 2650 A	
2nd passage / 2.passaggio			S 7111 NC		
3550			S 6645 N	S 2450 A	
2nd passage / 2.passaggio			S 7111 NC		
3550/1			S 6645 N	S 2450 A	
2nd passage / 2.passaggio			S 7111 NC		
3560			S 6645 N	S 0450 A	
2nd passage / 2.passaggio			S 7111 NC		
some / alcuni		S 1220 R	S 6645 N	S 0450 A	
3560/1			S 6645 N	S 0450 A	
2nd passage / 2.passaggio			S 7111 NC		
some / alcuni		S 1220 R	S 6645 N	S 0450 A	
3560/3			S 6645 N	S 0450 A	
2nd passage / 2.passaggio			S 7111 NC		
some / alcuni		S 1220 R	S 6645 N	S 0450 A	
3560/4			S 6645 N	S 0450 A	
2nd passage / 2.passaggio			S 7111 NC		
some / alcuni		S 1220 R	S 6645 N	S 0450 A	
3562/1			S 6645 N	S 0450 A	
2nd passage / 2.passaggio			S 7111 NC		
some / alcuni		S 1220 R	S 6645 N	S 0450 A	
3570			S 6645 N	S 0450 A	
2nd passage / 2.passaggio			S 7111 NC		
some / alcuni		S 1220 R	S 6645 N	S 0450 A	
75 Serie					
75.28			S 8500 NR	S 0950 A	
with hexagonal release nut / con dado di smontaggio esagonale		S 1563 R			
75.32			S 8500 NR	S 0950 A	
with hexagonal release nut / con dado di smontaggio esagonale		S 1563 R			
75.35			S 8500 NR	S 0950 A	
with hexagonal release nut / con dado di smontaggio esagonale		S 1563 R			
75.40			S 8500 NR	S 0950 A	
with hexagonal release nut / con dado di smontaggio esagonale		S 1563 R			
75.46			S 8500 NR	S 0950 A	
with hexagonal release nut / con dado di smontaggio esagonale		S 1563 R			
75.50			S 8500 NR	S 0950 A	
with hexagonal release nut / con dado di smontaggio esagonale		S 1563 R			
75.56			S 8500 NR	S 0950 A	
with hexagonal release nut / con dado di smontaggio esagonale		S 1563 R			
PEGASO buses/autobus					
5000 Serie					
5021 A		S 0420 R	S 6645 N		
2nd passage / 2.passaggio			S 7111 NC		
5022			S 6645 N		
2nd passage / 2.passaggio			S 7111 NC		
5022 C			S 6645 N		
2nd passage / 2.passaggio			S 7111 NC		
5022 CL			S 6645 N		
2nd passage / 2.passaggio			S 7111 NC		
5022 CLN			S 6645 N		
2nd passage / 2.passaggio			S 7111 NC		
5022 IV			S 6645 N		
2nd passage / 2.passaggio			S 7111 NC		
5022 V			S 6645 N		
2nd passage / 2.passaggio			S 7111 NC		
5022/10			S 6645 N		
2nd passage / 2.passaggio			S 7111 NC		
5023			S 6645 N	S 2450 A	
2nd passage / 2.passaggio			S 7111 NC		
5023 CL			S 6645 N	S 2450 A	
2nd passage / 2.passaggio			S 7111 NC		
5023 CLA			S 6645 N	S 2450 A	
2nd passage / 2.passaggio			S 7111 NC		
5023 CLN			S 6645 N	S 2450 A	
2nd passage / 2.passaggio			S 7111 NC		

P





KW HP



...PEGASO - buses/autobus

P

5023 DL/5				S 6645 N	S 2450 A
2nd passage / 2.passaggio				S 7111 NC	
5023/1				S 6645 N	S 2450 A
2nd passage / 2.passaggio				S 7111 NC	
5024				S 6645 N	S 2450 A
2nd passage / 2.passaggio				S 7111 NC	
5024 CL				S 6645 N	S 2450 A
2nd passage / 2.passaggio				S 7111 NC	
5024 CLN				S 6645 N	S 2450 A
2nd passage / 2.passaggio				S 7111 NC	
5024 DL/5				S 6645 N	S 2450 A
2nd passage / 2.passaggio				S 7111 NC	
5025				S 6645 N	
2nd passage / 2.passaggio				S 7111 NC	
5025 CLN				S 6645 N	
2nd passage / 2.passaggio				S 7111 NC	
5026				S 6645 N	
2nd passage / 2.passaggio				S 7111 NC	
5026 N				S 6645 N	
2nd passage / 2.passaggio				S 7111 NC	
5030				S 6645 N	
2nd passage / 2.passaggio				S 7111 NC	
5030 E				S 6645 N	S 2450 A
2nd passage / 2.passaggio				S 7111 NC	
5030 L				S 6645 N	
2nd passage / 2.passaggio				S 7111 NC	
5030 L/3				S 6645 N	
2nd passage / 2.passaggio				S 7111 NC	
5030/1				S 6645 N	
2nd passage / 2.passaggio				S 7111 NC	
5030/1 L				S 6645 N	
2nd passage / 2.passaggio				S 7111 NC	
5031				S 6645 N	
2nd passage / 2.passaggio				S 7111 NC	
5031 B				S 6645 N	
2nd passage / 2.passaggio				S 7111 NC	
5031 L				S 6645 N	
2nd passage / 2.passaggio				S 7111 NC	
5031 L/1				S 6645 N	S 2450 A
2nd passage / 2.passaggio				S 7111 NC	
5031 L/2				S 6645 N	
2nd passage / 2.passaggio				S 7111 NC	
5031 L/3				S 6645 N	
2nd passage / 2.passaggio				S 7111 NC	
5031 L/4				S 6645 N	S 2450 A
2nd passage / 2.passaggio				S 7111 NC	
some / alcuni				S 6645 N	S 7170 A
inner / interno					S 7670 A
5031 N				S 6645 N	
2nd passage / 2.passaggio				S 7111 NC	
5031 NB				S 6645 N	
2nd passage / 2.passaggio				S 7111 NC	
5031 T	95T1BX	166	225	S 1220 R	S 7111 NC
inner / interno	95T1BX	166	225		S 2650 A
5031 TC	95T1BX	166	225	S 1220 R	S 7111 NC
inner / interno	95T1BX	166	225		S 2650 A
5031/1				S 6645 N	S 7129 A
2nd passage / 2.passaggio				S 7111 NC	
5031/3				S 6645 N	S 2450 A
2nd passage / 2.passaggio				S 7111 NC	
5032				S 6645 N	S 2450 A
2nd passage / 2.passaggio				S 7111 NC	
some / alcuni				S 7111 NC	S 7170 A
inner / interno					S 7670 A
5032/1				S 6645 N	S 2450 A
2nd passage / 2.passaggio				S 7111 NC	
5032/2				S 6645 N	S 2450 A



KW HP



...PEGASO - buses/autobus

2nd passage / 2.passaggio			S 7111 NC		
5034 L/1			S 6645 N		
2nd passage / 2.passaggio			S 7111 NC		
5034 L/2			S 6645 N		
2nd passage / 2.passaggio			S 7111 NC		
5034 N			S 6645 N		
2nd passage / 2.passaggio			S 7111 NC		
5035			S 6645 N		
2nd passage / 2.passaggio			S 7111 NC		
5035 N			S 6645 N		
2nd passage / 2.passaggio			S 7111 NC		
5035 NA			S 6645 N		
2nd passage / 2.passaggio			S 7111 NC		
5035 NB			S 6645 N		
2nd passage / 2.passaggio			S 7111 NC		
5036			S 6645 N	S 0450 A	
2nd passage / 2.passaggio			S 7111 NC		
some / alcuni		S 1220 R	S 6645 N	S 0450 A	
5036 S			S 6645 N	S 0450 A	
2nd passage / 2.passaggio			S 7111 NC		
some / alcuni		S 1220 R	S 6645 N	S 0450 A	
5036 S/1			S 6645 N	S 0450 A	
2nd passage / 2.passaggio			S 7111 NC		
some / alcuni		S 1220 R	S 6645 N	S 0450 A	
5036/1			S 6645 N	S 0450 A	
2nd passage / 2.passaggio			S 7111 NC		
some / alcuni		S 1220 R	S 6645 N	S 0450 A	
5045			S 6645 N		
2nd passage / 2.passaggio			S 7111 NC		
5061 DR		S 0420 R	S 6645 N		
2nd passage / 2.passaggio			S 7111 NC		
5062 A		S 0420 R	S 6645 N		
2nd passage / 2.passaggio			S 7111 NC		
5062 B		S 0420 R	S 6645 N		
2nd passage / 2.passaggio			S 7111 NC		
5063 A/2		S 0420 R	S 6645 N	S 0950 A	
2nd passage / 2.passaggio			S 7111 NC		
5063 DR		S 0420 R	S 6645 N	S 0950 A	
2nd passage / 2.passaggio			S 7111 NC		
5063 DR/1		S 0420 R	S 6645 N	S 0950 A	
2nd passage / 2.passaggio			S 7111 NC		
5063 DR/2		S 0420 R	S 6645 N	S 0950 A	
2nd passage / 2.passaggio			S 7111 NC		
5064 A		S 0420 R	S 6645 N	S 0950 A	
2nd passage / 2.passaggio			S 7111 NC		
5064 A/1		S 0420 R	S 6645 N	S 0950 A	
2nd passage / 2.passaggio			S 7111 NC		
5064 B		S 0420 R	S 6645 N	S 0950 A	
2nd passage / 2.passaggio			S 7111 NC		
5065 C			S 6645 N		
2nd passage / 2.passaggio			S 7111 NC		
5065 DR		S 0420 R	S 6645 N		
2nd passage / 2.passaggio			S 7111 NC		
5067 DR		S 0420 R	S 6645 N		
2nd passage / 2.passaggio			S 7111 NC		
5070			S 6645 N	S 2650 A	
2nd passage / 2.passaggio			S 7111 NC		
5070/1			S 6645 N	S 2650 A	
2nd passage / 2.passaggio			S 7111 NC		
5070/2			S 6645 N	S 2650 A	
2nd passage / 2.passaggio			S 7111 NC		
5071			S 6645 N		
2nd passage / 2.passaggio			S 7111 NC		
5071/1			S 6645 N		
2nd passage / 2.passaggio			S 7111 NC		
5071/3			S 6645 N	S 2650 A	
2nd passage / 2.passaggio			S 7111 NC		

P





KW HP



...PEGASO - buses/autobus

P

5073				S 6645 N		
2nd passage / 2.passaggio				S 7111 NC		
5074				S 6645 N		
2nd passage / 2.passaggio				S 7111 NC		
5075				S 6645 N		
2nd passage / 2.passaggio				S 7111 NC		
5080			S 0420 R	S 6645 N		
2nd passage / 2.passaggio				S 7111 NC		
5081			S 0420 R	S 6645 N		
2nd passage / 2.passaggio				S 7111 NC		
5081/1			S 0420 R	S 6645 N		
2nd passage / 2.passaggio				S 7111 NC		
5117	9100.56	125 170		S 1220 R	S 7111 NC	S 2450 A
inner / interno	9100.56	125 170				S 3940 A
5117	96R1AX	250 340		S 1220 R	S 8111 NC	S 1050 A
inner / interno	96R1AX	250 340				S 1307 A
5123				S 1220 R	S 7111 NC	S 2650 A
inner / interno						S 7129 A
5231	96T1CX			S 1220 R	S 8111 NC	S 0450 A
2nd passage / 2.passaggio	96T1CX				S 7111 NC	
some / alcuni	96T1CX			S 1220 R	S 6645 N	S 0450 A
5231	96T3CX				S 7111 NC	S 0450 A
some / alcuni	96T3CX				S 8111 NC	S 0450 A
5317				S 9710 R	S 7111 NC	S 2650 A
5720/10				S 0420 R	S 7111 NC	
5720/20				S 0420 R	S 7111 NC	
5730/21				S 0420 R	S 7111 NC	
6000 Serie						
6021 A			S 0420 R	S 6645 N		
2nd passage / 2.passaggio				S 7111 NC		
6030				S 6645 N		
2nd passage / 2.passaggio				S 7111 NC		
6030 NA				S 6645 N		
2nd passage / 2.passaggio				S 7111 NC		
6031 A				S 6645 N	S 2450 A	
2nd passage / 2.passaggio				S 7111 NC		
6031 A/2				S 6645 N	S 2450 A	
2nd passage / 2.passaggio				S 7111 NC		
6031 N				S 6645 N	S 2450 A	
2nd passage / 2.passaggio				S 7111 NC		
6031 N/2				S 6645 N	S 2450 A	
2nd passage / 2.passaggio				S 7111 NC		
6035				S 6645 N	S 2450 A	
2nd passage / 2.passaggio				S 7111 NC		
6035 A				S 6645 N	S 2450 A	
2nd passage / 2.passaggio				S 7111 NC		
6035 A/1				S 6645 N	S 2450 A	
2nd passage / 2.passaggio				S 7111 NC		
6035 A/2				S 6645 N	S 2450 A	
2nd passage / 2.passaggio				S 7111 NC		
6035 A/3				S 6645 N	S 2450 A	
2nd passage / 2.passaggio				S 7111 NC		
6035/4				S 6645 N	S 2450 A	
2nd passage / 2.passaggio				S 7111 NC		
6035/5				S 6645 N	S 2450 A	
2nd passage / 2.passaggio				S 7111 NC		
6036				S 6645 N	S 2450 A	
2nd passage / 2.passaggio				S 7111 NC		
6037 A				S 6645 N	S 2450 A	
2nd passage / 2.passaggio				S 7111 NC		
6038				S 6645 N	S 2450 A	
2nd passage / 2.passaggio				S 7111 NC		
6038 A/2				S 6645 N	S 2450 A	
2nd passage / 2.passaggio				S 7111 NC		
6042			S 0420 R	S 6645 N		
2nd passage / 2.passaggio				S 7111 NC		
6042/1			S 0420 R	S 6645 N		



KW HP



...PEGASO - buses/autobus

2nd passage / 2.passaggio			S 0420 R	S 7111 NC		
6042/2				S 6645 N		
2nd passage / 2.passaggio				S 7111 NC		
6046				S 6645 N		
2nd passage / 2.passaggio				S 7111 NC		
6046/1				S 6645 N		
2nd passage / 2.passaggio				S 7111 NC		
6046/2				S 6645 N		
2nd passage / 2.passaggio				S 7111 NC		
6047				S 6645 N		
2nd passage / 2.passaggio				S 7111 NC		
6100						
1st passage / 1.passaggio				S 6645 N	S 0450 A	
2nd passage / 2.passaggio				S 7111 NC		
some / alcuni			S 1220 R	S 6645 N	S 0450 A	
6420			S 1220 R	S 7111 NC		
some / alcuni			S 1220 R	S 8111 NC	S 7187 A	
hydraulic (VOITH) / idraulico (VOITH)						S 6449 PO
6424			S 1220 R	S 7111 NC		
some / alcuni			S 1220 R	S 8111 NC		

PERLINI

dump trucks/autocarri ribaltabili

100 Serie

121-27	Aifo-Iveco 8210.02		S 0230 R	S 0710 NR		
--------	--------------------	--	----------	-----------	--	--

DP Serie

205	Detroit Diesel 6V-92		S 3301 PO		S 6550 A	
inner / interno	Detroit Diesel 6V-92				S 2840 A	
361	Detroit Diesel 12V-71		S 3301 PO			
363	Detroit Diesel 12V-71		S 3301 PO			
366	Detroit Diesel 12V-71		S 3301 PO			
655	Detroit Diesel 16V-71N		S 3301 PO			
655 B	Cummins KTA 19C		S 3409 R	S 4510 NR		
some / alcuni	Cummins KTA 19C		S 3409 R			
655 B	Detroit Diesel 12V-92TA				S 5450 A	
inner / interno	Detroit Diesel 12V-92TA				S 3450 A	
655 C	Cummins KTA 19C		S 3409 R	S 4510 NR		
some / alcuni	Cummins KTA 19C		S 3409 R			
655 C	Detroit Diesel 12V-92TA				S 5450 A	
inner / interno	Detroit Diesel 12V-92TA				S 3450 A	
855	Detroit Diesel 16V-92N		S 3301 PO			

S Serie

30	Detroit Diesel		S 3301 PO			
power steering / servosterzo	Detroit Diesel					S 8790 PO

T Serie

15	Scania DS 11			S 4323 NR		
power steering / servosterzo	Scania DS 11					S 8790 PO
turbocompressor / turbocompressore	Scania DS 11		S 2329 R			
15 SP	Scania DS 11			S 4323 NR		
power steering / servosterzo	Scania DS 11					S 8790 PO
turbocompressor / turbocompressore	Scania DS 11		S 2329 R			
20	Detroit Diesel 6V-53N		S 3301 PO			
cartridge / immersione	Detroit Diesel 6V-53N					S 8790 PO
power steering / servosterzo	Detroit Diesel 6V-71N		S 3301 PO			
20 (tipo/type 221)	Scania DS 11, DSI 11			S 4323 NR		
20 (tipo/type 225)	Scania DS 11, DSI 11		S 2329 R			
turbocompressor / turbocompressore	Scania DS 11			S 4323 NR		
20 S	Scania DS 11			S 4323 NR		
power steering / servosterzo	Scania DS 11					S 8790 PO
turbocompressor / turbocompressore	Scania DS 11		S 2329 R			
25 (tipo/type 251)	Scania DS 11, DSI 11			S 4323 NR		
turbocompressor / turbocompressore	Scania DS 11, DSI 11		S 2329 R			
30	Detroit Diesel 6V-53N		S 3301 PO			
cartridge / immersione	Detroit Diesel 6V-53N					S 8790 PO
power steering / servosterzo	Detroit Diesel		S 3301 PO		S 5450 A	
inner / interno	Detroit Diesel				S 3450 A	
drive / trasmissione	Detroit Diesel					S 3301 PO

P





kW HP



PETTER

refrigeration units/gruppi refrigeranti

BS Serie

BS649			S 1270 R			
-------	--	--	----------	--	--	--

DKL Serie

DKL4/50			S 2030 R	S 6481 N		
some / alcuni				S 6481 N		

LOC Serie

LOC1					S 6650 A	
LOC2					S 6650 A	

LOCX Serie

LOCX4/50			S 2030 R	S 6481 N		
some / alcuni				S 6481 N		

MOC Serie

MOC					S 6650 A	
-----	--	--	--	--	----------	--

PDL Serie

PDL30			S 0280 PO	S 7111 NC		
-------	--	--	-----------	-----------	--	--

PLAXTON

buses/autobus

Elite

12.6 m	Volvo DH12E420	309 420	01/09 >		S 4120 NR		S 9006 AR
by-pass	Volvo DH12E420	309 420	01/09 >	S 4120 R			
with filter AdBlue/SCR Denoxtronic 1 / con filtro AdBlue/SCR Denoxtronic 1	Volvo DH12E420	309 420	01/09 >				S 4401 U
with filter AdBlue/SCR Denoxtronic 2 / con filtro AdBlue/SCR Denoxtronic 2	Volvo DH12E420	309 420					S 4402 U
dryer filter WABCO / filtro essiccatore WABCO	Volvo DH12E420	309 420	01/09 >				S 7A66 A
2 filters / N.2 filtri	Volvo DH12E420	309 420	01/09 >	S 4402 R			
prefilter / prefiltra	Volvo DH12E420	309 420	01/09 >		S 4461 NR		
14 m	Volvo DH12E420	309 420	01/09 >		S 4120 NR		S 9006 AR
by-pass	Volvo DH12E420	309 420	01/09 >	S 4120 R			
with filter AdBlue/SCR Denoxtronic 1 / con filtro AdBlue/SCR Denoxtronic 1	Volvo DH12E420	309 420	01/09 >				S 4401 U
with filter AdBlue/SCR Denoxtronic 2 / con filtro AdBlue/SCR Denoxtronic 2	Volvo DH12E420	309 420					S 4402 U
dryer filter WABCO / filtro essiccatore WABCO	Volvo DH12E420	309 420	01/09 >				S 7A66 A
2 filters / N.2 filtri	Volvo DH12E420	309 420	01/09 >	S 4402 R			
prefilter / prefiltra	Volvo DH12E420	309 420	01/09 >		S 4461 NR		
15 m	Volvo DH12E420	309 420	01/09 >		S 4120 NR		S 9006 AR
by-pass	Volvo DH12E420	309 420	01/09 >	S 4120 R			
with filter AdBlue/SCR Denoxtronic 1 / con filtro AdBlue/SCR Denoxtronic 1	Volvo DH12E420	309 420	01/09 >				S 4401 U
with filter AdBlue/SCR Denoxtronic 2 / con filtro AdBlue/SCR Denoxtronic 2	Volvo DH12E420	309 420					S 4402 U
dryer filter WABCO / filtro essiccatore WABCO	Volvo DH12E420	309 420	01/09 >				S 7A66 A
2 filters / N.2 filtri	Volvo DH12E420	309 420	01/09 >	S 4402 R			
prefilter / prefiltra	Volvo DH12E420	309 420	01/09 >		S 4461 NR		

Panther

Panther (R09)	MAN D2066LOH02	265 360	01/06 >	S 5046 PE	S 6011 NE	S 7644 A	
dryer filter WABCO / filtro essiccatore WABCO	MAN D2066LOH02	265 360	01/06 >				S 7A66 A
power steering / servosterzo	MAN D2066LOH02	265 360	01/06 >				S 3081 PO
Panther (R09)	MAN D2066LOH03	294 400	01/06 >	S 5046 PE	S 6011 NE	S 7644 A	
dryer filter WABCO / filtro essiccatore WABCO	MAN D2066LOH03	294 400	01/06 >				S 7A66 A
power steering / servosterzo	MAN D2066LOH03	294 400	01/06 >				S 3081 PO

RENAULT TRUCKS

trucks/autocarri

110 Serie

110.150 TI 4x4	MIDR/MIDS06.02.12/12B		10/91 >	S 8600 R			
110.150 TI 4x4	MIDS06.02.26		09/88 >	S 0900 R	S 4323 NR		
110.170 4x4	MIDR/MIDS06.02.12/12B		09/85 >	S 8600 R			
110.170 4x4	MIDS06.02.26		09/88 >	S 0900 R	S 4323 NR		

130 Serie

130B11	797		09/83 > 01/90	S 3241 R			
130B13	797		09/83 > 01/90	S 3241 R			
130B6	797		09/83 > 01/90	S 3241 R			
130B6A	797		09/83 > 01/90	S 3241 R			
130B9	797		09/83 > 01/90	S 3241 R			
130B9A	797		09/83 > 01/90	S 3241 R			
130TB19	797		09/83 > 05/96	S 3241 R			
130TB20	797		09/83 > 05/96	S 3241 R			
130TB21	797		09/83 > 05/96	S 3241 R			

150 Serie

150B11							
some / alcuni	798, MAN 2565		05/83 > 07/86	S 3241 R			
assembly DELPHI / montaggio DELPHI	798, MAN 2565		05/83 > 07/86	S 3241 R	S 7111 NC		

**KW HP****...RENAULT TRUCKS - trucks/autocarri**

150B13	some / alcuni	798, MAN 2565	05/83 > 07/86	S 3241 R			
	assembly DELPHI / montaggio DELPHI	798, MAN 2565	05/83 > 07/86	S 3241 R	S 7111 NC		
85 Serie							
85.150		MIDR/MIDS06.02.12/12B	10/91 >	S 8600 R			
85.150		MIDS06.02.26	09/88 >	S 0900 R	S 4323 NR		
90 Serie							
90B6		720	05/84 > 06/91	S 3241 R		S 7974 A	✗
some / alcuni		720	05/84 > 06/91			S 7638 A	✗
spin-on / avvitabile		720	05/84 > 06/91		S 4323 NR		
with BOSCH pump / con pompa BOSCH		720	05/84 > 06/91		S 9091 N		
with DELPHI pump / con pompa DELPHI		720	05/84 > 06/91		S 7111 NC		
90B6A		720	05/84 > 06/91	S 3241 R		S 7974 A	✗
some / alcuni		720	05/84 > 06/91			S 7638 A	✗
spin-on / avvitabile		720	05/84 > 06/91		S 4323 NR		
with BOSCH pump / con pompa BOSCH		720	05/84 > 06/91		S 9091 N		
with DELPHI pump / con pompa DELPHI		720	05/84 > 06/91		S 7111 NC		
90B6Z		720	05/84 > 06/91	S 3241 R		S 7974 A	✗
some / alcuni		720	05/84 > 06/91			S 7638 A	✗
spin-on / avvitabile		720	05/84 > 06/91		S 4323 NR		
with BOSCH pump / con pompa BOSCH		720	05/84 > 06/91		S 9091 N		
with DELPHI pump / con pompa DELPHI		720	05/84 > 06/91		S 7111 NC		
90B7		720	05/84 > 06/91	S 3241 R		S 7974 A	✗
some / alcuni		720	05/84 > 06/91			S 7638 A	✗
spin-on / avvitabile		720	05/84 > 06/91		S 4323 NR		
with BOSCH pump / con pompa BOSCH		720	05/84 > 06/91		S 9091 N		
with DELPHI pump / con pompa DELPHI		720	05/84 > 06/91		S 7111 NC		
95 Serie							
95.185		MIDR06.02.12	01/88 > 12/88	S 8600 R			
AE Serie							
AE380 Magnum							
dryer filter / filtro essiccatore		MIDR06.35.40	279 380	09/90 > 06/92			S 7259 A
dryer filter WABCO, right-hand thread / filtro essiccatore WABCO, filetto destro		MIDR06.35.40	279 380	09/90 > 06/92			S 7A66 A
LONG LIFE 2 filters / LONG LIFE N.2 filtri		MIDR06.35.40	279 380	09/90 > 06/92		S 4471 NR	
2 filters / N.2 filtri		MIDR06.35.40	279 380	09/90 > 06/92	S 0900 R	S 4323 NR	
rotor for oil centrifuge / rotore per filtro olio centrifugo		MIDR06.35.40	279 380	09/90 > 06/92	S 5900 PO		
AE385 Magnum							
dryer filter / filtro essiccatore		MIDR06.35.40	283 385	02/92 > 10/96			S 7259 A
dryer filter WABCO, right-hand thread / filtro essiccatore WABCO, filetto destro		MIDR06.35.40	283 385	02/92 > 10/96			S 7A66 A
LONG LIFE 2 filters / LONG LIFE N.2 filtri		MIDR06.35.40	283 385	02/92 > 10/96		S 4471 NR	
2 filters / N.2 filtri		MIDR06.35.40	283 385	02/92 > 10/96	S 0900 R	S 4323 NR	
rotor for oil centrifuge / rotore per filtro olio centrifugo		MIDR06.35.40	283 385	02/92 > 10/96	S 5900 PO		
AE390 Magnum							
dryer filter / filtro essiccatore		MIDR06.24.65	287 390	02/96 > 02/00			S 7357 A
dryer filter WABCO, right-hand thread / filtro essiccatore WABCO, filetto destro		MIDR06.24.65	287 390	02/96 > 02/00			S 7259 A
inner / interno		MIDR06.24.65	287 390	02/96 > 02/00			S 7A66 A
LONG LIFE 2 filters / LONG LIFE N.2 filtri		MIDR06.24.65	287 390	02/96 > 02/00		S 4471 NR	
2 filters / N.2 filtri		MIDR06.24.65	287 390	02/96 > 02/00	S 0900 R	S 4323 NR	
rotor for oil centrifuge / rotore per filtro olio centrifugo		MIDR06.24.65	287 390	02/96 > 02/00	S 5900 PO		
power steering / servosterzo		MIDR06.24.65	287 390	02/96 > 02/00			S 3081 PO
AE400 Magnum E-Tech							
with automatic gearbox and hydraulic retarder ZF / con cambio automatico e rallentatore idraulico ZF		MIDR06.24.65	294 400	02/00 > 05/05			S 7357 A
dryer filter / filtro essiccatore		MIDR06.24.65	294 400	02/00 > 05/05			S 2234 Z
dryer filter WABCO, right-hand thread / filtro essiccatore WABCO, filetto destro		MIDR06.24.65	294 400	02/00 > 05/05			S 7259 A
inner / interno		MIDR06.24.65	294 400	02/00 > 05/05			S 7A66 A
2 filters / N.2 filtri		MIDR06.24.65	294 400	02/00 > 05/05	S 0900 R	S 0712 NR	
prefilter SEPAR 2000, heated / prefiltro SEPAR 2000, riscaldato		MIDR06.24.65	294 400	02/00 > 05/05		S 6059 NE	
rotor for oil centrifuge / rotore per filtro olio centrifugo		MIDR06.24.65	294 400	02/00 > 05/05	S 5903 PO		
power steering / servosterzo		MIDR06.24.65	294 400	02/00 > 05/05			S 3081 PO
AE420 Magnum							
dryer filter / filtro essiccatore		MIDR06.24.65	305 415	10/92 > 12/96			✗
dryer filter WABCO, right-hand thread / filtro essiccatore WABCO, filetto destro		MIDR06.24.65	305 415	10/92 > 12/96			S 7259 A
LONG LIFE 2 filters / LONG LIFE N.2 filtri		MIDR06.24.65	305 415	10/92 > 12/96			S 7A66 A
2 filters / N.2 filtri		MIDR06.24.65	305 415	10/92 > 12/96	S 0900 R	S 4471 NR	
rotor for oil centrifuge / rotore per filtro olio centrifugo		MIDR06.24.65	305 415	10/92 > 12/96	S 5900 PO	S 4323 NR	
power steering / servosterzo		MIDR06.24.65	305 415	10/92 > 12/96			S 3081 PO
AE420 TI Magnum							
		MIDR06.35.40	305 415	10/92 > 12/96			✗





KW HP



...RENAULT TRUCKS - trucks/autocarri

R

dryer filter / filtro essiccatore	MIDR06.35.40	305	415	10/92	>	12/96				S 7259 A
dryer filter WABCO, right-hand thread / filtro essiccatore WABCO, filetto destro	MIDR06.35.40	305	415	10/92	>	12/96				S 7A66 A
LONG LIFE 2 filters / LONG LIFE N.2 filtri	MIDR06.35.40	305	415	10/92	>	12/96				
2 filters / N.2 filtri	MIDR06.35.40	305	415	10/92	>	12/96	S 0900 R	S 4471 NR	S 4323 NR	
rotor for oil centrifuge / rotore per filtro olio centrifugo	MIDR06.35.40	305	415	10/92	>	12/96	S 5900 PO			
power steering / servosterzo	MIDR06.35.40	305	415	10/92	>	12/96				S 3081 PO
AE430 Magnum	MIDR06.24.65	316	430	02/96	>	02/00				S 7357 A
dryer filter / filtro essiccatore	MIDR06.24.65	316	430	02/96	>	02/00				S 7259 A
dryer filter WABCO, right-hand thread / filtro essiccatore WABCO, filetto destro	MIDR06.24.65	316	430	02/96	>	02/00				S 7A66 A
inner / interno	MIDR06.24.65	316	430	02/96	>	02/00			S 7406 A	
LONG LIFE 2 filters / LONG LIFE N.2 filtri	MIDR06.24.65	316	430	02/96	>	02/00		S 4471 NR		
2 filters / N.2 filtri	MIDR06.24.65	316	430	02/96	>	02/00	S 0900 R	S 4323 NR		
rotor for oil centrifuge / rotore per filtro olio centrifugo	MIDR06.24.65	316	430	02/96	>	02/00	S 5900 PO			
power steering / servosterzo	MIDR06.24.65	316	430	02/96	>	02/00				S 3081 PO
AE440 Magnum E-Tech	06.24.65B46	324	441	02/00	>	05/05				S 7357 A
with automatic gearbox and hydraulic retarder ZF / con cambio automatico e rallentatore idraulico ZF	06.24.65B46	324	441	02/00	>	05/05				S 2234 Z
dryer filter / filtro essiccatore	06.24.65B46	324	441	02/00	>	05/05				S 7259 A
dryer filter WABCO, right-hand thread / filtro essiccatore WABCO, filetto destro	06.24.65B46	324	441	02/00	>	05/05				S 7A66 A
inner / interno	06.24.65B46	324	441	02/00	>	05/05			S 7406 A	
2 filters / N.2 filtri	06.24.65B46	324	441	02/00	>	05/05	S 0900 R	S 0712 NR	S 6059 NE	
prefilter SEPAR 2000, heated / prefiltro SEPAR 2000, riscaldato	06.24.65B46	324	441	02/00	>	05/05				
rotor for oil centrifuge / rotore per filtro olio centrifugo	06.24.65B46	324	441	02/00	>	05/05	S 5903 PO			
power steering / servosterzo	06.24.65B46	324	441	02/00	>	05/05				S 3081 PO
AE470	MIDR06.24.65	346	470	02/96	>	02/00				S 7357 A
dryer filter / filtro essiccatore	MIDR06.24.65	346	470	02/96	>	02/00				S 7259 A
dryer filter WABCO, right-hand thread / filtro essiccatore WABCO, filetto destro	MIDR06.24.65	346	470	02/96	>	02/00				S 7A66 A
inner / interno	MIDR06.24.65	346	470	02/96	>	02/00			S 7406 A	
LONG LIFE 2 filters / LONG LIFE N.2 filtri	MIDR06.24.65	346	470	02/96	>	02/00		S 4471 NR		
2 filters / N.2 filtri	MIDR06.24.65	346	470	02/96	>	02/00	S 0900 R	S 4323 NR		
rotor for oil centrifuge / rotore per filtro olio centrifugo	MIDR06.24.65	346	470	02/96	>	02/00	S 5900 PO			
power steering / servosterzo	MIDR06.24.65	346	470	02/96	>	02/00				S 3081 PO
AE470 Magnum	MIDR06.24.65	346	470	02/96	>	02/00				S 7357 A
dryer filter / filtro essiccatore	MIDR06.24.65	346	470	02/96	>	02/00				S 7259 A
dryer filter WABCO, right-hand thread / filtro essiccatore WABCO, filetto destro	MIDR06.24.65	346	470	02/96	>	02/00				S 7A66 A
inner / interno	MIDR06.24.65	346	470	02/96	>	02/00			S 7406 A	
LONG LIFE 2 filters / LONG LIFE N.2 filtri	MIDR06.24.65	346	470	02/96	>	02/00		S 4471 NR		
2 filters / N.2 filtri	MIDR06.24.65	346	470	02/96	>	02/00	S 0900 R	S 4323 NR		
rotor for oil centrifuge / rotore per filtro olio centrifugo	MIDR06.24.65	346	470	02/96	>	02/00	S 5900 PO			
power steering / servosterzo	MIDR06.24.65	346	470	02/96	>	02/00				S 3081 PO
AE480 Magnum E-Tech	06.24.65C46			02/00	>	05/05	S 0900 R			S 7357 A
with automatic gearbox and hydraulic retarder ZF / con cambio automatico e rallentatore idraulico ZF	06.24.65C46			02/00	>	05/05				S 2234 Z
dryer filter / filtro essiccatore	06.24.65C46			02/00	>	05/05				S 7259 A
inner / interno	06.24.65C46			02/00	>	05/05			S 7406 A	
2 filters / N.2 filtri	06.24.65C46			02/00	>	05/05		S 0712 NR		
power steering / servosterzo	06.24.65C46			02/00	>	05/05				S 3081 PO
AE500 Magnum										
with pump BOSCH / con pompa BOSCH	Mack EE9-502			09/90	>	10/92	S 0900 R	S 4323 NR		
dryer filter / filtro essiccatore	Mack EE9-502			09/90	>	10/92				S 7259 A
AE520 Magnum										
with pump BOSCH / con pompa BOSCH	Mack EE9-530			10/92	>		S 0900 R	S 4323 NR		
dryer filter / filtro essiccatore	Mack EE9-530			10/92	>					S 7259 A
AE560										
with pump BOSCH / con pompa BOSCH	Mack EE9			02/96	>		S 0900 R	S 4323 NR		
dryer filter / filtro essiccatore	Mack EE9			02/96	>					S 7259 A
power steering / servosterzo	Mack EE9			02/96	>					S 3081 PO
AE560 Magnum										
with pump BOSCH / con pompa BOSCH	Mack EE9			02/96	>		S 0900 R	S 4323 NR		
dryer filter / filtro essiccatore	Mack EE9			02/96	>					S 7259 A
power steering / servosterzo	Mack EE9			02/96	>					S 3081 PO
B Serie										
B70.35D	Sofim 8140			01/83	>	03/86	S 8310 R	S 8500 NR	S 9240 A	
	Sofim 8140			04/86	>	12/90	S 3003 DR	S 8500 NR	S 9240 A	
some / alcuni	Sofim 8140			01/83	>	03/86	S 8310 R	S 4323 NR	S 9240 A	
some / alcuni	Sofim 8140			04/86	>	12/90	S 3003 DR	S 4323 NR	S 9240 A	
with pump BOSCH / con pompa BOSCH	Sofim 8140			01/83	>	03/86	S 8310 R	S 9091 N	S 9240 A	
with pump BOSCH / con pompa BOSCH	Sofim 8140			04/86	>	12/90	S 3003 DR	S 9091 N	S 9240 A	
B70.45D	Sofim 8140			01/83	>	03/86	S 8310 R	S 8500 NR	S 9240 A	

**kW HP**

...RENAULT TRUCKS - trucks/autocarri

some / alcuni	Sofim 8140			04/86 > 12/90	S 3003 DR	S 8500 NR	S 9240 A	
some / alcuni	Sofim 8140			01/83 > 03/86	S 8310 R	S 4323 NR	S 9240 A	
some / alcuni	Sofim 8140			04/86 > 12/90	S 3003 DR	S 4323 NR	S 9240 A	
with pump BOSCH / con pompa BOSCH	Sofim 8140			01/83 > 03/86	S 8310 R	S 9091 N	S 9240 A	
with pump BOSCH / con pompa BOSCH	Sofim 8140			04/86 > 12/90	S 3003 DR	S 9091 N	S 9240 A	
B80	Sofim 8140			01/83 > 03/86	S 8310 R	S 8500 NR	S 9240 A	
	Sofim 8140			04/86 > 12/90	S 3003 DR	S 8500 NR	S 9240 A	
some / alcuni	Sofim 8140			01/83 > 03/86	S 8310 R	S 4323 NR	S 9240 A	
some / alcuni	Sofim 8140			04/86 > 12/90	S 3003 DR	S 4323 NR	S 9240 A	
with pump BOSCH / con pompa BOSCH	Sofim 8140			01/83 > 03/86	S 8310 R	S 9091 N	S 9240 A	
with pump BOSCH / con pompa BOSCH	Sofim 8140			04/86 > 12/90	S 3003 DR	S 9091 N	S 9240 A	
B90 Turbodiesel	Sofim 8140			04/86 > 01/92	S 3003 DR	S 8500 NR		
some / alcuni	Sofim 8140			04/86 > 01/92	S 3003 DR	S 4323 NR		
C Serie								
C210	MID06.20.45	153	208	04/83 > 06/91				✗
with pump BOSCH / con pompa BOSCH	MID06.20.45	153	208	04/83 > 06/91		S 3010 N		
with BOSCH pump 2 filters / con pompa BOSCH N.2 filtri	MID06.20.45	153	208	04/83 > 06/91		S 4323 NR		
inner DONALDSON EBG 14-0407/FHG 14-0323 / interno DONALDSON EBG 14-0407/FHG 14-0323	MID06.20.45	153	208	04/83 > 06/91			S 2840 A	
assembly DONALDSON EBG 14-0407 / montaggio DONALDSON EBG 14-0407	MID06.20.45	153	208	04/83 > 06/91			S 7368 A	
assembly DONALDSON FHG 14-0323 / montaggio DONALDSON FHG 14-0323	MID06.20.45	153	208	04/83 > 06/91			S 6550 A	
assembly PERMATIC / montaggio PERMATIC	MID06.20.45	153	208	04/83 > 06/91			S 7A24 A	
2 filters / N.2 filtri	MID06.20.45	153	208	04/83 > 09/88	S 8600 R			
2 filters / N.2 filtri	MID06.20.45	153	208	10/88 > 06/91	S 0900 R			
power steering / servosterzo	MID06.20.45	153	208	04/83 > 06/91				S 3081 PO
C230	MIDR06.02.26	166	226	05/90 > 09/92	S 0900 R	S 4323 NR		✗
inner DONALDSON EBG 14-0407/FHG 14-0323 / interno DONALDSON EBG 14-0407/FHG 14-0323	MIDR06.02.26	166	226	05/90 > 09/92			S 2840 A	
assembly DONALDSON EBG 14-0407 / montaggio DONALDSON EBG 14-0407	MIDR06.02.26	166	226	05/90 > 09/92			S 7368 A	
assembly DONALDSON EBG 14-0407 / montaggio DONALDSON EBG 14-0407	MIDR06.02.26	166	226	05/90 > 09/92			S 7368 A	
assembly DONALDSON FHG 14-0323 / montaggio DONALDSON FHG 14-0323	MIDR06.02.26	166	226	05/90 > 09/92			S 6550 A	
assembly PERMATIC / montaggio PERMATIC	MIDR06.02.26	166	226	05/90 > 09/92			S 7A24 A	
power steering / servosterzo	MIDR06.02.26	166	226	05/90 > 09/92				S 3081 PO
C260	MIDS06.20.45	192	260	10/82 > 10/98				✗
with BOSCH pump 2 filters / con pompa BOSCH N.2 filtri	MIDS06.20.45	192	260	10/82 > 10/98		S 4323 NR		
dryer filter / filtro essiccatore	MIDS06.20.45	192	260	01/85 > 10/98				S 7259 A
inner DONALDSON EBG 14-0407/FHG 14-0323 / interno DONALDSON EBG 14-0407/FHG 14-0323	MIDS06.20.45	192	260	10/82 > 10/98			S 2840 A	
assembly DONALDSON EBG 14-0407 / montaggio DONALDSON EBG 14-0407	MIDS06.20.45	192	260	10/82 > 10/98			S 7368 A	
assembly DONALDSON FHG 14-0323 / montaggio DONALDSON FHG 14-0323	MIDS06.20.45	192	260	10/82 > 10/98			S 6550 A	
assembly PERMATIC / montaggio PERMATIC	MIDS06.20.45	192	260	10/82 > 10/98			S 7A24 A	
2 filters / N.2 filtri	MIDS06.20.45	192	260	10/82 > 10/98	S 8600 R			
C280	MIDS06.20.45B	202	275	09/82 > 10/98				✗
dryer filter / filtro essiccatore	MIDS06.20.45B	202	275	01/85 > 10/98				S 7259 A
inner DONALDSON EBG 14-0407/FHG 14-0323 / interno DONALDSON EBG 14-0407/FHG 14-0323	MIDS06.20.45B	202	275	09/82 > 10/98			S 2840 A	
assembly DONALDSON EBG 14-0407 / montaggio DONALDSON EBG 14-0407	MIDS06.20.45B	202	275	09/82 > 10/98			S 7368 A	
assembly DONALDSON FHG 14-0323 / montaggio DONALDSON FHG 14-0323	MIDS06.20.45B	202	275	09/82 > 10/98			S 6550 A	
assembly PERMATIC / montaggio PERMATIC	MIDS06.20.45B	202	275	09/82 > 10/98			S 7A24 A	
2 filters / N.2 filtri	MIDS06.20.45B	202	275	09/82 > 10/98	S 0900 R	S 4323 NR		
rotor for oil centrifuge / rotore per filtro olio centrifugo	MIDS06.20.45B	202	275	10/89 > 10/98	S 5900 PO			
power steering / servosterzo	MIDS06.20.45B	202	275	09/82 > 10/98				S 3081 PO
C290	MIDS06.20.45D	214	291	09/82 > 10/98				✗
some outer / alcuni esterno	MIDS06.20.45D	214	291	09/82 > 10/98			S 7343 A	
some inner / alcuni interno	MIDS06.20.45D	214	291	09/82 > 10/98			S 7342 A	
dryer filter / filtro essiccatore	MIDS06.20.45D	214	291	01/85 > 10/98				S 7259 A
inner DONALDSON EBG 14-0407/FHG 14-0323 / interno DONALDSON EBG 14-0407/FHG 14-0323	MIDS06.20.45D	214	291	09/82 > 10/98			S 2840 A	
assembly DONALDSON EBG 14-0407 / montaggio DONALDSON EBG 14-0407	MIDS06.20.45D	214	291	09/82 > 10/98			S 7368 A	
assembly DONALDSON FHG 14-0323 / montaggio DONALDSON FHG 14-0323	MIDS06.20.45D	214	291	09/82 > 10/98			S 6550 A	
assembly PERMATIC / montaggio PERMATIC	MIDS06.20.45D	214	291	09/82 > 10/98			S 7A24 A	
2 filters / N.2 filtri	MIDS06.20.45D	214	291	09/82 > 10/98	S 8600 R	S 4323 NR		
C300	MIDR06.20.45D/D3	222	302	04/87 > 10/98			S 7372 A	✗
some 2 filters (1 1/8-16 UN) / alcuni N.2 filtri (1 1/8-16 UN)	MIDR06.20.45D/D3	222	302	04/87 > 10/98	S 0900 R			
dryer filter / filtro essiccatore	MIDR06.20.45D/D3	222	302	04/87 > 10/98				S 7259 A
inner / interno	MIDR06.20.45D/D3	222	302	04/87 > 10/98			S 7342 A	
2 filters / N.2 filtri	MIDR06.20.45D/D3	222	302	04/87 > 10/98	S 8600 R	S 4323 NR		
rotor for oil centrifuge / rotore per filtro olio centrifugo	MIDR06.20.45D/D3	222	302	10/89 > 10/98	S 5900 PO			
C300 4x4	MIDR06.20.45D/D3	222	302	04/87 > 10/98			S 7372 A	✗
some 2 filters (1 1/8-16 UN) / alcuni N.2 filtri (1 1/8-16 UN)	MIDR06.20.45D/D3	222	302	04/87 > 10/98	S 0900 R			
dryer filter / filtro essiccatore	MIDR06.20.45D/D3	222	302	04/87 > 10/98				S 7259 A
inner / interno	MIDR06.20.45D/D3	222	302	04/87 > 10/98			S 7342 A	

R



...RENAULT TRUCKS - trucks/autocarri

R



2 filters / N.2 filtri	MIDR06.20.45D/D3	222	302	04/87	>	10/98	S 8600 R	S 4323 NR		
rotor for oil centrifuge / rotore per filtro olio centrifugo	MIDR06.20.45D/D3	222	302	10/89	>	10/98	S 5900 PO			
C340 TI	MIDR06.20.45E	249	339	07/90	>	10/98			S 7372 A	✗ S 7259 A
dryer filter / filtro essiccatore	MIDR06.20.45E	249	339	07/90	>	10/98			S 7342 A	
inner / interno	MIDR06.20.45E	249	339	07/90	>	10/98				
2 filters / N.2 filtri	MIDR06.20.45E	249	339	07/90	>	10/98	S 0900 R	S 4323 NR		
rotor for oil centrifuge / rotore per filtro olio centrifugo	MIDR06.20.45E	249	339	07/90	>	10/98	S 5900 PO			
power steering / servosterzo	MIDR06.20.45E	249	339	07/90	>	10/98				S 3081 PO
C380										
prefilter RACOR / prefiltro RACOR	DTI11 Euro6	279	380	08/13	>			S 4477 NR		
C430										
prefilter RACOR / prefiltro RACOR	DTI11 Euro6			08/13	>			S 4477 NR		
C440										
prefilter RACOR / prefiltro RACOR	DTI13 Euro6	324	440	08/13	>			S 4477 NR		
C460										
with activated carbons / ai carboni attivi	DTI11 Euro6	338	460	08/13	>			S 4477 NR		
C480										
with activated carbons / ai carboni attivi	DTI13 Euro6	353	480	08/13	>			S 4477 NR		
C520										
prefilter RACOR / prefiltro RACOR	DTI13 Euro6	382	520	08/13	>			S 4477 NR		
CLM Serie										
CLM280	MIDS06.35.40 D	208	283	04/86	>	10/92	S 8600 R	S 4323 NR		
with pump BOSCH / con pompa BOSCH	MIDS06.35.40 D	208	283	04/86	>	10/92	S 8600 R	S 3010 N		
with pump SIGMA FS300 / con pompa SIGMA FS300	MIDS06.35.40 D	208	283	04/86	>	10/92	S 8600 R	S 0510 NR		
dryer filter / filtro essiccatore	MIDS06.35.40 D	208	283	04/86	>	10/92				S 7259 A
cartridge / immersione	MIDS06.35.40 D	208	283	04/86	>	10/92	S 1910 PO			
CLM320 T	MIDR06.35.40	236	321	10/92	>		S 8600 R	S 4323 NR		
dryer filter / filtro essiccatore	MIDR06.35.40	236	321	10/92	>					S 7259 A
power steering / servosterzo	MIDR06.35.40	236	321	10/92	>					S 3081 PO
CLM340	MIDR06.35.40 G	247	336	02/88	>	10/91	S 8600 R	S 4323 NR		
some / alcuni	MIDR06.35.40 G	247	336	02/88	>	10/91	S 8600 R	S 8111 NC	S 8840 A	
dryer filter / filtro essiccatore	MIDR06.35.40 G	247	336	02/88	>	10/91				S 7259 A
CLM350 T	MIDR06.35.40 G	259	352	04/91	>	10/92	S 8600 R	S 4323 NR		
dryer filter / filtro essiccatore	MIDR06.35.40 G	259	352	04/91	>	10/92				S 7259 A
power steering / servosterzo	MIDR06.35.40 G	259	352	04/91	>	10/92				S 3081 PO
CLM380 T	MIDR06.35.40 H	275	374	05/91	>	10/92	S 8600 R	S 4323 NR		
dryer filter / filtro essiccatore	MIDR06.35.40 H	275	374	05/91	>	10/92				S 7259 A
CLM385 T	MIDR06.35.40	283	385	10/92	>		S 8600 R	S 4323 NR		
dryer filter / filtro essiccatore	MIDR06.35.40	283	385	10/92	>					S 7259 A
power steering / servosterzo	MIDR06.35.40	283	385	10/92	>					S 3081 PO
CLR Serie										
CLR220										
with complete filter DONALDSON / con filtro completo DONALDSON	MIDR06.02.26	162	220	05/86	>	08/88	S 8600 R	S 4323 NR	S 6550 A	
with complete filter DONALDSON / con filtro completo DONALDSON	MIDR06.02.26	162	220	09/88	>	05/91	S 0900 R	S 4323 NR	S 6550 A	
inner / interno	MIDR06.02.26	162	220	05/86	>	05/91			S 2840 A	
CLR220 4x4										
with complete filter DONALDSON / con filtro completo DONALDSON	MIDR06.02.26	162	220	05/86	>	08/88	S 8600 R	S 4323 NR	S 6550 A	
with complete filter DONALDSON / con filtro completo DONALDSON	MIDR06.02.26	162	220	09/88	>	05/91	S 0900 R	S 4323 NR	S 6550 A	
inner / interno	MIDR06.02.26	162	220	05/86	>	05/91			S 2840 A	
CLR230	MIDR06.02.26D	166	226	09/90	>	10/98	S 0900 R	S 4323 NR	S 2650 A	
some / alcuni	MIDR06.02.26D	166	226	09/90	>	10/98	S 0900 R	S 7111 NC	S 2650 A	
some / alcuni	MIDR06.02.26D	166	226	09/90	>	10/98	S 0900 R	S 3010 N	S 2650 A	
some / alcuni	MIDR06.02.26D	166	226	09/90	>	10/98	S 0900 R		S 2650 A	
inner / interno	MIDR06.02.26D	166	226	09/90	>	10/98			S 7129 A	
CLR290										
with complete filter / con filtro completo	MIDR06.20.45D	212	290	05/86	>	05/91	S 8600 R	S 4323 NR	S 6550 A	
inner / interno	MIDR06.20.45D	212	290	05/86	>	05/91			S 2840 A	
D Serie										
D 3.5 150	DTI 3	110	150	04/14	>		S 5026 PE	S 1411 GC	S 9380 A	
D 3.5 HD 150	DTI 3	110	150	04/14	>		S 5026 PE	S 1411 GC	S 9380 A	
D 5.6 150	DTI 3	110	150	04/14	>		S 5026 PE	S 1411 GC	S 9380 A	
D 6.5 150	DTI 3	110	150	04/14	>		S 5026 PE	S 1411 GC	S 9380 A	
D 7.5 180	DTI 3	130	177	04/14	>		S 5026 PE	S 1411 GC	S 9380 A	
E Serie										
E110	MAN 2156 HM5F						S 0530 PO	S 0201 N		
2nd passage / 2.passaggio	MAN 2156 HM5F							S 1411 N		
E37	597 Diesel						S 3241 R			



KW HP



...RENAULT TRUCKS - trucks/autocarri

E45	597 Diesel			S 3241 R			
E7C	597 Diesel			S 3241 R			
E7N	MAN 2156 HM5F			S 0530 PO	S 0201 N		
	2nd passage / 2.passaggio	MAN 2156 HM5F			S 1411 N		
E85	597 Diesel			S 3241 R			
G Serie							
G170 Turbo	MIDR/MIDS06.02.12/12B			S 8600 R			
G170 Turbo	MIDS06.02.26	09/88 >		S 0900 R	S 4323 NR		
G170.11	MIDR/MIDS06.02.12/12B			S 8600 R			
G170.11	MIDS06.02.26	09/88 >		S 0900 R	S 4323 NR		
G170.13	MIDR/MIDS06.02.12/12B			S 8600 R			
G170.13	MIDS06.02.26	09/88 >		S 0900 R	S 4323 NR		
G170.15	MIDR/MIDS06.02.12/12B			S 8600 R			
G170.15	MIDS06.02.26	09/88 >		S 0900 R	S 4323 NR		
G170.16	MIDR/MIDS06.02.12/12B			S 8600 R			
G170.16	MIDS06.02.26	09/88 >		S 0900 R	S 4323 NR		
G170.17	MIDR/MIDS06.02.12/12B			S 8600 R			
G170.17	MIDS06.02.26	09/88 >		S 0900 R	S 4323 NR		
G170.17A	MIDR/MIDS06.02.12/12B			S 8600 R			
G170.17A	MIDS06.02.26	09/88 >		S 0900 R	S 4323 NR		
G210							
spin-on / avvitabile	MID06.20.45/MIDS06.20.30	11/83 >	02/90	S 8600 R	S 4323 NR		
with pump BOSCH / con pompa BOSCH	MID06.20.45/MIDS06.20.30	11/83 >	02/90	S 8600 R	S 3010 N		
with pump DELPHI / con pompa DELPHI	MID06.20.45/MIDS06.20.30	11/83 >	02/90	S 8600 R	S 7111 NC		
with pump SIGMA V80 / con pompa SIGMA V80	MID06.20.45/MIDS06.20.30	11/83 >	02/90	S 8600 R			
inner / interno	MID06.20.45/MIDS06.20.30	11/83 >	02/90			S 7129 A	
inner / interno	MID06.20.45/MIDS06.20.30	11/83 >	02/90			S 8940 A	
inner / interno	MID06.20.45/MIDS06.20.30	11/83 >	02/90			S 2840 A	
assembly DONALDSON / montaggio DONALDSON	MID06.20.45/MIDS06.20.30	11/83 >	02/90	S 8600 R		S 0150 A	
assembly DONALDSON / montaggio DONALDSON	MID06.20.45/MIDS06.20.30	11/83 >	02/90	S 8600 R		S 6550 A	
assembly MANN / montaggio MANN	MID06.20.45/MIDS06.20.30	11/83 >	02/90	S 8600 R		S 5270 A	
assembly MANN / montaggio MANN	MID06.20.45/MIDS06.20.30	11/83 >	02/90	S 8600 R		S 2650 A	
assembly PERMATIC FO1719 / montaggio PERMATIC FO1719	MID06.20.45/MIDS06.20.30	11/83 >	02/90			S 7614 A	
G230							
spin-on / avvitabile	MID06.20.45/MIDS06.20.30	01/85 >	03/93	S 8600 R	S 4323 NR		
with pump BOSCH / con pompa BOSCH	MID06.20.45/MIDS06.20.30	01/85 >	03/93	S 8600 R	S 3010 N		
with pump SIGMA V80 / con pompa SIGMA V80	MID06.20.45/MIDS06.20.30	01/85 >	03/93	S 8600 R			
inner / interno	MID06.20.45/MIDS06.20.30	01/85 >	03/93			S 7129 A	
inner / interno	MID06.20.45/MIDS06.20.30	01/85 >	03/93			S 2840 A	
assembly DONALDSON / montaggio DONALDSON	MID06.20.45/MIDS06.20.30	01/85 >	03/93	S 8600 R		S 6550 A	
assembly MANN / montaggio MANN	MID06.20.45/MIDS06.20.30	01/85 >	03/93	S 8600 R		S 5270 A	
assembly MANN / montaggio MANN	MID06.20.45/MIDS06.20.30	01/85 >	03/93	S 8600 R		S 2650 A	
assembly PERMATIC FO1719 / montaggio PERMATIC FO1719	MID06.20.45/MIDS06.20.30	01/85 >	03/93			S 7614 A	
G250							
with pump BOSCH / con pompa BOSCH	MIDS06.20.45	10/82 >	05/90	S 8600 R	S 4323 NR	S 6550 A	
inner / interno	MIDS06.20.45	10/82 >	05/90			S 2840 A	
assembly DONALDSON / montaggio DONALDSON	MIDS06.20.45	10/82 >	05/90	S 8600 R	S 3010 N	S 6550 A	
G260	MIDR06.20.45	10/82 >	05/90	S 8600 R	S 3010 N	S 7A22 A	✗
with pump BOSCH / con pompa BOSCH	MIDR06.20.45	10/82 >	05/90	S 8600 R	S 4323 NR		
G280	MIDR06.20.45A	10/82 >	01/86	S 8600 R	S 3010 N	S 7A22 A	✗
with pump BOSCH / con pompa BOSCH	MIDR06.20.45A	10/82 >	01/86	S 8600 R	S 4323 NR		
with pump DELPHI / con pompa DELPHI	MIDR06.20.45A	10/82 >	01/86	S 8600 R	S 7111 NC		
with pump DELPHI / con pompa DELPHI	MIDR06.20.45A	10/82 >	01/86	S 8600 R	S 8111 NC		
with pump SIGMA FS300 / con pompa SIGMA FS300	MIDR06.20.45A	10/82 >	01/86		S 0510 NR		
cartridge / immersione	MIDR06.20.45A	10/82 >	01/86	S 1910 PO			
inner / interno	MIDR06.20.45A	10/82 >	01/86			S 2840 A	
assembly DONALDSON / montaggio DONALDSON	MIDR06.20.45A	10/82 >	01/86	S 8600 R		S 8840 A	✗
assembly DONALDSON / montaggio DONALDSON	MIDR06.20.45A	10/82 >	01/86	S 8600 R		S 7945 A	✗
assembly DONALDSON / montaggio DONALDSON	MIDR06.20.45A	10/82 >	01/86	S 8600 R		S 6550 A	✗
assembly DONALDSON / montaggio DONALDSON	MIDR06.20.45A	10/82 >	01/86	S 8600 R		S 4770 A	✗
G290							
spin-on / avvitabile	MID06.20.45			S 8600 R	S 4323 NR		
with pump BOSCH / con pompa BOSCH	MID06.20.45			S 8600 R	S 3010 N		
G320.19	MIDS06.20.45H	10/88 >		S 0900 R	S 4323 NR		
G320.19 6x2	MIDS06.20.45H	10/88 >		S 0900 R	S 4323 NR		
G320.26	MIDS06.20.45H	10/88 >		S 0900 R	S 4323 NR		
G320.26 6x2	MIDS06.20.45H	10/88 >		S 0900 R	S 4323 NR		

R





kW HP



...RENAULT TRUCKS - trucks/autocarri

R



GB Serie

GB131						
some / alcuni	797	06/80 > 12/84	S 3241 R		S 7974 A	
assembly DELPHI / montaggio DELPHI	797	06/80 > 12/84	S 3241 R	S 7111 NC	S 7974 A	
GB191						
some / alcuni	MID06.20.30	06/80 > 12/84	S 8600 R	S 7111 NC	S 2450 A	
spin-on / avvitabile	MID06.20.30	06/80 > 12/84	S 8600 R	S 4323 NR	S 2650 A	
with pump BOSCH / con pompa BOSCH	MID06.20.30	06/80 > 12/84	S 8600 R	S 3010 N	S 2650 A	
with pump SIGMA / con pompa SIGMA	MID06.20.30	06/80 > 12/84	S 8600 R		S 2650 A	
inner / interno	MID06.20.30	06/80 > 12/84			S 7129 A	
inner / interno	MID06.20.30	06/80 > 12/84			S 3940 A	
GB228						
spin-on / avvitabile	MIDS06.20.30		S 8600 R	S 4323 NR		
with pump BOSCH / con pompa BOSCH	MIDS06.20.30		S 8600 R	S 3010 N		
with pump SIGMA / con pompa SIGMA	MIDS06.20.30		S 8600 R			
GB231						
some / alcuni	MIDS06.20.30 Turbo	06/80 > 12/84	S 8600 R	S 4323 NR	S 2450 A	
spin-on / avvitabile	MIDS06.20.30 Turbo	06/80 > 12/84	S 8600 R	S 4323 NR	S 2650 A	
with pump BOSCH / con pompa BOSCH	MIDS06.20.30 Turbo	06/80 > 12/84	S 8600 R	S 3010 N	S 2650 A	
with pump SIGMA / con pompa SIGMA	MIDS06.20.30 Turbo	06/80 > 12/84	S 8600 R		S 2650 A	
inner / interno	MIDS06.20.30 Turbo	06/80 > 12/84			S 7129 A	
inner / interno	MIDS06.20.30 Turbo	06/80 > 12/84			S 3940 A	

GBH Serie

GBH260						
some / alcuni	MIDR06.20.45	09/75 > 08/85	S 8600 R		S 7945 A	
with pump BOSCH / con pompa BOSCH	MIDR06.20.45	09/75 > 08/85	S 8600 R	S 3010 N	S 0150 A	
with pump DELPHI / con pompa DELPHI	MIDR06.20.45	09/75 > 08/85	S 8600 R	S 8111 NC	S 0150 A	
with pump SIGMA FS300 / con pompa SIGMA FS300	MIDR06.20.45	09/75 > 08/85	S 8600 R	S 0510 NR	S 0150 A	
cartridge / immersione	MIDR06.20.45	09/75 > 08/85	S 1910 PO			
inner / interno	MIDR06.20.45	09/75 > 08/85			S 8940 A	
GBH280						
some / alcuni	MIDS/MIDR06.35.40	09/75 > 10/92	S 8600 R		S 6550 A	
some / alcuni	MIDS/MIDR06.35.40	09/75 > 10/92	S 8600 R		S 8840 A	
some / alcuni	MIDS/MIDR06.35.40	09/75 > 10/92	S 8600 R		S 7945 A	
some / alcuni	MIDS/MIDR06.35.40	09/75 > 10/92	S 8600 R		S 4770 A	
spin-on / avvitabile	MIDS/MIDR06.35.40	09/75 > 10/92	S 8600 R	S 4323 NR		
with pump BOSCH / con pompa BOSCH	MIDS/MIDR06.35.40	09/75 > 10/92	S 8600 R	S 3010 N		
with pump DELPHI / con pompa DELPHI	MIDS/MIDR06.35.40	09/75 > 10/92	S 8600 R	S 7111 NC		
with pump SIGMA FS300 / con pompa SIGMA FS300	MIDS/MIDR06.35.40	09/75 > 10/92	S 8600 R			
dryer filter / filtro essiccatore	MIDS/MIDR06.35.40	04/86 > 10/92				S 7259 A
cartridge / immersione	MIDS/MIDR06.35.40	09/75 > 06/80	S 1910 PO			
or / oppure	MIDS/MIDR06.35.40	09/75 > 10/92	S 8600 R	S 8111 NC		

GC Serie

GC190						
spin-on / avvitabile	MID06.20.30		S 8600 R	S 4323 NR	S 2650 A	
with pump BOSCH / con pompa BOSCH	MID06.20.30		S 8600 R	S 3010 N	S 2650 A	
with pump SIGMA / con pompa SIGMA	MID06.20.30		S 8600 R		S 2650 A	
inner / interno	MID06.20.30				S 7129 A	
assembly DELPHI / montaggio DELPHI	MID06.20.30		S 8600 R	S 7111 NC	S 2650 A	
GC191						
spin-on / avvitabile	MID06.20.30		S 8600 R	S 4323 NR		
with pump BOSCH / con pompa BOSCH	MID06.20.30		S 8600 R	S 3010 N		
with pump SIGMA / con pompa SIGMA	MID06.20.30		S 8600 R			
GC231						
spin-on / avvitabile	MIDS06.20.30		S 8600 R	S 4323 NR		
with pump BOSCH / con pompa BOSCH	MIDS06.20.30		S 8600 R	S 3010 N		
with pump SIGMA / con pompa SIGMA	MIDS06.20.30		S 8600 R			

GF Serie

GF151D						
inner / interno					S 3940 A	
assembly DELPHI / montaggio DELPHI			S 3241 R	S 7111 NC	S 2450 A	
GF190						
spin-on / avvitabile	MID06.20.30		S 8600 R	S 4323 NR	S 2650 A	
with pump BOSCH / con pompa BOSCH	MID06.20.30		S 8600 R	S 3010 N	S 2650 A	
with pump SIGMA / con pompa SIGMA	MID06.20.30		S 8600 R		S 2650 A	
inner / interno	MID06.20.30				S 7129 A	
assembly DELPHI / montaggio DELPHI	MID06.20.30		S 8600 R	S 7111 NC	S 2650 A	



kW HP



...RENAULT TRUCKS - trucks/autocarri

GF191						
spin-on / avvitabile	MID06.20.30		S 8600 R	S 4323 NR		
with pump BOSCH / con pompa BOSCH	MID06.20.30		S 8600 R	S 3010 N		
with pump SIGMA / con pompa SIGMA	MID06.20.30		S 8600 R			
GF231						
spin-on / avvitabile	MID/MIDS06.20.30		S 8600 R	S 4323 NR	S 2650 A	
with pump BOSCH / con pompa BOSCH	MID/MIDS06.20.30		S 8600 R	S 3010 N	S 2650 A	
with pump SIGMA / con pompa SIGMA	MID/MIDS06.20.30		S 8600 R		S 2650 A	
inner / interno	MID/MIDS06.20.30				S 7129 A	
assembly DELPHI / montaggio DELPHI	MID/MIDS06.20.30		S 8600 R	S 7111 NC	S 2650 A	
GLR Serie						
GLR130						
spin-on / avvitabile	MID06.20.30		S 8600 R	S 4323 NR		
with pump BOSCH / con pompa BOSCH	MID06.20.30		S 8600 R	S 3010 N		
with pump SIGMA / con pompa SIGMA	MID06.20.30		S 8600 R			
GLR230						
spin-on / avvitabile	MIDS06.20.30		S 8600 R	S 4323 NR		
with pump BOSCH / con pompa BOSCH	MIDS06.20.30		S 8600 R	S 3010 N		
with pump SIGMA / con pompa SIGMA	MIDS06.20.30		S 8600 R			
GR Serie						
GR190						
spin-on / avvitabile	MID06.20.30		S 8600 R	S 4323 NR	S 2650 A	
with pump BOSCH / con pompa BOSCH	MID06.20.30		S 8600 R	S 3010 N	S 2650 A	
with pump SIGMA / con pompa SIGMA	MID06.20.30		S 8600 R		S 2650 A	
inner / interno	MID06.20.30				S 7129 A	
assembly DELPHI / montaggio DELPHI	MID06.20.30		S 8600 R	S 7111 NC	S 2650 A	
GR191						
spin-on / avvitabile	MID06.20.30		S 8600 R	S 4323 NR	S 2650 A	
with pump BOSCH / con pompa BOSCH	MID06.20.30		S 8600 R	S 3010 N	S 2650 A	
with pump SIGMA / con pompa SIGMA	MID06.20.30		S 8600 R		S 2650 A	
inner / interno	MID06.20.30				S 7129 A	
GR231						
spin-on / avvitabile	MID/MIDS06.20.30		S 8600 R	S 4323 NR	S 2650 A	
with BOSCH pump / con pompa BOSCH	MID/MIDS06.20.30		S 8600 R	S 3010 N	S 2650 A	
with SIGMA pump / con pompa SIGMA	MID/MIDS06.20.30		S 8600 R		S 2650 A	
inner / interno	MID/MIDS06.20.30				S 7129 A	
DELPHI assembly / montaggio DELPHI	MID/MIDS06.20.30		S 8600 R	S 7111 NC	S 2650 A	
GR231						
spin-on / avvitabile	MIDS06.20.30 Turbo		S 8600 R	S 4323 NR	S 2650 A	
with pump BOSCH / con pompa BOSCH	MIDS06.20.30 Turbo		S 8600 R	S 3010 N	S 2650 A	
with pump SIGMA / con pompa SIGMA	MIDS06.20.30 Turbo		S 8600 R		S 2650 A	
inner / interno	MIDS06.20.30 Turbo				S 7129 A	
GR260						
with pump BOSCH / con pompa BOSCH	MIDS06.20.45		S 8600 R	S 3010 N	S 0150 A	
with pump DELPHI / con pompa DELPHI	MIDS06.20.45		S 8600 R	S 8111 NC	S 0150 A	
with pump SIGMA FS300 / con pompa SIGMA FS300	MIDS06.20.45		S 8600 R	S 0510 NR	S 0150 A	
cartridge / immersione	MIDS06.20.45		S 1910 PO			
inner / interno	MIDS06.20.45				S 8940 A	
GR280						
some / alcuni	MIDS/MIDR06.35.40	01/73 > 12/82	S 8600 R		S 8840 A	
some / alcuni	MIDS/MIDR06.35.40	01/73 > 12/82	S 8600 R		S 6550 A	
spin-on / avvitabile	MIDS/MIDR06.35.40	01/73 > 12/82	S 8600 R	S 4323 NR		
with BOSCH pump / con pompa BOSCH	MIDS/MIDR06.35.40	01/73 > 12/82	S 8600 R	S 3010 N		
with DELPHI pump / con pompa DELPHI	MIDS/MIDR06.35.40	01/73 > 12/82	S 8600 R	S 7111 NC		
with pump SIGMA / con pompa SIGMA	MIDS/MIDR06.35.40	01/73 > 12/82	S 8600 R			
cartridge / immersione	MIDS/MIDR06.35.40	01/73 > 06/80	S 1910 PO			
or / oppure	MIDS/MIDR06.35.40	01/73 > 12/82	S 8600 R	S 8111 NC		
GR300						
spin-on / avvitabile			S 8600 R	S 4323 NR		
with pump BOSCH / con pompa BOSCH				S 3010 N		
cartridge / immersione			S 1910 PO			
GR305						
spin-on / avvitabile	MDR06.35.40		S 8600 R	S 4323 NR	S 8840 A	
with pump BOSCH / con pompa BOSCH	MDR06.35.40		S 8600 R	S 3010 N	S 8840 A	
with pump SIGMA / con pompa SIGMA	MDR06.35.40		S 8600 R		S 8840 A	
GR320						
spin-on / avvitabile	MIV08.35.30		S 8600 R	S 4323 NR	S 8840 A	

R





kW HP



...RENAULT TRUCKS - trucks/autocarri

R

with pump BOSCH / con pompa BOSCH	MIV08.35.30			S 1910 PO	S 3010 N	S 8840 A	
cartridge / immersione	MIV08.35.30					S 8840 A	
GR350							
spin-on / avvitabile	MIVS08.35.30			S 8600 R	S 4323 NR	S 4770 A	
with pump BOSCH / con pompa BOSCH	MIVS08.35.30			S 8600 R	S 3010 N	S 4770 A	
with pump SIGMA / con pompa SIGMA	MIVS08.35.30			S 8600 R		S 4770 A	
GRH Serie							
GRH235							
spin-on / avvitabile	MIDS06.20.30 D	06/80 > 12/84		S 8600 R	S 4323 NR	S 2650 A	
with pump BOSCH / con pompa BOSCH	MIDS06.20.30 D	06/80 > 12/84		S 8600 R	S 3010 N	S 2650 A	
with pump SIGMA / con pompa SIGMA	MIDS06.20.30 D	06/80 > 12/84		S 8600 R		S 2650 A	
inner / interno	MIDS06.20.30 D	06/80 > 12/84				S 7129 A	
GRH305							
spin-on / avvitabile	MDR06.35.40			S 8600 R	S 4323 NR	S 8840 A	
with pump BOSCH / con pompa BOSCH	MDR06.35.40			S 8600 R	S 3010 N	S 8840 A	
with pump SIGMA / con pompa SIGMA	MDR06.35.40			S 8600 R		S 8840 A	
GRH350							
spin-on / avvitabile	MIVS08.35.30			S 8600 R	S 4323 NR	S 4770 A	
with pump BOSCH / con pompa BOSCH	MIVS08.35.30			S 8600 R	S 3010 N	S 4770 A	
with pump SIGMA / con pompa SIGMA	MIVS08.35.30			S 8600 R		S 4770 A	
HB Serie							
HB15							
	MID/MIDS06.20.30			S 8600 R			
HB17							
	MID/MIDS06.20.30			S 8600 R			
HB170BOM							
spin-on / avvitabile	MID06.20.30			S 8600 R	S 4323 NR	S 2650 A	
with pump BOSCH / con pompa BOSCH	MID06.20.30			S 8600 R	S 3010 N	S 2650 A	
with pump SIGMA / con pompa SIGMA	MID06.20.30			S 8600 R		S 2650 A	
inner / interno	MID06.20.30					S 7129 A	
assembly DELPHI / montaggio DELPHI	MID06.20.30			S 8600 R	S 7111 NC	S 2650 A	
HB19							
	MID/MIDS06.20.30			S 8600 R			
HB190BOM							
spin-on / avvitabile	MID06.20.30			S 8600 R	S 4323 NR	S 2650 A	
with pump BOSCH / con pompa BOSCH	MID06.20.30			S 8600 R	S 3010 N	S 2650 A	
with pump SIGMA / con pompa SIGMA	MID06.20.30			S 8600 R		S 2650 A	
inner / interno	MID06.20.30					S 7129 A	
assembly DELPHI / montaggio DELPHI	MID06.20.30			S 8600 R	S 7111 NC	S 2650 A	
HB26							
	MID/MIDS06.20.30			S 8600 R			
HF Serie							
HF15							
	MID/MIDS06.20.30			S 8600 R			
HF17							
	MID/MIDS06.20.30			S 8600 R			
HF19							
	MID/MIDS06.20.30			S 8600 R			
HF26							
	MID/MIDS06.20.30			S 8600 R			
HL Serie							
HL38							
2nd passage / 2.passaggio	MAN 2566				S 0201 N		
	MAN 2566				S 1411 N		
HL38T							
2nd passage / 2.passaggio	MAN 2566				S 0201 N		
	MAN 2566				S 1411 N		
HM Serie							
HM15							
some / alcuni	798 Diesel			S 3241 R			
assembly DELPHI / montaggio DELPHI	798 Diesel			S 3241 R	S 7111 NC		
HM15							
2nd passage / 2.passaggio	MAN 2565			S 7260 PO	S 0201 N		
	MAN 2565				S 1411 N		
HM17							
some / alcuni	798 Diesel			S 3241 R			
assembly DELPHI / montaggio DELPHI	798 Diesel			S 3241 R	S 7111 NC		
HM17							
2nd passage / 2.passaggio	MAN 2565			S 7260 PO	S 0201 N		
	MAN 2565				S 1411 N		
HM19							
some / alcuni	798 Diesel			S 3241 R			
assembly DELPHI / montaggio DELPHI	798 Diesel			S 3241 R	S 7111 NC		
HM19							
2nd passage / 2.passaggio	MAN 2565			S 7260 PO	S 0201 N		
	MAN 2565				S 1411 N		
HM26							
some / alcuni	798 Diesel			S 3241 R			
assembly DELPHI / montaggio DELPHI	798 Diesel			S 3241 R	S 7111 NC		
HM26							
	MAN 2565			S 7260 PO	S 0201 N		



kW HP



...RENAULT TRUCKS - trucks/autocarri

2nd passage / 2.passaggio	MAN 2565				S 1411 N		
HN Serie							
HN19	MAN 2566				S 0201 N		
2nd passage / 2.passaggio	MAN 2566				S 1411 N		
HN26	MAN 2566				S 0201 N		
2nd passage / 2.passaggio	MAN 2566				S 1411 N		
HR Serie							
HR15							
some / alcuni	797 Diesel				S 3241 R		
assembly DELPHI / montaggio DELPHI	797 Diesel				S 3241 R	S 7111 NC	
JK Serie							
JK60							
some / alcuni	720 Diesel			03/76 > 06/80			S 7638 A
with pump BOSCH / con pompa BOSCH	720 Diesel			03/76 > 06/80	S 3241 R	S 4323 NR	✗
with pump DELPHI / con pompa DELPHI	720 Diesel			03/76 > 06/80	S 3241 R	S 7111 NC	✗
JK60B							
some / alcuni	720-12	67	90	10/79 > 01/86			S 7638 A
with pump BOSCH / con pompa BOSCH	720-12	67	90	10/79 > 01/86	S 3241 R	S 4323 NR	✗
with pump DELPHI / con pompa DELPHI	720-12	67	90	10/79 > 01/86	S 3241 R	S 7111 NC	✗
JK65							
some / alcuni	720 Diesel			03/76 > 01/86			S 7638 A
with pump BOSCH / con pompa BOSCH	720 Diesel			03/76 > 01/86	S 3241 R	S 4323 NR	✗
with pump DELPHI / con pompa DELPHI	720 Diesel			03/76 > 01/86	S 3241 R	S 7111 NC	✗
JK75							
some / alcuni	720 Diesel			03/76 > 01/86			S 7638 A
with pump BOSCH / con pompa BOSCH	720 Diesel			03/76 > 01/86	S 3241 R	S 4323 NR	✗
with pump SIGMA / con pompa SIGMA	720 Diesel			03/76 > 01/86	S 3241 R	S 7111 NC	✗
JK75							
some / alcuni	720-12	66	90	10/79 > 01/86			S 7638 A
with pump / con pompa	720-12	66	90	10/79 > 01/86	S 3241 R	S 4323 NR	✗
with pump BOSCH / con pompa BOSCH	720-12	66	90	10/79 > 01/86	S 3241 R	S 7111 NC	✗
JL Serie							
JL19	Fulgur F644, F646				S 6490 PO	S 8381 NC	
JL20	Fulgur F644, F646				S 6490 PO	S 8381 NC	
JL20/200	Henschel 520D6T				S 0530 PO	S 0201 N	
2nd passage / 2.passaggio	Henschel 520D6T					S 1411 N	
JL21	Fulgur F644, F646				S 6490 PO	S 8381 NC	
JL23	Fulgur F644, F646				S 6490 PO	S 8381 NC	
JL25	Fulgur F644, F646				S 6490 PO	S 8381 NC	
JL28	Fulgur F644, F646				S 6490 PO	S 8381 NC	
JL29	Fulgur F644, F646				S 6490 PO	S 8381 NC	
JL32	Henschel 520D6T				S 0530 PO	S 0201 N	
2nd passage / 2.passaggio	Henschel 520D6T					S 1411 N	
JM Serie							
JM170	MAN				S 0530 PO	S 0101 N	
2nd passage / 2.passaggio	MAN					S 7411 N	
JM170L	MAN				S 0530 PO	S 0101 N	
2nd passage / 2.passaggio	MAN					S 7411 N	
JM170N	MAN				S 0530 PO	S 0101 N	
2nd passage / 2.passaggio	MAN					S 7411 N	
JM170NA	MAN				S 0530 PO	S 0101 N	
2nd passage / 2.passaggio	MAN					S 7411 N	
JM170NP	MAN				S 0530 PO	S 0101 N	
2nd passage / 2.passaggio	MAN					S 7411 N	
JM170UL	MAN				S 0530 PO	S 0101 N	
2nd passage / 2.passaggio	MAN					S 7411 N	
JM170XL	MAN				S 0530 PO	S 0101 N	
2nd passage / 2.passaggio	MAN					S 7411 N	
JM200	MAN 2146HM3, 2146HM4				S 0530 PO	S 0101 N	
2nd passage / 2.passaggio	MAN 2146HM3, 2146HM4					S 1411 N	
JM200L	MAN 2146HM3, 2146HM4				S 0530 PO	S 0101 N	
2nd passage / 2.passaggio	MAN 2146HM3, 2146HM4					S 1411 N	
JM200N	MAN 2146HM3, 2146HM4				S 0530 PO	S 0101 N	
2nd passage / 2.passaggio	MAN 2146HM3, 2146HM4					S 1411 N	
JM200NP	MAN 2146HM3, 2146HM4				S 0530 PO	S 0101 N	
2nd passage / 2.passaggio	MAN 2146HM3, 2146HM4					S 1411 N	
JM200NT	MAN 2146HM3, 2146HM4				S 0530 PO	S 0101 N	

R





kW HP



...RENAULT TRUCKS - trucks/autocarri

R



2nd passage / 2.passaggio	MAN 2146HM3, 2146HM4				S 1411 N		
JM200TT	MAN 2146HM3, 2146HM4			S 0530 PO	S 0101 N		
2nd passage / 2.passaggio	MAN 2146HM3, 2146HM4				S 1411 N		
JM200TTP	MAN 2146HM3, 2146HM4			S 0530 PO	S 0101 N		
2nd passage / 2.passaggio	MAN 2146HM3, 2146HM4				S 1411 N		
JM200UL	MAN 2146HM3, 2146HM4			S 0530 PO	S 0101 N		
2nd passage / 2.passaggio	MAN 2146HM3, 2146HM4				S 1411 N		
JM200V	MAN 2146HM3, 2146HM4			S 0530 PO	S 0101 N		
2nd passage / 2.passaggio	MAN 2146HM3, 2146HM4				S 1411 N		
JM200VN	MAN 2146HM3, 2146HM4			S 0530 PO	S 0101 N		
2nd passage / 2.passaggio	MAN 2146HM3, 2146HM4				S 1411 N		
JM200VP	MAN 2146HM3, 2146HM4			S 0530 PO	S 0101 N		
2nd passage / 2.passaggio	MAN 2146HM3, 2146HM4				S 1411 N		
JM200XL	MAN 2146HM3, 2146HM4			S 0530 PO	S 0101 N		
2nd passage / 2.passaggio	MAN 2146HM3, 2146HM4				S 1411 N		
JM240L	MAN 2146HM, 2146HM4			S 0530 PO	S 0101 N		
2nd passage / 2.passaggio	MAN 2146HM, 2146HM4				S 1411 N		
JM240N	MAN 2146HM, 2146HM4			S 0530 PO	S 0101 N		
2nd passage / 2.passaggio	MAN 2146HM, 2146HM4				S 1411 N		
JM240NA	MAN 2146HM3, 2146HM4			S 0530 PO	S 0101 N		
2nd passage / 2.passaggio	MAN 2146HM3, 2146HM4				S 1411 N		
JM240TPE	MAN 2146HM3, 2146HM4			S 0530 PO	S 0101 N		
2nd passage / 2.passaggio	MAN 2146HM3, 2146HM4				S 1411 N		
JM240UL	MAN 2146HM3, 2146HM4			S 0530 PO	S 0101 N		
2nd passage / 2.passaggio	MAN 2146HM3, 2146HM4				S 1411 N		
JM240V	MAN 2146HM, 2146HM4			S 0530 PO	S 0101 N		
2nd passage / 2.passaggio	MAN 2146HM, 2146HM4				S 1411 N		
JM240VN	MAN 2146HM3, 2146HM4			S 0530 PO	S 0101 N		
2nd passage / 2.passaggio	MAN 2146HM3, 2146HM4				S 1411 N		
JM240XL	MAN 2146HM3, 2146HM4			S 0530 PO	S 0101 N		
2nd passage / 2.passaggio	MAN 2146HM3, 2146HM4				S 1411 N		
JN Serie							
JN60	797 Diesel			06/80 > 06/84	S 3241 R		
assembly DELPHI / montaggio DELPHI	797 Diesel			06/80 > 06/84		S 7111 NC	
assembly PERMATIC FO1719 / montaggio PERMATIC FO1719	797 Diesel			06/80 > 06/84			S 7614 A
JN85	720 Diesel	72	98	06/80 > 06/84	S 3241 R		
with pump BOSCH / con pompa BOSCH	720 Diesel	72	98	06/80 > 06/84		S 4323 NR	
with pump DELPHI / con pompa DELPHI	720 Diesel	72	98	06/80 > 06/84		S 7111 NC	
JN85	797-10	72	98	03/75 > 06/80	S 3241 R		
assembly DELPHI / montaggio DELPHI	797-10	72	98	03/75 > 06/80		S 7111 NC	✗
assembly PERMATIC FO1719 / montaggio PERMATIC FO1719	797-10	72	98	03/75 > 06/80			S 7614 A
JP Serie							
JP11	797 Diesel				S 3241 R	S 7111 NC	
or DELPHI / oppure DELPHI	797 Diesel				S 3241 R		
or PURFLUX / oppure PURFLUX	797 Diesel						
JP11A	797-10	72	98	03/75 > 06/84	S 3241 R		S 7974 A
some / alcuni	797-10	72	98	03/75 > 06/84			S 7638 A
with DELPHI pump / con pompa DELPHI	797-10	72	98	03/75 > 06/84		S 7111 NC	
JP13A	797 Diesel	72	98	03/75 > 06/84	S 3241 R		S 7974 A
	797 Diesel	72	98	03/75 > 06/84	S 8600 R		
some / alcuni	797 Diesel	72	98	03/75 > 06/84			S 7638 A
spin-on / avvitabile	797 Diesel	72	98	03/75 > 06/84		S 4323 NR	
with DELPHI pump / con pompa DELPHI	797 Diesel	72	98	03/75 > 06/84		S 7111 NC	
JP13B	798 -10 Diesel	82	111	05/76 > 06/80	S 3241 R		S 7974 A
some / alcuni	798 -10 Diesel	82	111	05/76 > 06/80			S 7638 A
with DELPHI pump / con pompa DELPHI	798 -10 Diesel	82	111	05/76 > 06/80		S 7111 NC	
JP13C	798 -13 Diesel	82	111	05/76 > 06/80	S 3241 R		S 7974 A
some / alcuni	798 -13 Diesel	82	111	05/76 > 06/80			S 7638 A
with DELPHI pump / con pompa DELPHI	798 -13 Diesel	82	111	05/76 > 06/80		S 7111 NC	
JP14B	797	72	98	12/81 > 06/84	S 3241 R		S 7974 A
	797	72	98	12/81 > 06/84	S 8600 R		
some / alcuni	797	72	98	12/81 > 06/84			S 7638 A
spin-on / avvitabile	797	72	98	12/81 > 06/84		S 4323 NR	
with DELPHI pump / con pompa DELPHI	797	72	98	12/81 > 06/84		S 7111 NC	
JP60A	797 Diesel				S 3241 R	S 7111 NC	
or DELPHI / oppure DELPHI	797 Diesel				S 3241 R		
or PURFLUX / oppure PURFLUX	797 Diesel						



kW HP



...RENAULT TRUCKS - trucks/autocarri

JP90 or DELPHI / oppure DELPHI or PURFLUX / oppure PURFLUX	797 Diesel 797 Diesel		S 3241 R S 3241 R	S 7111 NC		
JP95 or DELPHI / oppure DELPHI or PURFLUX / oppure PURFLUX	797 Diesel 797 Diesel		S 3241 R S 3241 R	S 7111 NC		
JR Serie						
JR19A with pump DELPHI / con pompa DELPHI	798 Diesel		S 3241 R	S 7111 NC		
JR19B with pump DELPHI / con pompa DELPHI	798 Diesel		S 3241 R	S 7111 NC		
JR21A with pump DELPHI / con pompa DELPHI	798 Diesel		S 3241 R	S 7111 NC		
JR21B with pump DELPHI / con pompa DELPHI	798 Diesel		S 3241 R	S 7111 NC		
JR21C with pump DELPHI / con pompa DELPHI	798 Diesel		S 3241 R	S 7111 NC		
JX Serie						
JX21AT or DELPHI / oppure DELPHI or PURFLUX / oppure PURFLUX	797 Diesel 797 Diesel		S 3241 R S 3241 R	S 7111 NC		
JX21BT or DELPHI / oppure DELPHI or PURFLUX / oppure PURFLUX	797 Diesel 797 Diesel		S 3241 R S 3241 R	S 7111 NC		
JX21CT or DELPHI / oppure DELPHI or PURFLUX / oppure PURFLUX	797 Diesel 797 Diesel		S 3241 R S 3241 R	S 7111 NC		
JX21T or DELPHI / oppure DELPHI or PURFLUX / oppure PURFLUX	797 Diesel 797 Diesel		S 3241 R S 3241 R	S 7111 NC		
K Serie						
K 380 with activated carbons / ai carboni attivi by-pass with air-conditioner prefilter / con climatizzatore prefiltra with filter Urea/Adblue SCR Denoxtronic 2.2 / con filtro Urea/Adblue SCR Denoxtronic 2.2 dryer filter KNORR EAC2 / filtro essiccatore KNORR EAC2 2 filters / N.2 filtri prefilter / prefiltra prefilter RACOR / prefiltra RACOR power steering / servosterzo power steering ZF RAS-EC / servosterzo ZF RAS-EC	DTI 11 Euro6 DTI 11 Euro6 DTI 11 Euro6 DTI 11 Euro6 DTI 11 Euro6 DTI 11 Euro6 DTI 11 Euro6 DTI 11 Euro6 DTI 11 Euro6 DTI 11 Euro6 DTI 11 Euro6 DTI 11 Euro6	279 380 279 380 279 380 279 380 279 380 279 380 279 380 279 380 279 380 279 380 279 380 279 380	01/13 > 01/13 > 01/13 > 01/13 > 01/13 > 01/13 > 01/13 > 01/13 > 01/13 > 01/13 > 01/13 > 01/13 >	S 4120 R S 4402 R	S 4477 NR S 4477 NR	S 3454 C S 4350 CA S 3455 C S 4405 U S 7F23 A S 3081 PO S 5664 PO
K 430 with activated carbons / ai carboni attivi by-pass with air-conditioner prefilter / con climatizzatore prefiltra with filter Urea/Adblue SCR Denoxtronic 2.2 / con filtro Urea/Adblue SCR Denoxtronic 2.2 dryer filter KNORR EAC2 / filtro essiccatore KNORR EAC2 2 filters / N.2 filtri prefilter / prefiltra prefilter / prefiltra power steering / servosterzo power steering ZF RAS-EC / servosterzo ZF RAS-EC	DTI 11 Euro6 DTI 11 Euro6 DTI 11 Euro6 DTI 11 Euro6 DTI 11 Euro6 DTI 11 Euro6 DTI 11 Euro6 DTI 11 Euro6 DTI 11 Euro6 DTI 11 Euro6	316 430 316 430 316 430 316 430 316 430 316 430 316 430 316 430 316 430 316 430	01/13 > 01/13 > 01/13 > 01/13 > 01/13 > 01/13 > 01/13 > 01/13 > 01/13 > 01/13 >	S 4120 R S 4402 R	S 4477 NR S 4477 NR	S 3454 C S 4350 CA S 3455 C S 4405 U S 7F23 A S 3081 PO S 5664 PO
K 440 with activated carbons / ai carboni attivi by-pass with air-conditioner prefilter / con climatizzatore prefiltra with filter Urea/Adblue SCR Denoxtronic 2.2 / con filtro Urea/Adblue SCR Denoxtronic 2.2 dryer filter KNORR EAC2 / filtro essiccatore KNORR EAC2 2 filters / N.2 filtri prefilter / prefiltra prefilter RACOR / prefiltra RACOR power steering / servosterzo power steering ZF RAS-EC / servosterzo ZF RAS-EC	DTI 13 Euro6 DTI 13 Euro6 DTI 13 Euro6 DTI 13 Euro6 DTI 13 Euro6 DTI 13 Euro6 DTI 13 Euro6 DTI 13 Euro6 DTI 13 Euro6 DTI 13 Euro6	324 440 324 440 324 440 324 440 324 440 324 440 324 440 324 440 324 440 324 440	01/13 > 01/13 > 01/13 > 01/13 > 01/13 > 01/13 > 01/13 > 01/13 > 01/13 > 01/13 >	S 4120 R S 4402 R	S 4477 NR S 4477 NR	S 3454 C S 4350 CA S 3455 C S 4405 U S 7F23 A S 3081 PO S 5664 PO
K 460 with activated carbons / ai carboni attivi by-pass	DTI 11 Euro6 DTI 11 Euro6 DTI 11 Euro6	338 460 338 460 338 460	01/13 > 01/13 > 01/13 >	S 4120 R		S 3454 C S 4350 CA

R





kW HP



...RENAULT TRUCKS - trucks/autocarri

R



with air-conditioner prefilter / con climatizzatore prefiltro	DTI 11 Euro6	338	460	01/13	>				S 3455 C
with filter Urea/Adblue SCR Denoxtronic 2.2 / con filtro Urea/Adblue SCR Denoxtronic 2.2	DTI 11 Euro6	338	460	01/13	>				S 4405 U
dryer filter KNORR EAC2 / filtro essiccatore KNORR EAC2	DTI 11 Euro6	338	460	01/13	>				S 7F23 A
2 filters / N.2 filtri	DTI 11 Euro6	338	460	01/13	>		S 4402 R		
prefilter / prefiltro	DTI 11 Euro6	338	460	01/13	>			S 4477 NR	
prefilter / prefiltro	DTI 11 Euro6	338	460	01/13	>			S 4477 NR	
power steering / servosterzo	DTI 11 Euro6	338	460	01/13	>				S 3081 PO
power steering ZF RAS-EC / servosterzo ZF RAS-EC	DTI 11 Euro6	338	460	01/13	>				S 5664 PO
K 480	DTI 13 Euro6	353	480	01/13	>				S 3454 C
with activated carbons / ai carboni attivi	DTI 13 Euro6	353	480	01/13	>				S 4350 CA
by-pass	DTI 13 Euro6	353	480	01/13	>		S 4120 R		
with air-conditioner prefilter / con climatizzatore prefiltro	DTI 13 Euro6	353	480	01/13	>				S 3455 C
with filter Urea/Adblue SCR Denoxtronic 2.2 / con filtro Urea/Adblue SCR Denoxtronic 2.2	DTI 13 Euro6	353	480	01/13	>				S 4405 U
dryer filter KNORR EAC2 / filtro essiccatore KNORR EAC2	DTI 13 Euro6	353	480	01/13	>				S 7F23 A
2 filters / N.2 filtri	DTI 13 Euro6	353	480	01/13	>		S 4402 R		
prefilter / prefiltro	DTI 13 Euro6	353	480	01/13	>			S 4477 NR	
prefilter / prefiltro	DTI 13 Euro6	353	480	01/13	>			S 4477 NR	
power steering / servosterzo	DTI 13 Euro6	353	480	01/13	>				S 3081 PO
power steering ZF RAS-EC / servosterzo ZF RAS-EC	DTI 13 Euro6	353	480	01/13	>				S 5664 PO
K 520	DTI 13 Euro6	382	520	01/13	>				S 3454 C
with activated carbons / ai carboni attivi	DTI 13 Euro6	382	520	01/13	>				S 4350 CA
by-pass	DTI 13 Euro6	382	520	01/13	>		S 4120 R		
with air-conditioner prefilter / con climatizzatore prefiltro	DTI 13 Euro6	382	520	01/13	>				S 3455 C
with filter Urea/Adblue SCR Denoxtronic 2.2 / con filtro Urea/Adblue SCR Denoxtronic 2.2	DTI 13 Euro6	382	520	01/13	>				S 4405 U
dryer filter KNORR EAC2 / filtro essiccatore KNORR EAC2	DTI 13 Euro6	382	520	01/13	>				S 7F23 A
2 filters / N.2 filtri	DTI 13 Euro6	382	520	01/13	>		S 4402 R		
prefilter / prefiltro	DTI 13 Euro6	382	520	01/13	>			S 4477 NR	
power steering / servosterzo	DTI 13 Euro6	382	520	01/13	>				S 3081 PO
power steering ZF RAS-EC / servosterzo ZF RAS-EC	DTI 13 Euro6	382	520	01/13	>				S 5664 PO
Kerax									
260	MIDR06.20.45	191	260	09/97	>	12/01			S 7284 A
with automatic gearbox / con cambio automatico	MIDR06.20.45	191	260	09/97	>	12/01			S 3217 C
dryer filter / filtro essiccatore	MIDR06.20.45	191	260	09/97	>	12/01			S 5238 PE
dryer filter WABCO, right-hand thread / filtro essiccatore WABCO, filetto destro	MIDR06.20.45	191	260	09/97	>	12/01			S 7259 A
inner / interno	MIDR06.20.45	191	260	09/97	>	12/01			S 7A66 A
LONG LIFE N.2 FILTERS / LONG LIFE N.2 FILTRI	MIDR06.20.45	191	260	09/97	>	12/01			
2 filters / N.2 filtri	MIDR06.20.45	191	260	09/97	>	12/01	S 0900 R	S 4471 NR	
rotor for oil centrifuge / rotore per filtro olio centrifugo	MIDR06.20.45	191	260	09/97	>	12/01		S 4323 NR	S 5900 PO
power steering / servosterzo	MIDR06.20.45	191	260	09/97	>	12/01			S 3081 PO
270 DCI	dCi11-270	195	265	11/01	>	04/06			S 7284 A
	dCi11-270	195	265	05/06	>				S 7284 A
with automatic gearbox / con cambio automatico	dCi11-270	195	265	11/01	>	12/04			S 5238 PE
dryer filter / filtro essiccatore	dCi11-270	195	265	11/01	>				S 7259 A
inner / interno	dCi11-270	195	265	11/01	>				S 7404 A
2 filters / N.2 filtri	dCi11-270	195	265	11/01	>		S 0900 R	S 0712 NR	
prefilter SEPAR 2000, heated / prefiltro SEPAR 2000 riscaldato	dCi11-270	195	265	11/01	>				S 6059 NE
rotor for oil centrifuge / rotore per filtro olio centrifugo	dCi11-270	195	265	11/01	>				S 5903 PO
power steering / servosterzo	dCi11-270	195	265	11/01	>				S 3081 PO
300	MIDR06.20.45	219	299	09/97	>	12/01			S 7284 A
with automatic gearbox / con cambio automatico	MIDR06.20.45	219	299	09/97	>	12/01			S 3217 C
dryer filter / filtro essiccatore	MIDR06.20.45	219	299	09/97	>	12/01			S 5238 PE
dryer filter WABCO, right-hand thread / filtro essiccatore WABCO, filetto destro	MIDR06.20.45	219	299	09/97	>	12/01			S 7259 A
inner / interno	MIDR06.20.45	219	299	09/97	>	12/01			S 7A66 A
LONG LIFE N.2 FILTERS / LONG LIFE N.2 FILTRI	MIDR06.20.45	219	299	09/97	>	12/01			
2 filters / N.2 filtri	MIDR06.20.45	219	299	09/97	>	12/01	S 0900 R	S 4471 NR	
rotor for oil centrifuge / rotore per filtro olio centrifugo	MIDR06.20.45	219	299	09/97	>	12/01		S 4323 NR	S 5900 PO
power steering / servosterzo	MIDR06.20.45	219	299	09/97	>	12/01			S 3081 PO
320 DCI	dCi11-320	229	311	11/01	>	04/06			S 7284 A
	dCi11-320	229	311	05/06	>				S 7284 A
with automatic gearbox / con cambio automatico	dCi11-320	229	311	11/01	>	12/14			S 5238 PE
dryer filter / filtro essiccatore	dCi11-320	229	311	11/01	>				S 7259 A
dryer filter WABCO, right-hand thread / filtro essiccatore WABCO, filetto destro	dCi11-320	229	311	11/01	>				S 7A66 A
inner / interno	dCi11-320	229	311	11/01	>				S 7404 A
2 filters / N.2 filtri	dCi11-320	229	311	11/01	>		S 0900 R	S 0712 NR	
prefilter SEPAR 2000, heated / prefiltro SEPAR 2000 riscaldato	dCi11-320	229	311	11/01	>				S 6059 NE
rotor for oil centrifuge / rotore per filtro olio centrifugo	dCi11-320	229	311	11/01	>				S 5903 PO
power steering / servosterzo	dCi11-320	229	311	11/01	>				S 3081 PO



...RENAULT TRUCKS - trucks/autocarri

340	MIDR06.20.45	249	340	09/97	>	12/01			S 7284 A	S 3217 C
with automatic gearbox / con cambio automatico	MIDR06.20.45	249	340	09/97	>	12/01				S 5238 PE
dryer filter / filtro essiccatore	MIDR06.20.45	249	340	09/97	>	12/01				S 7259 A
dryer filter WABCO, right-hand thread / filtro essiccatore WABCO, filetto destro	MIDR06.20.45	249	340	09/97	>	12/01				S 7A66 A
inner / interno	MIDR06.20.45	249	340	09/97	>	12/01			S 7404 A	
LONG LIFE N.2 FILTERS / LONG LIFE N.2 FILTRI	MIDR06.20.45	249	340	09/97	>	12/01		S 4471 NR		
2 filters / N.2 filtri	MIDR06.20.45	249	340	09/97	>	12/01	S 0900 R	S 4323 NR		
power steering / servosterzo	MIDR06.20.45	249	340	09/97	>	12/01				S 3081 PO
350 6x4	MIDR06.23.56	255	347	01/03	>	04/06			S 7284 A	S 3217 C
	MIDR06.23.56	255	347	05/06	>				S 7284 A	
with automatic gearbox / con cambio automatico	MIDR06.23.56	255	347	09/99	>	12/14				S 5238 PE
dryer filter / filtro essiccatore	MIDR06.23.56	255	347	01/03	>					S 7259 A
dryer filter WABCO, right-hand thread / filtro essiccatore WABCO, filetto destro	MIDR06.23.56	255	347	01/03	>					S 7A66 A
inner / interno	MIDR06.23.56	255	347	01/03	>				S 7404 A	
LONG LIFE N.2 FILTERS / LONG LIFE N.2 FILTRI	MIDR06.23.56	255	347	01/03	>			S 4471 NR		
2 filters / N.2 filtri	MIDR06.23.56	255	347	01/03	>		S 0900 R	S 4323 NR		
rotor for oil centrifuge / rotore per filtro olio centrifugo	MIDR06.23.56	255	347	01/03	>					S 5900 PO
power steering / servosterzo	MIDR06.23.56	255	347	01/03	>					S 3081 PO
370 DCI	dCi11-370	266	361	11/01	>	04/06			S 7284 A	S 3217 C
	dCi11-370	266	361	05/06	>				S 7284 A	
with automatic gearbox / con cambio automatico	dCi11-370	266	361	11/01	>	12/14				S 5238 PE
dryer filter / filtro essiccatore	dCi11-370	266	361	11/01	>					S 7259 A
dryer filter WABCO, right-hand thread / filtro essiccatore WABCO, filetto destro	dCi11-370	266	361	11/01	>					S 7A66 A
inner / interno	dCi11-370	266	361	11/01	>				S 7404 A	
2 filters / N.2 filtri	dCi11-370	266	361	11/01	>		S 0900 R	S 0712 NR		
prefilter SEPAR 2000, heated / prefiltra SEPAR 2000 riscaldato	dCi11-370	266	361	11/01	>					S 6059 NE
rotor for oil centrifuge / rotore per filtro olio centrifugo	dCi11-370	266	361	11/01	>					S 5903 PO
power steering / servosterzo	dCi11-370	266	361	11/01	>					S 3081 PO
370 DXi	DXi 11 Euro4/5	272	370	05/06	>			S 9320 NR	S 7645 A	
by-pass	DXi 11 Euro4/5	272	370	05/06	>		S 4120 R			
with automatic gearbox / con cambio automatico	DXi 11 Euro4/5	272	370	05/06	>	12/14				S 5238 PE
filter PARKER-RACOR / filtro PARKER-RACOR	DXi 11 Euro4/5	272	370	05/06	>	12/14		S 4476 NR		
inner / interno	DXi 11 Euro4/5	272	370	05/06	>				S 7404 A	
2 filters / N.2 filtri	DXi 11 Euro4/5	272	370	05/06	>		S 4402 R			
power steering / servosterzo	DXi 11 Euro4/5	272	370	05/06	>					S 3081 PO
380 DXi	DXi 11 Euro5	280	380	06/09	>	12/14		S 9320 NR	S 7645 A	
by-pass	DXi 11 Euro5	280	380	06/09	>	12/14	S 4120 R			
with automatic gearbox / con cambio automatico	DXi 11 Euro5	280	380	06/09	>	12/14				S 5238 PE
with filter Urea/Adblue / con filtro Urea/Adblue	DXi 11 Euro5	280	380	06/09	>	12/14				S 4402 U
dryer filter WABCO, right-hand thread / filtro essiccatore WABCO, filetto destro	DXi 11 Euro5	280	380	06/09	>	12/14				S 7A66 A
inner / interno	DXi 11 Euro5	280	380	06/09	>	12/14			S 7404 A	
LONG LIFE	DXi 11 Euro5	280	380	06/09	>	12/14		S 4120 NR		
2 filters / N.2 filtri	DXi 11 Euro5	280	380	06/09	>	12/14	S 4402 R			
prefilter short filter / prefiltra filtro corto	DXi 11 Euro5	280	380	06/09	>	12/14		S 4157 NR		
prefilter long filter / prefiltra filtro lungo	DXi 11 Euro5	280	380	06/09	>	12/14		S 4146 NR		
power steering / servosterzo	DXi 11 Euro5	280	380	06/09	>	12/14				S 3081 PO
385	MIDR06.23.56	280	382	09/97	>	12/01			S 7284 A	S 3217 C
with automatic gearbox / con cambio automatico	MIDR06.23.56	280	382	09/98	>	12/01				S 5238 PE
dryer filter / filtro essiccatore	MIDR06.23.56	280	382	09/97	>	12/01				S 7259 A
dryer filter WABCO, right-hand thread / filtro essiccatore WABCO, filetto destro	MIDR06.23.56	280	382	09/97	>	12/01				S 7A66 A
inner / interno	MIDR06.23.56	280	382	09/97	>	12/01			S 7404 A	
LONG LIFE N.2 FILTERS / LONG LIFE N.2 FILTRI	MIDR06.23.56	280	382	09/97	>	12/01		S 4471 NR		
2 filters / N.2 filtri	MIDR06.23.56	280	382	09/97	>	12/01	S 0900 R	S 4323 NR		
rotor for oil centrifuge / rotore per filtro olio centrifugo	MIDR06.23.56	280	382	09/97	>	12/01				S 5900 PO
power steering / servosterzo	MIDR06.23.56	280	382	09/97	>	12/01				S 3081 PO
400	MIDR06.23.56	288	393	09/98	>	12/01			S 7284 A	S 3217 C
dryer filter / filtro essiccatore	MIDR06.23.56	288	393	09/98	>	12/01				S 7259 A
dryer filter WABCO, right-hand thread / filtro essiccatore WABCO, filetto destro	MIDR06.23.56	288	393	09/98	>	12/01				S 7A66 A
inner / interno	MIDR06.23.56	288	393	09/98	>	12/01			S 7404 A	
LONG LIFE N.2 FILTERS / LONG LIFE N.2 FILTRI	MIDR06.23.56	288	393	09/98	>	12/01		S 4471 NR		
2 filters / N.2 filtri	MIDR06.23.56	288	393	09/98	>	12/01	S 0900 R	S 4323 NR		
rotor for oil centrifuge / rotore per filtro olio centrifugo	MIDR06.23.56	288	393	09/98	>	12/01				S 5900 PO
power steering / servosterzo	MIDR06.23.56	288	393	09/98	>	12/01				S 3081 PO
410 DXi	DXi 11 Euro4/5	302	410	05/06	>			S 9320 NR	S 7645 A	
by-pass	DXi 11 Euro4/5	302	410	05/06	>		S 4120 R			
with automatic gearbox / con cambio automatico	DXi 11 Euro4/5	302	410	05/06	>	12/14				S 5238 PE
filter PARKER-RACOR / filtro PARKER-RACOR	DXi 11 Euro4/5	302	410	05/06	>	12/14		S 4479 NR		

R



...RENAULT TRUCKS - trucks/autocarri

R



inner / interno	DXi 11 Euro4/5	302	410	05/06	>			S 7404 A	
2 filters / N.2 filtri	DXi 11 Euro4/5	302	410	05/06	>		S 4402 R		
power steering / servosterzo	DXi 11 Euro4/5	302	410	05/06	>				S 3081 PO
420 DCI	dCi11-420	303	412	11/01	>	04/06		S 7284 A	S 3217 C
	dCi11-420	303	412	05/06	>			S 7284 A	
with automatic gearbox / con cambio automatico	dCi11-420	303	412	11/01	>	12/14			S 5238 PE
dryer filter / filtro essiccatore	dCi11-420	303	412	11/01	>				S 7259 A
dryer filter WABCO, right-hand thread / filtro essiccatore WABCO, filetto destro	dCi11-420	303	412	11/01	>				S 7A66 A
inner / interno	dCi11-420	303	412	11/01	>			S 7404 A	
2 filters / N.2 filtri	dCi11-420	303	412	11/01	>		S 0900 R	S 0712 NR	
prefilter SEPAR 2000, heated / prefiltra SEPAR 2000 riscaldato	dCi11-420	303	412	11/01	>				S 6059 NE
rotor for oil centrifuge / rotore per filtro olio centrifugo	dCi11-420	303	412	11/01	>				S 5903 PO
power steering / servosterzo	dCi11-420	303	412	11/01	>				S 3081 PO
430 DXi	DXi 11 Euro5	316	430	06/09	>	12/14		S 9320 NR	S 7645 A
by-pass	DXi 11 Euro5	316	430	06/09	>	12/14	S 4120 R		
with automatic gearbox / con cambio automatico	DXi 11 Euro5	316	430	06/09	>	12/14			S 5238 PE
with filter Urea/Adblue / con filtro Urea/Adblue	DXi 11 Euro5	316	430	06/09	>	12/14			S 4402 U
dryer filter WABCO, right-hand thread / filtro essiccatore WABCO, filetto destro	DXi 11 Euro5	316	430	06/09	>	12/14			S 7A66 A
inner / interno	DXi 11 Euro5	316	430	06/09	>	12/14		S 7404 A	
LONG LIFE	DXi 11 Euro5	316	430	06/09	>	12/14		S 4120 NR	
2 filters / N.2 filtri	DXi 11 Euro5	316	430	06/09	>	12/14	S 4402 R		
prefilter short filter / prefiltra filtro corto	DXi 11 Euro5	316	430	06/09	>	12/14		S 4157 NR	
prefilter long filter / prefiltra filtro lungo	DXi 11 Euro5	316	430	06/09	>	12/14		S 4146 NR	
power steering / servosterzo	DXi 11 Euro5	316	430	06/09	>	12/14			S 3081 PO
440 DXi	DXi 11 Euro4/5	324	440	05/06	>			S 9320 NR	S 7645 A
by-pass	DXi 11 Euro4/5	324	440	05/06	>		S 4120 R		
with filter Urea/Adblue / con filtro Urea/Adblue	DXi 11 Euro4/5	324	440	05/06	>				S 4402 U
dryer filter WABCO, right-hand thread / filtro essiccatore WABCO, filetto destro	DXi 11 Euro4/5	324	440	05/06	>				S 7A66 A
filter PARKER-RACOR / filtro PARKER-RACOR	DXi 11 Euro4/5	324	440	05/06	>	12/14		S 4479 NR	
inner / interno	DXi 11 Euro4/5	324	440	05/06	>			S 7404 A	
LONG LIFE	DXi 11 Euro4/5	324	440	05/06	>			S 4120 NR	
2 filters / N.2 filtri	DXi 11 Euro4/5	324	440	05/06	>		S 4402 R		
power steering / servosterzo	DXi 11 Euro4/5	324	440	05/06	>				S 3081 PO
450 DXi	DXi 11 Euro4/5	331	450	05/06	>			S 9320 NR	S 7645 A
by-pass	DXi 11 Euro4/5	331	450	05/06	>		S 4120 R		
with automatic gearbox / con cambio automatico	DXi 11 Euro4/5	331	450	05/06	>	12/14			S 5238 PE
filter PARKER-RACOR / filtro PARKER-RACOR	DXi 11 Euro4/5	331	450	05/06	>	12/14		S 4479 NR	
inner / interno	DXi 11 Euro4/5	331	450	05/06	>			S 7404 A	
2 filters / N.2 filtri	DXi 11 Euro4/5	331	450	05/06	>		S 4402 R		
power steering / servosterzo	DXi 11 Euro4/5	331	450	05/06	>				S 3081 PO
460 DXi	DXi 13 Euro4/5	339	460	02/08	>	05/09		S 9320 NR	S 7645 A
by-pass	DXi 13 Euro4/5	339	460	02/08	>	05/09	S 4120 R		
with automatic gearbox / con cambio automatico	DXi 13 Euro4/5	339	460	02/08	>	05/09			S 5238 PE
inner / interno	DXi 13 Euro4/5	339	460	02/08	>	05/09		S 7404 A	
2 filters / N.2 filtri	DXi 13 Euro4/5	339	460	02/08	>	05/09	S 4402 R		
prefilter short filter / prefiltra filtro corto	DXi 13 Euro4/5	339	460	02/08	>	05/09		S 4157 NR	
prefilter long filter / prefiltra filtro lungo	DXi 13 Euro4/5	339	460	02/08	>	05/09		S 4146 NR	
power steering / servosterzo	DXi 13 Euro4/5	339	460	02/08	>	05/09			S 3081 PO
460 DXi	DXi 13 Euro5	338	460	06/09	>	12/14		S 9320 NR	S 7645 A
by-pass	DXi 13 Euro5	338	460	06/09	>	12/14	S 4120 R		
with automatic gearbox / con cambio automatico	DXi 13 Euro5	338	460	06/09	>	12/14			S 5238 PE
with filter Urea/Adblue / con filtro Urea/Adblue	DXi 13 Euro5	338	460	06/09	>	12/14			S 4402 U
dryer filter WABCO, right-hand thread / filtro essiccatore WABCO, filetto destro	DXi 13 Euro5	338	460	06/09	>	12/14			S 7A66 A
inner / interno	DXi 13 Euro5	338	460	06/09	>	12/14		S 7404 A	
LONG LIFE	DXi 13 Euro5	338	460	06/09	>	12/14		S 4120 NR	
2 filters / N.2 filtri	DXi 13 Euro5	338	460	06/09	>	12/14	S 4402 R		
prefilter short filter / prefiltra filtro corto	DXi 13 Euro5	338	460	06/09	>	12/14		S 4157 NR	
prefilter long filter / prefiltra filtro lungo	DXi 13 Euro5	338	460	06/09	>	12/14		S 4146 NR	
power steering / servosterzo	DXi 13 Euro5	338	460	06/09	>	12/14			S 3081 PO
480 DXi	DXi 13 Euro4/5	353	480	02/08	>	12/14		S 9320 NR	S 7645 A
by-pass	DXi 13 Euro4/5	353	480	02/08	>	12/14	S 4120 R		
with automatic gearbox / con cambio automatico	DXi 13 Euro4/5	353	480	02/08	>	12/14			S 5238 PE
with filter Urea/Adblue / con filtro Urea/Adblue	DXi 13 Euro4/5	353	480	02/08	>	12/14			S 4402 U
dryer filter WABCO, right-hand thread / filtro essiccatore WABCO, filetto destro	DXi 13 Euro4/5	353	480	02/08	>	12/14			S 7A66 A
inner / interno	DXi 13 Euro4/5	353	480	02/08	>	12/14		S 7404 A	
LONG LIFE	DXi 13 Euro4/5	353	480	02/08	>	12/14		S 4120 NR	
2 filters / N.2 filtri	DXi 13 Euro4/5	353	480	02/08	>	12/14	S 4402 R		

**KW HP****...RENAULT TRUCKS - trucks/autocarri**

prefilter short filter / prefiltro filtro corto	DXi 13 Euro4/5	353	480	02/08 >	12/14		S 4157 NR		
prefilter long filter / prefiltro filtro lungo	DXi 13 Euro4/5	353	480	02/08 >	12/14		S 4146 NR		
power steering / servosterzo	DXi 13 Euro4/5	353	480	02/08 >	12/14				S 3081 PO
500 DXi	DXi 13 Euro4/5	368	500	02/08 >	12/14		S 9320 NR	S 7645 A	
by-pass	DXi 13 Euro4/5	368	500	02/08 >	12/14	S 4120 R			
with automatic gearbox / con cambio automatico	DXi 13 Euro4/5	368	500	02/08 >	12/14				S 5238 PE
inner / interno	DXi 13 Euro4/5	368	500	02/08 >	12/14			S 7404 A	
2 filters / N.2 filtri	DXi 13 Euro4/5	368	500	02/08 >	12/14	S 4402 R			
prefilter short filter / prefiltro filtro corto	DXi 13 Euro4/5	368	500	02/08 >	12/14		S 4157 NR		
prefilter long filter / prefiltro filtro lungo	DXi 13 Euro4/5	368	500	02/08 >	12/14		S 4146 NR		
power steering / servosterzo	DXi 13 Euro4/5	368	500	02/08 >	12/14				S 3081 PO
520 DXi	DXi 13 Euro4/5	382	520	02/08 >	12/14		S 9320 NR	S 7645 A	
by-pass	DXi 13 Euro4/5	382	520	02/08 >	12/14	S 4120 R			
with automatic gearbox / con cambio automatico	DXi 13 Euro4/5	382	520	02/08 >	12/14				S 5238 PE
with filter Urea/Adblue / con filtro Urea/Adblue	DXi 13 Euro4/5	382	520	02/08 >	12/14				S 4402 U
dryer filter WABCO, right-hand thread / filtro essiccatore WABCO, filetto destro	DXi 13 Euro4/5	382	520	02/08 >	12/14				S 7A66 A
inner / interno	DXi 13 Euro4/5	382	520	02/08 >	12/14			S 7404 A	
LONG LIFE	DXi 13 Euro4/5	382	520	02/08 >	12/14		S 4120 NR		
2 filters / N.2 filtri	DXi 13 Euro4/5	382	520	02/08 >	12/14	S 4402 R			
prefilter short filter / prefiltro filtro corto	DXi 13 Euro4/5	382	520	02/08 >	12/14		S 4157 NR		
prefilter long filter / prefiltro filtro lungo	DXi 13 Euro4/5	382	520	02/08 >	12/14		S 4146 NR		
power steering / servosterzo	DXi 13 Euro4/5	382	520	02/08 >	12/14				S 3081 PO
Magnum									
AE440 DXi	DXi 12	324	440	03/05 >	03/09		S 9320 NR	S 7643 A	
by-pass	DXi 12	324	440	03/05 >	03/09	S 4120 R			
with automatic gearbox / con cambio automatico	DXi 12	324	440	03/05 >	04/09				S 5238 PE
with gearbox ZF Ecosplit + Intarder / con cambio ZF Ecosplit + Intarder	DXi 12	324	440	03/05 >	03/09				S 2234 Z
inner / interno	DXi 12	324	440	03/05 >	03/09			S 7406 A	
LONG LIFE	DXi 12	324	440	03/05 >	03/09		S 4120 NR		
2 filters / N.2 filtri	DXi 12	324	440	03/05 >	03/09	S 4402 R			
prefilter / prefiltro	DXi 12	324	440	03/05 >	03/09		S 4461 NR		
power steering / servosterzo	DXi 12	324	440	03/05 >	03/09				S 3081 PO
AE440 DXi	DXi 13 Euro4/5	323	439	03/09 >	12/14		S 9320 NR	S 7643 A	
by-pass	DXi 13 Euro4/5	323	439	03/09 >	12/14	S 4120 R			
with automatic gearbox / con cambio automatico	DXi 13 Euro4/5	323	439	03/09 >	12/14				S 5238 PE
with gearbox ZF Ecosplit + Intarder / con cambio ZF Ecosplit + Intarder	DXi 13 Euro4/5	323	439	03/09 >	12/14				S 2234 Z
with filter Urea/Adblue / con filtro Urea/Adblue	DXi 13 Euro4/5	323	439	03/09 >	12/14				S 4402 U
inner / interno	DXi 13 Euro4/5	323	439	03/09 >	12/14			S 7406 A	
LONG LIFE	DXi 13 Euro4/5	323	439	03/09 >	12/14		S 4120 NR		
2 filters / N.2 filtri	DXi 13 Euro4/5	323	439	03/09 >	12/14	S 4402 R			
prefilter short filter / prefiltro filtro corto	DXi 13 Euro4/5	323	439	03/09 >	12/14		S 4157 NR		
prefilter long filter / prefiltro filtro lungo	DXi 13 Euro4/5	323	439	03/09 >	12/14		S 4146 NR		
power steering / servosterzo	DXi 13 Euro4/5	323	439	03/09 >	12/14				S 3081 PO
AE460 DXi	DXi 13 Euro4/5	338	460	03/06 >	03/09		S 9320 NR	S 7643 A	
by-pass	DXi 13 Euro4/5	338	460	03/06 >	03/09	S 4120 R			
with automatic gearbox / con cambio automatico	DXi 13 Euro4/5	338	460	06/06 >	04/09				S 5238 PE
with gearbox ZF Ecosplit + Intarder / con cambio ZF Ecosplit + Intarder	DXi 13 Euro4/5	338	460	03/06 >	03/09				S 2234 Z
inner / interno	DXi 13 Euro4/5	338	460	03/06 >	03/09			S 7406 A	
2 filters / N.2 filtri	DXi 13 Euro4/5	338	460	03/06 >	03/09	S 4402 R			
prefilter short filter / prefiltro filtro corto	DXi 13 Euro4/5	338	460	03/06 >	03/09		S 4157 NR		
prefilter long filter / prefiltro filtro lungo	DXi 13 Euro4/5	338	460	03/06 >	03/09		S 4146 NR		
power steering / servosterzo	DXi 13 Euro4/5	338	460	03/06 >	03/09				S 3081 PO
AE480 DXi	DXi 12	353	480	03/05 >	03/09		S 9320 NR	S 7643 A	
by-pass	DXi 12	353	480	03/05 >	03/09	S 4120 R			
with automatic gearbox / con cambio automatico	DXi 12	353	480	03/05 >	04/09				S 5238 PE
with gearbox ZF Ecosplit + Intarder / con cambio ZF Ecosplit + Intarder	DXi 12	353	480	03/05 >	03/09				S 2234 Z
inner / interno	DXi 12	353	480	03/05 >	03/09			S 7406 A	
2 filters / N.2 filtri	DXi 12	353	480	03/05 >	03/09	S 4402 R			
prefilter / prefiltro	DXi 12	353	480	03/05 >	03/09		S 4461 NR		
power steering / servosterzo	DXi 12	353	480	03/05 >	03/09				S 3081 PO
AE480 DXi	DXi 13 Euro 4/5	353	480	03/09 >	12/14		S 9320 NR	S 7643 A	
by-pass	DXi 13 Euro 4/5	353	480	03/09 >	12/14	S 4120 R			
with automatic gearbox / con cambio automatico	DXi 13 Euro 4/5	353	480	03/09 >	12/14				S 5238 PE
with gearbox ZF Ecosplit + Intarder / con cambio ZF Ecosplit + Intarder	DXi 13 Euro 4/5	353	480	03/09 >	12/14				S 2234 Z
inner / interno	DXi 13 Euro 4/5	353	480	03/09 >	12/14			S 7406 A	
2 filters / N.2 filtri	DXi 13 Euro 4/5	353	480	03/09 >	12/14	S 4402 R			
prefilter short filter / prefiltro filtro corto	DXi 13 Euro 4/5	353	480	03/09 >	12/14		S 4157 NR		

R



...RENAULT TRUCKS - trucks/autocarri

R

prefilter long filter / prefiltra filtro lungo	DXi 13 Euro 4/5	353	480	03/09	>	12/14		S 4146 NR		S 3081 PO
power steering / servosterzo	DXi 13 Euro 4/5	353	480	03/09	>	12/14				
AE500 DXi	DXi 13 Euro4/5	368	500	03/06	>	06/09		S 9320 NR	S 7643 A	
by-pass	DXi 13 Euro4/5	368	500	03/06	>	06/09	S 4120 R			
with automatic gearbox / con cambio automatico	DXi 13 Euro4/5	368	500	03/06	>	06/09				S 5238 PE
with gearbox ZF Ecosplit + Intarder / con cambio ZF Ecosplit + Intarder	DXi 13 Euro4/5	368	500	03/06	>	06/09				S 2234 Z
inner / interno	DXi 13 Euro4/5	368	500	03/06	>	06/09			S 7406 A	
2 filters / N.2 filtri	DXi 13 Euro4/5	368	500	03/06	>	06/09	S 4402 R			
prefilter short filter / prefiltra filtro corto	DXi 13 Euro4/5	368	500	03/06	>	06/09		S 4157 NR		
prefilter long filter / prefiltra filtro lungo	DXi 13 Euro4/5	368	500	03/06	>	06/09		S 4146 NR		
power steering / servosterzo	DXi 13 Euro4/5	368	500	03/06	>	06/09				S 3081 PO
AE520 DXi	DXi 13 Euro4/5	382	520	03/09	>	12/14		S 9320 NR	S 7643 A	
by-pass	DXi 13 Euro4/5	382	520	03/09	>	12/14	S 4120 R			
with gearbox ZF Ecosplit + Intarder / con cambio ZF Ecosplit + Intarder	DXi 13 Euro4/5	382	520	03/09	>	12/14				S 2234 Z
inner / interno	DXi 13 Euro4/5	382	520	03/09	>	12/14			S 7406 A	
2 filters / N.2 filtri	DXi 13 Euro4/5	382	520	03/09	>	12/14	S 4402 R			
prefilter short filter / prefiltra filtro corto	DXi 13 Euro4/5	382	520	03/09	>	12/14		S 4157 NR		
prefilter long filter / prefiltra filtro lungo	DXi 13 Euro4/5	382	520	03/09	>	12/14		S 4146 NR		
power steering / servosterzo	DXi 13 Euro4/5	382	520	03/09	>	12/14				S 3081 PO
Major										
R 340 TI	MIDR06.20.45	249	339	05/91	>	10/96				✗
dryer filter / filtro essiccatore	MIDR06.20.45	249	339	05/91	>	10/96				S 7259 A
DONALDSON assembly ECG 15 / montaggio DONALDSON ECG 15	MIDR06.20.45	249	339	05/91	>	10/96			S 4770 A	
2 filters / N.2 filtri	MIDR06.20.45	249	339	05/91	>	10/96	S 0900 R	S 4323 NR		
rotor for oil centrifuge / rotore per filtro olio centrifugo	MIDR06.20.45	249	339	05/91	>	10/96	S 5900 PO			
power steering / servosterzo	MIDR06.20.45	249	339	05/91	>	10/96				S 3081 PO
R 350	MIDR06.35.40G	259	352	01/90	>	12/92				✗
dryer filter / filtro essiccatore	MIDR06.35.40G	259	352	01/90	>	12/92				S 7259 A
DONALDSON assembly EBG 140407 (outer) / montaggio DONALDSON EBG 140407 (esterno)	MIDR06.35.40G	259	352	01/90	>	12/92			S 7368 A	
DONALDSON assembly EBG 140407 (inner) / montaggio DONALDSON EBG 140407 (interno)	MIDR06.35.40G	259	352	01/90	>	12/92			S 2840 A	
DONALDSON assembly ECG 15 / montaggio DONALDSON ECG 15	MIDR06.35.40G	259	352	01/90	>	12/92			S 4770 A	
2 filters / N.2 filtri	MIDR06.35.40G	259	352	01/90	>	12/92	S 0900 R	S 4323 NR		
rotor for oil centrifuge / rotore per filtro olio centrifugo	MIDR06.35.40G	259	352	01/90	>	12/92	S 5900 PO			
power steering / servosterzo	MIDR06.35.40G	259	352	01/90	>	12/92				S 3081 PO
R 380	MIDR06.35.40H	275	374	01/90	>	12/92				✗
dryer filter / filtro essiccatore	MIDR06.35.40H	275	374	01/90	>	12/92				S 7259 A
DONALDSON assembly EBG 140407 (outer) / montaggio DONALDSON EBG 140407 (esterno)	MIDR06.35.40H	275	374	01/90	>	12/92			S 7368 A	
DONALDSON assembly EBG 140407 (inner) / montaggio DONALDSON EBG 140407 (interno)	MIDR06.35.40H	275	374	01/90	>	12/92			S 2840 A	
DONALDSON assembly ECG 15 / montaggio DONALDSON ECG 15	MIDR06.35.40H	275	374	01/90	>	12/92			S 4770 A	
2 filters / N.2 filtri	MIDR06.35.40H	275	374	01/90	>	12/92	S 0900 R	S 4323 NR		
rotor for oil centrifuge / rotore per filtro olio centrifugo	MIDR06.35.40H	275	374	01/90	>	12/92	S 5900 PO			
power steering / servosterzo	MIDR06.35.40H	275	374	01/90	>	12/92				S 3081 PO
R 385 TI	MIDR06.35.40	283	385	05/91	>	12/96				✗
dryer filter / filtro essiccatore	MIDR06.35.40	283	385	05/91	>	12/96				S 7259 A
DONALDSON assembly ECG 15 / montaggio DONALDSON ECG 15	MIDR06.35.40	283	385	05/91	>	12/96			S 4770 A	
2 filters / N.2 filtri	MIDR06.35.40	283	385	05/91	>	12/96	S 0900 R	S 4323 NR		
rotor for oil centrifuge / rotore per filtro olio centrifugo	MIDR06.35.40	283	385	05/91	>	12/96	S 5900 PO			
power steering / servosterzo	MIDR06.35.40	283	385	05/91	>	12/96				S 3081 PO
R 420 TI	MIDR06.35.40	305	415	04/92	>	10/96				✗
dryer filter / filtro essiccatore	MIDR06.35.40	305	415	04/92	>	10/96				S 7259 A
DONALDSON assembly ECG 15 / montaggio DONALDSON ECG 15	MIDR06.35.40	305	415	04/92	>	10/96			S 4770 A	
2 filters / N.2 filtri	MIDR06.35.40	305	415	04/92	>	10/96	S 0900 R	S 4323 NR		
rotor for oil centrifuge / rotore per filtro olio centrifugo	MIDR06.35.40	305	415	04/92	>	10/96	S 5900 PO			
power steering / servosterzo	MIDR06.35.40	305	415	04/92	>	10/96				S 3081 PO
Manager										
G200										
with pump BOSCH / con pompa BOSCH	MIDR06.02.26Q			06/91	>	03/93	S 0900 R	S 3010 N		
with pump BOSCH / con pompa BOSCH	MIDR06.02.26Q			06/91	>	03/93	S 0900 R	S 4323 NR		
with pump DELPHI / con pompa DELPHI	MIDR06.02.26Q			06/91	>	03/93	S 0900 R	S 7111 NC		
with pump SIGMA V80 / con pompa SIGMA V80	MIDR06.02.26Q			06/91	>	03/93	S 0900 R			
dryer filter / filtro essiccatore	MIDR06.02.26Q			06/91	>	03/93				S 7259 A
inner / interno	MIDR06.02.26Q			06/91	>	03/93			S 2840 A	
inner / interno	MIDR06.02.26Q			06/91	>	03/93			S 8940 A	
assembly DONALDSON / montaggio DONALDSON	MIDR06.02.26Q			06/91	>	03/93	S 0900 R		S 6550 A	
assembly DONALDSON / montaggio DONALDSON	MIDR06.02.26Q			06/91	>	03/93	S 0900 R		S 0150 A	
assembly MANN / montaggio MANN	MIDR06.02.26Q			06/91	>	03/93	S 0900 R		S 5270 A	
assembly MANN / montaggio MANN	MIDR06.02.26Q			06/91	>	03/93	S 0900 R		S 2650 A	



kW HP



...RENAULT TRUCKS - trucks/autocarri

assembly PERMATIC FO1719 / montaggio PERMATIC FO1719	MIDR06.02.26Q			06/91 > 03/93			S 7614 A	
G210								
with pump BOSCH / con pompa BOSCH	MIDR06.02.26W			05/92 > 10/96	S 0900 R	S 3010 N		
with pump BOSCH / con pompa BOSCH	MIDR06.02.26W			05/92 > 10/96	S 0900 R	S 4323 NR		
with pump DELPHI / con pompa DELPHI	MIDR06.02.26W			05/92 > 10/96	S 0900 R	S 7111 NC		
with pump SIGMA V80 / con pompa SIGMA V80	MIDR06.02.26W			05/92 > 10/96	S 0900 R			
dryer filter / filtro essiccatore	MIDR06.02.26W			05/92 > 10/96				S 7259 A
inner / interno	MIDR06.02.26W			05/92 > 10/96			S 2840 A	
inner / interno	MIDR06.02.26W			05/92 > 10/96			S 8940 A	
assembly DONALDSON / montaggio DONALDSON	MIDR06.02.26W			05/92 > 10/96	S 0900 R		S 0150 A	
assembly DONALDSON / montaggio DONALDSON	MIDR06.02.26W			05/92 > 10/96	S 0900 R		S 6550 A	
assembly MANN / montaggio MANN	MIDR06.02.26W			05/92 > 10/96	S 0900 R		S 2650 A	
assembly MANN / montaggio MANN	MIDR06.02.26W			05/92 > 10/96	S 0900 R		S 5270 A	
assembly PERMATIC FO1719 / montaggio PERMATIC FO1719	MIDR06.02.26W			05/92 > 10/96			S 7614 A	
G220 BOM	MIDS06.20.45J			03/91 > 10/96	S 0900 R	S 4323 NR		
G230 TI								
with pump BOSCH / con pompa BOSCH	MIDR06.02.26D/X			09/91 > 10/96	S 0900 R	S 4323 NR	S 2650 A	
with pump BOSCH / con pompa BOSCH	MIDR06.02.26D/X			09/91 > 10/96	S 0900 R	S 3010 N	S 2650 A	
with pump DELPHI / con pompa DELPHI	MIDR06.02.26D/X			09/91 > 10/96	S 0900 R	S 7111 NC	S 2650 A	
with pump SIGMA V80 / con pompa SIGMA V80	MIDR06.02.26D/X			09/91 > 10/96	S 0900 R		S 2650 A	
dryer filter / filtro essiccatore	MIDR06.02.26D/X			09/91 > 10/96				S 7259 A
inner / interno	MIDR06.02.26D/X			09/91 > 10/96			S 7129 A	
assembly PERMATIC FO1719 / montaggio PERMATIC FO1719	MIDR06.02.26D/X			09/91 > 10/96			S 7614 A	
G270	MIDR06.20.45			11/92 > 10/96	S 0900 R	S 4323 NR		
dryer filter / filtro essiccatore	MIDR06.20.45			11/92 > 10/96				S 7259 A
power steering / servosterzo	MIDR06.20.45			11/92 > 10/96				S 3081 PO
G280								
with pump BOSCH / con pompa BOSCH	MIDS06.20.45B			01/90 > 03/93	S 8600 R	S 4323 NR		
with pump BOSCH / con pompa BOSCH	MIDS06.20.45B			01/90 > 03/93	S 8600 R	S 3010 N		
with pump DELPHI / con pompa DELPHI	MIDS06.20.45B			01/90 > 03/93	S 8600 R	S 8111 NC		
with pump DELPHI / con pompa DELPHI	MIDS06.20.45B			01/90 > 03/93	S 8600 R	S 7111 NC		
with pump SIGMA FS300 / con pompa SIGMA FS300	MIDS06.20.45B			01/90 > 03/93	S 8600 R	S 0510 NR		
cartridge / immersione	MIDS06.20.45B			01/90 > 03/93	S 1910 PO			
inner / interno	MIDS06.20.45B			01/90 > 03/93			S 2840 A	
assembly DONALDSON / montaggio DONALDSON	MIDS06.20.45B			01/90 > 03/93	S 8600 R		S 4770 A	✗
assembly DONALDSON / montaggio DONALDSON	MIDS06.20.45B			01/90 > 03/93	S 8600 R		S 6550 A	✗
assembly DONALDSON / montaggio DONALDSON	MIDS06.20.45B			01/90 > 03/93	S 8600 R		S 7945 A	✗
assembly DONALDSON / montaggio DONALDSON	MIDS06.20.45B			01/90 > 03/93	S 8600 R		S 8840 A	✗
G300								
inner / interno	MIDR06.20.45			01/90 > 10/96			S 2850 A	
assembly DONALDSON / montaggio DONALDSON	MIDR06.20.45			01/90 > 10/96	S 0900 R	S 4323 NR	S 0850 A	
G330	MIDR06.20.45H			02/90 > 03/93	S 8600 R	S 4323 NR		
some / alcuni	MIDR06.20.45H			02/90 > 03/93	S 0900 R	S 4323 NR		
G340 TI	MIDR06.20.45			01/90 > 06/97	S 0900 R	S 4323 NR		
dryer filter / filtro essiccatore	MIDR06.20.45			01/90 > 06/97				S 7259 A
Mascott								
110 2.8 TDI	Sofim 8140.43C	78	106	05/99 > 05/04	S 3003 DR	S 4394 NR	S 3541 A	✗
assembly STANADYNE / montaggio STANADYNE	Sofim 8140.43C	78	106	05/99 > 07/04		S 4475 NR		
120 DXi 3.0	DXi 3-120	85	115	05/04 >	S 5026 PE	S 4408 NR	S 5812 A	✗
130 2.8 TDI Common-Rail	Sofim 8140.43	92	125	05/99 > 05/04	S 3003 DR	S 4394 NR	S 3541 A	✗
assembly STANADYNE / montaggio STANADYNE	Sofim 8140.43	92	125	05/99 > 07/04		S 4475 NR		
140 2.8 TDI	Sofim 8140.43K	103	140	02/00 > 07/04	S 3003 DR	S 4394 NR	S 3541 A	✗
power steering / servosterzo	Sofim 8140.43K	103	140	02/00 > 07/04				S 3081 PO
150 2.8 TDI	Sofim 8140.43N	107	146	10/01 > 07/04	S 3003 DR	S 4394 NR	S 3541 A	✗
assembly STANADYNE / montaggio STANADYNE	Sofim 8140.43N	107	146	10/01 > 07/04		S 4475 NR		
power steering / servosterzo	Sofim 8140.43N	107	146	10/01 > 07/04				S 3081 PO
160 DXi 3.0	DXi 3-160	115	156	05/04 >	S 5026 PE	S 4408 NR	S 5812 A	✗
90 2.8 D	Sofim 8140.63.2585	63	85	05/99 > 05/04	S 3003 DR	S 4394 NR	S 3541 A	✗
assembly STANADYNE / montaggio STANADYNE	Sofim 8140.63.2585	63	85	05/99 > 07/04		S 4475 NR		
Maxity								
110 DXi	YD25	81	110	03/07 >	S 1600 R	S 5394 GC	S 9380 A	
130 DXi	YD25	96	130	03/07 >	S 1600 R	S 5394 GC	S 9380 A	
150 DXi	ZD30	110	150	03/07 >	S 5026 PE	S 5394 GC	S 9380 A	
Maxter								
G230 TI								
with pump BOSCH / con pompa BOSCH	MIDR06.02.26D/X			10/92 > 05/95	S 0900 R	S 4323 NR	S 2650 A	
with pump DELPHI / con pompa DELPHI	MIDR06.02.26D/X			10/92 > 05/95	S 0900 R	S 7111 NC	S 2650 A	

R





kW HP



...RENAULT TRUCKS - trucks/autocarri

R



dryer filter / filtro essiccatore	MIDR06.02.26D/X	10/92 > 05/95				S 7129 A	S 7259 A
inner / interno	MIDR06.02.26D/X	10/92 > 05/95					
G260	MIDR06.20.45C	02/96 > 06/97	S 0900 R	S 4323 NR			
G270	MIDR06.20.45	01/93 > 10/96	S 0900 R	S 4323 NR			
dryer filter / filtro essiccatore	MIDR06.20.45	01/93 > 10/96					S 7259 A
power steering / servosterzo	MIDR06.20.45	01/93 > 10/96					S 3081 PO
G280							
with pump BOSCH / con pompa BOSCH	MIDS06.20.45	10/92 > 03/93	S 8600 R	S 3010 N			
with pump BOSCH / con pompa BOSCH	MIDS06.20.45	10/92 > 03/93	S 8600 R	S 4323 NR			
with pump DELPHI / con pompa DELPHI	MIDS06.20.45	10/92 > 03/93	S 8600 R	S 8111 NC			
with pump DELPHI / con pompa DELPHI	MIDS06.20.45	10/92 > 03/93	S 8600 R	S 7111 NC			
with pump SIGMA FS300 / con pompa SIGMA FS300	MIDS06.20.45	10/92 > 03/93	S 8600 R	S 0510 NR			
cartridge / immersione	MIDS06.20.45	10/92 > 03/93	S 1910 PO				
inner / interno	MIDS06.20.45	10/92 > 03/93				S 2840 A	
assembly DONALDSON / montaggio DONALDSON	MIDS06.20.45	10/92 > 03/93	S 8600 R			S 6550 A	✗
assembly DONALDSON / montaggio DONALDSON	MIDS06.20.45	10/92 > 03/93	S 8600 R			S 7945 A	✗
assembly DONALDSON / montaggio DONALDSON	MIDS06.20.45	10/92 > 03/93	S 8600 R			S 4770 A	✗
assembly DONALDSON / montaggio DONALDSON	MIDS06.20.45	10/92 > 03/93	S 8600 R			S 8840 A	✗
G300	MIDR06.20.45	10/92 > 06/97	S 0900 R	S 4323 NR			
dryer filter / filtro essiccatore	MIDR06.20.45	10/92 > 06/97					S 7259 A
power steering / servosterzo	MIDR06.20.45	10/92 > 06/97					S 3081 PO
G340 TI	MIDR06.20.45	10/92 > 06/97	S 0900 R	S 4323 NR			
dryer filter / filtro essiccatore	MIDR06.20.45	10/92 > 06/97					S 7259 A
power steering / servosterzo	MIDR06.20.45	10/92 > 06/97					S 3081 PO
Messenger							
B110 TD	Sofim 8140	08/90 > 07/91	S 3003 DR	S 8500 NR			
	Sofim 8140	08/91 > 05/94	S 3003 DR	S 8500 NR		S 0950 A	
power steering / servosterzo	Sofim 8140	08/90 > 05/94					S 3081 PO
B120 TD	Sofim 8140	10/91 > 08/96	S 3003 DR	S 8500 NR		S 0950 A	
power steering / servosterzo	Sofim 8140	10/91 > 08/96					S 3081 PO
B120.35	Sofim 8140	09/96 >	S 3003 DR	S 8500 NR			
power steering / servosterzo	Sofim 8140	09/96 >					S 3081 PO
B120.55	Sofim 8140	09/96 >	S 3003 DR	S 8500 NR			
power steering / servosterzo	Sofim 8140	09/96 >					S 3081 PO
B120.65	Sofim 8140	09/96 >	S 3003 DR	S 8500 NR			
power steering / servosterzo	Sofim 8140	09/96 >					S 3081 PO
Midliner							
210	MIDR06.02.26W	05/92 > 05/00	S 0900 R	S 4323 NR			
some / alcuni	MIDR06.02.26W	05/92 > 05/00	S 0900 R	S 4323 NR		S 2650 A	
power steering / servosterzo	MIDR06.02.26W	05/92 > 05/00					S 3081 PO
M140	MIDS06.02.12C	06/89 > 03/93	S 0900 R	S 4323 NR		S 2650 A	
dryer filter / filtro essiccatore	MIDS06.02.12C	06/89 > 03/93					S 7259 A
M150	MIDR06.02.26U	11/92 > 05/00	S 8600 R	S 4323 NR		S 2650 A	
some / alcuni	MIDR06.02.26U	11/92 > 05/00	S 0900 R	S 4323 NR		S 2650 A	
dryer filter / filtro essiccatore	MIDR06.02.26U	11/92 > 05/00					S 7259 A
inner / interno	MIDR06.02.26U	11/92 > 05/00				S 7129 A	
power steering / servosterzo	MIDR06.02.26U	11/92 > 05/00					S 3081 PO
M160	MIDS06.02.12B	06/89 > 03/93	S 0900 R	S 4323 NR		S 2650 A	
dryer filter / filtro essiccatore	MIDS06.02.12B	06/89 > 03/93					S 7259 A
inner / interno	MIDS06.02.12B	06/89 > 03/93				S 7129 A	
M180	MIDR06.02.26V	11/92 > 05/00	S 8600 R	S 4323 NR		S 2650 A	
some / alcuni	MIDR06.02.26V	11/92 > 05/00	S 0900 R	S 4323 NR		S 2650 A	
dryer filter / filtro essiccatore	MIDR06.02.26V	11/92 > 05/00					S 7259 A
inner / interno	MIDR06.02.26V	11/92 > 05/00				S 7129 A	
power steering / servosterzo	MIDR06.02.26V	11/92 > 05/00					S 3081 PO
M200	MIDR06.02.26H	06/89 > 03/93	S 0900 R	S 4323 NR		S 2650 A	
dryer filter / filtro essiccatore	MIDR06.02.26H	06/89 > 03/93					S 7259 A
M210	MIDR06.02.26W	05/92 > 05/00	S 0900 R	S 4323 NR		S 2650 A	
dryer filter / filtro essiccatore	MIDR06.02.26W	05/92 > 05/00					S 7259 A
power steering / servosterzo	MIDR06.02.26W	05/92 > 05/00					S 3081 PO
M230	MIDR06.02.26	06/89 > 05/00	S 0900 R	S 4323 NR		S 2650 A	
dryer filter / filtro essiccatore	MIDR06.02.26	06/89 > 05/00					S 7259 A
power steering / servosterzo	MIDR06.02.26	06/89 > 05/00					S 3081 PO
M250	MIDR06.02.26	03/93 > 05/00	S 8600 R	S 4323 NR		S 2650 A	
some / alcuni	MIDR06.02.26	03/93 > 05/00	S 0900 R	S 4323 NR		S 2650 A	
dryer filter / filtro essiccatore	MIDR06.02.26	11/92 > 05/00					S 7259 A
inner / interno	MIDR06.02.26	03/93 > 05/00				S 7129 A	



kW HP



...RENAULT TRUCKS - trucks/autocarri

power steering / servosterzo	MIDR06.02.26	03/93 > 05/00				S 3081 PO
ME160	MIDS06.02.12B	01/90 > 05/00	S 0900 R	S 4323 NR	S 2650 A	
dryer filter / filtro essiccatore	MIDS06.02.12B	01/90 > 05/00				S 7259 A
inner / interno	MIDS06.02.12B	01/90 > 05/00			S 7129 A	
ME180	MIDR06.02.12D	01/90 > 05/00	S 0900 R	S 4323 NR	S 2650 A	
dryer filter / filtro essiccatore	MIDR06.02.12D	01/90 > 05/00				S 7259 A
S100						
spin-on / avvitabile	Perkins T4.38/4.236	01/86 > 09/90	S 9400 R	S 4323 NR		
with pump DELPHI / con pompa DELPHI	Perkins T4.38/4.236	01/86 > 09/90	S 9400 R	S 7111 NC		
with pump SIGMA V80 / con pompa SIGMA V80	Perkins T4.38/4.236	01/86 > 09/90	S 9400 R			
dryer filter / filtro essiccatore	Perkins T4.38/4.236	01/86 > 09/90			S 7F24 A	
S110	797	06/85 > 09/90	S 3241 R		S 7974 A	✗
some / alcuni	797	06/85 > 09/90			S 7638 A	✗
spin-on / avvitabile	797	06/85 > 09/90		S 4323 NR		
with pump DELPHI / con pompa DELPHI	797	06/85 > 09/90		S 7111 NC		
dryer filter / filtro essiccatore	797	06/85 > 09/90			S 7F24 A	
S120	Perkins Phaser 110T/T4.40	09/90 > 10/94	S 0420 R	S 4323 NR		
dryer filter / filtro essiccatore	Perkins Phaser 110T/T4.40	09/90 > 06/93			S 7F24 A	
dryer filter / filtro essiccatore	Perkins Phaser 110T/T4.40	09/90 > 10/94				S 7259 A
S135	Perkins Phaser 110T/T4.40	02/94 > 05/96	S 0420 R	S 4323 NR		
dryer filter / filtro essiccatore	Perkins Phaser 110T/T4.40	02/94 > 01/96			S 7F24 A	
dryer filter / filtro essiccatore	Perkins Phaser 110T/T4.40	02/94 > 05/96				S 7259 A
S140	MIDS06.02.12C	02/90 > 09/93	S 0900 R		S 7974 A	✗
some / alcuni	MIDS06.02.12C	02/90 > 06/93			S 7638 A	
spin-on / avvitabile	MIDS06.02.12C	02/90 > 06/93		S 4323 NR		
with DELPHI pump / con pompa DELPHI	MIDS06.02.12C	02/90 > 06/93		S 7111 NC		
dryer filter / filtro essiccatore	MIDS06.02.12C	02/90 > 06/93				S 7259 A
dryer filter / filtro essiccatore	MIDS06.02.12C	02/90 > 09/93			S 7F24 A	
S150	798-10	05/83 > 07/86	S 3241 R		S 7974 A	✗
some / alcuni	798-10	05/83 > 07/86			S 7638 A	✗
spin-on / avvitabile	798-10	05/83 > 07/86		S 4323 NR		
with pump DELPHI / con pompa DELPHI	798-10	05/83 > 07/86		S 7111 NC		
dryer filter / filtro essiccatore	798-10	05/83 > 07/86			S 7F24 A	
assembly PERMATIC FO1719 / montaggio PERMATIC FO1719	798-10	05/83 > 07/86			S 7614 A	
S150	MIDR06.02.12/26	01/94 > 05/96	S 8600 R		S 7974 A	✗
some / alcuni	MIDR06.02.12/26	01/94 > 05/96			S 7638 A	
spin-on / avvitabile	MIDR06.02.12/26	01/94 > 05/96		S 4323 NR		
with DELPHI pump / con pompa DELPHI	MIDR06.02.12/26	01/94 > 05/96		S 7111 NC		
dryer filter / filtro essiccatore	MIDR06.02.12/26	01/94 > 05/96			S 7F24 A	
dryer filter / filtro essiccatore	MIDR06.02.12/26	01/94 > 05/96				S 7A66 A
dryer filter / filtro essiccatore	MIDR06.02.12/26	01/94 > 05/96				S 7259 A
S150 TI	MIDS06.02.12B	05/86 > 09/90	S 8600 R		S 7974 A	✗
some / alcuni	MIDS06.02.12B	05/86 > 09/90			S 7638 A	✗
spin-on / avvitabile	MIDS06.02.12B	05/86 > 09/90		S 4323 NR		
with DELPHI pump / con pompa DELPHI	MIDS06.02.12B	05/86 > 09/90		S 7111 NC		
dryer filter / filtro essiccatore	MIDS06.02.12B	05/86 > 09/90			S 7F24 A	
assembly PERMATIC FO1719 / montaggio PERMATIC FO1719	MIDS06.02.12B	05/86 > 09/90			S 7614 A	
S160	MIDS06.02.12B	02/90 > 04/93	S 8600 R		S 7974 A	✗
some / alcuni	MIDS06.02.12B	02/90 > 04/93			S 7638 A	✗
spin-on / avvitabile	MIDS06.02.12B	02/90 > 04/93		S 4323 NR		
with DELPHI pump / con pompa DELPHI	MIDS06.02.12B	02/90 > 04/93		S 7111 NC		
dryer filter / filtro essiccatore	MIDS06.02.12B	02/90 > 04/93			S 7F24 A	
power steering / servosterzo	MIDS06.02.12B	02/90 > 04/93				S 3081 PO
S170 4X4	MIDR06.02.12D	10/82 > 03/93	S 8600 R		S 7974 A	✗
some / alcuni	MIDR06.02.12D	10/82 > 03/93			S 7638 A	✗
spin-on / avvitabile	MIDR06.02.12D	10/82 > 03/93		S 4323 NR		
with DELPHI pump / con pompa DELPHI	MIDR06.02.12D	10/82 > 03/93		S 7111 NC		
dryer filter / filtro essiccatore	MIDR06.02.12D	10/82 > 03/93			S 7F24 A	
S180	MIDR06.02.26V	11/92 >	S 8600 R		S 7974 A	✗
some / alcuni	MIDR06.02.26V	11/92 >			S 7638 A	
spin-on / avvitabile	MIDR06.02.26V	11/92 >		S 4323 NR		
with DELPHI pump / con pompa DELPHI	MIDR06.02.26V	11/92 >		S 7111 NC		
dryer filter / filtro essiccatore	MIDR06.02.26V	11/92 >			S 7F24 A	
dryer filter / filtro essiccatore	MIDR06.02.26V	11/92 >				S 7A66 A
dryer filter / filtro essiccatore	MIDR06.02.26V	11/92 >				S 7259 A
power steering / servosterzo	MIDR06.02.26V	11/92 >				S 3081 PO
S180	MIDR06.02.26V/41	132 180	05/96 > 01/00	S 0900 R	S 7974 A	✗

R





KW HP



...RENAULT TRUCKS - trucks/autocarri

R

some / alcuni	MIDR06.02.26V/41	132	180	05/96	>	01/00			S 7638 A	
spin-on / avvitabile	MIDR06.02.26V/41	132	180	05/96	>	01/00		S 4323 NR		
with DELPHI pump / con pompa DELPHI	MIDR06.02.26V/41	132	180	05/96	>	01/00		S 7111 NC		
dryer filter / filtro essiccatore	MIDR06.02.26V/41	132	180	05/96	>	01/00				S 7259 A
power steering / servosterzo	MIDR06.02.26V/41	132	180	05/96	>	01/00				S 3081 PO
S220 TI										
with complete filter DONALDSON / con filtro completo DONALDSON	MIDR06.02.26				>	08/88	S 8600 R	S 4323 NR	S 2840 A	
with complete filter DONALDSON / con filtro completo DONALDSON	MIDR06.02.26			09/88	>		S 0900 R	S 4323 NR	S 2840 A	
dryer filter / filtro essiccatore	MIDR06.02.26			09/87	>	09/90			S 7F24 A	
inner / interno	MIDR06.02.26								S 2840 A	
S90	720			05/84	>	06/91	S 3241 R		S 7974 A	✗
some / alcuni	720			05/84	>	06/91			S 7638 A	✗
spin-on / avvitabile	720			05/84	>	06/91		S 4323 NR		
with BOSCH pump / con pompa BOSCH	720			05/84	>	06/91		S 9091 N		
with DELPHI pump / con pompa DELPHI	720			05/84	>	06/91		S 7111 NC		
dryer filter / filtro essiccatore	720			05/84	>	12/94			S 7F24 A	
Midlum										
135-07	MIDR04.02.26	100	136	02/00	>	12/01	S 3698 R	S 4323 NR		S 3217 C
dryer filter / filtro essiccatore	MIDR04.02.26	100	136	02/00	>	12/01				S 7344 A
assembly DONALDSON / montaggio DONALDSON	MIDR04.02.26	100	136	02/00	>	12/01			S 7357 A	
assembly DONALDSON, inner / montaggio DONALDSON, interno	MIDR04.02.26	100	136	02/00	>	12/01			S 7406 A	
assembly MANN+HUMMEL / montaggio MANN+HUMMEL	MIDR04.02.26	100	136	02/00	>	12/01			S 2650 A	
assembly STANADYNE / montaggio STANADYNE	MIDR04.02.26	100	136	02/00	>	12/01		S 4475 NR		
power steering / servosterzo	MIDR04.02.26	100	136	02/00	>	12/01				S 3081 PO
135-08	MIDR04.02.26	100	136	02/00	>	12/01	S 3698 R	S 4323 NR		S 3217 C
dryer filter / filtro essiccatore	MIDR04.02.26	100	136	02/00	>	12/01				S 7344 A
assembly DONALDSON / montaggio DONALDSON	MIDR04.02.26	100	136	02/00	>	12/01			S 7357 A	
assembly DONALDSON, inner / montaggio DONALDSON, interno	MIDR04.02.26	100	136	02/00	>	12/01			S 7406 A	
assembly MANN+HUMMEL / montaggio MANN+HUMMEL	MIDR04.02.26	100	136	02/00	>	12/01			S 2650 A	
assembly STANADYNE / montaggio STANADYNE	MIDR04.02.26	100	136	02/00	>	12/01		S 4475 NR		
power steering / servosterzo	MIDR04.02.26	100	136	02/00	>	12/01				S 3081 PO
135-09	MIDR04.02.26	100	136	02/00	>	12/01	S 3698 R	S 4323 NR		S 3217 C
dryer filter / filtro essiccatore	MIDR04.02.26	100	136	02/00	>	12/01				S 7344 A
assembly DONALDSON / montaggio DONALDSON	MIDR04.02.26	100	136	02/00	>	12/01			S 7357 A	
assembly DONALDSON, inner / montaggio DONALDSON, interno	MIDR04.02.26	100	136	02/00	>	12/01			S 7406 A	
assembly MANN+HUMMEL / montaggio MANN+HUMMEL	MIDR04.02.26	100	136	02/00	>	12/01			S 2650 A	
assembly STANADYNE / montaggio STANADYNE	MIDR04.02.26	100	136	02/00	>	12/01		S 4475 NR		
power steering / servosterzo	MIDR04.02.26	100	136	02/00	>	12/01				S 3081 PO
135-10	MIDR04.02.26	100	136	02/00	>	12/01	S 3698 R	S 4323 NR		S 3217 C
dryer filter / filtro essiccatore	MIDR04.02.26	100	136	02/00	>	12/01				S 7344 A
assembly DONALDSON / montaggio DONALDSON	MIDR04.02.26	100	136	02/00	>	12/01			S 7357 A	
assembly DONALDSON, inner / montaggio DONALDSON, interno	MIDR04.02.26	100	136	02/00	>	12/01			S 7406 A	
assembly MANN+HUMMEL / montaggio MANN+HUMMEL	MIDR04.02.26	100	136	02/00	>	12/01			S 2650 A	
assembly STANADYNE / montaggio STANADYNE	MIDR04.02.26	100	136	02/00	>	12/01		S 4475 NR		
power steering / servosterzo	MIDR04.02.26	100	136	02/00	>	12/01				S 3081 PO
150-08	MIDR04.02.26	110	150	02/00	>	12/01	S 3698 R	S 4323 NR		S 3217 C
with gearbox ZF Ecosplit + Intarder / con cambio ZF Ecosplit + Intarder	MIDR04.02.26	110	150	02/00	>	12/01				S 2234 Z
dryer filter / filtro essiccatore	MIDR04.02.26	110	150	02/00	>	12/01				S 7344 A
assembly DONALDSON / montaggio DONALDSON	MIDR04.02.26	110	150	02/00	>	12/01			S 7357 A	
assembly DONALDSON, inner / montaggio DONALDSON, interno	MIDR04.02.26	110	150	02/00	>	12/01			S 7406 A	
assembly MANN+HUMMEL / montaggio MANN+HUMMEL	MIDR04.02.26	110	150	02/00	>	12/01			S 2650 A	
assembly STANADYNE / montaggio STANADYNE	MIDR04.02.26	110	150	02/00	>	12/01		S 4475 NR		
power steering / servosterzo	MIDR04.02.26	110	150	02/00	>	12/01				S 3081 PO
150-08 DCI	DCI4-150	112	152	11/01	>	05/06	S 3698 R	S 0712 NR		S 3217 C
dryer filter / filtro essiccatore	DCI4-150	112	152	11/01	>	05/06				S 7344 A
assembly DONALDSON, height 373 mm / montaggio DONALDSON, altezza 373 mm	DCI4-150	112	152	11/01	>	05/06			S 2764 A	
assembly DONALDSON, height 465 mm / montaggio DONALDSON, altezza 465 mm	DCI4-150	112	152	11/01	>	05/06			S 7357 A	
assembly MANN+HUMMEL / montaggio MANN+HUMMEL	DCI4-150	112	152	11/01	>	05/06			S 2650 A	
assembly STANADYNE / montaggio STANADYNE	DCI4-150	112	152	11/01	>	05/06		S 4475 NR		
power steering / servosterzo	DCI4-150	112	152	11/01	>	05/06				S 3081 PO
150-09	MIDR04.02.26	110	150	02/00	>	12/01	S 3698 R	S 4323 NR		S 3217 C
dryer filter / filtro essiccatore	MIDR04.02.26	110	150	02/00	>	12/01				S 7344 A
assembly DONALDSON / montaggio DONALDSON	MIDR04.02.26	110	150	02/00	>	12/01			S 7357 A	
assembly DONALDSON, inner / montaggio DONALDSON, interno	MIDR04.02.26	110	150	02/00	>	12/01			S 7406 A	
assembly MANN+HUMMEL / montaggio MANN+HUMMEL	MIDR04.02.26	110	150	02/00	>	12/01			S 2650 A	
assembly STANADYNE / montaggio STANADYNE	MIDR04.02.26	110	150	02/00	>	12/01		S 4475 NR		
power steering / servosterzo	MIDR04.02.26	110	150	02/00	>	12/01				S 3081 PO

**KW HP****...RENAULT TRUCKS - trucks/autocarri**

150-10 DCI	DCI4-150	112 152	11/01 > 05/06	S 3698 R	S 0712 NR		S 3217 C
dryer filter / filtro essiccatore	DCI4-150	112 152	11/01 > 05/06				S 7344 A
assembly / montaggio	DCI4-150	112 152	11/01 > 04/06		S 4475 NR		
assembly DONALDSON, height 373 mm / montaggio DONALDSON, altezza 373 mm	DCI4-150	112 152	11/01 > 05/06			S 2764 A	
assembly DONALDSON, height 465 mm / montaggio DONALDSON, altezza 465 mm	DCI4-150	112 152	11/01 > 05/06			S 7357 A	
assembly MANN+HUMMEL / montaggio MANN+HUMMEL	DCI4-150	112 152	11/01 > 05/06			S 2650 A	
power steering / servosterzo	DCI4-150	112 152	11/01 > 05/06				S 3081 PO
150-12	MIDR04.02.26	110 150	02/00 > 12/01	S 3698 R	S 4323 NR		S 3217 C
with gearbox ZF Ecosplit + Intarder / con cambio ZF Ecosplit + Intarder	MIDR04.02.26	110 150	02/00 > 12/01				S 2234 Z
dryer filter / filtro essiccatore	MIDR04.02.26	110 150	02/00 > 12/01				S 7344 A
assembly DONALDSON / montaggio DONALDSON	MIDR04.02.26	110 150	02/00 > 12/01			S 7357 A	
assembly DONALDSON, inner / montaggio DONALDSON, interno	MIDR04.02.26	110 150	02/00 > 12/01			S 7406 A	
assembly MANN+HUMMEL / montaggio MANN+HUMMEL	MIDR04.02.26	110 150	02/00 > 12/01			S 2650 A	
assembly STANADYNE / montaggio STANADYNE	MIDR04.02.26	110 150	02/00 > 12/01		S 4475 NR		
power steering / servosterzo	MIDR04.02.26	110 150	02/00 > 12/01				S 3081 PO
150-12 DCI	DCI4-150	112 152	11/01 > 05/06	S 3698 R	S 0712 NR		S 3217 C
dryer filter / filtro essiccatore	DCI4-150	112 152	11/01 > 05/06				S 7344 A
assembly DONALDSON, height 373 mm / montaggio DONALDSON, altezza 373 mm	DCI4-150	112 152	11/01 > 05/06			S 2764 A	
assembly DONALDSON, height 465 mm / montaggio DONALDSON, altezza 465 mm	DCI4-150	112 152	11/01 > 05/06			S 7357 A	
assembly MANN+HUMMEL / montaggio MANN+HUMMEL	DCI4-150	112 152	11/01 > 05/06			S 2650 A	
assembly STANADYNE / montaggio STANADYNE	DCI4-150	112 152	11/01 > 05/06		S 4475 NR		
power steering / servosterzo	DCI4-150	112 152	11/01 > 05/06				S 3081 PO
160 DXi	DXi 5 Euro4/5	118 160	05/06 >	S 5097 PE	S 6039 NE		S 4402 U
with filter Urea/Adblue / con filtro Urea/Adblue	DXi 5 Euro4/5	118 160	05/06 >				
assembly DONALDSON, height 373 mm / montaggio DONALDSON, altezza 373 mm	DXi 5 Euro4/5	118 160	05/06 >			S 7B10 A	
assembly DONALDSON, height 461 mm / montaggio DONALDSON, altezza 461 mm	DXi 5 Euro4/5	118 160	05/06 >			S 7643 A	
assembly DONALDSON, inner / montaggio DONALDSON, interno	DXi 5 Euro4/5	118 160	05/06 >			S 7406 A	
power steering / servosterzo	DXi 5 Euro4/5	118 160	05/06 >				S 3081 PO
180 DXi	DXi 5 Euro4/5	136 180	07/09 >	S 5097 PE	S 6039 NE		S 4402 U
with filter Urea/Adblue / con filtro Urea/Adblue	DXi 5 Euro4/5	136 180	07/09 >				
assembly DONALDSON, height 373 mm / montaggio DONALDSON, altezza 373 mm	DXi 5 Euro4/5	136 180	07/09 >			S 7B10 A	
assembly DONALDSON, height 461 mm / montaggio DONALDSON, altezza 461 mm	DXi 5 Euro4/5	136 180	07/09 >			S 7643 A	
assembly DONALDSON, inner / montaggio DONALDSON, interno	DXi 5 Euro4/5	136 180	07/09 >			S 7406 A	
power steering / servosterzo	DXi 5 Euro4/5	136 180	07/09 >				S 3081 PO
180-08	MIDR04.02.26	132 180	02/00 > 12/01	S 3698 R	S 4323 NR		S 3217 C
dryer filter / filtro essiccatore	MIDR04.02.26	132 180	02/00 > 12/01				S 7344 A
assembly DONALDSON / montaggio DONALDSON	MIDR04.02.26	132 180	02/00 > 12/01			S 7357 A	
assembly DONALDSON, inner / montaggio DONALDSON, interno	MIDR04.02.26	132 180	02/00 > 12/01			S 7406 A	
assembly MANN+HUMMEL / montaggio MANN+HUMMEL	MIDR04.02.26	132 180	02/00 > 12/01			S 2650 A	
assembly STANADYNE / montaggio STANADYNE	MIDR04.02.26	132 180	02/00 > 12/01		S 4475 NR		
power steering / servosterzo	MIDR04.02.26	132 180	02/00 > 12/01				S 3081 PO
180-08 DCI	DCI4-180	128 174	11/01 > 05/06	S 3698 R	S 0712 NR		S 3217 C
dryer filter / filtro essiccatore	DCI4-180	128 174	11/01 > 05/06				S 7344 A
assembly / montaggio	DCI4-180	128 174	11/01 > 05/06		S 4475 NR		
assembly DONALDSON, height 373 mm / montaggio DONALDSON, altezza 373 mm	DCI4-180	128 174	11/01 > 05/06			S 2764 A	
assembly DONALDSON, height 465 mm / montaggio DONALDSON, altezza 465 mm	DCI4-180	128 174	11/01 > 05/06			S 7357 A	
assembly MANN+HUMMEL / montaggio MANN+HUMMEL	DCI4-180	128 174	11/01 > 05/06			S 2650 A	
power steering / servosterzo	DCI4-180	128 174	11/01 > 05/06				S 3081 PO
180-10	MIDR06.02.26	132 180	02/00 > 12/01	S 0900 R	S 4323 NR		S 3217 C
dryer filter / filtro essiccatore	MIDR06.02.26	132 180	02/00 > 12/01				S 7344 A
assembly DONALDSON / montaggio DONALDSON	MIDR06.02.26	132 180	02/00 > 12/01			S 7357 A	
assembly DONALDSON, inner / montaggio DONALDSON, interno	MIDR06.02.26	132 180	02/00 > 12/01			S 7406 A	
assembly MANN+HUMMEL / montaggio MANN+HUMMEL	MIDR06.02.26	132 180	02/00 > 12/01			S 2650 A	
assembly STANADYNE / montaggio STANADYNE	MIDR06.02.26	132 180	02/00 > 12/01		S 4475 NR		
power steering / servosterzo	MIDR06.02.26	132 180	02/00 > 12/01				S 3081 PO
180-10 DCI	DCI4-180	128 174	11/01 > 05/06	S 3698 R	S 0712 NR		S 3217 C
dryer filter / filtro essiccatore	DCI4-180	128 174	11/01 > 05/06				S 7344 A
assembly DONALDSON, height 373 mm / montaggio DONALDSON, altezza 373 mm	DCI4-180	128 174	11/01 > 05/06			S 2764 A	
assembly DONALDSON, height 465 mm / montaggio DONALDSON, altezza 465 mm	DCI4-180	128 174	11/01 > 05/06			S 7357 A	
assembly MANN+HUMMEL / montaggio MANN+HUMMEL	DCI4-180	128 174	11/01 > 05/06			S 2650 A	
assembly STANADYNE / montaggio STANADYNE	DCI4-180	128 174	11/01 > 05/06		S 4475 NR		
power steering / servosterzo	DCI4-180	128 174	11/01 > 05/06				S 3081 PO
180-12	MIDR06.02.26	132 180	02/00 > 12/01	S 0900 R	S 4323 NR		S 3217 C
dryer filter / filtro essiccatore	MIDR06.02.26	132 180	02/00 > 12/01				S 7344 A
assembly / montaggio	MIDR06.02.26	132 180	02/00 > 12/01		S 4475 NR		
assembly DONALDSON / montaggio DONALDSON	MIDR06.02.26	132 180	02/00 > 12/01			S 7357 A	
assembly DONALDSON, inner / montaggio DONALDSON, interno	MIDR06.02.26	132 180	02/00 > 12/01			S 7406 A	

R

**KW HP****...RENAULT TRUCKS - trucks/autocarri****R**

assembly MANN+HUMMEL / montaggio MANN+HUMMEL	MIDR06.02.26	132	180	02/00	>	12/01			S 2650 A	
power steering / servosterzo	MIDR06.02.26	132	180	02/00	>	12/01				S 3081 PO
180-12 DCI	DCI4-180	128	174	11/01	>	05/06	S 3698 R	S 0712 NR		S 3217 C
dryer filter / filtro essiccatore	DCI4-180	128	174	11/01	>	05/06				S 7344 A
assembly DONALDSON, height 373 mm / montaggio DONALDSON, altezza 373 mm	DCI4-180	128	174	11/01	>	05/06			S 2764 A	
assembly DONALDSON, height 465 mm / montaggio DONALDSON, altezza 465 mm	DCI4-180	128	174	11/01	>	05/06			S 7357 A	
assembly MANN+HUMMEL / montaggio MANN+HUMMEL	DCI4-180	128	174	11/01	>	05/06			S 2650 A	
assembly STANADYNE / montaggio STANADYNE	DCI4-180	128	174	02/00	>	12/01		S 4475 NR		
power steering / servosterzo	DCI4-180	128	174	11/01	>	05/06				S 3081 PO
190 DXi	DXi 5 Euro4/5	140	190	05/06	>		S 5097 PE	S 6039 NE		
with filter Urea/Adblue / con filtro Urea/Adblue	DXi 5 Euro4/5	140	190	05/06	>					S 4402 U
assembly DONALDSON, height 373 mm / montaggio DONALDSON, altezza 373 mm	DXi 5 Euro4/5	140	190	05/06	>				S 7B10 A	
assembly DONALDSON, height 461 mm / montaggio DONALDSON, altezza 461 mm	DXi 5 Euro4/5	140	190	05/06	>				S 7643 A	
assembly DONALDSON, inner / montaggio DONALDSON, interno	DXi 5 Euro4/5	140	190	05/06	>				S 7406 A	
power steering / servosterzo	DXi 5 Euro4/5	140	190	05/06	>					S 3081 PO
210-08	MIDR06.02.26	154	210	02/00	>	12/01	S 0900 R	S 4323 NR		S 3217 C
with gearbox ZF Ecosplit + Intarder / con cambio ZF Ecosplit + Intarder	MIDR06.02.26	154	210	02/00	>	12/01				S 2234 Z
dryer filter / filtro essiccatore	MIDR06.02.26	154	210	02/00	>	12/01				S 7344 A
assembly DONALDSON / montaggio DONALDSON	MIDR06.02.26	154	210	02/00	>	12/01			S 7357 A	
assembly DONALDSON, inner / montaggio DONALDSON, interno	MIDR06.02.26	154	210	02/00	>	12/01			S 7406 A	
assembly MANN+HUMMEL / montaggio MANN+HUMMEL	MIDR06.02.26	154	210	02/00	>	12/01			S 2650 A	
assembly STANADYNE / montaggio STANADYNE	MIDR06.02.26	154	210	02/00	>	12/01		S 4475 NR		
power steering / servosterzo	MIDR06.02.26	154	210	02/00	>	12/01				S 3081 PO
210-09	MIDR06.02.26	154	210	02/00	>	12/01	S 0900 R	S 4323 NR		S 3217 C
with gearbox ZF Ecosplit + Intarder / con cambio ZF Ecosplit + Intarder	MIDR06.02.26	154	210	02/00	>	12/01				S 2234 Z
dryer filter / filtro essiccatore	MIDR06.02.26	154	210	02/00	>	12/01				S 7344 A
assembly DONALDSON / montaggio DONALDSON	MIDR06.02.26	154	210	02/00	>	12/01			S 7357 A	
assembly DONALDSON, inner / montaggio DONALDSON, interno	MIDR06.02.26	154	210	02/00	>	12/01			S 7406 A	
assembly MANN+HUMMEL / montaggio MANN+HUMMEL	MIDR06.02.26	154	210	02/00	>	12/01			S 2650 A	
assembly STANADYNE / montaggio STANADYNE	MIDR06.02.26	154	210	02/00	>	12/01		S 4475 NR		
power steering / servosterzo	MIDR06.02.26	154	210	02/00	>	12/01				S 3081 PO
210-10	MIDR06.02.26	154	210	02/00	>	12/01	S 0900 R	S 4323 NR		S 3217 C
with gearbox ZF Ecosplit + Intarder / con cambio ZF Ecosplit + Intarder	MIDR06.02.26	154	210	02/00	>	12/01				S 2234 Z
dryer filter / filtro essiccatore	MIDR06.02.26	154	210	02/00	>	12/01				S 7344 A
assembly DONALDSON / montaggio DONALDSON	MIDR06.02.26	154	210	02/00	>	12/01			S 7357 A	
assembly DONALDSON, inner / montaggio DONALDSON, interno	MIDR06.02.26	154	210	02/00	>	12/01			S 7406 A	
assembly MANN+HUMMEL / montaggio MANN+HUMMEL	MIDR06.02.26	154	210	02/00	>	12/01			S 2650 A	
assembly STANADYNE / montaggio STANADYNE	MIDR06.02.26	154	210	02/00	>	12/01		S 4475 NR		
power steering / servosterzo	MIDR06.02.26	154	210	02/00	>	12/01				S 3081 PO
210-12	MIDR06.02.26	154	210	02/00	>	12/01	S 0900 R	S 4323 NR		S 3217 C
with gearbox ZF Ecosplit + Intarder / con cambio ZF Ecosplit + Intarder	MIDR06.02.26	154	210	02/00	>	12/01				S 2234 Z
dryer filter / filtro essiccatore	MIDR06.02.26	154	210	02/00	>	12/01				S 7344 A
assembly DONALDSON / montaggio DONALDSON	MIDR06.02.26	154	210	02/00	>	12/01			S 7357 A	
assembly DONALDSON, inner / montaggio DONALDSON, interno	MIDR06.02.26	154	210	02/00	>	12/01			S 7406 A	
assembly MANN+HUMMEL / montaggio MANN+HUMMEL	MIDR06.02.26	154	210	02/00	>	12/01			S 2650 A	
assembly STANADYNE / montaggio STANADYNE	MIDR06.02.26	154	210	02/00	>	12/01		S 4475 NR		
power steering / servosterzo	MIDR06.02.26	154	210	02/00	>	12/01				S 3081 PO
210-13	MIDR06.02.26	154	210	02/00	>	12/01	S 0900 R	S 4323 NR		S 3217 C
with gearbox ZF Ecosplit + Intarder / con cambio ZF Ecosplit + Intarder	MIDR06.02.26	154	210	02/00	>	12/01				S 2234 Z
dryer filter / filtro essiccatore	MIDR06.02.26	154	210	02/00	>	12/01				S 7344 A
assembly DONALDSON / montaggio DONALDSON	MIDR06.02.26	154	210	02/00	>	12/01			S 7357 A	
assembly DONALDSON, inner / montaggio DONALDSON, interno	MIDR06.02.26	154	210	02/00	>	12/01			S 7406 A	
assembly MANN+HUMMEL / montaggio MANN+HUMMEL	MIDR06.02.26	154	210	02/00	>	12/01			S 2650 A	
assembly STANADYNE / montaggio STANADYNE	MIDR06.02.26	154	210	02/00	>	12/01		S 4475 NR		
power steering / servosterzo	MIDR06.02.26	154	210	02/00	>	12/01				S 3081 PO
210-14	MIDR06.02.26	154	210	02/00	>	12/01	S 0900 R	S 4323 NR		S 3217 C
with gearbox ZF Ecosplit + Intarder / con cambio ZF Ecosplit + Intarder	MIDR06.02.26	154	210	02/00	>	12/01				S 2234 Z
dryer filter / filtro essiccatore	MIDR06.02.26	154	210	02/00	>	12/01				S 7344 A
assembly DONALDSON / montaggio DONALDSON	MIDR06.02.26	154	210	02/00	>	12/01			S 7357 A	
assembly DONALDSON, inner / montaggio DONALDSON, interno	MIDR06.02.26	154	210	02/00	>	12/01			S 7406 A	
assembly MANN+HUMMEL / montaggio MANN+HUMMEL	MIDR06.02.26	154	210	02/00	>	12/01			S 2650 A	
assembly STANADYNE / montaggio STANADYNE	MIDR06.02.26	154	210	02/00	>	12/01		S 4475 NR		
power steering / servosterzo	MIDR06.02.26	154	210	02/00	>	12/01				S 3081 PO
210-15	MIDR06.02.26	154	210	02/00	>	12/01	S 0900 R	S 4323 NR		S 3217 C
with gearbox ZF Ecosplit + Intarder / con cambio ZF Ecosplit + Intarder	MIDR06.02.26	154	210	02/00	>	12/01				S 2234 Z
dryer filter / filtro essiccatore	MIDR06.02.26	154	210	02/00	>	12/01				S 7344 A
assembly DONALDSON / montaggio DONALDSON	MIDR06.02.26	154	210	02/00	>	12/01			S 7357 A	

**KW HP**

...RENAULT TRUCKS - trucks/autocarri

assembly DONALDSON, inner / montaggio DONALDSON, interno	MIDR06.02.26	154	210	02/00	>	12/01			S 7406 A	
assembly MANN+HUMMEL / montaggio MANN+HUMMEL	MIDR06.02.26	154	210	02/00	>	12/01			S 2650 A	
assembly STANADYNE / montaggio STANADYNE	MIDR06.02.26	154	210	02/00	>	12/01		S 4475 NR		
power steering / servosterzo	MIDR06.02.26	154	210	02/00	>	12/01				S 3081 PO
210-16	MIDR06.02.26	154	210	02/00	>	12/01	S 0900 R	S 4323 NR		S 3217 C
with gearbox ZF Ecosplit + Intarder / con cambio ZF Ecosplit + Intarder	MIDR06.02.26	154	210	02/00	>	12/01				S 2234 Z
dryer filter / filtro essiccatore	MIDR06.02.26	154	210	02/00	>	12/01				S 7344 A
assembly DONALDSON / montaggio DONALDSON	MIDR06.02.26	154	210	02/00	>	12/01			S 7357 A	
assembly DONALDSON, inner / montaggio DONALDSON, interno	MIDR06.02.26	154	210	02/00	>	12/01			S 7406 A	
assembly MANN+HUMMEL / montaggio MANN+HUMMEL	MIDR06.02.26	154	210	02/00	>	12/01			S 2650 A	
assembly STANADYNE / montaggio STANADYNE	MIDR06.02.26	154	210	02/00	>	12/01		S 4475 NR		
power steering / servosterzo	MIDR06.02.26	154	210	02/00	>	12/01				S 3081 PO
220 DXi	DXi 5 Euro4/5	162	220	05/06	>		S 5097 PE	S 6039 NE		
with filter Urea/Adblue / con filtro Urea/Adblue	DXi 5 Euro4/5	162	220	05/06	>					S 4402 U
assembly DONALDSON, height 373 mm / montaggio DONALDSON, altezza 373 mm	DXi 5 Euro4/5	162	220	05/06	>				S 7B10 A	
assembly DONALDSON, height 461 mm / montaggio DONALDSON, altezza 461 mm	DXi 5 Euro4/5	162	220	05/06	>				S 7643 A	
assembly DONALDSON, inner / montaggio DONALDSON, interno	DXi 5 Euro4/5	162	220	05/06	>				S 7406 A	
power steering / servosterzo	DXi 5 Euro4/5	162	220	05/06	>					S 3081 PO
220-08 DCI	DCI6-220	158	215	11/01	>	05/06	S 0900 R			S 3217 C
with gearbox ZF Ecosplit + Intarder / con cambio ZF Ecosplit + Intarder	DCI6-220	158	215	11/01	>	05/06				S 2234 Z
dryer filter / filtro essiccatore	DCI6-220	158	215	11/01	>	05/06				S 7344 A
assembly DONALDSON, height 373 mm / montaggio DONALDSON, altezza 373 mm	DCI6-220	158	215	11/01	>	05/06			S 2764 A	
assembly DONALDSON, height 465 mm / montaggio DONALDSON, altezza 465 mm	DCI6-220	158	215	11/01	>	05/06			S 7357 A	
assembly MANN+HUMMEL / montaggio MANN+HUMMEL	DCI6-220	158	215	11/01	>	05/06			S 2650 A	
assembly STANADYNE / montaggio STANADYNE	DCI6-220	158	215	11/01	>	05/06		S 4475 NR		
2 filters / N.2 filtri	DCI6-220	158	215	11/01	>	05/06		S 0712 NR		
power steering / servosterzo	DCI6-220	158	215	11/01	>	05/06				S 3081 PO
220-10 DCI	DCI6-220	158	215	11/01	>	05/06	S 0900 R			S 3217 C
with gearbox ZF Ecosplit + Intarder / con cambio ZF Ecosplit + Intarder	DCI6-220	158	215	11/01	>	05/06				S 2234 Z
dryer filter / filtro essiccatore	DCI6-220	158	215	11/01	>	05/06				S 7344 A
assembly DONALDSON, height 373 mm / montaggio DONALDSON, altezza 373 mm	DCI6-220	158	215	11/01	>	05/06			S 2764 A	
assembly DONALDSON, height 465 mm / montaggio DONALDSON, altezza 465 mm	DCI6-220	158	215	11/01	>	05/06			S 7357 A	
assembly MANN+HUMMEL / montaggio MANN+HUMMEL	DCI6-220	158	215	11/01	>	05/06			S 2650 A	
assembly STANADYNE / montaggio STANADYNE	DCI6-220	158	215	11/01	>	05/06		S 4475 NR		
2 filters / N.2 filtri	DCI6-220	158	215	11/01	>	05/06		S 0712 NR		
power steering / servosterzo	DCI6-220	158	215	11/01	>	05/06				S 3081 PO
220-12 DCI	DCI6-220	158	215	11/01	>	05/06	S 0900 R			S 3217 C
with gearbox ZF Ecosplit + Intarder / con cambio ZF Ecosplit + Intarder	DCI6-220	158	215	11/01	>	05/06				S 2234 Z
dryer filter / filtro essiccatore	DCI6-220	158	215	11/01	>	05/06				S 7344 A
assembly DONALDSON, height 373 mm / montaggio DONALDSON, altezza 373 mm	DCI6-220	158	215	11/01	>	05/06			S 2764 A	
assembly DONALDSON, height 465 mm / montaggio DONALDSON, altezza 465 mm	DCI6-220	158	215	11/01	>	05/06			S 7357 A	
assembly MANN+HUMMEL / montaggio MANN+HUMMEL	DCI6-220	158	215	11/01	>	05/06			S 2650 A	
assembly STANADYNE / montaggio STANADYNE	DCI6-220	158	215	11/01	>	05/06		S 4475 NR		
2 filters / N.2 filtri	DCI6-220	158	215	11/01	>	05/06		S 0712 NR		
power steering / servosterzo	DCI6-220	158	215	11/01	>	05/06				S 3081 PO
220-13 DCI	DCI6-220	158	215	11/01	>	05/06	S 0900 R			S 3217 C
with gearbox ZF Ecosplit + Intarder / con cambio ZF Ecosplit + Intarder	DCI6-220	158	215	11/01	>	05/06				S 2234 Z
dryer filter / filtro essiccatore	DCI6-220	158	215	11/01	>	05/06				S 7344 A
assembly DONALDSON, height 373 mm / montaggio DONALDSON, altezza 373 mm	DCI6-220	158	215	11/01	>	05/06			S 2764 A	
assembly DONALDSON, height 465 mm / montaggio DONALDSON, altezza 465 mm	DCI6-220	158	215	11/01	>	05/06			S 7357 A	
assembly MANN+HUMMEL / montaggio MANN+HUMMEL	DCI6-220	158	215	11/01	>	05/06			S 2650 A	
assembly STANADYNE / montaggio STANADYNE	DCI6-220	158	215	11/01	>	05/06		S 4475 NR		
2 filters / N.2 filtri	DCI6-220	158	215	11/01	>	05/06		S 0712 NR		
power steering / servosterzo	DCI6-220	158	215	11/01	>	05/06				S 3081 PO
220-14 DCI	DCI6-220	158	215	11/01	>	05/06	S 0900 R			S 3217 C
with gearbox ZF Ecosplit + Intarder / con cambio ZF Ecosplit + Intarder	DCI6-220	158	215	11/01	>	05/06				S 2234 Z
dryer filter / filtro essiccatore	DCI6-220	158	215	11/01	>	05/06				S 7344 A
assembly DONALDSON, height 373 mm / montaggio DONALDSON, altezza 373 mm	DCI6-220	158	215	11/01	>	05/06			S 2764 A	
assembly DONALDSON, height 465 mm / montaggio DONALDSON, altezza 465 mm	DCI6-220	158	215	11/01	>	05/06			S 7357 A	
assembly MANN+HUMMEL / montaggio MANN+HUMMEL	DCI6-220	158	215	11/01	>	05/06			S 2650 A	
assembly STANADYNE / montaggio STANADYNE	DCI6-220	158	215	11/01	>	05/06		S 4475 NR		
2 filters / N.2 filtri	DCI6-220	158	215	11/01	>	05/06		S 0712 NR		
power steering / servosterzo	DCI6-220	158	215	11/01	>	05/06				S 3081 PO
220-16 DCI	DCI6-220	158	215	11/01	>	05/06	S 0900 R			S 3217 C
with gearbox ZF Ecosplit + Intarder / con cambio ZF Ecosplit + Intarder	DCI6-220	158	215	11/01	>	05/06				S 2234 Z
dryer filter / filtro essiccatore	DCI6-220	158	215	11/01	>	05/06				S 7344 A
assembly DONALDSON, height 373 mm / montaggio DONALDSON, altezza 373 mm	DCI6-220	158	215	11/01	>	05/06			S 2764 A	

R



...RENAULT TRUCKS - trucks/autocarri

R

assembly DONALDSON, height 465 mm / montaggio DONALDSON, altezza 465 mm	DCI6-220	158 215	11/01 >	05/06			S 7357 A	
assembly MANN+HUMMEL / montaggio MANN+HUMMEL	DCI6-220	158 215	11/01 >	05/06			S 2650 A	
assembly STANADYNE / montaggio STANADYNE	DCI6-220	158 215	11/01 >	05/06		S 4475 NR		
2 filters / N.2 filtri	DCI6-220	158 215	11/01 >	05/06		S 0712 NR		
power steering / servosterzo	DCI6-220	158 215	11/01 >	05/06				S 3081 PO
220-18 DCI	DCI6-220	158 215	11/01 >	05/06	S 0900 R			S 3217 C
with gearbox ZF Ecosplit + Intarder / con cambio ZF Ecosplit + Intarder	DCI6-220	158 215	11/01 >	05/06				S 2234 Z
dryer filter / filtro essiccatore	DCI6-220	158 215	11/01 >	05/06				S 7344 A
assembly DONALDSON, height 373 mm / montaggio DONALDSON, altezza 373 mm	DCI6-220	158 215	11/01 >	05/06			S 2764 A	
assembly DONALDSON, height 465 mm / montaggio DONALDSON, altezza 465 mm	DCI6-220	158 215	11/01 >	05/06			S 7357 A	
assembly MANN+HUMMEL / montaggio MANN+HUMMEL	DCI6-220	158 215	11/01 >	05/06			S 2650 A	
assembly STANADYNE / montaggio STANADYNE	DCI6-220	158 215	11/01 >	05/06		S 4475 NR		
2 filters / N.2 filtri	DCI6-220	158 215	11/01 >	05/06		S 0712 NR		
power steering / servosterzo	DCI6-220	158 215	11/01 >	05/06				S 3081 PO
240 DXi	DXi 7 Euro4/5	177 240	05/06 >		S 5097 PE	S 6039 NE		
with filter Urea/Adblue / con filtro Urea/Adblue	DXi 7 Euro4/5	177 240	05/06 >					S 4402 U
assembly DONALDSON, height 373 mm / montaggio DONALDSON, altezza 373 mm	DXi 7 Euro4/5	177 240	05/06 >				S 7B10 A	
assembly DONALDSON, height 461 mm / montaggio DONALDSON, altezza 461 mm	DXi 7 Euro4/5	177 240	05/06 >				S 7643 A	
assembly DONALDSON, inner / montaggio DONALDSON, interno	DXi 7 Euro4/5	177 240	05/06 >				S 7406 A	
power steering / servosterzo	DXi 7 Euro4/5	177 240	05/06 >					S 3081 PO
250-12	MIDR06.02.26	184 250	02/00 >	12/01	S 0900 R	S 4323 NR		S 3217 C
with gearbox ZF Ecosplit + Intarder / con cambio ZF Ecosplit + Intarder	MIDR06.02.26	184 250	02/00 >	12/01				S 2234 Z
dryer filter / filtro essiccatore	MIDR06.02.26	184 250	02/00 >	12/01				S 7344 A
assembly DONALDSON / montaggio DONALDSON	MIDR06.02.26	184 250	02/00 >	12/01			S 7357 A	
assembly DONALDSON, inner / montaggio DONALDSON, interno	MIDR06.02.26	184 250	02/00 >	12/01			S 7406 A	
assembly MANN+HUMMEL / montaggio MANN+HUMMEL	MIDR06.02.26	184 250	02/00 >	12/01			S 2650 A	
assembly STANADYNE / montaggio STANADYNE	MIDR06.02.26	184 250	02/00 >	12/01		S 4475 NR		
power steering / servosterzo	MIDR06.02.26	184 250	02/00 >	12/01				S 3081 PO
250-13	MIDR06.02.26	184 250	02/00 >	12/01	S 0900 R	S 4323 NR		S 3217 C
with gearbox ZF Ecosplit + Intarder / con cambio ZF Ecosplit + Intarder	MIDR06.02.26	184 250	02/00 >	12/01				S 2234 Z
dryer filter / filtro essiccatore	MIDR06.02.26	184 250	02/00 >	12/01				S 7344 A
assembly DONALDSON / montaggio DONALDSON	MIDR06.02.26	184 250	02/00 >	12/01			S 7357 A	
assembly DONALDSON, inner / montaggio DONALDSON, interno	MIDR06.02.26	184 250	02/00 >	12/01			S 7406 A	
assembly MANN+HUMMEL / montaggio MANN+HUMMEL	MIDR06.02.26	184 250	02/00 >	12/01			S 2650 A	
assembly STANADYNE / montaggio STANADYNE	MIDR06.02.26	184 250	02/00 >	12/01		S 4475 NR		
power steering / servosterzo	MIDR06.02.26	184 250	02/00 >	12/01				S 3081 PO
250-14	MIDR06.02.26	184 250	02/00 >	12/01	S 0900 R	S 4323 NR		S 3217 C
with gearbox ZF Ecosplit + Intarder / con cambio ZF Ecosplit + Intarder	MIDR06.02.26	184 250	02/00 >	12/01				S 2234 Z
dryer filter / filtro essiccatore	MIDR06.02.26	184 250	02/00 >	12/01				S 7344 A
assembly DONALDSON / montaggio DONALDSON	MIDR06.02.26	184 250	02/00 >	12/01			S 7357 A	
assembly DONALDSON, inner / montaggio DONALDSON, interno	MIDR06.02.26	184 250	02/00 >	12/01			S 7406 A	
assembly MANN+HUMMEL / montaggio MANN+HUMMEL	MIDR06.02.26	184 250	02/00 >	12/01			S 2650 A	
assembly STANADYNE / montaggio STANADYNE	MIDR06.02.26	184 250	02/00 >	12/01		S 4475 NR		
power steering / servosterzo	MIDR06.02.26	184 250	02/00 >	12/01				S 3081 PO
250-15	MIDR06.02.26	184 250	02/00 >	12/01	S 0900 R	S 4323 NR		S 3217 C
with gearbox ZF Ecosplit + Intarder / con cambio ZF Ecosplit + Intarder	MIDR06.02.26	184 250	02/00 >	12/01				S 2234 Z
dryer filter / filtro essiccatore	MIDR06.02.26	184 250	02/00 >	12/01				S 7344 A
assembly DONALDSON / montaggio DONALDSON	MIDR06.02.26	184 250	02/00 >	12/01			S 7357 A	
assembly DONALDSON, inner / montaggio DONALDSON, interno	MIDR06.02.26	184 250	02/00 >	12/01			S 7406 A	
assembly MANN+HUMMEL / montaggio MANN+HUMMEL	MIDR06.02.26	184 250	02/00 >	12/01			S 2650 A	
assembly STANADYNE / montaggio STANADYNE	MIDR06.02.26	184 250	02/00 >	12/01		S 4475 NR		
power steering / servosterzo	MIDR06.02.26	184 250	02/00 >	12/01				S 3081 PO
250-16	MIDR06.02.26	184 250	02/00 >	12/01	S 0900 R	S 4323 NR		S 3217 C
with gearbox ZF Ecosplit + Intarder / con cambio ZF Ecosplit + Intarder	MIDR06.02.26	184 250	02/00 >	12/01				S 2234 Z
dryer filter / filtro essiccatore	MIDR06.02.26	184 250	02/00 >	12/01				S 7344 A
assembly DONALDSON / montaggio DONALDSON	MIDR06.02.26	184 250	02/00 >	12/01			S 7357 A	
assembly DONALDSON, inner / montaggio DONALDSON, interno	MIDR06.02.26	184 250	02/00 >	12/01			S 7406 A	
assembly MANN+HUMMEL / montaggio MANN+HUMMEL	MIDR06.02.26	184 250	02/00 >	12/01			S 2650 A	
assembly STANADYNE / montaggio STANADYNE	MIDR06.02.26	184 250	02/00 >	12/01		S 4475 NR		
power steering / servosterzo	MIDR06.02.26	184 250	02/00 >	12/01				S 3081 PO
270 DXi	DXi 7 Euro4/5	195 270	07/09 >		S 5097 PE	S 6039 NE		
with filter Urea/Adblue / con filtro Urea/Adblue	DXi 7 Euro4/5	195 270	07/09 >					S 4402 U
assembly DONALDSON, height 373 mm / montaggio DONALDSON, altezza 373 mm	DXi 7 Euro4/5	195 270	07/09 >				S 7B10 A	
assembly DONALDSON, height 461 mm / montaggio DONALDSON, altezza 461 mm	DXi 7 Euro4/5	195 270	07/09 >				S 7643 A	
assembly DONALDSON, inner / montaggio DONALDSON, interno	DXi 7 Euro4/5	195 270	07/09 >				S 7406 A	
power steering / servosterzo	DXi 7 Euro4/5	195 270	07/09 >					S 3081 PO
270-12 DCI	DCI6-270	195 265	11/01 >	05/06	S 0900 R			S 3217 C

**kW HP****...RENAULT TRUCKS - trucks/autocarri**

with gearbox ZF Ecosplit + Intarder / con cambio ZF Ecosplit + Intarder	DCI6-270	195	265	11/01	>	05/06			S 2234 Z	
dryer filter / filtro essiccatore	DCI6-270	195	265	11/01	>	05/06			S 7344 A	
assembly DONALDSON, height 373 mm / montaggio DONALDSON, altezza 373 mm	DCI6-270	195	265	11/01	>	05/06		S 2764 A		
assembly DONALDSON, height 465 mm / montaggio DONALDSON, altezza 465 mm	DCI6-270	195	265	11/01	>	05/06		S 7357 A		
assembly MANN+HUMMEL / montaggio MANN+HUMMEL	DCI6-270	195	265	11/01	>	05/06		S 2650 A		
assembly STANADYNE / montaggio STANADYNE	DCI6-270	195	265	11/01	>	05/06				
2 filters / N.2 filtri	DCI6-270	195	265	11/01	>	05/06				
power steering / servosterzo	DCI6-270	195	265	11/01	>	05/06			S 3081 PO	
270-13 DCI	DCI6-270	195	265	11/01	>	05/06	S 0900 R		S 3217 C	
with gearbox ZF Ecosplit + Intarder / con cambio ZF Ecosplit + Intarder	DCI6-270	195	265	11/01	>	05/06			S 2234 Z	
dryer filter / filtro essiccatore	DCI6-270	195	265	11/01	>	05/06			S 7344 A	
assembly DONALDSON, height 373 mm / montaggio DONALDSON, altezza 373 mm	DCI6-270	195	265	11/01	>	05/06		S 2764 A		
assembly DONALDSON, height 465 mm / montaggio DONALDSON, altezza 465 mm	DCI6-270	195	265	11/01	>	05/06		S 7357 A		
assembly MANN+HUMMEL / montaggio MANN+HUMMEL	DCI6-270	195	265	11/01	>	05/06		S 2650 A		
assembly STANADYNE / montaggio STANADYNE	DCI6-270	195	265	11/01	>	05/06				
2 filters / N.2 filtri	DCI6-270	195	265	11/01	>	05/06				
power steering / servosterzo	DCI6-270	195	265	11/01	>	05/06			S 3081 PO	
270-14 DCI	DCI6-270	195	265	11/01	>	05/06	S 0900 R		S 3217 C	
with gearbox ZF Ecosplit + Intarder / con cambio ZF Ecosplit + Intarder	DCI6-270	195	265	11/01	>	05/06			S 2234 Z	
dryer filter / filtro essiccatore	DCI6-270	195	265	11/01	>	05/06			S 7344 A	
assembly DONALDSON, height 373 mm / montaggio DONALDSON, altezza 373 mm	DCI6-270	195	265	11/01	>	05/06		S 2764 A		
assembly DONALDSON, height 465 mm / montaggio DONALDSON, altezza 465 mm	DCI6-270	195	265	11/01	>	05/06		S 7357 A		
assembly MANN+HUMMEL / montaggio MANN+HUMMEL	DCI6-270	195	265	11/01	>	05/06		S 2650 A		
assembly STANADYNE / montaggio STANADYNE	DCI6-270	195	265	11/01	>	05/06				
2 filters / N.2 filtri	DCI6-270	195	265	11/01	>	05/06				
power steering / servosterzo	DCI6-270	195	265	11/01	>	05/06			S 3081 PO	
270-16 DCI	DCI6-270	195	265	11/01	>	05/06	S 0900 R		S 3217 C	
with gearbox ZF Ecosplit + Intarder / con cambio ZF Ecosplit + Intarder	DCI6-270	195	265	11/01	>	05/06			S 2234 Z	
dryer filter / filtro essiccatore	DCI6-270	195	265	11/01	>	05/06			S 7344 A	
assembly DONALDSON, height 373 mm / montaggio DONALDSON, altezza 373 mm	DCI6-270	195	265	11/01	>	05/06		S 2764 A		
assembly DONALDSON, height 465 mm / montaggio DONALDSON, altezza 465 mm	DCI6-270	195	265	11/01	>	05/06		S 7357 A		
assembly MANN+HUMMEL / montaggio MANN+HUMMEL	DCI6-270	195	265	11/01	>	05/06		S 2650 A		
assembly STANADYNE / montaggio STANADYNE	DCI6-270	195	265	11/01	>	05/06				
2 filters / N.2 filtri	DCI6-270	195	265	11/01	>	05/06				
power steering / servosterzo	DCI6-270	195	265	11/01	>	05/06			S 3081 PO	
270-18 DCI	DCI6-270	195	265	11/01	>	05/06	S 0900 R		S 3217 C	
with gearbox ZF Ecosplit + Intarder / con cambio ZF Ecosplit + Intarder	DCI6-270	195	265	11/01	>	05/06			S 2234 Z	
dryer filter / filtro essiccatore	DCI6-270	195	265	11/01	>	05/06			S 7344 A	
assembly DONALDSON, height 373 mm / montaggio DONALDSON, altezza 373 mm	DCI6-270	195	265	11/01	>	05/06		S 2764 A		
assembly DONALDSON, height 465 mm / montaggio DONALDSON, altezza 465 mm	DCI6-270	195	265	11/01	>	05/06		S 7357 A		
assembly MANN+HUMMEL / montaggio MANN+HUMMEL	DCI6-270	195	265	11/01	>	05/06		S 2650 A		
assembly STANADYNE / montaggio STANADYNE	DCI6-270	195	265	11/01	>	05/06				
2 filters / N.2 filtri	DCI6-270	195	265	11/01	>	05/06				
power steering / servosterzo	DCI6-270	195	265	11/01	>	05/06			S 3081 PO	
280 DXi	DXi 7 Euro4/5	206	280	05/06	>		S 5097 PE	S 6039 NE		
with filter Urea/Adblue / con filtro Urea/Adblue	DXi 7 Euro4/5	206	280	05/06	>				S 4402 U	
assembly DONALDSON, height 373 mm / montaggio DONALDSON, altezza 373 mm	DXi 7 Euro4/5	206	280	05/06	>			S 7B10 A		
assembly DONALDSON, height 461 mm / montaggio DONALDSON, altezza 461 mm	DXi 7 Euro4/5	206	280	05/06	>			S 7643 A		
assembly DONALDSON, inner / montaggio DONALDSON, interno	DXi 7 Euro4/5	206	280	05/06	>			S 7406 A		
power steering / servosterzo	DXi 7 Euro4/5	206	280	05/06	>				S 3081 PO	
300 DXi	DXi 7 Euro4/5	217	300	07/09	>		S 5097 PE	S 6039 NE		
with filter Urea/Adblue / con filtro Urea/Adblue	DXi 7 Euro4/5	217	300	07/09	>				S 4402 U	
assembly DONALDSON, height 373 mm / montaggio DONALDSON, altezza 373 mm	DXi 7 Euro4/5	217	300	07/09	>			S 7B10 A		
assembly DONALDSON, height 461 mm / montaggio DONALDSON, altezza 461 mm	DXi 7 Euro4/5	217	300	07/09	>			S 7643 A		
assembly DONALDSON, inner / montaggio DONALDSON, interno	DXi 7 Euro4/5	217	300	07/09	>			S 7406 A		
power steering / servosterzo	DXi 7 Euro4/5	217	300	07/09	>				S 3081 PO	
Premium Distribution/Route										
210	MIDR06.02.26W4	154	210	04/96	>	12/01	S 0900 R	S 4323 NR	S 7357 A	S 3217 C
inner / interno	MIDR06.02.26W4	154	210	04/96	>	12/01			S 7406 A	
LONG LIFE	MIDR06.02.26W4	154	210	04/96	>	12/01		S 4471 NR		
power steering / servosterzo	MIDR06.02.26W4	154	210	04/96	>	12/01				S 3081 PO
250	MIDR06.02.45Y41	184	250	04/96	>	12/01	S 0900 R	S 4323 NR	S 7357 A	S 3217 C
inner / interno	MIDR06.02.45Y41	184	250	04/96	>	12/01			S 7406 A	
LONG LIFE	MIDR06.02.45Y41	184	250	04/96	>	12/01		S 4471 NR		
power steering / servosterzo	MIDR06.02.45Y41	184	250	04/96	>	12/01				S 3081 PO
260	MIDR06.20.45C4	188	256	04/96	>	12/01			S 7357 A	S 3217 C
inner / interno	MIDR06.20.45C4	188	256	04/96	>	12/01			S 7406 A	

R

**KW HP****...RENAULT TRUCKS - trucks/autocarri****R**

2 filters / N.2 filtri	MIDR06.20.45C4	188	256	04/96	>	12/01	S 0900 R	S 4323 NR		
2 filters LONG LIFE / N.2 filtri LONG LIFE	MIDR06.20.45C4	188	256	04/96	>	12/01		S 4471 NR		
rotor for oil centrifuge / rotore per filtro olio centrifugo	MIDR06.20.45C4	188	256	04/96	>	12/01	S 5900 PO			
power steering / servosterzo	MIDR06.20.45C4	188	256	04/96	>	12/01				S 3081 PO
300	MIDR06.20.45D41	219	298	04/96	>	12/01			S 7357 A	S 3217 C
inner / interno	MIDR06.20.45D41	219	298	04/96	>	12/01			S 7406 A	
2 filters / N.2 filtri	MIDR06.20.45D41	219	298	04/96	>	12/01	S 0900 R	S 4323 NR		
2 filters LONG LIFE / N.2 filtri LONG LIFE	MIDR06.20.45D41	219	298	04/96	>	12/01		S 4471 NR		
rotor for oil centrifuge / rotore per filtro olio centrifugo	MIDR06.20.45D41	219	298	04/96	>	12/01	S 5900 PO			
power steering / servosterzo	MIDR06.20.45D41	219	298	04/96	>	12/01				S 3081 PO
340	MIDR06.20.45E41	249	338	04/96	>	12/01			S 7357 A	S 3217 C
inner / interno	MIDR06.20.45E41	249	338	04/96	>	12/01			S 7406 A	
2 filters / N.2 filtri	MIDR06.20.45E41	249	338	04/96	>	12/01	S 0900 R	S 4323 NR		
2 filters LONG LIFE / N.2 filtri LONG LIFE	MIDR06.20.45E41	249	338	04/96	>	12/01		S 4471 NR		
power steering / servosterzo	MIDR06.20.45E41	249	338	04/96	>	12/01				S 3081 PO
340 D	MIDR06.20.45E41	249	338	04/96	>	12/01			S 7357 A	S 3217 C
inner / interno	MIDR06.20.45E41	249	338	04/96	>	12/01			S 7406 A	
2 filters / N.2 filtri	MIDR06.20.45E41	249	338	04/96	>	12/01	S 0900 R	S 4323 NR		
2 filters LONG LIFE / N.2 filtri LONG LIFE	MIDR06.20.45E41	249	338	04/96	>	12/01		S 4471 NR		
power steering / servosterzo	MIDR06.20.45E41	249	338	04/96	>	12/01				S 3081 PO
385	MIDR06.23.56A41	280	381	04/96	>	12/01			S 7357 A	S 3217 C
inner / interno	MIDR06.23.56A41	280	381	04/96	>	12/01			S 7406 A	
2 filters / N.2 filtri	MIDR06.23.56A41	280	381	04/96	>	12/01	S 0900 R	S 4323 NR		
2 filters LONG LIFE / N.2 filtri LONG LIFE	MIDR06.23.56A41	280	381	04/96	>	12/01		S 4471 NR		
power steering / servosterzo	MIDR06.23.56A41	280	381	04/96	>	12/01				S 3081 PO
400	MIDR06.23.56B41	287	392	01/99	>	12/01			S 7357 A	S 3217 C
some / alcuni	MIDR06.23.56B41	287	392	01/99	>	12/01			S 7284 A	
some inner / alcuni interno	MIDR06.23.56B41	287	392	01/99	>	12/01			S 7404 A	
inner / interno	MIDR06.23.56B41	287	392	01/99	>	12/01			S 7406 A	
2 filters / N.2 filtri	MIDR06.23.56B41	287	392	01/99	>	12/01	S 0900 R	S 4323 NR		
2 filters LONG LIFE / N.2 filtri LONG LIFE	MIDR06.23.56B41	287	392	01/99	>	12/01		S 4471 NR		
power steering / servosterzo	MIDR06.23.56B41	287	392	01/99	>	12/01				S 3081 PO
HD210	MIDR06.02.26W4	154	210	04/96	>	12/01	S 0900 R	S 4323 NR	S 7357 A	S 3217 C
with automatic gearbox / con cambio automatico	MIDR06.02.26W4	154	210	04/96	>	12/01				S 5238 PE
inner / interno	MIDR06.02.26W4	154	210	04/96	>	12/01			S 7406 A	
LONG LIFE	MIDR06.02.26W4	154	210	04/96	>	12/01		S 4471 NR		
power steering / servosterzo	MIDR06.02.26W4	154	210	04/96	>	12/01				S 3081 PO
HD220 DCI	DCI6-220	158	215	11/01	>	05/06	S 0900 R		S 7357 A	S 3217 C
with automatic gearbox / con cambio automatico	DCI6-220	158	215	11/01	>	05/06				S 5238 PE
inner / interno	DCI6-220	158	215	11/01	>	05/06			S 7406 A	
2 filters / N.2 filtri	DCI6-220	158	215	11/01	>	05/06		S 0712 NR		
power steering / servosterzo	DCI6-220	158	215	11/01	>	05/06				S 3081 PO
dusty areas / zone polverose	DCI6-220	158	215	11/01	>	05/06			S 7284 A	
dusty areas inner / zone polverose interno	DCI6-220	158	215	11/01	>	05/06			S 7404 A	
HD240 DXi	DXi 7 Euro4/5	177	240	05/06	>		S 5097 PE	S 6039 NE		
with automatic gearbox / con cambio automatico	DXi 7 Euro4/5	177	240	05/06	>					S 5238 PE
with filter height 461 mm / con filtro altezza 461 mm	DXi 7 Euro4/5	177	240	05/06	>				S 7643 A	
with filter height 556 mm / con filtro altezza 556 mm	DXi 7 Euro4/5	177	240	05/06	>				S 7645 A	
with filter Urea/Adblue / con filtro Urea/Adblue	DXi 7 Euro4/5	177	240	05/06	>					S 4402 U
dryer filter WABCO, right-hand thread / filtro essiccatore WABCO, filetto destro	DXi 7 Euro4/5	177	240	05/06	>					S 7A66 A
inner height 440 mm / interno altezza 440 mm	DXi 7 Euro4/5	177	240	05/06	>				S 7406 A	
inner height 534 mm / interno altezza 534 mm	DXi 7 Euro4/5	177	240	05/06	>				S 7404 A	
power steering / servosterzo	DXi 7 Euro4/5	177	240	05/06	>					S 3081 PO
HD250	MIDR06.02.45Y41	184	250	04/96	>	12/01	S 0900 R	S 4323 NR	S 7357 A	S 3217 C
with automatic gearbox / con cambio automatico	MIDR06.02.45Y41	184	250	04/06	>	12/01				S 5238 PE
inner / interno	MIDR06.02.45Y41	184	250	04/96	>	12/01			S 7406 A	
LONG LIFE	MIDR06.02.45Y41	184	250	04/96	>	12/01		S 4471 NR		
power steering / servosterzo	MIDR06.02.45Y41	184	250	04/96	>	12/01				S 3081 PO
HD260	MIDR06.20.45C4	188	256	04/96	>	12/01			S 7357 A	S 3217 C
with automatic gearbox / con cambio automatico	MIDR06.20.45C4	188	256	04/96	>	11/01				S 5238 PE
inner / interno	MIDR06.20.45C4	188	256	04/96	>	12/01			S 7406 A	
2 filters / N.2 filtri	MIDR06.20.45C4	188	256	04/96	>	12/01	S 0900 R	S 4323 NR		
2 filters LONG LIFE / N.2 filtri LONG LIFE	MIDR06.20.45C4	188	256	04/96	>	12/01		S 4471 NR		
power steering / servosterzo	MIDR06.20.45C4	188	256	04/96	>	12/01				S 3081 PO
HD270 DCI	DCI6-270	195	265	11/01	>	05/06	S 0900 R		S 7357 A	S 3217 C
with automatic gearbox / con cambio automatico	DCI6-270	195	265	11/01	>	09/06				S 5238 PE
inner / interno	DCI6-270	195	265	11/01	>	05/06			S 7406 A	



...RENAULT TRUCKS - trucks/autocarri

inner / interno	DCI6-270	195	265	11/01	>	05/06			S 7404 A	
2 filters / N.2 filtri	DCI6-270	195	265	11/01	>	05/06		S 0712 NR		
prefilter SEPAR 2000, heated / prefiltra SEPAR 2000 riscaldato	DCI6-270	195	265	11/01	>	05/06		S 6059 NE		
power steering / servosterzo	DCI6-270	195	265	11/01	>	05/06				S 3081 PO
dusty areas / zone polverose	DCI6-270	195	265	11/01	>	05/06	S 0900 R		S 7284 A	
HD270 DXi	DXi 7 Euro4/5	194	264	05/06	>		S 5097 PE	S 6039 NE		
with automatic gearbox / con cambio automatico	DXi 7 Euro4/5	194	264	05/06	>					S 5238 PE
with filter height 461 mm / con filtro altezza 461 mm	DXi 7 Euro4/5	194	264	05/06	>				S 7643 A	
with filter height 556 mm / con filtro altezza 556 mm	DXi 7 Euro4/5	194	264	05/06	>				S 7645 A	
with filter Urea/Adblue / con filtro Urea/Adblue	DXi 7 Euro4/5	194	264	05/06	>					S 4402 U
dryer filter WABCO, right-hand thread / filtro essiccatore WABCO, filetto destro	DXi 7 Euro4/5	194	264	05/06	>					S 7A66 A
inner height 440 mm / interno altezza 440 mm	DXi 7 Euro4/5	194	264	05/06	>				S 7406 A	
inner height 534 mm / interno altezza 534 mm	DXi 7 Euro4/5	194	264	05/06	>				S 7404 A	
power steering / servosterzo	DXi 7 Euro4/5	194	264	05/06	>					S 3081 PO
HD280 DXi	DXi 7 Euro4/5	206	280	05/06	>		S 5097 PE	S 6039 NE		
with filter height 461 mm / con filtro altezza 461 mm	DXi 7 Euro4/5	206	280	05/06	>				S 7643 A	
with filter height 556 mm / con filtro altezza 556 mm	DXi 7 Euro4/5	206	280	05/06	>				S 7645 A	
with filter Urea/Adblue / con filtro Urea/Adblue	DXi 7 Euro4/5	206	280	05/06	>					S 4402 U
dryer filter WABCO, right-hand thread / filtro essiccatore WABCO, filetto destro	DXi 7 Euro4/5	206	280	05/06	>					S 7A66 A
inner height 440 mm / interno altezza 440 mm	DXi 7 Euro4/5	206	280	05/06	>			S 7406 A		
inner height 534 mm / interno altezza 534 mm	DXi 7 Euro4/5	206	280	05/06	>			S 7404 A		
power steering / servosterzo	DXi 7 Euro4/5	206	280	05/06	>					S 3081 PO
HD300	MIDR06.20.45D41	219	298	04/96	>	12/01			S 7357 A	S 3217 C
with automatic gearbox / con cambio automatico	MIDR06.20.45D41	219	298	04/96	>	12/01			S 7406 A	S 5238 PE
inner / interno	MIDR06.20.45D41	219	298	04/96	>	12/01				
2 filters / N.2 filtri	MIDR06.20.45D41	219	298	04/96	>	12/01	S 0900 R	S 4323 NR		
2 filters LONG LIFE / N.2 filtri LONG LIFE	MIDR06.20.45D41	219	298	04/96	>	12/01		S 4471 NR		
power steering / servosterzo	MIDR06.20.45D41	219	298	04/96	>	12/01				S 3081 PO
HD310 DXi	DXi 7 Euro4/5	224	305	05/06	>		S 5097 PE	S 6039 NE		
with automatic gearbox / con cambio automatico	DXi 7 Euro4/5	224	305	05/06	>					S 5238 PE
with filter height 461 mm / con filtro altezza 461 mm	DXi 7 Euro4/5	224	305	05/06	>				S 7643 A	
with filter height 556 mm / con filtro altezza 556 mm	DXi 7 Euro4/5	224	305	05/06	>				S 7645 A	
with filter Urea/Adblue / con filtro Urea/Adblue	DXi 7 Euro4/5	224	305	05/06	>					S 4402 U
dryer filter WABCO, right-hand thread / filtro essiccatore WABCO, filetto destro	DXi 7 Euro4/5	224	305	05/06	>					S 7A66 A
inner height 440 mm / interno altezza 440 mm	DXi 7 Euro4/5	224	305	05/06	>			S 7406 A		
inner height 534 mm / interno altezza 534 mm	DXi 7 Euro4/5	224	305	05/06	>			S 7404 A		
power steering / servosterzo	DXi 7 Euro4/5	224	305	05/06	>					S 3081 PO
HD320 DCI	DCI6-320	229	311	11/01	>	05/06			S 7357 A	S 3217 C
with automatic gearbox / con cambio automatico	DCI6-320	229	311	11/01	>	09/06				S 5238 PE
inner / interno	DCI6-320	229	311	11/01	>	05/06			S 7406 A	
2 filters / N.2 filtri	DCI6-320	229	311	11/01	>	05/06	S 0900 R	S 0712 NR		
power steering / servosterzo	DCI6-320	229	311	11/01	>	05/06				S 3081 PO
dusty areas / zone polverose	DCI6-320	229	311	11/01	>	05/06			S 7284 A	
dusty areas inner / zone polverose interno	DCI6-320	229	311	11/01	>	05/06			S 7404 A	
HD320 DXi	DXi 7 Euro4/5	235	320	05/06	>		S 5097 PE	S 6039 NE		
with filter height 461 mm / con filtro altezza 461 mm	DXi 7 Euro4/5	235	320	05/06	>				S 7643 A	
with filter height 556 mm / con filtro altezza 556 mm	DXi 7 Euro4/5	235	320	05/06	>				S 7645 A	
with filter Urea/Adblue / con filtro Urea/Adblue	DXi 7 Euro4/5	235	320	05/06	>					S 4402 U
dryer filter WABCO, right-hand thread / filtro essiccatore WABCO, filetto destro	DXi 7 Euro4/5	235	320	05/06	>					S 7A66 A
inner height 440 mm / interno altezza 440 mm	DXi 7 Euro4/5	235	320	05/06	>			S 7406 A		
inner height 534 mm / interno altezza 534 mm	DXi 7 Euro4/5	235	320	05/06	>			S 7404 A		
power steering / servosterzo	DXi 7 Euro4/5	235	320	05/06	>					S 3081 PO
HD340	MIDR06.20.45E41	249	338	04/96	>	12/01			S 7357 A	S 3217 C
with automatic gearbox / con cambio automatico	MIDR06.20.45E41	249	338	04/96	>	12/01				S 5238 PE
inner / interno	MIDR06.20.45E41	249	338	04/96	>	12/01			S 7406 A	
2 filters / N.2 filtri	MIDR06.20.45E41	249	338	04/96	>	12/01	S 0900 R	S 4323 NR		
2 filters LONG LIFE / N.2 filtri LONG LIFE	MIDR06.20.45E41	249	338	04/96	>	12/01		S 4471 NR		
power steering / servosterzo	MIDR06.20.45E41	249	338	04/96	>	12/01				S 3081 PO
HD340 DXi	DXi 7 Euro4/5	247	336	05/06	>		S 5097 PE	S 6039 NE		
with automatic gearbox / con cambio automatico	DXi 7 Euro4/5	247	336	05/06	>					S 5238 PE
with filter height 461 mm / con filtro altezza 461 mm	DXi 7 Euro4/5	247	336	05/06	>				S 7643 A	
with filter height 556 mm / con filtro altezza 556 mm	DXi 7 Euro4/5	247	336	05/06	>				S 7645 A	
with filter Urea/Adblue / con filtro Urea/Adblue	DXi 7 Euro4/5	247	336	05/06	>					S 4402 U
dryer filter WABCO, right-hand thread / filtro essiccatore WABCO, filetto destro	DXi 7 Euro4/5	247	336	05/06	>					S 7A66 A
inner height 440 mm / interno altezza 440 mm	DXi 7 Euro4/5	247	336	05/06	>			S 7406 A		
inner height 534 mm / interno altezza 534 mm	DXi 7 Euro4/5	247	336	05/06	>			S 7404 A		
power steering / servosterzo	DXi 7 Euro4/5	247	336	05/06	>					S 3081 PO

R



...RENAULT TRUCKS - trucks/autocarri

R

HD370 DCI	dCi 11-370	266	361	11/01	>	05/06			S 7357 A	S 3217 C
with automatic gearbox / con cambio automatico	dCi 11-370	266	361	11/01	>	05/06				S 5238 PE
dryer filter WABCO, right-hand thread / filtro essiccatore WABCO, filetto destro	dCi 11-370	266	361	11/01	>	05/06				S 7A66 A
inner / interno	dCi 11-370	266	361	11/01	>	05/06			S 7406 A	
2 filters / N.2 filtri	dCi 11-370	266	361	11/01	>	05/06		S 0712 NR		
prefilter SEPAR 2000, heated / prefilto SEPAR 2000 riscaldato	dCi 11-370	266	361	11/01	>	05/06		S 6059 NE		
rotor for oil centrifuge / rotore per filtro olio centrifugo	dCi 11-370	266	361	11/01	>	05/06	S 5903 PO			
power steering / servosterzo	dCi 11-370	266	361	11/01	>	05/06				S 3081 PO
dusty areas / zone polverose	dCi 11-370	266	361	11/01	>	05/06			S 7284 A	
dusty areas inner / zone polverose interno	dCi 11-370	266	361	11/01	>	05/06			S 7404 A	
HD370 DXi	DXi 11 Euro4/5	272	370	05/06	>			S 9320 NR	S 7643 A	
by-pass	DXi 11 Euro4/5	272	370	05/06	>		S 4120 R			
with filter Urea/Adblue / con filtro Urea/Adblue	DXi 11 Euro4/5	272	370	05/06	>					S 4402 U
dryer filter WABCO, right-hand thread / filtro essiccatore WABCO, filetto destro	DXi 11 Euro4/5	272	370	05/06	>					S 7A66 A
inner / interno	DXi 11 Euro4/5	272	370	05/06	>				S 7406 A	
LONG LIFE	DXi 11 Euro4/5	272	370	05/06	>			S 4120 NR		
2 filters / N.2 filtri	DXi 11 Euro4/5	272	370	05/06	>		S 4402 R			
prefilter short filter / prefilto filtro corto	DXi 11 Euro4/5	272	370	05/06	>			S 4157 NR		
prefilter long filter / prefilto filtro lungo	DXi 11 Euro4/5	272	370	05/06	>			S 4146 NR		
power steering / servosterzo	DXi 11 Euro4/5	272	370	06/06	>					S 3081 PO
HD380 DXi	DXi 11 Euro4/5	280	381	05/06	>			S 9320 NR	S 7643 A	
by-pass	DXi 11 Euro4/5	280	381	05/06	>		S 4120 R			
with automatic gearbox / con cambio automatico	DXi 11 Euro4/5	280	381	10/05	>					S 5238 PE
with filter Urea/Adblue / con filtro Urea/Adblue	DXi 11 Euro4/5	280	381	05/06	>					S 4402 U
dryer filter WABCO, right-hand thread / filtro essiccatore WABCO, filetto destro	DXi 11 Euro4/5	280	381	05/06	>					S 7A66 A
inner / interno	DXi 11 Euro4/5	280	381	05/06	>				S 7406 A	
LONG LIFE	DXi 11 Euro4/5	280	381	05/06	>			S 4120 NR		
2 filters / N.2 filtri	DXi 11 Euro4/5	280	381	05/06	>		S 4402 R			
prefilter short filter / prefilto filtro corto	DXi 11 Euro4/5	280	381	05/06	>			S 4157 NR		
prefilter long filter / prefilto filtro lungo	DXi 11 Euro4/5	280	381	05/06	>			S 4146 NR		
power steering / servosterzo	DXi 11 Euro4/5	280	381	05/06	>					S 3081 PO
HD410 DXi	DXi 11 Euro4/5	302	410	05/06	>			S 9320 NR	S 7643 A	
by-pass	DXi 11 Euro4/5	302	410	05/06	>		S 4120 R			
with automatic gearbox / con cambio automatico	DXi 11 Euro4/5	302	410	05/06	>					S 5238 PE
with filter Urea/Adblue / con filtro Urea/Adblue	DXi 11 Euro4/5	302	410	05/06	>					S 4402 U
dryer filter WABCO, right-hand thread / filtro essiccatore WABCO, filetto destro	DXi 11 Euro4/5	302	410	05/06	>					S 7A66 A
inner / interno	DXi 11 Euro4/5	302	410	05/06	>				S 7406 A	
LONG LIFE	DXi 11 Euro4/5	302	410	05/06	>			S 4120 NR		
2 filters / N.2 filtri	DXi 11 Euro4/5	302	410	05/06	>		S 4402 R			
prefilter short filter / prefilto filtro corto	DXi 11 Euro4/5	302	410	05/06	>			S 4157 NR		
prefilter long filter / prefilto filtro lungo	DXi 11 Euro4/5	302	410	05/06	>			S 4146 NR		
power steering / servosterzo	DXi 11 Euro4/5	302	410	05/06	>					S 3081 PO
HD420 DCI	dCi 11B-43	303	412	05/00	>	05/06			S 7357 A	S 3217 C
with automatic gearbox / con cambio automatico	dCi 11B-43	303	412	05/00	>	05/06				S 5238 PE
inner / interno	dCi 11B-43	303	412	05/00	>	05/06			S 7406 A	
2 filters / N.2 filtri	dCi 11B-43	303	412	05/00	>	05/06	S 0900 R	S 0712 NR		
prefilter SEPAR 2000 heated / prefilto SEPAR 2000 riscaldato	dCi 11B-43	303	412	05/00	>	05/06		S 6059 NE		
rotor for oil centrifuge / rotore per filtro olio centrifugo	dCi 11B-43	303	412	05/00	>	05/06	S 5903 PO			
power steering / servosterzo	dCi 11B-43	303	412	05/00	>	05/06				S 3081 PO
HD430 DXi	DXi 11 Euro4/5	316	430	05/06	>			S 9320 NR	S 7643 A	
by-pass	DXi 11 Euro4/5	316	430	05/06	>		S 4120 R			
with automatic gearbox / con cambio automatico	DXi 11 Euro4/5	316	430	06/09	>					S 5238 PE
with filter Urea/Adblue / con filtro Urea/Adblue	DXi 11 Euro4/5	316	430	05/06	>					S 4402 U
dryer filter / filtro essiccatore	DXi 11 Euro4/5	316	430	05/06	>					S 7A66 A
inner / interno	DXi 11 Euro4/5	316	430	05/06	>				S 7406 A	
LONG LIFE	DXi 11 Euro4/5	316	430	05/06	>			S 4120 NR		
2 filters / N.2 filtri	DXi 11 Euro4/5	316	430	05/06	>		S 4402 R			
prefilter short filter / prefilto filtro corto	DXi 11 Euro4/5	316	430	05/06	>			S 4157 NR		
prefilter long filter / prefilto filtro lungo	DXi 11 Euro4/5	316	430	05/06	>			S 4146 NR		
power steering / servosterzo	DXi 11 Euro4/5	316	430	06/06	>					S 3081 PO
HD450 DXi	DXi 11 Euro4/5	331	450	05/06	>			S 9320 NR	S 7643 A	
by-pass	DXi 11 Euro4/5	331	450	05/06	>		S 4120 R			
with automatic gearbox / con cambio automatico	DXi 11 Euro4/5	331	450	05/06	>					S 5238 PE
with filter Urea/Adblue / con filtro Urea/Adblue	DXi 11 Euro4/5	331	450	05/06	>					S 4402 U
dryer filter / filtro essiccatore	DXi 11 Euro4/5	331	450	05/06	>					S 7A66 A
inner / interno	DXi 11 Euro4/5	331	450	05/06	>				S 7406 A	
LONG LIFE	DXi 11 Euro4/5	331	450	05/06	>			S 4120 NR		



...RENAULT TRUCKS - trucks/autocarri

2 filters / N.2 filtri	DXi 11 Euro4/5	331	450	05/06	>	S 4402 R			
prefilter short filter / prefiltro filtro corto	DXi 11 Euro4/5	331	450	05/06	>		S 4157 NR		
prefilter long filter / prefiltro filtro lungo	DXi 11 Euro4/5	331	450	05/06	>		S 4146 NR		
power steering / servosterzo	DXi 11 Euro4/5	331	450	05/06	>				S 3081 PO
HD460 DXi	DXi 11 Euro4/5	339	460	05/06	>		S 9320 NR	S 7643 A	
by-pass	DXi 11 Euro4/5	339	460	05/06	>	S 4120 R			
with automatic gearbox / con cambio automatico	DXi 11 Euro4/5	339	460	06/09	>				S 5238 PE
with filter Urea/Adblue / con filtro Urea/Adblue	DXi 11 Euro4/5	339	460	05/06	>				S 4402 U
dryer filter / filtro essiccatore	DXi 11 Euro4/5	339	460	05/06	>				S 7A66 A
inner / interno	DXi 11 Euro4/5	339	460	05/06	>			S 7406 A	
LONG LIFE	DXi 11 Euro4/5	339	460	05/06	>		S 4120 NR		
2 filters / N.2 filtri	DXi 11 Euro4/5	339	460	05/06	>	S 4402 R			
prefilter short filter / prefiltro filtro corto	DXi 11 Euro4/5	339	460	05/06	>		S 4157 NR		
prefilter long filter / prefiltro filtro lungo	DXi 11 Euro4/5	339	460	05/06	>		S 4146 NR		
power steering / servosterzo	DXi 11 Euro4/5	339	460	06/06	>				S 3081 PO
HR300	MIDR06.20.45D41	219	298	04/96	> 12/01			S 7357 A	S 3217 C
inner / interno	MIDR06.20.45D41	219	298	04/96	> 12/01			S 7406 A	
2 filters / N.2 filtri	MIDR06.20.45D41	219	298	04/96	> 12/01	S 0900 R	S 4323 NR		
2 filters LONG LIFE / N.2 filtri LONG LIFE	MIDR06.20.45D41	219	298	04/96	> 12/01		S 4471 NR		
power steering / servosterzo	MIDR06.20.45D41	219	298	04/96	> 12/01				S 3081 PO
HR320 DCI	dCi 11-320	229	311	11/01	> 05/06			S 7357 A	S 3217 C
with automatic gearbox / con cambio automatico	dCi 11-320	229	311	11/01	> 05/06				S 5238 PE
dryer filter WABCO, right-hand thread / filtro essiccatore WABCO, filetto destro	dCi 11-320	229	311	11/06	> 05/06				S 7A66 A
inner / interno	dCi 11-320	229	311	11/01	> 05/06			S 7406 A	
2 filters / N.2 filtri	dCi 11-320	229	311	11/01	> 05/06		S 0712 NR		
prefilter SEPAR 2000, heated / prefiltro SEPAR 2000 riscaldato	dCi 11-320	229	311	11/06	> 05/06		S 6059 NE		
rotor for oil centrifuge / rotore per filtro olio centrifugo	dCi 11-320	229	311	11/01	> 05/06	S 5903 PO			
power steering / servosterzo	dCi 11-320	229	311	11/01	> 05/06				S 3081 PO
dusty areas / zone polverose	dCi 11-320	229	311	11/01	> 05/06			S 7284 A	
dusty areas inner / zone polverose interno	dCi 11-320	229	311	11/01	> 05/06			S 7404 A	
HR330 DXi	DXi 11	243	330	10/05	> 04/06		S 9320 NR	S 7643 A	S 3217 C
	DXi 11	243	330	05/06	>		S 9320 NR	S 7643 A	
by-pass	DXi 11	243	330	10/05	>	S 4120 R			
with automatic gearbox / con cambio automatico	DXi 11	243	330	10/05	>				S 5238 PE
dryer filter WABCO, right-hand thread / filtro essiccatore WABCO, filetto destro	DXi 11	243	330	10/05	>				S 7A66 A
inner / interno	DXi 11	243	330	10/05	>			S 7406 A	
LONG LIFE	DXi 11	243	330	10/05	>		S 4120 NR		
2 filters / N.2 filtri	DXi 11	243	330	10/05	>	S 4402 R			
prefilter short filter / prefiltro filtro corto	DXi 11	243	330	10/05	>		S 4157 NR		
prefilter long filter / prefiltro filtro lungo	DXi 11	243	330	10/05	>		S 4146 NR		
power steering / servosterzo	DXi 11	243	330	10/05	>				S 3081 PO
HR340	MIDR06.20.45	249	338	04/96	> 12/01			S 7357 A	S 3217 C
with automatic gearbox / con cambio automatico	MIDR06.20.45	249	338	04/96	> 12/01				S 5238 PE
inner / interno	MIDR06.20.45	249	338	04/96	> 12/01			S 7406 A	
2 filters / N.2 filtri	MIDR06.20.45	249	338	04/96	> 12/01	S 0900 R	S 4323 NR		
2 filters LONG LIFE / N.2 filtri LONG LIFE	MIDR06.20.45	249	338	04/96	> 12/01		S 4471 NR		
power steering / servosterzo	MIDR06.20.45	249	338	04/96	> 12/01				S 3081 PO
HR370 DCI	dCi 11-370	266	361	11/01	> 05/06			S 7357 A	S 3217 C
with automatic gearbox / con cambio automatico	dCi 11-370	266	361	11/01	> 05/06				S 5238 PE
dryer filter / filtro essiccatore	dCi 11-370	266	361	11/01	> 05/06				S 7A66 A
inner / interno	dCi 11-370	266	361	11/01	> 05/06			S 7406 A	
2 filters / N.2 filtri	dCi 11-370	266	361	11/01	> 05/06		S 0712 NR		
prefilter SEPAR 2000, heated / prefiltro SEPAR 2000 riscaldato	dCi 11-370	266	361	11/01	> 05/06		S 6059 NE		
rotor for oil centrifuge / rotore per filtro olio centrifugo	dCi 11-370	266	361	11/01	> 05/06	S 5903 PO			
power steering / servosterzo	dCi 11-370	266	361	11/01	> 05/06				S 3081 PO
dusty areas / zone polverose	dCi 11-370	266	361	11/01	> 05/06			S 7284 A	
dusty areas inner / zone polverose interno	dCi 11-370	266	361	11/01	> 05/06			S 7404 A	
HR370 DXi	DXi 11 Euro4/5	272	370	05/06	>		S 9320 NR	S 7643 A	
by-pass	DXi 11 Euro4/5	272	370	05/06	>	S 4120 R			
with automatic gearbox / con cambio automatico	DXi 11 Euro4/5	272	370	05/06	>				S 5238 PE
dryer filter WABCO, right-hand thread / filtro essiccatore WABCO, filetto destro	DXi 11 Euro4/5	272	370	05/06	>				S 7A66 A
inner / interno	DXi 11 Euro4/5	272	370	05/06	>			S 7406 A	
LONG LIFE	DXi 11 Euro4/5	272	370	05/06	>		S 4120 NR		
2 filters / N.2 filtri	DXi 11 Euro4/5	272	370	05/06	>	S 4402 R			
prefilter short filter / prefiltro filtro corto	DXi 11 Euro4/5	272	370	05/06	>		S 4157 NR		
prefilter long filter / prefiltro filtro lungo	DXi 11 Euro4/5	272	370	05/06	>		S 4146 NR		
power steering / servosterzo	DXi 11 Euro4/5	272	370	05/06	>				S 3081 PO

R



...RENAULT TRUCKS - trucks/autocarri

R

HR380 DXi	DXi 11	279	380	10/05	>		S 9320 NR	S 7643 A	
	DXi 11	279	380	10/05	>	04/06	S 9320 NR	S 7643 A	S 3217 C
	by-pass	DXi 11	279	380	10/05	>	S 4120 R		
	with automatic gearbox / con cambio automatico	DXi 11	279	380	10/05	>			S 5238 PE
	dryer filter WABCO, right-hand thread / filtro essiccatore WABCO, filetto destro	DXi 11	279	380	10/05	>			S 7A66 A
	inner / interno	DXi 11	279	380	10/05	>		S 7406 A	
	LONG LIFE	DXi 11	279	380	10/05	>	S 4120 NR		
	2 filters / N.2 filtri	DXi 11	279	380	10/05	>	S 4402 R		
	prefilter short filter / prefiltra filtro corto	DXi 11	279	380	10/05	>	S 4157 NR		
	prefilter long filter / prefiltra filtro lungo	DXi 11	279	380	10/05	>	S 4146 NR		
	power steering / servosterzo	DXi 11	279	380	10/05	>			S 3081 PO
HR385	MIDR06.23.56A41	280	381	04/96	>	12/01		S 7357 A	S 3217 C
	with automatic gearbox / con cambio automatico	MIDR06.23.56A41	280	381	04/96	>	12/01		S 5238 PE
	inner / interno	MIDR06.23.56A41	280	381	04/96	>	12/01	S 7406 A	
	2 filters / N.2 filtri	MIDR06.23.56A41	280	381	04/96	>	12/01	S 0900 R	S 4323 NR
	2 filters LONG LIFE / N.2 filtri LONG LIFE	MIDR06.23.56A41	280	381	04/96	>	12/01	S 4471 NR	
power steering / servosterzo	MIDR06.23.56A41	280	381	04/96	>	12/01		S 3081 PO	
HR400	MIDR06.23.56B41	287	392	01/99	>	12/01		S 7357 A	S 3217 C
	some / alcuni	MIDR06.23.56B41	287	392	01/99	>	12/01		S 7284 A
	some inner / alcuni interno	MIDR06.23.56B41	287	392	01/99	>	12/01		S 7404 A
	with automatic gearbox / con cambio automatico	MIDR06.23.56B41	287	392	01/99	>	12/01		S 5238 PE
	inner / interno	MIDR06.23.56B41	287	392	01/99	>	12/01	S 7406 A	
	2 filters / N.2 filtri	MIDR06.23.56B41	287	392	01/99	>	12/01	S 0900 R	S 4323 NR
2 filters LONG LIFE / N.2 filtri LONG LIFE	MIDR06.23.56B41	287	392	01/99	>	12/01	S 4471 NR		
power steering / servosterzo	MIDR06.23.56B41	287	392	01/99	>	12/01		S 3081 PO	
HR410 DXi	DXi 11 Euro4/5	302	410	05/06	>		S 9320 NR	S 7643 A	
	by-pass	DXi 11 Euro4/5	302	410	05/06	>	S 4120 R		
	with automatic gearbox / con cambio automatico	DXi 11 Euro4/5	302	410	05/06	>			S 5238 PE
	dryer filter WABCO, right-hand thread / filtro essiccatore WABCO, filetto destro	DXi 11 Euro4/5	302	410	05/06	>			S 7A66 A
	inner / interno	DXi 11 Euro4/5	302	410	05/06	>		S 7406 A	
	LONG LIFE	DXi 11 Euro4/5	302	410	05/06	>	S 4120 NR		
	2 filters / N.2 filtri	DXi 11 Euro4/5	302	410	05/06	>	S 4402 R		
	prefilter short filter / prefiltra filtro corto	DXi 11 Euro4/5	302	410	05/06	>	S 4157 NR		
	prefilter long filter / prefiltra filtro lungo	DXi 11 Euro4/5	302	410	05/06	>	S 4146 NR		
	power steering / servosterzo	DXi 11 Euro4/5	302	410	05/06	>			S 3081 PO
	HR420 DCi	dCi 11B-43	303	412	05/00	>	05/06		S 7357 A
with automatic gearbox / con cambio automatico		dCi 11B-43	303	412	05/00	>	05/06		S 5238 PE
inner / interno		dCi 11B-43	303	412	05/00	>	05/06	S 7406 A	
2 filters / N.2 filtri		dCi 11B-43	303	412	05/00	>	05/06	S 0900 R	S 0712 NR
prefilter SEPAR 2000 heated / prefiltra SEPAR 2000 riscaldato		dCi 11B-43	303	412	05/00	>	05/06	S 6059 NE	
rotor for oil centrifuge / rotore per filtro olio centrifugo		dCi 11B-43	303	412	05/00	>	05/06	S 5903 PO	
power steering / servosterzo	dCi 11B-43	303	412	05/00	>	05/06		S 3081 PO	
HR430 DXi	DXi 11 Euro4/5	316	430	06/09	>		S 9320 NR	S 7643 A	
	by-pass	DXi 11 Euro4/5	316	430	06/09	>	S 4120 R		
	with automatic gearbox / con cambio automatico	DXi 11 Euro4/5	316	430	06/09	>			S 5238 PE
	dryer filter / filtro essiccatore	DXi 11 Euro4/5	316	430	06/09	>			S 7A66 A
	inner / interno	DXi 11 Euro4/5	316	430	06/09	>		S 7406 A	
	LONG LIFE	DXi 11 Euro4/5	316	430	06/09	>	S 4120 NR		
	2 filters / N.2 filtri	DXi 11 Euro4/5	316	430	06/09	>	S 4402 R		
	prefilter short filter / prefiltra filtro corto	DXi 11 Euro4/5	316	430	06/09	>	S 4157 NR		
	prefilter long filter / prefiltra filtro lungo	DXi 11 Euro4/5	316	430	06/09	>	S 4146 NR		
	power steering / servosterzo	DXi 11 Euro4/5	316	430	06/09	>			S 3081 PO
	HR440 DXi	DXi 11 Euro3/4/5	324	436	10/05	>	04/06	S 9320 NR	S 7643 A
DXi 11 Euro3/4/5		324	436	05/06	>		S 9320 NR	S 7643 A	
by-pass		DXi 11 Euro3/4/5	324	436	10/05	>	S 4120 R		
with automatic gearbox / con cambio automatico		DXi 11 Euro3/4/5	324	436	10/05	>			S 5238 PE
dryer filter WABCO, right-hand thread / filtro essiccatore WABCO, filetto destro		DXi 11 Euro3/4/5	324	436	10/05	>			S 7A66 A
inner / interno		DXi 11 Euro3/4/5	324	436	10/05	>		S 7406 A	
LONG LIFE		DXi 11 Euro3/4/5	324	436	10/05	>	S 4120 NR		
2 filters / N.2 filtri		DXi 11 Euro3/4/5	324	436	10/05	>	S 4402 R		
prefilter short filter / prefiltra filtro corto		DXi 11 Euro3/4/5	324	436	10/05	>	S 4157 NR		
prefilter long filter / prefiltra filtro lungo		DXi 11 Euro3/4/5	324	436	10/05	>	S 4146 NR		
power steering / servosterzo		DXi 11 Euro3/4/5	324	436	10/05	>			S 3081 PO
HR450 DXi	DXi 11 Euro4/5	331	450	05/06	>		S 9320 NR	S 7643 A	
	by-pass	DXi 11 Euro4/5	331	450	05/06	>	S 4120 R		
	with automatic gearbox / con cambio automatico	DXi 11 Euro4/5	331	450	05/06	>			S 5238 PE
	dryer filter WABCO, right-hand thread / filtro essiccatore WABCO, filetto destro	DXi 11 Euro4/5	331	450	05/06	>			S 7A66 A

**KW HP****...RENAULT TRUCKS - trucks/autocarri**

inner / interno	DXi 11 Euro4/5	331 450	05/06 >			S 4120 NR	S 7406 A	
LONG LIFE	DXi 11 Euro4/5	331 450	05/06 >					
2 filters / N.2 filtri	DXi 11 Euro4/5	331 450	05/06 >		S 4402 R			
prefilter short filter / prefilto filtro corto	DXi 11 Euro4/5	331 450	05/06 >			S 4157 NR		
prefilter long filter / prefilto filtro lungo	DXi 11 Euro4/5	331 450	05/06 >			S 4146 NR		
power steering / servosterzo	DXi 11 Euro4/5	331 450	05/06 >					S 3081 PO
HR460 DXi	DXi 11 Euro4/5	339 460	06/09 >			S 9320 NR	S 7643 A	
by-pass	DXi 11 Euro4/5	339 460	06/09 >		S 4120 R			
with automatic gearbox / con cambio automatico	DXi 11 Euro4/5	339 460	06/09 >					S 5238 PE
dryer filter WABCO, right-hand thread / filtro essiccatore WABCO, filetto destro	DXi 11 Euro4/5	339 460	06/09 >					S 7A66 A
inner / interno	DXi 11 Euro4/5	339 460	06/09 >				S 7406 A	
LONG LIFE	DXi 11 Euro4/5	339 460	06/09 >			S 4120 NR		
2 filters / N.2 filtri	DXi 11 Euro4/5	339 460	06/09 >		S 4402 R			
prefilter short filter / prefilto filtro corto	DXi 11 Euro4/5	339 460	06/09 >			S 4157 NR		
prefilter long filter / prefilto filtro lungo	DXi 11 Euro4/5	339 460	06/09 >			S 4146 NR		
power steering / servosterzo	DXi 11 Euro4/5	339 460	06/09 >					S 3081 PO
Premium Lander								
HL270 DCI	DCI6-270	195 265	02/04 > 04/06		S 0900 R		S 7357 A	S 3217 C
	DCI6-270	195 265	05/06 >		S 0900 R		S 7357 A	
with automatic gearbox / con cambio automatico	DCI6-270	195 265	02/04 >					S 5238 PE
dryer filter WABCO, right-hand thread / filtro essiccatore WABCO, filetto destro	DCI6-270	195 265	02/04 >					S 7A66 A
inner / interno	DCI6-270	195 265	02/04 >				S 7406 A	
2 filters / N.2 filtri	DCI6-270	195 265	02/04 >			S 0712 NR		
rotor for oil centrifuge / rotore per filtro olio centrifugo	DCI6-270	195 265	02/04 >		S 5903 PO			
power steering / servosterzo	DCI6-270	195 265	02/04 >					S 3081 PO
dusty areas / zone polverose	DCI6-270	195 265	02/04 >				S 7284 A	
dusty areas inner / zone polverose interno	DCI6-270	195 265	02/04 >				S 7404 A	
HL270 DXi	DXi 7 Euro4/5	194 264	05/06 >		S 5097 PE	S 6039 NE		
with automatic gearbox / con cambio automatico	DXi 7 Euro4/5	194 264	05/06 >					S 5238 PE
with filter height 461 mm / con filtro altezza 461 mm	DXi 7 Euro4/5	194 264	05/06 >				S 7643 A	
with filter height 556 mm / con filtro altezza 556 mm	DXi 7 Euro4/5	194 264	05/06 >				S 7645 A	
with filter Urea/Adblue / con filtro Urea/Adblue	DXi 7 Euro4/5	194 264	05/06 >					S 4402 U
dryer filter WABCO, right-hand thread / filtro essiccatore WABCO, filetto destro	DXi 7 Euro4/5	194 264	05/06 >					S 7A66 A
inner height 440 mm / interno altezza 440 mm	DXi 7 Euro4/5	194 264	05/06 >				S 7406 A	
inner height 534 mm / interno altezza 534 mm	DXi 7 Euro4/5	194 264	05/06 >				S 7404 A	
power steering / servosterzo	DXi 7 Euro4/5	194 264	05/06 >					S 3081 PO
HL310 DXi	DXi 7 Euro4/5	224 305	05/06 >		S 5097 PE	S 6039 NE		
with automatic gearbox / con cambio automatico	DXi 7 Euro4/5	224 305	05/06 >					S 5238 PE
with filter height 461 mm / con filtro altezza 461 mm	DXi 7 Euro4/5	224 305	05/06 >				S 7643 A	
with filter height 556 mm / con filtro altezza 556 mm	DXi 7 Euro4/5	224 305	05/06 >				S 7645 A	
with filter Urea/Adblue / con filtro Urea/Adblue	DXi 7 Euro4/5	224 305	05/06 >					S 4402 U
dryer filter WABCO, right-hand thread / filtro essiccatore WABCO, filetto destro	DXi 7 Euro4/5	224 305	05/06 >					S 7A66 A
inner height 440 mm / interno altezza 440 mm	DXi 7 Euro4/5	224 305	05/06 >				S 7406 A	
inner height 534 mm / interno altezza 534 mm	DXi 7 Euro4/5	224 305	05/06 >				S 7404 A	
power steering / servosterzo	DXi 7 Euro4/5	224 305	05/06 >					S 3081 PO
HL320 DCI	DCI11-320	229 311	02/04 >				S 7357 A	
	DCI11-320	229 311	02/04 > 04/06					S 3217 C
with automatic gearbox / con cambio automatico	DCI11-320	229 311	02/04 >					S 5238 PE
with filter SEPAR 2000, heated / con filtro SEPAR 2000, riscaldato	DCI11-320	229 311	02/04 >			S 6059 NE		
dryer filter WABCO, right-hand thread / filtro essiccatore WABCO, filetto destro	DCI11-320	229 311	02/04 >					S 7A66 A
inner / interno	DCI11-320	229 311	02/04 >				S 7406 A	
2 filters / N.2 filtri	DCI11-320	229 311	02/04 >		S 0900 R	S 0712 NR		
rotor for oil centrifuge / rotore per filtro olio centrifugo	DCI11-320	229 311	02/04 >		S 5903 PO			
power steering / servosterzo	DCI11-320	229 311	02/04 >					S 3081 PO
dusty areas / zone polverose	DCI11-320	229 311	02/04 >				S 7284 A	
dusty areas inner / zone polverose interno	DCI11-320	229 311	02/04 >				S 7404 A	
HL340 DXi	DXi 7 Euro4/5	247 336	05/06 >		S 5097 PE	S 6039 NE		
with automatic gearbox / con cambio automatico	DXi 7 Euro4/5	247 336	05/06 >					S 5238 PE
with filter height 461 mm / con filtro altezza 461 mm	DXi 7 Euro4/5	247 336	05/06 >				S 7643 A	
with filter height 556 mm / con filtro altezza 556 mm	DXi 7 Euro4/5	247 336	05/06 >				S 7645 A	
with filter Urea/Adblue / con filtro Urea/Adblue	DXi 7 Euro4/5	247 336	05/06 >					S 4402 U
dryer filter WABCO, right-hand thread / filtro essiccatore WABCO, filetto destro	DXi 7 Euro4/5	247 336	05/06 >					S 7A66 A
inner height 440 mm / interno altezza 440 mm	DXi 7 Euro4/5	247 336	05/06 >				S 7406 A	
inner height 534 mm / interno altezza 534 mm	DXi 7 Euro4/5	247 336	05/06 >				S 7404 A	
power steering / servosterzo	DXi 7 Euro4/5	247 336	05/06 >					S 3081 PO
HL370 DCI	DCI11-370	266 361	02/04 > 04/06				S 7357 A	S 3217 C
	DCI11-370	266 361	05/06 >				S 7357 A	

R



KW HP



...RENAULT TRUCKS - trucks/autocarri

R



with automatic gearbox / con cambio automatico	DCI11-370	266	361	02/04	>			S 5238 PE
with filter SEPAR 2000, heated / con filtro SEPAR 2000, riscaldato	DCI11-370	266	361	02/04	>		S 6059 NE	
dryer filter WABCO, right-hand thread / filtro essiccatore WABCO, filetto destro	DCI11-370	266	361	02/04	>			S 7A66 A
inner / interno	DCI11-370	266	361	02/04	>		S 7406 A	
2 filters / N.2 filtri	DCI11-370	266	361	02/04	>	S 0900 R	S 0712 NR	
rotor for oil centrifuge / rotore per filtro olio centrifugo	DCI11-370	266	361	02/04	>	S 5903 PO		
power steering / servosterzo	DCI11-370	266	361	02/04	>			S 3081 PO
dusty areas / zone polverose	DCI11-370	266	361	02/04	>			S 7284 A
dusty areas inner / zone polverose interno	DCI11-370	266	361	02/04	>			S 7404 A
HL370 DXi	DXi 11 Euro4/5	272	370	05/06	>		S 9320 NR	S 7643 A
by-pass	DXi 11 Euro4/5	272	370	05/06	>	S 4120 R		
with automatic gearbox / con cambio automatico	DXi 11 Euro4/5	272	370	05/06	>			S 5238 PE
with filter Urea/Adblue / con filtro Urea/Adblue	DXi 11 Euro4/5	272	370	05/06	>			S 4402 U
dryer filter WABCO, right-hand thread / filtro essiccatore WABCO, filetto destro	DXi 11 Euro4/5	272	370	05/06	>			S 7A66 A
inner / interno	DXi 11 Euro4/5	272	370	05/06	>			S 7406 A
LONG LIFE	DXi 11 Euro4/5	272	370	05/06	>		S 4120 NR	
2 filters / N.2 filtri	DXi 11 Euro4/5	272	370	05/06	>	S 4402 R		
prefilter short filter / prefilto filtro corto	DXi 11 Euro4/5	272	370	05/06	>		S 4157 NR	
prefilter long filter / prefilto filtro lungo	DXi 11 Euro4/5	272	370	05/06	>		S 4146 NR	
power steering / servosterzo	DXi 11 Euro4/5	272	370	05/06	>			S 3081 PO
HL380 DXi	DXi 11 Euro 4/5	280	381	06/09	>		S 9320 NR	S 7643 A
by-pass	DXi 11 Euro 4/5	280	381	06/09	>	S 4120 R		
with automatic gearbox / con cambio automatico	DXi 11 Euro 4/5	280	381	06/09	>			S 5238 PE
with filter Urea/Adblue / con filtro Urea/Adblue	DXi 11 Euro 4/5	280	381	06/09	>			S 4402 U
dryer filter WABCO, right-hand thread / filtro essiccatore WABCO, filetto destro	DXi 11 Euro 4/5	280	381	06/09	>			S 7A66 A
inner / interno	DXi 11 Euro 4/5	280	381	06/09	>			S 7406 A
LONG LIFE	DXi 11 Euro 4/5	280	381	06/09	>		S 4120 NR	
2 filters / N.2 filtri	DXi 11 Euro 4/5	280	381	06/09	>	S 4402 R		
prefilter short filter / prefilto filtro corto	DXi 11 Euro 4/5	280	381	06/09	>		S 4157 NR	
prefilter long filter / prefilto filtro lungo	DXi 11 Euro 4/5	280	381	06/09	>		S 4146 NR	
power steering / servosterzo	DXi 11 Euro 4/5	280	381	06/09	>			S 3081 PO
HL410 DXi	DXi 11 Euro4/5	302	410	05/06	>		S 9320 NR	S 7643 A
by-pass	DXi 11 Euro4/5	302	410	05/06	>	S 4120 R		
with automatic gearbox / con cambio automatico	DXi 11 Euro4/5	302	410	05/06	>			S 5238 PE
with filter Urea/Adblue / con filtro Urea/Adblue	DXi 11 Euro4/5	302	410	05/06	>			S 4402 U
dryer filter WABCO, right-hand thread / filtro essiccatore WABCO, filetto destro	DXi 11 Euro4/5	302	410	05/06	>			S 7A66 A
inner / interno	DXi 11 Euro4/5	302	410	05/06	>			S 7406 A
LONG LIFE	DXi 11 Euro4/5	302	410	05/06	>		S 4120 NR	
2 filters / N.2 filtri	DXi 11 Euro4/5	302	410	05/06	>	S 4402 R		
prefilter short filter / prefilto filtro corto	DXi 11 Euro4/5	302	410	05/06	>		S 4157 NR	
prefilter long filter / prefilto filtro lungo	DXi 11 Euro4/5	302	410	05/06	>		S 4146 NR	
power steering / servosterzo	DXi 11 Euro4/5	302	410	05/06	>			S 3081 PO
HL420 DCI	DCI11-B/43	303	412	02/04	>	04/06		S 7357 A
	DCI11-B/43	303	412	05/06	>			S 7357 A
with automatic gearbox / con cambio automatico	DCI11-B/43	303	412	02/04	>			S 5238 PE
dryer filter WABCO, right-hand thread / filtro essiccatore WABCO, filetto destro	DCI11-B/43	303	412	02/04	>			S 7A66 A
inner / interno	DCI11-B/43	303	412	02/04	>			S 7406 A
2 filters / N.2 filtri	DCI11-B/43	303	412	02/04	>	S 0900 R	S 0712 NR	
prefilter SEPAR 2000, heated / prefilto SEPAR 2000, riscaldato	DCI11-B/43	303	412	02/04	>		S 6059 NE	
rotor for oil centrifuge / rotore per filtro olio centrifugo	DCI11-B/43	303	412	02/04	>	S 5903 PO		
power steering / servosterzo	DCI11-B/43	303	412	02/04	>			S 3081 PO
HL430 DXi	DXi 11 Euro4/5	316	430	06/09	>		S 9320 NR	S 7643 A
by-pass	DXi 11 Euro4/5	316	430	06/09	>	S 4120 R		
with automatic gearbox / con cambio automatico	DXi 11 Euro4/5	316	430	06/09	>			S 5238 PE
with filter Urea/Adblue / con filtro Urea/Adblue	DXi 11 Euro4/5	316	430	06/09	>			S 4402 U
dryer filter WABCO, right-hand thread / filtro essiccatore WABCO, filetto destro	DXi 11 Euro4/5	316	430	06/09	>			S 7A66 A
inner / interno	DXi 11 Euro4/5	316	430	06/09	>			S 7406 A
LONG LIFE	DXi 11 Euro4/5	316	430	06/09	>		S 4120 NR	
2 filters / N.2 filtri	DXi 11 Euro4/5	316	430	06/09	>	S 4402 R		
prefilter short filter / prefilto filtro corto	DXi 11 Euro4/5	316	430	06/09	>		S 4157 NR	
prefilter long filter / prefilto filtro lungo	DXi 11 Euro4/5	316	430	06/09	>		S 4146 NR	
power steering / servosterzo	DXi 11 Euro4/5	316	430	06/09	>			S 3081 PO
HL440 DXi	DXi 11 Euro4/5	324	436	10/05	>		S 9320 NR	S 7643 A
	DXi 11 Euro4/5	324	436	10/05	>	04/06		S 3217 C
by-pass	DXi 11 Euro4/5	324	436	10/05	>	S 4120 R		
with automatic gearbox / con cambio automatico	DXi 11 Euro4/5	324	436	10/05	>			S 5238 PE
with filter Urea/Adblue / con filtro Urea/Adblue	DXi 11 Euro4/5	324	436	10/05	>			S 4402 U



...RENAULT TRUCKS - trucks/autocarri

dryer filter WABCO, right-hand thread / filtro essiccatore WABCO, filetto destro	DXi 11 Euro4/5	324	436	10/05	>				S 7A66 A
inner / interno	DXi 11 Euro4/5	324	436	10/05	>				
LONG LIFE	DXi 11 Euro4/5	324	436	10/05	>				
2 filters / N.2 filtri	DXi 11 Euro4/5	324	436	10/05	>	S 4402 R	S 4120 NR	S 7406 A	
prefilter short filter / prefiltro filtro corto	DXi 11 Euro4/5	324	436	10/05	>		S 4157 NR		
prefilter long filter / prefiltro filtro lungo	DXi 11 Euro4/5	324	436	10/05	>		S 4146 NR		
power steering / servosterzo	DXi 11 Euro4/5	324	436	10/05	>				S 3081 PO
HL450 DXi	DXi 11 Euro4/5	331	450	05/06	>		S 9320 NR	S 7643 A	
by-pass	DXi 11 Euro4/5	331	450	05/06	>	S 4120 R			
with automatic gearbox / con cambio automatico	DXi 11 Euro4/5	331	450	05/06	>				S 5238 PE
with filter Urea/Adblue / con filtro Urea/Adblue	DXi 11 Euro4/5	331	450	05/06	>				S 4402 U
dryer filter WABCO, right-hand thread / filtro essiccatore WABCO, filetto destro	DXi 11 Euro4/5	331	450	05/06	>				S 7A66 A
inner / interno	DXi 11 Euro4/5	331	450	05/06	>			S 7406 A	
LONG LIFE	DXi 11 Euro4/5	331	450	05/06	>		S 4120 NR		
2 filters / N.2 filtri	DXi 11 Euro4/5	331	450	05/06	>	S 4402 R			
prefilter short filter / prefiltro filtro corto	DXi 11 Euro4/5	331	450	05/06	>		S 4157 NR		
prefilter long filter / prefiltro filtro lungo	DXi 11 Euro4/5	331	450	05/06	>		S 4146 NR		
power steering / servosterzo	DXi 11 Euro4/5	331	450	05/06	>				S 3081 PO
HL460 DXi	DXi 11 Euro4/5	339	460	06/09	>		S 9320 NR	S 7643 A	
by-pass	DXi 11 Euro4/5	339	460	06/09	>	S 4120 R			
with automatic gearbox / con cambio automatico	DXi 11 Euro4/5	339	460	06/09	>				S 5238 PE
with filter Urea/Adblue / con filtro Urea/Adblue	DXi 11 Euro4/5	339	460	06/09	>				S 4402 U
dryer filter WABCO, right-hand thread / filtro essiccatore WABCO, filetto destro	DXi 11 Euro4/5	339	460	06/09	>				S 7A66 A
inner / interno	DXi 11 Euro4/5	339	460	06/09	>			S 7406 A	
LONG LIFE	DXi 11 Euro4/5	339	460	06/09	>		S 4120 NR		
2 filters / N.2 filtri	DXi 11 Euro4/5	339	460	06/09	>	S 4402 R			
prefilter short filter / prefiltro filtro corto	DXi 11 Euro4/5	339	460	06/09	>		S 4157 NR		
prefilter long filter / prefiltro filtro lungo	DXi 11 Euro4/5	339	460	06/09	>		S 4146 NR		
power steering / servosterzo	DXi 11 Euro4/5	339	460	06/09	>				S 3081 PO
PS Serie									
PS30T	MAN 2566						S 0201 N		
2nd passage / 2.passaggio	MAN 2566						S 1411 N		
Puncher									
270.18 DCI		195	265	09/02	>	S 0900 R			S 3217 C
dryer filter / filtro essiccatore		195	265	09/02	>				S 7344 A
inner DONALDSON / interno DONALDSON		195	265	09/02	>			S 7406 A	
inner MANN+HUMMEL / interno MANN+HUMMEL		195	265	09/02	>			S 7129 A	
assembly DONALDSON / montaggio DONALDSON		195	265	09/02	>			S 7357 A	
assembly DONALDSON P78-6892 / montaggio DONALDSON P78-6892		195	265	09/02	>			S 7B10 A	
assembly DONALDSON, height 373 mm / montaggio DONALDSON, altezza 373 mm		195	265	09/02	>			S 2764 A	
assembly MANN+HUMMEL / montaggio MANN+HUMMEL		195	265	09/02	>			S 2650 A	
2 filters / N.2 filtri		195	265	09/02	>		S 0712 NR		
power steering / servosterzo		195	265	09/02	>				S 3081 PO
270.19 DCI		195	265	09/02	>	S 0900 R			S 3217 C
dryer filter / filtro essiccatore		195	265	09/02	>				S 7344 A
inner DONALDSON / interno DONALDSON		195	265	09/02	>			S 7406 A	
inner MANN+HUMMEL / interno MANN+HUMMEL		195	265	09/02	>			S 7129 A	
assembly DONALDSON / montaggio DONALDSON		195	265	09/02	>			S 7357 A	
assembly DONALDSON P78-6892 / montaggio DONALDSON P78-6892		195	265	09/02	>			S 7B10 A	
assembly DONALDSON, height 373 mm / montaggio DONALDSON, altezza 373 mm		195	265	09/02	>			S 2764 A	
assembly MANN+HUMMEL / montaggio MANN+HUMMEL		195	265	09/02	>			S 2650 A	
2 filters / N.2 filtri		195	265	09/02	>		S 0712 NR		
power steering / servosterzo		195	265	09/02	>				S 3081 PO
270.26 DCI		195	265	09/02	>	S 0900 R			S 3217 C
dryer filter / filtro essiccatore		195	265	09/02	>				S 7344 A
inner DONALDSON / interno DONALDSON		195	265	09/02	>			S 7406 A	
inner MANN+HUMMEL / interno MANN+HUMMEL		195	265	09/02	>			S 7129 A	
assembly DONALDSON / montaggio DONALDSON		195	265	09/02	>			S 7357 A	
assembly DONALDSON P78-6892 / montaggio DONALDSON P78-6892		195	265	09/02	>			S 7B10 A	
assembly DONALDSON, height 373 mm / montaggio DONALDSON, altezza 373 mm		195	265	09/02	>			S 2764 A	
assembly MANN+HUMMEL / montaggio MANN+HUMMEL		195	265	09/02	>			S 2650 A	
2 filters / N.2 filtri		195	265	09/02	>		S 0712 NR		
power steering / servosterzo		195	265	09/02	>				S 3081 PO
R Serie									
R310.17	MIDR06.35.40			10/80	>	03/89	S 8600 R	S 8840 A	
some / alcuni	MIDR06.35.40			10/80	>	03/89	S 8600 R	S 4770 A	
with pump BOSCH / con pompa BOSCH	MIDR06.35.40			10/80	>	03/89	S 8600 R	S 3010 N	





kW HP



...RENAULT TRUCKS - trucks/autocarri

R



with pump BOSCH / con pompa BOSCH	MIDR06.35.40	10/80 > 03/89	S 8600 R	S 4323 NR		
with pump SIGMA / con pompa SIGMA	MIDR06.35.40	10/80 > 03/89	S 8600 R			
R310.18	MIDR06.35.40	10/80 > 03/89	S 8600 R		S 8840 A	
some / alcuni	MIDR06.35.40	10/80 > 03/89	S 8600 R		S 4770 A	
with pump BOSCH / con pompa BOSCH	MIDR06.35.40	10/80 > 03/89	S 8600 R	S 4323 NR		
with pump BOSCH / con pompa BOSCH	MIDR06.35.40	10/80 > 03/89	S 8600 R	S 3010 N		
with pump SIGMA / con pompa SIGMA	MIDR06.35.40	10/80 > 03/89	S 8600 R			
R310.19	MIDR06.35.40	10/80 > 03/89	S 8600 R		S 8840 A	
some / alcuni	MIDR06.35.40	10/80 > 03/89	S 8600 R		S 4770 A	
with pump BOSCH / con pompa BOSCH	MIDR06.35.40	10/80 > 03/89	S 8600 R	S 4323 NR		
with pump BOSCH / con pompa BOSCH	MIDR06.35.40	10/80 > 03/89	S 8600 R	S 3010 N		
with pump SIGMA / con pompa SIGMA	MIDR06.35.40	10/80 > 03/89	S 8600 R			
R310.22	MIDR06.35.40	10/80 > 03/89	S 8600 R		S 8840 A	
some / alcuni	MIDR06.35.40	10/80 > 03/89	S 8600 R		S 4770 A	
with pump BOSCH / con pompa BOSCH	MIDR06.35.40	10/80 > 03/89	S 8600 R	S 4323 NR		
with pump BOSCH / con pompa BOSCH	MIDR06.35.40	10/80 > 03/89	S 8600 R	S 3010 N		
with pump SIGMA / con pompa SIGMA	MIDR06.35.40	10/80 > 03/89	S 8600 R			
R310.26T	MIDR06.35.40	10/80 > 03/89	S 8600 R		S 8840 A	
some / alcuni	MIDR06.35.40	10/80 > 03/89	S 8600 R		S 4770 A	
with pump BOSCH / con pompa BOSCH	MIDR06.35.40	10/80 > 03/89	S 8600 R	S 4323 NR		
with pump BOSCH / con pompa BOSCH	MIDR06.35.40	10/80 > 03/89	S 8600 R	S 3010 N		
with pump SIGMA / con pompa SIGMA	MIDR06.35.40	10/80 > 03/89	S 8600 R			
R330	MIDS06.20.45E	05/88 > 05/91	S 0900 R	S 4323 NR		
R360.19T	MIVS08.35.30		S 8600 R	S 4323 NR	S 4770 A	
with pump BOSCH / con pompa BOSCH	MIVS08.35.30		S 8600 R	S 3010 N	S 4770 A	
with pump SIGMA / con pompa SIGMA	MIVS08.35.30		S 8600 R		S 4770 A	
R360.26T	MIVS08.35.30		S 8600 R	S 4323 NR	S 4770 A	
with pump BOSCH / con pompa BOSCH	MIVS08.35.30		S 8600 R	S 3010 N	S 4770 A	
with pump SIGMA / con pompa SIGMA	MIVS08.35.30		S 8600 R		S 4770 A	
R360.33T	MIVS08.35.30		S 8600 R	S 4323 NR	S 4770 A	
with pump BOSCH / con pompa BOSCH	MIVS08.35.30		S 8600 R	S 3010 N	S 4770 A	
with pump SIGMA / con pompa SIGMA	MIVS08.35.30		S 8600 R		S 4770 A	
R370.19T	MIVS08.35.30		S 8600 R	S 4323 NR	S 4770 A	
with pump BOSCH / con pompa BOSCH	MIVS08.35.30		S 8600 R	S 3010 N	S 4770 A	
with pump SIGMA / con pompa SIGMA	MIVS08.35.30		S 8600 R		S 4770 A	
R370.26T	MIVS08.35.30		S 8600 R	S 4323 NR	S 4770 A	
with pump BOSCH / con pompa BOSCH	MIVS08.35.30		S 8600 R	S 3010 N	S 4770 A	
with pump SIGMA / con pompa SIGMA	MIVS08.35.30		S 8600 R		S 4770 A	
R370.35T	MIVS08.35.30		S 8600 R	S 4323 NR	S 4770 A	
with pump BOSCH / con pompa BOSCH	MIVS08.35.30		S 8600 R	S 3010 N	S 4770 A	
with pump SIGMA / con pompa SIGMA	MIVS08.35.30		S 8600 R		S 4770 A	
R390	MIVS08.35.30		S 8600 R	S 4323 NR	S 4770 A	
R420 TI Major	MIDR06.35.40	10/92 >	S 0900 R	S 4323 NR		
power steering / servosterzo	MIDR06.35.40	10/92 >				S 3081 PO
RI Serie						
RI357	MIDR06.35.30		S 8600 R	S 4323 NR		
RI357T	MIDR06.35.30		S 8600 R	S 4323 NR		
S Serie						
S100.06						
spin-on / avvitabile	Perkins LJ80-322		S 5600 R	S 4323 NR		
with pump SIGMA V80 / con pompa SIGMA V80	Perkins LJ80-322		S 5600 R			
assembly DELPHI / montaggio DELPHI	Perkins LJ80-322		S 5600 R	S 7111 NC		
S100.08						
spin-on / avvitabile	Perkins LJ80-322		S 5600 R	S 4323 NR		
with pump SIGMA V80 / con pompa SIGMA V80	Perkins LJ80-322		S 5600 R			
assembly DELPHI / montaggio DELPHI	Perkins LJ80-322		S 5600 R	S 7111 NC		
S130						
some / alcuni	720		S 3241 R			
with RENAULT 50 00 243 970 / con RENAULT 50 00 243 970	720		S 3241 R		S 7974 A	
with RENAULT 50 00 790 570 / con RENAULT 50 00 790 570	720		S 3241 R	S 4323 NR		
assembly DELPHI / montaggio DELPHI	720		S 3241 R	S 7111 NC		
S130						
with RENAULT 00 00 504 020 / con RENAULT 00 00 504 020	797, 798		S 8600 R			
with RENAULT 50 00 040 870 / con RENAULT 50 00 040 870	797, 798		S 3241 R			
with RENAULT 50 00 243 970 / con RENAULT 50 00 243 970	797, 798				S 7974 A	
with RENAULT 50 00 790 570 / con RENAULT 50 00 790 570	797, 798			S 4323 NR		
assembly DELPHI / montaggio DELPHI	797, 798			S 7111 NC		



KW HP



...RENAULT TRUCKS - trucks/autocarri

S130.08					
some / alcuni	720			S 3241 R	
with RENAULT 50 00 243 970 / con RENAULT 50 00 243 970	720			S 3241 R	S 7974 A
with RENAULT 50 00 790 570 / con RENAULT 50 00 790 570	720			S 3241 R	S 4323 NR
assembly DELPHI / montaggio DELPHI	720			S 3241 R	S 7111 NC
S130.08					
with RENAULT 00 00 504 020 / con RENAULT 00 00 504 020	797, 798			S 8600 R	
with RENAULT 50 00 040 870 / con RENAULT 50 00 040 870	797, 798			S 3241 R	
with RENAULT 50 00 243 970 / con RENAULT 50 00 243 970	797, 798				S 7974 A
with RENAULT 50 00 790 570 / con RENAULT 50 00 790 570	797, 798				S 4323 NR
assembly DELPHI / montaggio DELPHI	797, 798				S 7111 NC
S130.09					
some / alcuni	720			S 3241 R	
with RENAULT 50 00 243 970 / con RENAULT 50 00 243 970	720			S 3241 R	S 7974 A
with RENAULT 50 00 790 570 / con RENAULT 50 00 790 570	720			S 3241 R	S 4323 NR
assembly DELPHI / montaggio DELPHI	720			S 3241 R	S 7111 NC
S130.09					
with RENAULT 00 00 504 020 / con RENAULT 00 00 504 020	797, 798			S 8600 R	
with RENAULT 50 00 040 870 / con RENAULT 50 00 040 870	797, 798			S 3241 R	
with RENAULT 50 00 243 970 / con RENAULT 50 00 243 970	797, 798				S 7974 A
with RENAULT 50 00 790 570 / con RENAULT 50 00 790 570	797, 798				S 4323 NR
assembly DELPHI / montaggio DELPHI	797, 798				S 7111 NC
S130.115					
some / alcuni	720			S 3241 R	
with RENAULT 50 00 243 970 / con RENAULT 50 00 243 970	720			S 3241 R	S 7974 A
with RENAULT 50 00 790 570 / con RENAULT 50 00 790 570	720			S 3241 R	S 4323 NR
assembly DELPHI / montaggio DELPHI	720			S 3241 R	S 7111 NC
S130.115					
with RENAULT 00 00 504 020 / con RENAULT 00 00 504 020	797, 798			S 8600 R	
with RENAULT 50 00 040 870 / con RENAULT 50 00 040 870	797, 798			S 3241 R	
with RENAULT 50 00 243 970 / con RENAULT 50 00 243 970	797, 798				S 7974 A
with RENAULT 50 00 790 570 / con RENAULT 50 00 790 570	797, 798				S 4323 NR
assembly DELPHI / montaggio DELPHI	797, 798				S 7111 NC
S130BOM					
some / alcuni	720			S 3241 R	
with RENAULT 50 00 243 970 / con RENAULT 50 00 243 970	720			S 3241 R	S 7974 A
with RENAULT 50 00 790 570 / con RENAULT 50 00 790 570	720			S 3241 R	S 4323 NR
assembly DELPHI / montaggio DELPHI	720			S 3241 R	S 7111 NC
S130BOM					
with RENAULT 00 00 504 020 / con RENAULT 00 00 504 020	797, 798			S 8600 R	
with RENAULT 50 00 040 870 / con RENAULT 50 00 040 870	797, 798			S 3241 R	
with RENAULT 50 00 243 970 / con RENAULT 50 00 243 970	797, 798				S 7974 A
with RENAULT 50 00 790 570 / con RENAULT 50 00 790 570	797, 798				S 4323 NR
assembly DELPHI / montaggio DELPHI	797, 798				S 7111 NC
S150					
some / alcuni	798, MAN 2565			S 3241 R	
assembly DELPHI / montaggio DELPHI	798, MAN 2565			S 3241 R	S 7111 NC
S150 BOM	MIDR/MIDS06.02.12/12B			S 8600 R	
S150 BOM	MIDS06.02.26	09/88 >		S 0900 R	S 4323 NR
S150 BOM Turbo Intercooler	MIDR/MIDS06.02.12/12B			S 8600 R	
S150 BOM Turbo Intercooler	MIDS06.02.26	09/88 >		S 0900 R	S 4323 NR
S150 CIT	MIDR/MIDS06.02.12/12B			S 8600 R	
S150 CIT	MIDS06.02.26	09/88 >		S 0900 R	S 4323 NR
S150 TI	MIDR/MIDS06.02.12/12B			S 8600 R	
S150 TI	MIDS06.02.26	09/88 >		S 0900 R	S 4323 NR
S150.08	MIDR/MIDS06.02.12/12B			S 8600 R	
S150.08	MIDS06.02.26	09/88 >		S 0900 R	S 4323 NR
S150.09	MIDR/MIDS06.02.12/12B			S 8600 R	
S150.09	MIDS06.02.26	09/88 >		S 0900 R	S 4323 NR
S150.11	MIDR/MIDS06.02.12/12B			S 8600 R	
S150.11	MIDS06.02.26	09/88 >		S 0900 R	S 4323 NR
S150.13	MIDR/MIDS06.02.12/12B			S 8600 R	
S150.13	MIDS06.02.26	09/88 >		S 0900 R	S 4323 NR
S150.14	MIDR/MIDS06.02.12/12B			S 8600 R	
S150.14	MIDS06.02.26	09/88 >		S 0900 R	S 4323 NR
S150BOM					
some / alcuni	798, MAN 2565			S 3241 R	

R





kW HP



...RENAULT TRUCKS - trucks/autocarri

R

assembly DELPHI / montaggio DELPHI	798, MAN 2565		S 3241 R	S 7111 NC		
S160 Turbo			S 0900 R	S 4323 NR		
S170	MIDR/MIDS06.02.12/12B	10/87 > 05/89	S 8600 R			
S170	MIDS06.02.26	09/88 >	S 0900 R	S 4323 NR		
S170 SP	MIDR/MIDS06.02.12/12B		S 8600 R			
S170 SP	MIDS06.02.26	09/88 >	S 0900 R	S 4323 NR		
S170.11 Turbo	MIDR/MIDS06.02.12/12B		S 8600 R			
S170.11 Turbo	MIDS06.02.26	09/88 >	S 0900 R	S 4323 NR		
S170.13	MIDR/MIDS06.02.12/12B		S 8600 R			
S170.13	MIDS06.02.26	09/88 >	S 0900 R	S 4323 NR		
S170.13T Turbo	MIDR/MIDS06.02.12/12B		S 8600 R			
S170.13T Turbo	MIDS06.02.26	09/88 >	S 0900 R	S 4323 NR		
S170.14 Turbo	MIDR/MIDS06.02.12/12B		S 8600 R			
S170.14 Turbo	MIDS06.02.26	09/88 >	S 0900 R	S 4323 NR		
S170.15A Turbo Intercooler	MIDR/MIDS06.02.12/12B		S 8600 R			
S170.15A Turbo Intercooler	MIDS06.02.26	09/88 >	S 0900 R	S 4323 NR		
SB Serie						
SB2	599	10/66 > 06/80	S 6290 PO			
some / alcuni	599	10/66 > 06/80	S 6290 PO	S 3010 N		
with pump BOSCH / con pompa BOSCH	599	10/66 > 06/80	S 6290 PO	S 9091 N		
with pump DELPHI / con pompa DELPHI	599	10/66 > 06/80	S 6290 PO	S 7111 NC		
SB2	712	01/71 > 06/84	S 6290 PO			
SB2	817	> 06/80	S 6290 PO			
spin-on / avvitabile	817	> 06/80	S 3241 R			
SB2	817 Diesel	> 06/80	S 6290 PO			
some / alcuni	817 Diesel	> 06/80	S 6290 PO	S 3010 N		
with pump BOSCH / con pompa BOSCH	817 Diesel	> 06/80	S 6290 PO	S 9091 N		
with pump DELPHI / con pompa DELPHI	817 Diesel	> 06/80	S 6290 PO	S 7111 NC		
SB2 Traffic	599	10/66 > 06/70	S 6290 PO			
some / alcuni	599	10/66 > 06/70	S 6290 PO	S 3010 N		
with pump BOSCH / con pompa BOSCH	599	10/66 > 06/70	S 6290 PO	S 9091 N		
with pump DELPHI / con pompa DELPHI	599	10/66 > 06/70	S 6290 PO	S 7111 NC		
SC Serie						
SC6			S 3241 R			
some / alcuni	597		S 3241 R	S 7111 NC		
with pump DELPHI / con pompa DELPHI	597					
SG Serie						
SG2	817	04/73 > 06/80	S 6290 PO			
spin-on / avvitabile	817	04/73 > 06/80	S 3241 R			
SG3	817	04/73 > 06/80	S 6290 PO			
spin-on / avvitabile	817	04/73 > 06/80	S 3241 R			
SG4	817	04/73 > 06/80	S 6290 PO			
spin-on / avvitabile	817	04/73 > 06/80	S 3241 R			
SG5			S 3241 R			
some / alcuni	597, 797	10/67 > 06/84	S 3241 R	S 7111 NC		
with pump DELPHI / con pompa DELPHI	597, 797	10/67 > 06/84	S 3241 R			
SG5	817	04/73 > 06/80	S 6290 PO			
spin-on / avvitabile	817	04/73 > 06/80	S 3241 R			
SM Serie						
SM10	MAN D0846	01/72 > 10/79	S 0530 PO	S 0101 N		
2nd passage / 2.passaggio	MAN D0846	01/72 > 10/79		S 7411 N		
with pump SIGMA / con pompa SIGMA	MAN D0846	01/72 > 10/79	S 0530 PO			
SM10	MAN D2146MN	10/67 > 12/74	S 0530 PO	S 0201 N		
2nd passage / 2.passaggio	MAN D2146MN	10/67 > 12/74		S 1411 N		
SM12	MAN D0846	01/72 > 10/79	S 0530 PO	S 0101 N		
2nd passage / 2.passaggio	MAN D0846	01/72 > 10/79		S 7411 N		
with pump SIGMA / con pompa SIGMA	MAN D0846	01/72 > 10/79	S 0530 PO			
SM12S	MAN D2146MN	10/67 > 12/74	S 0530 PO	S 0201 N		
2nd passage / 2.passaggio	MAN D2146MN	10/67 > 12/74		S 1411 N		
SM13			S 3241 R			
some / alcuni	597, 797	10/67 > 06/84	S 3241 R			
some / alcuni	597, 797	10/67 > 06/84			S 7974 A	
with pump BOSCH / con pompa BOSCH	597, 797	10/67 > 06/84	S 3241 R	S 9091 N		
with pump DELPHI / con pompa DELPHI	597, 797	10/67 > 06/84	S 3241 R	S 7111 NC		
with pump SIGMA V80 / con pompa SIGMA V80	597, 797	10/67 > 06/84	S 3241 R			
cartridge / immersione	597, 797	10/67 > 06/84	S 6290 PO			
SM170	MAN D0846	01/72 > 10/79	S 0530 PO	S 7411 N		



kW HP



...RENAULT TRUCKS - trucks/autocarri

some / alcuni	MAN D0846	01/72 > 10/79	S 0530 PO	S 1411 N		
with pump SIGMA / con pompa SIGMA	MAN D0846	01/72 > 10/79	S 0530 PO			
SM180	MAN D0846	04/71 > 12/74	S 0530 PO	S 7411 N		
some / alcuni	MAN D0846	04/71 > 04/74	S 0530 PO	S 1411 N		
with pump SIGMA / con pompa SIGMA	MAN D0846	04/71 > 12/74	S 0530 PO			
SM200	MAN D2156	04/71 > 12/74	S 0530 PO	S 0201 N		
2nd passage / 2.passaggio	MAN D2156	04/71 > 12/74		S 1411 N		
SM21.180	MAN D0846HMN	10/67 > 12/74	S 0530 PO	S 0101 N		
2nd passage / 2.passaggio	MAN D0846HMN	10/67 > 12/74		S 7411 N		
some / alcuni	MAN D0846HMN	10/67 > 12/74	S 0530 PO	S 1411 N		
SM21.240	MAN D2156HMN6	01/73 > 06/80	S 0530 PO	S 7411 N		
some / alcuni	MAN D2156HMN6	01/73 > 06/80	S 0530 PO	S 1411 N		
SM240	MAN D2156	04/71 > 12/74	S 0530 PO	S 0201 N		
2nd passage / 2.passaggio	MAN D2156	04/71 > 12/74		S 1411 N		
SM260	MAN D2356	01/72 > 06/80	S 0530 PO	S 0201 N		
2nd passage / 2.passaggio	MAN D2356	01/72 > 06/80		S 1411 N		
SM280TU	MAN D2156	04/73 > 06/80	S 0530 PO	S 0201 N		
2nd passage / 2.passaggio	MAN D2156	04/73 > 06/80		S 1411 N		
SM300	MAN D2658M41	01/71 > 12/76	S 2530 PO	S 0201 N		
2nd passage / 2.passaggio	MAN D2658M41	01/71 > 12/76		S 1411 N		
SM300T	MAN D2658M41	01/71 > 12/76	S 2530 PO	S 0201 N		
2nd passage / 2.passaggio	MAN D2658M41	01/71 > 12/76		S 1411 N		
SM320	MAN D2858M4	01/72 > 12/74	S 2530 PO	S 0201 N		
2nd passage / 2.passaggio	MAN D2858M4	01/72 > 12/74		S 1411 N		
SM340V	MAN D2858M4	01/72 > 06/80	S 2530 PO	S 0201 N		
2nd passage / 2.passaggio	MAN D2858M4	01/72 > 06/80		S 1411 N		
SM5						
some / alcuni	712	10/67 > 02/73	S 6290 PO			
some / alcuni	712	10/67 > 02/73	S 6290 PO	S 3010 N		
some / alcuni	712	10/67 > 02/73			S 7974 A	
with pump BOSCH / con pompa BOSCH	712	10/67 > 02/73	S 6290 PO	S 9091 N		
with pump DELPHI / con pompa DELPHI	712	10/67 > 02/73	S 6290 PO	S 7111 NC		
SM5						
some / alcuni	720	03/73 > 06/80	S 3241 R			
some / alcuni	720	03/73 > 06/80	S 3241 R	S 3010 N		
some / alcuni	720	03/73 > 06/80			S 7974 A	
with pump BOSCH / con pompa BOSCH	720	03/73 > 06/80	S 3241 R	S 9091 N		
with pump DELPHI / con pompa DELPHI	720	03/73 > 06/80	S 3241 R	S 7111 NC		
SM6						
some / alcuni	597, 797	10/67 > 06/80	S 3241 R			
some / alcuni	597, 797	10/67 > 06/80			S 7974 A	
with pump BOSCH / con pompa BOSCH	597, 797	10/67 > 06/80	S 3241 R	S 9091 N		
with pump DELPHI / con pompa DELPHI	597, 797	10/67 > 06/80	S 3241 R	S 7111 NC		
with pump SIGMA V80 / con pompa SIGMA V80	597, 797	10/67 > 06/80	S 3241 R			
cartridge / immersione	597, 797	10/67 > 06/80	S 6290 PO			
SM6						
some / alcuni	798	06/73 > 06/80	S 3241 R			
with pump DELPHI / con pompa DELPHI	798	06/73 > 06/80	S 3241 R	S 7111 NC		
with pump SIGMA V80 / con pompa SIGMA V80	798	06/73 > 06/80	S 3241 R			
SM7						
some / alcuni	597, 797	10/67 > 06/80	S 3241 R			
some / alcuni	597, 797	10/67 > 06/80			S 7974 A	
with pump BOSCH / con pompa BOSCH	597, 797	10/67 > 06/80	S 3241 R	S 9091 N		
with pump DELPHI / con pompa DELPHI	597, 797	10/67 > 06/80	S 3241 R	S 7111 NC		
with pump SIGMA V80 / con pompa SIGMA V80	597, 797	10/67 > 06/80	S 3241 R			
cartridge / immersione	597, 797	10/67 > 06/80	S 6290 PO			
SM7						
some / alcuni	798, MAN 2565	06/73 > 06/80	S 3241 R			
with pump DELPHI / con pompa DELPHI	798, MAN 2565	06/73 > 06/80	S 3241 R	S 7111 NC		
with pump SIGMA V80 / con pompa SIGMA V80	798, MAN 2565	06/73 > 06/80	S 3241 R			
SM8						
some / alcuni	597, 797	10/67 > 06/84	S 3241 R			
some / alcuni	597, 797	10/67 > 06/84			S 7974 A	
with pump BOSCH / con pompa BOSCH	597, 797	10/67 > 06/84	S 3241 R	S 9091 N		
with pump DELPHI / con pompa DELPHI	597, 797	10/67 > 06/84	S 3241 R	S 7111 NC		
with pump SIGMA V80 / con pompa SIGMA V80	597, 797	10/67 > 06/84	S 3241 R			
cartridge / immersione	597, 797	10/67 > 06/84	S 6290 PO			

R





KW HP



...RENAULT TRUCKS - trucks/autocarri

R



SM8									
some / alcuni	798, MAN 2565			06/73 >	06/80	S 3241 R			
with pump DELPHI / con pompa DELPHI	798, MAN 2565			06/73 >	06/80	S 3241 R	S 7111 NC		
with pump SIGMA V80 / con pompa SIGMA V80	798, MAN 2565			06/73 >	06/80	S 3241 R			
cartridge / immersione	798, MAN 2565			06/73 >	06/80	S 6290 PO			
SM8 4x4									
some / alcuni	597, 797			10/67 >	06/84	S 3241 R			
some / alcuni	597, 797			10/67 >	06/84			S 7974 A	
with pump BOSCH / con pompa BOSCH	597, 797			10/67 >	06/84	S 3241 R	S 9091 N		
with pump DELPHI / con pompa DELPHI	597, 797			10/67 >	06/84	S 3241 R	S 7111 NC		
with pump SIGMA V80 / con pompa SIGMA V80	597, 797			10/67 >	06/84	S 3241 R			
cartridge / immersione	597, 797			10/67 >	06/84	S 6290 PO			
SM8.13									
some / alcuni	797, 798, MAN 2565			01/71 >	06/80	S 3241 R			
some / alcuni	797, 798, MAN 2565			01/71 >	06/80			S 7974 A	
with pump DELPHI / con pompa DELPHI	797, 798, MAN 2565			01/71 >	06/80	S 3241 R	S 7111 NC		
with pump SIGMA V80 / con pompa SIGMA V80	797, 798, MAN 2565			01/71 >	06/80	S 3241 R			
cartridge / immersione	797, 798, MAN 2565			01/71 >	06/80	S 6290 PO			
SM8.15									
some / alcuni	798, MAN 2565			01/71 >	06/80	S 3241 R			
some / alcuni	798, MAN 2565			01/71 >	06/80			S 7974 A	
with pump DELPHI / con pompa DELPHI	798, MAN 2565			01/71 >	06/80	S 3241 R	S 7111 NC		
with pump SIGMA V80 / con pompa SIGMA V80	798, MAN 2565			01/71 >	06/80	S 3241 R			
cartridge / immersione	798, MAN 2565			01/71 >	06/80	S 6290 PO			
SM8T									
some / alcuni	597, 797			10/67 >	06/84	S 3241 R			
some / alcuni	597, 797			10/67 >	06/84			S 7974 A	
with pump BOSCH / con pompa BOSCH	597, 797			10/67 >	06/84	S 3241 R	S 9091 N		
with pump DELPHI / con pompa DELPHI	597, 797			10/67 >	06/84	S 3241 R	S 7111 NC		
with pump SIGMA V80 / con pompa SIGMA V80	597, 797			10/67 >	06/84	S 3241 R			
cartridge / immersione	597, 797			10/67 >	06/84	S 6290 PO			
T Serie									
T 380									
by-pass	DTI11 Euro 6	279 380		06/13 >		S 4120 R			S 9006 AR
outer / esterno	DTI11 Euro 6	279 380		06/13 >				S 7B39 A	
2 filters / N.2 filtri	DTI11 Euro 6	279 380		06/13 >		S 4402 R			
prefilter RACOR / prefiltra RACOR	DTI11 Euro 6	279 380		06/13 >			S 4477 NR		
power steering / servosterzo	DTI11 Euro 6	279 380		06/13 >					S 3081 PO
T 430									
by-pass	DTI11 Euro 6	316 430		06/13 >		S 4120 R			S 9006 AR
outer / esterno	DTI11 Euro 6	316 430		06/13 >				S 7B39 A	
2 filters / N.2 filtri	DTI11 Euro 6	316 430		06/13 >		S 4402 R			
prefilter RACOR / prefiltra RACOR	DTI11 Euro 6	316 430		06/13 >			S 4477 NR		
power steering / servosterzo	DTI11 Euro 6	316 430		06/13 >					S 3081 PO
T 440									
by-pass	DTI13 Euro 6	324 440		06/13 >		S 4120 R			S 9006 AR
inner / interno	DTI13 Euro 6	324 440		06/13 >				S 7A04 A	
DONALDSON assembly outer / montaggio DONALDSON esterno	DTI13 Euro 6	324 440		06/13 >				S 7B39 A	
assembly MANN+HUMMEL / montaggio MANN+HUMMEL	DTI13 Euro 6	324 440		06/13 >				S 7A03 A	
2 filters / N.2 filtri	DTI13 Euro 6	324 440		06/13 >		S 4402 R			
prefilter / prefiltra	DTI13 Euro 6	324 440		06/13 >			S 4477 NR		
power steering / servosterzo	DTI13 Euro 6	324 440		06/13 >					S 3081 PO
T 460									
by-pass	DTI11 Euro 6	338 460		06/13 >		S 4120 R			S 9006 AR
outer / esterno	DTI11 Euro 6	338 460		06/13 >				S 7B39 A	
2 filters / N.2 filtri	DTI11 Euro 6	338 460		06/13 >		S 4402 R			
prefilter RACOR / prefiltra RACOR	DTI11 Euro 6	338 460		06/13 >			S 4477 NR		
power steering / servosterzo	DTI11 Euro 6	338 460		06/13 >					S 3081 PO
T 480									
by-pass	DTI13 Euro 6	353 480		06/13 >		S 4120 R			S 9006 AR
inner / interno	DTI13 Euro 6	353 480		06/13 >				S 7A04 A	
DONALDSON assembly outer / montaggio DONALDSON esterno	DTI13 Euro 6	353 480		06/13 >				S 7B39 A	
assembly MANN+HUMMEL / montaggio MANN+HUMMEL	DTI13 Euro 6	353 480		06/13 >				S 7A03 A	
2 filters / N.2 filtri	DTI13 Euro 6	353 480		06/13 >		S 4402 R			
prefilter / prefiltra	DTI13 Euro 6	353 480		06/13 >			S 4477 NR		
power steering / servosterzo	DTI13 Euro 6	353 480		06/13 >					S 3081 PO
T 520									
	DTI13 Euro 6	382 520		06/13 >					S 9006 AR



kW HP



...RENAULT TRUCKS - trucks/autocarri

by-pass	DT113 Euro 6	382 520	06/13 >	S 4120 R		
inner / interno	DT113 Euro 6	382 520	06/13 >			S 7A04 A
DONALDSON assembly outer / montaggio DONALDSON esterno	DT113 Euro 6	382 520	06/13 >			S 7B39 A
assembly MANN+HUMMEL / montaggio MANN+HUMMEL	DT113 Euro 6	382 520	06/13 >			S 7A03 A
2 filters / N.2 filtri	DT113 Euro 6	382 520	06/13 >	S 4402 R		
prefilter RACOR / prefiltro RACOR	DT113 Euro 6	382 520	06/13 >		S 4477 NR	
power steering / servosterzo	DT113 Euro 6	382 520	06/13 >			S 3081 PO
TB Serie						
TB191						
some / alcuni	MID/MIDS06.20.30		06/80 > 12/84	S 8600 R	S 3010 N	S 2450 A
spin-on / avvitabile	MID/MIDS06.20.30		06/80 > 12/84	S 8600 R	S 4323 NR	S 2650 A
with pump BOSCH / con pompa BOSCH	MID/MIDS06.20.30		06/80 > 12/84	S 8600 R	S 3010 N	S 2650 A
with pump DELPHI / con pompa DELPHI	MID/MIDS06.20.30		06/80 > 12/84	S 8600 R	S 7111 NC	S 2650 A
with pump SIGMA / con pompa SIGMA	MID/MIDS06.20.30		06/80 > 12/84	S 8600 R		S 2650 A
inner / interno	MID/MIDS06.20.30		06/80 > 12/84			S 7129 A
inner / interno	MID/MIDS06.20.30		06/80 > 12/84			S 3940 A
TB230						
some / alcuni	MID/MIDS06.20.30		06/80 > 12/84	S 8600 R	S 4323 NR	S 2450 A
spin-on / avvitabile	MID/MIDS06.20.30		06/80 > 12/84	S 8600 R	S 4323 NR	S 2650 A
with pump BOSCH / con pompa BOSCH	MID/MIDS06.20.30		06/80 > 12/84	S 8600 R	S 3010 N	S 2650 A
with pump DELPHI / con pompa DELPHI	MID/MIDS06.20.30		06/80 > 12/84	S 8600 R	S 7111 NC	S 2650 A
with pump SIGMA V80 / con pompa SIGMA V80	MID/MIDS06.20.30		06/80 > 12/84	S 8600 R		S 2650 A
inner / interno	MID/MIDS06.20.30		06/80 > 12/84			S 7129 A
inner / interno	MID/MIDS06.20.30		06/80 > 12/84			S 3940 A
TB231						
some / alcuni	MID/MIDS06.20.30		06/80 > 12/84	S 8600 R	S 4323 NR	S 2450 A
spin-on / avvitabile	MID/MIDS06.20.30		06/80 > 12/84	S 8600 R	S 4323 NR	S 2650 A
with pump BOSCH / con pompa BOSCH	MID/MIDS06.20.30		06/80 > 12/84	S 8600 R	S 3010 N	S 2650 A
with pump DELPHI / con pompa DELPHI	MID/MIDS06.20.30		06/80 > 12/84	S 8600 R	S 7111 NC	S 2650 A
with pump SIGMA V80 / con pompa SIGMA V80	MID/MIDS06.20.30		06/80 > 12/84	S 8600 R		S 2650 A
inner / interno	MID/MIDS06.20.30		06/80 > 12/84			S 7129 A
inner / interno	MID/MIDS06.20.30		06/80 > 12/84			S 3940 A
TBH Serie						
TBH260						
some / alcuni	MIDR/MIDS06.20.45			S 8600 R	S 0510 NR	S 6550 A
some / alcuni	MIDR/MIDS06.20.45			S 8600 R	S 0510 NR	S 7945 A
with pump BOSCH / con pompa BOSCH	MIDR/MIDS06.20.45			S 8600 R	S 3010 N	S 0150 A
with pump DELPHI / con pompa DELPHI	MIDR/MIDS06.20.45			S 8600 R	S 8111 NC	S 0150 A
with pump SIGMA FS300 / con pompa SIGMA FS300	MIDR/MIDS06.20.45			S 8600 R	S 0510 NR	S 0150 A
cartridge / immersione	MIDR/MIDS06.20.45			S 1910 PO		
inner / interno	MIDR/MIDS06.20.45					S 8940 A
inner / interno	MIDR/MIDS06.20.45					S 2840 A
TBH280						
some / alcuni	MDR/MDS06.35.40		01/77 > 06/91	S 8600 R	S 3010 N	S 8840 A
some / alcuni	MDR/MDS06.35.40		01/77 > 06/91	S 8600 R	S 3010 N	S 4770 A
some / alcuni	MDR/MDS06.35.40		01/77 > 06/91	S 8600 R	S 3010 N	S 7945 A
with pump BOSCH / con pompa BOSCH	MDR/MDS06.35.40		01/77 > 06/91	S 8600 R	S 3010 N	S 6550 A
with pump BOSCH / con pompa BOSCH	MDR/MDS06.35.40		01/77 > 06/91	S 8600 R	S 4323 NR	S 6550 A
with pump DELPHI / con pompa DELPHI	MDR/MDS06.35.40		01/77 > 06/91	S 8600 R	S 8111 NC	S 6550 A
with pump DELPHI / con pompa DELPHI	MDR/MDS06.35.40		01/77 > 06/91	S 8600 R	S 7111 NC	S 6550 A
with pump SIGMA FS300 / con pompa SIGMA FS300	MDR/MDS06.35.40		01/77 > 06/91	S 8600 R	S 0510 NR	S 6550 A
cartridge / immersione	MDR/MDS06.35.40		01/77 > 06/91	S 1910 PO		
inner / interno	MDR/MDS06.35.40		01/77 > 06/91			S 2840 A
TF Serie						
TF230						
some / alcuni	MIDS06.20.30		01/76 > 09/79	S 8600 R	S 3010 N	S 2650 A
some / alcuni	MIDS06.20.30		01/76 > 09/79	S 8600 R	S 3010 N	S 2450 A
spin-on / avvitabile	MIDS06.20.30		01/76 > 09/79	S 8600 R	S 4323 NR	S 2650 A
with pump SIGMA V80 / con pompa SIGMA V80	MIDS06.20.30		01/76 > 09/79	S 8600 R		S 2650 A
inner / interno	MIDS06.20.30		01/76 > 09/79			S 7129 A
inner / interno	MIDS06.20.30		01/76 > 09/79			S 3940 A
TLM Serie						
TLM280						
with pump BOSCH / con pompa BOSCH	MIDS06.35.40D		06/80 > 05/91	S 8600 R	S 3010 N	
with pump BOSCH / con pompa BOSCH	MIDS06.35.40D		06/80 > 05/91	S 8600 R	S 4323 NR	
with pump DELPHI / con pompa DELPHI	MIDS06.35.40D		06/80 > 05/91	S 8600 R	S 7111 NC	
with pump DELPHI / con pompa DELPHI	MIDS06.35.40D		06/80 > 05/91	S 8600 R	S 8111 NC	
with pump SIGMA FS300 / con pompa SIGMA FS300	MIDS06.35.40D		06/80 > 05/91	S 8600 R	S 0510 NR	

R





kW HP



...RENAULT TRUCKS - trucks/autocarri

R

cartridge / immersione	MIDS06.35.40D	06/80 > 05/91	S 1910 PO		
inner / interno	MIDS06.35.40D	06/80 > 05/91			S 2840 A
assembly DONALDSON / montaggio DONALDSON	MIDS06.35.40D	06/80 > 05/91	S 8600 R		S 7945 A
assembly DONALDSON / montaggio DONALDSON	MIDS06.35.40D	06/80 > 05/91	S 8600 R		S 4770 A
assembly DONALDSON / montaggio DONALDSON	MIDS06.35.40D	06/80 > 05/91	S 8600 R		S 8840 A
assembly DONALDSON / montaggio DONALDSON	MIDS06.35.40D	06/80 > 05/91	S 8600 R		S 6550 A
TLR Serie					
TLR280					
some / alcuni	MDS06.35.40	09/75 > 12/82	S 8600 R		S 8840 A
some / alcuni	MDS06.35.40	09/75 > 12/82	S 8600 R		S 7945 A
some / alcuni	MDS06.35.40	09/75 > 12/82	S 8600 R		S 4770 A
with pump BOSCH / con pompa BOSCH	MDS06.35.40	09/75 > 12/82	S 8600 R	S 4323 NR	S 6550 A
with pump BOSCH / con pompa BOSCH	MDS06.35.40	09/75 > 12/82	S 8600 R	S 3010 N	S 6550 A
with pump DELPHI / con pompa DELPHI	MDS06.35.40	09/75 > 12/82	S 8600 R	S 7111 NC	S 6550 A
with pump SIGMA / con pompa SIGMA	MDS06.35.40	09/75 > 12/82	S 8600 R		S 6550 A
cartridge / immersione	MDS06.35.40	09/75 > 12/82	S 1910 PO		
inner / interno	MDS06.35.40	09/75 > 12/82			S 2840 A
or / oppure	MDS06.35.40	09/75 > 12/82	S 8600 R	S 8111 NC	S 6550 A
TR Serie					
TR250					
some / alcuni	M635CP	01/72 > 12/74	S 1910 PO		S 0150 A
with pump BOSCH / con pompa BOSCH	M635CP	01/72 > 12/74	S 1910 PO	S 3010 N	
with pump DELPHI / con pompa DELPHI	M635CP	01/72 > 12/74	S 1910 PO	S 8111 NC	
with pump SIGMA FS300 / con pompa SIGMA FS300	M635CP	01/72 > 12/74	S 1910 PO	S 0510 NR	
inner / interno	M635CP	01/72 > 12/74			S 8940 A
TR260					
with pump BOSCH / con pompa BOSCH	MIDR/MDS06.20.45	05/71 > 12/74	S 8600 R	S 3010 N	S 0150 A
with pump DELPHI / con pompa DELPHI	MIDR/MDS06.20.45	05/71 > 12/74	S 8600 R	S 8111 NC	S 0150 A
with pump SIGMA FS300 / con pompa SIGMA FS300	MIDR/MDS06.20.45	05/71 > 12/74	S 8600 R	S 0510 NR	S 0150 A
cartridge / immersione	MIDR/MDS06.20.45	05/71 > 12/74	S 1910 PO		
inner / interno	MIDR/MDS06.20.45	05/71 > 12/74			S 8940 A
TR280					
some / alcuni	MIDR/MDS/MDS06.35.40 206 280	01/73 > 12/82	S 8600 R		S 8840 A
some / alcuni	MIDR/MDS/MDS06.35.40 206 280	01/73 > 12/82	S 8600 R		S 4770 A
some / alcuni	MIDR/MDS/MDS06.35.40 206 280	01/73 > 12/82	S 8600 R		S 7945 A
some / alcuni	MIDR/MDS/MDS06.35.40 206 280	01/73 > 12/82	S 8600 R		S 6550 A
with pump BOSCH / con pompa BOSCH	MIDR/MDS/MDS06.35.40 206 280	01/73 > 12/82	S 8600 R	S 4323 NR	
with pump BOSCH / con pompa BOSCH	MIDR/MDS/MDS06.35.40 206 280	01/73 > 12/82	S 8600 R	S 3010 N	
with pump SIGMA / con pompa SIGMA	MIDR/MDS/MDS06.35.40 206 280	01/73 > 12/82	S 8600 R		
inner / interno	MIDR/MDS/MDS06.35.40 206 280	01/73 > 12/82			S 2840 A
TR300					
spin-on / avvitabile	V825	10/70 > 12/74	S 8600 R	S 4323 NR	S 0850 A
with pump BOSCH / con pompa BOSCH	V825	10/70 > 12/74		S 3010 N	S 0850 A
cartridge / immersione	V825	10/70 > 12/74	S 1910 PO		S 0850 A
inner / interno	V825	10/70 > 12/74			S 2850 A
TR305					
spin-on / avvitabile	MDR06.35.40		S 8600 R	S 4323 NR	S 8840 A
with pump BOSCH / con pompa BOSCH	MDR06.35.40		S 8600 R	S 3010 N	S 8840 A
with pump SIGMA / con pompa SIGMA	MDR06.35.40		S 8600 R		S 8840 A
TR320					
some / alcuni	MIV08.35.30	09/73 > 09/79	S 1910 PO	S 3010 N	S 8840 A
some / alcuni	MIV08.35.30	09/73 > 09/79		S 3010 N	S 4770 A
some / alcuni	MIV08.35.30	09/73 > 09/79	S 1910 PO		S 0850 A
spin-on / avvitabile	MIV08.35.30	09/73 > 09/79	S 8600 R	S 4323 NR	S 8840 A
inner / interno	MIV08.35.30	09/73 > 09/79			S 2850 A
TR350					
some / alcuni	MIVS08.35.30	08/77 > 12/81	S 8600 R	S 3010 N	S 8840 A
spin-on / avvitabile	MIVS08.35.30	08/77 > 12/81	S 8600 R	S 4323 NR	S 4770 A
with pump BOSCH / con pompa BOSCH	MIVS08.35.30	08/77 > 12/81	S 8600 R	S 3010 N	S 4770 A
with pump SIGMA / con pompa SIGMA	MIVS08.35.30	08/77 > 12/81	S 8600 R		S 4770 A
TRH Serie					
TRH320					
some / alcuni	MIV08.35.30	09/73 > 09/79	S 1910 PO	S 3010 N	S 8840 A
some / alcuni	MIV08.35.30	09/73 > 09/79		S 3010 N	S 4770 A
spin-on / avvitabile	MIV08.35.30	09/73 > 09/79	S 8600 R	S 4323 NR	S 8840 A
TRH350					
some / alcuni	MIVS08.35.30	08/77 > 06/80	S 8600 R	S 3010 N	S 8840 A
spin-on / avvitabile	MIVS08.35.30	08/77 > 06/80	S 8600 R	S 4323 NR	S 4770 A
with pump BOSCH / con pompa BOSCH	MIVS08.35.30	08/77 > 06/80	S 8600 R	S 3010 N	S 4770 A
with pump SIGMA / con pompa SIGMA	MIVS08.35.30	08/77 > 06/80	S 8600 R		S 4770 A



kW HP



...RENAULT TRUCKS - trucks/autocarri

TRM Serie						
TRM320	MIV08.35.30	09/73 > 09/79	S 1910 PO	S 3010 N	S 8840 A	
some / alcuni	MIV08.35.30	09/73 > 09/79	S 1910 PO	S 3010 N	S 4770 A	
spin-on / avvitabile	MIV08.35.30	09/73 > 09/79	S 8600 R	S 4323 NR	S 8840 A	
RENAULT TRUCKS (E)				trucks/autocarri		
D 10 Serie						
D 14 Turbo 150	MWM TD 229-6		S 8600 R		S 2450 A	
D 16 Turbo 150	MWM TD 229-6		S 8600 R		S 2450 A	
D 17	B 26			S 7111 NC	S 2450 A	
power steering / servosterzo	B 26					S 8790 PO
D 100 Serie						
D 170.14	MIDR 06.02.12		S 8600 R		S 2450 A	
D 170.17	MIDR 06.02.12		S 8600 R		S 2450 A	
D 20 Serie						
D 20	B 26			S 7111 NC	S 2450 A	
power steering / servosterzo	B 26					S 8790 PO
D 20 Turbo 200	BS 16			S 7111 NC	S 2650 A	
power steering / servosterzo	BS 16					S 8790 PO
D 200 Serie						
D 210.20	BS 16 A, BSR 16			S 7111 NC	S 2650 A	
D 230.20	BS 16 A, BSR 16			S 7111 NC	S 2650 A	
D 230.26	BS 16 A, BSR 16			S 7111 NC	S 2650 A	
D 270 T	BS 36 A		S 1220 R	S 7111 NC		
D 270.20	BS 36 A		S 1220 R	S 7111 NC	S 0450 A	
D 270.26	BS 36 A		S 1220 R	S 7111 NC		
D 270.34	BS 36 A		S 1220 R	S 7111 NC		
D 270.35	BS 36 A		S 1220 R	S 7111 NC		
D 2000 Serie						
D 2626 Turbo 300	BS 36, BSS 36		S 1220 R	S 7111 NC		
power steering / servosterzo	BS 36, BSS 36					S 8790 PO
D 2626 Turbo 350	BS 36, BSS 36		S 1220 R	S 7111 NC		
power steering / servosterzo	BS 36, BSS 36					S 8790 PO
D 2662 Turbo 200	BS 16			S 7111 NC	S 2650 A	
power steering / servosterzo	BS 16					S 8790 PO
D 2664 Turbo 200	BS 16			S 7111 NC	S 2650 A	
power steering / servosterzo	BS 16					S 8790 PO
D 300 Serie						
D 320 T	BSR 36 C		S 1220 R	S 7111 NC		
D 320.34	BSR 36 C		S 1220 R	S 7111 NC	S 0450 A	
D 320.37	BSR 36 C		S 1220 R	S 7111 NC	S 0450 A	
D 320.38	BSR 36 C		S 1220 R	S 7111 NC		
D 3000 Serie						
D 3064	B 36		S 1220 R	S 7111 NC		
power steering / servosterzo	B 36					S 8790 PO
D 3464 Turbo 300	BS 36, BSS 36		S 1220 R	S 7111 NC		
power steering / servosterzo	BS 36, BSS 36					S 8790 PO
D 3582 Turbo 300	BS 36, BSS 36		S 1220 R	S 7111 NC		
power steering / servosterzo	BS 36, BSS 36					S 8790 PO
D 3582 Turbo 350	BS 36, BSS 36		S 1220 R	S 7111 NC		
power steering / servosterzo	BS 36, BSS 36					S 8790 PO
D 3784 Turbo 300	BS 36		S 1220 R	S 7111 NC		
some / alcuni	BS 36		S 1220 R	S 7111 NC	S 0450 A	
power steering / servosterzo	BS 36					S 8790 PO
D 38 Serie						
D 38 T Turbo 300	BS 36, BSR 36, BSS 36		S 1220 R	S 7111 NC		
power steering / servosterzo	BS 36, BSR 36, BSS 36					S 8790 PO
D 38 T Turbo 350	BS 36, BSR 36, BSS 36		S 1220 R	S 7111 NC		
power steering / servosterzo	BS 36, BSR 36, BSS 36					S 8790 PO
D 38 TR Turbo 300	BS 36, BSR 36, BSS 36		S 1220 R	S 7111 NC		
power steering / servosterzo	BS 36, BSR 36, BSS 36					S 8790 PO
D 38 TR Turbo 355	BS 36, BSR 36, BSS 36		S 1220 R	S 7111 NC		
power steering / servosterzo	BS 36, BSR 36, BSS 36					S 8790 PO
D 38 Turbo 300	BS 36, BSR 36, BSS 36		S 1220 R	S 7111 NC		
power steering / servosterzo	BS 36, BSR 36, BSS 36					S 8790 PO
D 38 Turbo 350	BS 36, BSR 36, BSS 36		S 1220 R	S 7111 NC		
power steering / servosterzo	BS 36, BSR 36, BSS 36					S 8790 PO

R





kW HP



...RENAULT TRUCKS (E) - trucks/autocarri

R

DG 100 Serie							
170.14	MIDR 06.02.12			S 8600 R		S 2450 A	
170.17	MIDR 06.02.12			S 8600 R		S 2450 A	
DG 200 Serie							
210.17	BS 16 A, BSR 16					S 2650 A	
210.20	BS 16 A, BSR 16					S 2650 A	
220.18	MIDR 06.02.26 D			S 0900 R	S 4323 NR	S 2650 A	
220.20	MIDR 06.02.26 D			S 0900 R	S 4323 NR	S 2650 A	
230.20	BS 16 A, BSR 16					S 2650 A	
260.20	MIDR 06.20.45 A			S 8600 R	S 4323 NR		
290 T-GT	MIDR 06.20.45			S 8600 R			
some / alcuni	MIDR 06.20.45			S 8600 R	S 4323 NR		
290.19	MIDR 06.20.45			S 8600 R			
some / alcuni	MIDR 06.20.45			S 8600 R	S 4323 NR		
290.20	MIDR 06.20.45			S 8600 R			
some / alcuni	MIDR 06.20.45			S 8600 R	S 4323 NR		
290.26	MIDR 06.20.45			S 8600 R			
some / alcuni	MIDR 06.20.45			S 8600 R	S 4323 NR		
290.34	MIDR 06.20.45			S 8600 R			
some / alcuni	MIDR 06.20.45			S 8600 R	S 4323 NR		
DG 300 Serie							
320 T	MIDR 06.20.45 H			S 0900 R	S 4323 NR		
320 T-GT	MIDR 06.20.45 H			S 0900 R	S 4323 NR		
320.20	MIDR 06.20.45 H			S 0900 R	S 4323 NR		
320.26	MIDR 06.20.45 H			S 0900 R	S 4323 NR		
320.34	MIDR 06.20.45 H			S 0900 R	S 4323 NR		
320.38	MIDR 06.20.45 H			S 0900 R	S 4323 NR		
DR 300 Serie							
320 T	BSR 36 C			S 1220 R	S 7111 NC		
320.20	BSR 36 C			S 1220 R	S 7111 NC		
320.26	BSR 36 C			S 1220 R	S 7111 NC		
320.35	BSR 36 C			S 1220 R	S 7111 NC		
320.38	BSR 36 C			S 1220 R	S 7111 NC		
340 T	BSR 36 D			S 1220 R	S 7111 NC		
340 T-TI	MIDR 06.35.40 G			S 8600 R	S 4323 NR		
some / alcuni	MIDR 06.35.40 G			S 8600 R	S 4323 NR	S 0450 A	
340 TI	MIDR 06.35.40 G			S 8600 R	S 4323 NR		
some / alcuni	MIDR 06.35.40 G			S 8600 R	S 4323 NR	S 0450 A	
340.20	BSR 36 D			S 1220 R	S 7111 NC		
340.26	BSR 36 D			S 1220 R	S 7111 NC		
340.34	BSR 36 D			S 1220 R	S 7111 NC		
340.34 TI	MIDR 06.35.40 G			S 8600 R	S 4323 NR		
some / alcuni	MIDR 06.35.40 G			S 8600 R	S 4323 NR	S 0450 A	
340.35	BSR 36 D			S 1220 R	S 7111 NC		
340.37	BSR 36 D			S 1220 R	S 7111 NC		
340.37 TI	MIDR 06.35.40 G			S 8600 R	S 4323 NR		
some / alcuni	MIDR 06.35.40 G			S 8600 R	S 4323 NR	S 0450 A	
340.38	BSR 36 D			S 1220 R	S 7111 NC		
365 T	MIDR 06.35.40 G			S 8600 R	S 4323 NR		
some / alcuni	MIDR 06.35.40 G			S 8600 R	S 4323 NR	S 0450 A	
some / alcuni	MIDR 06.35.40 G			S 8600 R	S 4323 NR	S 8840 A	
365.26 TI	MIDR 06.35.40 H			S 8600 R	S 4323 NR		
some / alcuni	MIDR 06.35.40 H			S 8600 R	S 4323 NR	S 0450 A	
some / alcuni	MIDR 06.35.40 H			S 8600 R	S 4323 NR	S 4770 A	
365.38 TI	MIDR 06.35.40 H			S 8600 R	S 4323 NR		
some / alcuni	MIDR 06.35.40 H			S 8600 R	S 4323 NR	S 0450 A	
some / alcuni	MIDR 06.35.40 H			S 8600 R	S 4323 NR	S 4770 A	

RENAULT V.I.

buses/autobus

Agora

Agora	MIDR06.20.45	02/96 > 03/06	S 3698 R		S 7343 A	
with automatic gearbox ZF HP500 / con cambio automatico ZF HP500	MIDR06.20.45	02/96 > 03/06				S 2234 Z
dryer filter / filtro essiccatore	MIDR06.20.45	02/96 > 03/06				S 7259 A
hydrostatic steering / guida idrostatica	MIDR06.20.45	02/96 > 03/06				S 8137 RH
inner / interno	MIDR06.20.45	02/96 > 03/06			S 7342 A	
2 filters / N.2 filtri	MIDR06.20.45	02/96 > 03/06		S 4323 NR		
power steering / servosterzo	MIDR06.20.45	02/96 > 03/06				S 3081 PO

**kW HP****...RENAULT V.I. - buses/autobus**

Agora CNG	Iveco Cursor8 CNG	180	245	09/03	>	03/06	S 3288 R		S 7575 A	
with automatic gearbox ZF HP502 / con cambio automatico ZF HP502	Iveco Cursor8 CNG	180	245	09/03	>	03/06				S 2234 Z
with air-conditioner WEBASTO Aerosphere / con climatizzatore WEBASTO Aerosphere	Iveco Cursor8 CNG	180	245	09/03	>	03/06				S 3081 C
dryer filter / filtro essiccatore	Iveco Cursor8 CNG	180	245	09/03	>	03/06				S 7259 A
VGT filter / filtro VGT	Iveco Cursor8 CNG	180	245	09/03	>	03/06				S 0VGT A
Agora CNG	Iveco Cursor8 CNG	213	290	09/03	>	03/06	S 3288 R		S 7575 A	
with automatic gearbox ZF HP502 / con cambio automatico ZF HP502	Iveco Cursor8 CNG	213	290	09/03	>	03/06				S 2234 Z
with air-conditioner WEBASTO Aerosphere / con climatizzatore WEBASTO Aerosphere	Iveco Cursor8 CNG	213	290	09/03	>	03/06				S 3081 C
dryer filter / filtro essiccatore	Iveco Cursor8 CNG	213	290	09/03	>	03/06				S 7259 A
VGT filter / filtro VGT	Iveco Cursor8 CNG	213	290	09/03	>	03/06				S 0VGT A
Agora L (Euro 3)	Aifo-Iveco Cursor 8			01/02	>	03/06	S 3288 R	S 4396 NR	S 7575 A	
with automatic gearbox and hydraulic retarder ZF Ecosplit + Intarder / con cambio automatico e rallentatore idraulico ZF Ecosplit + Intarder	Aifo-Iveco Cursor 8			01/02	>	03/06				S 2234 Z
with automatic gearbox ZF HP500 / con cambio automatico ZF HP500	Aifo-Iveco Cursor 8			01/02	>	03/06				S 2234 Z
with air-conditioner WEBASTO Aerosphere / con climatizzatore WEBASTO Aerosphere	Aifo-Iveco Cursor 8			01/02	>	03/06				S 3081 C
dryer filter / filtro essiccatore	Aifo-Iveco Cursor 8			01/02	>	03/06				S 7259 A
VGT filter / filtro VGT	Aifo-Iveco Cursor 8			01/02	>	03/06				S 0VGT A
Agora S (Euro 3)	Aifo-Iveco Cursor 8			01/02	>	03/06	S 3288 R	S 4396 NR	S 7575 A	
with automatic gearbox and hydraulic retarder ZF Ecosplit + Intarder / con cambio automatico e rallentatore idraulico ZF Ecosplit + Intarder	Aifo-Iveco Cursor 8			01/02	>	03/06				S 2234 Z
with automatic gearbox ZF HP500 / con cambio automatico ZF HP500	Aifo-Iveco Cursor 8			01/02	>	03/06				S 2234 Z
with air-conditioner WEBASTO Aerosphere / con climatizzatore WEBASTO Aerosphere	Aifo-Iveco Cursor 8			01/02	>	03/06				S 3081 C
dryer filter / filtro essiccatore	Aifo-Iveco Cursor 8			01/02	>	03/06				S 7259 A
VGT filter / filtro VGT	Aifo-Iveco Cursor 8			01/02	>	03/06				S 0VGT A
Ares										
300	MIDR06.20.45	222	302	09/97	>		S 0900 R		S 7284 A	
dryer filter / filtro essiccatore	MIDR06.20.45	222	302	09/97	>					S 7259 A
2 filters / N.2 filtri	MIDR06.20.45	222	302	09/97	>		S 4323 NR			
power steering / servosterzo	MIDR06.20.45	222	302	09/97	>					S 3081 PO
340	MIDR06.20.45	249	340	09/97	>		S 0900 R		S 7284 A	
dryer filter / filtro essiccatore	MIDR06.20.45	249	340	09/97	>					S 7259 A
dryer filter WABCO, right-hand thread / filtro essiccatore WABCO, filetto destro	MIDR06.20.45	249	340	09/97	>					S 7A66 A
2 filters / N.2 filtri	MIDR06.20.45	249	340	09/97	>		S 4323 NR			
power steering / servosterzo	MIDR06.20.45	249	340	09/97	>					S 3081 PO
380	MIDR06.23.56	280	381	07/00	>		S 0900 R		S 7284 A	
dryer filter / filtro essiccatore	MIDR06.23.56	280	381	07/00	>					S 7259 A
dryer filter WABCO, right-hand thread / filtro essiccatore WABCO, filetto destro	MIDR06.23.56	280	381	07/00	>					S 7A66 A
2 filters / N.2 filtri	MIDR06.23.56	280	381	07/00	>		S 4323 NR			
rotor for oil centrifuge / rotore per filtro olio centrifugo	MIDR06.23.56	280	381	07/00	>					S 5900 PO
power steering / servosterzo	MIDR06.23.56	280	381	07/00	>					S 3081 PO
Axer										
12 m	Aifo-Iveco Cursor 8	228	310	09/02	>		S 3288 R	S 4396 NR	S 7637 A	
with automatic gearbox ZF HP592 / con cambio automatico ZF HP592	Aifo-Iveco Cursor 8	228	310	09/02	>					S 2234 Z
with air-conditioner WEBASTO Aerosphere / con climatizzatore WEBASTO Aerosphere	Aifo-Iveco Cursor 8	228	310	09/02	>					S 3081 C
dryer filter / filtro essiccatore	Aifo-Iveco Cursor 8	228	310	09/02	>					S 7259 A
dryer filter WABCO, right-hand thread / filtro essiccatore WABCO, filetto destro	Aifo-Iveco Cursor 8	228	310	09/02	>					S 7A66 A
VGT filter / filtro VGT	Aifo-Iveco Cursor 8	228	310	09/02	>					S 0VGT A
inner / interno	Aifo-Iveco Cursor 8	228	310	09/02	>			S 7649 A		
prefilter / prefiltra	Aifo-Iveco Cursor 8	228	310	09/02	>		S 0999 NR			
power steering / servosterzo	Aifo-Iveco Cursor 8	228	310	09/02	>					S 3081 PO
12 m	Aifo-Iveco Cursor 8	259	352	09/02	>		S 3288 R	S 4396 NR	S 7637 A	
with automatic gearbox ZF HP592 / con cambio automatico ZF HP592	Aifo-Iveco Cursor 8	259	352	09/02	>					S 2234 Z
with air-conditioner WEBASTO Aerosphere / con climatizzatore WEBASTO Aerosphere	Aifo-Iveco Cursor 8	259	352	09/02	>					S 3081 C
dryer filter / filtro essiccatore	Aifo-Iveco Cursor 8	259	352	09/02	>					S 7259 A
dryer filter WABCO, right-hand thread / filtro essiccatore WABCO, filetto destro	Aifo-Iveco Cursor 8	259	352	09/02	>					S 7A66 A
VGT filter / filtro VGT	Aifo-Iveco Cursor 8	259	352	09/02	>					S 0VGT A
inner / interno	Aifo-Iveco Cursor 8	259	352	09/02	>			S 7649 A		
prefilter / prefiltra	Aifo-Iveco Cursor 8	259	352	09/02	>		S 0999 NR			
power steering / servosterzo	Aifo-Iveco Cursor 8	259	352	09/02	>					S 3081 PO
12.8 m	Aifo-Iveco Cursor 8	228	310	09/02	>		S 3288 R	S 4396 NR	S 7637 A	
with automatic gearbox ZF HP592 / con cambio automatico ZF HP592	Aifo-Iveco Cursor 8	228	310	09/02	>					S 2234 Z
with air-conditioner WEBASTO Aerosphere / con climatizzatore WEBASTO Aerosphere	Aifo-Iveco Cursor 8	228	310	09/02	>					S 3081 C
dryer filter / filtro essiccatore	Aifo-Iveco Cursor 8	228	310	09/02	>					S 7259 A
dryer filter WABCO, right-hand thread / filtro essiccatore WABCO, filetto destro	Aifo-Iveco Cursor 8	228	310	09/02	>					S 7A66 A
VGT filter / filtro VGT	Aifo-Iveco Cursor 8	228	310	09/02	>					S 0VGT A
inner / interno	Aifo-Iveco Cursor 8	228	310	09/02	>			S 7649 A		
prefilter / prefiltra	Aifo-Iveco Cursor 8	228	310	09/02	>		S 0999 NR			
power steering / servosterzo	Aifo-Iveco Cursor 8	228	310	09/02	>					S 3081 PO
12.8 m	Aifo-Iveco Cursor 8	259	352	09/02	>		S 3288 R	S 4396 NR	S 7637 A	

R



kW HP



...RENAULT V.I. - buses/autobus

R

with automatic gearbox ZF HP592 / con cambio automatico ZF HP592	Aifo-Iveco Cursor 8	259	352	09/02	>				S 2234 Z
with air-conditioner WEBASTO Aerosphere / con climatizzatore WEBASTO Aerosphere	Aifo-Iveco Cursor 8	259	352	09/02	>				S 3081 C
dryer filter / filtro essiccatore	Aifo-Iveco Cursor 8	259	352	09/02	>				S 7259 A
dryer filter WABCO, right-hand thread / filtro essiccatore WABCO, filetto destro	Aifo-Iveco Cursor 8	259	352	09/02	>				S 7A66 A
VGT filter / filtro VGT	Aifo-Iveco Cursor 8	259	352	09/02	>				S 0VGT A
inner / interno	Aifo-Iveco Cursor 8	259	352	09/02	>			S 7649 A	
prefilter / prefiltra	Aifo-Iveco Cursor 8	259	352	09/02	>		S 0999 NR		
power steering / servosterzo	Aifo-Iveco Cursor 8	259	352	09/02	>				S 3081 PO
Crusair									
PR 100	V800						S 1910 PO		S 2450 A
some / alcuni	V800						S 8600 R		S 0450 A
PR2	Detroit Diesel						S 3301 PO		S 0450 A
some / alcuni	Detroit Diesel						S 3301 PO		S 0840 A
inner / interno	Detroit Diesel								S 1450 A
PR2 A	V800						S 1910 PO		S 2450 A
some / alcuni	V800						S 8600 R		S 0450 A
PR3	Detroit Diesel						S 3301 PO		S 0450 A
some / alcuni	Detroit Diesel						S 3301 PO		S 0840 A
inner / interno	Detroit Diesel								S 1450 A
PR3 A	Detroit Diesel						S 3301 PO		S 0450 A
some / alcuni	Detroit Diesel						S 3301 PO		S 0840 A
inner / interno	Detroit Diesel								S 1450 A
PR3 A	V800						S 1910 PO		S 2450 A
some / alcuni	V800						S 8600 R		S 0450 A
E1									
E1									
spin-on / avvitabile	MIDR06.20.45							S 4323 NR	
with pump BOSCH / con pompa BOSCH	MIDR06.20.45			>	09/88		S 3106 R	S 3010 N	
with pump BOSCH / con pompa BOSCH	MIDR06.20.45			10/88	>		S 0900 R	S 4323 NR	
E2									
E2									
spin-on / avvitabile	MIDR06.20.45							S 4323 NR	
with BOSCH pump / con pompa BOSCH	MIDR06.20.45			>	09/88		S 8600 R	S 3010 N	
with BOSCH pump / con pompa BOSCH	MIDR06.20.45			10/88	>		S 0900 R	S 3010 N	
ER Serie									
ER100									
with pump BOSCH / con pompa BOSCH	MIDS/MIPS06.20.30						S 8600 R	S 4323 NR	S 2450 A
with pump BOSCH / con pompa BOSCH	MIDS/MIPS06.20.30						S 8600 R	S 3010 N	S 0450 A
with pump BOSCH / con pompa BOSCH	MIDS/MIPS06.20.30						S 8600 R	S 3010 N	S 2450 A
with pump SIGMA V80 / con pompa SIGMA V80	MIDS/MIPS06.20.30						S 8600 R		S 0450 A
with pump SIGMA V80 / con pompa SIGMA V80	MIDS/MIPS06.20.30						S 8600 R		S 2450 A
inner / interno	MIDS/MIPS06.20.30								S 3940 A
inner / interno	MIDS/MIPS06.20.30								S 1450 A
FR1									
FR1									
some DONALDSON / alcuni DONALDSON	Mack EE 6-335	250	340	01/84	>	07/99			✗
dryer filter / filtro essiccatore	Mack EE 6-335	250	340	01/84	>	07/99			S 7259 A
hydrostatic steering / guida idrostatica	Mack EE 6-335	250	340	01/84	>	07/99			S 8605 HP
inner DONALDSON / interno DONALDSON	Mack EE 6-335	250	340	01/84	>	07/99			S 2840 A
inner DONALDSON FHG120 / interno DONALDSON FHG120	Mack EE 6-335	250	340	01/84	>	07/99			S 8940 A
assembly DONALDSON EBG140 / montaggio DONALDSON EBG140	Mack EE 6-335	250	340	01/84	>	07/99			S 7368 A
assembly DONALDSON FHG120 / montaggio DONALDSON FHG120	Mack EE 6-335	250	340	01/84	>	07/99			S 0150 A
assembly PERMATIC FO2312 / montaggio PERMATIC FO2312	Mack EE 6-335	250	340	01/84	>	07/99			S 7A24 A
2 filters / N.2 filtri	Mack EE 6-335	250	340	01/84	>	09/88	S 8600 R		
2 filters / N.2 filtri	Mack EE 6-335	250	340	10/88	>	07/99	S 0900 R		
2 filters spin-on / N.2 filtri avvitabile	Mack EE 6-335	250	340	01/84	>	07/99		S 4323 NR	
2 filters cartridge / N.2 filtri immersione	Mack EE 6-335	250	340	01/84	>	07/99		S 3010 N	
2 filters LONG LIFE / N.2 filtri LONG LIFE	Mack EE 6-335	250	340	01/84	>	07/99		S 4471 NR	
FR1	MIDR06.20.45C	250	340	10/82	>	07/99			✗
with BOSCH pump 2 filters / con pompa BOSCH N.2 filtri	MIDR06.20.45C	250	340	10/82	>	07/99		S 4323 NR	
dryer filter / filtro essiccatore	MIDR06.20.45C	250	340	01/93	>	07/99			S 7259 A
hydrostatic steering / guida idrostatica	MIDR06.20.45C	250	340	10/82	>	07/99			S 8605 HP
inner DONALDSON / interno DONALDSON	MIDR06.20.45C	250	340	10/82	>	07/99			S 2840 A
inner DONALDSON FHG120 / interno DONALDSON FHG120	MIDR06.20.45C	250	340	10/82	>	07/99			S 8940 A
assembly DONALDSON / montaggio DONALDSON	MIDR06.20.45C	250	340	10/82	>	07/99			S 6550 A
assembly DONALDSON EBG140 / montaggio DONALDSON EBG140	MIDR06.20.45C	250	340	10/82	>	07/99			S 7368 A
assembly DONALDSON FHG120 / montaggio DONALDSON FHG120	MIDR06.20.45C	250	340	10/82	>	07/99			S 0150 A



kW HP



...RENAULT V.I. - buses/autobus

assembly PERMATIC FO2312 / montaggio PERMATIC FO2312	MIDR06.20.45C	250 340	10/82 > 07/99			S 7A24 A	
2 filters / N.2 filtri	MIDR06.20.45C	250 340	10/82 > 09/88	S 8600 R			
2 filters / N.2 filtri	MIDR06.20.45C	250 340	10/88 > 07/99	S 0900 R			
2 filters cartridge / N.2 filtri immersione	MIDR06.20.45C	250 340	10/82 > 07/99		S 3010 N		
2 filters LONG LIFE / N.2 filtri LONG LIFE	MIDR06.20.45C	250 340	10/82 > 07/99		S 4471 NR		
rotor for oil centrifuge / rotore per filtro olio centrifugo	MIDR06.20.45C	250 340	10/89 > 07/99	S 5900 PO			
GT							
GT							
some / alcuni	MIDR06.20.45		10/80 >		S 3010 N	S 6550 A	
spin-on / avvitabile	MIDR06.20.45		10/80 >		S 4323 NR		
with BOSCH pump / con pompa BOSCH	MIDR06.20.45		10/80 > 09/88	S 8600 R	S 3010 N		
with BOSCH pump / con pompa BOSCH	MIDR06.20.45		10/88 >	S 0900 R	S 3010 N		
inner / interno	MIDR06.20.45		10/80 >			S 2840 A	
GT1							
GT1	Mack EE 6335			S 0900 R			
GT2							
GT2	Mack EE 6335			S 0900 R			
GTS							
GTS	Mack EE 6335			S 0900 R			
GTS							
spin-on / avvitabile	MIDR06.20.45				S 4323 NR		
with BOSCH pump / con pompa BOSCH	MIDR06.20.45		> 09/88	S 8600 R	S 3010 N		
with BOSCH pump / con pompa BOSCH	MIDR06.20.45		10/88 >	S 0900 R	S 3010 N		
Iliade							
300	MIDR06.20.45		02/96 > 03/07	S 0900 R	S 4323 NR	S 7284 A	
with gearbox ZF Ecosplit + Intarder / con cambio ZF Ecosplit + Intarder	MIDR06.20.45		02/96 > 03/07				S 2234 Z
with air-conditioner WEBASTO Aerosphere / con climatizzatore WEBASTO Aerosphere	MIDR06.20.45		02/96 > 03/07				S 3081 C
dryer filter / filtro essiccatore	MIDR06.20.45		02/96 > 03/07				S 7259 A
power steering / servosterzo	MIDR06.20.45		02/96 > 03/07				S 3081 PO
340	MIDR06.20.45		02/96 > 03/07	S 0900 R	S 4323 NR	S 7284 A	
with gearbox ZF Ecosplit + Intarder / con cambio ZF Ecosplit + Intarder	MIDR06.20.45		02/96 > 03/07				S 2234 Z
with air-conditioner WEBASTO Aerosphere / con climatizzatore WEBASTO Aerosphere	MIDR06.20.45		02/96 > 03/07				S 3081 C
dryer filter / filtro essiccatore	MIDR06.20.45		02/96 > 03/07				S 7259 A
power steering / servosterzo	MIDR06.20.45		02/96 > 03/07				S 3081 PO
385	MIDR06.23.56		02/96 > 03/07	S 0900 R	S 4323 NR	S 7284 A	
with gearbox ZF Ecosplit + Intarder / con cambio ZF Ecosplit + Intarder	MIDR06.23.56		02/96 > 03/07				S 2234 Z
with air-conditioner WEBASTO Aerosphere / con climatizzatore WEBASTO Aerosphere	MIDR06.23.56		02/96 > 03/07				S 3081 C
dryer filter / filtro essiccatore	MIDR06.23.56		02/96 > 03/07				S 7259 A
power steering / servosterzo	MIDR06.23.56		02/96 > 03/07				S 3081 PO
PR Serie							
PR10 S							
some / alcuni	MIDS06.20.30			S 8600 R	S 3010 N	S 0550 A	
spin-on / avvitabile	MIDS06.20.30			S 8600 R	S 4323 NR		
with pump BOSCH / con pompa BOSCH	MIDS06.20.30			S 8600 R	S 3010 N	S 2650 A	
with pump SIGMA / con pompa SIGMA	MIDS06.20.30			S 8600 R		S 2650 A	
inner / interno	MIDS06.20.30					S 7129 A	
PR100							
with BOSCH pump / con pompa BOSCH	MIDS/MIPS06.20.30		06/80 > 12/84	S 8600 R	S 3010 N	S 2450 A	
with BOSCH pump / con pompa BOSCH	MIDS/MIPS06.20.30		06/80 > 12/84	S 8600 R	S 3010 N	S 0450 A	
with BOSCH pump / con pompa BOSCH	MIDS/MIPS06.20.30		06/80 > 12/84	S 8600 R	S 4323 NR	S 2450 A	
with SIGMA pump / con pompa SIGMA	MIDS/MIPS06.20.30		06/80 > 12/84	S 8600 R		S 2450 A	
with SIGMA pump / con pompa SIGMA	MIDS/MIPS06.20.30		06/80 > 12/84	S 8600 R		S 0450 A	
inner / interno	MIDS/MIPS06.20.30		06/80 > 12/84			S 3940 A	
inner / interno	MIDS/MIPS06.20.30		06/80 > 12/84			S 1450 A	
automatic drive VOITH D851.2/D851.3 / trasmissione automatica VOITH D851.2/D851.3	MIDS/MIPS06.20.30		06/80 > 12/84				S 6449 PO
PR100	Perkins V8.510			S 4380 PO		S 2450 A	
some / alcuni	Perkins V8.510			S 4380 PO		S 0450 A	
inner / interno	Perkins V8.510					S 1450 A	
inner / interno	Perkins V8.510					S 3940 A	
PR100	V800			S 1910 PO		S 2450 A	
some / alcuni	V800			S 1910 PO		S 0450 A	
inner / interno	V800					S 3940 A	
inner / interno	V800					S 1450 A	
PR100 PA	Perkins V8.510			S 4380 PO		S 2450 A	
some / alcuni	Perkins V8.510			S 4380 PO		S 0450 A	
inner / interno	Perkins V8.510					S 3940 A	
inner / interno	Perkins V8.510					S 1450 A	

R





kW HP



...RENAULT V.I. - buses/autobus

R

PR100 PA	V800				S 1910 PO		S 2450 A	
some / alcuni	V800				S 1910 PO		S 0450 A	
inner / interno	V800						S 3940 A	
inner / interno	V800						S 1450 A	
PR100 PRS	Perkins V8.510				S 4380 PO		S 2450 A	
some / alcuni	Perkins V8.510				S 4380 PO		S 0450 A	
inner / interno	Perkins V8.510						S 3940 A	
inner / interno	Perkins V8.510						S 1450 A	
PR100 PRS	V800				S 1910 PO		S 2450 A	
some / alcuni	V800				S 1910 PO		S 0450 A	
inner / interno	V800						S 3940 A	
inner / interno	V800						S 1450 A	
PR100-2	MIPR06.20.45	186	253	10/92 >	S 0900 R	S 4323 NR		
automatic drive VOITH D851.2/D851.3 / trasmissione automatica VOITH D851.2/D851.3	MIPR06.20.45	186	253	10/92 >				S 6449 PO
PR12 S								
some / alcuni	MIDS06.20.30				S 8600 R	S 3010 N	S 0550 A	
spin-on / avvitabile	MIDS06.20.30				S 8600 R	S 4323 NR		
with pump BOSCH / con pompa BOSCH	MIDS06.20.30				S 8600 R	S 3010 N	S 2650 A	
with pump SIGMA / con pompa SIGMA	MIDS06.20.30				S 8600 R		S 2650 A	
inner / interno	MIDS06.20.30						S 7129 A	
PR14 S								
some / alcuni	MIDR06.20.30				S 8600 R	S 3010 N	S 0450 A	
with BOSCH pump / con pompa BOSCH	MIDR06.20.30				S 8600 R	S 3010 N	S 4770 A	
or / oppure	MIDR06.20.30				S 8600 R	S 4323 NR	S 4770 A	
PR14 S								
some / alcuni	MIDS06.20.30				S 8600 R	S 3010 N	S 0550 A	
spin-on / avvitabile	MIDS06.20.30				S 8600 R	S 4323 NR		
with pump BOSCH / con pompa BOSCH	MIDS06.20.30				S 8600 R	S 3010 N	S 2650 A	
with pump SIGMA / con pompa SIGMA	MIDS06.20.30				S 8600 R		S 2650 A	
inner / interno	MIDS06.20.30						S 7129 A	
PR14 SL								
some / alcuni	MIDR06.20.30				S 8600 R	S 3010 N	S 0450 A	
with BOSCH pump / con pompa BOSCH	MIDR06.20.30				S 8600 R	S 3010 N	S 4770 A	
or / oppure	MIDR06.20.30				S 8600 R	S 4323 NR	S 4770 A	
PR14 SL								
some / alcuni	MIDS06.20.30				S 8600 R	S 3010 N	S 0550 A	
spin-on / avvitabile	MIDS06.20.30				S 8600 R	S 4323 NR		
with pump BOSCH / con pompa BOSCH	MIDS06.20.30				S 8600 R	S 3010 N	S 2650 A	
with pump SIGMA / con pompa SIGMA	MIDS06.20.30				S 8600 R		S 2650 A	
inner / interno	MIDS06.20.30						S 7129 A	
PR14 SR								
some / alcuni	MIDR06.20.30				S 8600 R	S 3010 N	S 0450 A	
with BOSCH pump / con pompa BOSCH	MIDR06.20.30				S 8600 R	S 3010 N	S 4770 A	
or / oppure	MIDR06.20.30				S 8600 R	S 4323 NR	S 4770 A	
PR14 SR								
some / alcuni	MIDS06.20.30				S 8600 R	S 3010 N	S 0550 A	
spin-on / avvitabile	MIDS06.20.30				S 8600 R	S 4323 NR		
with pump BOSCH / con pompa BOSCH	MIDS06.20.30				S 8600 R	S 3010 N	S 2650 A	
with pump SIGMA / con pompa SIGMA	MIDS06.20.30				S 8600 R		S 2650 A	
inner / interno	MIDS06.20.30						S 7129 A	
PR180								
with BOSCH pump / con pompa BOSCH	MIDS/MIPS06.20.30			06/80 > 12/89	S 8600 R	S 4323 NR	S 2450 A	
with BOSCH pump / con pompa BOSCH	MIDS/MIPS06.20.30			06/80 > 12/89	S 8600 R	S 3010 N	S 0450 A	
with BOSCH pump / con pompa BOSCH	MIDS/MIPS06.20.30			06/80 > 12/89	S 8600 R	S 3010 N	S 2450 A	
with SIGMA pump / con pompa SIGMA	MIDS/MIPS06.20.30			06/80 > 12/89	S 8600 R		S 0450 A	
with SIGMA pump / con pompa SIGMA	MIDS/MIPS06.20.30			06/80 > 12/89	S 8600 R		S 2450 A	
inner / interno	MIDS/MIPS06.20.30			06/80 > 12/89			S 1450 A	
inner / interno	MIDS/MIPS06.20.30			06/80 > 12/89			S 3940 A	
automatic drive VOITH D851.2/D851.3 / trasmissione automatica VOITH D851.2/D851.3	MIDS/MIPS06.20.30			06/80 > 12/89				S 6449 PO
PR180-2	MIPR06.20.45	222	302	10/92 >	S 0900 R	S 4323 NR		
automatic drive VOITH D851.2/D851.3 / trasmissione automatica VOITH D851.2/D851.3	MIPR06.20.45	222	302	10/92 >				S 6449 PO
PR40								
some / alcuni	MIDR06.20.30				S 8600 R	S 3010 N	S 0450 A	
with BOSCH pump / con pompa BOSCH	MIDR06.20.30				S 8600 R	S 3010 N	S 4770 A	
or / oppure	MIDR06.20.30				S 8600 R	S 4323 NR	S 4770 A	
PR40 S								
some / alcuni	MIDR06.20.30				S 8600 R	S 3010 N	S 0450 A	



kW HP



...RENAULT V.I. - buses/autobus

with BOSCH pump / con pompa BOSCH or / oppure	MIDR06.20.30 MIDR06.20.30			S 8600 R S 8600 R	S 3010 N S 4323 NR	S 4770 A S 4770 A	
PX Serie							
PX40 VT							
some / alcuni	MIDR06.20.30			S 8600 R	S 4323 NR	S 0450 A	
with pump BOSCH / con pompa BOSCH	MIDR06.20.30			S 8600 R	S 3010 N	S 4770 A	
or / oppure	MIDR06.20.30			S 8600 R	S 3010 N	S 0450 A	
PX40 VTS							
some / alcuni	MIDR06.20.30			S 8600 R	S 4323 NR	S 4770 A	
with pump BOSCH / con pompa BOSCH	MIDR06.20.30			S 8600 R	S 3010 N	S 4770 A	
or / oppure	MIDR06.20.30			S 8600 R	S 3010 N	S 0450 A	
R Serie							
R312	MIDR/MIDS06.20.45	01/91 > 06/96				S 7368 A	
some DONALDSON / alcuni DONALDSON	MIDR/MIDS06.20.45	01/91 > 06/96				S 7343 A	
some 2 filters (1 1/8-16 UN) / alcuni N.2 filtri (1 1/8-16 UN)	MIDR/MIDS06.20.45	01/91 > 06/96		S 0900 R			
with automatic gearbox ZF HP500 / con cambio automatico ZF HP500	MIDR/MIDS06.20.45	01/91 > 06/96					S 2234 Z
dryer filter / filtro essiccatore	MIDR/MIDS06.20.45	01/91 > 06/96					S 7259 A
inner / interno	MIDR/MIDS06.20.45	01/91 > 06/96				S 2840 A	
assembly PERMATIC / montaggio PERMATIC	MIDR/MIDS06.20.45	01/91 > 06/96				S 7A24 A	
2 filters / N.2 filtri	MIDR/MIDS06.20.45	01/91 > 06/96		S 8600 R	S 4323 NR		
power steering / servosterzo	MIDR/MIDS06.20.45	01/91 > 06/96					S 3081 PO
automatic drive VOITH D851.2/D851.3 / trasmissione automatica VOITH D851.2/D851.3	MIDR/MIDS06.20.45	01/91 > 06/96					S 6449 PO
Recreo							
C 935	MIHR06.20.45	188 256	09/96 > 03/07			S 7343 A	
dryer filter / filtro essiccatore	MIHR06.20.45	188 256	09/96 > 03/07				S 7259 A
inner / interno	MIHR06.20.45	188 256	09/96 > 03/07			S 7342 A	
2 filters / N.2 filtri	MIHR06.20.45	188 256	09/96 > 03/07	S 3698 R	S 4323 NR		
power steering / servosterzo	MIHR06.20.45	188 256	09/96 > 03/07				S 3081 PO
automatic drive VOITH 851.2/851.3 / trasmissione automatica VOITH 851.2/851.3	MIHR06.20.45	188 256	09/96 > 03/07				S 6449 PO
S Serie							
S105 M							
with pump BOSCH / con pompa BOSCH	597 Diesel			S 3241 R	S 9091 N		
with pump DELPHI / con pompa DELPHI	597 Diesel			S 3241 R	S 7111 NC		
S45 GT							
with pump BOSCH / con pompa BOSCH	597 Diesel			S 3241 R	S 9091 N		
with pump DELPHI / con pompa DELPHI	597 Diesel			S 3241 R	S 7111 NC		
S45 R	MAN D0836 HM8U				S 7411 N		
S53 M							
with pump BOSCH / con pompa BOSCH	597 Diesel			S 3241 R	S 9091 N		
with pump DELPHI / con pompa DELPHI	597 Diesel			S 3241 R	S 7111 NC		
S53 R	MAN D0836 HM8U				S 7411 N		
SC Serie							
SC10	MAN D0836 HM8U	118 160			S 7411 N		
T1							
T1	Mack EE 6335			S 0900 R			
T1							
spin-on / avvitabile	MIDR06.20.45				S 4323 NR		
with BOSCH pump / con pompa BOSCH	MIDR06.20.45		> 09/88	S 8600 R	S 3010 N		
with BOSCH pump / con pompa BOSCH	MIDR06.20.45		10/88 >	S 0900 R	S 3010 N		
TR Serie							
TR14							
with pump BOSCH / con pompa BOSCH	MIDS06.20.30			S 8600 R	S 3010 N	S 0550 A	
with pump BOSCH / con pompa BOSCH	MIDS06.20.30			S 8600 R	S 3010 N	S 2650 A	
with pump SIGMA / con pompa SIGMA	MIDS06.20.30			S 8600 R		S 0550 A	
with pump SIGMA / con pompa SIGMA	MIDS06.20.30			S 8600 R		S 2650 A	
inner / interno	MIDS06.20.30					S 7129 A	
TR2000							
some / alcuni				S 8600 R	S 3010 N	S 7974 A	
some / alcuni				S 8600 R	S 7111 NC	S 7974 A	
some / alcuni				S 8600 R	S 4323 NR	S 7974 A	
TR4000							
some / alcuni				S 8600 R	S 3010 N	S 7974 A	
some / alcuni				S 8600 R	S 4323 NR	S 7974 A	
some / alcuni				S 8600 R	S 7111 NC	S 7974 A	
TRM10000							
some / alcuni				S 8600 R	S 4323 NR	S 2650 A	
some / alcuni				S 8600 R	S 4323 NR	S 0450 A	
some / alcuni				S 8600 R	S 4323 NR	S 6550 A	
TRM2000							
some / alcuni				S 8600 R	S 3010 N	S 7974 A	
some / alcuni				S 8600 R	S 7111 NC	S 7974 A	

R





kW HP



...RENAULT V.I. - buses/autobus

S



some / alcuni					S 8600 R	S 4323 NR	S 7974 A	
TRM4000					S 8600 R	S 3010 N	S 7974 A	
some / alcuni					S 8600 R	S 7111 NC	S 7974 A	
some / alcuni					S 8600 R	S 4323 NR	S 7974 A	
TRM9000					S 8600 R	S 4323 NR	S 2650 A	
some / alcuni					S 8600 R	S 4323 NR	S 0450 A	

Tracer

Tracer	MIDR06.20.45	186 253	09/92 >		S 8600 R	S 4323 NR		
some / alcuni	MIDR06.20.45	186 253	09/92 >		S 8600 R	S 4323 NR		
with automatic gearbox ZF HP500/590 / con cambio automatico ZF HP500/590	MIDR06.20.45	186 253	09/92 >					S 2234 Z
dryer filter / filtro essiccatore	MIDR06.20.45	186 253	09/92 >					S 7259 A
inner / interno	MIDR06.20.45	186 253	09/92 >				S 2840 A	
power steering / servosterzo	MIDR06.20.45	186 253	09/92 >					S 3081 PO
automatic drive VOITH 851.2/851.3 / trasmissione automatica VOITH 851.2/851.3	MIDR06.20.45	186 253	09/92 >					S 6449 PO

RENAULT V.I. (E)**buses/autobus****A 200 Serie**

A 290	MIDR 06.20.45				S 8600 R		S 0450 A	
--------------	---------------	--	--	--	----------	--	----------	--

A 300 Serie

A 320	BSR 36 C				S 1220 R		S 0450 A	
some / alcuni	BSR 36 C				S 1220 R	S 7111 NC	S 0450 A	

D 200 Serie

D 250	BS 16					S 7111 NC	S 2650 A	
--------------	-------	--	--	--	--	-----------	----------	--

D 300 Serie

D 300	BS 36				S 1220 R	S 7111 NC	S 0450 A	
--------------	-------	--	--	--	----------	-----------	----------	--

PR Serie

100	BS 16					S 7111 NC	S 2650 A	
100 PA	Perkins V8.510				S 4380 PO		S 0450 A	

SCANIA**buses/autobus****112 Serie**

F 112	DN 11.07		10/81 > 01/95			S 4323 NR	S 0050 A	
some / alcuni	DN 11.07		01/84 > 01/95			S 8501 NR	S 0050 A	
dryer filter / filtro essiccatore	DN 11.07		01/85 > 01/95					S 7259 A
power steering / servosterzo	DN 11.07		10/81 > 01/95					S 3081 PO
turbocompressor / turbocompressore	DN 11.07		10/81 > 01/95		S 2329 R			
F 112	DS 11.15		10/81 > 01/95			S 4323 NR	S 0050 A	
some / alcuni	DS 11.15		01/84 > 01/95			S 8501 NR	S 0050 A	
dryer filter / filtro essiccatore	DS 11.15		01/85 > 01/95					S 7259 A
power steering / servosterzo	DS 11.15		10/81 > 01/95					S 3081 PO
turbocompressor / turbocompressore	DS 11.15		10/81 > 01/95		S 2329 R			
K 112	DN 11		04/82 > 06/90			S 4323 NR	S 0550 A	
some / alcuni	DN 11		01/84 > 06/90			S 8501 NR	S 0550 A	
dryer filter / filtro essiccatore	DN 11		01/85 > 06/90					S 7259 A
power steering / servosterzo	DN 11		04/82 > 06/90					S 3081 PO
K 112	DS 11, DSC 11		04/82 >			S 4323 NR	S 0550 A	
some / alcuni	DS 11, DSC 11		01/84 >			S 8501 NR		
dryer filter / filtro essiccatore	DS 11, DSC 11		01/85 >					S 7259 A
power steering / servosterzo	DS 11, DSC 11		04/82 >					S 3081 PO
turbocompressor / turbocompressore	DS 11, DSC 11		04/82 >		S 2329 R			
S 112	DN 11.01		07/83 > 10/91			S 4323 NR		
some / alcuni	DN 11.01		01/84 > 10/91			S 8501 NR		
dryer filter / filtro essiccatore	DN 11.01		01/85 > 10/91					S 7259 A
power steering / servosterzo	DN 11.01		07/83 > 10/91					S 3081 PO
turbocompressor / turbocompressore	DN 11.01		07/83 > 10/91		S 2329 R			
S 112	DS 11		01/81 > 10/91			S 4323 NR		
some / alcuni	DS 11		01/84 > 10/91			S 8501 NR		
dryer filter / filtro essiccatore	DS 11		01/85 > 10/91					S 7259 A
power steering / servosterzo	DS 11		01/81 > 10/91					S 3081 PO
turbocompressor / turbocompressore	DS 11		01/81 > 10/91		S 2329 R			
113 Serie								
BN 113 ALB	DS 11		05/90 > 08/98			S 4323 NR	S 8570 A	
some / alcuni	DS 11		05/90 > 08/98			S 8501 NR	S 8570 A	
dryer filter / filtro essiccatore	DS 11		05/90 > 08/98					S 7259 A
inner / interno	DS 11		05/90 > 08/98				S 7288 A	
power steering / servosterzo	DS 11		05/90 > 08/98					S 3081 PO



KW HP



...SCANIA - buses/autobus

turbocompressor / turbocompressore	DS 11	05/90 > 08/98	S 2329 R			
BN 113 ALB	DSC 11	05/90 > 08/98		S 4323 NR	S 8570 A	
some / alcuni	DSC 11	05/90 > 08/98		S 8501 NR	S 8570 A	
dryer filter / filtro essiccatore	DSC 11	05/90 > 08/98				S 7259 A
inner / interno	DSC 11	05/90 > 08/98			S 7288 A	
power steering / servosterzo	DSC 11	05/90 > 08/98				S 3081 PO
turbocompressor / turbocompressore	DSC 11	05/90 > 08/98	S 2329 R			
BN 113 CLB	DN 11	05/90 > 08/98		S 4323 NR	S 8570 A	
some / alcuni	DN 11	05/90 > 08/98		S 8501 NR	S 8570 A	
dryer filter / filtro essiccatore	DN 11	05/90 > 08/98				S 7259 A
inner / interno	DN 11	05/90 > 08/98			S 7288 A	
power steering / servosterzo	DN 11	05/90 > 08/98				S 3081 PO
C 113 ALB	DS 11	05/90 > 08/98		S 4323 NR	S 8570 A	
some / alcuni	DS 11	05/90 > 08/98		S 8501 NR	S 8570 A	
dryer filter / filtro essiccatore	DS 11	05/90 > 08/98				S 7259 A
inner / interno	DS 11	05/90 > 08/98			S 7288 A	
power steering / servosterzo	DS 11	05/90 > 08/98				S 3081 PO
turbocompressor / turbocompressore	DS 11	05/90 > 08/98	S 2329 R			
C 113 ALB	DSC 11	05/90 > 08/98		S 4323 NR	S 8570 A	
some / alcuni	DSC 11	05/90 > 08/98		S 8501 NR	S 8570 A	
dryer filter / filtro essiccatore	DSC 11	05/90 > 08/98				S 7259 A
inner / interno	DSC 11	05/90 > 08/98			S 7288 A	
power steering / servosterzo	DSC 11	05/90 > 08/98				S 3081 PO
turbocompressor / turbocompressore	DSC 11	05/90 > 08/98	S 2329 R			
C 113 CLB	DN 11	05/90 > 08/98		S 4323 NR	S 8570 A	
some / alcuni	DN 11	05/90 > 08/98		S 8501 NR	S 8570 A	
dryer filter / filtro essiccatore	DN 11	05/90 > 08/98				S 7259 A
inner / interno	DN 11	05/90 > 08/98			S 7288 A	
power steering / servosterzo	DN 11	05/90 > 08/98				S 3081 PO
C 113 CLB	DS 11	05/90 > 08/98		S 4323 NR	S 8570 A	
some / alcuni	DS 11	05/90 > 08/98		S 8501 NR	S 8570 A	
dryer filter / filtro essiccatore	DS 11	05/90 > 08/98				S 7259 A
inner / interno	DS 11	05/90 > 08/98			S 7288 A	
power steering / servosterzo	DS 11	05/90 > 08/98				S 3081 PO
turbocompressor / turbocompressore	DS 11	05/90 > 08/98	S 2329 R			
C 113 CLB	DSC 11	05/90 > 08/98		S 4323 NR	S 8570 A	
some / alcuni	DSC 11	05/90 > 08/98		S 8501 NR	S 8570 A	
dryer filter / filtro essiccatore	DSC 11	05/90 > 08/98				S 7259 A
inner / interno	DSC 11	05/90 > 08/98			S 7288 A	
power steering / servosterzo	DSC 11	05/90 > 08/98				S 3081 PO
turbocompressor / turbocompressore	DSC 11	05/90 > 08/98	S 2329 R			
CN 113	DS 11	01/90 > 08/98		S 4323 NR	S 8570 A	
some / alcuni	DS 11	01/90 > 08/98		S 8501 NR	S 8570 A	
dryer filter / filtro essiccatore	DS 11	01/90 > 08/98				S 7259 A
inner / interno	DS 11	01/90 > 08/98			S 7288 A	
power steering / servosterzo	DS 11	01/90 > 08/98				S 3081 PO
turbocompressor / turbocompressore	DS 11	01/90 > 08/98	S 2329 R			
CN 113	DSC 11	01/90 > 08/98		S 4323 NR	S 8570 A	
some / alcuni	DSC 11	01/90 > 08/98		S 8501 NR	S 8570 A	
dryer filter / filtro essiccatore	DSC 11	01/90 > 08/98				S 7259 A
inner / interno	DSC 11	01/90 > 08/98			S 7288 A	
power steering / servosterzo	DSC 11	01/90 > 08/98				S 3081 PO
turbocompressor / turbocompressore	DSC 11	01/90 > 08/98	S 2329 R			
CN 113 A	DS 11	01/90 > 08/98		S 4323 NR	S 8570 A	
some / alcuni	DS 11	01/90 > 08/98		S 8501 NR	S 8570 A	
dryer filter / filtro essiccatore	DS 11	01/90 > 08/98				S 7259 A
inner / interno	DS 11	01/90 > 08/98			S 7288 A	
power steering / servosterzo	DS 11	01/90 > 08/98				S 3081 PO
turbocompressor / turbocompressore	DS 11	01/90 > 08/98	S 2329 R			
CN 113 A	DSC 11	01/90 > 08/98		S 4323 NR	S 8570 A	
some / alcuni	DSC 11	01/90 > 08/98		S 8501 NR	S 8570 A	
dryer filter / filtro essiccatore	DSC 11	01/90 > 08/98				S 7259 A
inner / interno	DSC 11	01/90 > 08/98			S 7288 A	
power steering / servosterzo	DSC 11	01/90 > 08/98				S 3081 PO
turbocompressor / turbocompressore	DSC 11	01/90 > 08/98	S 2329 R			
CN 113 ALB	DSC 11	05/90 > 08/98		S 4323 NR	S 8570 A	
some / alcuni	DSC 11	05/90 > 08/98		S 8501 NR	S 8570 A	

S





kW HP



...SCANIA - buses/autobus

S

dryer filter / filtro essiccatore	DSC 11	05/90 > 08/98				S 7259 A
inner / interno	DSC 11	05/90 > 08/98			S 7288 A	
power steering / servosterzo	DSC 11	05/90 > 08/98				S 3081 PO
turbocompressor / turbocompressore	DSC 11	05/90 > 08/98	S 2329 R			
CN 113 CLB	DN 11	01/90 > 08/98		S 4323 NR	S 8570 A	
some / alcuni	DN 11	01/90 > 08/98		S 8501 NR	S 8570 A	
dryer filter / filtro essiccatore	DN 11	01/90 > 08/98				S 7259 A
inner / interno	DN 11	01/90 > 08/98			S 7288 A	
power steering / servosterzo	DN 11	01/90 > 08/98				S 3081 PO
CN 113 CLB	DSC 11	01/90 > 08/98		S 4323 NR	S 8570 A	
some / alcuni	DSC 11	01/90 > 08/98		S 8501 NR	S 8570 A	
dryer filter / filtro essiccatore	DSC 11	01/90 > 08/98				S 7259 A
inner / interno	DSC 11	01/90 > 08/98			S 7288 A	
power steering / servosterzo	DSC 11	01/90 > 08/98				S 3081 PO
turbocompressor / turbocompressore	DSC 11	01/90 > 08/98	S 2329 R			
F 113 HL	DS 11	06/90 > 08/98		S 4323 NR	S 8570 A	
some / alcuni	DS 11	06/90 > 08/98		S 8501 NR	S 8570 A	
dryer filter / filtro essiccatore	DS 11	06/90 > 08/98				S 7259 A
inner / interno	DS 11	06/90 > 08/98			S 7288 A	
power steering / servosterzo	DS 11	06/90 > 08/98				S 3081 PO
turbocompressor / turbocompressore	DS 11	06/90 > 08/98	S 2329 R			
F 113 HR	DS 11	06/90 > 08/98		S 4323 NR	S 8570 A	
some / alcuni	DS 11	06/90 > 08/98		S 8501 NR	S 8570 A	
dryer filter / filtro essiccatore	DS 11	06/90 > 08/98				S 7259 A
inner / interno	DS 11	06/90 > 08/98			S 7288 A	
power steering / servosterzo	DS 11	06/90 > 08/98				S 3081 PO
turbocompressor / turbocompressore	DS 11	06/90 > 08/98	S 2329 R			
K 113 CLA	DSC 11	05/82 > 12/00		S 4323 NR	S 8570 A	
some / alcuni	DSC 11	01/84 > 12/00		S 8501 NR	S 8570 A	
dryer filter / filtro essiccatore	DSC 11	01/85 > 12/00				S 7259 A
inner / interno	DSC 11	05/82 > 12/00			S 7288 A	
power steering / servosterzo	DSC 11	05/82 > 12/00				S 3081 PO
turbocompressor / turbocompressore	DSC 11	05/82 > 12/00	S 2329 R			
K 113 CLB	DN 11	05/82 > 12/00		S 4323 NR	S 8570 A	
some / alcuni	DN 11	01/84 > 12/00		S 8501 NR	S 8570 A	
dryer filter / filtro essiccatore	DN 11	01/85 > 12/00				S 7259 A
inner / interno	DN 11	05/82 > 12/00			S 7288 A	
power steering / servosterzo	DN 11	05/82 > 12/00				S 3081 PO
K 113 CLB	DS 11, DSC 11	05/82 > 12/00		S 4323 NR	S 8570 A	
some / alcuni	DS 11, DSC 11	05/82 > 12/00		S 8501 NR	S 8570 A	
dryer filter / filtro essiccatore	DS 11, DSC 11	01/85 > 12/00				S 7259 A
inner / interno	DS 11, DSC 11	05/82 > 12/00			S 7288 A	
power steering / servosterzo	DS 11, DSC 11	05/82 > 12/00				S 3081 PO
turbocompressor / turbocompressore	DS 11, DSC 11	05/82 > 12/00	S 2329 R			
K 113 CRA	DSC 11	05/82 > 12/00		S 4323 NR	S 8570 A	
some / alcuni	DSC 11	01/84 > 12/00		S 8501 NR	S 8570 A	
dryer filter / filtro essiccatore	DSC 11	01/85 > 12/00				S 7259 A
inner / interno	DSC 11	05/82 > 12/00			S 7288 A	
power steering / servosterzo	DSC 11	05/82 > 12/00				S 3081 PO
turbocompressor / turbocompressore	DSC 11	05/82 > 12/00	S 2329 R			
N 113 CLB	DN 11	09/91 > 08/98		S 4323 NR	S 8570 A	
some / alcuni	DN 11	09/91 > 08/98		S 8501 NR	S 8570 A	
dryer filter / filtro essiccatore	DN 11	09/91 > 08/98				S 7259 A
inner / interno	DN 11	09/91 > 08/98			S 7288 A	
power steering / servosterzo	DN 11	09/91 > 08/98				S 3081 PO
turbocompressor / turbocompressore	DN 11	09/91 > 08/98	S 2329 R			
N 113 CLB	DS 11	04/91 > 08/98		S 4323 NR	S 8570 A	
some / alcuni	DS 11	04/91 > 08/98		S 8501 NR	S 8570 A	
dryer filter / filtro essiccatore	DS 11	04/91 > 08/98				S 7259 A
inner / interno	DS 11	04/91 > 08/98			S 7288 A	
power steering / servosterzo	DS 11	04/91 > 08/98				S 3081 PO
turbocompressor / turbocompressore	DS 11	04/91 > 08/98	S 2329 R			
N 113 CLB	DSC 11	09/91 > 08/98		S 4323 NR	S 8570 A	
some / alcuni	DSC 11	09/91 > 08/98		S 8501 NR	S 8570 A	
dryer filter / filtro essiccatore	DSC 11	09/91 > 08/98				S 7259 A
inner / interno	DSC 11	09/91 > 08/98			S 7288 A	
power steering / servosterzo	DSC 11	09/91 > 08/98				S 3081 PO



kW HP



...SCANIA - buses/autobus

turbocompressor / turbocompressore	DSC 11			09/91 > 08/98	S 2329 R			
N 113 CLL	DS 11			04/91 > 08/98		S 4323 NR	S 8570 A	
some / alcuni	DS 11			04/91 > 08/98		S 8501 NR	S 8570 A	
dryer filter / filtro essiccatore	DS 11			04/91 > 08/98				S 7259 A
inner / interno	DS 11			04/91 > 08/98			S 7288 A	
power steering / servosterzo	DS 11			04/91 > 08/98				S 3081 PO
turbocompressor / turbocompressore	DS 11			04/91 > 08/98	S 2329 R			
N 113 CLL	DSC 11			04/91 > 08/98		S 4323 NR	S 8570 A	
some / alcuni	DSC 11			04/91 > 08/98		S 8501 NR	S 8570 A	
dryer filter / filtro essiccatore	DSC 11			04/91 > 08/98				S 7259 A
inner / interno	DSC 11			04/91 > 08/98			S 7288 A	
power steering / servosterzo	DSC 11			04/91 > 08/98				S 3081 PO
turbocompressor / turbocompressore	DSC 11			04/91 > 08/98	S 2329 R			
N 113 CLL	DSI 11			04/91 > 08/98		S 4323 NR	S 8570 A	
some / alcuni	DSI 11			04/91 > 08/98		S 8501 NR	S 8570 A	
dryer filter / filtro essiccatore	DSI 11			04/91 > 08/98				S 7259 A
inner / interno	DSI 11			04/91 > 08/98			S 7288 A	
power steering / servosterzo	DSI 11			04/91 > 08/98				S 3081 PO
turbocompressor / turbocompressore	DSI 11			04/91 > 08/98	S 2329 R			
N 113 CLR	DS 11			04/91 > 08/98		S 4323 NR	S 8570 A	
some / alcuni	DS 11			04/91 > 08/98		S 8501 NR	S 8570 A	
dryer filter / filtro essiccatore	DS 11			04/91 > 08/98				S 7259 A
inner / interno	DS 11			04/91 > 08/98			S 7288 A	
power steering / servosterzo	DS 11			04/91 > 08/98				S 3081 PO
turbocompressor / turbocompressore	DS 11			04/91 > 08/98	S 2329 R			
N 113 CLR	DSC 11			04/91 > 08/98		S 4323 NR	S 8570 A	
some / alcuni	DSC 11			04/91 > 08/98		S 8501 NR	S 8570 A	
dryer filter / filtro essiccatore	DSC 11			04/91 > 08/98				S 7259 A
inner / interno	DSC 11			04/91 > 08/98			S 7288 A	
power steering / servosterzo	DSC 11			04/91 > 08/98				S 3081 PO
turbocompressor / turbocompressore	DSC 11			04/91 > 08/98	S 2329 R			
N 113 CLR	DSI 11			04/91 > 08/98		S 4323 NR	S 8570 A	
some / alcuni	DSI 11			04/91 > 08/98		S 8501 NR	S 8570 A	
dryer filter / filtro essiccatore	DSI 11			04/91 > 08/98				S 7259 A
inner / interno	DSI 11			04/91 > 08/98			S 7288 A	
power steering / servosterzo	DSI 11			04/91 > 08/98				S 3081 PO
turbocompressor / turbocompressore	DSI 11			04/91 > 08/98	S 2329 R			
N 113 DRB	DN 11			04/91 > 08/98		S 4323 NR	S 8570 A	
some / alcuni	DN 11			04/91 > 08/98		S 8501 NR	S 8570 A	
dryer filter / filtro essiccatore	DN 11			04/91 > 08/98				S 7259 A
inner / interno	DN 11			04/91 > 08/98			S 7288 A	
power steering / servosterzo	DN 11			04/91 > 08/98				S 3081 PO
N 113 DRB	DS 11			04/91 > 08/98		S 4323 NR	S 8570 A	
some / alcuni	DS 11			04/91 > 08/98		S 8501 NR	S 8570 A	
dryer filter / filtro essiccatore	DS 11			04/91 > 08/98				S 7259 A
inner / interno	DS 11			04/91 > 08/98			S 7288 A	
power steering / servosterzo	DS 11			04/91 > 08/98				S 3081 PO
turbocompressor / turbocompressore	DS 11			04/91 > 08/98	S 2329 R			
N 113 DRB	DSC 11			04/91 > 08/98		S 4323 NR	S 8570 A	
some / alcuni	DSC 11			04/91 > 08/98		S 8501 NR	S 8570 A	
dryer filter / filtro essiccatore	DSC 11			04/91 > 08/98				S 7259 A
inner / interno	DSC 11			04/91 > 08/98			S 7288 A	
power steering / servosterzo	DSC 11			04/91 > 08/98				S 3081 PO
turbocompressor / turbocompressore	DSC 11			04/91 > 08/98	S 2329 R			
114 Serie								
K 114	DC11 Euro3			09/99 >	S 4402 R	S 4341 NR	S 8570 A	
some inner / alcuni interno	DC11 Euro3			09/99 >			S 7288 A	
retarder / freno di rallentamento	DC11 Euro3			09/99 >				S 5613 PO
power steering / servosterzo	DC11 Euro3			09/99 >				S 3081 PO
K 114	DSC11 Euro2	252	343	08/97 >	S 4402 R	S 0310 NR	S 8570 A	
retarder / freno di rallentamento	DSC11 Euro2	252	343	08/97 >				S 5613 PO
inner / interno	DSC11 Euro2	252	343	08/97 >			S 7288 A	
power steering / servosterzo	DSC11 Euro2	252	343	08/97 >				S 3081 PO
124 Serie								
K 124	DC12 Euro3	310	421	08/99 >	S 4402 R	S 4341 NR	S 8570 A	
some outer / alcuni esterno	DC12 Euro3	310	421	06/05 >			S 7A11 A	
some inner / alcuni interno	DC12 Euro3	310	421	06/05 >			S 7649 A	

S





KW HP



...SCANIA - buses/autobus

S



retarder / freno di rallentamento	DC12 Euro3	310 421	08/99 >				S 5613 PO
inner / interno	DC12 Euro3	310 421	08/99 >			S 7288 A	
power steering / servosterzo	DC12 Euro3	310 421	08/99 >				S 3081 PO
K 124	DC12.10.340 Euro4	250 340	11/05 >	S 4402 R	S 6010 NE	S 7A11 A	
retarder / freno di rallentamento	DC12.10.340 Euro4	250 340	11/05 >				S 5613 PO
inner / interno	DC12.10.340 Euro4	250 340	11/05 >			S 7649 A	
power steering / servosterzo	DC12.10.340 Euro4	250 340	11/05 >				S 3081 PO
K 124	DC12.13.380 Euro4	280 380	11/05 >	S 4402 R	S 6010 NE	S 7A11 A	
retarder / freno di rallentamento	DC12.13.380 Euro4	280 380	11/05 >				S 5613 PO
inner / interno	DC12.13.380 Euro4	280 380	11/05 >			S 7649 A	
power steering / servosterzo	DC12.13.380 Euro4	280 380	11/05 >				S 3081 PO
K 124	DSC12 Euro2	265 360	08/97 >	S 4402 R	S 0310 NR	S 8570 A	
some inner / alcuni interno	DSC12 Euro2	265 360	08/97 >			S 7288 A	
retarder / freno di rallentamento	DSC12 Euro2	265 360	08/97 >				S 5613 PO
power steering / servosterzo	DSC12 Euro2	265 360	08/97 >				S 3081 PO
82 Serie							
F 82 CL	DS 8.05 B		10/81 > 01/95		S 4323 NR	S 7186 A	
some / alcuni	DS 8.05 B		01/84 > 01/95		S 8501 NR	S 7186 A	
dryer filter / filtro essiccatore	DS 8.05 B		01/85 > 01/95				S 7259 A
power steering / servosterzo	DS 8.05 B		10/81 > 01/95				S 3081 PO
turbocompressor / turbocompressore	DS 8.05 B		10/81 > 01/95	S 2329 R			
K 82 CL	DSI 8.01 B		03/84 >		S 8501 NR	S 7186 A	
some / alcuni	DSI 8.01 B		03/84 >		S 8501 NR	S 0050 A	
some / alcuni	DSI 8.01 B		03/84 >		S 4323 NR	S 7186 A	
dryer filter / filtro essiccatore	DSI 8.01 B		01/85 >				S 7259 A
power steering / servosterzo	DSI 8.01 B		03/84 >				S 3081 PO
turbocompressor / turbocompressore	DSI 8.01 B		03/84 >	S 2329 R			
K 82 CR	DSI 8.01 B		03/84 >		S 8501 NR	S 0050 A	
some / alcuni	DSI 8.01 B		03/84 >		S 4323 NR	S 0050 A	
some / alcuni	DSI 8.01 B		03/84 >		S 8501 NR	S 7186 A	
dryer filter / filtro essiccatore	DSI 8.01 B		01/85 >				S 7259 A
power steering / servosterzo	DSI 8.01 B		03/84 >				S 3081 PO
turbocompressor / turbocompressore	DSI 8.01 B		03/84 >	S 2329 R			
92 Serie							
K 92 CL	DS 9.03 B		05/82 >		S 4323 NR	S 0050 A	
some / alcuni	DS 9.03 B		01/84 >		S 8501 NR	S 0050 A	
dryer filter / filtro essiccatore	DS 9.03 B		01/85 >				S 7259 A
power steering / servosterzo	DS 9.03 B		05/82 >				S 3081 PO
turbocompressor / turbocompressore	DS 9.03 B		05/82 >	S 2329 R			
93 Serie							
K 93 CL	DS 9, DSC 9		11/87 >		S 4323 NR	S 8570 A	
some / alcuni	DS 9, DSC 9		11/87 >		S 8501 NR	S 7186 A	
some / alcuni	DS 9, DSC 9		11/87 >		S 8501 NR	S 8570 A	
dryer filter / filtro essiccatore	DS 9, DSC 9		11/87 >				S 7259 A
inner / interno	DS 9, DSC 9		11/87 >			S 7288 A	
power steering / servosterzo	DS 9, DSC 9		11/87 >				S 3081 PO
turbocompressor / turbocompressore	DS 9, DSC 9		11/87 >	S 2329 R			
K 93 CLB	DS 9, DSC 9		11/87 >		S 4323 NR	S 8570 A	
some / alcuni	DS 9, DSC 9		11/87 >		S 8501 NR	S 8570 A	
some / alcuni	DS 9, DSC 9		11/87 >		S 8501 NR	S 7186 A	
dryer filter / filtro essiccatore	DS 9, DSC 9		11/87 >				S 7259 A
inner / interno	DS 9, DSC 9		11/87 >			S 7288 A	
power steering / servosterzo	DS 9, DSC 9		11/87 >				S 3081 PO
turbocompressor / turbocompressore	DS 9, DSC 9		11/87 >	S 2329 R			
K 93 CR	DS 9, DSC 9		11/87 >		S 4323 NR	S 8570 A	
some / alcuni	DS 9, DSC 9		11/87 >		S 8501 NR	S 8570 A	
some / alcuni	DS 9, DSC 9		11/87 >		S 8501 NR	S 7186 A	
dryer filter / filtro essiccatore	DS 9, DSC 9		11/87 >				S 7259 A
inner / interno	DS 9, DSC 9		11/87 >			S 7288 A	
power steering / servosterzo	DS 9, DSC 9		11/87 >				S 3081 PO
turbocompressor / turbocompressore	DS 9, DSC 9		11/87 >	S 2329 R			
K 93 CRB	DS 9, DSC 9		11/87 >		S 4323 NR	S 8570 A	
some / alcuni	DS 9, DSC 9		11/87 >		S 8501 NR	S 7186 A	
some / alcuni	DS 9, DSC 9		11/87 >		S 8501 NR	S 8570 A	
dryer filter / filtro essiccatore	DS 9, DSC 9		11/87 >				S 7259 A



| kW | HP |



...SCANIA - buses/autobus

inner / interno	DS 9, DSC 9			11/87 >			S 7288 A	
power steering / servosterzo	DS 9, DSC 9			11/87 >				S 3081 PO
turbocompressor / turbocompressore	DS 9, DSC 9			11/87 >	S 2329 R			
94 Serie								
CN 94 UA	DC9.02 Euro3	191 260		09/99 >	S 4402 R	S 4341 NR	S 8570 A	
inner / interno	DC9.02 Euro3	191 260		09/99 >			S 7288 A	
power steering / servosterzo	DC9.02 Euro3	191 260		09/99 >				S 3081 PO
CN 94 UA	DC9.03 Euro3	221 300		09/99 >	S 4402 R	S 4341 NR	S 8570 A	
inner / interno	DC9.03 Euro3	221 300		09/99 >			S 7288 A	
power steering / servosterzo	DC9.03 Euro3	221 300		09/99 >				S 3081 PO
CN 94 UB	DC9.01 Euro3	169 230		09/99 >	S 4402 R	S 4341 NR	S 8570 A	
inner / interno	DC9.01 Euro3	169 230		09/99 >			S 7288 A	
power steering / servosterzo	DC9.01 Euro3	169 230		09/99 >				S 3081 PO
CN 94 UB	DC9.02 Euro3	191 260		09/99 >	S 4402 R	S 4341 NR	S 8570 A	
inner / interno	DC9.02 Euro3	191 260		09/99 >			S 7288 A	
power steering / servosterzo	DC9.02 Euro3	191 260		09/99 >				S 3081 PO
IL 94 IB	DC9.03 Euro3	221 300		09/99 >	S 4402 R	S 4341 NR	S 8570 A	
inner / interno	DC9.03 Euro3	221 300		09/99 >			S 7288 A	
power steering / servosterzo	DC9.03 Euro3	221 300		09/99 >				S 3081 PO
IL 94 IB	DC9.06 Euro3	221 300		09/99 >	S 4402 R	S 4341 NR	S 8570 A	
inner / interno	DC9.06 Euro3	221 300		09/99 >			S 7288 A	
power steering / servosterzo	DC9.06 Euro3	221 300		09/99 >				S 3081 PO
K 94 EB/IB/UB	DC9.16.230 Euro4	169 230		11/05 >	S 4402 R	S 0310 NR	S 8570 A	
retarder / freno di rallentamento	DC9.16.230 Euro4	169 230		11/05 >			S 7288 A	S 5613 PO
inner / interno	DC9.16.230 Euro4	169 230		11/05 >				
power steering / servosterzo	DC9.16.230 Euro4	169 230		11/05 >				S 3081 PO
K 94 EB/IB/UB	DC9.16.310 Euro4	228 310		11/05 >	S 4402 R	S 0310 NR	S 8570 A	
retarder / freno di rallentamento	DC9.16.310 Euro4	228 310		11/05 >			S 7288 A	S 5613 PO
inner / interno	DC9.16.310 Euro4	228 310		11/05 >				
power steering / servosterzo	DC9.16.310 Euro4	228 310		11/05 >				S 3081 PO
K 94 EB/IB/UB	DC9.17.270 Euro4	198 270		11/05 >	S 4402 R	S 6010 NE	S 8570 A	
retarder / freno di rallentamento	DC9.17.270 Euro4	198 270		11/05 >			S 7288 A	S 5613 PO
inner / interno	DC9.17.270 Euro4	198 270		11/05 >				
power steering / servosterzo	DC9.17.270 Euro4	198 270		11/05 >				S 3081 PO
K 94 EB/IB/UB	DSC9.11/DSC9.15			09/97 >	S 4402 R	S 0310 NR	S 8570 A	
retarder / freno di rallentamento	DSC9.11/DSC9.15			09/97 >			S 7288 A	S 5613 PO
inner / interno	DSC9.11/DSC9.15			09/97 >				
power steering / servosterzo	DSC9.11/DSC9.15			09/97 >				S 3081 PO
N 94 E/EB/IB/UB	DC9.16 Euro4	169 230		11/05 >	S 4402 R	S 6010 NE	S 8570 A	
inner / interno	DC9.16 Euro4	169 230		11/05 >			S 7288 A	
power steering / servosterzo	DC9.16 Euro4	169 230		11/05 >				S 3081 PO
N 94 E/EB/IB/UB	DC9.17 Euro4	198 270		11/05 >	S 4402 R	S 6010 NE	S 8570 A	
inner / interno	DC9.17 Euro4	198 270		11/05 >			S 7288 A	
power steering / servosterzo	DC9.17 Euro4	198 270		11/05 >				S 3081 PO
B Serie								
B 110	D 11			01/68 > 07/71		S 0201 N		
	D 11			08/71 > 12/76		S 4323 NR		
2nd passage / 2.passaggio	D 11			01/68 > 07/71		S 1411 N		
power steering / servosterzo	D 11			01/68 > 12/76				S 8790 PO
power steering / servosterzo	D 11			01/68 > 12/76				S 3081 PO
B 110	DS 11			01/68 > 07/71		S 0201 N		
	DS 11			08/71 > 12/76		S 4323 NR		
2nd passage / 2.passaggio	DS 11			01/68 > 07/71		S 1411 N		
power steering / servosterzo	DS 11			01/68 > 12/76				S 8790 PO
power steering / servosterzo	DS 11			01/68 > 12/76				S 3081 PO
turbocompressor / turbocompressore	DS 11			01/68 > 12/76	S 2329 R			
B 110 S	D 11			01/68 > 07/71		S 0201 N		
	D 11			08/71 > 12/76		S 4323 NR		
2nd passage / 2.passaggio	D 11			01/68 > 07/71		S 1411 N		
power steering / servosterzo	D 11			01/68 > 12/76				S 3081 PO
power steering / servosterzo	D 11			01/68 > 12/76				S 8790 PO
B 110 S	DS 11			01/68 > 07/71		S 0201 N		
	DS 11			08/71 > 12/76		S 4323 NR		
2nd passage / 2.passaggio	DS 11			01/68 > 07/71		S 1411 N		
power steering / servosterzo	DS 11			01/68 > 12/76				S 8790 PO
power steering / servosterzo	DS 11			01/68 > 12/76				S 3081 PO
turbocompressor / turbocompressore	DS 11			01/68 > 12/76	S 2329 R			

S





KW HP



...SCANIA - buses/autobus

S



B 111 power steering / servosterzo	D 11	01/74 > 08/78		S 4323 NR	S 2450 A	S 8790 PO	
	D 11	01/74 > 08/78				S 3081 PO	
B 111 power steering / servosterzo	D 11	01/74 > 08/78				S 3081 PO	
	D 11	01/74 > 08/78				S 3081 PO	
B 111 turbocompressor / turbocompressore	DN 11	06/90 > 01/99		S 4323 NR	S 2650 A		
	DN 11	06/90 > 01/99	S 2329 R				
B 80 2nd passage / 2.passaggio some / alcuni power steering / servosterzo power steering / servosterzo	D 8	01/68 > 07/71		S 0201 N			
	D 8	08/71 > 04/76		S 4323 NR			
	D 8	01/68 > 07/71		S 1411 N			
	D 8	01/68 > 04/76		S 0201 N	S 2650 A		
	D 8	01/68 > 04/76				S 8790 PO	
	D 8	01/68 > 04/76				S 3081 PO	
B 86 some / alcuni power steering / servosterzo power steering / servosterzo turbocompressor / turbocompressore	D 8.01/02B09	06/82 > 01/90		S 4323 NR	S 2650 A		
	D 8.01/02B09	01/84 > 01/90		S 8501 NR	S 2650 A		
	D 8.01/02B09	06/82 > 01/90				S 8790 PO	
	D 8.01/02B09	06/82 > 01/90				S 3081 PO	
	D 8.01/02B09	06/82 > 01/90	S 2329 R				
B 86 S some / alcuni power steering / servosterzo power steering / servosterzo turbocompressor / turbocompressore	DS 8.01B10	06/82 > 01/95		S 4323 NR	S 2650 A		
	DS 8.01B10	01/84 > 01/95		S 8501 NR	S 2650 A		
	DS 8.01B10	06/82 > 01/95				S 3081 PO	
	DS 8.01B10	06/82 > 01/95				S 8790 PO	
	DS 8.01B10	06/82 > 01/95	S 2329 R				
BF Serie							
BF 110 2nd passage / 2.passaggio power steering / servosterzo power steering / servosterzo	D 11	01/68 > 07/71		S 0201 N			
	D 11	08/71 > 12/73		S 4323 NR			
	D 11	01/68 > 07/71		S 1411 N			
	D 11	01/68 > 12/73				S 3081 PO	
	D 11	01/68 > 12/73				S 8790 PO	
BF 110 2nd passage / 2.passaggio power steering / servosterzo power steering / servosterzo turbocompressor / turbocompressore	DS 11	01/68 > 07/71		S 0201 N			
	DS 11	08/71 > 12/76		S 4323 NR			
	DS 11	01/68 > 07/71		S 1411 N			
	DS 11	01/68 > 12/76				S 8790 PO	
	DS 11	01/68 > 12/76				S 3081 PO	
BF 110 Super 2nd passage / 2.passaggio power steering / servosterzo power steering / servosterzo turbocompressor / turbocompressore	DS 11	01/68 > 07/71		S 0201 N			
	DS 11	08/71 > 12/76		S 4323 NR			
	DS 11	01/68 > 07/71		S 1411 N			
	DS 11	01/68 > 12/76				S 3081 PO	
	DS 11	01/68 > 12/76				S 8790 PO	
BF 111 turbocompressor / turbocompressore	DS 11	01/91 > 01/99		S 4323 NR	S 2450 A		
	DS 11	01/91 > 01/99	S 2329 R				
BF 80 2nd passage / 2.passaggio spin-on / avvitabile power steering / servosterzo power steering / servosterzo	D 8	10/73 > 04/76		S 0201 N	S 2650 A		
	D 8	10/73 > 04/76		S 1411 N			
	D 8	10/73 > 04/76		S 4323 NR	S 2650 A		
	D 8	10/73 > 04/76				S 8790 PO	
	D 8	10/73 > 04/76				S 3081 PO	
BF 80 2nd passage / 2.passaggio spin-on / avvitabile power steering / servosterzo power steering / servosterzo turbocompressor / turbocompressore	DS 8	10/73 > 04/76		S 0201 N	S 2450 A		
	DS 8	10/73 > 04/76		S 1411 N			
	DS 8	10/73 > 04/76		S 4323 NR	S 2450 A		
	DS 8	10/73 > 04/76				S 8790 PO	
	DS 8	10/73 > 04/76				S 3081 PO	
	DS 8	10/73 > 04/76	S 2329 R				
BF 86 power steering / servosterzo power steering / servosterzo turbocompressor / turbocompressore	DS 8	05/75 > 06/82		S 4323 NR	S 2650 A		
	DS 8	05/75 > 06/82				S 8790 PO	
	DS 8	05/75 > 06/82				S 3081 PO	
BF 86 S power steering / servosterzo power steering / servosterzo turbocompressor / turbocompressore	DS 8	05/75 > 06/82		S 4323 NR	S 2650 A		
	DS 8	05/75 > 06/82				S 8790 PO	
	DS 8	05/75 > 06/82				S 3081 PO	
BR Serie							
	BR 111 2nd passage / 2.passaggio power steering / servosterzo power steering / servosterzo	D 11	01/69 > 07/71		S 0201 N	S 2450 A	
		D 11	08/71 > 08/78		S 4323 NR	S 2450 A	
D 11		01/69 > 07/71		S 1411 N			
D 11		01/69 > 08/78				S 3081 PO	
D 11		01/69 > 08/78				S 8790 PO	
BR 111 M	D 11	01/69 > 07/71		S 0201 N	S 2450 A		



KW HP



...SCANIA - buses/autobus

2nd passage / 2.passaggio	D 11			08/71 > 08/78		S 4323 NR	S 2450 A		
power steering / servosterzo	D 11			01/69 > 07/71		S 1411 N		S 8790 PO	
power steering / servosterzo	D 11			01/69 > 08/78				S 3081 PO	
power steering / servosterzo	D 11			01/69 > 08/78				S 3081 PO	
BR 112	DS 11			09/78 >		S 4323 NR	S 0050 A		
some / alcuni	DS 11			01/84 >		S 8501 NR	S 0050 A		
power steering / servosterzo	DS 11			09/78 >				S 3081 PO	
power steering / servosterzo	DS 11			09/78 >				S 8790 PO	
turbocompressor / turbocompressore	DS 11			09/78 >	S 2329 R				
BR 116	DS 11			01/76 >		S 4323 NR	S 0050 A		
some / alcuni	DS 11			01/84 >		S 8501 NR	S 0050 A		
power steering / servosterzo	DS 11			01/76 >				S 3081 PO	
power steering / servosterzo	DS 11			01/76 >				S 8790 PO	
turbocompressor / turbocompressore	DS 11			01/76 >	S 2329 R				
BR 116 S	DS 11			01/76 >		S 4323 NR	S 0050 A		
some / alcuni	DS 11			01/84 >		S 8501 NR	S 0050 A		
power steering / servosterzo	DS 11			01/76 >				S 8790 PO	
power steering / servosterzo	DS 11			01/76 >				S 3081 PO	
turbocompressor / turbocompressore	DS 11			01/76 >	S 2329 R				
BR 145	D 14			08/71 >		S 4323 NR	S 2650 A		
some / alcuni	D 14			01/84 >		S 8501 NR	S 2650 A		
power steering / servosterzo	D 14			08/71 >				S 3081 PO	
power steering / servosterzo	D 14			08/71 >				S 8790 PO	
turbocompressor / turbocompressore	D 14			08/71 >	S 2329 R				
BR 85	D 8			10/73 > 04/75		S 0201 N	S 2650 A		
2nd passage / 2.passaggio	D 8			10/73 > 04/75		S 1411 N			
spin-on / avvitabile	D 8			10/73 > 04/75		S 4323 NR	S 2650 A		
power steering / servosterzo	D 8			10/73 > 04/75				S 8790 PO	
power steering / servosterzo	D 8			10/73 > 04/75				S 3081 PO	
BR 85 Super	DS 8			08/71 > 04/75		S 0201 N	S 2650 A		
2nd passage / 2.passaggio	DS 8			08/71 > 04/75		S 1411 N			
spin-on / avvitabile	DS 8			08/71 > 04/75		S 4323 NR	S 2650 A		
power steering / servosterzo	DS 8			08/71 > 04/75				S 3081 PO	
power steering / servosterzo	DS 8			08/71 > 04/75				S 8790 PO	
Century									
12.35	DC11.04 Euro3	280	382	11/99 >		S 4402 R	S 4341 NR	S 8570 A	
power steering / servosterzo	DC11.04 Euro3	280	382	11/99 >					S 3081 PO
12.35	DC12 Euro3	310	422	09/03 >		S 4402 R	S 4341 NR	S 8570 A	
power steering / servosterzo	DC12 Euro3	310	422	09/03 >					S 3081 PO
12.35	DSC12.05 Euro2	308	420	05/96 >		S 4402 R	S 0310 NR	S 8570 A	
power steering / servosterzo	DSC12.05 Euro2	308	420	05/96 >					S 3081 PO
12.37	DC12 Euro3	310	422	01/00 >		S 4402 R	S 4341 NR	S 8570 A	
power steering / servosterzo	DC12 Euro3	310	422	01/00 >					S 3081 PO
12.85	DC11 Euro3	310	422	09/02 >		S 4402 R	S 4341 NR	S 8570 A	
power steering / servosterzo	DC11 Euro3	310	422	09/02 >					S 3081 PO
12.85	DC12 Euro3	310	422	09/02 >		S 4402 R	S 4341 NR	S 8570 A	
power steering / servosterzo	DC12 Euro3	310	422	09/02 >					S 3081 PO
13.37	DC12 Euro3	310	422	01/02 >		S 4402 R	S 4341 NR	S 8570 A	
power steering / servosterzo	DC12 Euro3	310	422	01/02 >					S 3081 PO
CF Serie									
110 L	D 11			01/68 > 04/70			S 0201 N		
2nd passage / 2.passaggio	D 11			01/68 > 04/70			S 1411 N		
power steering / servosterzo	D 11			01/68 > 04/70					S 3081 PO
power steering / servosterzo	D 11			01/68 > 04/70					S 8790 PO
Citywide LE									
250	DC09.111-250 Euro6	184	250	09/13 >		S 5181 PE	S 6147 NE	S 7A11 A	
with air-conditioner Spheros REVO (6 filters) / con climatizzatore Spheros REVO (N.6 filtri)	DC09.111-250 Euro6	184	250	09/13 >					S 3457 C
spheros aeroshere world SPHEROS / con climatizzatore sul tetto SPHEROS	DC09.111-250 Euro6	184	250	09/13 >					S 3457 C
with air-conditioner Webasto Aerosphere World (6 filters) / con climatizzatore Webasto Aerosphere World (N.6 filtri)	DC09.111-250 Euro6	184	250	09/13 >					S 3283 C
dryer filter / filtro essiccatore	DC09.111-250 Euro6	184	250	09/13 >					S 7F30 A
inner / interno	DC09.111-250 Euro6	184	250	09/13 >				S 7649 A	
power steering / servosterzo	DC09.111-250 Euro6	184	250	09/13 >					S 3081 PO
280	DC09.113-280 Euro6	206	280	09/13 >					S 3457 C
	DC09.113-280 Euro6	206	280	09/13 >		S 5181 PE	S 6147 NE	S 7A11 A	
with air-conditioner Spheros REVO (6 filters) / con climatizzatore Spheros REVO (N.6 filtri)	DC09.113-280 Euro6	206	280	09/13 >					S 3457 C
with air-conditioner Webasto Aerosphere World (6 filters) / con climatizzatore Webasto Aerosphere World (N.6 filtri)	DC09.113-280 Euro6	206	280	09/13 >					S 3283 C
dryer filter / filtro essiccatore	DC09.113-280 Euro6	206	280	09/13 >					S 7F30 A

S





kW HP



...SCANIA - buses/autobus

S

inner / interno	DC09.113-280 Euro6	206	280	09/13	>			S 7649 A	
power steering / servosterzo	DC09.113-280 Euro6	206	280	09/13	>				S 3081 PO
320	DC09.108-320 Euro6	235	320	09/13	>	S 5181 PE	S 6147 NE	S 7A11 A	
with air-conditioner Spheros REVO (6 filters) / con climatizzatore Spheros REVO (N.6 filtri)	DC09.108-320 Euro6	235	320	09/13	>				S 3457 C
spheros aeroshere world SPHEROS / con climatizzatore sul tetto SPHEROS	DC09.108-320 Euro6	235	320	09/13	>				S 3457 C
with air-conditioner Webasto Aerosphere World (6 filters) / con climatizzatore Webasto Aerosphere World (N.6 filtri)	DC09.108-320 Euro6	235	320	09/13	>				S 3283 C
dryer filter / filtro essiccatore	DC09.108-320 Euro6	235	320	09/13	>				S 7F30 A
inner / interno	DC09.108-320 Euro6	235	320	09/13	>			S 7649 A	
power steering / servosterzo	DC09.108-320 Euro6	235	320	09/13	>				S 3081 PO
360	DC09.112-360 Euro6	265	360	09/13	>	S 5181 PE	S 6147 NE	S 7A11 A	
with air-conditioner Spheros REVO (6 filters) / con climatizzatore Spheros REVO (N.6 filtri)	DC09.112-360 Euro6	265	360	09/13	>				S 3457 C
spheros aeroshere world SPHEROS / con climatizzatore sul tetto SPHEROS	DC09.112-360 Euro6	265	360	09/13	>				S 3457 C
with air-conditioner Webasto Aerosphere World (6 filters) / con climatizzatore Webasto Aerosphere World (N.6 filtri)	DC09.112-360 Euro6	265	360	09/13	>				S 3283 C
dryer filter / filtro essiccatore	DC09.112-360 Euro6	265	360	09/13	>				S 7F30 A
inner / interno	DC09.112-360 Euro6	265	360	09/13	>			S 7649 A	
power steering / servosterzo	DC09.112-360 Euro6	265	360	09/13	>				S 3081 PO

Citywide LF

250	DC09.111-250 Euro6	184	250	09/13	>	S 5181 PE	S 6147 NE	S 7A11 A	
with air-conditioner Spheros REVO (6 filters) / con climatizzatore Spheros REVO (N.6 filtri)	DC09.111-250 Euro6	184	250	09/13	>				S 3457 C
spheros aeroshere world SPHEROS / con climatizzatore sul tetto SPHEROS	DC09.111-250 Euro6	184	250	09/13	>				S 3457 C
with air-conditioner Webasto Aerosphere World (6 filters) / con climatizzatore Webasto Aerosphere World (N.6 filtri)	DC09.111-250 Euro6	184	250	09/13	>				S 3283 C
dryer filter / filtro essiccatore	DC09.111-250 Euro6	184	250	09/13	>				S 7F30 A
inner / interno	DC09.111-250 Euro6	184	250	09/13	>			S 7649 A	
power steering / servosterzo	DC09.111-250 Euro6	184	250	09/13	>				S 3081 PO
280	DC09.113-280 Euro6	206	280	09/13	>	S 5181 PE	S 6147 NE	S 7A11 A	
with air-conditioner Spheros REVO (6 filters) / con climatizzatore Spheros REVO (N.6 filtri)	DC09.113-280 Euro6	206	280	09/13	>				S 3457 C
spheros aeroshere world SPHEROS / con climatizzatore sul tetto SPHEROS	DC09.113-280 Euro6	206	280	09/13	>				S 3457 C
with air-conditioner Webasto Aerosphere World (6 filters) / con climatizzatore Webasto Aerosphere World (N.6 filtri)	DC09.113-280 Euro6	206	280	09/13	>				S 3283 C
dryer filter / filtro essiccatore	DC09.113-280 Euro6	206	280	09/13	>				S 7F30 A
inner / interno	DC09.113-280 Euro6	206	280	09/13	>			S 7649 A	
power steering / servosterzo	DC09.113-280 Euro6	206	280	09/13	>				S 3081 PO

CR Serie

110	D 11			01/68	> 07/71			S 0201 N	
	D 11			08/71	> 12/73			S 4323 NR	
2nd passage / 2.passaggio	D 11			01/68	> 07/71			S 1411 N	
power steering / servosterzo	D 11			01/68	> 12/73				S 3081 PO
power steering / servosterzo	D 11			01/68	> 12/73				S 8790 PO
111	D 11			01/68	> 07/71			S 0201 N	
	D 11			08/71	> 08/78			S 4323 NR	
2nd passage / 2.passaggio	D 11			01/68	> 07/71			S 1411 N	
power steering / servosterzo	D 11			01/68	> 08/78				S 3081 PO
power steering / servosterzo	D 11			01/68	> 08/78				S 8790 PO
111 M	D 11			01/68	> 07/71			S 0201 N	
	D 11			08/71	> 08/78			S 4323 NR	
2nd passage / 2.passaggio	D 11			01/68	> 07/71			S 1411 N	
power steering / servosterzo	D 11			01/68	> 08/78				S 8790 PO
power steering / servosterzo	D 11			01/68	> 08/78				S 3081 PO
112	DS 11			09/78	>			S 4323 NR	S 0050 A
some / alcuni	DS 11			01/84	>			S 8501 NR	S 0050 A
power steering / servosterzo	DS 11			09/78	>				S 3081 PO
power steering / servosterzo	DS 11			09/78	>				S 8790 PO
turbocompressor / turbocompressore	DS 11			09/78	>	S 2329 R			
145	DS 14			08/71	> 06/84			S 4323 NR	S 2650 A
some / alcuni	DS 14			01/84	> 06/84			S 8501 NR	S 2650 A
power steering / servosterzo	DS 14			08/71	> 06/84				S 8790 PO
power steering / servosterzo	DS 14			08/71	> 06/84				S 3081 PO
turbocompressor / turbocompressore	DS 14			08/71	> 06/84	S 2329 R			
85	D 8			08/71	> 04/75			S 0201 N	S 2650 A
2nd passage / 2.passaggio	D 8			08/71	> 04/75			S 1411 N	
power steering / servosterzo	D 8			08/71	> 04/75				S 8790 PO
power steering / servosterzo	D 8			08/71	> 04/75				S 3081 PO

Interlink HD

250	DC09.111-250 Euro6	184	250	10/15	>	S 5181 PE	S 6147 NE	S 7A11 A	
with air-conditioner Spheros REVO (6 filters) / con climatizzatore Spheros REVO (N.6 filtri)	DC09.111-250 Euro6	184	250	10/15	>				S 3457 C
spheros aeroshere world SPHEROS / con climatizzatore sul tetto SPHEROS	DC09.111-250 Euro6	184	250	10/15	>				S 3457 C
dryer filter / filtro essiccatore	DC09.111-250 Euro6	184	250	01/16	>				S 7F30 A
power steering / servosterzo	DC09.111-250 Euro6	184	250	10/15	>				S 3081 PO

**KW HP****...SCANIA - buses/autobus****S**

power steering / servosterzo	DC09.113-280 Euro6	206	280	10/15	>				S 3081 PO
320	DC09.108-320 Euro6	235	320	10/15	>	S 5181 PE	S 6147 NE	S 7A11 A	
with air-conditioner Spheros REVO (6 filters) / con climatizzatore Spheros REVO (N.6 filtri)	DC09.108-320 Euro6	235	320	10/15	>				S 3457 C
dryer filter / filtro essiccatore	DC09.108-320 Euro6	235	320	01/16	>				S 7F30 A
power steering / servosterzo	DC09.108-320 Euro6	235	320	10/15	>				S 3081 PO
360	DC09.112-360 Euro6	265	360	10/15	>	S 5181 PE	S 6147 NE	S 7A11 A	
with air-conditioner Spheros REVO (6 filters) / con climatizzatore Spheros REVO (N.6 filtri)	DC09.112-360 Euro6	265	360	10/15	>				S 3457 C
dryer filter / filtro essiccatore	DC09.112-360 Euro6	265	360	01/16	>				S 7F30 A
power steering / servosterzo	DC09.112-360 Euro6	265	360	10/15	>				S 3081 PO
410	DC13.115-410 Euro6	301	409	10/15	>	S 5181 PE	S 6147 NE	S 7A11 A	
with air-conditioner Spheros REVO (6 filters) / con climatizzatore Spheros REVO (N.6 filtri)	DC13.115-410 Euro6	301	409	10/15	>				S 3457 C
dryer filter / filtro essiccatore	DC13.115-410 Euro6	301	409	01/16	>				S 7F30 A
power steering / servosterzo	DC13.115-410 Euro6	301	409	10/15	>				S 3081 PO
450	DC13.124-450 Euro6	331	450	10/15	>	S 5181 PE	S 6147 NE	S 7A11 A	
with air-conditioner Spheros REVO (6 filters) / con climatizzatore Spheros REVO (N.6 filtri)	DC13.124-450 Euro6	331	450	10/15	>				S 3457 C
dryer filter / filtro essiccatore	DC13.124-450 Euro6	331	450	01/16	>				S 7F30 A
power steering / servosterzo	DC13.124-450 Euro6	331	450	10/15	>				S 3081 PO
490	DC13.125-490 Euro6	360	490	10/15	>	S 5181 PE	S 6147 NE	S 7A11 A	
with air-conditioner Spheros REVO (6 filters) / con climatizzatore Spheros REVO (N.6 filtri)	DC13.125-490 Euro6	360	490	10/15	>				S 3457 C
dryer filter / filtro essiccatore	DC13.125-490 Euro6	360	490	01/16	>				S 7F30 A
power steering / servosterzo	DC13.125-490 Euro6	360	490	10/15	>				S 3081 PO

OmniCity

12 m	DC9.01 Euro3	169	230	09/02	>	S 4402 R	S 4341 NR	S 8570 A	
with automatic gearbox and hydraulic retarder ZF 4/5HP502C / con cambio automatico e rallentatore idraulico ZF 4/5HP502C	DC9.01 Euro3	169	230	09/02	>				S 2234 Z
spheros aeroshere world SPHEROS / con climatizzatore sul tetto SPHEROS	DC9.01 Euro3	169	230	09/02	>				S 3457 C
with air-conditioner WEBASTO Aerosphere (6 filters) / con climatizzatore WEBASTO Aerosphere (N.6 filtri)	DC9.01 Euro3	169	230	09/02	>				S 3081 C
dryer filter / filtro essiccatore	DC9.01 Euro3	169	230	09/02	>				S 7F30 A
retarder / freno di rallentamento	DC9.01 Euro3	169	230	09/02	>				S 5613 PO
inner / interno	DC9.01 Euro3	169	230	09/02	>			S 7288 A	
power steering / servosterzo	DC9.01 Euro3	169	230	09/02	>				S 3081 PO
12 m	DC9.02 Euro3	191	260	09/02	>	S 4402 R	S 4341 NR	S 8570 A	
with automatic gearbox and hydraulic retarder ZF 4/5HP592C / con cambio automatico e rallentatore idraulico ZF 4/5HP592C	DC9.02 Euro3	191	260	09/02	>				S 2234 Z
with air-conditioner WEBASTO Aerosphere (6 filters) / con climatizzatore WEBASTO Aerosphere (N.6 filtri)	DC9.02 Euro3	191	260	09/02	>				S 3081 C
dryer filter / filtro essiccatore	DC9.02 Euro3	191	260	09/02	>				S 7F30 A
retarder / freno di rallentamento	DC9.02 Euro3	191	260	09/02	>				S 5613 PO
inner / interno	DC9.02 Euro3	191	260	09/02	>			S 7288 A	
power steering / servosterzo	DC9.02 Euro3	191	260	09/02	>				S 3081 PO
18 m	DC9.02 Euro3	191	260	09/02	>	S 4402 R	S 4341 NR	S 8570 A	
with automatic gearbox and hydraulic retarder ZF 4/5HP592C / con cambio automatico e rallentatore idraulico ZF 4/5HP592C	DC9.02 Euro3	191	260	09/02	>				S 2234 Z
with air-conditioner WEBASTO Aerosphere (6 filters) / con climatizzatore WEBASTO Aerosphere (N.6 filtri)	DC9.02 Euro3	191	260	09/02	>				S 3081 C
dryer filter / filtro essiccatore	DC9.02 Euro3	191	260	09/02	>				S 7F30 A
retarder / freno di rallentamento	DC9.02 Euro3	191	260	09/02	>				S 5613 PO
inner / interno	DC9.02 Euro3	191	260	09/02	>			S 7288 A	
power steering / servosterzo	DC9.02 Euro3	191	260	09/02	>				S 3081 PO
18 m	DC9.03 Euro3	221	300	09/02	>	S 4402 R	S 4341 NR	S 8570 A	
with automatic gearbox and hydraulic retarder ZF 5HP602 / con cambio automatico e rallentatore idraulico ZF 5HP602	DC9.03 Euro3	221	300	09/02	>				S 2234 Z
with air-conditioner WEBASTO Aerosphere (6 filters) / con climatizzatore WEBASTO Aerosphere (N.6 filtri)	DC9.03 Euro3	221	300	09/02	>				S 3081 C
dryer filter / filtro essiccatore	DC9.03 Euro3	221	300	09/02	>				S 7F30 A
retarder / freno di rallentamento	DC9.03 Euro3	221	300	09/02	>				S 5613 PO
inner / interno	DC9.03 Euro3	221	300	09/02	>			S 7288 A	
power steering / servosterzo	DC9.03 Euro3	221	300	09/02	>				S 3081 PO

OmniExpress

3.20	DC09.112 E6	265	360	01/14	>	S 5181 PE	S 6147 NE	S 7A11 A	
retarder / freno di rallentamento	DC09.112 E6	265	360	01/14	>				S 5613 PO
inner / interno	DC09.112 E6	265	360	01/14	>			S 7649 A	
power steering / servosterzo	DC09.112 E6	265	360	01/14	>				S 3081 PO
3.20	DC13.115 E6	302	410	01/14	>	S 5181 PE	S 6147 NE	S 7A11 A	
retarder / freno di rallentamento	DC13.115 E6	302	410	01/14	>				S 5613 PO
inner / interno	DC13.115 E6	302	410	01/14	>			S 7649 A	
power steering / servosterzo	DC13.115 E6	302	410	01/14	>				S 3081 PO
3.20	DC13.124 E6	331	450	01/14	>	S 5181 PE	S 6147 NE	S 7A11 A	
retarder / freno di rallentamento	DC13.124 E6	331	450	01/14	>				S 5613 PO
inner / interno	DC13.124 E6	331	450	01/14	>			S 7649 A	
power steering / servosterzo	DC13.124 E6	331	450	01/14	>				S 3081 PO
3.20	DC13.125 E6	360	490	01/14	>	S 5181 PE	S 6147 NE	S 7A11 A	
retarder / freno di rallentamento	DC13.125 E6	360	490	01/14	>				S 5613 PO
inner / interno	DC13.125 E6	360	490	01/14	>			S 7649 A	

**KW HP****...SCANIA - buses/autobus**

power steering / servosterzo	DC13.125 E6	360	490	01/14	>				S 3081 PO
3.40	DC09.112 E6	265	360	01/14	>	S 5181 PE	S 6147 NE	S 7A11 A	
retarder / freno di rallentamento	DC09.112 E6	265	360	01/14	>				S 5613 PO
inner / interno	DC09.112 E6	265	360	01/14	>			S 7649 A	
power steering / servosterzo	DC09.112 E6	265	360	01/14	>				S 3081 PO
3.40	DC13.115 E6	302	410	01/14	>	S 5181 PE	S 6147 NE	S 7A11 A	
retarder / freno di rallentamento	DC13.115 E6	302	410	01/14	>				S 5613 PO
inner / interno	DC13.115 E6	302	410	01/14	>			S 7649 A	
power steering / servosterzo	DC13.115 E6	302	410	01/14	>				S 3081 PO
3.40	DC13.124 E6	331	450	01/14	>	S 5181 PE	S 6147 NE	S 7A11 A	
retarder / freno di rallentamento	DC13.124 E6	331	450	01/14	>				S 5613 PO
inner / interno	DC13.124 E6	331	450	01/14	>			S 7649 A	
power steering / servosterzo	DC13.124 E6	331	450	01/14	>				S 3081 PO
3.40	DC13.125 E6	360	490	01/14	>	S 5181 PE	S 6147 NE	S 7A11 A	
retarder / freno di rallentamento	DC13.125 E6	360	490	01/14	>				S 5613 PO
inner / interno	DC13.125 E6	360	490	01/14	>			S 7649 A	
power steering / servosterzo	DC13.125 E6	360	490	01/14	>				S 3081 PO
3.60	DC09.112 E6	265	360	01/14	>	S 5181 PE	S 6147 NE	S 7A11 A	
retarder / freno di rallentamento	DC09.112 E6	265	360	01/14	>				S 5613 PO
inner / interno	DC09.112 E6	265	360	01/14	>			S 7649 A	
power steering / servosterzo	DC09.112 E6	265	360	01/14	>				S 3081 PO
3.60	DC13.115 E6	302	410	01/14	>	S 5181 PE	S 6147 NE	S 7A11 A	
retarder / freno di rallentamento	DC13.115 E6	302	410	01/14	>				S 5613 PO
inner / interno	DC13.115 E6	302	410	01/14	>			S 7649 A	
power steering / servosterzo	DC13.115 E6	302	410	01/14	>				S 3081 PO
3.60	DC13.124 E6	331	450	01/14	>	S 5181 PE	S 6147 NE	S 7A11 A	
retarder / freno di rallentamento	DC13.124 E6	331	450	01/14	>				S 5613 PO
inner / interno	DC13.124 E6	331	450	01/14	>			S 7649 A	
power steering / servosterzo	DC13.124 E6	331	450	01/14	>				S 3081 PO
3.60	DC13.125 E6	360	490	01/14	>	S 5181 PE	S 6147 NE	S 7A11 A	
retarder / freno di rallentamento	DC13.125 E6	360	490	01/14	>				S 5613 PO
inner / interno	DC13.125 E6	360	490	01/14	>			S 7649 A	
power steering / servosterzo	DC13.125 E6	360	490	01/14	>				S 3081 PO
310	DC9.18.310	228	310	09/07	>	S 4402 R	S 6010 NE	S 7A11 A	
with automatic gearbox ZF 6HP592/6HP692 / con cambio automatico ZF 6HP592/6HP692	DC9.18.310	228	310	09/07	>				S 2234 Z
spheros aeroshere world SPHEROS / con climatizzatore sul tetto SPHEROS	DC9.18.310	228	310	09/07	>				S 3457 C
dryer filter / filtro essiccatore	DC9.18.310	228	310	09/07	>				S 7F30 A
retarder / freno di rallentamento	DC9.18.310	228	310	09/07	>				S 5613 PO
inner / interno	DC9.18.310	228	310	09/07	>			S 7649 A	
power steering / servosterzo	DC9.18.310	228	310	09/07	>				S 3081 PO
380	DC12.13.380	279	380	09/07	>	S 4402 R	S 6010 NE	S 7A11 A	
with automatic gearbox ZF 6HP592/6HP692 / con cambio automatico ZF 6HP592/6HP692	DC12.13.380	279	380	09/07	>				S 2234 Z
spheros aeroshere world SPHEROS / con climatizzatore sul tetto SPHEROS	DC12.13.380	279	380	09/07	>				S 3457 C
dryer filter / filtro essiccatore	DC12.13.380	279	380	09/07	>				S 7F30 A
retarder / freno di rallentamento	DC12.13.380	279	380	09/07	>				S 5613 PO
inner / interno	DC12.13.380	279	380	09/07	>			S 7649 A	
power steering / servosterzo	DC12.13.380	279	380	09/07	>				S 3081 PO
420	DC12.13.420	309	420	09/07	>	S 4402 R	S 6010 NE	S 7A11 A	
with automatic gearbox ZF 6HP592/6HP692 / con cambio automatico ZF 6HP592/6HP692	DC12.13.420	309	420	09/07	>				S 2234 Z
spheros aeroshere world SPHEROS / con climatizzatore sul tetto SPHEROS	DC12.13.420	309	420	09/07	>				S 3457 C
dryer filter / filtro essiccatore	DC12.13.420	309	420	09/07	>				S 7F30 A
retarder / freno di rallentamento	DC12.13.420	309	420	09/07	>				S 5613 PO
inner / interno	DC12.13.420	309	420	09/07	>			S 7649 A	
power steering / servosterzo	DC12.13.420	309	420	09/07	>				S 3081 PO
OmniLine									
12 m									
with automatic gearbox and hydraulic retarder ZF 5HP602 / con cambio automatico e rallentatore idraulico ZF 5HP602	DC9.03 Euro3	221	300	09/02	>				S 2234 Z
with air-conditioner WEBASTO Aerosphere / con climatizzatore WEBASTO Aerosphere	DC9.03 Euro3	221	300	09/02	>	S 4402 R	S 4341 NR	S 8570 A	S 3081 C
dryer filter / filtro essiccatore	DC9.03 Euro3	221	300	09/02	>				S 7F24 A
inner / interno	DC9.03 Euro3	221	300	09/02	>			S 7288 A	
power steering / servosterzo	DC9.03 Euro3	221	300	09/02	>				S 3081 PO
OmniLink									
12 m									
with automatic gearbox and hydraulic retarder ZF 4/5HP592C / con cambio automatico e rallentatore idraulico ZF 4/5HP592C	DC9.01 Euro3	169	230	09/02	>				S 2234 Z
with air-conditioner WEBASTO Aerosphere / con climatizzatore WEBASTO Aerosphere	DC9.01 Euro3	169	230	09/02	>	S 4402 R	S 4341 NR	S 8570 A	S 3081 C
dryer filter / filtro essiccatore	DC9.01 Euro3	169	230	09/02	>				S 7F30 A
inner / interno	DC9.01 Euro3	169	230	09/02	>			S 7288 A	

S

**kW HP****...SCANIA - buses/autobus****S**

power steering / servosterzo	DC9.01 Euro3	169	230	09/02 >				S 3081 PO
12 m								
with automatic gearbox and hydraulic retarder ZF 4/5HP592C / con cambio automatico e rallentatore idraulico ZF 4/5HP592C	DC9.02 Euro3	191	260	09/02 >				S 2234 Z
with air-conditioner WEBASTO Aerosphere / con climatizzatore WEBASTO Aerosphere	DC9.02 Euro3	191	260	09/02 >	S 4402 R	S 4341 NR	S 8570 A	S 3081 C
dryer filter / filtro essiccatore	DC9.02 Euro3	191	260	09/02 >				S 7F30 A
inner / interno	DC9.02 Euro3	191	260	09/02 >			S 7288 A	
power steering / servosterzo	DC9.02 Euro3	191	260	09/02 >				S 3081 PO
12 m								
with automatic gearbox and hydraulic retarder ZF 5HP602 / con cambio automatico e rallentatore idraulico ZF 5HP602	DC9.03 Euro3	221	300	09/02 >				S 2234 Z
with air-conditioner WEBASTO Aerosphere / con climatizzatore WEBASTO Aerosphere	DC9.03 Euro3	221	300	09/02 >	S 4402 R	S 4341 NR	S 8570 A	S 3081 C
dryer filter / filtro essiccatore	DC9.03 Euro3	221	300	09/02 >				S 7F30 A
inner / interno	DC9.03 Euro3	221	300	09/02 >			S 7288 A	
power steering / servosterzo	DC9.03 Euro3	221	300	09/02 >				S 3081 PO

Touring

HD 12-360	DC09.112 E6	265	360	01/14 >	S 5181 PE	S 6147 NE	S 7A11 A	
dryer filter / filtro essiccatore	DC09.112 E6	265	360	01/14 >				S 7F30 A
retarder / freno di rallentamento	DC09.112 E6	265	360	01/14 >				S 5613 PO
inner / interno	DC09.112 E6	265	360	01/14 >			S 7649 A	
power steering / servosterzo	DC09.112 E6	265	360	01/14 >				S 3081 PO
HD 12-410	DC13.125 E6	302	410	01/14 >	S 5181 PE	S 6147 NE	S 7A11 A	
dryer filter / filtro essiccatore	DC13.125 E6	302	410	01/14 >				S 7F30 A
retarder / freno di rallentamento	DC13.125 E6	302	410	01/14 >				S 5613 PO
inner / interno	DC13.125 E6	302	410	01/14 >			S 7649 A	
power steering / servosterzo	DC13.125 E6	302	410	01/14 >				S 3081 PO
HD 12-440	DC/DT13.10.440	324	440	02/10 >	S 5181 PE	S 6147 NE	S 7A11 A	
dryer filter / filtro essiccatore	DC/DT13.10.440	324	440	02/10 >				S 7F30 A
retarder / freno di rallentamento	DC/DT13.10.440	324	440	02/10 >				S 5613 PO
inner / interno	DC/DT13.10.440	324	440	02/10 >			S 7649 A	
power steering / servosterzo	DC/DT13.10.440	324	440	02/10 >				S 3081 PO
HD 12-450	DC13.124 E6	331	450	01/14 >	S 5181 PE	S 6147 NE	S 7A11 A	
dryer filter / filtro essiccatore	DC13.124 E6	331	450	01/14 >				S 7F30 A
retarder / freno di rallentamento	DC13.124 E6	331	450	01/14 >				S 5613 PO
inner / interno	DC13.124 E6	331	450	01/14 >			S 7649 A	
power steering / servosterzo	DC13.124 E6	331	450	01/14 >				S 3081 PO
HD 12-480	DC13.07.480	353	480	02/10 >	S 5181 PE	S 6147 NE	S 7A11 A	
dryer filter / filtro essiccatore	DC13.07.480	353	480	02/10 >				S 7F30 A
retarder / freno di rallentamento	DC13.07.480	353	480	02/10 >				S 5613 PO
inner / interno	DC13.07.480	353	480	02/10 >			S 7649 A	
power steering / servosterzo	DC13.07.480	353	480	02/10 >				S 3081 PO
HD 12-490	DC13.125 E6	360	490	01/14 >	S 5181 PE	S 6147 NE	S 7A11 A	
dryer filter / filtro essiccatore	DC13.125 E6	360	490	01/14 >				S 7F30 A
retarder / freno di rallentamento	DC13.125 E6	360	490	01/14 >				S 5613 PO
inner / interno	DC13.125 E6	360	490	01/14 >			S 7649 A	
power steering / servosterzo	DC13.125 E6	360	490	01/14 >				S 3081 PO

SCANIA**trucks/autocarri****110 Serie**

L 110	D 11			02/68 > 07/71		S 0201 N	S 2450 A	
	D 11			08/71 > 12/74		S 4323 NR	S 2450 A	
2nd passage / 2.passaggio	D 11			02/68 > 07/71		S 1411 N		
power steering / servosterzo	D 11			02/68 > 12/74				S 3081 PO
L 110	DS 11			02/68 > 07/71		S 0201 N	S 0450 A	
	DS 11			08/71 > 12/74		S 4323 NR	S 0450 A	
2nd passage / 2.passaggio	DS 11			02/68 > 07/71		S 1411 N		
power steering / servosterzo	DS 11			02/68 > 12/74				S 3081 PO
turbocompressor / turbocompressore	DS 11			02/68 > 12/74	S 2329 R			
LB 110	D 11			02/68 > 07/71		S 0201 N	S 2450 A	
	D 11			08/71 > 12/74		S 4323 NR	S 2450 A	
2nd passage / 2.passaggio	D 11			02/68 > 07/71		S 1411 N		
power steering / servosterzo	D 11			02/68 > 12/74				S 3081 PO
LB 110	DS 11			02/68 > 07/71		S 0201 N	S 0450 A	
	DS 11			08/71 > 12/74		S 4323 NR	S 0450 A	
2nd passage / 2.passaggio	DS 11			02/68 > 07/71		S 1411 N		
power steering / servosterzo	DS 11			02/68 > 12/74				S 3081 PO
turbocompressor / turbocompressore	DS 11			02/68 > 12/74	S 2329 R			
LBS 110	DS 11			02/68 > 07/71		S 0201 N	S 0450 A	
	DS 11			08/71 > 12/74		S 4323 NR	S 0450 A	



kW HP



...SCANIA - trucks/autocarri

2nd passage / 2.passaggio	DS 11	02/68 > 07/71		S 1411 N		
power steering / servosterzo	DS 11	02/68 > 12/74				S 3081 PO
turbocompressor / turbocompressore	DS 11	02/68 > 12/74	S 2329 R			
LBT 110						
	DS 11	02/68 > 07/71		S 0201 N	S 0450 A	
	DS 11	08/71 > 12/74		S 4323 NR	S 0450 A	
2nd passage / 2.passaggio	DS 11	02/68 > 07/71		S 1411 N		
power steering / servosterzo	DS 11	02/68 > 12/74				S 3081 PO
turbocompressor / turbocompressore	DS 11	02/68 > 12/74	S 2329 R			
LT 110						
	DS 11	02/68 > 07/71		S 0201 N	S 0450 A	
	DS 11	08/71 > 12/74		S 4323 NR	S 0450 A	
2nd passage / 2.passaggio	DS 11	02/68 > 07/71		S 1411 N		
power steering / servosterzo	DS 11	02/68 > 12/74				S 3081 PO
turbocompressor / turbocompressore	DS 11	02/68 > 12/74	S 2329 R			
111 Serie						
L 111						
	D 11	01/75 > 12/80		S 0201 N	S 2450 A	
2nd passage / 2.passaggio	D 11	01/75 > 12/80		S 1411 N		
some / alcuni	D 11	01/75 > 12/80		S 4323 NR	S 2450 A	
power steering / servosterzo	D 11	01/75 > 12/80				S 3081 PO
L 111						
	DS 11	01/75 > 12/80		S 0201 N	S 0450 A	
2nd passage / 2.passaggio	DS 11	01/75 > 12/80		S 1411 N		
some / alcuni	DS 11	01/75 > 12/80		S 4323 NR	S 0450 A	
power steering / servosterzo	DS 11	01/75 > 12/80				S 3081 PO
turbocompressor / turbocompressore	DS 11	01/75 > 12/80	S 2329 R			
LB 111						
	D 11	01/75 > 12/80		S 0201 N	S 2450 A	
2nd passage / 2.passaggio	D 11	01/75 > 12/80		S 1411 N		
spin-on / avvitabile	D 11	01/75 > 12/80		S 4323 NR	S 2450 A	
power steering / servosterzo	D 11	01/75 > 12/80				S 3081 PO
LBS 111						
	D 11	01/75 > 12/80		S 0201 N	S 2450 A	
2nd passage / 2.passaggio	D 11	01/75 > 12/80		S 1411 N		
spin-on / avvitabile	D 11	01/75 > 12/80		S 4323 NR	S 2450 A	
power steering / servosterzo	D 11	01/75 > 12/80				S 3081 PO
LBT 111						
	D 11	01/75 > 12/80		S 0201 N	S 2450 A	
2nd passage / 2.passaggio	D 11	01/75 > 12/80		S 1411 N		
spin-on / avvitabile	D 11	01/75 > 12/80		S 4323 NR	S 2450 A	
power steering / servosterzo	D 11	01/75 > 12/80				S 3081 PO
LS 111						
	D 11	01/75 > 12/80		S 0201 N	S 2450 A	
2nd passage / 2.passaggio	D 11	01/75 > 12/80		S 1411 N		
some / alcuni	D 11	01/75 > 12/80		S 4323 NR	S 2450 A	
power steering / servosterzo	D 11	01/75 > 12/80				S 3081 PO
LS 111						
	DS 11	01/75 > 12/80		S 0201 N	S 0450 A	
2nd passage / 2.passaggio	DS 11	01/75 > 12/80		S 1411 N		
some / alcuni	DS 11	01/75 > 12/80		S 4323 NR	S 0450 A	
power steering / servosterzo	DS 11	01/75 > 12/80				S 3081 PO
turbocompressor / turbocompressore	DS 11	01/75 > 12/80	S 2329 R			
LT 111						
2nd passage / 2.passaggio	D 11	01/75 > 12/80		S 1411 N		
some / alcuni	D 11	01/75 > 12/80		S 4323 NR	S 2450 A	
spin-on / avvitabile	D 11	01/75 > 12/80		S 4323 NR	S 0450 A	
power steering / servosterzo	D 11	01/75 > 12/80				S 3081 PO
LT 111						
	DS 11	01/75 > 12/80		S 0201 N	S 0450 A	
2nd passage / 2.passaggio	DS 11	01/75 > 12/80		S 1411 N		
some / alcuni	DS 11	01/75 > 12/80		S 4323 NR	S 0450 A	
power steering / servosterzo	DS 11	01/75 > 12/80				S 3081 PO
turbocompressor / turbocompressore	DS 11	01/75 > 12/80	S 2329 R			
112 Serie						
P 112 H						
	DS 11	01/81 > 05/88		S 4323 NR	S 0050 A	
some / alcuni	DS 11	01/81 > 05/88		S 8501 NR	S 0050 A	
dryer filter / filtro essiccatore	DS 11	01/85 > 05/88				S 7259 A
power steering / servosterzo	DS 11	01/81 > 05/88				S 3081 PO
turbocompressor / turbocompressore	DS 11	01/81 > 05/88	S 2329 R			
P 112 M						
	DS 11	01/81 > 05/88		S 4323 NR	S 0050 A	
some / alcuni	DS 11	01/81 > 05/88		S 8501 NR	S 0050 A	
dryer filter / filtro essiccatore	DS 11	01/85 > 05/88				S 7259 A
power steering / servosterzo	DS 11	01/81 > 05/88				S 3081 PO
turbocompressor / turbocompressore	DS 11	01/81 > 05/88	S 2329 R			
P 112 MA						
	DS 11	01/81 > 05/88		S 4323 NR	S 0050 A	
some / alcuni	DS 11	01/81 > 05/88		S 8501 NR	S 0050 A	

S





kW HP



...SCANIA - trucks/autocarri

S



dryer filter / filtro essiccatore	DS 11	01/85 > 05/88				S 7259 A
power steering / servosterzo	DS 11	01/81 > 05/88				S 3081 PO
turbocompressor / turbocompressore	DS 11	01/81 > 05/88	S 2329 R			
R 112 H						
some / alcuni	DS 11	01/81 > 05/88		S 4323 NR	S 0050 A	
dryer filter / filtro essiccatore	DS 11	01/85 > 05/88		S 8501 NR	S 0050 A	
power steering / servosterzo	DS 11	01/81 > 05/88				S 7259 A
turbocompressor / turbocompressore	DS 11	01/81 > 05/88	S 2329 R			S 3081 PO
R 112 M						
some / alcuni	DS 11	01/81 > 05/88		S 4323 NR	S 0050 A	
dryer filter / filtro essiccatore	DS 11	01/85 > 05/88		S 8501 NR	S 0050 A	
power steering / servosterzo	DS 11	01/81 > 05/88				S 7259 A
turbocompressor / turbocompressore	DS 11	01/81 > 05/88	S 2329 R			S 3081 PO
T 112 E						
some / alcuni	DS 11	01/81 > 05/88		S 4323 NR	S 0050 A	
dryer filter / filtro essiccatore	DS 11	01/85 > 05/88		S 8501 NR	S 0050 A	
power steering / servosterzo	DS 11	01/81 > 05/88				S 7259 A
turbocompressor / turbocompressore	DS 11	01/81 > 05/88	S 2329 R			S 3081 PO
T 112 H						
some / alcuni	DN 11	05/80 > 05/88		S 4323 NR	S 0050 A	
dryer filter / filtro essiccatore	DN 11	01/85 > 05/88		S 8501 NR	S 0050 A	
power steering / servosterzo	DN 11	05/80 > 05/88				S 7259 A
turbocompressor / turbocompressore	DN 11	05/80 > 05/88				S 3081 PO
T 112 H						
some / alcuni	DS 11	01/81 > 05/88		S 4323 NR	S 0050 A	
dryer filter / filtro essiccatore	DS 11	01/85 > 05/88		S 8501 NR	S 0050 A	
power steering / servosterzo	DS 11	01/81 > 05/88				S 7259 A
turbocompressor / turbocompressore	DS 11	01/81 > 05/88	S 2329 R			S 3081 PO
T 112 M						
some / alcuni	DS 11	01/81 > 05/88		S 4323 NR	S 0050 A	
dryer filter / filtro essiccatore	DS 11	01/85 > 05/88		S 8501 NR	S 0050 A	
power steering / servosterzo	DS 11	01/81 > 05/88				S 7259 A
turbocompressor / turbocompressore	DS 11	01/81 > 05/88	S 2329 R			S 3081 PO
113 Serie						
P 113 M 310						
some / alcuni	DS 11, DSC 11	05/88 > 05/97		S 8501 NR		
with outer air intake at the top / con presa aria in alto, esterno	DS 11, DSC 11	05/88 > 05/97		S 4323 NR	S 8570 A	
with outer air intake at the bottom / con presa aria in basso, esterno	DS 11, DSC 11	05/88 > 05/97		S 4323 NR	S 7214 A	
dryer filter / filtro essiccatore	DS 11, DSC 11	05/88 > 05/97				S 7259 A
inner / interno	DS 11, DSC 11	05/88 > 05/97			S 7288 A	
power steering / servosterzo	DS 11, DSC 11	05/88 > 05/97				S 3081 PO
turbocompressor / turbocompressore	DS 11, DSC 11	05/88 > 05/97	S 2329 R			
P 113 M 340						
some / alcuni	DS 11, DSC 11	05/88 > 05/97		S 8501 NR		
with outer air intake at the top / con presa aria in alto, esterno	DS 11, DSC 11	05/88 > 05/97		S 4323 NR	S 8570 A	
with outer air intake at the bottom / con presa aria in basso, esterno	DS 11, DSC 11	05/88 > 05/97		S 4323 NR	S 7214 A	
dryer filter / filtro essiccatore	DS 11, DSC 11	05/88 > 05/97				S 7259 A
inner / interno	DS 11, DSC 11	05/88 > 05/97			S 7288 A	
power steering / servosterzo	DS 11, DSC 11	05/88 > 05/97				S 3081 PO
turbocompressor / turbocompressore	DS 11, DSC 11	05/88 > 05/97	S 2329 R			
R 113 H 360						
some / alcuni	DSC 11	05/88 > 05/97		S 8501 NR		
with outer air intake at the top / con presa aria in alto, esterno	DSC 11	05/88 > 05/97		S 4323 NR	S 8570 A	
with outer air intake at the bottom / con presa aria in basso, esterno	DSC 11	05/88 > 05/97		S 4323 NR	S 7214 A	
dryer filter / filtro essiccatore	DSC 11	05/88 > 05/97				S 7259 A
inner / interno	DSC 11	05/88 > 05/97			S 7288 A	
power steering / servosterzo	DSC 11	05/88 > 05/97				S 3081 PO
turbocompressor / turbocompressore	DSC 11	05/88 > 05/97	S 2329 R			
R 113 H 380						
some / alcuni		05/88 > 05/97		S 8501 NR		
with outer air intake at the top / con presa aria in alto, esterno		05/88 > 05/97		S 4323 NR	S 8570 A	
with air intake at the bottom / con presa aria in basso		05/88 > 05/97		S 4323 NR	S 7214 A	
dryer filter / filtro essiccatore		05/88 > 05/97				S 7259 A
inner / interno		05/88 > 05/97			S 7288 A	
power steering / servosterzo		05/88 > 05/97				S 3081 PO
turbocompressor / turbocompressore		05/88 > 05/97	S 2329 R			
R 113 M 320						
some / alcuni	DSC 11	05/88 > 05/97		S 8501 NR		



KW HP



...SCANIA - trucks/autocarri

with outer air intake at the top / con presa aria in alto, esterno	DSC 11			05/88 > 05/97		S 4323 NR	S 8570 A		
with outer air intake at the bottom / con presa aria in basso, esterno	DSC 11			05/88 > 05/97		S 4323 NR	S 7214 A		
dryer filter / filtro essiccatore	DSC 11			05/88 > 05/97				S 7259 A	
inner / interno	DSC 11			05/88 > 05/97			S 7288 A		
power steering / servosterzo	DSC 11			05/88 > 05/97				S 3081 PO	
turbocompressor / turbocompressore	DSC 11			05/88 > 05/97	S 2329 R				
R 113 M 360									
some / alcuni	DSC 11			05/88 > 05/97		S 8501 NR			
with outer air intake at the top / con presa aria in alto, esterno	DSC 11			05/88 > 05/97		S 4323 NR	S 8570 A		
with outer air intake at the bottom / con presa aria in basso, esterno	DSC 11			05/88 > 05/97		S 4323 NR	S 7214 A		
dryer filter / filtro essiccatore	DSC 11			05/88 > 05/97				S 7259 A	
inner / interno	DSC 11			05/88 > 05/97			S 7288 A		
power steering / servosterzo	DSC 11			05/88 > 05/97				S 3081 PO	
turbocompressor / turbocompressore	DSC 11			05/88 > 05/97	S 2329 R				
R 113 M 380									
some / alcuni				05/88 > 05/97		S 8501 NR			
with outer air intake at the top / con presa aria in alto, esterno				05/88 > 05/97		S 4323 NR	S 8570 A		
with air intake at the bottom / con presa aria in basso				05/88 > 05/97		S 4323 NR	S 7214 A		
dryer filter / filtro essiccatore				05/88 > 05/97				S 7259 A	
inner / interno				05/88 > 05/97			S 7288 A		
power steering / servosterzo				05/88 > 05/97				S 3081 PO	
turbocompressor / turbocompressore				05/88 > 05/97	S 2329 R				
R 113 M 400									
some / alcuni				05/88 > 05/97		S 8501 NR			
with outer air intake at the top / con presa aria in alto, esterno				05/88 > 05/97		S 4323 NR	S 8570 A		
with outer air intake at the bottom / con presa aria in basso, esterno				05/88 > 05/97		S 4323 NR	S 7214 A		
dryer filter / filtro essiccatore				05/88 > 05/97				S 7259 A	
inner / interno				05/88 > 05/97			S 7288 A		
power steering / servosterzo				05/88 > 05/97				S 3081 PO	
turbocompressor / turbocompressore				05/88 > 05/97	S 2329 R				
T 113 M 320									
	DSC 11			05/88 > 05/00		S 4323 NR	S 7214 A		
some / alcuni	DSC 11			05/88 > 05/00		S 8501 NR	S 7214 A		
dryer filter / filtro essiccatore	DSC 11			05/88 > 05/00				S 7259 A	
power steering / servosterzo	DSC 11			05/88 > 05/00				S 3081 PO	
turbocompressor / turbocompressore	DSC 11			05/88 > 05/00	S 2329 R				
T 113 M 360									
	DSC 11			05/88 > 05/00		S 4323 NR	S 7214 A		
some / alcuni	DSC 11			05/88 > 05/00		S 8501 NR	S 7214 A		
dryer filter / filtro essiccatore	DSC 11			05/88 > 05/00				S 7259 A	
power steering / servosterzo	DSC 11			05/88 > 05/00				S 3081 PO	
turbocompressor / turbocompressore	DSC 11			05/88 > 05/00	S 2329 R				
114 Serie									
P114 C 340									
	DC11 Euro3	250 340		03/99 > 10/04	S 4402 R	S 4341 NR		S 3066 C	
dryer filter WABCO / filtro essiccatore WABCO	DC11 Euro3	250 340		03/99 > 10/04				S 7344 A	
retarder / freno di rallentamento	DC11 Euro3	250 340		03/99 > 10/04				S 5613 PO	
export models Russia / modelli di esportazione Russia	DC11 Euro3	250 340		03/99 > 10/04			S 7642 A		
assembly DONALDSON / montaggio DONALDSON	DC11 Euro3	250 340		03/99 > 10/04			S 7286 A		
DONALDSON assembly flame retardant media / montaggio DONALDSON media filtrante ritardante di fiamma	DC11 Euro3	250 340		03/99 > 10/04			S 7A25 A		
DONALDSON assembly short version / montaggio DONALDSON versione corta	DC11 Euro3	250 340		03/99 > 10/04			S 7B36 A		
assembly KNECHT-MAHLE / montaggio KNECHT-MAHLE	DC11 Euro3	250 340		03/99 > 10/04			S 7970 A		
prefilter / prefiltro	DC11 Euro3	250 340		03/99 > 10/04				S 3452 C	
prefilter RACOR / prefiltro RACOR	DC11 Euro3	250 340		03/99 > 10/04		S 4143 NR			
power steering / servosterzo	DC11 Euro3	250 340		03/99 > 10/04				S 3081 PO	
P114 C 340									
	DSC11 Euro2	250 340		10/96 > 10/04	S 4402 R	S 0310 NR		S 3066 C	
dryer filter WABCO / filtro essiccatore WABCO	DSC11 Euro2	250 340		10/96 > 10/04				S 7344 A	
retarder / freno di rallentamento	DSC11 Euro2	250 340		10/96 > 10/04				S 5613 PO	
export models Russia / modelli di esportazione Russia	DSC11 Euro2	250 340		10/96 > 10/04			S 7642 A		
assembly DONALDSON / montaggio DONALDSON	DSC11 Euro2	250 340		10/96 > 10/04			S 7286 A		
DONALDSON assembly flame retardant media / montaggio DONALDSON media filtrante ritardante di fiamma	DSC11 Euro2	250 340		10/96 > 10/04			S 7A25 A		
DONALDSON assembly short version / montaggio DONALDSON versione corta	DSC11 Euro2	250 340		10/96 > 10/04			S 7B36 A		
assembly KNECHT-MAHLE / montaggio KNECHT-MAHLE	DSC11 Euro2	250 340		10/96 > 10/04			S 7970 A		
prefilter / prefiltro	DSC11 Euro2	250 340		10/96 > 10/04				S 3452 C	
prefilter RACOR / prefiltro RACOR	DSC11 Euro2	250 340		10/96 > 10/04		S 4143 NR			
power steering / servosterzo	DSC11 Euro2	250 340		10/96 > 10/04				S 3081 PO	
P114 C 380									
	DSC11 Euro2	280 381		10/96 > 10/04	S 4402 R	S 0310 NR		S 3066 C	
dryer filter WABCO / filtro essiccatore WABCO	DSC11 Euro2	280 381		10/96 > 10/04				S 7344 A	
retarder / freno di rallentamento	DSC11 Euro2	280 381		10/96 > 10/04				S 5613 PO	
export models Russia / modelli di esportazione Russia	DSC11 Euro2	280 381		10/96 > 09/04			S 7642 A		





KW HP



...SCANIA - trucks/autocarri

assembly DONALDSON / montaggio DONALDSON	DSC11 Euro2	280	381	10/96	>	10/04			S 7286 A	
DONALDSON assembly flame retardant media / montaggio DONALDSON media filtrante ritardante di fiamma	DSC11 Euro2	280	381	10/96	>	10/04			S 7A25 A	
DONALDSON assembly short version / montaggio DONALDSON versione corta	DSC11 Euro2	280	381	10/96	>	10/04			S 7B36 A	
assembly KNECHT-MAHLE / montaggio KNECHT-MAHLE	DSC11 Euro2	280	381	10/96	>	10/04			S 7970 A	
prefilter RACOR / prefiltra RACOR	DSC11 Euro2	280	381	10/96	>	10/04		S 4143 NR		
power steering / servosterzo	DSC11 Euro2	280	381	10/96	>	10/04				S 3081 PO
P114 G 340	DSC11 Euro2	250	340	10/96	>	10/04	S 4402 R	S 0310 NR		S 3066 C
dryer filter WABCO / filtro essiccatore WABCO	DSC11 Euro2	250	340	10/96	>	10/04				S 7344 A
retarder / freno di rallentamento	DSC11 Euro2	250	340	10/96	>	10/04				S 5613 PO
export models Russia / modelli di esportazione Russia	DSC11 Euro2	250	340	10/96	>	10/04			S 7642 A	
assembly DONALDSON / montaggio DONALDSON	DSC11 Euro2	250	340	10/96	>	10/04			S 7286 A	
DONALDSON assembly flame retardant media / montaggio DONALDSON media filtrante ritardante di fiamma	DSC11 Euro2	250	340	10/96	>	10/04			S 7A25 A	
DONALDSON assembly short version / montaggio DONALDSON versione corta	DSC11 Euro2	250	340	10/96	>	10/04			S 7B36 A	
assembly KNECHT-MAHLE / montaggio KNECHT-MAHLE	DSC11 Euro2	250	340	10/96	>	10/04			S 7970 A	
prefilter RACOR / prefiltra RACOR	DSC11 Euro2	250	340	10/96	>	10/04		S 4143 NR		
power steering / servosterzo	DSC11 Euro2	250	340	10/96	>	10/04				S 3081 PO
P114 G 380	DSC11 Euro2	280	381	10/96	>	10/04	S 4402 R	S 0310 NR		S 3066 C
dryer filter WABCO / filtro essiccatore WABCO	DSC11 Euro2	280	381	10/96	>	10/04				S 7344 A
retarder / freno di rallentamento	DSC11 Euro2	280	381	10/96	>	10/04				S 5613 PO
export models Russia / modelli di esportazione Russia	DSC11 Euro2	280	381	10/96	>	10/04			S 7642 A	
assembly DONALDSON / montaggio DONALDSON	DSC11 Euro2	280	381	10/96	>	10/04			S 7286 A	
DONALDSON assembly flame retardant media / montaggio DONALDSON media filtrante ritardante di fiamma	DSC11 Euro2	280	381	10/96	>	10/04			S 7A25 A	
DONALDSON assembly short version / montaggio DONALDSON versione corta	DSC11 Euro2	280	381	10/96	>	10/04			S 7B36 A	
assembly KNECHT-MAHLE / montaggio KNECHT-MAHLE	DSC11 Euro2	280	381	10/96	>	10/04			S 7970 A	
prefilter RACOR / prefiltra RACOR	DSC11 Euro2	280	381	10/96	>	10/04		S 4143 NR		
power steering / servosterzo	DSC11 Euro2	280	381	10/96	>	10/04				S 3081 PO
P114 L 320	DSC11 Euro1	235	320	10/96	>	10/04	S 4402 R	S 0310 NR	S 7286 A	S 3066 C
dryer filter WABCO / filtro essiccatore WABCO	DSC11 Euro1	235	320	10/96	>	10/04				S 7344 A
DONALDSON assembly short version / montaggio DONALDSON versione corta	DSC11 Euro1	235	320	10/96	>	10/04			S 7B36 A	
power steering / servosterzo	DSC11 Euro1	235	320	10/96	>	10/04				S 3081 PO
P114 L 340	DSC11 Euro2	250	340	10/96	>	10/04	S 4402 R	S 0310 NR		S 3066 C
dryer filter WABCO / filtro essiccatore WABCO	DSC11 Euro2	250	340	10/96	>	10/04				S 7344 A
retarder / freno di rallentamento	DSC11 Euro2	250	340	10/96	>	10/04				S 5613 PO
export models Russia / modelli di esportazione Russia	DSC11 Euro2	250	340	10/96	>	10/04			S 7642 A	
assembly DONALDSON / montaggio DONALDSON	DSC11 Euro2	250	340	10/96	>	10/04			S 7286 A	
DONALDSON assembly flame retardant media / montaggio DONALDSON media filtrante ritardante di fiamma	DSC11 Euro2	250	340	10/96	>	10/04			S 7A25 A	
DONALDSON assembly short version / montaggio DONALDSON versione corta	DSC11 Euro2	250	340	10/96	>	10/04			S 7B36 A	
assembly KNECHT-MAHLE / montaggio KNECHT-MAHLE	DSC11 Euro2	250	340	10/96	>	10/04			S 7970 A	
prefilter / prefiltra	DSC11 Euro2	250	340	10/96	>	10/04				S 3452 C
prefilter RACOR / prefiltra RACOR	DSC11 Euro2	250	340	10/96	>	10/04		S 4143 NR		
power steering / servosterzo	DSC11 Euro2	250	340	10/96	>	10/04				S 3081 PO
P114 L 360	DSC11 Euro1	265	360	10/96	>	10/04	S 4402 R	S 0310 NR	S 7286 A	S 3066 C
dryer filter WABCO / filtro essiccatore WABCO	DSC11 Euro1	265	360	10/96	>	10/04				S 7344 A
DONALDSON assembly short version / montaggio DONALDSON versione corta	DSC11 Euro1	265	360	10/96	>	10/04			S 7B36 A	
power steering / servosterzo	DSC11 Euro1	265	360	10/96	>	10/04				S 3081 PO
P114 L 380	DC11.02/DC11.04 Euro3	280	380	03/99	>	10/04	S 4402 R	S 4341 NR		S 3066 C
dryer filter / filtro essiccatore	DC11.02/DC11.04 Euro3	280	380	03/99	>	10/04				S 7344 A
export models Russia / modelli di esportazione Russia	DC11.02/DC11.04 Euro3	280	380	03/99	>	10/04			S 7642 A	
DONALDSON assembly / montaggio DONALDSON	DC11.02/DC11.04 Euro3	280	380	03/99	>	10/04			S 7286 A	
DONALDSON assembly flame retardant media / montaggio DONALDSON media filtrante ritardante di fiamma	DC11.02/DC11.04 Euro3	280	380	03/99	>	10/04			S 7A25 A	
DONALDSON assembly short version / montaggio DONALDSON versione corta	DC11.02/DC11.04 Euro3	280	380	03/99	>	10/04			S 7B36 A	
assembly KNECHT-MAHLE / montaggio KNECHT-MAHLE	DC11.02/DC11.04 Euro3	280	380	03/99	>	10/04			S 7970 A	
prefilter RACOR / prefiltra RACOR	DC11.02/DC11.04 Euro3	280	380	03/99	>	10/04		S 4143 NR		
power steering / servosterzo	DC11.02/DC11.04 Euro3	280	380	03/99	>	10/04				S 3081 PO
P114 L 380	DSC11 Euro2	280	381	10/96	>	10/04	S 4402 R	S 0310 NR		S 3066 C
dryer filter WABCO / filtro essiccatore WABCO	DSC11 Euro2	280	381	10/96	>	10/04				S 7344 A
retarder / freno di rallentamento	DSC11 Euro2	280	381	10/96	>	10/04				S 5613 PO
export models Russia / modelli di esportazione Russia	DSC11 Euro2	280	381	10/96	>	10/04			S 7642 A	
assembly DONALDSON / montaggio DONALDSON	DSC11 Euro2	280	381	10/96	>	10/04			S 7286 A	
DONALDSON assembly flame retardant media / montaggio DONALDSON media filtrante ritardante di fiamma	DSC11 Euro2	280	381	10/96	>	10/04			S 7A25 A	
DONALDSON assembly short version / montaggio DONALDSON versione corta	DSC11 Euro2	280	381	10/96	>	10/04			S 7B36 A	
assembly KNECHT-MAHLE / montaggio KNECHT-MAHLE	DSC11 Euro2	280	381	10/96	>	10/04			S 7970 A	
prefilter RACOR / prefiltra RACOR	DSC11 Euro2	280	381	10/96	>	10/04		S 4143 NR		
power steering / servosterzo	DSC11 Euro2	280	381	10/96	>	10/04				S 3081 PO
R114 C 320	DSC11 Euro1	235	320	10/96	>	10/04	S 4402 R	S 0310 NR	S 7286 A	S 3066 C
dryer filter WABCO / filtro essiccatore WABCO	DSC11 Euro1	235	320	10/96	>	10/04				S 7344 A
DONALDSON assembly short version / montaggio DONALDSON versione corta	DSC11 Euro1	235	320	10/96	>	10/04			S 7B36 A	

**KW HP****...SCANIA - trucks/autocarri****S**

assembly KNECHT-MAHLE / montaggio KNECHT-MAHLE	DSC11 Euro2	250	340	10/96	>	10/04			S 7970 A	
prefilter / prefiltro	DSC11 Euro2	250	340	10/96	>	10/04				S 3452 C
prefilter RACOR / prefiltro RACOR	DSC11 Euro2	250	340	10/96	>	10/04		S 4143 NR		
power steering / servosterzo	DSC11 Euro2	250	340	10/96	>	10/04				S 3081 PO
R114 L 360	DSC11 Euro1	265	360	10/96	>	10/04	S 4402 R	S 0310 NR	S 7286 A	S 3066 C
dryer filter WABCO / filtro essiccatore WABCO	DSC11 Euro1	265	360	10/96	>	10/04				S 7344 A
DONALDSON assembly short version / montaggio DONALDSON versione corta	DSC11 Euro1	265	360	10/96	>	10/04			S 7B36 A	
power steering / servosterzo	DSC11 Euro1	265	360	10/96	>	10/04				S 3081 PO
R114 L 380	DC11.02/DC11.04 Euro3	280	380	03/99	>	10/04	S 4402 R	S 4341 NR		S 3066 C
dryer filter / filtro essiccatore	DC11.02/DC11.04 Euro3	280	380	03/99	>	10/04				S 7344 A
export models Russia / modelli di esportazione Russia	DC11.02/DC11.04 Euro3	280	380	03/99	>	10/04			S 7642 A	
DONALDSON assembly / montaggio DONALDSON	DC11.02/DC11.04 Euro3	280	380	03/99	>	10/04			S 7286 A	
DONALDSON assembly flame retardant media / montaggio DONALDSON media filtrante ritardante di fiamma	DC11.02/DC11.04 Euro3	280	380	03/99	>	10/04			S 7A25 A	
DONALDSON assembly short version / montaggio DONALDSON versione corta	DC11.02/DC11.04 Euro3	280	380	03/99	>	10/04			S 7B36 A	
assembly KNECHT-MAHLE / montaggio KNECHT-MAHLE	DC11.02/DC11.04 Euro3	280	380	03/99	>	10/04			S 7970 A	
prefilter RACOR / prefiltro RACOR	DC11.02/DC11.04 Euro3	280	380	03/99	>	10/04		S 4143 NR		
power steering / servosterzo	DC11.02/DC11.04 Euro3	280	380	03/99	>	10/04				S 3081 PO
R114 L 380	DSC11 Euro2	280	381	10/96	>	10/04	S 4402 R	S 0310 NR		S 3066 C
dryer filter WABCO / filtro essiccatore WABCO	DSC11 Euro2	280	381	10/96	>	10/04				S 7344 A
retarder / freno di rallentamento	DSC11 Euro2	280	381	10/96	>	10/04				S 5613 PO
export models Russia / modelli di esportazione Russia	DSC11 Euro2	280	381	10/96	>	10/04			S 7642 A	
assembly DONALDSON / montaggio DONALDSON	DSC11 Euro2	280	381	10/96	>	10/04			S 7286 A	
DONALDSON assembly flame retardant media / montaggio DONALDSON media filtrante ritardante di fiamma	DSC11 Euro2	280	381	10/96	>	10/04			S 7A25 A	
DONALDSON assembly short version / montaggio DONALDSON versione corta	DSC11 Euro2	280	381	10/96	>	10/04			S 7B36 A	
assembly KNECHT-MAHLE / montaggio KNECHT-MAHLE	DSC11 Euro2	280	381	10/96	>	10/04			S 7970 A	
prefilter RACOR / prefiltro RACOR	DSC11 Euro2	280	381	10/96	>	10/04		S 4143 NR		
power steering / servosterzo	DSC11 Euro2	280	381	10/96	>	10/04				S 3081 PO
T114 C 320	DSC11 Euro1	235	320	10/96	>	10/04	S 4402 R	S 0310 NR	S 7286 A	S 3066 C
dryer filter WABCO / filtro essiccatore WABCO	DSC11 Euro1	235	320	10/96	>	10/04				S 7344 A
DONALDSON assembly short version / montaggio DONALDSON versione corta	DSC11 Euro1	235	320	10/96	>	10/04			S 7B36 A	
DONALDSON assembly short version / montaggio DONALDSON versione corta	DSC11 Euro1	235	320	10/96	>	10/04			S 7B36 A	
power steering / servosterzo	DSC11 Euro1	235	320	10/96	>	10/04				S 3081 PO
T114 C 340	DSC11 Euro2	250	340	10/96	>	10/04	S 4402 R	S 0310 NR		S 3066 C
dryer filter WABCO / filtro essiccatore WABCO	DSC11 Euro2	250	340	10/96	>	10/04				S 7344 A
retarder / freno di rallentamento	DSC11 Euro2	250	340	10/96	>	10/04				S 5613 PO
export models Russia / modelli di esportazione Russia	DSC11 Euro2	250	340	10/96	>	10/04			S 7642 A	
assembly DONALDSON / montaggio DONALDSON	DSC11 Euro2	250	340	10/96	>	10/04			S 7286 A	
DONALDSON assembly flame retardant media / montaggio DONALDSON media filtrante ritardante di fiamma	DSC11 Euro2	250	340	10/96	>	10/04			S 7A25 A	
DONALDSON assembly short version / montaggio DONALDSON versione corta	DSC11 Euro2	250	340	10/96	>	10/04			S 7B36 A	
assembly KNECHT-MAHLE / montaggio KNECHT-MAHLE	DSC11 Euro2	250	340	10/96	>	10/04			S 7970 A	
prefilter RACOR / prefiltro RACOR	DSC11 Euro2	250	340	10/96	>	10/04		S 4143 NR		
power steering / servosterzo	DSC11 Euro2	250	340	10/96	>	10/04				S 3081 PO
T114 C 360	DSC11 Euro1	265	360	10/96	>	10/04	S 4402 R	S 0310 NR	S 7286 A	S 3066 C
dryer filter WABCO / filtro essiccatore WABCO	DSC11 Euro1	265	360	10/96	>	10/04				S 7344 A
DONALDSON assembly short version / montaggio DONALDSON versione corta	DSC11 Euro1	265	360	10/96	>	10/04			S 7B36 A	
power steering / servosterzo	DSC11 Euro1	265	360	10/96	>	10/04				S 3081 PO
T114 C 380	DSC11 Euro2	280	381	10/96	>	10/04	S 4402 R	S 0310 NR		S 3066 C
dryer filter WABCO / filtro essiccatore WABCO	DSC11 Euro2	280	381	10/96	>	10/04				S 7344 A
retarder / freno di rallentamento	DSC11 Euro2	280	381	10/96	>	10/04				S 5613 PO
export models Russia / modelli di esportazione Russia	DSC11 Euro2	280	381	10/96	>	10/04			S 7642 A	
assembly DONALDSON / montaggio DONALDSON	DSC11 Euro2	280	381	10/96	>	10/04			S 7286 A	
DONALDSON assembly flame retardant media / montaggio DONALDSON media filtrante ritardante di fiamma	DSC11 Euro2	280	381	10/96	>	10/04			S 7A25 A	
DONALDSON assembly short version / montaggio DONALDSON versione corta	DSC11 Euro2	280	381	10/96	>	10/04			S 7B36 A	
assembly KNECHT-MAHLE / montaggio KNECHT-MAHLE	DSC11 Euro2	280	381	10/96	>	10/04			S 7970 A	
prefilter RACOR / prefiltro RACOR	DSC11 Euro2	280	381	10/96	>	10/04		S 4143 NR		
power steering / servosterzo	DSC11 Euro2	280	381	10/96	>	10/04				S 3081 PO
T114 G 320	DSC11 Euro1	235	320	10/96	>	10/04	S 4402 R	S 0310 NR	S 7286 A	S 3066 C
dryer filter WABCO / filtro essiccatore WABCO	DSC11 Euro1	235	320	10/96	>	10/04				S 7344 A
DONALDSON assembly short version / montaggio DONALDSON versione corta	DSC11 Euro1	235	320	10/96	>	10/04			S 7B36 A	
power steering / servosterzo	DSC11 Euro1	235	320	10/96	>	10/04				S 3081 PO
T114 G 340	DSC11 Euro2	250	340	10/96	>	10/04	S 4402 R	S 0310 NR		S 3066 C
dryer filter WABCO / filtro essiccatore WABCO	DSC11 Euro2	250	340	10/96	>	10/04				S 7344 A
retarder / freno di rallentamento	DSC11 Euro2	250	340	10/96	>	10/04				S 5613 PO
export models Russia / modelli di esportazione Russia	DSC11 Euro2	250	340	10/96	>	10/04			S 7642 A	
assembly DONALDSON / montaggio DONALDSON	DSC11 Euro2	250	340	10/96	>	10/04			S 7286 A	
DONALDSON assembly flame retardant media / montaggio DONALDSON media filtrante ritardante di fiamma	DSC11 Euro2	250	340	10/96	>	10/04			S 7A25 A	
DONALDSON assembly short version / montaggio DONALDSON versione corta	DSC11 Euro2	250	340	10/96	>	10/04			S 7B36 A	

**KW HP**

...SCANIA - trucks/autocarri

assembly KNECHT-MAHLE / montaggio KNECHT-MAHLE	DSC11 Euro2	250 340	10/96 >	10/04			S 4143 NR	S 7970 A	
prefilter RACOR / prefiltrao RACOR	DSC11 Euro2	250 340	10/96 >	10/04					S 3081 PO
power steering / servosterzo	DSC11 Euro2	250 340	10/96 >	10/04					S 3066 C
T114 G 360	DSC11 Euro1	265 360	10/96 >	10/04	S 4402 R	S 0310 NR		S 7286 A	S 7344 A
dryer filter WABCO / filtro essiccatore WABCO	DSC11 Euro1	265 360	10/96 >	10/04				S 7B36 A	
DONALDSON assembly short version / montaggio DONALDSON versione corta	DSC11 Euro1	265 360	10/96 >	10/04					S 3081 PO
power steering / servosterzo	DSC11 Euro1	265 360	10/96 >	10/04					S 3081 PO
T114 G 380	DSC11 Euro2	280 381	10/96 >	10/04	S 4402 R	S 0310 NR			S 3066 C
dryer filter WABCO / filtro essiccatore WABCO	DSC11 Euro2	280 381	10/96 >	10/04					S 7344 A
retarder / freno di rallentamento	DSC11 Euro2	280 381	10/96 >	10/04					S 5613 PO
export models Russia / modelli di esportazione Russia	DSC11 Euro2	280 381	10/96 >	10/04				S 7642 A	
assembly DONALDSON / montaggio DONALDSON	DSC11 Euro2	280 381	10/96 >	10/04				S 7286 A	
DONALDSON assembly flame retardant media / montaggio DONALDSON media filtrante ritardante di fiamma	DSC11 Euro2	280 381	10/96 >	10/04				S 7A25 A	
DONALDSON assembly short version / montaggio DONALDSON versione corta	DSC11 Euro2	280 381	10/96 >	10/04				S 7B36 A	
assembly KNECHT-MAHLE / montaggio KNECHT-MAHLE	DSC11 Euro2	280 381	10/96 >	10/04				S 7970 A	
prefilter RACOR / prefiltrao RACOR	DSC11 Euro2	280 381	10/96 >	10/04			S 4143 NR		
power steering / servosterzo	DSC11 Euro2	280 381	10/96 >	10/04					S 3081 PO
T114 L 320	DSC11 Euro1	235 320	10/96 >	10/04	S 4402 R	S 0310 NR		S 7286 A	S 3066 C
dryer filter WABCO / filtro essiccatore WABCO	DSC11 Euro1	235 320	10/96 >	10/04					S 7344 A
DONALDSON assembly short version / montaggio DONALDSON versione corta	DSC11 Euro1	235 320	10/96 >	10/04				S 7B36 A	
power steering / servosterzo	DSC11 Euro1	235 320	10/96 >	10/04					S 3081 PO
T114 L 340	DSC11 Euro2	250 340	10/96 >	10/04	S 4402 R	S 0310 NR			S 3066 C
dryer filter WABCO / filtro essiccatore WABCO	DSC11 Euro2	250 340	10/96 >	10/04					S 7344 A
retarder / freno di rallentamento	DSC11 Euro2	250 340	10/96 >	10/04					S 5613 PO
export models Russia / modelli di esportazione Russia	DSC11 Euro2	250 340	10/96 >	10/04				S 7642 A	
assembly DONALDSON / montaggio DONALDSON	DSC11 Euro2	250 340	10/96 >	10/04				S 7286 A	
DONALDSON assembly flame retardant media / montaggio DONALDSON media filtrante ritardante di fiamma	DSC11 Euro2	250 340	10/96 >	10/04				S 7A25 A	
DONALDSON assembly short version / montaggio DONALDSON versione corta	DSC11 Euro2	250 340	10/96 >	10/04				S 7B36 A	
assembly KNECHT-MAHLE / montaggio KNECHT-MAHLE	DSC11 Euro2	250 340	10/96 >	10/04				S 7970 A	
prefilter RACOR / prefiltrao RACOR	DSC11 Euro2	250 340	10/96 >	10/04			S 4143 NR		
power steering / servosterzo	DSC11 Euro2	250 340	10/96 >	10/04					S 3081 PO
T114 L 360	DSC11 Euro1	265 360	10/96 >	10/04	S 4402 R	S 0310 NR		S 7286 A	S 3066 C
dryer filter WABCO / filtro essiccatore WABCO	DSC11 Euro1	265 360	10/96 >	10/04					S 7344 A
DONALDSON assembly short version / montaggio DONALDSON versione corta	DSC11 Euro1	265 360	10/96 >	10/04				S 7B36 A	
power steering / servosterzo	DSC11 Euro1	265 360	10/96 >	10/04					S 3081 PO
T114 L 380	DC11.02/DC11.04 Euro3	280 380	03/99 >	10/04	S 4402 R	S 4341 NR			S 3066 C
dryer filter / filtro essiccatore	DC11.02/DC11.04 Euro3	280 380	03/99 >	10/04					S 7344 A
DONALDSON assembly / montaggio DONALDSON	DC11.02/DC11.04 Euro3	280 380	03/99 >	10/04				S 7286 A	
DONALDSON assembly flame retardant media / montaggio DONALDSON media filtrante ritardante di fiamma	DC11.02/DC11.04 Euro3	280 380	03/99 >	10/04				S 7A25 A	
DONALDSON assembly short version / montaggio DONALDSON versione corta	DC11.02/DC11.04 Euro3	280 380	03/99 >	10/04				S 7B36 A	
assembly KNECHT-MAHLE / montaggio KNECHT-MAHLE	DC11.02/DC11.04 Euro3	280 380	03/99 >	10/04				S 7970 A	
prefilter RACOR / prefiltrao RACOR	DC11.02/DC11.04 Euro3	280 380	03/99 >	10/04			S 4143 NR		
power steering / servosterzo	DC11.02/DC11.04 Euro3	280 380	03/99 >	10/04					S 3081 PO
T114 L 380	DSC11 Euro2	280 381	10/96 >	10/04	S 4402 R	S 0310 NR			S 3066 C
dryer filter WABCO / filtro essiccatore WABCO	DSC11 Euro2	280 381	10/96 >	10/04					S 7344 A
retarder / freno di rallentamento	DSC11 Euro2	280 381	10/96 >	10/04					S 5613 PO
flame retardant media DONALDSON / media filtrante ritardante di fiamma DONALDSON	DSC11 Euro2	280 381	10/96 >	10/04				S 7A25 A	
export models Russia / modelli di esportazione Russia	DSC11 Euro2	280 381	10/96 >	10/04				S 7642 A	
assembly DONALDSON / montaggio DONALDSON	DSC11 Euro2	280 381	10/96 >	10/04				S 7286 A	
DONALDSON assembly short version / montaggio DONALDSON versione corta	DSC11 Euro2	280 381	10/96 >	10/04				S 7B36 A	
assembly KNECHT-MAHLE / montaggio KNECHT-MAHLE	DSC11 Euro2	280 381	10/96 >	10/04				S 7970 A	
prefilter RACOR / prefiltrao RACOR	DSC11 Euro2	280 381	10/96 >	10/04			S 4143 NR		
power steering / servosterzo	DSC11 Euro2	280 381	10/96 >	10/04					S 3081 PO
124 Serie									
P124 C 400	DSC12.01 Euro2	294 400	11/95 >	10/04	S 4402 R	S 0310 NR			S 3066 C
dryer filter WABCO / filtro essiccatore WABCO	DSC12.01 Euro2	294 400	11/95 >	10/04					S 7344 A
export models Russia / modelli di esportazione Russia	DSC12.01 Euro2	294 400	11/95 >	10/04				S 7642 A	
DONALDSON assembly / montaggio DONALDSON	DSC12.01 Euro2	294 400	11/95 >	10/04				S 7286 A	
DONALDSON assembly flame retardant media / montaggio DONALDSON media filtrante ritardante di fiamma	DSC12.01 Euro2	294 400	11/95 >	10/04				S 7A25 A	
assembly KNECHT-MAHLE / montaggio KNECHT-MAHLE	DSC12.01 Euro2	294 400	11/95 >	10/04				S 7970 A	
power steering / servosterzo	DSC12.01 Euro2	294 400	11/95 >	10/04					S 3081 PO
P124 C 420	DSC12.05 Euro2	309 420	11/95 >	10/04	S 4402 R	S 0310 NR			S 3066 C
dryer filter WABCO / filtro essiccatore WABCO	DSC12.05 Euro2	309 420	11/95 >	10/04					S 7344 A
export models Russia / modelli di esportazione Russia	DSC12.05 Euro2	309 420	11/95 >	10/04				S 7642 A	
DONALDSON assembly / montaggio DONALDSON	DSC12.05 Euro2	309 420	11/95 >	10/04				S 7286 A	
DONALDSON assembly flame retardant media / montaggio DONALDSON media filtrante ritardante di fiamma	DSC12.05 Euro2	309 420	11/95 >	10/04				S 7A25 A	
assembly KNECHT-MAHLE / montaggio KNECHT-MAHLE	DSC12.05 Euro2	309 420	11/95 >	10/04	S 4402 R	S 0310 NR		S 7970 A	S 3066 C

S

**KW HP****...SCANIA - trucks/autocarri****S**

power steering / servosterzo	DSC12.05 Euro2	309	420	11/95	>	10/04				S 3081 PO
P124 G 420	DSC12.05 Euro2	309	420	11/95	>	10/04	S 4402 R	S 0310 NR		S 3066 C
dryer filter WABCO / filtro essiccatore WABCO	DSC12.05 Euro2	309	420	11/95	>	10/04				S 7344 A
export models Russia / modelli di esportazione Russia	DSC12.05 Euro2	309	420	11/95	>	10/04			S 7642 A	
DONALDSON assembly / montaggio DONALDSON	DSC12.05 Euro2	309	420	11/95	>	10/04			S 7286 A	
DONALDSON assembly flame retardant media / montaggio DONALDSON media filtrante ritardante di fiamma	DSC12.05 Euro2	309	420	11/95	>	10/04			S 7A25 A	
assembly KNECHT-MAHLE / montaggio KNECHT-MAHLE	DSC12.05 Euro2	309	420	11/95	>	10/04			S 7970 A	
power steering / servosterzo	DSC12.05 Euro2	309	420	11/95	>	10/04				S 3081 PO
P124 L 360	DSC12.02 Euro2	265	360	11/95	>	10/04	S 4402 R	S 0310 NR		S 3066 C
dryer filter WABCO / filtro essiccatore WABCO	DSC12.02 Euro2	265	360	11/95	>	10/04				S 7344 A
export models Russia / modelli di esportazione Russia	DSC12.02 Euro2	265	360	11/95	>	01/04			S 7642 A	
DONALDSON assembly / montaggio DONALDSON	DSC12.02 Euro2	265	360	11/95	>	10/04			S 7286 A	
DONALDSON assembly flame retardant media / montaggio DONALDSON media filtrante ritardante di fiamma	DSC12.02 Euro2	265	360	11/95	>	10/04			S 7A25 A	
assembly KNECHT-MAHLE / montaggio KNECHT-MAHLE	DSC12.02 Euro2	265	360	11/95	>	10/04			S 7970 A	
prefilter / prefiltrato	DSC12.02 Euro2	265	360	01/96	>	10/04				S 3452 C
power steering / servosterzo	DSC12.02 Euro2	265	360	11/95	>	10/04				S 3081 PO
P124 L 400	DSC12.01 Euro2	294	400	11/95	>	10/04	S 4402 R	S 0310 NR		S 3066 C
dryer filter WABCO / filtro essiccatore WABCO	DSC12.01 Euro2	294	400	11/95	>	10/04				S 7344 A
export models Russia / modelli di esportazione Russia	DSC12.01 Euro2	294	400	11/95	>	10/04			S 7642 A	
DONALDSON assembly / montaggio DONALDSON	DSC12.01 Euro2	294	400	11/95	>	10/04			S 7286 A	
DONALDSON assembly flame retardant media / montaggio DONALDSON media filtrante ritardante di fiamma	DSC12.01 Euro2	294	400	11/95	>	10/04			S 7A25 A	
assembly KNECHT-MAHLE / montaggio KNECHT-MAHLE	DSC12.01 Euro2	294	400	11/95	>	10/04			S 7970 A	
power steering / servosterzo	DSC12.01 Euro2	294	400	11/95	>	10/04				S 3081 PO
P124 L 420	DC12.01 Euro3	309	420	03/99	>	12/03	S 4402 R	S 4341 NR		S 3066 C
dryer filter WABCO / filtro essiccatore WABCO	DC12.01 Euro3	309	420	03/99	>	12/03				S 7344 A
export models Russia / modelli di esportazione Russia	DC12.01 Euro3	309	420	03/99	>	12/03			S 7642 A	
DONALDSON assembly / montaggio DONALDSON	DC12.01 Euro3	309	420	03/99	>	12/03			S 7286 A	
DONALDSON assembly flame retardant media / montaggio DONALDSON media filtrante ritardante di fiamma	DC12.01 Euro3	309	420	03/99	>	12/03			S 7A25 A	
assembly KNECHT-MAHLE / montaggio KNECHT-MAHLE	DC12.01 Euro3	309	420	03/99	>	12/03			S 7970 A	
power steering / servosterzo	DC12.01 Euro3	309	420	03/99	>	12/03				S 3081 PO
P124 L 420	DSC12.05 Euro2	309	420	11/95	>	10/04	S 4402 R	S 0310 NR		S 3066 C
dryer filter WABCO / filtro essiccatore WABCO	DSC12.05 Euro2	309	420	11/95	>	10/04				S 7344 A
export models Russia / modelli di esportazione Russia	DSC12.05 Euro2	309	420	11/95	>	10/04			S 7642 A	
DONALDSON assembly / montaggio DONALDSON	DSC12.05 Euro2	309	420	11/95	>	10/04			S 7286 A	
DONALDSON assembly flame retardant media / montaggio DONALDSON media filtrante ritardante di fiamma	DSC12.05 Euro2	309	420	11/95	>	10/04			S 7A25 A	
assembly KNECHT-MAHLE / montaggio KNECHT-MAHLE	DSC12.05 Euro2	309	420	11/95	>	10/04			S 7970 A	
power steering / servosterzo	DSC12.05 Euro2	309	420	11/95	>	10/04				S 3081 PO
P124 L 420 HPI	DC12.03 Euro3	309	420	10/02	>	10/04	S 4402 R	S 6010 NE		S 3066 C
dryer filter WABCO / filtro essiccatore WABCO	DC12.03 Euro3	309	420	10/02	>	10/04				S 7344 A
export models Russia / modelli di esportazione Russia	DC12.03 Euro3	309	420	10/02	>	10/04			S 7642 A	
DONALDSON assembly / montaggio DONALDSON	DC12.03 Euro3	309	420	10/02	>	10/04			S 7286 A	
DONALDSON assembly flame retardant media / montaggio DONALDSON media filtrante ritardante di fiamma	DC12.03 Euro3	309	420	10/02	>	10/04			S 7A25 A	
assembly KNECHT-MAHLE / montaggio KNECHT-MAHLE	DC12.03 Euro3	309	420	10/02	>	10/04			S 7970 A	
prefilter / prefiltrato	DC12.03 Euro3	309	420	10/02	>	10/04				S 3452 C
power steering / servosterzo	DC12.03 Euro3	309	420	10/02	>	10/04				S 3081 PO
P124 L 440 HPI	DT12.08 Euro3	324	440	09/00	>	10/04	S 4402 R	S 6010 NE		S 3066 C
dryer filter WABCO / filtro essiccatore WABCO	DT12.08 Euro3	324	440	09/00	>	10/04				S 7344 A
export models Russia / modelli di esportazione Russia	DT12.08 Euro3	324	440	09/00	>	10/04			S 7642 A	
DONALDSON assembly / montaggio DONALDSON	DT12.08 Euro3	324	440	09/00	>	10/04			S 7286 A	
DONALDSON assembly flame retardant media / montaggio DONALDSON media filtrante ritardante di fiamma	DT12.08 Euro3	324	440	09/00	>	10/04			S 7A25 A	
assembly KNECHT-MAHLE / montaggio KNECHT-MAHLE	DT12.08 Euro3	324	440	09/00	>	10/04			S 7970 A	
power steering / servosterzo	DT12.08 Euro3	324	440	09/00	>	10/04				S 3081 PO
P124 L 470 HPI	DT12.02 Euro3	346	470	09/00	>	10/04	S 4402 R	S 6010 NE		S 3066 C
dryer filter WABCO / filtro essiccatore WABCO	DT12.02 Euro3	346	470	09/00	>	10/04				S 7344 A
export models Russia / modelli di esportazione Russia	DT12.02 Euro3	346	470	09/00	>	10/04			S 7642 A	
DONALDSON assembly / montaggio DONALDSON	DT12.02 Euro3	346	470	09/00	>	10/04			S 7286 A	
DONALDSON assembly flame retardant media / montaggio DONALDSON media filtrante ritardante di fiamma	DT12.02 Euro3	346	470	09/00	>	10/04			S 7A25 A	
assembly KNECHT-MAHLE / montaggio KNECHT-MAHLE	DT12.02 Euro3	346	470	09/00	>	10/04			S 7970 A	
prefilter / prefiltrato	DT12.02 Euro3	346	470	02/01	>	10/04				S 3452 C
power steering / servosterzo	DT12.02 Euro3	346	470	09/00	>	10/04				S 3081 PO
R124 C 360	DSC12.02 Euro2	265	360	11/95	>	10/04	S 4402 R	S 0310 NR		S 3066 C
dryer filter WABCO / filtro essiccatore WABCO	DSC12.02 Euro2	265	360	11/95	>	10/04				S 7344 A
export models Russia / modelli di esportazione Russia	DSC12.02 Euro2	265	360	11/95	>	10/04			S 7642 A	
DONALDSON assembly / montaggio DONALDSON	DSC12.02 Euro2	265	360	11/95	>	10/04			S 7286 A	
DONALDSON assembly flame retardant media / montaggio DONALDSON media filtrante ritardante di fiamma	DSC12.02 Euro2	265	360	11/95	>	10/04			S 7A25 A	
assembly KNECHT-MAHLE / montaggio KNECHT-MAHLE	DSC12.02 Euro2	265	360	11/95	>	10/04			S 7970 A	
prefilter / prefiltrato	DSC12.02 Euro2	265	360	11/95	>	10/04				S 3452 C

**KW HP****...SCANIA - trucks/autocarri****S**

dryer filter WABCO / filtro essiccatore WABCO	DSC12.02 Euro2	265	360	11/95	>	10/04			S 7642 A	S 7344 A
export models Russia / modelli di esportazione Russia	DSC12.02 Euro2	265	360	11/95	>	10/04				
DONALDSON assembly / montaggio DONALDSON	DSC12.02 Euro2	265	360	11/95	>	10/04			S 7286 A	
DONALDSON assembly flame retardant media / montaggio DONALDSON media filtrante ritardante di fiamma	DSC12.02 Euro2	265	360	11/95	>	10/04			S 7A25 A	
assembly KNECHT-MAHLE / montaggio KNECHT-MAHLE	DSC12.02 Euro2	265	360	11/95	>	10/04			S 7970 A	
prefilter / prefiltro	DSC12.02 Euro2	265	360	11/95	>	10/04				S 3452 C
power steering / servosterzo	DSC12.02 Euro2	265	360	11/95	>	10/04				S 3081 PO
T124 C 420	DSC12.05 Euro2	309	420	11/95	>	10/04	S 4402 R	S 0310 NR		S 3066 C
dryer filter WABCO / filtro essiccatore WABCO	DSC12.05 Euro2	309	420	11/95	>	10/04				S 7344 A
export models Russia / modelli di esportazione Russia	DSC12.05 Euro2	309	420	11/95	>	10/04			S 7642 A	
DONALDSON assembly / montaggio DONALDSON	DSC12.05 Euro2	309	420	11/95	>	10/04			S 7286 A	
DONALDSON assembly flame retardant media / montaggio DONALDSON media filtrante ritardante di fiamma	DSC12.05 Euro2	309	420	11/95	>	10/04			S 7A25 A	
assembly KNECHT-MAHLE / montaggio KNECHT-MAHLE	DSC12.05 Euro2	309	420	11/95	>	10/04			S 7970 A	
power steering / servosterzo	DSC12.05 Euro2	309	420	11/95	>	10/04				S 3081 PO
T124 G 360	DSC12.02 Euro2	265	360	11/95	>	10/04	S 4402 R	S 0310 NR		S 3066 C
dryer filter WABCO / filtro essiccatore WABCO	DSC12.02 Euro2	265	360	11/95	>	10/04				S 7344 A
export models Russia / modelli di esportazione Russia	DSC12.02 Euro2	265	360	11/95	>	10/04			S 7642 A	
DONALDSON assembly / montaggio DONALDSON	DSC12.02 Euro2	265	360	11/95	>	10/04			S 7286 A	
DONALDSON assembly flame retardant media / montaggio DONALDSON media filtrante ritardante di fiamma	DSC12.02 Euro2	265	360	11/95	>	10/04			S 7A25 A	
assembly KNECHT-MAHLE / montaggio KNECHT-MAHLE	DSC12.02 Euro2	265	360	11/95	>	10/04			S 7970 A	
power steering / servosterzo	DSC12.02 Euro2	265	360	11/95	>	10/04				S 3081 PO
T124 G 420	DSC12.05 Euro2	309	420	11/95	>	10/04	S 4402 R	S 0310 NR		S 3066 C
dryer filter WABCO / filtro essiccatore WABCO	DSC12.05 Euro2	309	420	11/95	>	10/04				S 7344 A
export models Russia / modelli di esportazione Russia	DSC12.05 Euro2	309	420	11/95	>	10/04			S 7642 A	
DONALDSON assembly / montaggio DONALDSON	DSC12.05 Euro2	309	420	11/95	>	10/04			S 7286 A	
DONALDSON assembly flame retardant media / montaggio DONALDSON media filtrante ritardante di fiamma	DSC12.05 Euro2	309	420	11/95	>	10/04			S 7A25 A	
assembly KNECHT-MAHLE / montaggio KNECHT-MAHLE	DSC12.05 Euro2	309	420	11/95	>	10/04			S 7970 A	
power steering / servosterzo	DSC12.05 Euro2	309	420	11/95	>	10/04				S 3081 PO
T124 L 360	DSC12.02 Euro2	265	360	11/95	>	10/04	S 4402 R	S 0310 NR		S 3066 C
dryer filter WABCO / filtro essiccatore WABCO	DSC12.02 Euro2	265	360	11/95	>	10/04				S 7344 A
export models Russia / modelli di esportazione Russia	DSC12.02 Euro2	265	360	11/95	>	10/04			S 7642 A	
DONALDSON assembly / montaggio DONALDSON	DSC12.02 Euro2	265	360	11/95	>	10/04			S 7286 A	
DONALDSON assembly flame retardant media / montaggio DONALDSON media filtrante ritardante di fiamma	DSC12.02 Euro2	265	360	11/95	>	10/04			S 7A25 A	
assembly KNECHT-MAHLE / montaggio KNECHT-MAHLE	DSC12.02 Euro2	265	360	11/95	>	10/04			S 7970 A	
power steering / servosterzo	DSC12.02 Euro2	265	360	11/95	>	10/04				S 3081 PO
T124 L 400	DSC12.01 Euro2	294	400	11/95	>	10/04	S 4402 R	S 0310 NR		S 3066 C
dryer filter WABCO / filtro essiccatore WABCO	DSC12.01 Euro2	294	400	11/95	>	10/04				S 7344 A
export models Russia / modelli di esportazione Russia	DSC12.01 Euro2	294	400	11/95	>	10/04			S 7642 A	
DONALDSON assembly / montaggio DONALDSON	DSC12.01 Euro2	294	400	11/95	>	10/04			S 7286 A	
DONALDSON assembly flame retardant media / montaggio DONALDSON media filtrante ritardante di fiamma	DSC12.01 Euro2	294	400	11/95	>	10/04			S 7A25 A	
assembly KNECHT-MAHLE / montaggio KNECHT-MAHLE	DSC12.01 Euro2	294	400	11/95	>	10/04			S 7970 A	
power steering / servosterzo	DSC12.01 Euro2	294	400	11/95	>	10/04				S 3081 PO
T124 L 420	DC12.01 Euro3	309	420	03/99	>	12/03	S 4402 R	S 4341 NR		S 3066 C
dryer filter WABCO / filtro essiccatore WABCO	DC12.01 Euro3	309	420	03/99	>	12/03				S 7344 A
export models Russia / modelli di esportazione Russia	DC12.01 Euro3	309	420	03/99	>	12/03			S 7642 A	
DONALDSON assembly / montaggio DONALDSON	DC12.01 Euro3	309	420	03/99	>	12/03			S 7286 A	
DONALDSON assembly flame retardant media / montaggio DONALDSON media filtrante ritardante di fiamma	DC12.01 Euro3	309	420	03/99	>	12/03			S 7A25 A	
assembly KNECHT-MAHLE / montaggio KNECHT-MAHLE	DC12.01 Euro3	309	420	03/99	>	12/03			S 7970 A	
power steering / servosterzo	DC12.01 Euro3	309	420	03/99	>	12/03				S 3081 PO
T124 L 420	DSC12.05 Euro2	309	420	11/95	>	10/04	S 4402 R	S 0310 NR		S 3066 C
dryer filter WABCO / filtro essiccatore WABCO	DSC12.05 Euro2	309	420	11/95	>	10/04				S 7344 A
export models Russia / modelli di esportazione Russia	DSC12.05 Euro2	309	420	11/95	>	10/04			S 7642 A	
DONALDSON assembly / montaggio DONALDSON	DSC12.05 Euro2	309	420	11/95	>	10/04			S 7286 A	
DONALDSON assembly flame retardant media / montaggio DONALDSON media filtrante ritardante di fiamma	DSC12.05 Euro2	309	420	11/95	>	10/04			S 7A25 A	
assembly KNECHT-MAHLE / montaggio KNECHT-MAHLE	DSC12.05 Euro2	309	420	11/95	>	10/04			S 7970 A	
power steering / servosterzo	DSC12.05 Euro2	309	420	11/95	>	10/04				S 3081 PO
140 Serie										
L 140	DS 14			01/69	>	10/77		S 4323 NR	S 0450 A	
power steering / servosterzo	DS 14			01/69	>	10/77				S 3081 PO
turbocompressor / turbocompressore	DS 14			01/69	>	10/77	S 2329 R			
LB 140	DS 14			01/69	>	10/77		S 4323 NR	S 7186 A	
power steering / servosterzo	DS 14			01/69	>	10/77				S 3081 PO
turbocompressor / turbocompressore	DS 14			01/69	>	10/77	S 2329 R			
LBS 140	DS 14			01/69	>	10/77		S 4323 NR	S 7186 A	
power steering / servosterzo	DS 14			01/69	>	10/77				S 3081 PO
turbocompressor / turbocompressore	DS 14			01/69	>	10/77	S 2329 R			
LBT 140	DS 14			01/69	>	10/77		S 4323 NR	S 0050 A	



kW HP



...SCANIA - trucks/autocarri

S

power steering / servosterzo	DS 14	05/80 > 03/88				S 3081 PO
turbocompressor / turbocompressore	DS 14	05/80 > 03/88	S 2329 R			
143 Serie						
R 143 E 420						
with outer air intake at the top / con presa aria in alto, esterno	DSC 14	03/88 > 12/96		S 4323 NR	S 8570 A	
dryer filter / filtro essiccatore	DSC 14	03/88 > 12/96				S 7259 A
inner / interno	DSC 14	03/88 > 12/96			S 7288 A	
power steering / servosterzo	DSC 14	03/88 > 12/96				S 3081 PO
turbocompressor / turbocompressore	DSC 14	03/88 > 12/96	S 2329 R			
R 143 H 420						
with outer air intake at the top / con presa aria in alto, esterno	DSC 14	03/88 > 12/96		S 4323 NR	S 8570 A	
dryer filter / filtro essiccatore	DSC 14	01/88 > 12/96				S 7259 A
inner / interno	DSC 14	03/88 > 12/96			S 7288 A	
power steering / servosterzo	DSC 14	03/88 > 12/96				S 3081 PO
turbocompressor / turbocompressore	DSC 14	03/88 > 12/96	S 2329 R			
R 143 H 450						
with outer air intake at the top / con presa aria in alto, esterno	DSC 14	03/88 > 12/96		S 4323 NR	S 8570 A	
dryer filter / filtro essiccatore	DSC 14	03/88 > 12/96				S 7259 A
inner / interno	DSC 14	03/88 > 12/96			S 7288 A	
power steering / servosterzo	DSC 14	03/88 > 12/96				S 3081 PO
turbocompressor / turbocompressore	DSC 14	03/88 > 12/96	S 2329 R			
R 143 H 500						
with outer air intake at the top / con presa aria in alto, esterno	DSC 14	03/88 > 12/96		S 4323 NR	S 8570 A	
dryer filter / filtro essiccatore	DSC 14	03/88 > 12/96				S 7259 A
inner / interno	DSC 14	03/88 > 12/96			S 7288 A	
power steering / servosterzo	DSC 14	03/88 > 12/96				S 3081 PO
turbocompressor / turbocompressore	DSC 14	03/88 > 12/96	S 2329 R			
R 143 M 400						
some / alcuni	DSC 14	03/88 > 12/96		S 4323 NR	S 8570 A	
dryer filter / filtro essiccatore	DSC 14	03/88 > 12/96		S 8501 NR	S 8570 A	
inner / interno	DSC 14	03/88 > 12/96			S 7288 A	
power steering / servosterzo	DSC 14	03/88 > 12/96				S 3081 PO
turbocompressor / turbocompressore	DSC 14	03/88 > 12/96	S 2329 R			
R 143 M 420						
with outer air intake at the top / con presa aria in alto, esterno	DSC 14	03/88 > 12/96		S 4323 NR	S 8570 A	
dryer filter / filtro essiccatore	DSC 14	03/88 > 12/96				S 7259 A
inner / interno	DSC 14	03/88 > 12/96			S 7288 A	
power steering / servosterzo	DSC 14	03/88 > 12/96				S 3081 PO
turbocompressor / turbocompressore	DSC 14	03/88 > 12/96	S 2329 R			
R 143 M 450						
with outer air intake at the top / con presa aria in alto, esterno	DSC 14	03/88 > 12/96		S 4323 NR	S 8570 A	
dryer filter / filtro essiccatore	DSC 14	03/88 > 12/96				S 7259 A
inner / interno	DSC 14	03/88 > 12/96			S 7288 A	
power steering / servosterzo	DSC 14	03/88 > 12/96				S 3081 PO
turbocompressor / turbocompressore	DSC 14	03/88 > 12/96	S 2329 R			
R 143 M 470						
some / alcuni	DSC 14	03/88 > 12/96		S 4323 NR	S 8570 A	
dryer filter / filtro essiccatore	DSC 14	03/88 > 12/96		S 8501 NR	S 8570 A	
inner / interno	DSC 14	03/88 > 12/96			S 7288 A	
power steering / servosterzo	DSC 14	03/88 > 12/96				S 3081 PO
turbocompressor / turbocompressore	DSC 14	03/88 > 12/96	S 2329 R			
R 143 M 500						
with outer air intake at the top / con presa aria in alto, esterno	DSC 14	03/88 > 12/96		S 4323 NR	S 8570 A	
dryer filter / filtro essiccatore	DSC 14	03/88 > 12/96				S 7259 A
inner / interno	DSC 14	03/88 > 12/96			S 7288 A	
power steering / servosterzo	DSC 14	03/88 > 12/96				S 3081 PO
turbocompressor / turbocompressore	DSC 14	03/88 > 12/96	S 2329 R			
T 143 M 400						
some / alcuni	DSC 14	05/88 > 12/96		S 8501 NR		
with outer air intake at the top / con presa aria in alto, esterno	DSC 14	05/88 > 12/96		S 4323 NR	S 8570 A	
with outer air intake at the bottom / con presa aria in basso, esterno	DSC 14	05/88 > 12/96		S 4323 NR	S 7214 A	
dryer filter / filtro essiccatore	DSC 14	05/88 > 12/96				S 7259 A
inner / interno	DSC 14	05/88 > 12/96			S 7288 A	
turbocompressor / turbocompressore	DSC 14	05/88 > 12/96	S 2329 R			
T 143 M 450						
some / alcuni	DSC 14	05/88 > 12/96		S 8501 NR		
with outer air intake at the top / con presa aria in alto, esterno	DSC 14	05/88 > 12/96		S 4323 NR	S 8570 A	



KW HP



...SCANIA - trucks/autocarri

with outer air intake at the bottom / con presa aria in basso, esterno	DSC 14			05/88 > 12/96		S 4323 NR	S 7214 A	
dryer filter / filtro essiccatore	DSC 14			05/88 > 12/96				S 7259 A
inner / interno	DSC 14			05/88 > 12/96			S 7288 A	
turbocompressor / turbocompressore	DSC 14			05/88 > 12/96	S 2329 R			
T 143 M 470								
some / alcuni	DSC 14			05/88 > 12/96		S 8501 NR		
with outer air intake at the top / con presa aria in alto, esterno	DSC 14			05/88 > 12/96		S 4323 NR	S 8570 A	
with outer air intake at the bottom / con presa aria in basso, esterno	DSC 14			05/88 > 12/96		S 4323 NR	S 7214 A	
dryer filter / filtro essiccatore	DSC 14			05/88 > 12/96				S 7259 A
inner / interno	DSC 14			05/88 > 12/96			S 7288 A	
turbocompressor / turbocompressore	DSC 14			05/88 > 12/96	S 2329 R			
144 Serie								
R144 C 460								
dryer filter WABCO / filtro essiccatore WABCO	DSC14.15	338	460	11/95 > 12/01				S 7344 A
assembly DONALDSON / montaggio DONALDSON	DSC14.15	338	460	11/95 > 12/01	S 4402 R	S 0310 NR	S 7358 A	S 3066 C
DONALDSON assembly inner / montaggio DONALDSON interno	DSC14.15	338	460	11/95 > 12/01			S 7A44 A	
DONALDSON assembly flame retardant media / montaggio DONALDSON media filtrante ritardante di fiamma	DSC14.15	338	460	11/95 > 12/01			S 7A26 A	
assembly KNECHT-MAHLE / montaggio KNECHT-MAHLE	DSC14.15	338	460	11/95 > 12/01	S 4402 R	S 0310 NR	S 7615 A	S 3066 C
power steering / servosterzo	DSC14.15	338	460	11/95 > 12/01				S 3081 PO
R144 C 530								
dryer filter WABCO / filtro essiccatore WABCO	DSC14.13	390	530	11/95 > 12/01				S 7344 A
assembly DONALDSON / montaggio DONALDSON	DSC14.13	390	530	11/95 > 12/01	S 4402 R	S 0310 NR	S 7358 A	S 3066 C
DONALDSON assembly inner / montaggio DONALDSON interno	DSC14.13	390	530	11/95 > 12/01			S 7A44 A	
DONALDSON assembly flame retardant media / montaggio DONALDSON media filtrante ritardante di fiamma	DSC14.13	390	530	11/95 > 12/01			S 7A26 A	
assembly KNECHT-MAHLE / montaggio KNECHT-MAHLE	DSC14.13	390	530	11/95 > 12/01	S 4402 R	S 0310 NR	S 7615 A	S 3066 C
power steering / servosterzo	DSC14.13	390	530	11/95 > 12/01				S 3081 PO
R144 G 460								
dryer filter WABCO / filtro essiccatore WABCO	DSC14.15	338	460	11/95 > 12/01				S 7344 A
assembly DONALDSON / montaggio DONALDSON	DSC14.15	338	460	11/95 > 12/01	S 4402 R	S 0310 NR	S 7358 A	S 3066 C
DONALDSON assembly inner / montaggio DONALDSON interno	DSC14.15	338	460	11/95 > 12/01			S 7A44 A	
DONALDSON assembly flame retardant media / montaggio DONALDSON media filtrante ritardante di fiamma	DSC14.15	338	460	11/95 > 12/01			S 7A26 A	
assembly KNECHT-MAHLE / montaggio KNECHT-MAHLE	DSC14.15	338	460	11/95 > 12/01	S 4402 R	S 0310 NR	S 7615 A	S 3066 C
power steering / servosterzo	DSC14.15	338	460	11/95 > 12/01				S 3081 PO
R144 G 530								
dryer filter WABCO / filtro essiccatore WABCO	DSC14.13	390	530	11/95 > 12/01				S 7344 A
assembly DONALDSON / montaggio DONALDSON	DSC14.13	390	530	11/95 > 12/01	S 4402 R	S 0310 NR	S 7358 A	S 3066 C
DONALDSON assembly inner / montaggio DONALDSON interno	DSC14.13	390	530	11/95 > 12/01			S 7A44 A	
DONALDSON assembly flame retardant media / montaggio DONALDSON media filtrante ritardante di fiamma	DSC14.13	390	530	11/95 > 12/01			S 7A26 A	
assembly KNECHT-MAHLE / montaggio KNECHT-MAHLE	DSC14.13	390	530	11/95 > 12/01	S 4402 R	S 0310 NR	S 7615 A	S 3066 C
power steering / servosterzo	DSC14.13	390	530	11/95 > 12/01				S 3081 PO
R144 L 460								
dryer filter WABCO / filtro essiccatore WABCO	DSC14.15	338	460	11/95 > 12/01				S 7344 A
assembly DONALDSON / montaggio DONALDSON	DSC14.15	338	460	11/95 > 12/01	S 4402 R	S 0310 NR	S 7358 A	S 3066 C
DONALDSON assembly inner / montaggio DONALDSON interno	DSC14.15	338	460	11/95 > 12/01			S 7A44 A	
DONALDSON assembly flame retardant media / montaggio DONALDSON media filtrante ritardante di fiamma	DSC14.15	338	460	11/95 > 12/01			S 7A26 A	
assembly KNECHT-MAHLE / montaggio KNECHT-MAHLE	DSC14.15	338	460	11/95 > 12/01	S 4402 R	S 0310 NR	S 7615 A	S 3066 C
power steering / servosterzo	DSC14.15	338	460	11/95 > 12/01				S 3081 PO
R144 L 530								
dryer filter WABCO / filtro essiccatore WABCO	DSC14.13	390	530	11/95 > 12/01				S 7344 A
assembly DONALDSON / montaggio DONALDSON	DSC14.13	390	530	11/95 > 12/01	S 4402 R	S 0310 NR	S 7358 A	S 3066 C
DONALDSON assembly inner / montaggio DONALDSON interno	DSC14.13	390	530	11/95 > 12/01			S 7A44 A	
DONALDSON assembly flame retardant media / montaggio DONALDSON media filtrante ritardante di fiamma	DSC14.13	390	530	11/95 > 12/01			S 7A26 A	
assembly KNECHT-MAHLE / montaggio KNECHT-MAHLE	DSC14.13	390	530	11/95 > 12/01	S 4402 R	S 0310 NR	S 7615 A	S 3066 C
power steering / servosterzo	DSC14.13	390	530	11/95 > 12/01				S 3081 PO
T144 C 460								
dryer filter WABCO / filtro essiccatore WABCO	DSC14.15	338	460	11/95 > 12/01				S 7344 A
assembly DONALDSON / montaggio DONALDSON	DSC14.15	338	460	11/95 > 12/01	S 4402 R	S 0310 NR	S 7358 A	S 3066 C
DONALDSON assembly inner / montaggio DONALDSON interno	DSC14.15	338	460	11/95 > 12/01			S 7A44 A	
DONALDSON assembly flame retardant media / montaggio DONALDSON media filtrante ritardante di fiamma	DSC14.15	338	460	11/95 > 12/01			S 7A26 A	
assembly KNECHT-MAHLE / montaggio KNECHT-MAHLE	DSC14.15	338	460	11/95 > 12/01	S 4402 R	S 0310 NR	S 7615 A	S 3066 C
power steering / servosterzo	DSC14.15	338	460	11/95 > 12/01				S 3081 PO
T144 C 530								
dryer filter WABCO / filtro essiccatore WABCO	DSC14.13	390	530	11/95 > 12/01				S 7344 A
assembly DONALDSON / montaggio DONALDSON	DSC14.13	390	530	11/95 > 12/01	S 4402 R	S 0310 NR	S 7358 A	S 3066 C
DONALDSON assembly inner / montaggio DONALDSON interno	DSC14.13	390	530	11/95 > 12/01			S 7A44 A	
DONALDSON assembly flame retardant media / montaggio DONALDSON media filtrante ritardante di fiamma	DSC14.13	390	530	11/95 > 12/01			S 7A26 A	
assembly KNECHT-MAHLE / montaggio KNECHT-MAHLE	DSC14.13	390	530	11/95 > 12/01	S 4402 R	S 0310 NR	S 7615 A	S 3066 C





kW HP



...SCANIA - trucks/autocarri

S

power steering / servosterzo	DSC14.13	390	530	11/95 >	12/01				S 3081 PO
T144 G 460									
dryer filter WABCO / filtro essiccatore WABCO	DSC14.15	338	460	11/95 >	12/01				S 7344 A
assembly DONALDSON / montaggio DONALDSON	DSC14.15	338	460	11/95 >	12/01	S 4402 R	S 0310 NR	S 7358 A	S 3066 C
DONALDSON assembly inner / montaggio DONALDSON interno	DSC14.15	338	460	11/95 >	12/01			S 7A44 A	
DONALDSON assembly flame retardant media / montaggio DONALDSON media filtrante ritardante di fiamma	DSC14.15	338	460	11/95 >	12/01			S 7A26 A	
assembly KNECHT-MAHLE / montaggio KNECHT-MAHLE	DSC14.15	338	460	11/95 >	12/01	S 4402 R	S 0310 NR	S 7615 A	S 3066 C
power steering / servosterzo	DSC14.15	338	460	11/95 >	12/01				S 3081 PO
T144 G 530									
dryer filter WABCO / filtro essiccatore WABCO	DSC14.13	390	530	11/95 >	12/01				S 7344 A
assembly DONALDSON / montaggio DONALDSON	DSC14.13	390	530	11/95 >	12/01	S 4402 R	S 0310 NR	S 7358 A	S 3066 C
DONALDSON assembly inner / montaggio DONALDSON interno	DSC14.13	390	530	11/95 >	12/01			S 7A44 A	
DONALDSON assembly flame retardant media / montaggio DONALDSON media filtrante ritardante di fiamma	DSC14.13	390	530	11/95 >	12/01			S 7A26 A	
assembly KNECHT-MAHLE / montaggio KNECHT-MAHLE	DSC14.13	390	530	11/95 >	12/01	S 4402 R	S 0310 NR	S 7615 A	S 3066 C
power steering / servosterzo	DSC14.13	390	530	11/95 >	12/01				S 3081 PO
T144 L 460									
dryer filter WABCO / filtro essiccatore WABCO	DSC14.15	338	460	11/95 >	12/01				S 7344 A
assembly DONALDSON / montaggio DONALDSON	DSC14.15	338	460	11/95 >	12/01	S 4402 R	S 0310 NR	S 7358 A	S 3066 C
DONALDSON assembly inner / montaggio DONALDSON interno	DSC14.15	338	460	11/95 >	12/01			S 7A44 A	
DONALDSON assembly flame retardant media / montaggio DONALDSON media filtrante ritardante di fiamma	DSC14.15	338	460	11/95 >	12/01			S 7A26 A	
assembly KNECHT-MAHLE / montaggio KNECHT-MAHLE	DSC14.15	338	460	11/95 >	12/01	S 4402 R	S 0310 NR	S 7615 A	S 3066 C
power steering / servosterzo	DSC14.15	338	460	11/95 >	12/01				S 3081 PO
T144 L 530									
dryer filter WABCO / filtro essiccatore WABCO	DSC14.13	390	530	11/95 >	12/01				S 7344 A
assembly DONALDSON / montaggio DONALDSON	DSC14.13	390	530	11/95 >	12/01	S 4402 R	S 0310 NR	S 7358 A	S 3066 C
DONALDSON assembly inner / montaggio DONALDSON interno	DSC14.13	390	530	11/95 >	12/01			S 7A44 A	
DONALDSON assembly flame retardant media / montaggio DONALDSON media filtrante ritardante di fiamma	DSC14.13	390	530	11/95 >	12/01			S 7A26 A	
assembly KNECHT-MAHLE / montaggio KNECHT-MAHLE	DSC14.13	390	530	11/95 >	12/01	S 4402 R	S 0310 NR	S 7615 A	S 3066 C
power steering / servosterzo	DSC14.13	390	530	11/95 >	12/01				S 3081 PO
145 Serie									
LT 145	D 14			01/75 >	01/77			S 4323 NR	S 0050 A
power steering / servosterzo	D 14			01/75 >	01/77				S 3081 PO
LT 145	DS 14			01/75 >	01/77			S 4323 NR	S 0050 A
some / alcuni	DS 14			01/75 >	01/77			S 8501 NR	S 0050 A
power steering / servosterzo	DS 14			01/75 >	01/77				S 3081 PO
turbocompressor / turbocompressore	DS 14			01/75 >	01/77	S 2329 R			
LT 145 S	D 14			01/75 >	01/77			S 4323 NR	S 0050 A
power steering / servosterzo	D 14			01/75 >	01/77				S 3081 PO
146 Serie									
L 146	DS 14			02/77 >	04/80			S 4323 NR	S 0050 A
some / alcuni	DS 14			02/77 >	04/80			S 8501 NR	S 0050 A
power steering / servosterzo	DS 14			02/77 >	04/80				S 3081 PO
turbocompressor / turbocompressore	DS 14			02/77 >	04/80	S 2329 R			
LT 146	DS 14			02/77 >	04/80			S 4323 NR	S 0050 A
some / alcuni	DS 14			02/77 >	04/80			S 8501 NR	S 0050 A
power steering / servosterzo	DS 14			02/77 >	04/80				S 3081 PO
turbocompressor / turbocompressore	DS 14			02/77 >	04/80	S 2329 R			
164 Serie									
R164 GB 480									
assembly DONALDSON / montaggio DONALDSON	DC16.02	353	480	06/00 >	10/04	S 5044 PE	S 6008 NE	S 7358 A	S 3066 C
DONALDSON assembly inner / montaggio DONALDSON interno	DC16.02	353	480	06/00 >	10/04			S 7A44 A	
DONALDSON assembly flame retardant media / montaggio DONALDSON media filtrante ritardante di fiamma	DC16.02	353	480	06/00 >	10/04			S 7A26 A	
assembly KNECHT-MAHLE / montaggio KNECHT-MAHLE	DC16.02	353	480	06/00 >	10/04	S 5044 PE	S 6008 NE	S 7615 A	S 3066 C
prefilter / prefiltrato	DC16.02	353	480	06/00 >	10/04				S 3452 C
power steering / servosterzo	DC16.02	353	480	06/00 >	10/04				S 3081 PO
R164 GB 580									
assembly DONALDSON / montaggio DONALDSON	DC16.01	426	580	06/00 >	10/04	S 5044 PE	S 6008 NE	S 7358 A	S 3066 C
DONALDSON assembly inner / montaggio DONALDSON interno	DC16.01	426	580	06/00 >	10/04			S 7A44 A	
DONALDSON assembly flame retardant media / montaggio DONALDSON media filtrante ritardante di fiamma	DC16.01	426	580	06/00 >	10/04			S 7A26 A	
assembly KNECHT-MAHLE / montaggio KNECHT-MAHLE	DC16.01	426	580	06/00 >	10/04	S 5044 PE	S 6008 NE	S 7615 A	S 3066 C
prefilter / prefiltrato	DC16.01	426	580	06/00 >	10/04				S 3452 C
power steering / servosterzo	DC16.01	426	580	06/00 >	10/04				S 3081 PO
R164 LA 480									
assembly DONALDSON / montaggio DONALDSON	DC16.02	353	480	06/00 >	10/04	S 5044 PE	S 6008 NE	S 7358 A	S 3066 C
DONALDSON assembly inner / montaggio DONALDSON interno	DC16.02	353	480	06/00 >	10/04			S 7A44 A	
DONALDSON assembly flame retardant media / montaggio DONALDSON media filtrante ritardante di fiamma	DC16.02	353	480	06/00 >	10/04			S 7A26 A	
assembly KNECHT-MAHLE / montaggio KNECHT-MAHLE	DC16.02	353	480	06/00 >	10/04	S 5044 PE	S 6008 NE	S 7615 A	S 3066 C



kW HP



...SCANIA - trucks/autocarri

prefilter / prefiltrato	DC16.02	353	480	06/00 >	10/04				S 3452 C
power steering / servosterzo	DC16.02	353	480	06/00 >	10/04				S 3081 PO
R164 LA 580									
assembly DONALDSON / montaggio DONALDSON	DC16.01	426	580	06/00 >	10/04	S 5044 PE	S 6008 NE	S 7358 A	S 3066 C
DONALDSON assembly inner / montaggio DONALDSON interno	DC16.01	426	580	06/00 >	10/04			S 7A44 A	
DONALDSON assembly flame retardant media / montaggio DONALDSON media filtrante ritardante di fiamma	DC16.01	426	580	06/00 >	10/04			S 7A26 A	
assembly KNECHT-MAHLE / montaggio KNECHT-MAHLE	DC16.01	426	580	06/00 >	10/04	S 5044 PE	S 6008 NE	S 7615 A	S 3066 C
prefilter / prefiltrato	DC16.01	426	580	06/00 >	10/04				S 3452 C
power steering / servosterzo	DC16.01	426	580	06/00 >	10/04				S 3081 PO
R164 LB 480									
assembly DONALDSON / montaggio DONALDSON	DC16.02	353	480	06/00 >	10/04	S 5044 PE	S 6008 NE	S 7358 A	S 3066 C
DONALDSON assembly inner / montaggio DONALDSON interno	DC16.02	353	480	06/00 >	10/04			S 7A44 A	
DONALDSON assembly flame retardant media / montaggio DONALDSON media filtrante ritardante di fiamma	DC16.02	353	480	06/00 >	10/04			S 7A26 A	
assembly KNECHT-MAHLE / montaggio KNECHT-MAHLE	DC16.02	353	480	06/00 >	10/04	S 5044 PE	S 6008 NE	S 7615 A	S 3066 C
prefilter / prefiltrato	DC16.02	353	480	06/00 >	10/04				S 3452 C
power steering / servosterzo	DC16.02	353	480	06/00 >	10/04				S 3081 PO
R164 LB 580									
assembly DONALDSON / montaggio DONALDSON	DC16.01	426	580	06/00 >	10/04	S 5044 PE	S 6008 NE	S 7358 A	S 3066 C
DONALDSON assembly inner / montaggio DONALDSON interno	DC16.01	426	580	06/00 >	10/04			S 7A44 A	
DONALDSON assembly flame retardant media / montaggio DONALDSON media filtrante ritardante di fiamma	DC16.01	426	580	06/00 >	10/04			S 7A26 A	
assembly KNECHT-MAHLE / montaggio KNECHT-MAHLE	DC16.01	426	580	06/00 >	10/04	S 5044 PE	S 6008 NE	S 7615 A	S 3066 C
prefilter / prefiltrato	DC16.01	426	580	06/00 >	10/04				S 3452 C
power steering / servosterzo	DC16.01	426	580	06/00 >	10/04				S 3081 PO
75 Serie									
L 75				01/58 >	12/80			S 0201 N	
2nd passage / 2.passaggio				01/58 >	12/80			S 1411 N	
LT 75 Super				01/58 >	12/80			S 0201 N	
2nd passage / 2.passaggio				01/58 >	12/80			S 1411 N	
80 Serie									
L 80		D 8		02/68 >	04/75			S 0201 N	
2nd passage / 2.passaggio		D 8		02/68 >	04/75			S 1411 N	
spin-on / avvitabile		D 8		02/68 >	04/75			S 4323 NR	
assembly DELPHI / montaggio DELPHI		D 8		02/68 >	04/75			S 7111 NC	
L 80		DS 8		02/68 >	04/75			S 4323 NR	
1st passage / 1.passaggio		DS 8		02/68 >	04/75			S 0201 N	
2nd passage / 2.passaggio		DS 8		02/68 >	04/75			S 1411 N	
turbocompressor / turbocompressore		DS 8		02/68 >	04/75	S 2329 R			
LB 80		D 8		02/68 >	04/75			S 0201 N	
2nd passage / 2.passaggio		D 8		02/68 >	04/75			S 1411 N	
spin-on / avvitabile		D 8		02/68 >	04/75			S 4323 NR	
assembly DELPHI / montaggio DELPHI		D 8		02/68 >	04/75			S 7111 NC	
LB 80		DS 8		02/68 >	04/75			S 4323 NR	
1st passage / 1.passaggio		DS 8		02/68 >	04/75			S 0201 N	
2nd passage / 2.passaggio		DS 8		02/68 >	04/75			S 1411 N	
turbocompressor / turbocompressore		DS 8		02/68 >	04/75	S 2329 R			
81 Serie									
L 81		D 8		05/75 >	12/80			S 0201 N	
2nd passage / 2.passaggio		D 8		05/75 >	12/80			S 1411 N	
some / alcuni		D 8		05/75 >	12/80			S 4323 NR	
power steering / servosterzo		D 8		05/75 >	12/80				S 3081 PO
L 81		DS 8		05/75 >	12/80			S 4323 NR	
power steering / servosterzo		DS 8		05/75 >	12/80				S 3081 PO
turbocompressor / turbocompressore		DS 8		05/75 >	12/80	S 2329 R			
LB 81		D 8		05/75 >	12/80			S 0201 N	
2nd passage / 2.passaggio		D 8		05/75 >	12/80			S 1411 N	
some / alcuni		D 8		05/75 >	12/80			S 4323 NR	
power steering / servosterzo		D 8		05/75 >	12/80				S 3081 PO
LB 81		DS 8		05/75 >	12/80			S 4323 NR	
power steering / servosterzo		DS 8		05/75 >	12/80				S 3081 PO
turbocompressor / turbocompressore		DS 8		05/75 >	12/80	S 2329 R			
82 Serie									
G 82 M		DN 8		05/80 >	03/88			S 4323 NR	S 7186 A
some / alcuni		DN 8		05/80 >	03/88			S 8501 NR	S 7186 A
dryer filter / filtro essiccatore		DN 8		01/85 >	03/88				S 7259 A
power steering / servosterzo		DN 8		05/80 >	03/88				S 3081 PO
G 82 M		DS 8		05/80 >	03/88			S 4323 NR	S 7186 A
some / alcuni		DS 8		05/80 >	03/88			S 8501 NR	S 7186 A

S





KW HP



...SCANIA - trucks/autocarri

S



dryer filter / filtro essiccatore	DS 8	01/85 > 03/88				S 7259 A
power steering / servosterzo	DS 8	05/80 > 03/88				S 3081 PO
turbocompressor / turbocompressore	DS 8	05/80 > 03/88	S 2329 R			
G 82 MD	DS 8	05/80 > 03/88		S 4323 NR	S 7186 A	
some / alcuni	DS 8	05/80 > 03/88		S 8501 NR	S 7186 A	
dryer filter / filtro essiccatore	DS 8	01/85 > 03/88				S 7259 A
power steering / servosterzo	DS 8	05/80 > 03/88				S 3081 PO
turbocompressor / turbocompressore	DS 8	05/80 > 03/88	S 2329 R			
P 82	DSI 8	05/80 > 03/88		S 4323 NR	S 0050 A	
some / alcuni	DSI 8	05/80 > 03/88		S 8501 NR	S 0050 A	
dryer filter / filtro essiccatore	DSI 8	01/85 > 03/88				S 7259 A
power steering / servosterzo	DSI 8	05/80 > 03/88				S 3081 PO
turbocompressor / turbocompressore	DSI 8	05/80 > 03/88	S 2329 R			
P 82 H	DS 8	05/80 > 03/88		S 4323 NR	S 7186 A	
some / alcuni	DS 8	05/80 > 03/88		S 8501 NR	S 7186 A	
dryer filter / filtro essiccatore	DS 8	01/85 > 03/88				S 7259 A
power steering / servosterzo	DS 8	05/80 > 03/88				S 3081 PO
turbocompressor / turbocompressore	DS 8	05/80 > 03/88	S 2329 R			
T 82	DS 9, DSC 9	05/80 > 03/88		S 4323 NR	S 0050 A	
dryer filter / filtro essiccatore	DS 9, DSC 9	01/85 > 03/88				S 7259 A
power steering / servosterzo	DS 9, DSC 9	05/80 > 03/88				S 3081 PO
turbocompressor / turbocompressore	DS 9, DSC 9	05/80 > 03/88	S 2329 R			
T 82	DSI 8	05/80 > 03/88		S 4323 NR	S 0050 A	
some / alcuni	DSI 8	05/80 > 03/88		S 8501 NR	S 0050 A	
dryer filter / filtro essiccatore	DSI 8	01/85 > 03/88				S 7259 A
power steering / servosterzo	DSI 8	05/80 > 03/88				S 3081 PO
turbocompressor / turbocompressore	DSI 8	05/80 > 03/88	S 2329 R			
T 82 H	DS 11	05/80 > 03/88		S 4323 NR	S 0050 A	
some / alcuni	DS 11	05/80 > 03/88		S 8501 NR	S 7186 A	
dryer filter / filtro essiccatore	DS 11	01/85 > 03/88				S 7259 A
power steering / servosterzo	DS 11	05/80 > 03/88				S 3081 PO
turbocompressor / turbocompressore	DS 11	05/80 > 03/88	S 2329 R			
T 82 H	DS 8	05/80 > 03/88		S 4323 NR	S 7186 A	
some / alcuni	DS 8	05/80 > 03/88		S 8501 NR	S 7186 A	
dryer filter / filtro essiccatore	DS 8	01/85 > 03/88				S 7259 A
power steering / servosterzo	DS 8	05/80 > 03/88				S 3081 PO
turbocompressor / turbocompressore	DS 8	05/80 > 03/88	S 2329 R			
T 82 M	DN 8	05/80 > 03/88		S 4323 NR	S 7186 A	
some / alcuni	DN 8	05/80 > 03/88		S 8501 NR	S 7186 A	
dryer filter / filtro essiccatore	DN 8	01/85 > 03/88				S 7259 A
power steering / servosterzo	DN 8	05/80 > 03/88				S 3081 PO
T 82 M	DS 8	05/80 > 03/88		S 4323 NR	S 7186 A	
some / alcuni	DS 8	05/80 > 03/88		S 8501 NR	S 7186 A	
dryer filter / filtro essiccatore	DS 8	01/85 > 03/88				S 7259 A
power steering / servosterzo	DS 8	05/80 > 03/88				S 3081 PO
turbocompressor / turbocompressore	DS 8	05/80 > 03/88	S 2329 R			
85 Serie						
L 85	D 8	02/68 > 04/75		S 0201 N		
2nd passage / 2.passaggio	D 8	02/68 > 04/75		S 1411 N		
L 85	DS 8	02/68 > 04/75		S 0201 N		
2nd passage / 2.passaggio	DS 8	02/68 > 04/75		S 1411 N		
LB 85	D 8	02/68 > 04/75		S 0201 N		
2nd passage / 2.passaggio	D 8	02/68 > 04/75		S 1411 N		
LB 85	DS 8	02/68 > 04/75		S 0201 N		
2nd passage / 2.passaggio	DS 8	02/68 > 04/75		S 1411 N		
LS 85	D 8	02/68 > 04/75		S 0201 N		
2nd passage / 2.passaggio	D 8	02/68 > 04/75		S 1411 N		
LS 85	DS 8	02/68 > 04/75		S 0201 N		
2nd passage / 2.passaggio	DS 8	02/68 > 04/75		S 1411 N		
86 Serie						
L 86	D 8	05/75 > 12/80		S 0201 N		
2nd passage / 2.passaggio	D 8	05/75 > 12/80		S 1411 N		
spin-on / avvvitabile	D 8	05/75 > 12/80		S 4323 NR		
power steering / servosterzo	D 8	05/75 > 12/80				S 3081 PO
L 86	DS 8	05/75 > 12/80		S 4323 NR		
1st passage / 1.passaggio	DS 8	05/75 > 12/80		S 0201 N		
2nd passage / 2.passaggio	DS 8	05/75 > 12/80		S 1411 N		



kW HP



...SCANIA - trucks/autocarri

power steering / servosterzo	DS 8	05/75 > 12/80				S 3081 PO
turbocompressor / turbocompressore	DS 8	05/75 > 12/80	S 2329 R			
LB 86	D 8	05/75 > 12/80		S 0201 N		
2nd passage / 2.passaggio	D 8	05/75 > 12/80		S 1411 N		
spin-on / avvitabile	D 8	05/75 > 12/80		S 4323 NR		
power steering / servosterzo	D 8	05/75 > 12/80				S 3081 PO
LB 86	DS 8	05/75 > 12/80		S 4323 NR		
1st passage / 1.passaggio	DS 8	05/75 > 12/80		S 0201 N		
2nd passage / 2.passaggio	DS 8	05/75 > 12/80		S 1411 N		
power steering / servosterzo	DS 8	05/75 > 12/80				S 3081 PO
turbocompressor / turbocompressore	DS 8	05/75 > 12/80	S 2329 R			
LBS 86	D 8	05/75 > 12/80		S 0201 N		
2nd passage / 2.passaggio	D 8	05/75 > 12/80		S 1411 N		
spin-on / avvitabile	D 8	05/75 > 12/80		S 4323 NR		
power steering / servosterzo	D 8	05/75 > 12/80				S 3081 PO
LBS 86	DS 8	05/75 > 12/80		S 4323 NR		
1st passage / 1.passaggio	DS 8	05/75 > 12/80		S 0201 N		
2nd passage / 2.passaggio	DS 8	05/75 > 12/80		S 1411 N		
power steering / servosterzo	DS 8	05/75 > 12/80				S 3081 PO
turbocompressor / turbocompressore	DS 8	05/75 > 12/80	S 2329 R			
LS 86	D 8	05/75 > 12/80		S 0201 N		
2nd passage / 2.passaggio	D 8	05/75 > 12/80		S 1411 N		
spin-on / avvitabile	D 8	05/75 > 12/80		S 4323 NR		
power steering / servosterzo	D 8	05/75 > 12/80				S 3081 PO
LS 86	DS 8	05/75 > 12/80		S 4323 NR		
1st passage / 1.passaggio	DS 8	05/75 > 12/80		S 0201 N		
2nd passage / 2.passaggio	DS 8	05/75 > 12/80		S 1411 N		
power steering / servosterzo	DS 8	05/75 > 12/80				S 3081 PO
turbocompressor / turbocompressore	DS 8	05/75 > 12/80	S 2329 R			
92 Serie						
G 92	DN 9	01/85 > 03/88		S 4323 NR	S 7186 A	
some / alcuni	DN 9	01/85 > 03/88		S 8501 NR	S 7186 A	
dryer filter / filtro essiccatore	DN 9	01/85 > 03/88				S 7259 A
power steering / servosterzo	DN 9	01/85 > 03/88				S 3081 PO
G 92						
some / alcuni	DS 9, DSC 9	01/85 > 03/88		S 8501 NR		
with air intake at the top / con presa aria in alto	DS 9, DSC 9	01/85 > 03/88		S 4323 NR	S 0050 A	
with air intake at the bottom / con presa aria in basso	DS 9, DSC 9	01/85 > 03/88		S 4323 NR	S 7186 A	
dryer filter / filtro essiccatore	DS 9, DSC 9	01/85 > 03/88				S 7259 A
power steering / servosterzo	DS 9, DSC 9	01/85 > 03/88				S 3081 PO
turbocompressor / turbocompressore	DS 9, DSC 9	01/85 > 03/88	S 2329 R			
P 92	DN 9	01/85 > 03/88		S 4323 NR	S 7186 A	
some / alcuni	DN 9	01/85 > 03/88		S 8501 NR	S 7186 A	
dryer filter / filtro essiccatore	DN 9	01/85 > 03/88				S 7259 A
power steering / servosterzo	DN 9	01/85 > 03/88				S 3081 PO
P 92 M						
some / alcuni	DS 9, DSC 9	01/85 > 03/88		S 8501 NR		
with air intake at the top / con presa aria in alto	DS 9, DSC 9	01/85 > 03/88		S 4323 NR	S 0050 A	
with air intake at the bottom / con presa aria in basso	DS 9, DSC 9	01/85 > 03/88		S 4323 NR	S 7186 A	
dryer filter / filtro essiccatore	DS 9, DSC 9	01/85 > 03/88				S 7259 A
power steering / servosterzo	DS 9, DSC 9	01/85 > 03/88				S 3081 PO
turbocompressor / turbocompressore	DS 9, DSC 9	01/85 > 03/88	S 2329 R			
R 92	DN 9	01/85 > 03/88		S 4323 NR	S 7186 A	
some / alcuni	DN 9	01/85 > 03/88		S 8501 NR	S 7186 A	
dryer filter / filtro essiccatore	DN 9	01/85 > 03/88				S 7259 A
power steering / servosterzo	DN 9	01/85 > 03/88				S 3081 PO
R 92						
some / alcuni	DS 9, DSC 9	01/85 > 03/88		S 8501 NR		
with air intake at the top / con presa aria in alto	DS 9, DSC 9	01/85 > 03/88		S 4323 NR	S 0050 A	
with air intake at the bottom / con presa aria in basso	DS 9, DSC 9	01/85 > 03/88		S 4323 NR	S 7186 A	
dryer filter / filtro essiccatore	DS 9, DSC 9	01/85 > 03/88				S 7259 A
power steering / servosterzo	DS 9, DSC 9	01/85 > 03/88				S 3081 PO
turbocompressor / turbocompressore	DS 9, DSC 9	01/85 > 03/88	S 2329 R			
T 92	DN 9	01/85 > 03/88		S 4323 NR	S 7186 A	
some / alcuni	DN 9	01/85 > 03/88		S 8501 NR	S 7186 A	
dryer filter / filtro essiccatore	DN 9	01/85 > 03/88				S 7259 A
power steering / servosterzo	DN 9	01/85 > 03/88				S 3081 PO

S





kW HP



...SCANIA - trucks/autocarri

S

T 92									
some / alcuni	DS 9, DSC 9			01/85 > 03/88		S 8501 NR			
with air intake at the top / con presa aria in alto	DS 9, DSC 9			01/85 > 03/88		S 4323 NR	S 0050 A		
with air intake at the bottom / con presa aria in basso	DS 9, DSC 9			01/85 > 03/88		S 4323 NR	S 7186 A		
dryer filter / filtro essiccatore	DS 9, DSC 9			01/85 > 03/88					S 7259 A
power steering / servosterzo	DS 9, DSC 9			01/85 > 03/88					S 3081 PO
turbocompressor / turbocompressore	DS 9, DSC 9			01/85 > 03/88	S 2329 R				
93 Serie									
F 93									
some / alcuni	DN 9, DS 9			06/90 > 01/98		S 8501 NR			
with outer air intake at the top / con presa aria in alto, esterno	DN 9, DS 9			06/90 > 01/98		S 4323 NR	S 8570 A		
with outer air intake at the bottom / con presa aria in basso, esterno	DN 9, DS 9			06/90 > 01/98		S 4323 NR	S 7214 A		
dryer filter / filtro essiccatore	DN 9, DS 9			06/90 > 01/88					S 7259 A
inner / interno	DN 9, DS 9			06/90 > 01/98			S 7288 A		
power steering / servosterzo	DN 9, DS 9			06/90 > 01/98					S 3081 PO
turbocompressor / turbocompressore	DN 9, DS 9			06/90 > 01/98	S 2329 R				
G 93									
some / alcuni	DS 9, DSC 9			03/88 > 08/97		S 8501 NR			
with outer air intake at the top / con presa aria in alto, esterno	DS 9, DSC 9			03/88 > 08/97		S 4323 NR	S 8570 A		
with outer air intake at the bottom / con presa aria in basso, esterno	DS 9, DSC 9			03/88 > 08/97		S 4323 NR	S 7214 A		
dryer filter / filtro essiccatore	DS 9, DSC 9			03/88 > 08/97					S 7259 A
inner / interno	DS 9, DSC 9			03/88 > 08/97			S 7288 A		
power steering / servosterzo	DS 9, DSC 9			03/88 > 08/97					S 3081 PO
turbocompressor / turbocompressore	DS 9, DSC 9			03/88 > 08/97	S 2329 R				
P 93									
some / alcuni	DS 9, DSC 9			03/88 > 08/97		S 8501 NR			
with outer air intake at the top / con presa aria in alto, esterno	DS 9, DSC 9			03/88 > 08/97		S 4323 NR	S 8570 A		
with outer air intake at the bottom / con presa aria in basso, esterno	DS 9, DSC 9			03/88 > 08/97		S 4323 NR	S 7214 A		
dryer filter / filtro essiccatore	DS 9, DSC 9			03/88 > 08/97					S 7259 A
inner / interno	DS 9, DSC 9			03/88 > 08/97			S 7288 A		
power steering / servosterzo	DS 9, DSC 9			03/88 > 08/97					S 3081 PO
turbocompressor / turbocompressore	DS 9, DSC 9			03/88 > 08/97	S 2329 R				
R 93									
some / alcuni	DS 9, DSC 9			03/88 > 08/97		S 8501 NR			
with outer air intake at the top / con presa aria in alto, esterno	DS 9, DSC 9			03/88 > 08/97		S 4323 NR	S 8570 A		
with outer air intake at the bottom / con presa aria in basso, esterno	DS 9, DSC 9			03/88 > 08/97		S 4323 NR	S 7214 A		
dryer filter / filtro essiccatore	DS 9, DSC 9			03/88 > 08/97					S 7259 A
inner / interno	DS 9, DSC 9			03/88 > 08/97			S 7288 A		
power steering / servosterzo	DS 9, DSC 9			03/88 > 08/97					S 3081 PO
turbocompressor / turbocompressore	DS 9, DSC 9			03/88 > 08/97	S 2329 R				
T 93									
some / alcuni	DS 9, DSC 9			03/88 > 08/97		S 4323 NR	S 7214 A		
dryer filter / filtro essiccatore	DS 9, DSC 9			03/88 > 08/97		S 8501 NR	S 7214 A		S 7259 A
power steering / servosterzo	DS 9, DSC 9			03/88 > 08/97					S 3081 PO
turbocompressor / turbocompressore	DS 9, DSC 9			03/88 > 08/97	S 2329 R				
94 Serie									
P94 C 260									
dryer filter WABCO / filtro essiccatore WABCO	DSC9.12 Euro2	191	260	10/95 > 10/04	S 4402 R	S 0310 NR			S 3066 C
retarder / freno di rallentamento	DSC9.12 Euro2	191	260	10/95 > 10/04					S 7344 A
export models Russia / modelli di esportazione Russia	DSC9.12 Euro2	191	260	10/95 > 10/04			S 7642 A		S 5613 PO
assembly DONALDSON / montaggio DONALDSON	DSC9.12 Euro2	191	260	10/95 > 10/04			S 7286 A		
DONALDSON assembly flame retardant media / montaggio DONALDSON media filtrante ritardante di fiamma	DSC9.12 Euro2	191	260	10/95 > 10/04			S 7A25 A		
assembly KNECHT-MAHLE / montaggio KNECHT-MAHLE	DSC9.12 Euro2	191	260	10/95 > 10/04			S 7970 A		
prefilter Parker-Racor / prefiltra Parker-Racor	DSC9.12 Euro2	191	260	10/95 > 10/04		S 4143 NR			
power steering / servosterzo	DSC9.12 Euro2	191	260	10/95 > 10/04					S 3081 PO
P94 D 220									
dryer filter WABCO / filtro essiccatore WABCO	DSC9.11 Euro2	162	220	10/95 > 10/04	S 4402 R	S 0310 NR			S 3066 C
retarder / freno di rallentamento	DSC9.11 Euro2	162	220	10/95 > 10/04					S 7344 A
export models Russia / modelli di esportazione Russia	DSC9.11 Euro2	162	220	10/95 > 10/04			S 7642 A		S 5613 PO
assembly DONALDSON / montaggio DONALDSON	DSC9.11 Euro2	162	220	10/95 > 10/04			S 7286 A		
DONALDSON assembly flame retardant media / montaggio DONALDSON media filtrante ritardante di fiamma	DSC9.11 Euro2	162	220	10/95 > 10/04			S 7A25 A		
assembly KNECHT-MAHLE / montaggio KNECHT-MAHLE	DSC9.11 Euro2	162	220	10/95 > 10/04			S 7970 A		
power steering / servosterzo	DSC9.11 Euro2	162	220	10/95 > 10/04					S 3081 PO
P94 D 230									
dryer filter WABCO / filtro essiccatore WABCO	DC9.01 Euro3	169	230	03/99 > 10/04	S 4402 R	S 4341 NR			S 3066 C
retarder / freno di rallentamento	DC9.01 Euro3	169	230	03/99 > 10/04					S 7344 A
export models Russia / modelli di esportazione Russia	DC9.01 Euro3	169	230	03/99 > 10/04			S 7642 A		S 5613 PO

**KW HP****...SCANIA - trucks/autocarri****S**

DONALDSON assembly flame retardant media / montaggio DONALDSON media filtrante ritardante di fiamma	DSC9.12 Euro2	191 260	10/95 >	10/04			S 7A25 A	
assembly KNECHT-MAHLE / montaggio KNECHT-MAHLE	DSC9.12 Euro2	191 260	10/95 >	10/04			S 7970 A	
power steering / servosterzo	DSC9.12 Euro2	191 260	10/95 >	10/04				S 3081 PO
R94 C 310	DSC9.13 Euro2, DSC9.15 Euro2	228 310	10/95 >	10/04	S 4402 R	S 0310 NR		S 3066 C
dryer filter WABCO / filtro essiccatore WABCO	DSC9.13 Euro2, DSC9.15 Euro2	228 310	10/95 >	10/04				S 7344 A
export models Russia / modelli di esportazione Russia	DSC9.13 Euro2, DSC9.15 Euro2	228 310	10/95 >	10/04			S 7642 A	
assembly DONALDSON / montaggio DONALDSON	DSC9.13 Euro2, DSC9.15 Euro2	228 310	10/95 >	10/04			S 7286 A	
DONALDSON assembly flame retardant media / montaggio DONALDSON media filtrante ritardante di fiamma	DSC9.13 Euro2, DSC9.15 Euro2	228 310	10/95 >	10/04			S 7A25 A	
assembly KNECHT-MAHLE / montaggio KNECHT-MAHLE	DSC9.13 Euro2, DSC9.15 Euro2	228 310	10/95 >	10/04			S 7970 A	
power steering / servosterzo	DSC9.13 Euro2, DSC9.15 Euro2	228 310	10/95 >	10/04				S 3081 PO
R94 G 220	DSC9.11 Euro2	162 220	10/95 >	10/04	S 4402 R	S 0310 NR		S 3066 C
dryer filter WABCO / filtro essiccatore WABCO	DSC9.11 Euro2	162 220	10/95 >	10/04				S 7344 A
export models Russia / modelli di esportazione Russia	DSC9.11 Euro2	162 220	10/95 >	10/04			S 7642 A	
assembly DONALDSON / montaggio DONALDSON	DSC9.11 Euro2	162 220	10/95 >	10/04			S 7286 A	
DONALDSON assembly flame retardant media / montaggio DONALDSON media filtrante ritardante di fiamma	DSC9.11 Euro2	162 220	10/95 >	10/04			S 7A25 A	
assembly KNECHT-MAHLE / montaggio KNECHT-MAHLE	DSC9.11 Euro2	162 220	10/95 >	10/04			S 7970 A	
power steering / servosterzo	DSC9.11 Euro2	162 220	10/95 >	10/04				S 3081 PO
R94 G 310	DSC9.13 Euro2, DSC9.15 Euro2	228 310	10/95 >	10/04	S 4402 R	S 0310 NR		S 3066 C
dryer filter WABCO / filtro essiccatore WABCO	DSC9.13 Euro2, DSC9.15 Euro2	228 310	10/95 >	10/04				S 7344 A
export models Russia / modelli di esportazione Russia	DSC9.13 Euro2, DSC9.15 Euro2	228 310	10/95 >	10/04			S 7642 A	
assembly DONALDSON / montaggio DONALDSON	DSC9.13 Euro2, DSC9.15 Euro2	228 310	10/95 >	10/04			S 7286 A	
DONALDSON assembly flame retardant media / montaggio DONALDSON media filtrante ritardante di fiamma	DSC9.13 Euro2, DSC9.15 Euro2	228 310	10/95 >	10/04			S 7A25 A	
assembly KNECHT-MAHLE / montaggio KNECHT-MAHLE	DSC9.13 Euro2, DSC9.15 Euro2	228 310	10/95 >	10/04			S 7970 A	
power steering / servosterzo	DSC9.13 Euro2, DSC9.15 Euro2	228 310	10/95 >	10/04				S 3081 PO
R94 L 310	DSC9.13 Euro2, DSC9.15 Euro2	228 310	10/95 >	10/04	S 4402 R	S 0310 NR		S 3066 C
dryer filter WABCO / filtro essiccatore WABCO	DSC9.13 Euro2, DSC9.15 Euro2	228 310	10/95 >	10/04				S 7344 A
export models Russia / modelli di esportazione Russia	DSC9.13 Euro2, DSC9.15 Euro2	228 310	10/95 >	10/04			S 7642 A	
assembly DONALDSON / montaggio DONALDSON	DSC9.13 Euro2, DSC9.15 Euro2	228 310	10/95 >	10/04			S 7286 A	
DONALDSON assembly flame retardant media / montaggio DONALDSON media filtrante ritardante di fiamma	DSC9.13 Euro2, DSC9.15 Euro2	228 310	10/95 >	10/04			S 7A25 A	
assembly KNECHT-MAHLE / montaggio KNECHT-MAHLE	DSC9.13 Euro2, DSC9.15 Euro2	228 310	10/95 >	10/04			S 7970 A	
power steering / servosterzo	DSC9.13 Euro2, DSC9.15 Euro2	228 310	10/95 >	10/04				S 3081 PO

G Serie

G 230	DC9.16-230 Euro4	169 230	10/07 >		S 4402 R	S 6010 NE		S 3289 C
dryer filter / filtro essiccatore	DC9.16-230 Euro4	169 230	10/07 >					S 7F30 A
retarder / freno di rallentamento	DC9.16-230 Euro4	169 230	10/07 >					S 5613 PO
flame retardant media DONALDSON assembly / media filtrante ritardante di fiamma montaggio DONALDSON	DC9.16-230 Euro4	169 230	10/07 >	12/08			S 7A25 A	
assembly DONALDSON / montaggio DONALDSON	DC9.16-230 Euro4	169 230	10/07 >	12/08			S 7286 A	
assembly DONALDSON / montaggio DONALDSON	DC9.16-230 Euro4	169 230	01/09 >				S 7B36 A	
assembly KNECHT-MAHLE / montaggio KNECHT-MAHLE	DC9.16-230 Euro4	169 230	10/07 >				S 7970 A	
power steering / servosterzo	DC9.16-230 Euro4	169 230	10/07 >					S 3081 PO
Vehicles for building site with filter (1506545, 1506546, 1506547) / veicoli da cantiere con filtro (1506545, 1506546, 1506547)	DC9.16-230 Euro4	169 230	10/07 >				S 7A50 A	
G 250	DC09.111-250 Euro6	184 250	10/13 >		S 5181 PE	S 6147 NE	S 7B36 A	S 3289 C
dryer filter / filtro essiccatore	DC09.111-250 Euro6	184 250	10/13 >					S 7F30 A
filter PARKER-RACOR / filtro PARKER-RACOR	DC09.111-250 Euro6	184 250	10/13 >			S 4479 NR		
inner / interno	DC09.111-250 Euro6	184 250	10/13 >				S 7D41 A	
power steering / servosterzo	DC09.111-250 Euro6	184 250	10/13 >					S 3081 PO
G 270	DC9.17-270 Euro4	198 270	10/07 >		S 4402 R	S 6010 NE		S 3289 C
dryer filter / filtro essiccatore	DC9.17-270 Euro4	198 270	10/07 >					S 7F30 A
retarder / freno di rallentamento	DC9.17-270 Euro4	198 270	10/07 >					S 5613 PO
flame retardant media DONALDSON assembly / media filtrante ritardante di fiamma montaggio DONALDSON	DC9.17-270 Euro4	198 270	10/07 >	12/08			S 7A25 A	
assembly DONALDSON / montaggio DONALDSON	DC9.17-270 Euro4	198 270	10/07 >	12/08			S 7286 A	
assembly KNECHT-MAHLE / montaggio KNECHT-MAHLE	DC9.17-270 Euro4	198 270	10/07 >				S 7970 A	
power steering / servosterzo	DC9.17-270 Euro4	198 270	10/07 >					S 3081 PO
Vehicles for building site with filter (1506545, 1506546, 1506547) / veicoli da cantiere con filtro (1506545, 1506546, 1506547)	DC9.17-270 Euro4	198 270	10/07 >				S 7A50 A	
G 280	DC09.113-280 Euro6	206 280	10/13 >		S 5181 PE	S 6147 NE	S 7B36 A	S 3289 C
dryer filter / filtro essiccatore	DC09.113-280 Euro6	206 280	10/13 >					S 7F30 A
filter PARKER-RACOR / filtro PARKER-RACOR	DC09.113-280 Euro6	206 280	10/13 >			S 4479 NR		
inner / interno	DC09.113-280 Euro6	206 280	10/13 >				S 7D41 A	
power steering / servosterzo	DC09.113-280 Euro6	206 280	10/13 >					S 3081 PO
G 310	DC9.18-310 Euro4	228 310	10/07 >		S 4402 R	S 6010 NE		S 3289 C
dryer filter / filtro essiccatore	DC9.18-310 Euro4	228 310	10/07 >					S 7F30 A
retarder / freno di rallentamento	DC9.18-310 Euro4	228 310	10/07 >					S 5613 PO
flame retardant media DONALDSON assembly / media filtrante ritardante di fiamma montaggio DONALDSON	DC9.18-310 Euro4	228 310	10/07 >	12/08			S 7A25 A	
flame retardant media DONALDSON assembly / media filtrante ritardante di fiamma montaggio DONALDSON	DC9.18-310 Euro4	228 310	01/09 >				S 7B36 A	
assembly DONALDSON / montaggio DONALDSON	DC9.18-310 Euro4	228 310	10/07 >	12/08			S 7286 A	
assembly KNECHT-MAHLE / montaggio KNECHT-MAHLE	DC9.18-310 Euro4	228 310	10/07 >				S 7970 A	
power steering / servosterzo	DC9.18-310 Euro4	228 310	10/07 >					S 3081 PO



...SCANIA - trucks/autocarri

Vehicles for building site with filter (1506545, 1506546, 1506547) / veicoli da cantiere con filtro (1506545, 1506546, 1506547)	DC9.18-310 Euro4	228	310	10/07	>			S 7A50 A	
G 320	DC09.108-320 Euro6	235	320	10/13	>	S 5181 PE			S 3289 C
dryer filter / filtro essiccatore	DC09.108-320 Euro6	235	320	10/13	>				S 7F30 A
filter PARKER-RACOR / filtro PARKER-RACOR	DC09.108-320 Euro6	235	320	10/13	>		S 4479 NR		
power steering / servosterzo	DC09.108-320 Euro6	235	320	10/13	>				S 3081 PO
G 340	DC12.10-340 Euro4	250	340	10/07	>	S 4402 R	S 6010 NE		S 3289 C
dryer filter / filtro essiccatore	DC12.10-340 Euro4	250	340	10/07	>				S 7F30 A
retarder / freno di rallentamento	DC12.10-340 Euro4	250	340	10/07	>				S 5613 PO
flame retardant media DONALDSON assembly / media filtrante ritardante di fiamma montaggio DONALDSON	DC12.10-340 Euro4	250	340	10/07	>			S 7A25 A	
flame retardant media DONALDSON assembly / media filtrante ritardante di fiamma montaggio DONALDSON	DC12.10-340 Euro4	250	340	01/09	>			S 7B36 A	
assembly DONALDSON / montaggio DONALDSON	DC12.10-340 Euro4	250	340	10/07	>			S 7286 A	
assembly KNECHT-MAHLE / montaggio KNECHT-MAHLE	DC12.10-340 Euro4	250	340	10/07	>			S 7970 A	
power steering / servosterzo	DC12.10-340 Euro4	250	340	10/07	>				S 3081 PO
Vehicles for building site with filter (1506545, 1506546, 1506547) / veicoli da cantiere con filtro (1506545, 1506546, 1506547)	DC12.10-340 Euro4	250	340	10/07	>			S 7A50 A	
G 360	DC09.112-360 Euro6	265	360	10/13	>	S 5181 PE			S 3289 C
dryer filter / filtro essiccatore	DC09.112-360 Euro6	265	360	10/13	>				S 7F30 A
filter PARKER-RACOR / filtro PARKER-RACOR	DC09.112-360 Euro6	265	360	10/13	>		S 4479 NR		
power steering / servosterzo	DC09.112-360 Euro6	265	360	10/13	>				S 3081 PO
G 370	DC13.116-370 Euro6	272	370	10/13	>	S 5181 PE			S 3289 C
dryer filter / filtro essiccatore	DC13.116-370 Euro6	272	370	10/13	>				S 7F30 A
filter PARKER-RACOR / filtro PARKER-RACOR	DC13.116-370 Euro6	272	370	10/13	>		S 4479 NR		
power steering / servosterzo	DC13.116-370 Euro6	272	370	10/13	>				S 3081 PO
G 380	DC12.13-380 Euro4	280	380	10/07	>	S 4402 R	S 6010 NE		S 3289 C
dryer filter / filtro essiccatore	DC12.13-380 Euro4	280	380	10/07	>				S 7F30 A
retarder / freno di rallentamento	DC12.13-380 Euro4	280	380	10/07	>				S 5613 PO
flame retardant media DONALDSON assembly / media filtrante ritardante di fiamma montaggio DONALDSON	DC12.13-380 Euro4	280	380	10/07	>			S 7A25 A	
flame retardant media DONALDSON assembly / media filtrante ritardante di fiamma montaggio DONALDSON	DC12.13-380 Euro4	280	380	01/09	>			S 7B36 A	
assembly DONALDSON / montaggio DONALDSON	DC12.13-380 Euro4	280	380	10/07	>			S 7286 A	
assembly KNECHT-MAHLE / montaggio KNECHT-MAHLE	DC12.13-380 Euro4	280	380	10/07	>			S 7970 A	
power steering / servosterzo	DC12.13-380 Euro4	280	380	10/07	>				S 3081 PO
Vehicles for building site with filter (1506545, 1506546, 1506547) / veicoli da cantiere con filtro (1506545, 1506546, 1506547)	DC12.13-380 Euro4	280	380	10/07	>			S 7A50 A	
G 380	DC12.18-380 Euro5	280	380	10/07	>	S 4402 R	S 6010 NE		S 3289 C
with filter Urea/Adblue / con filtro Urea/Adblue	DC12.18-380 Euro5	280	380	10/07	>				S 4401 U
dryer filter / filtro essiccatore	DC12.18-380 Euro5	280	380	10/07	>				S 7F30 A
retarder / freno di rallentamento	DC12.18-380 Euro5	280	380	10/07	>				S 5613 PO
flame retardant media DONALDSON assembly / media filtrante ritardante di fiamma montaggio DONALDSON	DC12.18-380 Euro5	280	380	10/07	>			S 7A25 A	
flame retardant media DONALDSON assembly / media filtrante ritardante di fiamma montaggio DONALDSON	DC12.18-380 Euro5	280	380	01/09	>			S 7B36 A	
assembly DONALDSON / montaggio DONALDSON	DC12.18-380 Euro5	280	380	10/07	>			S 7286 A	
assembly KNECHT-MAHLE / montaggio KNECHT-MAHLE	DC12.18-380 Euro5	280	380	10/07	>			S 7970 A	
power steering / servosterzo	DC12.18-380 Euro5	280	380	10/07	>				S 3081 PO
Vehicles for building site with filter (1506545, 1506546, 1506547) / veicoli da cantiere con filtro (1506545, 1506546, 1506547)	DC12.18-380 Euro5	280	380	10/07	>			S 7A50 A	
G 410	DC13.115-410 Euro6	302	410	10/13	>	S 5181 PE			S 3289 C
dryer filter / filtro essiccatore	DC13.115-410 Euro6	302	410	10/13	>				S 7F30 A
filter PARKER-RACOR / filtro PARKER-RACOR	DC13.115-410 Euro6	302	410	10/13	>		S 4479 NR		
power steering / servosterzo	DC13.115-410 Euro6	302	410	10/13	>				S 3081 PO
G 420	DC12.15-420 Euro5	309	420	10/07	>	S 4402 R	S 6010 NE		S 3289 C
with filter Urea/Adblue / con filtro Urea/Adblue	DC12.15-420 Euro5	309	420	10/07	>				S 4401 U
dryer filter / filtro essiccatore	DC12.15-420 Euro5	309	420	10/07	>				S 7F30 A
retarder / freno di rallentamento	DC12.15-420 Euro5	309	420	10/07	>				S 5613 PO
flame retardant media DONALDSON assembly / media filtrante ritardante di fiamma montaggio DONALDSON	DC12.15-420 Euro5	309	420	10/07	>			S 7A25 A	
flame retardant media DONALDSON assembly / media filtrante ritardante di fiamma montaggio DONALDSON	DC12.15-420 Euro5	309	420	01/09	>			S 7B36 A	
assembly DONALDSON / montaggio DONALDSON	DC12.15-420 Euro5	309	420	10/07	>			S 7286 A	
assembly KNECHT-MAHLE / montaggio KNECHT-MAHLE	DC12.15-420 Euro5	309	420	10/07	>			S 7970 A	
power steering / servosterzo	DC12.15-420 Euro5	309	420	10/07	>				S 3081 PO
Vehicles for building site with filter (1506545, 1506546, 1506547) / veicoli da cantiere con filtro (1506545, 1506546, 1506547)	DC12.15-420 Euro5	309	420	10/07	>			S 7A50 A	
G 420	DT12.12-420 Euro4	309	420	10/07	>	S 4402 R	S 6010 NE		S 3289 C
dryer filter / filtro essiccatore	DT12.12-420 Euro4	309	420	10/07	>				S 7F30 A
retarder / freno di rallentamento	DT12.12-420 Euro4	309	420	10/07	>				S 5613 PO
flame retardant media DONALDSON assembly / media filtrante ritardante di fiamma montaggio DONALDSON	DT12.12-420 Euro4	309	420	10/07	>			S 7A25 A	
flame retardant media DONALDSON assembly / media filtrante ritardante di fiamma montaggio DONALDSON	DT12.12-420 Euro4	309	420	01/09	>			S 7B36 A	
assembly DONALDSON / montaggio DONALDSON	DT12.12-420 Euro4	309	420	10/07	>			S 7286 A	
assembly KNECHT-MAHLE / montaggio KNECHT-MAHLE	DT12.12-420 Euro4	309	420	10/07	>			S 7970 A	
power steering / servosterzo	DT12.12-420 Euro4	309	420	10/07	>				S 3081 PO
Vehicles for building site with filter (1506545, 1506546, 1506547) / veicoli da cantiere con filtro (1506545, 1506546, 1506547)	DT12.12-420 Euro4	309	420	10/07	>			S 7A50 A	
G 440	DC13.10-440 Euro5	324	440	04/10	>	S 5181 PE			S 7F30 A
dryer filter / filtro essiccatore	DC13.10-440 Euro5	324	440	04/10	>				S 5613 PO
retarder / freno di rallentamento	DC13.10-440 Euro5	324	440	04/10	>				

S



...SCANIA - trucks/autocarri

S

power steering / servosterzo	DC13.10-440 Euro5	324	440	04/10	>				S 3081 PO
Vehicles for building site with filter (1506545, 1506546, 1506547) / veicoli da cantiere con filtro (1506545, 1506546, 1506547)	DC13.10-440 Euro5	324	440	04/10	>			S 7A50 A	
G 440	DC13.109-440 Euro6	324	440	10/13	>	S 5181 PE			S 3289 C
dryer filter / filtro essiccatore	DC13.109-440 Euro6	324	440	10/13	>				S 7F30 A
retarder / freno di rallentamento	DC13.109-440 Euro6	324	440	10/13	>				S 5613 PO
power steering / servosterzo	DC13.109-440 Euro6	324	440	10/13	>				S 3081 PO
G 450	DC13.124-450 Euro6	331	450	10/13	>	S 5181 PE			S 3289 C
dryer filter / filtro essiccatore	DC13.124-450 Euro6	331	450	10/13	>				S 7F30 A
filter PARKER-RACOR / filtro PARKER-RACOR	DC13.124-450 Euro6	331	450	10/13	>		S 4479 NR		
power steering / servosterzo	DC13.124-450 Euro6	331	450	10/13	>				S 3081 PO
G 470	DT12.06-470 Euro3	345	470	10/07	>	S 4402 R	S 6010 NE		S 3289 C
dryer filter / filtro essiccatore	DT12.06-470 Euro3	345	470	10/07	>				S 7F30 A
retarder / freno di rallentamento	DT12.06-470 Euro3	345	470	10/07	>				S 5613 PO
flame retardant media DONALDSON assembly / media filtrante ritardante di fiamma montaggio DONALDSON	DT12.06-470 Euro3	345	470	10/07	> 12/08			S 7A25 A	
flame retardant media DONALDSON assembly / media filtrante ritardante di fiamma montaggio DONALDSON	DT12.06-470 Euro3	345	470	01/09	>			S 7B36 A	
assembly DONALDSON / montaggio DONALDSON	DT12.06-470 Euro3	345	470	10/07	> 12/08			S 7286 A	
assembly KNECHT-MAHLE / montaggio KNECHT-MAHLE	DT12.06-470 Euro3	345	470	10/07	>			S 7970 A	
power steering / servosterzo	DT12.06-470 Euro3	345	470	10/07	>				S 3081 PO
Vehicles for building site with filter (1506545, 1506546, 1506547) / veicoli da cantiere con filtro (1506545, 1506546, 1506547)	DT12.06-470 Euro3	345	470	10/07	>			S 7A50 A	
G 480	DC13.07-490 Euro5	353	480	10/07	>	S 5181 PE	S 6147 NE		S 3289 C
dryer filter / filtro essiccatore	DC13.07-490 Euro5	353	480	10/07	>				S 7F30 A
filter PARKER-RACOR / filtro PARKER-RACOR	DC13.07-490 Euro5	353	480	10/07	>		S 4479 NR		
retarder / freno di rallentamento	DC13.07-490 Euro5	353	480	10/07	>				S 5613 PO
flame retardant media DONALDSON assembly / media filtrante ritardante di fiamma montaggio DONALDSON	DC13.07-490 Euro5	353	480	10/07	> 12/08			S 7A25 A	
flame retardant media DONALDSON assembly / media filtrante ritardante di fiamma montaggio DONALDSON	DC13.07-490 Euro5	353	480	01/09	>			S 7B36 A	
assembly DONALDSON / montaggio DONALDSON	DC13.07-490 Euro5	353	480	10/07	> 12/08			S 7286 A	
assembly KNECHT-MAHLE / montaggio KNECHT-MAHLE	DC13.07-490 Euro5	353	480	10/07	>			S 7970 A	
power steering / servosterzo	DC13.07-490 Euro5	353	480	10/07	>				S 3081 PO
Vehicles for building site with filter (1506545, 1506546, 1506547) / veicoli da cantiere con filtro (1506545, 1506546, 1506547)	DC13.07-490 Euro5	353	480	10/07	>			S 7A50 A	
G 480	DT12.17-480 Euro4	353	480	10/07	>	S 4402 R	S 6010 NE		S 3289 C
dryer filter / filtro essiccatore	DT12.17-480 Euro4	353	480	10/07	>				S 7F30 A
retarder / freno di rallentamento	DT12.17-480 Euro4	353	480	10/07	>				S 5613 PO
flame retardant media DONALDSON assembly / media filtrante ritardante di fiamma montaggio DONALDSON	DT12.17-480 Euro4	353	480	10/07	> 12/08			S 7A25 A	
flame retardant media DONALDSON assembly / media filtrante ritardante di fiamma montaggio DONALDSON	DT12.17-480 Euro4	353	480	01/09	>			S 7B36 A	
assembly DONALDSON / montaggio DONALDSON	DT12.17-480 Euro4	353	480	10/07	> 12/08			S 7286 A	
assembly KNECHT-MAHLE / montaggio KNECHT-MAHLE	DT12.17-480 Euro4	353	480	10/07	>			S 7970 A	
power steering / servosterzo	DT12.17-480 Euro4	353	480	10/07	>				S 3081 PO
Vehicles for building site with filter (1506545, 1506546, 1506547) / veicoli da cantiere con filtro (1506545, 1506546, 1506547)	DT12.17-480 Euro4	353	480	10/07	>			S 7A50 A	
G 490	DC13.125-490 Euro6	360	490	10/13	>	S 5181 PE			S 3289 C
dryer filter / filtro essiccatore	DC13.125-490 Euro6	360	490	10/13	>				S 7F30 A
filter PARKER-RACOR / filtro PARKER-RACOR	DC13.125-490 Euro6	360	490	10/13	>		S 4479 NR		
power steering / servosterzo	DC13.125-490 Euro6	360	490	10/13	>				S 3081 PO
L Serie									
L 280	DC09.130	206	280	12/17	>	S 5181 PE	S 6147 NE	S 7F26 A	
dryer filter / filtro essiccatore	DC09.130	206	280	12/17	>				S 7F30 A
retarder / freno di rallentamento	DC09.130	206	280	12/17	>				S 5613 PO
power steering / servosterzo	DC09.130	206	280	12/17	>				S 3081 PO
P Serie									
P 230	DC9.13 Euro3	169	230	09/04	>				S 7F30 A
dryer filter WABCO / filtro essiccatore WABCO	DC9.13 Euro3	169	230	09/04	> 09/05				S 7344 A
assembly DONALDSON / montaggio DONALDSON	DC9.13 Euro3	169	230	09/04	> 09/07	S 4402 R	S 4341 NR	S 7286 A	S 3066 C
assembly DONALDSON / montaggio DONALDSON	DC9.13 Euro3	169	230	10/07	>	S 4402 R	S 4341 NR	S 7286 A	
DONALDSON assembly short version / montaggio DONALDSON versione corta	DC9.13 Euro3	169	230	09/04	>			S 7B36 A	
assembly KNECHT-MAHLE / montaggio KNECHT-MAHLE	DC9.13 Euro3	169	230	09/04	> 09/07	S 4402 R	S 4341 NR	S 7970 A	S 3066 C
assembly KNECHT-MAHLE / montaggio KNECHT-MAHLE	DC9.13 Euro3	169	230	10/07	>	S 4402 R	S 4341 NR	S 7970 A	
power steering / servosterzo	DC9.13 Euro3	169	230	09/04	>				S 3081 PO
Vehicles for building site with filter (1506545, 1506546, 1506547) / veicoli da cantiere con filtro (1506545, 1506546, 1506547)	DC9.13 Euro3	169	230	09/04	>			S 7A50 A	
P 230	DC9.16 Euro4	169	230	10/05	>				S 7F30 A
assembly DONALDSON / montaggio DONALDSON	DC9.16 Euro4	169	230	10/05	> 09/07	S 4402 R	S 6010 NE	S 7286 A	S 3066 C
assembly DONALDSON / montaggio DONALDSON	DC9.16 Euro4	169	230	10/07	>	S 4402 R	S 6010 NE	S 7286 A	
DONALDSON assembly short version / montaggio DONALDSON versione corta	DC9.16 Euro4	169	230	09/04	>			S 7B36 A	
assembly KNECHT-MAHLE / montaggio KNECHT-MAHLE	DC9.16 Euro4	169	230	10/05	> 09/07	S 4402 R	S 6010 NE	S 7970 A	S 3066 C
assembly KNECHT-MAHLE / montaggio KNECHT-MAHLE	DC9.16 Euro4	169	230	10/07	>	S 4402 R	S 6010 NE	S 7970 A	
power steering / servosterzo	DC9.16 Euro4	169	230	10/05	>				S 3081 PO
Vehicles for building site with filter (1506545, 1506546, 1506547) / veicoli da cantiere con filtro (1506545, 1506546, 1506547)	DC9.16 Euro4	169	230	10/05	>			S 7A50 A	

**KW HP****...SCANIA - trucks/autocarri**

P 230	DC9.30/35-230 E5/EEV	169	230	10/07	>	S 5181 PE	S 6147 NE		S 3289 C
dryer filter / filtro essiccatore	DC9.30/35-230 E5/EEV	169	230	10/07	>				S 7F30 A
DONALDSON assembly short version / montaggio DONALDSON versione corta	DC9.30/35-230 E5/EEV	169	230	09/04	>			S 7B36 A	
power steering / servosterzo	DC9.30/35-230 E5/EEV	169	230	10/07	>				S 3081 PO
Vehicles for building site with filter (1506545, 1506546, 1506547) / veicoli da cantiere con filtro (1506545, 1506546, 1506547)	DC9.30/35-230 E5/EEV	169	230	10/07	>			S 7A50 A	
P 250	DC09.111-250 E6	184	250	10/13	>	S 5181 PE	S 6147 NE	S 7B36 A	S 3289 C
dryer filter / filtro essiccatore	DC09.111-250 E6	184	250	10/13	>				S 7F30 A
filter PARKER-RACOR / filtro PARKER-RACOR	DC09.111-250 E6	184	250	10/13	>		S 4479 NR		
power steering / servosterzo	DC09.111-250 E6	184	250	10/13	>				S 3081 PO
P 270	DC9.12 Euro3	198	270	09/04	>				S 7F30 A
dryer filter / filtro essiccatore	DC9.12 Euro3	198	270	09/04	>				S 7344 A
dryer filter WABCO / filtro essiccatore WABCO	DC9.12 Euro3	198	270	09/04	>	09/05			
assembly DONALDSON / montaggio DONALDSON	DC9.12 Euro3	198	270	09/04	>	09/07	S 4402 R	S 4341 NR	S 7286 A
assembly DONALDSON / montaggio DONALDSON	DC9.12 Euro3	198	270	10/07	>		S 4402 R	S 4341 NR	S 7286 A
DONALDSON assembly short version / montaggio DONALDSON versione corta	DC9.12 Euro3	198	270	09/04	>				S 7B36 A
assembly KNECHT-MAHLE / montaggio KNECHT-MAHLE	DC9.12 Euro3	198	270	09/04	>	09/07	S 4402 R	S 4341 NR	S 7970 A
assembly KNECHT-MAHLE / montaggio KNECHT-MAHLE	DC9.12 Euro3	198	270	10/07	>		S 4402 R	S 4341 NR	S 7970 A
power steering / servosterzo	DC9.12 Euro3	198	270	09/04	>				S 3081 PO
Vehicles for building site with filter (1506545, 1506546, 1506547) / veicoli da cantiere con filtro (1506545, 1506546, 1506547)	DC9.12 Euro3	198	270	09/04	>			S 7A50 A	
P 270	DC9.17 Euro4	198	270	10/05	>				S 7F30 A
dryer filter / filtro essiccatore	DC9.17 Euro4	198	270	10/05	>	09/07	S 4402 R	S 6010 NE	S 7286 A
assembly DONALDSON / montaggio DONALDSON	DC9.17 Euro4	198	270	10/07	>		S 4402 R	S 6010 NE	S 7286 A
assembly DONALDSON / montaggio DONALDSON	DC9.17 Euro4	198	270	09/04	>				S 7B36 A
DONALDSON assembly short version / montaggio DONALDSON versione corta	DC9.17 Euro4	198	270	10/05	>	09/07	S 4402 R	S 6010 NE	S 7970 A
assembly KNECHT-MAHLE / montaggio KNECHT-MAHLE	DC9.17 Euro4	198	270	10/07	>		S 4402 R	S 6010 NE	S 7970 A
assembly KNECHT-MAHLE / montaggio KNECHT-MAHLE	DC9.17 Euro4	198	270	10/05	>				S 3081 PO
power steering / servosterzo	DC9.17 Euro4	198	270	10/05	>				S 3081 PO
Vehicles for building site with filter (1506545, 1506546, 1506547) / veicoli da cantiere con filtro (1506545, 1506546, 1506547)	DC9.17 Euro4	198	270	10/05	>			S 7A50 A	
P 280	DC09.113-280 E6	206	280	10/13	>	S 5181 PE	S 6147 NE	S 7B36 A	S 3289 C
dryer filter / filtro essiccatore	DC09.113-280 E6	206	280	10/13	>				S 7F30 A
filter PARKER-RACOR / filtro PARKER-RACOR	DC09.113-280 E6	206	280	10/13	>		S 4479 NR		
power steering / servosterzo	DC09.113-280 E6	206	280	10/13	>				S 3081 PO
P 280	DC9.29/36-280 E5/EEV	206	280	10/07	>	S 5181 PE	S 6147 NE		S 3289 C
dryer filter / filtro essiccatore	DC9.29/36-280 E5/EEV	206	280	10/07	>				S 7F30 A
DONALDSON assembly short version / montaggio DONALDSON versione corta	DC9.29/36-280 E5/EEV	206	280	09/04	>			S 7B36 A	
power steering / servosterzo	DC9.29/36-280 E5/EEV	206	280	10/07	>				S 3081 PO
Vehicles for building site with filter (1506545, 1506546, 1506547) / veicoli da cantiere con filtro (1506545, 1506546, 1506547)	DC9.29/36-280 E5/EEV	206	280	10/07	>			S 7A50 A	
P 310	DC9.11 Euro3	228	310	09/04	>				S 7F30 A
dryer filter / filtro essiccatore	DC9.11 Euro3	228	310	09/04	>	09/05			S 7344 A
dryer filter WABCO / filtro essiccatore WABCO	DC9.11 Euro3	228	310	09/04	>	09/07	S 4402 R	S 4341 NR	S 7286 A
assembly DONALDSON / montaggio DONALDSON	DC9.11 Euro3	228	310	10/07	>		S 4402 R	S 4341 NR	S 7286 A
assembly DONALDSON / montaggio DONALDSON	DC9.11 Euro3	228	310	09/04	>				S 7B36 A
DONALDSON assembly short version / montaggio DONALDSON versione corta	DC9.11 Euro3	228	310	09/04	>	09/07	S 4402 R	S 4341 NR	S 7970 A
assembly KNECHT-MAHLE / montaggio KNECHT-MAHLE	DC9.11 Euro3	228	310	10/07	>		S 4402 R	S 4341 NR	S 7970 A
assembly KNECHT-MAHLE / montaggio KNECHT-MAHLE	DC9.11 Euro3	228	310	09/04	>				S 3081 PO
power steering / servosterzo	DC9.11 Euro3	228	310	09/04	>				S 3081 PO
Vehicles for building site with filter (1506545, 1506546, 1506547) / veicoli da cantiere con filtro (1506545, 1506546, 1506547)	DC9.11 Euro3	228	310	09/04	>			S 7A50 A	
P 310	DC9.18/110-310 Euro4/5	228	310	11/05	>				S 7F30 A
dryer filter / filtro essiccatore	DC9.18/110-310 Euro4/5	228	310	11/05	>	09/07	S 4402 R	S 6010 NE	S 7286 A
assembly DONALDSON / montaggio DONALDSON	DC9.18/110-310 Euro4/5	228	310	10/07	>		S 4402 R	S 6010 NE	S 7286 A
assembly DONALDSON / montaggio DONALDSON	DC9.18/110-310 Euro4/5	228	310	09/04	>				S 7B36 A
DONALDSON assembly short version / montaggio DONALDSON versione corta	DC9.18/110-310 Euro4/5	228	310	11/05	>	09/07	S 4402 R	S 6010 NE	S 7970 A
assembly KNECHT-MAHLE / montaggio KNECHT-MAHLE	DC9.18/110-310 Euro4/5	228	310	10/07	>		S 4402 R	S 6010 NE	S 7970 A
assembly KNECHT-MAHLE / montaggio KNECHT-MAHLE	DC9.18/110-310 Euro4/5	228	310	11/05	>				S 3081 PO
power steering / servosterzo	DC9.18/110-310 Euro4/5	228	310	11/05	>				S 3081 PO
Vehicles for building site with filter (1506545, 1506546, 1506547) / veicoli da cantiere con filtro (1506545, 1506546, 1506547)	DC9.18/110-310 Euro4/5	228	310	11/05	>			S 7A50 A	
P 320	DC09.37/108-320 E6	235	320	10/13	>	S 5181 PE	S 6147 NE	S 7B36 A	S 3289 C
dryer filter / filtro essiccatore	DC09.37/108-320 E6	235	320	10/13	>				S 7F30 A
filter PARKER-RACOR / filtro PARKER-RACOR	DC09.37/108-320 E6	235	320	10/13	>		S 4479 NR		
power steering / servosterzo	DC09.37/108-320 E6	235	320	10/13	>				S 3081 PO
P 320	DC9.28-320 Euro5	235	320	10/07	>	S 5181 PE	S 6147 NE		S 3289 C
dryer filter / filtro essiccatore	DC9.28-320 Euro5	235	320	10/17	>				S 7F30 A
DONALDSON assembly short version / montaggio DONALDSON versione corta	DC9.28-320 Euro5	235	320	09/04	>			S 7B36 A	
power steering / servosterzo	DC9.28-320 Euro5	235	320	10/07	>				S 3081 PO
Vehicles for building site with filter (1506545, 1506546, 1506547) / veicoli da cantiere con filtro (1506545, 1506546, 1506547)	DC9.28-320 Euro5	235	320	10/07	>			S 7A50 A	
P 340	DC11.08 Euro3	250	340	09/04	>				S 7F30 A
dryer filter / filtro essiccatore	DC11.08 Euro3	250	340	09/04	>				S 7F30 A





...SCANIA - trucks/autocarri

S

dryer filter WABCO / filtro essiccatore WABCO	DC11.08 Euro3	250 340	09/04 > 09/05				S 7344 A
assembly DONALDSON / montaggio DONALDSON	DC11.08 Euro3	250 340	09/04 > 09/07	S 4402 R	S 4341 NR	S 7286 A	S 3066 C
assembly DONALDSON / montaggio DONALDSON	DC11.08 Euro3	250 340	10/07 >	S 4402 R	S 4341 NR	S 7286 A	
DONALDSON assembly short version / montaggio DONALDSON versione corta	DC11.08 Euro3	250 340	09/04 >			S 7B36 A	
assembly KNECHT-MAHLE / montaggio KNECHT-MAHLE	DC11.08 Euro3	250 340	09/04 > 09/07	S 4402 R	S 4341 NR	S 7970 A	S 3066 C
assembly KNECHT-MAHLE / montaggio KNECHT-MAHLE	DC11.08 Euro3	250 340	10/07 >	S 4402 R	S 4341 NR	S 7970 A	
power steering / servosterzo	DC11.08 Euro3	250 340	09/04 >				S 3081 PO
Vehicles for building site with filter (1506545, 1506546, 1506547) / veicoli da cantiere con filtro (1506545, 1506546, 1506547)	DC11.08 Euro3	250 340	09/04 >			S 7A50 A	
P 340							
dryer filter / filtro essiccatore	DC12.10 Euro4	250 340	05/06 >				S 7F30 A
assembly DONALDSON / montaggio DONALDSON	DC12.10 Euro4	250 340	05/06 > 09/07	S 4402 R	S 6010 NE	S 7286 A	S 3066 C
assembly DONALDSON / montaggio DONALDSON	DC12.10 Euro4	250 340	10/07 >	S 4402 R	S 6010 NE	S 7286 A	
DONALDSON assembly short version / montaggio DONALDSON versione corta	DC12.10 Euro4	250 340	09/04 >			S 7B36 A	
assembly KNECHT-MAHLE / montaggio KNECHT-MAHLE	DC12.10 Euro4	250 340	05/06 > 09/07	S 4402 R	S 6010 NE	S 7970 A	S 3066 C
assembly KNECHT-MAHLE / montaggio KNECHT-MAHLE	DC12.10 Euro4	250 340	10/07 >	S 4402 R	S 6010 NE	S 7970 A	
power steering / servosterzo	DC12.10 Euro4	250 340	05/06 >				S 3081 PO
Vehicles for building site with filter (1506545, 1506546, 1506547) / veicoli da cantiere con filtro (1506545, 1506546, 1506547)	DC12.10 Euro4	250 340	05/06 >			S 7A50 A	
P 360							
dryer filter / filtro essiccatore	DC09.112-360 E6	265 360	10/13 >	S 5181 PE	S 6147 NE	S 7B36 A	S 3289 C
filter PARKER-RACOR / filtro PARKER-RACOR	DC09.112-360 E6	265 360	10/13 >		S 4479 NR		S 7F30 A
power steering / servosterzo	DC09.112-360 E6	265 360	10/13 >				S 3081 PO
P 360							
dryer filter / filtro essiccatore	DC13.06-360 Euro5	265 360	10/07 >	S 5181 PE	S 6147 NE		S 3289 C
DONALDSON assembly short version / montaggio DONALDSON versione corta	DC13.06-360 Euro5	265 360	09/04 >			S 7B36 A	
power steering / servosterzo	DC13.06-360 Euro5	265 360	10/07 >				S 3081 PO
Vehicles for building site with filter (1506545, 1506546, 1506547) / veicoli da cantiere con filtro (1506545, 1506546, 1506547)	DC13.06-360 Euro5	265 360	10/07 >			S 7A50 A	
P 370							
dryer filter / filtro essiccatore	DC13.116-370 E6	272 370	10/13 >	S 5181 PE	S 6147 NE	S 7B36 A	S 3289 C
filter PARKER-RACOR / filtro PARKER-RACOR	DC13.116-370 E6	272 370	10/13 >		S 4479 NR		S 7F30 A
power steering / servosterzo	DC13.116-370 E6	272 370	10/13 >				S 3081 PO
P 380							
dryer filter / filtro essiccatore	DC11.09 Euro3	279 380	09/04 >				S 7F30 A
dryer filter WABCO / filtro essiccatore WABCO	DC11.09 Euro3	279 380	09/04 > 09/05				S 7344 A
assembly DONALDSON / montaggio DONALDSON	DC11.09 Euro3	279 380	09/04 > 09/07	S 4402 R	S 4341 NR	S 7286 A	S 3066 C
assembly DONALDSON / montaggio DONALDSON	DC11.09 Euro3	279 380	10/07 >	S 4402 R	S 4341 NR	S 7286 A	
DONALDSON assembly short version / montaggio DONALDSON versione corta	DC11.09 Euro3	279 380	09/04 >			S 7B36 A	
assembly KNECHT-MAHLE / montaggio KNECHT-MAHLE	DC11.09 Euro3	279 380	09/04 > 09/07	S 4402 R	S 4341 NR	S 7970 A	S 3066 C
assembly KNECHT-MAHLE / montaggio KNECHT-MAHLE	DC11.09 Euro3	279 380	10/07 >	S 4402 R	S 4341 NR	S 7970 A	
power steering / servosterzo	DC11.09 Euro3	279 380	09/04 >				S 3081 PO
Vehicles for building site with filter (1506545, 1506546, 1506547) / veicoli da cantiere con filtro (1506545, 1506546, 1506547)	DC11.09 Euro3	279 380	09/04 >			S 7A50 A	
P 380							
dryer filter / filtro essiccatore	DC12.13 Euro4	280 380	10/05 >				S 7F30 A
assembly DONALDSON / montaggio DONALDSON	DC12.13 Euro4	280 380	10/05 > 09/07	S 4402 R	S 6010 NE	S 7286 A	S 3066 C
assembly DONALDSON / montaggio DONALDSON	DC12.13 Euro4	280 380	10/07 >	S 4402 R	S 6010 NE	S 7286 A	
DONALDSON assembly short version / montaggio DONALDSON versione corta	DC12.13 Euro4	280 380	09/04 >			S 7B36 A	
assembly KNECHT-MAHLE / montaggio KNECHT-MAHLE	DC12.13 Euro4	280 380	10/05 > 09/07	S 4402 R	S 6010 NE	S 7970 A	S 3066 C
assembly KNECHT-MAHLE / montaggio KNECHT-MAHLE	DC12.13 Euro4	280 380	10/07 >	S 4402 R	S 6010 NE	S 7970 A	
power steering / servosterzo	DC12.13 Euro4	280 380	10/05 >				S 3081 PO
Vehicles for building site with filter (1506545, 1506546, 1506547) / veicoli da cantiere con filtro (1506545, 1506546, 1506547)	DC12.13 Euro4	280 380	10/05 >			S 7A50 A	
P 380							
with filter Urea/Adblue / con filtro Urea/Adblue	DC12.18-380 Euro5	280 381	10/07 >				S 4401 U
dryer filter / filtro essiccatore	DC12.18-380 Euro5	280 381	10/07 >				S 7F30 A
assembly DONALDSON / montaggio DONALDSON	DC12.18-380 Euro5	280 381	10/07 >	S 4402 R	S 6010 NE	S 7286 A	S 3289 C
DONALDSON assembly short version / montaggio DONALDSON versione corta	DC12.18-380 Euro5	280 381	09/04 >			S 7B36 A	
assembly KNECHT-MAHLE / montaggio KNECHT-MAHLE	DC12.18-380 Euro5	280 381	10/07 >	S 4402 R	S 6010 NE	S 7970 A	S 3289 C
power steering / servosterzo	DC12.18-380 Euro5	280 381	10/07 >				S 3081 PO
Vehicles for building site with filter (1506545, 1506546, 1506547) / veicoli da cantiere con filtro (1506545, 1506546, 1506547)	DC12.18-380 Euro5	280 381	10/07 >			S 7A50 A	
P 400							
dryer filter / filtro essiccatore	DC13.05-400 Euro5	294 400	10/07 >	S 5181 PE	S 6147 NE		S 3289 C
DONALDSON assembly short version / montaggio DONALDSON versione corta	DC13.05-400 Euro5	294 400	09/04 >			S 7B36 A	
power steering / servosterzo	DC13.05-400 Euro5	294 400	10/07 >				S 3081 PO
Vehicles for building site with filter (1506545, 1506546, 1506547) / veicoli da cantiere con filtro (1506545, 1506546, 1506547)	DC13.05-400 Euro5	294 400	10/07 >			S 7A50 A	
P 410							
dryer filter / filtro essiccatore	DC13.115-410 E6	302 410	10/13 >	S 5181 PE	S 6147 NE	S 7B36 A	S 3289 C
filter PARKER-RACOR / filtro PARKER-RACOR	DC13.115-410 E6	302 410	10/13 >		S 4479 NR		S 7F30 A
power steering / servosterzo	DC13.115-410 E6	302 410	10/13 >				S 3081 PO
P 420							



...SCANIA - trucks/autocarri

dryer filter / filtro essiccatore	DC12.14 Euro 3	309	420	09/04	>				S 7F30 A
dryer filter WABCO / filtro essiccatore WABCO	DC12.14 Euro 3	309	420	09/04	> 09/05				S 7344 A
assembly DONALDSON / montaggio DONALDSON	DC12.14 Euro 3	309	420	09/04	> 09/07	S 4402 R	S 4341 NR	S 7286 A	S 3066 C
assembly DONALDSON / montaggio DONALDSON	DC12.14 Euro 3	309	420	10/07	>	S 4402 R	S 4341 NR	S 7286 A	
DONALDSON assembly short version / montaggio DONALDSON versione corta	DC12.14 Euro 3	309	420	09/04	>			S 7B36 A	
assembly KNECHT-MAHLE / montaggio KNECHT-MAHLE	DC12.14 Euro 3	309	420	09/04	> 09/07	S 4402 R	S 4341 NR	S 7970 A	S 3066 C
assembly KNECHT-MAHLE / montaggio KNECHT-MAHLE	DC12.14 Euro 3	309	420	10/07	>	S 4402 R	S 4341 NR	S 7970 A	
power steering / servosterzo	DC12.14 Euro 3	309	420	09/04	>				S 3081 PO
Vehicles for building site with filter (1506545, 1506546, 1506547) / veicoli da cantiere con filtro (1506545, 1506546, 1506547)	DC12.14 Euro 3	309	420	09/04	>			S 7A50 A	
P 420									
with filter Urea/Adblue / con filtro Urea/Adblue	DC12.15 Euro5	309	420	05/06	>				S 4401 U
dryer filter / filtro essiccatore	DC12.15 Euro5	309	420	05/06	>				S 7F30 A
assembly DONALDSON / montaggio DONALDSON	DC12.15 Euro5	309	420	05/06	> 09/07	S 4402 R	S 6010 NE	S 7286 A	S 3066 C
assembly DONALDSON / montaggio DONALDSON	DC12.15 Euro5	309	420	10/07	>	S 4402 R	S 6010 NE	S 7286 A	S 3289 C
DONALDSON assembly short version / montaggio DONALDSON versione corta	DC12.15 Euro5	309	420	09/04	>			S 7B36 A	
assembly KNECHT-MAHLE / montaggio KNECHT-MAHLE	DC12.15 Euro5	309	420	05/06	> 09/07	S 4402 R	S 6010 NE	S 7970 A	S 3066 C
assembly KNECHT-MAHLE / montaggio KNECHT-MAHLE	DC12.15 Euro5	309	420	10/07	>	S 4402 R	S 6010 NE	S 7970 A	S 3289 C
power steering / servosterzo	DC12.15 Euro5	309	420	05/06	>				S 3081 PO
Vehicles for building site with filter (1506545, 1506546, 1506547) / veicoli da cantiere con filtro (1506545, 1506546, 1506547)	DC12.15 Euro5	309	420	05/06	>			S 7A50 A	
P 420									
dryer filter / filtro essiccatore	DT12.12 Euro4	309	420	09/04	> 09/06				S 7F30 A
dryer filter WABCO / filtro essiccatore WABCO	DT12.12 Euro4	309	420	09/04	> 09/06				S 7344 A
assembly DONALDSON / montaggio DONALDSON	DT12.12 Euro4	309	420	09/04	> 09/06	S 4402 R	S 6010 NE	S 7286 A	S 3066 C
DONALDSON assembly short version / montaggio DONALDSON versione corta	DT12.12 Euro4	309	420	09/04	>			S 7B36 A	
assembly KNECHT-MAHLE / montaggio KNECHT-MAHLE	DT12.12 Euro4	309	420	09/04	> 09/06	S 4402 R	S 6010 NE	S 7970 A	S 3066 C
power steering / servosterzo	DT12.12 Euro4	309	420	09/04	> 09/06				S 3081 PO
Vehicles for building site with filter (1506545, 1506546, 1506547) / veicoli da cantiere con filtro (1506545, 1506546, 1506547)	DT12.12 Euro4	309	420	09/04	> 09/06			S 7A50 A	
P 450									
dryer filter / filtro essiccatore	DC13.124-450 E6	331	450	10/13	>	S 5181 PE	S 6147 NE	S 7B36 A	S 3289 C
dryer filter / filtro essiccatore	DC13.124-450 E6	331	450	10/13	>				S 7F30 A
filter PARKER-RACOR / filtro PARKER-RACOR	DC13.124-450 E6	331	450	10/13	>		S 4479 NR		
power steering / servosterzo	DC13.124-450 E6	331	450	10/13	>				S 3081 PO
P 470									
dryer filter / filtro essiccatore	DT12.06-470 Euro3	346	470	09/04	> 09/07				S 7F30 A
dryer filter WABCO / filtro essiccatore WABCO	DT12.06-470 Euro3	346	470	09/04	> 09/05				S 7344 A
assembly DONALDSON / montaggio DONALDSON	DT12.06-470 Euro3	346	470	09/04	> 09/07	S 4402 R	S 6010 NE	S 7286 A	S 3066 C
DONALDSON assembly short version / montaggio DONALDSON versione corta	DT12.06-470 Euro3	346	470	09/04	>			S 7B36 A	
assembly KNECHT-MAHLE / montaggio KNECHT-MAHLE	DT12.06-470 Euro3	346	470	09/04	> 09/07	S 4402 R	S 6010 NE	S 7970 A	S 3066 C
power steering / servosterzo	DT12.06-470 Euro3	346	470	09/04	> 09/07				S 3081 PO
Vehicles for building site with filter (1506545, 1506546, 1506547) / veicoli da cantiere con filtro (1506545, 1506546, 1506547)	DT12.06-470 Euro3	346	470	09/04	> 09/07			S 7A50 A	
P 480									
dryer filter / filtro essiccatore	DC13.07-480 Euro5	353	480	10/07	>	S 5181 PE	S 6147 NE		S 3289 C
dryer filter / filtro essiccatore	DC13.07-480 Euro5	353	480	10/07	>				S 7F30 A
filter PARKER-RACOR / filtro PARKER-RACOR	DC13.07-480 Euro5	353	480	10/07	>		S 4479 NR		
flame retardant media DONALDSON assembly / media filtrante ritardante di fiamma montaggio DONALDSON	DC13.07-480 Euro5	353	480	10/07	> 12/08			S 7A25 A	
DONALDSON assembly / montaggio DONALDSON	DC13.07-480 Euro5	353	480	10/07	> 12/08			S 7286 A	
DONALDSON assembly short version / montaggio DONALDSON versione corta	DC13.07-480 Euro5	353	480	09/04	>			S 7B36 A	
assembly KNECHT-MAHLE / montaggio KNECHT-MAHLE	DC13.07-480 Euro5	353	480	10/07	>			S 7970 A	
power steering / servosterzo	DC13.07-480 Euro5	353	480	10/07	>				S 3081 PO
Vehicles for building site with filter (1506545, 1506546, 1506547) / veicoli da cantiere con filtro (1506545, 1506546, 1506547)	DC13.07-480 Euro5	353	480	10/07	>			S 7A50 A	
P 480									
dryer filter / filtro essiccatore	DT12.17-480 Euro4	353	480	09/06	>				S 7F30 A
filter PARKER-RACOR / filtro PARKER-RACOR	DT12.17-480 Euro4	353	480	09/06	>		S 4479 NR		
flame retardant media DONALDSON assembly / media filtrante ritardante di fiamma montaggio DONALDSON	DT12.17-480 Euro4	353	480	09/06	> 12/08			S 7A25 A	
assembly DONALDSON / montaggio DONALDSON	DT12.17-480 Euro4	353	480	09/06	> 09/07	S 4402 R	S 6010 NE	S 7286 A	S 3066 C
assembly DONALDSON / montaggio DONALDSON	DT12.17-480 Euro4	353	480	10/07	> 12/08	S 4402 R	S 6010 NE	S 7286 A	S 3289 C
assembly DONALDSON / montaggio DONALDSON	DT12.17-480 Euro4	353	480	01/09	>	S 4402 R	S 6010 NE		S 3289 C
DONALDSON assembly short version / montaggio DONALDSON versione corta	DT12.17-480 Euro4	353	480	09/04	>			S 7B36 A	
assembly KNECHT-MAHLE / montaggio KNECHT-MAHLE	DT12.17-480 Euro4	353	480	09/06	>	S 4402 R	S 6010 NE	S 7970 A	S 3066 C
power steering / servosterzo	DT12.17-480 Euro4	353	480	09/06	>				S 3081 PO
Vehicles for building site with filter (1506545, 1506546, 1506547) / veicoli da cantiere con filtro (1506545, 1506546, 1506547)	DT12.17-480 Euro4	353	480	09/06	>			S 7A50 A	
P 490									
dryer filter / filtro essiccatore	DC13.125-490 E6	360	490	10/13	>	S 5181 PE	S 6147 NE	S 7B36 A	S 3289 C
dryer filter / filtro essiccatore	DC13.125-490 E6	360	490	10/13	>				S 7F30 A
filter PARKER-RACOR / filtro PARKER-RACOR	DC13.125-490 E6	360	490	10/13	>		S 4479 NR		
power steering / servosterzo	DC13.125-490 E6	360	490	10/13	>				S 3081 PO
R Serie									
R 230									
	DC9.13 Euro3	169	230	06/04	> 09/07	S 4402 R	S 4341 NR		S 3066 C
	DC9.13 Euro3	169	230	10/07	>	S 4402 R	S 4341 NR		S 3289 C
dryer filter / filtro essiccatore	DC9.13 Euro3	169	230	06/04	>				S 7F30 A

S



...SCANIA - trucks/autocarri

S

dryer filter WABCO / filtro essiccatore WABCO	DC9.13 Euro3	169 230	06/04 > 09/05			S 7344 A
filter PARKER-RACOR / filtro PARKER-RACOR	DC9.13 Euro3	169 230	06/04 >		S 4479 NR	
retarder / freno di rallentamento	DC9.13 Euro3	169 230	06/04 >			S 5613 PO
flame retardant media DONALDSON / media filtrante ritardante di fiamma DONALDSON	DC9.13 Euro3	169 230	06/04 > 12/08			S 7A25 A
assembly DONALDSON / montaggio DONALDSON	DC9.13 Euro3	169 230	06/04 > 12/08			S 7286 A
DONALDSON assembly short version / montaggio DONALDSON versione corta	DC9.13 Euro3	169 230	01/09 >			S 7B36 A
assembly KNECHT-MAHLE / montaggio KNECHT-MAHLE	DC9.13 Euro3	169 230	06/04 >			S 7970 A
power steering / servosterzo	DC9.13 Euro3	169 230	06/04 >			S 3081 PO
Vehicles for building site with filter (1506545, 1506546, 1506547) / veicoli da cantiere con filtro (1506545, 1506546, 1506547)	DC9.13 Euro3	169 230	06/04 >			S 7A50 A
R 230	DC9.16 Euro4	169 230	10/05 > 09/07	S 4402 R	S 6010 NE	S 3066 C
	DC9.16 Euro4	169 230	10/07 >	S 4402 R	S 6010 NE	S 3289 C
dryer filter / filtro essiccatore	DC9.16 Euro4	169 230	10/05 >			S 7F30 A
filter PARKER-RACOR / filtro PARKER-RACOR	DC9.16 Euro4	169 230	10/05 >		S 4479 NR	
retarder / freno di rallentamento	DC9.16 Euro4	169 230	10/05 >			S 5613 PO
flame retardant media DONALDSON / media filtrante ritardante di fiamma DONALDSON	DC9.16 Euro4	169 230	10/05 > 12/08			S 7A25 A
assembly DONALDSON / montaggio DONALDSON	DC9.16 Euro4	169 230	10/05 > 12/08			S 7286 A
DONALDSON assembly short version / montaggio DONALDSON versione corta	DC9.16 Euro4	169 230	01/09 >			S 7B36 A
assembly KNECHT-MAHLE / montaggio KNECHT-MAHLE	DC9.16 Euro4	169 230	10/05 >			S 7970 A
power steering / servosterzo	DC9.16 Euro4	169 230	10/05 >			S 3081 PO
Vehicles for building site with filter (1506545, 1506546, 1506547) / veicoli da cantiere con filtro (1506545, 1506546, 1506547)	DC9.16 Euro4	169 230	10/05 >			S 7A50 A
R 270	DC9.12 Euro3	198 270	06/04 > 09/07	S 4402 R	S 4341 NR	S 3066 C
	DC9.12 Euro3	198 270	10/07 >	S 4402 R	S 4341 NR	S 3289 C
dryer filter WABCO / filtro essiccatore WABCO	DC9.12 Euro3	198 270	06/04 > 09/05			S 7344 A
filter PARKER-RACOR / filtro PARKER-RACOR	DC9.12 Euro3	198 270	06/04 >		S 4479 NR	
retarder / freno di rallentamento	DC9.12 Euro3	198 270	06/04 >			S 5613 PO
flame retardant media DONALDSON / media filtrante ritardante di fiamma DONALDSON	DC9.12 Euro3	198 270	06/04 > 12/08			S 7A25 A
assembly DONALDSON / montaggio DONALDSON	DC9.12 Euro3	198 270	06/04 > 12/08			S 7286 A
DONALDSON assembly short version / montaggio DONALDSON versione corta	DC9.12 Euro3	198 270	01/09 >			S 7B36 A
assembly KNECHT-MAHLE / montaggio KNECHT-MAHLE	DC9.12 Euro3	198 270	06/04 >			S 7970 A
power steering / servosterzo	DC9.12 Euro3	198 270	06/04 >			S 3081 PO
Vehicles for building site with filter (1506545, 1506546, 1506547) / veicoli da cantiere con filtro (1506545, 1506546, 1506547)	DC9.12 Euro3	198 270	06/04 >			S 7A50 A
R 270	DC9.17 Euro4	198 270	10/05 > 09/07	S 4402 R	S 6010 NE	S 3066 C
	DC9.17 Euro4	198 270	10/07 >	S 4402 R	S 6010 NE	S 3289 C
dryer filter / filtro essiccatore	DC9.17 Euro4	198 270	10/05 >			S 7F30 A
filter PARKER-RACOR / filtro PARKER-RACOR	DC9.17 Euro4	198 270	10/05 >		S 4479 NR	
retarder / freno di rallentamento	DC9.17 Euro4	198 270	10/05 >			S 5613 PO
flame retardant media DONALDSON / media filtrante ritardante di fiamma DONALDSON	DC9.17 Euro4	198 270	10/05 > 12/08			S 7A25 A
assembly DONALDSON / montaggio DONALDSON	DC9.17 Euro4	198 270	10/05 > 12/08			S 7286 A
DONALDSON assembly short version / montaggio DONALDSON versione corta	DC9.17 Euro4	198 270	01/09 >			S 7B36 A
assembly KNECHT-MAHLE / montaggio KNECHT-MAHLE	DC9.17 Euro4	198 270	10/05 >			S 7970 A
power steering / servosterzo	DC9.17 Euro4	198 270	10/05 >			S 3081 PO
Vehicles for building site with filter (1506545, 1506546, 1506547) / veicoli da cantiere con filtro (1506545, 1506546, 1506547)	DC9.17 Euro4	198 270	10/05 >			S 7A50 A
R 310	DC9.11 Euro3	228 310	06/04 > 09/07	S 4402 R	S 4341 NR	S 3066 C
	DC9.11 Euro3	228 310	10/07 >	S 4402 R	S 4341 NR	S 3289 C
dryer filter / filtro essiccatore	DC9.11 Euro3	228 310	06/04 >			S 7F30 A
dryer filter WABCO / filtro essiccatore WABCO	DC9.11 Euro3	228 310	06/04 > 09/05			S 7344 A
filter PARKER-RACOR / filtro PARKER-RACOR	DC9.11 Euro3	228 310	06/04 >		S 4479 NR	
flame retardant media DONALDSON / media filtrante ritardante di fiamma DONALDSON	DC9.11 Euro3	228 310	06/04 > 12/08			S 7A25 A
assembly DONALDSON / montaggio DONALDSON	DC9.11 Euro3	228 310	06/04 > 12/08			S 7286 A
DONALDSON assembly short version / montaggio DONALDSON versione corta	DC9.11 Euro3	228 310	01/09 >			S 7B36 A
assembly KNECHT-MAHLE / montaggio KNECHT-MAHLE	DC9.11 Euro3	228 310	06/04 >			S 7970 A
power steering / servosterzo	DC9.11 Euro3	228 310	06/04 >			S 3081 PO
Vehicles for building site with filter (1506545, 1506546, 1506547) / veicoli da cantiere con filtro (1506545, 1506546, 1506547)	DC9.11 Euro3	228 310	06/04 >			S 7A50 A
R 310	DC9.18 Euro4	228 310	10/05 > 09/07	S 4402 R	S 6010 NE	S 3066 C
	DC9.18 Euro4	228 310	10/07 >	S 4402 R	S 6010 NE	S 3289 C
dryer filter / filtro essiccatore	DC9.18 Euro4	228 310	10/05 >			S 7F30 A
filter PARKER-RACOR / filtro PARKER-RACOR	DC9.18 Euro4	228 310	10/05 >		S 4479 NR	
retarder / freno di rallentamento	DC9.18 Euro4	228 310	10/05 >			S 5613 PO
flame retardant media DONALDSON / media filtrante ritardante di fiamma DONALDSON	DC9.18 Euro4	228 310	10/05 > 12/08			S 7A25 A
assembly DONALDSON / montaggio DONALDSON	DC9.18 Euro4	228 310	10/05 > 12/08			S 7286 A
DONALDSON assembly short version / montaggio DONALDSON versione corta	DC9.18 Euro4	228 310	01/09 >			S 7B36 A
assembly KNECHT-MAHLE / montaggio KNECHT-MAHLE	DC9.18 Euro4	228 310	10/05 >			S 7970 A
power steering / servosterzo	DC9.18 Euro4	228 310	10/05 >			S 3081 PO
Vehicles for building site with filter (1506545, 1506546, 1506547) / veicoli da cantiere con filtro (1506545, 1506546, 1506547)	DC9.18 Euro4	228 310	10/05 >			S 7A50 A
R 340	DC11.08 Euro3	250 340	06/04 > 09/07	S 4402 R	S 4341 NR	S 3066 C
	DC11.08 Euro3	250 340	10/07 >	S 4402 R	S 4341 NR	S 3289 C
dryer filter / filtro essiccatore	DC11.08 Euro3	250 340	06/04 >			S 7F30 A

**KW HP****...SCANIA - trucks/autocarri**

dryer filter WABCO / filtro essiccatore WABCO	DC11.08 Euro3	250 340	06/04 > 09/05			S 7344 A
filter PARKER-RACOR / filtro PARKER-RACOR	DC11.08 Euro3	250 340	06/04 >		S 4479 NR	
flame retardant media DONALDSON / media filtrante ritardante di fiamma DONALDSON	DC11.08 Euro3	250 340	06/04 > 12/08			S 7A25 A
assembly DONALDSON / montaggio DONALDSON	DC11.08 Euro3	250 340	06/04 > 12/08			S 7286 A
DONALDSON assembly short version / montaggio DONALDSON versione corta	DC11.08 Euro3	250 340	09/04 >			S 7B36 A
DONALDSON assembly short version / montaggio DONALDSON versione corta	DC11.08 Euro3	250 340	01/09 >			S 7B36 A
assembly KNECHT-MAHLE / montaggio KNECHT-MAHLE	DC11.08 Euro3	250 340	06/04 >			S 7970 A
power steering / servosterzo	DC11.08 Euro3	250 340	06/04 >			S 3081 PO
Vehicles for building site with filter (1506545, 1506546, 1506547) / veicoli da cantiere con filtro (1506545, 1506546, 1506547)	DC11.08 Euro3	250 340	06/04 >			S 7A50 A
R 340	DC12.10 Euro4	250 340	10/05 > 09/07	S 4402 R	S 6010 NE	S 3066 C
	DC12.10 Euro4	250 340	10/07 >	S 4402 R	S 6010 NE	S 3289 C
dryer filter / filtro essiccatore	DC12.10 Euro4	250 340	10/05 >			S 7F30 A
filter PARKER-RACOR / filtro PARKER-RACOR	DC12.10 Euro4	250 340	10/05 >		S 4479 NR	
retarder / freno di rallentamento	DC12.10 Euro4	250 340	10/05 >			S 5613 PO
flame retardant media DONALDSON / media filtrante ritardante di fiamma DONALDSON	DC12.10 Euro4	250 340	10/05 > 12/08			S 7A25 A
assembly DONALDSON / montaggio DONALDSON	DC12.10 Euro4	250 340	10/05 > 12/08			S 7286 A
DONALDSON assembly short version / montaggio DONALDSON versione corta	DC12.10 Euro4	250 340	01/09 >			S 7B36 A
assembly KNECHT-MAHLE / montaggio KNECHT-MAHLE	DC12.10 Euro4	250 340	10/05 >			S 7970 A
power steering / servosterzo	DC12.10 Euro4	250 340	10/05 >			S 3081 PO
Vehicles for building site with filter (1506545, 1506546, 1506547) / veicoli da cantiere con filtro (1506545, 1506546, 1506547)	DC12.10 Euro4	250 340	10/05 >			S 7A50 A
R 360	DC13.06-360 Euro5	265 360	10/07 >	S 5181 PE	S 6147 NE	S 3289 C
dryer filter / filtro essiccatore	DC13.06-360 Euro5	265 360	10/07 >			S 7F30 A
filter PARKER-RACOR / filtro PARKER-RACOR	DC13.06-360 Euro5	265 360	10/07 >		S 4479 NR	
DONALDSON assembly short version / montaggio DONALDSON versione corta	DC13.06-360 Euro5	265 360	10/07 >			S 7B36 A
power steering / servosterzo	DC13.06-360 Euro5	265 360	10/07 >			S 3081 PO
Vehicles for building site with filter (1506545, 1506546, 1506547) / veicoli da cantiere con filtro (1506545, 1506546, 1506547)	DC13.06-360 Euro5	265 360	10/07 >			S 7A50 A
R 380	DC11.09 Euro3	279 380	06/04 > 09/07	S 4402 R	S 4341 NR	S 3066 C
	DC11.09 Euro3	279 380	10/07 >	S 4402 R	S 4341 NR	S 3289 C
dryer filter / filtro essiccatore	DC11.09 Euro3	279 380	06/04 >			S 7F30 A
dryer filter WABCO / filtro essiccatore WABCO	DC11.09 Euro3	279 380	06/04 > 09/05			S 7344 A
filter PARKER-RACOR / filtro PARKER-RACOR	DC11.09 Euro3	279 380	06/04 >		S 4479 NR	
retarder / freno di rallentamento	DC11.09 Euro3	279 380	06/04 >			S 5613 PO
flame retardant media DONALDSON / media filtrante ritardante di fiamma DONALDSON	DC11.09 Euro3	279 380	06/04 > 12/08			S 7A25 A
assembly DONALDSON / montaggio DONALDSON	DC11.09 Euro3	279 380	06/04 > 12/08			S 7286 A
DONALDSON assembly short version / montaggio DONALDSON versione corta	DC11.09 Euro3	279 380	01/09 >			S 7B36 A
assembly KNECHT-MAHLE / montaggio KNECHT-MAHLE	DC11.09 Euro3	279 380	06/04 >			S 7970 A
power steering / servosterzo	DC11.09 Euro3	279 380	06/04 >			S 3081 PO
Vehicles for building site with filter (1506545, 1506546, 1506547) / veicoli da cantiere con filtro (1506545, 1506546, 1506547)	DC11.09 Euro3	279 380	06/04 >			S 7A50 A
R 380	DC12.13 Euro4	280 380	10/05 > 09/07	S 4402 R	S 6010 NE	S 3066 C
	DC12.13 Euro4	280 380	10/07 >	S 4402 R	S 6010 NE	S 3289 C
with filter Urea/Adblue / con filtro Urea/Adblue	DC12.13 Euro4	280 380	10/05 >			S 4401 U
dryer filter / filtro essiccatore	DC12.13 Euro4	280 380	10/05 >			S 7F30 A
filter PARKER-RACOR / filtro PARKER-RACOR	DC12.13 Euro4	280 380	10/05 >		S 4479 NR	
retarder / freno di rallentamento	DC12.13 Euro4	280 380	10/05 >			S 5613 PO
flame retardant media DONALDSON / media filtrante ritardante di fiamma DONALDSON	DC12.13 Euro4	280 380	10/05 > 12/08			S 7A25 A
assembly DONALDSON / montaggio DONALDSON	DC12.13 Euro4	280 380	10/05 > 12/08			S 7286 A
DONALDSON assembly short version / montaggio DONALDSON versione corta	DC12.13 Euro4	280 380	01/09 >			S 7B36 A
assembly KNECHT-MAHLE / montaggio KNECHT-MAHLE	DC12.13 Euro4	280 380	10/05 >			S 7970 A
power steering / servosterzo	DC12.13 Euro4	280 380	10/05 >			S 3081 PO
Vehicles for building site with filter (1506545, 1506546, 1506547) / veicoli da cantiere con filtro (1506545, 1506546, 1506547)	DC12.13 Euro4	280 380	10/05 >			S 7A50 A
R 380	DC12.18-380 Euro5	280 381	09/06 > 09/07	S 4402 R	S 6010 NE	S 3066 C
	DC12.18-380 Euro5	280 381	10/07 >	S 4402 R	S 6010 NE	S 3289 C
with filter Urea/Adblue / con filtro Urea/Adblue	DC12.18-380 Euro5	280 381	09/06 >			S 4401 U
dryer filter / filtro essiccatore	DC12.18-380 Euro5	280 381	09/06 >			S 7F30 A
filter PARKER-RACOR / filtro PARKER-RACOR	DC12.18-380 Euro5	280 381	09/05 >		S 4479 NR	
retarder / freno di rallentamento	DC12.18-380 Euro5	280 381	09/06 >			S 5613 PO
flame retardant media DONALDSON / media filtrante ritardante di fiamma DONALDSON	DC12.18-380 Euro5	280 381	09/06 > 12/08			S 7A25 A
assembly DONALDSON / montaggio DONALDSON	DC12.18-380 Euro5	280 381	09/06 > 12/08			S 7286 A
DONALDSON assembly short version / montaggio DONALDSON versione corta	DC12.18-380 Euro5	280 381	01/09 >			S 7B36 A
assembly KNECHT-MAHLE / montaggio KNECHT-MAHLE	DC12.18-380 Euro5	280 381	09/06 >			S 7970 A
power steering / servosterzo	DC12.18-380 Euro5	280 381	09/06 >			S 3081 PO
Vehicles for building site with filter (1506545, 1506546, 1506547) / veicoli da cantiere con filtro (1506545, 1506546, 1506547)	DC12.18-380 Euro5	280 381	09/06 >			S 7A50 A
R 400	DC13.05-400 Euro5	294 400	10/07 >	S 5181 PE	S 6147 NE	S 3289 C
dryer filter / filtro essiccatore	DC13.05-400 Euro5	294 400	10/07 >			S 7F30 A
filter PARKER-RACOR / filtro PARKER-RACOR	DC13.05-400 Euro5	294 400	10/07 >		S 4479 NR	
DONALDSON assembly short version / montaggio DONALDSON versione corta	DC13.05-400 Euro5	294 400	10/07 >			S 7B36 A
power steering / servosterzo	DC13.05-400 Euro5	294 400	10/07 >			S 3081 PO





...SCANIA - trucks/autocarri

S

Vehicles for building site with filter (1506545, 1506546, 1506547) / veicoli da cantiere con filtro (1506545, 1506546, 1506547)	DC13.05-400 Euro5	294	400	10/07	>				S 7A50 A	
R 410										
DONALDSON assembly short version / montaggio DONALDSON versione corta	DC13.141-410	302	410	09/04	>				S 7B36 A	
DONALDSON assembly short version / montaggio DONALDSON versione corta	DC13.141-410	302	410	09/04	>				S 7B36 A	
R 410	DC13.141-410 Euro6	302	410	08/16	>	S 5181 PE	S 6147 NE		S 7B36 A	S 3289 C
dryer filter / filtro essiccatore	DC13.141-410 Euro6	302	410	10/13	>					S 7F30 A
filter PARKER-RACOR / filtro PARKER-RACOR	DC13.141-410 Euro6	302	410	10/13	>		S 4479 NR			
retarder / freno di rallentamento	DC13.141-410 Euro6	302	410	08/16	>					S 5613 PO
power steering / servosterzo	DC13.141-410 Euro6	302	410	08/16	>					S 3081 PO
R 420	DC12.14 Euro3	309	420	06/04	> 09/07	S 4402 R	S 4341 NR			S 3066 C
	DC12.14 Euro3	309	420	10/07	>	S 4402 R	S 4341 NR			S 3289 C
dryer filter / filtro essiccatore	DC12.14 Euro3	309	420	06/04	>					S 7F30 A
dryer filter WABCO / filtro essiccatore WABCO	DC12.14 Euro3	309	420	06/04	> 09/05					S 7344 A
filter PARKER-RACOR / filtro PARKER-RACOR	DC12.14 Euro3	309	420	06/04	>		S 4479 NR			
retarder / freno di rallentamento	DC12.14 Euro3	309	420	06/04	>					S 5613 PO
assembly DONALDSON / montaggio DONALDSON	DC12.14 Euro3	309	420	06/04	> 12/08				S 7286 A	
DONALDSON assembly flame retardant media / montaggio DONALDSON media filtrante ritardante di fiamma	DC12.14 Euro3	309	420	06/04	> 12/08				S 7A25 A	
DONALDSON assembly flame retardant media / montaggio DONALDSON media filtrante ritardante di fiamma	DC12.14 Euro3	309	420	01/09	>				S 7B36 A	
assembly KNECHT-MAHLE / montaggio KNECHT-MAHLE	DC12.14 Euro3	309	420	06/04	>				S 7970 A	
power steering / servosterzo	DC12.14 Euro3	309	420	06/04	>					S 3081 PO
Vehicles for building site with filter (1506545, 1506546, 1506547) / veicoli da cantiere con filtro (1506545, 1506546, 1506547)	DC12.14 Euro3	309	420	06/04	>				S 7A50 A	
R 420 HPI	DT12.12 Euro4	309	420	06/04	> 09/07	S 4402 R	S 6010 NE			S 3066 C
	DT12.12 Euro4	309	420	10/07	>	S 4402 R	S 6010 NE			S 3289 C
dryer filter / filtro essiccatore	DT12.12 Euro4	309	420	06/04	>					S 7F30 A
dryer filter WABCO / filtro essiccatore WABCO	DT12.12 Euro4	309	420	06/04	> 09/05					S 7344 A
retarder / freno di rallentamento	DT12.12 Euro4	309	420	06/04	>					S 5613 PO
flame retardant media DONALDSON / media filtrante ritardante di fiamma DONALDSON	DT12.12 Euro4	309	420	06/04	> 12/08				S 7A25 A	
flame retardant media DONALDSON / media filtrante ritardante di fiamma DONALDSON	DT12.12 Euro4	309	420	01/09	>				S 7B36 A	
assembly DONALDSON / montaggio DONALDSON	DT12.12 Euro4	309	420	06/04	> 12/08				S 7286 A	
assembly KNECHT-MAHLE / montaggio KNECHT-MAHLE	DT12.12 Euro4	309	420	06/04	>				S 7970 A	
power steering / servosterzo	DT12.12 Euro4	309	420	06/04	>					S 3081 PO
Vehicles for building site with filter (1506545, 1506546, 1506547) / veicoli da cantiere con filtro (1506545, 1506546, 1506547)	DT12.12 Euro4	309	420	06/04	>				S 7A50 A	
R 420 HPI	DT12.15 Euro5	309	420	02/06	> 09/07	S 4402 R	S 6010 NE			S 3066 C
	DT12.15 Euro5	309	420	10/07	>	S 4402 R	S 6010 NE			S 3289 C
with filter Urea/Adblue / con filtro Urea/Adblue	DT12.15 Euro5	309	420	02/06	>					S 4401 U
retarder / freno di rallentamento	DT12.15 Euro5	309	420	02/06	>					S 5613 PO
flame retardant media DONALDSON / media filtrante ritardante di fiamma DONALDSON	DT12.15 Euro5	309	420	02/06	> 12/08				S 7A25 A	
flame retardant media DONALDSON / media filtrante ritardante di fiamma DONALDSON	DT12.15 Euro5	309	420	01/09	>				S 7B36 A	
assembly DONALDSON / montaggio DONALDSON	DT12.15 Euro5	309	420	02/06	> 12/08				S 7286 A	
assembly KNECHT-MAHLE / montaggio KNECHT-MAHLE	DT12.15 Euro5	309	420	02/06	>				S 7970 A	
power steering / servosterzo	DT12.15 Euro5	309	420	02/06	>					S 3081 PO
Vehicles for building site with filter (1506545, 1506546, 1506547) / veicoli da cantiere con filtro (1506545, 1506546, 1506547)	DT12.15 Euro5	309	420	02/06	>				S 7A50 A	
R 440	DC13.10-440 Euro5	324	440	10/07	>	S 5181 PE	S 6147 NE			S 3289 C
dryer filter / filtro essiccatore	DC13.10-440 Euro5	324	440	10/07	>					S 7F30 A
filter PARKER-RACOR / filtro PARKER-RACOR	DC13.10-440 Euro5	324	440	10/07	>		S 4479 NR			
retarder / freno di rallentamento	DC13.10-440 Euro5	324	440	10/07	>					S 5613 PO
flame retardant media DONALDSON / media filtrante ritardante di fiamma DONALDSON	DC13.10-440 Euro5	324	440	10/07	> 12/08				S 7A25 A	
flame retardant media DONALDSON / media filtrante ritardante di fiamma DONALDSON	DC13.10-440 Euro5	324	440	01/09	>				S 7B36 A	
assembly DONALDSON / montaggio DONALDSON	DC13.10-440 Euro5	324	440	10/07	> 12/08				S 7286 A	
assembly KNECHT-MAHLE / montaggio KNECHT-MAHLE	DC13.10-440 Euro5	324	440	10/07	>				S 7970 A	
power steering / servosterzo	DC13.10-440 Euro5	324	440	10/07	>					S 3081 PO
Vehicles for building site with filter (1506545, 1506546, 1506547) / veicoli da cantiere con filtro (1506545, 1506546, 1506547)	DC13.10-440 Euro5	324	440	10/07	>				S 7A50 A	
R 450	DC13.148-450 Euro6	331	450	08/16	>	S 5181 PE	S 6147 NE		S 7B36 A	S 3289 C
dryer filter / filtro essiccatore	DC13.148-450 Euro6	331	450	10/13	>					S 7F30 A
filter PARKER-RACOR / filtro PARKER-RACOR	DC13.148-450 Euro6	331	450	10/13	>		S 4479 NR			
retarder / freno di rallentamento	DC13.148-450 Euro6	331	450	08/16	>					S 5613 PO
power steering / servosterzo	DC13.148-450 Euro6	331	450	08/16	>					S 3081 PO
R 470 HPI	DT12.03 Euro4	346	470	10/05	> 09/07	S 4402 R	S 6010 NE			S 3066 C
dryer filter / filtro essiccatore	DT12.03 Euro4	346	470	10/05	> 09/07					S 7F30 A
filter PARKER-RACOR / filtro PARKER-RACOR	DT12.03 Euro4	346	470	10/05	> 09/07		S 4479 NR			
retarder / freno di rallentamento	DT12.03 Euro4	346	470	10/05	> 09/07					S 5613 PO
flame retardant media DONALDSON / media filtrante ritardante di fiamma DONALDSON	DT12.03 Euro4	346	470	10/05	> 09/07				S 7A25 A	
assembly DONALDSON / montaggio DONALDSON	DT12.03 Euro4	346	470	10/05	> 09/07				S 7286 A	
assembly KNECHT-MAHLE / montaggio KNECHT-MAHLE	DT12.03 Euro4	346	470	10/05	> 09/07				S 7970 A	
power steering / servosterzo	DT12.03 Euro4	346	470	10/05	> 09/07					S 3081 PO
Vehicles for building site with filter (1506545, 1506546, 1506547) / veicoli da cantiere con filtro (1506545, 1506546, 1506547)	DT12.03 Euro4	346	470	10/05	> 09/07				S 7A50 A	
R 470 HPI	DT12.06 Euro3	346	470	06/04	> 09/07	S 4402 R	S 6010 NE			S 3066 C



...SCANIA - trucks/autocarri

dryer filter / filtro essiccatore	DT12.06 Euro3	346 470	10/07 >	S 4402 R	S 6010 NE		S 3289 C
dryer filter WABCO / filtro essiccatore WABCO	DT12.06 Euro3	346 470	06/04 >				S 7F30 A
filter PARKER-RACOR / filtro PARKER-RACOR	DT12.06 Euro3	346 470	06/04 > 09/05				S 7344 A
retarder / freno di rallentamento	DT12.06 Euro3	346 470	06/04 >		S 4479 NR		
flame retardant media DONALDSON / media filtrante ritardante di fiamma DONALDSON	DT12.06 Euro3	346 470	06/04 > 12/08			S 7A25 A	S 5613 PO
flame retardant media DONALDSON / media filtrante ritardante di fiamma DONALDSON	DT12.06 Euro3	346 470	01/09 >			S 7B36 A	
assembly DONALDSON / montaggio DONALDSON	DT12.06 Euro3	346 470	06/04 > 12/08			S 7286 A	
assembly KNECHT-MAHLE / montaggio KNECHT-MAHLE	DT12.06 Euro3	346 470	06/04 >			S 7970 A	
power steering / servosterzo	DT12.06 Euro3	346 470	06/04 >				S 3081 PO
Vehicles for building site with filter (1506545, 1506546, 1506547) / veicoli da cantiere con filtro (1506545, 1506546, 1506547)	DT12.06 Euro3	346 470	06/04 >			S 7A50 A	
R 480	DC13.07-480 Euro5	353 480	10/07 >	S 5181 PE	S 6147 NE		S 3289 C
dryer filter / filtro essiccatore	DC13.07-480 Euro5	353 480	10/07 >				S 7F30 A
filter PARKER-RACOR / filtro PARKER-RACOR	DC13.07-480 Euro5	353 480	10/07 >		S 4479 NR		
DONALDSON assembly short version / montaggio DONALDSON versione corta	DC13.07-480 Euro5	353 480	09/04 >			S 7B36 A	
power steering / servosterzo	DC13.07-480 Euro5	353 480	10/07 >				S 3081 PO
Vehicles for building site with filter (1506545, 1506546, 1506547) / veicoli da cantiere con filtro (1506545, 1506546, 1506547)	DC13.07-480 Euro5	353 480	10/07 >			S 7A50 A	
R 480	DC13.110-480 Euro6	353 480	02/12 >	S 5181 PE	S 6147 NE	S 7B36 A	S 3289 C
dryer filter / filtro essiccatore	DC13.110-480 Euro6	353 480	02/12 >				S 7F30 A
filter PARKER-RACOR / filtro PARKER-RACOR	DC13.110-480 Euro6	353 480	02/12 >		S 4479 NR		
retarder / freno di rallentamento	DC13.110-480 Euro6	353 480	02/12 >				S 5613 PO
power steering / servosterzo	DC13.110-480 Euro6	353 480	02/12 >				S 3081 PO
R 480 HPI	DT12.17 Euro4	353 480	06/06 > 09/07	S 4402 R	S 6010 NE		S 3066 C
	DT12.17 Euro4	353 480	10/07 >	S 4402 R	S 6010 NE		S 3289 C
filter PARKER-RACOR / filtro PARKER-RACOR	DT12.17 Euro4	353 480	09/06 >		S 4479 NR		
retarder / freno di rallentamento	DT12.17 Euro4	353 480	06/06 >				S 5613 PO
flame retardant media DONALDSON / media filtrante ritardante di fiamma DONALDSON	DT12.17 Euro4	353 480	06/06 > 12/08			S 7A25 A	
flame retardant media DONALDSON / media filtrante ritardante di fiamma DONALDSON	DT12.17 Euro4	353 480	01/09 >			S 7B36 A	
assembly DONALDSON / montaggio DONALDSON	DT12.17 Euro4	353 480	06/06 > 12/08			S 7286 A	
assembly KNECHT-MAHLE / montaggio KNECHT-MAHLE	DT12.17 Euro4	353 480	06/06 >			S 7970 A	
power steering / servosterzo	DT12.17 Euro4	353 480	06/06 >				S 3081 PO
Vehicles for building site with filter (1506545, 1506546, 1506547) / veicoli da cantiere con filtro (1506545, 1506546, 1506547)	DT12.17 Euro4	353 480	06/06 >			S 7A50 A	
R 500	DC13.155-500 Euro6	358 500	08/16 >	S 5181 PE	S 6147 NE		S 5613 PO
retarder / freno di rallentamento	DC13.155-500 Euro6	358 500	08/16 >				S 3081 PO
power steering / servosterzo	DC13.155-500 Euro6	358 500	08/16 >				
R 500	DC16.04 Euro3	368 500	06/04 > 09/07	S 5044 PE	S 6008 NE		S 3066 C
	DC16.04 Euro3	368 500	10/07 >	S 5044 PE	S 6008 NE		S 3289 C
dryer filter / filtro essiccatore	DC16.04 Euro3	368 500	06/04 >				S 7F30 A
dryer filter WABCO / filtro essiccatore WABCO	DC16.04 Euro3	368 500	06/04 > 09/05				S 7344 A
filter PARKER-RACOR / filtro PARKER-RACOR	DC16.04 Euro3	368 500	06/04 >		S 4479 NR		
retarder / freno di rallentamento	DC16.04 Euro3	368 500	06/04 >				S 5613 PO
assembly DONALDSON / montaggio DONALDSON	DC16.04 Euro3	368 500	06/04 > 03/09			S 7358 A	
DONALDSON assembly inner / montaggio DONALDSON interno	DC16.04 Euro3	368 500	06/04 > 03/09			S 7A44 A	
DONALDSON assembly flame retardant media / montaggio DONALDSON media filtrante ritardante di fiamma	DC16.04 Euro3	368 500	06/04 > 03/09			S 7A26 A	
DONALDSON assembly flame retardant media / montaggio DONALDSON media filtrante ritardante di fiamma	DC16.04 Euro3	368 500	04/09 >			S 7C13 A	
assembly KNECHT-MAHLE / montaggio KNECHT-MAHLE	DC16.04 Euro3	368 500	06/04 >			S 7615 A	
power steering / servosterzo	DC16.04 Euro3	368 500	06/04 >				S 3081 PO
R 500	DC16.06 Euro4	368 500	02/06 > 09/07	S 5044 PE	S 6008 NE		S 3066 C
	DC16.06 Euro4	368 500	10/07 >	S 5044 PE	S 6008 NE		S 3289 C
with filter Urea/Adblue / con filtro Urea/Adblue	DC16.06 Euro4	368 500	02/06 >				S 4401 U
dryer filter / filtro essiccatore	DC16.06 Euro4	368 500	02/06 >				S 7F30 A
filter PARKER-RACOR / filtro PARKER-RACOR	DC16.06 Euro4	368 500	02/06 >		S 4479 NR		
retarder / freno di rallentamento	DC16.06 Euro4	368 500	02/06 >				S 5613 PO
assembly DONALDSON / montaggio DONALDSON	DC16.06 Euro4	368 500	02/06 > 03/09			S 7358 A	
DONALDSON assembly inner / montaggio DONALDSON interno	DC16.06 Euro4	368 500	02/06 > 03/09			S 7A44 A	
DONALDSON assembly flame retardant media / montaggio DONALDSON media filtrante ritardante di fiamma	DC16.06 Euro4	368 500	02/06 > 03/09			S 7A26 A	
DONALDSON assembly flame retardant media / montaggio DONALDSON media filtrante ritardante di fiamma	DC16.06 Euro4	368 500	04/09 >			S 7C13 A	
assembly KNECHT-MAHLE / montaggio KNECHT-MAHLE	DC16.06 Euro4	368 500	02/06 >			S 7615 A	
power steering / servosterzo	DC16.06 Euro4	368 500	02/06 >				S 3081 PO
R 500	DC16.09 Euro5	368 500	05/06 > 09/07	S 5044 PE	S 6008 NE		S 3066 C
	DC16.09 Euro5	368 500	10/07 >	S 5044 PE	S 6008 NE		S 3289 C
with filter Urea/Adblue / con filtro Urea/Adblue	DC16.09 Euro5	368 500	05/06 >				S 4401 U
dryer filter / filtro essiccatore	DC16.09 Euro5	368 500	05/06 >				S 7F30 A
filter PARKER-RACOR / filtro PARKER-RACOR	DC16.09 Euro5	368 500	05/06 >		S 4479 NR		
retarder / freno di rallentamento	DC16.09 Euro5	368 500	05/06 >				S 5613 PO
assembly DONALDSON / montaggio DONALDSON	DC16.09 Euro5	368 500	05/06 > 03/09			S 7358 A	
DONALDSON assembly inner / montaggio DONALDSON interno	DC16.09 Euro5	368 500	05/06 > 03/09			S 7A44 A	



**KW HP****...SCANIA - trucks/autocarri****S**

DONALDSON assembly flame retardant media / montaggio DONALDSON media filtrante ritardante di fiamma	DC16.09 Euro5	368	500	05/06	>	03/09			S 7A26 A	
DONALDSON assembly flame retardant media / montaggio DONALDSON media filtrante ritardante di fiamma	DC16.09 Euro5	368	500	04/09	>				S 7C13 A	
assembly KNECHT-MAHLE / montaggio KNECHT-MAHLE	DC16.09 Euro5	368	500	05/06	>				S 7615 A	
power steering / servosterzo	DC16.09 Euro5	368	500	05/06	>					S 3081 PO
R 520	DC16.105-520 Euro6	382	520	08/16	>		S 5044 PE	S 6147 NE	S 7C13 A	
retarder / freno di rallentamento	DC16.105-520 Euro6	382	520	08/16	>					S 5613 PO
power steering / servosterzo	DC16.105-520 Euro6	382	520	08/16	>					S 3081 PO
R 560	DC16.05 Euro4	412	560	02/06	>	09/07	S 5044 PE	S 6008 NE		S 3066 C
	DC16.05 Euro4	412	560	10/07	>		S 5044 PE	S 6008 NE		S 3289 C
with filter Urea/Adblue / con filtro Urea/Adblue	DC16.05 Euro4	412	560	02/06	>					S 4401 U
dryer filter / filtro essiccatore	DC16.05 Euro4	412	560	02/06	>					S 7F30 A
filter PARKER-RACOR / filtro PARKER-RACOR	DC16.05 Euro4	412	560	02/06	>			S 4479 NR		
retarder / freno di rallentamento	DC16.05 Euro4	412	560	02/06	>					S 5613 PO
assembly DONALDSON / montaggio DONALDSON	DC16.05 Euro4	412	560	02/06	>	03/09			S 7358 A	
DONALDSON assembly inner / montaggio DONALDSON interno	DC16.05 Euro4	412	560	02/06	>	03/09			S 7A44 A	
DONALDSON assembly flame retardant media / montaggio DONALDSON media filtrante ritardante di fiamma	DC16.05 Euro4	412	560	02/06	>	03/09			S 7A26 A	
DONALDSON assembly flame retardant media / montaggio DONALDSON media filtrante ritardante di fiamma	DC16.05 Euro4	412	560	04/09	>				S 7C13 A	
assembly KNECHT-MAHLE / montaggio KNECHT-MAHLE	DC16.05 Euro4	412	560	02/06	>				S 7615 A	
power steering / servosterzo	DC16.05 Euro4	412	560	02/06	>					S 3081 PO
R 560	DC16.18-560 Euro5	412	560	10/07	>		S 5044 PE	S 6008 NE		S 3289 C
with filter Urea/Adblue / con filtro Urea/Adblue	DC16.18-560 Euro5	412	560	10/07	>					S 4401 U
dryer filter / filtro essiccatore	DC16.18-560 Euro5	412	560	10/07	>					S 7F30 A
filter PARKER-RACOR / filtro PARKER-RACOR	DC16.18-560 Euro5	412	560	10/07	>			S 4479 NR		
assembly DONALDSON / montaggio DONALDSON	DC16.18-560 Euro5	412	560	10/07	>	03/09			S 7358 A	
DONALDSON assembly inner / montaggio DONALDSON interno	DC16.18-560 Euro5	412	560	10/07	>	03/09			S 7A44 A	
DONALDSON assembly flame retardant media / montaggio DONALDSON media filtrante ritardante di fiamma	DC16.18-560 Euro5	412	560	10/07	>	03/09			S 7A26 A	
DONALDSON assembly flame retardant media / montaggio DONALDSON media filtrante ritardante di fiamma	DC16.18-560 Euro5	412	560	04/09	>				S 7C13 A	
assembly KNECHT-MAHLE / montaggio KNECHT-MAHLE	DC16.18-560 Euro5	412	560	10/07	>				S 7615 A	
power steering / servosterzo	DC16.18-560 Euro5	412	560	10/07	>					S 3081 PO
R 580	DC16.03 Euro3	426	580	06/04	>	09/07	S 5044 PE	S 6008 NE		S 3066 C
	DC16.03 Euro3	426	580	10/07	>		S 5044 PE	S 6008 NE		S 3289 C
with filter Urea/Adblue / con filtro Urea/Adblue	DC16.03 Euro3	426	580	05/05	>					S 4401 U
dryer filter / filtro essiccatore	DC16.03 Euro3	426	580	06/04	>					S 7F30 A
dryer filter WABCO / filtro essiccatore WABCO	DC16.03 Euro3	426	580	06/04	>	09/05				S 7344 A
filter PARKER-RACOR / filtro PARKER-RACOR	DC16.03 Euro3	426	580	06/04	>			S 4479 NR		
retarder / freno di rallentamento	DC16.03 Euro3	426	580	06/04	>					S 5613 PO
assembly DONALDSON / montaggio DONALDSON	DC16.03 Euro3	426	580	06/04	>	03/09			S 7358 A	
DONALDSON assembly inner / montaggio DONALDSON interno	DC16.03 Euro3	426	580	06/04	>	03/09			S 7A44 A	
DONALDSON assembly flame retardant media / montaggio DONALDSON media filtrante ritardante di fiamma	DC16.03 Euro3	426	580	06/04	>	03/09			S 7A26 A	
DONALDSON assembly flame retardant media / montaggio DONALDSON media filtrante ritardante di fiamma	DC16.03 Euro3	426	580	04/09	>				S 7C13 A	
assembly KNECHT-MAHLE / montaggio KNECHT-MAHLE	DC16.03 Euro3	426	580	06/04	>				S 7615 A	
power steering / servosterzo	DC16.03 Euro3	426	580	06/04	>					S 3081 PO
R 580	DC16.106-580 Euro6	427	580	08/16	>		S 5044 PE	S 6147 NE	S 7C13 A	
retarder / freno di rallentamento	DC16.106-580 Euro6	427	580	08/16	>					S 5613 PO
power steering / servosterzo	DC16.106-580 Euro6	427	580	08/16	>					S 3081 PO
R 620	DC16.08 Euro4	456	620	05/06	>	09/07	S 5044 PE	S 6008 NE		S 3066 C
	DC16.08 Euro4	456	620	10/07	>		S 5044 PE	S 6008 NE		S 3289 C
with filter Urea/Adblue / con filtro Urea/Adblue	DC16.08 Euro4	456	620	05/06	>					S 4401 U
dryer filter / filtro essiccatore	DC16.08 Euro4	456	620	05/06	>					S 7F30 A
filter PARKER-RACOR / filtro PARKER-RACOR	DC16.08 Euro4	456	620	05/06	>			S 4479 NR		
retarder / freno di rallentamento	DC16.08 Euro4	456	620	05/06	>					S 5613 PO
assembly DONALDSON / montaggio DONALDSON	DC16.08 Euro4	456	620	05/06	>	03/09			S 7358 A	
DONALDSON assembly inner / montaggio DONALDSON interno	DC16.08 Euro4	456	620	05/06	>	03/09			S 7A44 A	
DONALDSON assembly flame retardant media / montaggio DONALDSON media filtrante ritardante di fiamma	DC16.08 Euro4	456	620	05/06	>	03/09			S 7A26 A	
DONALDSON assembly flame retardant media / montaggio DONALDSON media filtrante ritardante di fiamma	DC16.08 Euro4	456	620	04/09	>				S 7C13 A	
assembly KNECHT-MAHLE / montaggio KNECHT-MAHLE	DC16.08 Euro4	456	620	05/06	>				S 7615 A	
power steering / servosterzo	DC16.08 Euro4	456	620	05/06	>					S 3081 PO
R 620	DC16.17-620 Euro5	456	620	10/07	>		S 5044 PE	S 6008 NE		S 3289 C
with filter Urea/Adblue / con filtro Urea/Adblue	DC16.17-620 Euro5	456	620	10/07	>					S 4401 U
retarder / freno di rallentamento	DC16.17-620 Euro5	456	620	10/07	>					S 5613 PO
assembly DONALDSON / montaggio DONALDSON	DC16.17-620 Euro5	456	620	10/07	>	03/09			S 7358 A	
DONALDSON assembly inner / montaggio DONALDSON interno	DC16.17-620 Euro5	456	620	10/07	>	03/09			S 7A44 A	
DONALDSON assembly flame retardant media / montaggio DONALDSON media filtrante ritardante di fiamma	DC16.17-620 Euro5	456	620	10/07	>	03/09			S 7A26 A	
DONALDSON assembly flame retardant media / montaggio DONALDSON media filtrante ritardante di fiamma	DC16.17-620 Euro5	456	620	04/09	>				S 7C13 A	
assembly KNECHT-MAHLE / montaggio KNECHT-MAHLE	DC16.17-620 Euro5	456	620	10/07	>				S 7615 A	
power steering / servosterzo	DC16.17-620 Euro5	456	620	10/07	>					S 3081 PO
R 730	DC16.107-730 Euro6	537	730	08/16	>		S 5044 PE	S 6147 NE	S 7C13 A	

**KW HP**

...SCANIA - trucks/autocarri

retarder / freno di rallentamento	DC16.107-730 Euro6	537	730	08/16	>				S 5613 PO
power steering / servosterzo	DC16.107-730 Euro6	537	730	08/16	>				S 3081 PO
R 730	DC16.21-730 Euro5	537	730	05/10	>	S 5044 PE	S 6147 NE	S 7C13 A	S 3289 C
with filter Urea/Adblue / con filtro Urea/Adblue	DC16.21-730 Euro5	537	730	05/10	>				S 4401 U
dryer filter / filtro essiccatore	DC16.21-730 Euro5	537	730	05/10	>				S 7F30 A
filter PARKER-RACOR / filtro PARKER-RACOR	DC16.21-730 Euro5	537	730	05/10	>		S 4479 NR		
power steering / servosterzo	DC16.21-730 Euro5	537	730	05/10	>				S 3081 PO
S Serie									
S 410	DC13.141-410 Euro6	302	410	08/16	>	S 5181 PE	S 6147 NE		
retarder / freno di rallentamento	DC13.141-410 Euro6	302	410	08/16	>				S 5613 PO
power steering / servosterzo	DC13.141-410 Euro6	302	410	08/16	>				S 3081 PO
S 450	DC13.148-450 Euro6	331	450	08/16	>	S 5181 PE	S 6147 NE		
retarder / freno di rallentamento	DC13.148-450 Euro6	331	450	08/16	>				S 5613 PO
power steering / servosterzo	DC13.148-450 Euro6	331	450	08/16	>				S 3081 PO
S 500	DC13.155-500 Euro6	358	500	08/16	>	S 5181 PE	S 6147 NE		
retarder / freno di rallentamento	DC13.155-500 Euro6	358	500	08/16	>				S 5613 PO
power steering / servosterzo	DC13.155-500 Euro6	358	500	08/16	>				S 3081 PO
S 520	DC16.105-520 Euro6	382	520	08/16	>	S 5044 PE	S 6147 NE		
retarder / freno di rallentamento	DC16.105-520 Euro6	382	520	08/16	>				S 5613 PO
power steering / servosterzo	DC16.105-520 Euro6	382	520	08/16	>				S 3081 PO
S 580	DC16.106-580 Euro6	427	580	08/16	>	S 5044 PE	S 6147 NE		
retarder / freno di rallentamento	DC16.106-580 Euro6	427	580	08/16	>				S 5613 PO
power steering / servosterzo	DC16.106-580 Euro6	427	580	08/16	>				S 3081 PO
S 730	DC16.107-730 Euro6	537	730	08/16	>	S 5044 PE	S 6147 NE		
retarder / freno di rallentamento	DC16.107-730 Euro6	537	730	08/16	>				S 5613 PO
power steering / servosterzo	DC16.107-730 Euro6	537	730	08/16	>				S 3081 PO
SBA Serie									
SBA 111	D 11			12/75	> 12/90		S 4323 NR	S 2450 A	
SBAT Serie									
SBAT 111	DS 11			12/75	> 12/90		S 4323 NR	S 0450 A	
some / alcuni	DS 11			12/75	> 12/90		S 8501 NR	S 0450 A	
turbocompressor / turbocompressore	DS 11			12/75	> 12/90	S 2329 R			
SBH Serie									
SBH 111	D 11			12/75	> 12/90		S 4323 NR	S 2450 A	
T Serie									
T 340	DC11.08 Euro3	250	340	09/04	> 12/05	S 4402 R	S 4341 NR		S 3066 C
dryer filter / filtro essiccatore	DC11.08 Euro3	250	340	09/04	> 12/05				S 7F30 A
dryer filter WABCO / filtro essiccatore WABCO	DC11.08 Euro3	250	340	09/04	> 09/05				S 7344 A
retarder / freno di rallentamento	DC11.08 Euro3	250	340	09/04	> 12/05				S 5613 PO
assembly DONALDSON / montaggio DONALDSON	DC11.08 Euro3	250	340	09/04	> 12/05			S 7286 A	
DONALDSON assembly flame retardant media / montaggio DONALDSON media filtrante ritardante di fiamma	DC11.08 Euro3	250	340	09/04	> 12/05			S 7A25 A	
assembly KNECHT-MAHLE / montaggio KNECHT-MAHLE	DC11.08 Euro3	250	340	09/04	> 12/05			S 7970 A	
power steering / servosterzo	DC11.08 Euro3	250	340	09/04	> 12/05				S 3081 PO
Vehicles for building site with filter (1506545) / veicoli da cantiere con filtro (1506545)	DC11.08 Euro3	250	340	09/04	> 12/05			S 7A50 A	
T 380	DC11.09 Euro3	279	380	09/04	> 12/05	S 4402 R	S 4341 NR		S 3066 C
dryer filter / filtro essiccatore	DC11.09 Euro3	279	380	09/04	> 12/05				S 7F30 A
dryer filter WABCO / filtro essiccatore WABCO	DC11.09 Euro3	279	380	09/04	> 09/05				S 7344 A
retarder / freno di rallentamento	DC11.09 Euro3	279	380	09/04	> 12/05				S 5613 PO
assembly DONALDSON / montaggio DONALDSON	DC11.09 Euro3	279	380	09/04	> 12/05			S 7286 A	
DONALDSON assembly flame retardant media / montaggio DONALDSON media filtrante ritardante di fiamma	DC11.09 Euro3	279	380	09/04	> 12/05			S 7A25 A	
assembly KNECHT-MAHLE / montaggio KNECHT-MAHLE	DC11.09 Euro3	279	380	09/04	> 12/05			S 7970 A	
power steering / servosterzo	DC11.09 Euro3	279	380	09/04	> 12/05				S 3081 PO
Vehicles for building site with filter (1506545) / veicoli da cantiere con filtro (1506545)	DC11.09 Euro3	279	380	09/04	> 12/05			S 7A50 A	
T 420	DC12.14 Euro3	309	420	09/04	> 12/05	S 4402 R	S 4341 NR		S 3066 C
dryer filter WABCO / filtro essiccatore WABCO	DC12.14 Euro3	309	420	09/04	> 09/05				S 7344 A
retarder / freno di rallentamento	DC12.14 Euro3	309	420	09/04	> 12/05				S 5613 PO
assembly DONALDSON / montaggio DONALDSON	DC12.14 Euro3	309	420	09/04	> 12/05			S 7286 A	
DONALDSON assembly flame retardant media / montaggio DONALDSON media filtrante ritardante di fiamma	DC12.14 Euro3	309	420	09/04	> 12/05			S 7A25 A	
assembly KNECHT-MAHLE / montaggio KNECHT-MAHLE	DC12.14 Euro3	309	420	09/04	> 12/05			S 7970 A	
power steering / servosterzo	DC12.14 Euro3	309	420	09/04	> 12/05				S 3081 PO
Vehicles for building site with filter (1506545) / veicoli da cantiere con filtro (1506545)	DC12.14 Euro3	309	420	09/04	> 12/05			S 7A50 A	
T 420 HPI	DT12.12 Euro4	309	420	09/04	> 12/05	S 4402 R	S 6010 NE		S 3066 C
dryer filter / filtro essiccatore	DT12.12 Euro4	309	420	09/04	> 12/05				S 7F30 A
dryer filter WABCO / filtro essiccatore WABCO	DT12.12 Euro4	309	420	09/04	> 09/05				S 7344 A
retarder / freno di rallentamento	DT12.12 Euro4	309	420	09/04	> 12/05				S 5613 PO
assembly DONALDSON / montaggio DONALDSON	DT12.12 Euro4	309	420	09/04	> 12/05			S 7286 A	
DONALDSON assembly flame retardant media / montaggio DONALDSON media filtrante ritardante di fiamma	DT12.12 Euro4	309	420	09/04	> 12/05			S 7A25 A	

S



KW HP



...SCANIA - trucks/autocarri

S

assembly KNECHT-MAHLE / montaggio KNECHT-MAHLE	DT12.12 Euro4	309 420	09/04 > 12/05			S 7970 A	
power steering / servosterzo	DT12.12 Euro4	309 420	09/04 > 12/05				S 3081 PO
Vehicles for building site with filter (1506545) / veicoli da cantiere con filtro (1506545)	DT12.12 Euro4	309 420	09/04 > 12/05			S 7A50 A	
T 470 HPI	DT12.06 Euro3	346 470	09/04 > 12/05	S 4402 R	S 6010 NE		S 3066 C
dryer filter / filtro essiccatore	DT12.06 Euro3	346 470	09/04 > 12/05				S 7F30 A
dryer filter WABCO / filtro essiccatore WABCO	DT12.06 Euro3	346 470	09/04 > 09/05				S 7344 A
retarder / freno di rallentamento	DT12.06 Euro3	346 470	09/04 > 12/05				S 5613 PO
assembly DONALDSON / montaggio DONALDSON	DT12.06 Euro3	346 470	09/04 > 12/05			S 7286 A	
DONALDSON assembly flame retardant media / montaggio DONALDSON media filtrante ritardante di fiamma	DT12.06 Euro3	346 470	09/04 > 12/05			S 7A25 A	
assembly KNECHT-MAHLE / montaggio KNECHT-MAHLE	DT12.06 Euro3	346 470	09/04 > 12/05			S 7970 A	
power steering / servosterzo	DT12.06 Euro3	346 470	09/04 > 12/05				S 3081 PO
Vehicles for building site with filter (1506545) / veicoli da cantiere con filtro (1506545)	DT12.06 Euro3	346 470	09/04 > 12/05			S 7A50 A	
T 500	DC16.04 Euro3	368 500	09/04 > 12/05	S 5044 PE	S 6008 NE		S 3066 C
dryer filter / filtro essiccatore	DC16.04 Euro3	368 500	09/04 > 12/05				S 7F30 A
dryer filter WABCO / filtro essiccatore WABCO	DC16.04 Euro3	368 500	09/04 > 09/05				S 7344 A
retarder / freno di rallentamento	DC16.04 Euro3	368 500	09/04 > 12/05				S 5613 PO
assembly DONALDSON / montaggio DONALDSON	DC16.04 Euro3	368 500	09/04 > 12/05			S 7358 A	
DONALDSON assembly inner / montaggio DONALDSON interno	DC16.04 Euro3	368 500	09/04 > 12/05			S 7A44 A	
DONALDSON assembly flame retardant media / montaggio DONALDSON media filtrante ritardante di fiamma	DC16.04 Euro3	368 500	09/04 > 12/05			S 7A26 A	
assembly KNECHT-MAHLE / montaggio KNECHT-MAHLE	DC16.04 Euro3	368 500	09/04 > 12/05			S 7615 A	
power steering / servosterzo	DC16.04 Euro3	368 500	09/04 > 12/05				S 3081 PO
T 580	DC16.03 Euro3	426 580	09/04 > 12/05	S 5044 PE	S 6008 NE		S 3066 C
dryer filter / filtro essiccatore	DC16.03 Euro3	426 580	09/04 > 12/05				S 7F30 A
dryer filter WABCO / filtro essiccatore WABCO	DC16.03 Euro3	426 580	09/04 > 09/05				S 7344 A
retarder / freno di rallentamento	DC16.03 Euro3	426 580	09/04 > 12/05				S 5613 PO
assembly DONALDSON / montaggio DONALDSON	DC16.03 Euro3	426 580	09/04 > 12/05			S 7358 A	
DONALDSON assembly inner / montaggio DONALDSON interno	DC16.03 Euro3	426 580	09/04 > 12/05			S 7A44 A	
DONALDSON assembly flame retardant media / montaggio DONALDSON media filtrante ritardante di fiamma	DC16.03 Euro3	426 580	09/04 > 12/05			S 7A26 A	
assembly KNECHT-MAHLE / montaggio KNECHT-MAHLE	DC16.03 Euro3	426 580	09/04 > 12/05			S 7615 A	
power steering / servosterzo	DC16.03 Euro3	426 580	09/04 > 12/05				S 3081 PO

SEDDON ATKINSON

trucks/autocarri

13-4 Serie

13-4							
spin-on / avvitabile	Perkins 6.354		S 0420 R	S 7111 NC			
cartridge / immersione	Perkins 6.354		S 4380 PO	S 7111 NC			
or PERKINS / oppure PERKINS	Perkins 6.354		S 4380 PO	S 7112 NC			
or PERKINS / oppure PERKINS	Perkins 6.354		S 0420 R	S 7112 NC			
13-4							
some / alcuni	Rolls Royce 220 MKI/MKII			S 7111 NC	S 0150 A		
13-4							
some / alcuni	Rolls Royce 260 MKI/MKII			S 7111 NC	S 0150 A		
13-4 T6							
spin-on / avvitabile	Perkins T6.354		S 0420 R	S 7111 NC	S 0150 A		
cartridge / immersione	Perkins T6.354		S 4380 PO	S 7111 NC	S 0150 A		
or PERKINS / oppure PERKINS	Perkins T6.354		S 0420 R	S 7112 NC	S 0150 A		
or PERKINS / oppure PERKINS	Perkins T6.354		S 4380 PO	S 7112 NC	S 0150 A		
13-4-14							
spin-on / avvitabile	Perkins		S 0420 R	S 7111 NC			
cartridge / immersione	Perkins		S 4380 PO	S 7111 NC			
or PERKINS / oppure PERKINS	Perkins		S 0420 R	S 7112 NC			
or PERKINS / oppure PERKINS	Perkins		S 4380 PO	S 7112 NC			
13-4-16							
spin-on / avvitabile	Perkins		S 0420 R	S 7111 NC			
cartridge / immersione	Perkins		S 4380 PO	S 7111 NC			
or PERKINS / oppure PERKINS	Perkins		S 0420 R	S 7112 NC			
or PERKINS / oppure PERKINS	Perkins		S 4380 PO	S 7112 NC			

16-4 Serie

16-4	Perkins V8-605		S 4380 PO		S 0150 A		
16-4 V8							
spin-on / avvitabile	Perkins V8-510		S 0420 R		S 0150 A		
cartridge / immersione	Perkins V8-510		S 4380 PO		S 0150 A		
16-4 V8	Perkins V8-540		S 0420 R				

18-4 Serie

18-4							
spin-on / avvitabile	Perkins 6.354		S 0420 R	S 7111 NC			
cartridge / immersione	Perkins 6.354		S 4380 PO	S 7111 NC			



kW HP



...SEDDON ATKINSON - trucks/autocarri

or PERKINS / oppure PERKINS	Perkins 6.354		S 4380 PO	S 7112 NC		
or PERKINS / oppure PERKINS	Perkins 6.354		S 0420 R	S 7112 NC		
185 Serie						
185-4-354						
spin-on / avvitabile	Perkins		S 0420 R	S 7111 NC		
cartridge / immersione	Perkins		S 4380 PO	S 7111 NC		
or PERKINS / oppure PERKINS	Perkins		S 4380 PO	S 7112 NC		
or PERKINS / oppure PERKINS	Perkins		S 0420 R	S 7112 NC		
20-4 Serie						
20-4						
spin-on / avvitabile	Perkins 6.354		S 0420 R	S 7111 NC		
cartridge / immersione	Perkins 6.354		S 4380 PO	S 7111 NC		
or PERKINS / oppure PERKINS	Perkins 6.354		S 4380 PO	S 7112 NC		
or PERKINS / oppure PERKINS	Perkins 6.354		S 0420 R	S 7112 NC		
20-4						
some / alcuni	Rolls Royce 220 MKI/MKII			S 7111 NC	S 0150 A	
20-4						
some / alcuni	Rolls Royce 260 MKI/MKII			S 7111 NC	S 0150 A	
20-4 T6						
spin-on / avvitabile	Perkins T6.354		S 0420 R	S 7111 NC	S 0150 A	
cartridge / immersione	Perkins T6.354		S 4380 PO	S 7111 NC	S 0150 A	
or PERKINS / oppure PERKINS	Perkins T6.354		S 0420 R	S 7112 NC	S 0150 A	
or PERKINS / oppure PERKINS	Perkins T6.354		S 4380 PO	S 7112 NC	S 0150 A	
200 Serie						
Serie 200						
some / alcuni	IHC D 310			S 7111 NC		
	IHC D 310			S 7111 NC	S 8950 A	
Serie 200						
	IHC D 358		S 5800 R			
Serie 200						
	Perkins 6.354		S 9400 R	S 7111 NC	S 8950 A	
some / alcuni	Perkins 6.354		S 9400 R	S 7111 NC	S 0150 A	
heavy duty	Perkins 6.354		S 0420 R	S 7111 NC	S 8950 A	
or PERKINS / oppure PERKINS	Perkins 6.354		S 9400 R	S 7112 NC	S 8950 A	
201 Serie						
R14 P354						
heavy duty	Perkins 6.354		S 9400 R	S 7111 NC	S 8950 A	
	Perkins 6.354		S 0420 R	S 7111 NC	S 8950 A	
or PERKINS / oppure PERKINS	Perkins 6.354		S 9400 R	S 7112 NC	S 8950 A	
R16 N35B						
2nd passage / 2.passaggio	IHC D 358			S 8501 NR		
with BOSCH pump, 1st passage / con pompa BOSCH, 1.passaggio	IHC D 358		S 5800 R		S 0850 A	
with pump DELPHI / con pompa DELPHI	IHC D 358		S 5800 R	S 7111 NC	S 0850 A	
R17 N13						
2nd passage / 2.passaggio	IHC D 358			S 8501 NR		
some / alcuni	IHC D 358		S 5800 R		S 0850 A	
with BOSCH pump, 1st passage / con pompa BOSCH, 1.passaggio	IHC D 358		S 5800 R		S 8950 A	
with pump DELPHI / con pompa DELPHI	IHC D 358		S 5800 R	S 7111 NC	S 8950 A	
R17 P16						
assembly DELPHI / montaggio DELPHI	Perkins T6.354.4	01/83 > 05/86	S 0420 R	S 8111 NC	S 8950 A	
or DELPHI / oppure DELPHI	Perkins T6.354.4	01/83 > 05/86	S 0420 R	S 7111 NC	S 8950 A	
or PERKINS / oppure PERKINS	Perkins T6.354.4	01/83 > 05/86	S 0420 R	S 7112 NC	S 8950 A	
211 Serie						
R17 21P						
heavy duty	Perkins Phaser 210 Ti	03/90 > 09/92	S 9400 R	S 7111 NC		
	Perkins Phaser 210 Ti	03/90 > 09/92	S 0420 R	S 7111 NC		
or PERKINS / oppure PERKINS	Perkins Phaser 210 Ti	03/90 > 09/92	S 9400 R	S 7112 NC		
R17 P16						
	Perkins Phaser 160 Ti	05/86 > 06/90	S 9400 R	S 7111 NC	S 2370 A	
or PERKINS / oppure PERKINS	Perkins Phaser 160 Ti	05/86 > 06/90	S 9400 R	S 7112 NC	S 2370 A	
R17 P16						
	Perkins Phaser 180 Ti	05/86 > 06/90	S 9400 R	S 7111 NC	S 2370 A	
or PERKINS / oppure PERKINS	Perkins Phaser 180 Ti	05/86 > 06/90	S 9400 R	S 7112 NC	S 2370 A	
R17 P18						
	Perkins Phaser 160 Ti	05/86 > 06/90	S 9400 R	S 7111 NC	S 2370 A	
or PERKINS / oppure PERKINS	Perkins Phaser 160 Ti	05/86 > 06/90	S 9400 R	S 7112 NC	S 2370 A	
R17 P18						
	Perkins Phaser 180 Ti	05/86 > 06/90	S 9400 R	S 7111 NC	S 2370 A	
or PERKINS / oppure PERKINS	Perkins Phaser 180 Ti	05/86 > 06/90	S 9400 R	S 7112 NC	S 2370 A	
R17 P21						
heavy duty	Perkins Phaser 210 Ti	03/90 > 09/92	S 9400 R	S 7111 NC		
	Perkins Phaser 210 Ti	03/90 > 09/92	S 0420 R	S 7111 NC		
or PERKINS / oppure PERKINS	Perkins Phaser 210 Ti	03/90 > 09/92	S 9400 R	S 7112 NC		
24-4 Serie						
24-4 T6						
spin-on / avvitabile	Perkins T6.354		S 0420 R	S 7111 NC	S 0150 A	
cartridge / immersione	Perkins T6.354		S 4380 PO	S 7111 NC	S 0150 A	

S





kW HP



...SEDDON ATKINSON - trucks/autocarri

or PERKINS / oppure PERKINS	Perkins T6.354		S 4380 PO	S 7112 NC	S 0150 A	
or PERKINS / oppure PERKINS	Perkins T6.354		S 0420 R	S 7112 NC	S 0150 A	
26-4 Serie						
26-4	Perkins V8-605		S 4380 PO		S 0150 A	
26-4 V8						
spin-on / avvitabile	Perkins V8-510		S 0420 R		S 0150 A	
cartridge / immersione	Perkins V8-510		S 4380 PO		S 0150 A	
28-4 Serie						
28-4	Perkins V8-605		S 4380 PO		S 0150 A	
28-4 V8						
spin-on / avvitabile	Perkins V8-510		S 0420 R		S 0150 A	
cartridge / immersione	Perkins V8-510		S 4380 PO		S 0150 A	
300 Serie						
Serie 300	Cummins L10		S 3409 R			
some / alcuni	Cummins L10		S 3409 R	S 4510 NR		
Serie 300	IHC DT 466		S 5800 R			
some / alcuni	IHC DT 466		S 5800 R		S 6550 A	
301 Serie						
R24 L22	Cummins LT10-220	01/84 > 02/87	S 3409 R	S 4510 NR		
some / alcuni	Cummins LT10-220	01/84 > 02/87	S 3409 R	S 4510 NR	S 6550 A	
R24 L25	Cummins LT10-250	01/84 > 02/87	S 3409 R	S 4510 NR		
some / alcuni	Cummins LT10-250	01/84 > 02/87	S 3409 R	S 4510 NR	S 6550 A	
R24 M466	IHC DT 466		S 5800 R			
some / alcuni	IHC DT 466		S 5800 R		S 6550 A	
R30 L25	Cummins LT10-250	01/84 > 02/87	S 3409 R	S 4510 NR		
some / alcuni	Cummins LT10-250	01/84 > 02/87	S 3409 R	S 4510 NR	S 6550 A	
Serie 301	Cummins L10-250	> 12/83	S 3409 R	S 4510 NR		
some / alcuni	Cummins L10-250	> 12/83	S 3409 R	S 4510 NR	S 6550 A	
Serie 301	Gardner 6LXC	> 12/83			S 0150 A	
some / alcuni	Gardner 6LXC	> 12/83			S 0150 A	
Serie 301	Gardner 6LXCT	> 12/83	S 0900 R			
some / alcuni	Gardner 6LXCT	> 12/83	S 0900 R		S 0150 A	
T17 L25	Cummins LT10-250	10/82 > 02/87	S 3409 R	S 4510 NR		
some / alcuni	Cummins LT10-250	10/82 > 02/87	S 3409 R	S 4510 NR	S 6550 A	
T17 L29	Cummins LTA10-290	02/84 > 02/87	S 3409 R	S 4510 NR		
some / alcuni	Cummins LTA10-290	02/84 > 02/87	S 3409 R	S 4510 NR	S 6550 A	
T22 L29	Cummins LTA10-290	02/84 > 02/87	S 3409 R	S 4510 NR		
some / alcuni	Cummins LTA10-290	02/84 > 02/87	S 3409 R	S 4510 NR	S 6550 A	
T24 L29	Cummins LTA10-290	02/84 > 02/87	S 3409 R	S 4510 NR		
some / alcuni	Cummins LTA10-290	02/84 > 02/87	S 3409 R	S 4510 NR	S 6550 A	
311 Serie						
R24 L22	Cummins LT10-220		S 3409 R	S 4510 NR		
some / alcuni	Cummins LT10-220		S 3409 R	S 4510 NR	S 6550 A	
R24 L25	Cummins LT10-250		S 3409 R	S 4510 NR		
some / alcuni	Cummins LT10-250		S 3409 R	S 4510 NR	S 6550 A	
R30 L25	Cummins LT10-250	03/87 > 06/90	S 3409 R	S 4510 NR		
some / alcuni	Cummins LT10-250	03/87 > 06/90	S 3409 R	S 4510 NR	S 6550 A	
R30 L29	Cummins LTA10-290	03/87 > 06/90	S 3409 R	S 4510 NR		
some / alcuni	Cummins LTA10-290	03/87 > 06/90	S 3409 R	S 4510 NR	S 6550 A	
T17 L25	Cummins LT10-250	03/87 > 12/91	S 3409 R			
some / alcuni	Cummins LTA10-290	03/87 > 12/91	S 3409 R			
T17 L29	Cummins LTA10-290	03/87 > 12/91	S 3409 R	S 4510 NR		
some / alcuni	Cummins LTA10-290	03/87 > 12/91	S 3409 R	S 4510 NR		
T22 L29	Cummins LTA10-290	03/87 > 11/89	S 3409 R			
some / alcuni	Cummins LTA10-290	03/87 > 11/89	S 3409 R	S 4510 NR		
T24 L29	Cummins LTA10-290	03/87 > 06/90	S 3409 R	S 4510 NR		
some / alcuni	Cummins LTA10-290	03/87 > 06/90	S 3409 R	S 4510 NR	S 6550 A	
32-4 Serie						
32-4	Gardner 6LXB				S 0150 A	
some / alcuni	Gardner 6LXB				S 0150 A	
32-4	Perkins V8-605		S 4380 PO		S 0150 A	
some / alcuni	Perkins V8-605		S 4380 PO		S 0150 A	
32-4	Rolls Royce 220 MKI/MKII			S 7111 NC	S 0150 A	
some / alcuni	Rolls Royce 220 MKI/MKII			S 7111 NC	S 0150 A	
32-4 V8	Perkins V8-510		S 0420 R		S 0150 A	
spin-on / avvitabile	Perkins V8-510		S 0420 R		S 0150 A	
cartridge / immersione	Perkins V8-510		S 4380 PO		S 0150 A	



kW HP



...SEDDON ATKINSON - trucks/autocarri

34-4 Serie							
34-4	Cummins NH220			S 4510 NR	S 0150 A		
34-4	Gardner 6LXB				S 0150 A		
34-4	Rolls Royce 220 MKI/MKII			S 7111 NC	S 0150 A		
34-4	Rolls Royce 260 MKI/MKII			S 7111 NC	S 0150 A		
401 Serie							
R30 G23	Gardner 6LXCT	01/84 > 12/84	S 0900 R				
some / alcuni	Gardner 6LXCT	01/84 > 12/84	S 0900 R		S 6550 A		
R30 G26	Rolls Royce 265 Li	01/84 > 03/87			S 6550 A		
R30 G27	Gardner 6LXDT	01/85 > 03/87	S 0900 R				
Serie 401	Gardner 6LXCT	> 01/85	S 0900 R				
some / alcuni	Gardner 6LXCT	> 01/85	S 0900 R		S 6550 A		
Serie 401	Gardner 8LXCT	01/84 > 02/87	S 0900 R				
some / alcuni	Gardner 8LXCT	01/84 > 02/87	S 0900 R		S 6550 A		
Serie 401	Rolls Royce 265 Li	> 02/84			S 6550 A		
some / alcuni	Rolls Royce 290 L	> 01/84		S 7111 NC	S 6550 A		
T17 C25	Cummins NTC 250	01/84 > 08/84	S 3409 R	S 4510 NR			
some / alcuni	Cummins NTC 250	01/84 > 08/84	S 3409 R	S 4510 NR	S 6550 A		
T17 C29	Cummins NTE 290	01/84 > 02/87	S 3409 R	S 4510 NR			
some / alcuni	Cummins NTE 290	01/84 > 02/87	S 3409 R	S 4510 NR	S 6550 A		
T17 C32	Cummins NTE 320	02/84 > 02/87	S 3409 R	S 4510 NR			
some / alcuni	Cummins NTE 320	02/84 > 02/87	S 3409 R	S 4510 NR	S 6550 A		
T17 G32	Gardner 6LYT	05/85 > 02/87	S 0900 R				
some / alcuni	Gardner 6LYT	05/85 > 02/87	S 0900 R		S 6550 A		
T17 L25	Cummins LT10-250	01/83 >	S 3409 R				
some / alcuni	Cummins LT10-250	01/83 >	S 3409 R	S 4510 NR			
T17 L29	Cummins LTA10-290	03/84 >	S 3409 R				
some / alcuni	Cummins LTA10-290	03/84 >	S 3409 R	S 4510 NR			
T17 R34	Rolls Royce 340 i	09/84 > 02/87			S 6550 A		
some / alcuni	Rolls Royce 340 i	09/84 > 02/87					S 8790 PO
T19 R30	Rolls Royce 300 Li			S 7111 NC	S 6550 A		
some / alcuni	Rolls Royce 300 Li						S 8790 PO
T22 C32	Cummins Super NTE 320		S 3409 R	S 4510 NR			
some / alcuni	Cummins Super NTE 320		S 3409 R	S 4510 NR	S 6550 A		
411 Serie							
T12 C32	Cummins Super E 320	03/87 > 12/88	S 3409 R	S 4510 NR			
some / alcuni	Cummins Super E 320	03/87 > 12/88	S 3409 R	S 4510 NR	S 6550 A		
T17 G32	Gardner 6LYT	03/87 > 01/88	S 0900 R				
some / alcuni	Gardner 6LYT	03/87 > 01/88	S 0900 R		S 6550 A		
T17 R30	Rolls Royce 300 Li	03/87 > 09/88		S 7111 NC	S 6550 A		
some / alcuni	Rolls Royce 300 Li	03/87 > 09/88					S 8790 PO
T17 R34	Rolls Royce 340 Li	03/87 > 09/88			S 6550 A		
some / alcuni	Rolls Royce 340 Li	03/87 > 09/88					S 8790 PO
T22 C32	Cummins Super E 320	03/87 > 01/89	S 3409 R	S 4510 NR			
some / alcuni	Cummins Super E 320	03/87 > 01/89	S 3409 R	S 4510 NR	S 6550 A		
T22 G32	Gardner 6 LYT	03/87 > 12/89	S 0900 R				
some / alcuni	Gardner 6 LYT	03/87 > 12/89	S 0900 R		S 6550 A		
T22 R34	Rolls Royce 340 Li	03/87 > 12/89		S 7111 NC	S 6550 A		
some / alcuni	Rolls Royce 340 Li	03/87 > 12/89					S 8790 PO
T24 C32	Cummins Super E 320	03/87 > 01/89	S 3409 R	S 4510 NR			
some / alcuni	Cummins Super E 320	03/87 > 01/89	S 3409 R	S 4510 NR	S 6550 A		
T24 G32	Gardner 6 LYT	03/87 > 12/89	S 0900 R				
some / alcuni	Gardner 6 LYT	03/87 > 12/89	S 0900 R		S 6550 A		
T24 R34	Rolls Royce 340 Li	03/87 > 09/88		S 7111 NC	S 6550 A		
some / alcuni	Rolls Royce 340 Li	03/87 > 09/88					S 8790 PO

S





KW HP



...SEDDON ATKINSON - trucks/autocarri

S

DD6 Serie

20 DD6 V8

spin-on / avvitabile
cartridge / immersione

Perkins V8-510

Perkins V8-510

S 0420 R

S 4380 PO

S 8950 A

S 8950 A

22 DD6 V8

spin-on / avvitabile
cartridge / immersione

Perkins V8-510

Perkins V8-510

S 0420 R

S 4380 PO

S 8950 A

S 8950 A

24 DD6 V8

spin-on / avvitabile
cartridge / immersione

Perkins V8-510

Perkins V8-510

S 0420 R

S 4380 PO

S 8950 A

S 8950 A

Strato

17.30L

some / alcuni

Cummins LTAA10-300

Cummins LTAA10-300

10/86 > 06/90

10/86 > 06/90

S 3409 R

S 3409 R

S 4510 NR

17.32C

some / alcuni

Cummins Super E 320

Cummins Super E 320

08/88 >

08/88 >

S 3409 R

S 3409 R

S 4510 NR

17.33L

some / alcuni

Cummins LTAA 10-325

Cummins LTAA 10-325

10/88 >

10/88 >

S 3409 R

S 3409 R

S 4510 NR

17.35C

some / alcuni

Cummins Super E 320

Cummins Super E 320

08/88 >

08/88 >

S 3409 R

S 3409 R

S 4510 NR

17.37C

some / alcuni

Cummins Super E 365

Cummins Super E 365

09/89 > 12/91

09/89 > 12/91

S 3409 R

S 3409 R

S 4510 NR

17.38C

some / alcuni

Cummins Super E 365

Cummins Super E 365

09/89 > 12/91

09/89 > 12/91

S 3409 R

S 3409 R

S 4510 NR

17.40C

some / alcuni

Cummins NTAA 380

Cummins Super E 400

01/93 >

08/88 > 06/90

S 4510 NR

S 3409 R

S 4510 NR

17.41C

some / alcuni

Cummins Super E 400

Cummins Super E 400

08/88 > 06/90

08/88 > 06/90

S 3409 R

S 3409 R

S 4510 NR

17.47C

some / alcuni

Cummins NTAA 410

Cummins NTAA 465

01/92 >

07/90 >

S 4510 NR

S 4510 NR

S 4510 NR

210 P17

heavy duty
or PERKINS / oppure PERKINS

Perkins Phaser 210 Ti

Perkins Phaser 210 Ti

Perkins Phaser 210 Ti

10/92 >

10/92 >

10/92 >

S 9400 R

S 0420 R

S 9400 R

S 7111 NC

S 7111 NC

S 7112 NC

22.32C

some / alcuni

Cummins Super E 320

Cummins Super E 320

08/88 >

08/88 >

S 3409 R

S 3409 R

S 4510 NR

22.33L

some / alcuni

Cummins Super E 320

Cummins LTAA 10-325

08/88 >

10/88 >

S 3409 R

S 3409 R

S 4510 NR

22.37C

some / alcuni

Cummins LTAA 10-325

Cummins Super E 365

10/88 >

09/89 > 12/91

S 3409 R

S 3409 R

S 4510 NR

22.38C

some / alcuni

Cummins Super E 365

Cummins Super E 365

09/89 > 12/91

09/89 > 12/91

S 3409 R

S 3409 R

S 4510 NR

22.38C

some / alcuni

Cummins NTAA 380

Cummins Super E 400

01/93 >

S 3409 R

S 4510 NR

S 3409 R

S 4510 NR

22.40C

some / alcuni

Cummins NTAA 410

Cummins Super E 400

01/92 >

S 3409 R

S 4510 NR

S 3409 R

S 4510 NR

22.41C

some / alcuni

Cummins NTAA 465

Cummins NTAA 465

06/90 >

06/90 >

S 3409 R

S 3409 R

S 4510 NR

TC17.28L

some / alcuni

Cummins NTAA 465

Cummins LTA10-275

06/90 >

07/90 >

S 3409 R

S 3409 R

S 4510 NR

TC17.32C

some / alcuni

Cummins LTA10-275

Cummins Super E 320

07/90 >

08/88 >

S 3409 R

S 3409 R

S 4510 NR

TC17.33L

some / alcuni

Cummins Super E 320

Cummins LTAA 10-325

08/88 >

10/88 >

S 3409 R

S 3409 R

S 4510 NR

TC17.37C

some / alcuni

Cummins LTAA 10-325

Cummins Super E 365

10/88 >

09/89 > 12/91

S 3409 R

S 3409 R

S 4510 NR

TC17.38

some / alcuni

Cummins Super E 365

Cummins Super E 365

09/89 > 12/91

09/89 > 12/91

S 3409 R

S 3409 R

S 4510 NR

TC17.41C

some / alcuni

Cummins NTAA 380

Cummins NTAA 410

01/93 >

01/92 >

S 4510 NR

S 4510 NR

S 4510 NR

TC22.32C

some / alcuni

Cummins NTAA 410

Cummins Super E 320

01/92 >

08/88 >

S 4510 NR

S 3409 R

S 4510 NR

TC22.33L

some / alcuni

Cummins Super E 320

Cummins Super E 320

08/88 >

08/88 >

S 3409 R

S 3409 R

S 4510 NR

TC22.37C

some / alcuni

Cummins LTAA 10-325

Cummins LTAA 10-325

10/88 >

10/88 >

S 3409 R

S 3409 R

S 4510 NR

TC22.38C

some / alcuni

Cummins Super E 365

Cummins Super E 365

09/89 > 12/91

09/89 > 12/91

S 3409 R

S 3409 R

S 4510 NR

TC22.41C

some / alcuni

Cummins Super E 365

Cummins NTAA 380

09/89 > 12/91

01/93 >

S 3409 R

S 4510 NR

S 4510 NR



kW HP



...SEDDON ATKINSON - trucks/autocarri

some / alcuni	Cummins NTAA 410	01/92 >		S 4510 NR		
Troner						
1236.38 TX						
assembly DELPHI / montaggio DELPHI	Pegaso	03/90 >	S 1220 R	S 8111 NC		
or DELPHI / oppure DELPHI	Pegaso	03/90 >	S 1220 R	S 7111 NC		
SEDDON ATKINSON				buses/autobus		
Middy Serie						
Middy Bus	Perkins 4.236		S 9400 R	S 7111 NC	S 8950 A	
heavy duty	Perkins 4.236		S 0420 R	S 7111 NC	S 8950 A	
cartridge / immersione	Perkins 4.236		S 3180 PO	S 7111 NC	S 8950 A	
or PERKINS / oppure PERKINS	Perkins 4.236		S 9400 R	S 7112 NC	S 8950 A	
Pennine Serie						
Pennine 4	Perkins 6.354	> 12/74	S 4380 PO	S 7111 NC	S 8950 A	
	Perkins 6.354	01/75 >	S 0420 R	S 7111 NC	S 8950 A	
or PERKINS / oppure PERKINS	Perkins 6.354	> 12/74	S 4380 PO	S 7112 NC	S 8950 A	
or PERKINS / oppure PERKINS	Perkins 6.354	01/75 >	S 0420 R	S 7112 NC	S 8950 A	
Pennine 4	Perkins V8-510	> 12/74	S 4380 PO		S 8950 A	
	Perkins V8-510	01/75 >	S 0420 R		S 8950 A	
Pennine 5	Perkins 6.354	> 12/74	S 4380 PO	S 7111 NC	S 8950 A	
	Perkins 6.354	01/75 >	S 0420 R	S 7111 NC	S 8950 A	
or PERKINS / oppure PERKINS	Perkins 6.354	> 12/74	S 4380 PO	S 7112 NC	S 8950 A	
or PERKINS / oppure PERKINS	Perkins 6.354	01/75 >	S 0420 R	S 7112 NC	S 8950 A	
Pennine 5	Perkins V8-510	> 12/74	S 4380 PO		S 8950 A	
	Perkins V8-510	01/75 >	S 0420 R		S 8950 A	
Pennine 6	Perkins T6.354		S 0420 R	S 7111 NC	S 8950 A	
some / alcuni	Perkins T6.354		S 0420 R	S 7111 NC	S 0060 A	
or PERKINS / oppure PERKINS	Perkins T6.354		S 0420 R	S 7112 NC	S 0060 A	
Pennine 7	Gardner 6LXB				S 0150 A	
Pennine 7U	Gardner 6LXB				S 0150 A	
T 38 Serie						
T 38 4x4	Cummins NTC 335			S 4510 NR		
full-flow	Cummins NTC 335		S 3409 R			
SISU AUTO				trucks/autocarri		
R Serie						
R400 (400-310)	Renault DCI 11-320 229 311	03/05 >			S 7643 A	S 3217 C
with automatic gearbox / con cambio automatico	Renault DCI 11-320 229 311	03/05 >				S 5238 PE
dryer filter WABCO, right-hand thread / filtro essiccatore WABCO, filetto destro	Renault DCI 11-320 229 311	03/05 >				S 7A66 A
inner / interno	Renault DCI 11-320 229 311	03/05 >			S 7406 A	
2 filters / N.2 filtri	Renault DCI 11-320 229 311	03/05 >	S 0900 R	S 0712 NR		
rotor for oil centrifuge / rotore per filtro olio centrifugo	Renault DCI 11-320 229 311	03/05 >	S 5903 PO			
dusty areas / zone polverose	Renault DCI 11-320 229 311	03/05 >			S 7284 A	
dusty areas inner / zone polverose interno	Renault DCI 11-320 229 311	03/05 >			S 7404 A	
R400 (400-360)	Renault DCI 11-370 266 361	03/05 >			S 7643 A	S 3217 C
with automatic gearbox / con cambio automatico	Renault DCI 11-370 266 361	03/05 >				S 5238 PE
dryer filter WABCO, right-hand thread / filtro essiccatore WABCO, filetto destro	Renault DCI 11-370 266 361	03/05 >				S 7A66 A
inner / interno	Renault DCI 11-370 266 361	03/05 >			S 7406 A	
2 filters / N.2 filtri	Renault DCI 11-370 266 361	03/05 >	S 0900 R	S 0712 NR		
rotor for oil centrifuge / rotore per filtro olio centrifugo	Renault DCI 11-370 266 361	03/05 >	S 5903 PO			
dusty areas / zone polverose	Renault DCI 11-370 266 361	03/05 >			S 7284 A	
dusty areas inner / zone polverose interno	Renault DCI 11-370 266 361	03/05 >			S 7404 A	
R400 (400-420)	Renault DCI 11B 303 412	03/05 >			S 7643 A	S 3217 C
with automatic gearbox / con cambio automatico	Renault DCI 11B 303 412	03/05 >				S 5238 PE
dryer filter WABCO, right-hand thread / filtro essiccatore WABCO, filetto destro	Renault DCI 11B 303 412	03/05 >				S 7A66 A
inner / interno	Renault DCI 11B 303 412	03/05 >			S 7406 A	
2 filters / N.2 filtri	Renault DCI 11B 303 412	03/05 >	S 0900 R	S 0712 NR		
rotor for oil centrifuge / rotore per filtro olio centrifugo	Renault DCI 11B 303 412	03/05 >	S 5903 PO			
dusty areas / zone polverose	Renault DCI 11B 303 412	03/05 >			S 7284 A	
dusty areas inner / zone polverose interno	Renault DCI 11B 303 412	03/05 >			S 7404 A	
R460 (500-460)	Renault DXi 13 338 460	10/06 >		S 9320 NR	S 7643 A	
by-pass	Renault DXi 13 338 460	10/06 >	S 4120 R			
with automatic gearbox / con cambio automatico	Renault DXi 13 338 460	10/06 >				S 5238 PE
with gearbox ZF Ecosplit + Intarder / con cambio ZF Ecosplit + Intarder	Renault DXi 13 338 460	10/06 >				S 2234 Z
with filter Urea/Adblue / con filtro Urea/Adblue	Renault DXi 13 338 460	10/06 >				S 4402 U
inner / interno	Renault DXi 13 338 460	10/06 >			S 7406 A	
LONG LIFE	Renault DXi 13 338 460	10/06 >		S 4120 NR		

S





...SISU AUTO - trucks/autocarri

S

2 filters / N.2 filtri	Renault DXi 13	338	460	10/06	>	S 4402 R			
prefilter short filter / prefiltro filtro corto	Renault DXi 13	338	460	10/06	>		S 4461 NR		
prefilter long filter / prefiltro filtro lungo	Renault DXi 13	338	460	10/06	>		S 4146 NR		
power steering / servosterzo	Renault DXi 13	338	460	10/06	>				S 3081 PO
R500 (500-440)	Renault DXi 12	324	440	03/06	>		S 9320 NR	S 7643 A	
by-pass	Renault DXi 12	324	440	03/06	>	S 4120 R			
with automatic gearbox / con cambio automatico	Renault DXi 12	324	440	03/06	>				S 5238 PE
with filter Urea/Adblue / con filtro Urea/Adblue	Renault DXi 12	324	440	03/06	>				S 4402 U
inner / interno	Renault DXi 12	324	440	03/06	>			S 7406 A	
LONG LIFE	Renault DXi 12	324	440	03/06	>		S 4120 NR		
2 filters / N.2 filtri	Renault DXi 12	324	440	03/06	>	S 4402 R			
prefilter / prefiltro	Renault DXi 12	324	440	03/06	>		S 4461 NR		
power steering / servosterzo	Renault DXi 12	324	440	03/06	>				S 3081 PO
R500 (500-480)	Renault DXi 12	353	480	03/06	>		S 9320 NR	S 7643 A	
by-pass	Renault DXi 12	353	480	03/06	>	S 4120 R			
with automatic gearbox / con cambio automatico	Renault DXi 12	353	480	03/06	>				S 5238 PE
with filter Urea/Adblue / con filtro Urea/Adblue	Renault DXi 12	353	480	03/06	>				S 4402 U
inner / interno	Renault DXi 12	353	480	03/06	>			S 7406 A	
LONG LIFE	Renault DXi 12	353	480	03/06	>		S 4120 NR		
2 filters / N.2 filtri	Renault DXi 12	353	480	03/06	>	S 4402 R			
prefilter / prefiltro	Renault DXi 12	353	480	03/06	>		S 4461 NR		
power steering / servosterzo	Renault DXi 12	353	480	03/06	>				S 3081 PO
R500 (500-500)	Renault DXi 13	368	500	10/06	>		S 9320 NR	S 7643 A	
by-pass	Renault DXi 13	368	500	10/06	>	S 4120 R			
with automatic gearbox / con cambio automatico	Renault DXi 13	368	500	10/06	>				S 5238 PE
with gearbox ZF Ecosplit + Intarder / con cambio ZF Ecosplit + Intarder	Renault DXi 13	368	500	10/06	>				S 2234 Z
with filter Urea/Adblue / con filtro Urea/Adblue	Renault DXi 13	368	500	10/06	>				S 4402 U
inner / interno	Renault DXi 13	368	500	10/06	>			S 7406 A	
LONG LIFE	Renault DXi 13	368	500	10/06	>		S 4120 NR		
2 filters / N.2 filtri	Renault DXi 13	368	500	10/06	>	S 4402 R			
prefilter short filter / prefiltro filtro corto	Renault DXi 13	368	500	10/06	>		S 4461 NR		
prefilter long filter / prefiltro filtro lungo	Renault DXi 13	368	500	10/06	>		S 4146 NR		
power steering / servosterzo	Renault DXi 13	368	500	10/06	>				S 3081 PO

Rock

480	Mercedes Benz OM501LA	350	480	03/11	>	S 5006 PE	S 6001 NE		S 3072 C
with activated carbons / ai carboni attivi	Mercedes Benz OM501LA	350	480	03/11	>				S 4225 CA
dryer filter / filtro essiccatore	Mercedes Benz OM501LA	350	480	03/11	>				S 7A66 A
assembly KNECHT-MAHLE / montaggio KNECHT-MAHLE	Mercedes Benz OM501LA	350	480	03/11	>			S 7639 A	
assembly MANN+HUMMEL / montaggio MANN+HUMMEL	Mercedes Benz OM501LA	350	480	03/11	>			S 7A12 A	
power steering / servosterzo	Mercedes Benz OM501LA	350	480	03/11	>				S 3081 PO
dusty areas / zone polverose	Mercedes Benz OM501LA	350	480	03/11	>				S 3221 C
550	Mercedes Benz OM502LA	405	550	03/11	>	S 5006 PE	S 6001 NE		S 3072 C
with activated carbons / ai carboni attivi	Mercedes Benz OM502LA	405	550	03/11	>				S 4225 CA
dryer filter / filtro essiccatore	Mercedes Benz OM502LA	405	550	03/11	>				S 7A66 A
assembly KNECHT-MAHLE / montaggio KNECHT-MAHLE	Mercedes Benz OM502LA	405	550	03/11	>			S 7639 A	
assembly MANN+HUMMEL / montaggio MANN+HUMMEL	Mercedes Benz OM502LA	405	550	03/11	>			S 7A12 A	
power steering / servosterzo	Mercedes Benz OM502LA	405	550	03/11	>				S 3081 PO
dusty areas / zone polverose	Mercedes Benz OM502LA	405	550	03/11	>				S 3221 C
600	Mercedes Benz OM502LA	440	600	03/11	>	S 5006 PE	S 6001 NE		S 3072 C
with activated carbons / ai carboni attivi	Mercedes Benz OM502LA	440	600	03/11	>				S 4225 CA
dryer filter / filtro essiccatore	Mercedes Benz OM502LA	440	600	03/11	>				S 7A66 A
assembly KNECHT-MAHLE / montaggio KNECHT-MAHLE	Mercedes Benz OM502LA	440	600	03/11	>			S 7639 A	
assembly MANN+HUMMEL / montaggio MANN+HUMMEL	Mercedes Benz OM502LA	440	600	03/11	>			S 7A12 A	
power steering / servosterzo	Mercedes Benz OM502LA	440	600	03/11	>				S 3081 PO
dusty areas / zone polverose	Mercedes Benz OM502LA	440	600	03/11	>				S 3221 C

Timber

480	Mercedes Benz OM501LA	350	480	03/11	>	S 5006 PE	S 6001 NE		S 3072 C
with activated carbons / ai carboni attivi	Mercedes Benz OM501LA	350	480	03/11	>				S 4225 CA
dryer filter / filtro essiccatore	Mercedes Benz OM501LA	350	480	03/11	>				S 7A66 A
assembly KNECHT-MAHLE / montaggio KNECHT-MAHLE	Mercedes Benz OM501LA	350	480	03/11	>			S 7639 A	
assembly MANN+HUMMEL / montaggio MANN+HUMMEL	Mercedes Benz OM501LA	350	480	03/11	>			S 7A12 A	
power steering / servosterzo	Mercedes Benz OM501LA	350	480	03/11	>				S 3081 PO
dusty areas / zone polverose	Mercedes Benz OM501LA	350	480	03/11	>				S 3221 C
550	Mercedes Benz OM502LA	405	550	03/11	>	S 5006 PE	S 6001 NE		S 3072 C
with activated carbons / ai carboni attivi	Mercedes Benz OM502LA	405	550	03/11	>				S 4225 CA
dryer filter / filtro essiccatore	Mercedes Benz OM502LA	405	550	03/11	>				S 7A66 A
assembly KNECHT-MAHLE / montaggio KNECHT-MAHLE	Mercedes Benz OM502LA	405	550	03/11	>			S 7639 A	



KW HP



...SISU AUTO - trucks/autocarri

assembly MANN+HUMMEL / montaggio MANN+HUMMEL	Mercedes Benz OM502LA	405	550	03/11	>			S 7A12 A	
power steering / servosterzo	Mercedes Benz OM502LA	405	550	03/11	>				S 3081 PO
dusty areas / zone polverose	Mercedes Benz OM502LA	405	550	03/11	>				S 3221 C
600	Mercedes Benz OM502LA	440	600	03/11	>	S 5006 PE	S 6001 NE		S 3072 C
with activated carbons / ai carboni attivi	Mercedes Benz OM502LA	440	600	03/11	>				S 4225 CA
dryer filter / filtro essiccatore	Mercedes Benz OM502LA	440	600	03/11	>				S 7A66 A
assembly KNECHT-MAHLE / montaggio KNECHT-MAHLE	Mercedes Benz OM502LA	440	600	03/11	>			S 7639 A	
assembly MANN+HUMMEL / montaggio MANN+HUMMEL	Mercedes Benz OM502LA	440	600	03/11	>			S 7A12 A	
power steering / servosterzo	Mercedes Benz OM502LA	440	600	03/11	>				S 3081 PO
dusty areas / zone polverose	Mercedes Benz OM502LA	440	600	03/11	>				S 3221 C

SOLARIS

buses/autobus

Alpino

8.6	Cummins ISBe4	178	242	10/06	>		S 2220 NR		
spheros aeroshere world / con climatizzatore sul tetto	Cummins ISBe4	178	242	10/06	>				S 3440 C
with filter Urea/Adblue / con filtro Urea/Adblue	Cummins ISBe4	178	242	10/06	>				S 4401 U
power steering / servosterzo	Cummins ISBe4	178	242	10/06	>				S 3081 PO

Urbino

U 10	Cummins ISBe4-250B	184	250	09/07	>		S 2220 NR		
with automatic gearbox ZF HP590/592 / con cambio automatico ZF HP590/592	Cummins ISBe4-250B	184	250	09/07	>				S 2234 Z
spheros aeroshere world / con climatizzatore sul tetto	Cummins ISBe4-250B	184	250	09/07	>				S 3440 C
spheros aeroshere world KONVEKTA / con climatizzatore sul tetto KONVEKTA	Cummins ISBe4-250B	184	250	09/07	>				S 3458 C
spheros aeroshere world SPHEROS / con climatizzatore sul tetto SPHEROS	Cummins ISBe4-250B	184	250	09/07	>				S 3457 C
with filter Urea/Adblue / con filtro Urea/Adblue	Cummins ISBe4-250B	184	250	09/07	>				S 4401 U
power steering / servosterzo	Cummins ISBe4-250B	184	250	09/07	>				S 3081 PO
U 12	MAN D0824LOH17	162	221	01/99	>	S 3292 R	S 4378 NR	S 7187 A	
with automatic gearbox ZF HP590/592 / con cambio automatico ZF HP590/592	MAN D0824LOH17	162	221	01/99	>				S 2234 Z
spheros aeroshere world / con climatizzatore sul tetto	MAN D0824LOH17	162	221	01/99	>				S 3440 C
spheros aeroshere world KONVEKTA / con climatizzatore sul tetto KONVEKTA	MAN D0824LOH17	162	221	01/99	>				S 3458 C
spheros aeroshere world SPHEROS / con climatizzatore sul tetto SPHEROS	MAN D0824LOH17	162	221	01/99	>				S 3457 C
dryer filter / filtro essiccatore	MAN D0824LOH17	162	221	01/99	>				S 7259 A
power steering / servosterzo	MAN D0824LOH17	162	221	01/99	>				S 3081 PO
U 12	MAN D0826LOH18	191	260	01/99	>	S 3292 R	S 4378 NR	S 7187 A	
with automatic gearbox ZF HP590/592 / con cambio automatico ZF HP590/592	MAN D0826LOH18	191	260	01/99	>				S 2234 Z
spheros aeroshere world / con climatizzatore sul tetto	MAN D0826LOH18	191	260	01/99	>				S 3440 C
spheros aeroshere world KONVEKTA / con climatizzatore sul tetto KONVEKTA	MAN D0826LOH18	191	260	01/99	>				S 3458 C
spheros aeroshere world SPHEROS / con climatizzatore sul tetto SPHEROS	MAN D0826LOH18	191	260	01/99	>				S 3457 C
dryer filter / filtro essiccatore	MAN D0826LOH18	191	260	01/99	>				S 7259 A
power steering / servosterzo	MAN D0826LOH18	191	260	01/99	>				S 3081 PO
U 12 LE	DAF PR183 Euro5-EEV	183	250	09/06	>	S 5045 PE	S 6024 NE		
with automatic gearbox ZF HP590/592 / con cambio automatico ZF HP590/592	DAF PR183 Euro5-EEV	183	250	09/06	>				S 2234 Z
spheros aeroshere world / con climatizzatore sul tetto	DAF PR183 Euro5-EEV	183	250	09/06	>				S 3440 C
spheros aeroshere world KONVEKTA / con climatizzatore sul tetto KONVEKTA	DAF PR183 Euro5-EEV	183	250	09/06	>				S 3458 C
spheros aeroshere world SPHEROS / con climatizzatore sul tetto SPHEROS	DAF PR183 Euro5-EEV	183	250	09/06	>				S 3457 C
with filter Urea/Adblue / con filtro Urea/Adblue	DAF PR183 Euro5-EEV	183	250	09/06	>				S 4401 U
dryer filter / filtro essiccatore	DAF PR183 Euro5-EEV	183	250	09/06	>				S 7259 A
LONG LIFE	DAF PR183 Euro5-EEV	183	250	09/06	>	S 5234 PE			
power steering / servosterzo	DAF PR183 Euro5-EEV	183	250	09/06	>				S 3081 PO
U 12 LE III	DAF PE183C	188	255	01/03	>	S 5045 PE	S 6009 NE		
with automatic gearbox ZF HP590/592 / con cambio automatico ZF HP590/592	DAF PE183C	188	255	01/03	>				S 2234 Z
spheros aeroshere world / con climatizzatore sul tetto	DAF PE183C	188	255	01/03	>				S 3440 C
spheros aeroshere world KONVEKTA / con climatizzatore sul tetto KONVEKTA	DAF PE183C	188	255	01/03	>				S 3458 C
spheros aeroshere world SPHEROS / con climatizzatore sul tetto SPHEROS	DAF PE183C	188	255	01/03	>				S 3457 C
with filter H. 250 mm / con filtro H. 250 mm	DAF PE183C	188	255	01/03	>		S 6146 NE		
dryer filter / filtro essiccatore	DAF PE183C	188	255	01/03	>				S 7259 A
LONG LIFE H. 220 mm	DAF PE183C	188	255	01/03	>	S 5234 PE			
power steering / servosterzo	DAF PE183C	188	255	01/03	>				S 3081 PO
U 15	DAF PR228S Euro4	228	310	10/06	>		S 6024 NE		
with automatic gearbox ZF HP590/592 / con cambio automatico ZF HP590/592	DAF PR228S Euro4	228	310	10/06	>				S 2234 Z
spheros aeroshere world / con climatizzatore sul tetto	DAF PR228S Euro4	228	310	10/06	>				S 3440 C
spheros aeroshere world KONVEKTA / con climatizzatore sul tetto KONVEKTA	DAF PR228S Euro4	228	310	10/06	>				S 3458 C
spheros aeroshere world SPHEROS / con climatizzatore sul tetto SPHEROS	DAF PR228S Euro4	228	310	10/06	>				S 3457 C
with filter H. 150 mm / con filtro H. 150 mm	DAF PR228S Euro4	228	310	10/06	>	S 5045 PE			
with filter Urea/Adblue / con filtro Urea/Adblue	DAF PR228S Euro4	228	310	10/06	>				S 4401 U
LONG LIFE H. 220 mm	DAF PR228S Euro4	228	310	10/06	>	S 5234 PE			
power steering / servosterzo	DAF PR228S Euro4	228	310	10/06	>				S 3081 PO
U 15	DAF PR250S Euro4	250	340	10/06	>		S 6024 NE		

S



**KW HP****...SOLARIS - buses/autobus****S**

with automatic gearbox ZF HP590/592 / con cambio automatico ZF HP590/592	DAF PR250S Euro4	250	340	10/06	>				S 2234 Z
spheros aeroshere world / con climatizzatore sul tetto	DAF PR250S Euro4	250	340	10/06	>				S 3440 C
spheros aeroshere world KONVEKTA / con climatizzatore sul tetto KONVEKTA	DAF PR250S Euro4	250	340	10/06	>				S 3458 C
spheros aeroshere world SPHEROS / con climatizzatore sul tetto SPHEROS	DAF PR250S Euro4	250	340	10/06	>				S 3457 C
with filter H. 150 mm / con filtro H. 150 mm	DAF PR250S Euro4	250	340	10/06	>		S 5045 PE		
with filter Urea/Adblue / con filtro Urea/Adblue	DAF PR250S Euro4	250	340	10/06	>				S 4401 U
LONG LIFE H. 220 mm	DAF PR250S Euro4	250	340	10/06	>		S 5234 PE		
power steering / servosterzo	DAF PR250S Euro4	250	340	10/06	>				S 3081 PO
U 15	DAF PR265S Euro4	265	360	10/06	>			S 6024 NE	
with automatic gearbox ZF HP590/592 / con cambio automatico ZF HP590/592	DAF PR265S Euro4	265	360	10/06	>				S 2234 Z
spheros aeroshere world / con climatizzatore sul tetto	DAF PR265S Euro4	265	360	10/06	>				S 3440 C
spheros aeroshere world SPHEROS / con climatizzatore sul tetto SPHEROS	DAF PR265S Euro4	265	360	10/06	>				S 3457 C
with filter H. 150 mm / con filtro H. 150 mm	DAF PR265S Euro4	265	360	10/06	>		S 5045 PE		
with filter Urea/Adblue / con filtro Urea/Adblue	DAF PR265S Euro4	265	360	10/06	>				S 4401 U
LONG LIFE H. 220 mm	DAF PR265S Euro4	265	360	10/06	>		S 5234 PE		
power steering / servosterzo	DAF PR265S Euro4	265	360	10/06	>				S 3081 PO
U 15	MAN D0826LOH18	191	260	01/99	>		S 3292 R	S 4378 NR	S 7187 A
with automatic gearbox ZF HP590/592 / con cambio automatico ZF HP590/592	MAN D0826LOH18	191	260	01/99	>				S 2234 Z
spheros aeroshere world / con climatizzatore sul tetto	MAN D0826LOH18	191	260	01/99	>				S 3440 C
spheros aeroshere world KONVEKTA / con climatizzatore sul tetto KONVEKTA	MAN D0826LOH18	191	260	01/99	>				S 3458 C
spheros aeroshere world SPHEROS / con climatizzatore sul tetto SPHEROS	MAN D0826LOH18	191	260	01/99	>				S 3457 C
dryer filter / filtro essiccatore	MAN D0826LOH18	191	260	01/99	>				S 7259 A
power steering / servosterzo	MAN D0826LOH18	191	260	01/99	>				S 3081 PO
U 18	DAF PF235M	235	320	01/99	>		S 3408 R	S 4337 NR	S 8570 A
with automatic gearbox ZF HP590/592 / con cambio automatico ZF HP590/592	DAF PF235M	235	320	01/99	>				S 2234 Z
spheros aeroshere world / con climatizzatore sul tetto	DAF PF235M	235	320	01/99	>				S 3440 C
spheros aeroshere world KONVEKTA / con climatizzatore sul tetto KONVEKTA	DAF PF235M	235	320	01/99	>				S 3458 C
spheros aeroshere world SPHEROS / con climatizzatore sul tetto SPHEROS	DAF PF235M	235	320	01/99	>				S 3457 C
dryer filter / filtro essiccatore	DAF PF235M	235	320	01/99	>				S 7259 A
power steering / servosterzo	DAF PF235M	235	320	01/99	>				S 3081 PO
U 18	DAF PR228S Euro4	228	310	10/06	>			S 6024 NE	
with automatic gearbox ZF HP590/592 / con cambio automatico ZF HP590/592	DAF PR228S Euro4	228	310	10/06	>				S 2234 Z
spheros aeroshere world / con climatizzatore sul tetto	DAF PR228S Euro4	228	310	10/06	>				S 3440 C
spheros aeroshere world KONVEKTA / con climatizzatore sul tetto KONVEKTA	DAF PR228S Euro4	228	310	10/06	>				S 3458 C
spheros aeroshere world SPHEROS / con climatizzatore sul tetto SPHEROS	DAF PR228S Euro4	228	310	10/16	>				S 3457 C
with filter H. 150 mm / con filtro H. 150 mm	DAF PR228S Euro4	228	310	10/06	>		S 5045 PE		
with filter Urea/Adblue / con filtro Urea/Adblue	DAF PR228S Euro4	228	310	10/06	>				S 4401 U
LONG LIFE H. 220 mm	DAF PR228S Euro4	228	310	10/06	>		S 5234 PE		
power steering / servosterzo	DAF PR228S Euro4	228	310	10/06	>				S 3081 PO
U 18	DAF PR250S Euro4	250	340	10/06	>			S 6024 NE	
with automatic gearbox ZF HP590/592 / con cambio automatico ZF HP590/592	DAF PR250S Euro4	250	340	10/06	>				S 2234 Z
spheros aeroshere world / con climatizzatore sul tetto	DAF PR250S Euro4	250	340	10/06	>				S 3440 C
spheros aeroshere world KONVEKTA / con climatizzatore sul tetto KONVEKTA	DAF PR250S Euro4	250	340	10/06	>				S 3458 C
spheros aeroshere world SPHEROS / con climatizzatore sul tetto SPHEROS	DAF PR250S Euro4	250	340	10/06	>				S 3456 C
with filter H. 150 mm / con filtro H. 150 mm	DAF PR250S Euro4	250	340	10/06	>		S 5045 PE		
with filter Urea/Adblue / con filtro Urea/Adblue	DAF PR250S Euro4	250	340	10/06	>				S 4401 U
LONG LIFE H. 220 mm	DAF PR250S Euro4	250	340	10/06	>		S 5234 PE		
power steering / servosterzo	DAF PR250S Euro4	250	340	10/06	>				S 3081 PO
U 18	DAF PR265S Euro4	265	360	10/06	>			S 6024 NE	
with automatic gearbox ZF HP590/592 / con cambio automatico ZF HP590/592	DAF PR265S Euro4	265	360	10/06	>				S 2234 Z
spheros aeroshere world / con climatizzatore sul tetto	DAF PR265S Euro4	265	360	10/06	>				S 3457 C
spheros aeroshere world / con climatizzatore sul tetto	DAF PR265S Euro4	265	360	10/06	>				S 3440 C
spheros aeroshere world KONVEKTA / con climatizzatore sul tetto KONVEKTA	DAF PR265S Euro4	265	360	10/06	>				S 3458 C
with filter H. 150 mm / con filtro H. 150 mm	DAF PR265S Euro4	265	360	10/06	>		S 5045 PE		
with filter Urea/Adblue / con filtro Urea/Adblue	DAF PR265S Euro4	265	360	10/06	>				S 4401 U
LONG LIFE H. 220 mm	DAF PR265S Euro4	265	360	10/06	>		S 5234 PE		
power steering / servosterzo	DAF PR265S Euro4	265	360	10/06	>				S 3081 PO
U 18	MAN D0824LOH25	191	260	01/99	>		S 3292 R	S 4378 NR	S 7187 A
with automatic gearbox ZF HP590/592 / con cambio automatico ZF HP590/592	MAN D0824LOH25	191	260	01/99	>				S 2234 Z
spheros aeroshere world / con climatizzatore sul tetto	MAN D0824LOH25	191	260	01/99	>				S 3440 C
spheros aeroshere world KONVEKTA / con climatizzatore sul tetto KONVEKTA	MAN D0824LOH25	191	260	01/99	>				S 3458 C
spheros aeroshere world SPHEROS / con climatizzatore sul tetto SPHEROS	MAN D0824LOH25	191	260	01/99	>				S 3457 C
dryer filter / filtro essiccatore	MAN D0824LOH25	191	260	01/99	>				S 7259 A
power steering / servosterzo	MAN D0824LOH25	191	260	01/99	>				S 3081 PO
U 18	MAN D2866LOH25	228	310	01/99	>		S 7260 PO	S 4378 NR	S 1050 A
with automatic gearbox ZF HP590/592 / con cambio automatico ZF HP590/592	MAN D2866LOH25	228	310	01/99	>				S 2234 Z
spheros aeroshere world / con climatizzatore sul tetto	MAN D2866LOH25	228	310	01/99	>				S 3440 C



| kW | HP |



...SOLARIS - buses/autobus

spheros aeroshere world KONVEKTA / con climatizzatore sul tetto KONVEKTA	MAN D2866LOH25	228	310	01/99	>				S 3458 C
spheros aeroshere world SPHEROS / con climatizzatore sul tetto SPHEROS	MAN D2866LOH25	228	310	01/99	>				S 3457 C
dryer filter / filtro essiccatore	MAN D2866LOH25	228	310	01/99	>				S 7259 A
power steering / servosterzo	MAN D2866LOH25	228	310	01/99	>				S 3081 PO
U 18	MAN D2866LOH26	257	349	01/99	>	S 7260 PO	S 4378 NR	S 1050 A	
with automatic gearbox ZF HP590/592 / con cambio automatico ZF HP590/592	MAN D2866LOH26	257	349	01/99	>				S 2234 Z
spheros aeroshere world / con climatizzatore sul tetto	MAN D2866LOH26	257	349	01/99	>				S 3440 C
spheros aeroshere world KONVEKTA / con climatizzatore sul tetto KONVEKTA	MAN D2866LOH26	257	349	01/99	>				S 3458 C
spheros aeroshere world SPHEROS / con climatizzatore sul tetto SPHEROS	MAN D2866LOH26	257	349	01/99	>				S 3457 C
dryer filter / filtro essiccatore	MAN D2866LOH26	257	349	01/99	>				S 7259 A
power steering / servosterzo	MAN D2866LOH26	257	349	01/99	>				S 3081 PO
U 9	MAN D0824LOH05	114	155	01/99	>	S 3292 R	S 4378 NR		
spheros aeroshere world / con climatizzatore sul tetto	MAN D0824LOH05	114	155	01/99	>				S 3444 C
spheros aeroshere world KONVEKTA / con climatizzatore sul tetto KONVEKTA	MAN D0824LOH05	114	155	01/99	>				S 3458 C
spheros aeroshere world SPHEROS / con climatizzatore sul tetto SPHEROS	MAN D0824LOH05	114	155	01/99	>				S 3457 C
dryer filter / filtro essiccatore	MAN D0824LOH05	114	155	01/99	>				S 7259 A

Vacanza

12	DAF MX300 Euro4	300	408	10/06	>	S 5081 PE	S 6024 NE	S 7A59 A	
with filter Urea/Adblue / con filtro Urea/Adblue	DAF MX300 Euro4	300	408	10/06	>				S 4401 U
power steering / servosterzo	DAF MX300 Euro4	300	408	10/06	>				S 3081 PO
12	DAF XE250C	250	340	01/02	>	S 5234 PE	S 6146 NE		
dryer filter / filtro essiccatore	DAF XE250C	250	340	01/02	>				S 7259 A
power steering / servosterzo	DAF XE250C	250	340	01/02	>				S 3081 PO
12	DAF XE280C	280	380	01/02	>	S 5234 PE	S 6146 NE		
dryer filter / filtro essiccatore	DAF XE280C	280	380	01/02	>				S 7259 A
power steering / servosterzo	DAF XE280C	280	380	01/02	>				S 3081 PO
12	DAF XE315C	315	428	01/02	>	S 5234 PE	S 6146 NE		
dryer filter / filtro essiccatore	DAF XE315C	315	428	01/02	>				S 7259 A
power steering / servosterzo	DAF XE315C	315	428	01/02	>				S 3081 PO
13	DAF MX300 Euro4	300	408	10/06	>	S 5081 PE	S 6024 NE	S 7A59 A	
with filter Urea/Adblue / con filtro Urea/Adblue	DAF MX300 Euro4	300	408	10/06	>				S 4401 U
power steering / servosterzo	DAF MX300 Euro4	300	408	10/06	>				S 3081 PO
13	DAF XE250C	250	340	01/02	>	S 5234 PE	S 6146 NE		
dryer filter / filtro essiccatore	DAF XE250C	250	340	01/02	>				S 7259 A
power steering / servosterzo	DAF XE250C	250	340	01/02	>				S 3081 PO
13	DAF XE280C	280	380	01/02	>	S 5234 PE	S 6146 NE		
dryer filter / filtro essiccatore	DAF XE280C	280	380	01/02	>				S 7259 A
power steering / servosterzo	DAF XE280C	280	380	01/02	>				S 3081 PO
13	DAF XE315C	315	428	01/02	>	S 5234 PE	S 6146 NE		
dryer filter / filtro essiccatore	DAF XE315C	315	428	01/02	>				S 7259 A
power steering / servosterzo	DAF XE315C	315	428	01/02	>				S 3081 PO

SOLBUS

buses/autobus

B Serie

B 9.5	Iveco F4AE0682	176	240	07/02	>	S 0620 R	S 2220 NR		
with automatic gearbox Voith D851.3E / con cambio automatico Voith D851.3E	Iveco F4AE0682	176	240	07/02	>				S 5663 PO
with air-conditioner WEBASTO Aerosphere World / con climatizzatore WEBASTO Aerosphere World	Iveco F4AE0682	176	240	07/02	>				S 3283 C

C Serie

C 10.5	Iveco F4AE0682	176	240	07/02	>	S 0620 R	S 2220 NR		
with automatic gearbox Voith D851.3E / con cambio automatico Voith D851.3E	Iveco F4AE0682	176	240	07/02	>				S 5663 PO
power steering / servosterzo	Iveco F4AE0682	176	240	07/02	>				S 3081 PO
C 9.5	Iveco F4AE0682	176	240	07/02	>	S 0620 R	S 2220 NR		
with automatic gearbox Voith D851.3E / con cambio automatico Voith D851.3E	Iveco F4AE0682	176	240	07/02	>				S 5663 PO
power steering / servosterzo	Iveco F4AE0682	176	240	07/02	>				S 3081 PO

Solcity

10 (SL10T)	Iveco F4AE0682	176	240	03/06	>	S 0620 R	S 2220 NR		
with automatic gearbox Voith D851.3, D854.3, D864.3 / con cambio automatico Voith D851.3, D854.3, D864.3	Iveco F4AE0682	176	240	03/06	>				S 6449 PO
with automatic gearbox Voith D851.3E / con cambio automatico Voith D851.3E	Iveco F4AE0682	176	240	03/06	>				S 5663 PO
power steering / servosterzo	Iveco F4AE0682	176	240	03/06	>				S 3081 PO

Soltour

ST 10	Iveco F4AE0682	176	240	03/06	>	S 0620 R	S 2220 NR		
with automatic gearbox Voith D851.3, D854.3, D864.3 / con cambio automatico Voith D851.3, D854.3, D864.3	Iveco F4AE0682	176	240	03/06	>				S 6449 PO
with automatic gearbox Voith D851.3E / con cambio automatico Voith D851.3E	Iveco F4AE0682	176	240	03/06	>				S 5663 PO
dryer filter WABCO / filtro essiccatore WABCO	Iveco F4AE0682	176	240	03/06	>				S 7A66 A
power steering / servosterzo	Iveco F4AE0682	176	240	03/06	>				S 3081 PO

Solway

SL 11	Cummins ISBe4	220	300	09/07	>	S 0620 R	S 2220 NR		
--------------	---------------	-----	-----	-------	---	----------	-----------	--	--

S





kW HP



...SOLBUS - buses/autobus

S

with automatic gearbox Voith D851.3, D854.3, D864.3 / con cambio automatico Voith D851.3, D854.3, D864.3	Cummins ISBe4	220	300	09/07	>				S 6449 PO
with automatic gearbox Voith D851.3E / con cambio automatico Voith D851.3E	Cummins ISBe4	220	300	09/07	>				S 5663 PO
with air-conditioner WEBASTO Aerosphere World / con climatizzatore WEBASTO Aerosphere World	Cummins ISBe4	220	300	09/07	>				S 3283 C
with filter SCR-System / con filtro SCR-System	Cummins ISBe4	220	300	09/07	>				S 7A86 A
with filter Urea/Adblue / con filtro Urea/Adblue	Cummins ISBe4	220	300	09/07	>				S 4401 U
dryer filter WABCO / filtro essiccatore WABCO	Cummins ISBe4	220	300	09/07	>				S 7A66 A
power steering / servosterzo	Cummins ISBe4	220	300	09/07	>				S 3081 PO
SL 11	Iveco F4AE3682E	194	264	09/08	>	S 0620 R	S 2220 NR		
with automatic gearbox Voith D851.3, D854.3, D864.3 / con cambio automatico Voith D851.3, D854.3, D864.3	Iveco F4AE3682E	194	264	09/08	>				S 6449 PO
with automatic gearbox Voith D851.3E / con cambio automatico Voith D851.3E	Iveco F4AE3682E	194	264	09/08	>				S 5663 PO
with air-conditioner WEBASTO Aerosphere World / con climatizzatore WEBASTO Aerosphere World	Iveco F4AE3682E	194	264	09/08	>				S 3283 C
with filter Urea/Adblue / con filtro Urea/Adblue	Iveco F4AE3682E	194	264	09/08	>				S 4401 U
dryer filter WABCO / filtro essiccatore WABCO	Iveco F4AE3682E	194	264	09/08	>				S 7A66 A
power steering / servosterzo	Iveco F4AE3682E	194	264	09/08	>				S 3081 PO

STEYR / DAIMLER / PUCH

trucks/autocarri

10 S Serie

10 S 14	MAN D 0834	103	140	05/01	>	S 3292 R		S 8502 A	S 3048 C
dryer filter / filtro essiccatore	MAN D 0834	103	140	05/01	>				S 7259 A
2 filters / N.2 filtri	MAN D 0834	103	140	05/01	>		S 4378 NR		
prefilter SEPAR 2000 / prefiltra SEPAR 2000	MAN D 0834	103	140	05/01	>		S 6063 NE		
power steering / servosterzo	MAN D 0834	103	140	05/01	>				S 3081 PO
10 S 14 (Serie BR 92)	WD 612.04/.61					S 8600 R	S 8501 NR	S 0950 A	
some / alcuni	WD 612.04/.61					S 8600 R	S 5400 NR	S 0950 A	
10 S 16	MAN D 0824			09/91	> 12/94	S 3292 R		S 2450 A	✗
	MAN D 0824			01/95	>	S 3292 R		S 8502 A	S 3048 C
dryer filter / filtro essiccatore	MAN D 0824			09/91	>				S 7259 A
2 filters / N.2 filtri	MAN D 0824			09/91	>		S 4378 NR		
prefilter SEPAR 2000 / prefiltra SEPAR 2000	MAN D 0824			01/95	>		S 6063 NE		
10 S 18	MAN D 0834			05/01	>	S 3292 R	S 4378 NR		S 3048 C
dryer filter / filtro essiccatore	MAN D 0834			05/01	>				S 7259 A
power steering / servosterzo	MAN D 0834			05/01	>				S 3081 PO
10 S 18 (Serie BR 92)	WD 612.63/.73					S 8600 R	S 0101 N	S 2450 A	
2nd passage cartridge / 2.passaggio immersione	WD 612.63/.73						S 7411 N		
some / alcuni	WD 612.63/.73					S 8600 R	S 5400 NR	S 2450 A	
spin-on / avvitabile	WD 612.63/.73					S 8600 R	S 8501 NR	S 2450 A	
10 S 22	MAN D 0826			05/94	>	S 3292 R	S 4378 NR		S 3048 C
some / alcuni	MAN D 0826			05/94	>	S 3292 R	S 4378 NR	S 2650 A	S 3048 C
dryer filter / filtro essiccatore	MAN D 0826			05/01	>				S 7259 A

12 S Serie

12 S 14 (Serie BR 92)	WD 612.04/.61					S 8600 R	S 8501 NR	S 0950 A	
some / alcuni	WD 612.04/.61					S 8600 R	S 5400 NR	S 0950 A	
12 S 18 (Serie BR 92)	WD 612.63/.73					S 8600 R	S 0101 N	S 2450 A	
2nd passage cartridge / 2.passaggio immersione	WD 612.63/.73					S 8600 R	S 7411 N	S 2450 A	
some / alcuni	WD 612.63/.73					S 8600 R	S 5400 NR	S 2450 A	
spin-on / avvitabile	WD 612.63/.73					S 8600 R	S 8501 NR	S 2450 A	
12 S 21 (Serie BR 92)	WD 612.65/.75					S 8600 R	S 0101 N	S 2450 A	
2nd passage cartridge / 2.passaggio immersione	WD 612.65/.75					S 8600 R	S 7411 N	S 2450 A	
some / alcuni	WD 612.65/.75					S 8600 R	S 5400 NR	S 2450 A	
spin-on / avvitabile	WD 612.65/.75					S 8600 R	S 8501 NR	S 2450 A	

1200 Serie

1290	WD 815.00/.60/.70					S 2530 PO			
1291	WD 1015.61					S 2530 PO		S 1050 A	
inner / interno	WD 1015.61							S 1307 A	
1291	WD 615.60					S 2530 PO		S 0450 A	
inner / interno	WD 615.60							S 1450 A	
1291	WD 615.65/.67, WD 815.61					S 2530 PO		S 0450 A	
inner / interno	WD 615.65/.67, WD 815.61							S 1450 A	
1291	WD 815.64					S 2530 PO	S 0201 N	S 0450 A	
2nd passage / 2.passaggio	WD 815.64						S 1411 N		
inner / interno	WD 815.64							S 1450 A	
1291	WD 815.65, WD 815.66					S 2530 PO		S 1050 A	
inner / interno	WD 815.65, WD 815.66							S 1307 A	

1300 Serie

1390	WD 610.60					S 2530 PO			
1391	WD 612.00/.60/.67					S 2530 PO	S 0101 N	S 2650 A	
2nd passage / 2.passaggio	WD 612.00/.60/.67						S 7411 N		



kW HP



...STEYR / DAIMLER / PUCH - trucks/autocarri

inner / interno	WD 612/00/60/67				S 7129 A	
14 S Serie						
14 S 14 (Serie BR 92)	WD 612.04/61		S 8600 R	S 8501 NR	S 0950 A	
some / alcuni	WD 612.04/61		S 8600 R	S 5400 NR	S 0950 A	
14 S 18 (Serie BR 92)	WD 612.63/73		S 8600 R	S 0101 N	S 2450 A	
2nd passage cartridge / 2.passaggio immersione	WD 612.63/73			S 7411 N		
some / alcuni	WD 612.63/73		S 8600 R	S 5400 NR	S 2450 A	
spin-on / avvitabile	WD 612.63/73		S 8600 R	S 8501 NR	S 2450 A	
14 S 21 (Serie BR 92)	WD 612.65/75		S 8600 R	S 0101 N	S 2450 A	
2nd passage cartridge / 2.passaggio immersione	WD 612.65/75			S 7411 N		
some / alcuni	WD 612.65/75		S 8600 R	S 5400 NR	S 2450 A	
spin-on / avvitabile	WD 612.65/75		S 8600 R	S 8501 NR	S 2450 A	
1400 Serie						
1490	WD 614.01, WD 614.60		S 0300 O			
1490	WD 614.69		S 2530 PO		S 2650 A	
inner / interno	WD 614.69				S 7129 A	
1490	WD 615.60		S 2530 PO		S 0450 A	
inner / interno	WD 615.60				S 1450 A	
1490	WD 815.00/60/70		S 2530 PO			
1491	WD 1015.61		S 2530 PO		S 1050 A	
inner / interno	WD 1015.61				S 1307 A	
1491	WD 615.60		S 2530 PO		S 0450 A	
inner / interno	WD 615.60				S 1450 A	
1491	WD 615.66/67, WD 815.61		S 2530 PO		S 0450 A	
inner / interno	WD 615.66/67, WD 815.61				S 1450 A	
1491	WD 615.68		S 8600 R	S 0201 N	S 0450 A	
1491	WD 815.64		S 2530 PO	S 0201 N	S 0450 A	
2nd passage / 2.passaggio	WD 815.64			S 1411 N		
inner / interno	WD 815.64				S 1450 A	
1491	WD 815.65, WD 815.66		S 2530 PO		S 1050 A	
inner / interno	WD 815.65, WD 815.66				S 1307 A	
15 S Serie						
15 S 18 (Serie BR 92)	WD 612.63/73		S 8600 R	S 0101 N	S 2450 A	
2nd passage cartridge / 2.passaggio immersione	WD 612.63/73			S 7411 N		
some / alcuni	WD 612.63/73		S 8600 R	S 5400 NR	S 2450 A	
spin-on / avvitabile	WD 612.63/73		S 8600 R	S 8501 NR	S 2450 A	
15 S 21 (Serie BR 92)	WD 612.65/75		S 8600 R	S 0101 N	S 2450 A	
2nd passage cartridge / 2.passaggio immersione	WD 612.65/75			S 7411 N		
some / alcuni	WD 612.65/75		S 8600 R	S 5400 NR	S 2450 A	
spin-on / avvitabile	WD 612.65/75		S 8600 R	S 8501 NR	S 2450 A	
16 S Serie						
16 S 18 (Serie BR 92)	WD 612.63/73		S 8600 R	S 0101 N	S 2450 A	
2nd passage cartridge / 2.passaggio immersione	WD 612.63/73			S 7411 N		
some / alcuni	WD 612.63/73		S 8600 R	S 5400 NR	S 2450 A	
spin-on / avvitabile	WD 612.63/73		S 8600 R	S 8501 NR	S 2450 A	
16 S 21 (Serie BR 92)	WD 612.65/75		S 8600 R	S 0101 N	S 2450 A	
2nd passage cartridge / 2.passaggio immersione	WD 612.65/75			S 7411 N		
some / alcuni	WD 612.65/75		S 8600 R	S 5400 NR	S 2450 A	
spin-on / avvitabile	WD 612.65/75		S 8600 R	S 8501 NR	S 2450 A	
1800 Serie						
1891	WD 815.64		S 2530 PO	S 0201 N	S 0450 A	
2nd passage / 2.passaggio	WD 815.64			S 1411 N		
inner / interno	WD 815.64				S 1450 A	
19 S Serie						
19 S 31			S 8600 R	S 0201 N	S 0450 A	
2nd passage / 2.passaggio				S 1411 N		
inner / interno					S 1450 A	
19 S 37			S 2530 PO	S 6710 NR	S 1050 A	
22 S Serie						
22 S 31			S 8600 R	S 0201 N	S 0450 A	
2nd passage / 2.passaggio				S 1411 N		
inner / interno					S 1450 A	
22 S 37			S 2530 PO	S 6710 NR	S 1050 A	
26 S Serie						
26 S 31			S 8600 R	S 0201 N	S 0450 A	
2nd passage / 2.passaggio				S 1411 N		
inner / interno					S 1450 A	

S





kW HP



...STEYR / DAIMLER / PUCH - trucks/autocarri

S

26 S 37			S 2530 PO	S 6710 NR	S 1050 A	
2800 Serie						
2891	WD 815.95		S 2530 PO	S 0201 N	S 0450 A	
2nd passage / 2.passaggio	WD 815.95			S 1411 N		
inner / interno	WD 815.95				S 1450 A	
32 S Serie						
32 S 31			S 8600 R	S 0201 N	S 0450 A	
2nd passage / 2.passaggio				S 1411 N		
inner / interno					S 1450 A	
32 S 37			S 2530 PO	S 6710 NR	S 1050 A	
400 Serie						
411					S 4940 A	
500 Serie						
585			S 0530 PO			
586 Z	WD 609 Z		S 2530 PO			
590	WD 610.01		S 8600 R			
2nd passage / 2.passaggio	WD 610.01			S 8501 NR		
power steering / servosterzo	WD 610.01					S 3081 PO
590	WD 610.18		S 2530 PO			
2nd passage / 2.passaggio	WD 610.18			S 8501 NR		
power steering / servosterzo	WD 610.18					S 3081 PO
600 Serie						
680			S 0530 PO			
690	WD 610.01		S 8600 R			
2nd passage / 2.passaggio	WD 610.01			S 8501 NR		
power steering / servosterzo	WD 610.01					S 3081 PO
690	WD 610.18		S 2530 PO			
2nd passage / 2.passaggio	WD 610.18			S 8501 NR		
power steering / servosterzo	WD 610.18					S 3081 PO
692	WD 612.04, WD 612.24		S 8600 R		S 0950 A	
2nd passage / 2.passaggio	WD 612.04, WD 612.24			S 8501 NR		
inner / interno	WD 612.04, WD 612.24				S 1940 A	
692	WD 612.73		S 8600 R		S 2450 A	
2nd passage / 2.passaggio	WD 612.73			S 8501 NR		
inner / interno	WD 612.73				S 3940 A	
700 Serie						
780			S 0530 PO			
780	WD 609 Z		S 2530 PO			
780 Z	WD 609 Z		S 2530 PO			
790						
1st passage spin-on / 1.passaggio avvitabile			S 0300 O			
1st passage cartridge / 1.passaggio immersione			S 0300 O			
2nd passage spin-on / 2.passaggio avvitabile			S 0300 O	S 8501 NR		
2nd passage cartridge / 2.passaggio immersione			S 0300 O			
some / alcuni			S 2530 PO			
some / alcuni			S 0300 O			
power steering / servosterzo						S 3081 PO
790	WD 610.00		S 8600 R			
791	WD 612/.00/.60/.67		S 2530 PO	S 0101 N	S 2650 A	
2nd passage / 2.passaggio	WD 612/.00/.60/.67			S 7411 N		
inner / interno	WD 612/.00/.60/.67				S 7129 A	
792	WD 612/.63/.74/.76		S 8600 R		S 2450 A	
2nd passage / 2.passaggio	WD 612/.63/.74/.76			S 8501 NR		
inner / interno	WD 612/.63/.74/.76				S 3940 A	
792	WD612.02		S 8600 R		S 0950 A	
2nd passage / 2.passaggio	WD612.02			S 8501 NR		
inner / interno	WD612.02				S 1940 A	
8 S Serie						
8 S 10	MAN D 0824	01/95 >	S 3292 R	S 4378 NR		S 3048 C
some / alcuni	MAN D 0824	01/95 >	S 3292 R	S 4378 NR	S 2450 A	S 3048 C
dryer filter / filtro essiccatore	MAN D 0824	01/95 >				S 7259 A
8 S 11	MAN D 0824	08/95 >	S 3292 R	S 4378 NR		S 3048 C
some / alcuni	MAN D 0824	08/95 >	S 3292 R	S 4378 NR	S 2450 A	S 3048 C
dryer filter / filtro essiccatore	MAN D 0824	08/95 >				S 7259 A
8 S 14	MAN D 0834	05/01 >	S 3292 R	S 4378 NR		S 3048 C
dryer filter / filtro essiccatore	MAN D 0834	05/01 >				S 7259 A
power steering / servosterzo	MAN D 0834	05/01 >				S 3081 PO



kW HP



...STEYR / DAIMLER / PUCH - trucks/autocarri

8 S 16	MAN D 0824	01/95 >	S 3292 R	S 4378 NR		S 3048 C
some / alcuni	MAN D 0824	01/95 >	S 3292 R	S 4378 NR	S 2650 A	S 3048 C
dryer filter / filtro essiccatore	MAN D 0824	01/95 >				S 7259 A
8 S 18	MAN D 0834	05/01 >	S 3292 R	S 4378 NR		S 3048 C
dryer filter / filtro essiccatore	MAN D 0834	05/01 >				S 7259 A
power steering / servosterzo	MAN D 0834	05/01 >				S 3081 PO
8 S 22	MAN D 0826	05/94 >	S 3292 R	S 4378 NR		S 3048 C
some / alcuni	MAN D 0826	05/94 >	S 3292 R	S 4378 NR	S 2650 A	S 3048 C
dryer filter / filtro essiccatore	MAN D 0826	05/94 >				S 7259 A
800 Serie						
880	WD 614.01, WD 614.60		S 0300 O			
890			S 0300 O			
1st passage spin-on / 1.passaggio avvitabile			S 0300 O			
1st passage cartridge / 1.passaggio immersione			S 0300 O	S 8501 NR		
2nd passage spin-on / 2.passaggio avvitabile			S 0300 O			
2nd passage cartridge / 2.passaggio immersione			S 0300 O			
some / alcuni			S 0300 O			
some / alcuni			S 2530 PO			S 3081 PO
power steering / servosterzo						
890	WD 614.01, WD 614.60		S 0300 O			
891	WD 612/.00/.60/.67		S 2530 PO	S 0101 N	S 2650 A	
2nd passage / 2.passaggio	WD 612/.00/.60/.67			S 7411 N		
inner / interno	WD 612/.00/.60/.67				S 7129 A	
892	WD 612/.63/.65/.75		S 8600 R		S 2450 A	
2nd passage / 2.passaggio	WD 612/.63/.65/.75			S 8501 NR		
inner / interno	WD 612/.63/.65/.75				S 3940 A	
9 S Serie						
9 S 14	MAN D 0834	05/01 >	S 3292 R	S 4378 NR		S 3048 C
dryer filter / filtro essiccatore	MAN D 0834	05/01 >				S 7259 A
power steering / servosterzo	MAN D 0834	05/01 >				S 3081 PO
9 S 14 (Serie BR 92)	WD 612.04/.61		S 8600 R	S 8501 NR	S 0950 A	
some / alcuni	WD 612.04/.61		S 8600 R	S 5400 NR	S 0950 A	
9 S 16	MAN D 0824	01/95 >	S 3292 R	S 4378 NR	S 2450 A	S 3048 C
dryer filter / filtro essiccatore	MAN D 0824	01/95 >				S 7259 A
9 S 18	MAN D 0834	05/01 >	S 3292 R	S 4378 NR		S 3048 C
dryer filter / filtro essiccatore	MAN D 0834	05/01 >				S 7259 A
power steering / servosterzo	MAN D 0834	05/01 >				S 3081 PO
9 S 18 (Serie BR 92)	WD 612.63/.73		S 8600 R	S 0101 N	S 2450 A	
2nd passage cartridge / 2.passaggio immersione	WD 612.63/.73			S 7411 N		
some / alcuni	WD 612.63/.73		S 8600 R	S 5400 NR	S 2450 A	
spin-on / avvitabile	WD 612.63/.73		S 8600 R	S 8501 NR	S 2450 A	
9 S 22	MAN D 0826	05/94 >	S 3292 R	S 4378 NR		S 3048 C
some / alcuni	MAN D 0826	05/94 >	S 3292 R	S 4378 NR	S 2650 A	S 3048 C
dryer filter / filtro essiccatore	MAN D 0826	05/94 >				S 7259 A
900 Serie						
990	WD 614.01, WD 614.20		S 0300 O		S 2450 A	
some / alcuni	WD 614.01, WD 614.20		S 0300 O		S 2650 A	
990 A	WD 614.01, WD 614.60		S 0300 O			
991	WD 615.00		S 2530 PO	S 0101 N	S 2650 A	
2nd passage / 2.passaggio	WD 615.00			S 7411 N		
inner / interno	WD 615.00				S 7129 A	
TALBOT (E) trucks/autocarri						
26 Serie						
26/26 B				S 7411 N		
some / alcuni			S 1220 R	S 7111 NC		
26/26 B Turbo 300				S 7411 N		
some / alcuni			S 1220 R	S 7111 NC		
26/26 D				S 7111 NC		
some / alcuni			S 1220 R	S 7111 NC		
power steering / servosterzo						S 8790 PO
42 Serie						
42/14	D36			S 7411 N	S 5270 A	
some / alcuni	D36		S 1220 R	S 7111 NC	S 5270 A	
42/14 B	D36			S 7411 N	S 5270 A	
some / alcuni	D36		S 1220 R	S 7111 NC	S 5270 A	
42/16				S 7411 N	S 5270 A	





kW HP



...TALBOT (E) - trucks/autocarri

some / alcuni		07/77 >	S 1220 R	S 7111 NC	S 5270 A	
some / alcuni				S 7111 NC	S 5270 A	
42/16 B				S 7411 N	S 5270 A	
some / alcuni				S 7111 NC	S 5270 A	
some / alcuni		07/77 >	S 1220 R	S 7111 NC	S 5270 A	
42/16 C				S 7411 N	S 5270 A	
some / alcuni				S 7111 NC	S 5270 A	
some / alcuni		07/77 >	S 1220 R	S 7111 NC	S 5270 A	
42/17	B26			S 7111 NC	S 5270 A	
42/17 B	B26			S 7111 NC	S 5270 A	
42/17 C	B26			S 7111 NC	S 5270 A	
42/20	BS16			S 7111 NC	S 2650 A	
power steering / servosterzo	BS16					S 8790 PO
42/20 AB	B26			S 7111 NC	S 5270 A	
42/20 B	B26			S 7111 NC	S 5270 A	
42/20 CD	B26			S 7111 NC	S 2450 A	
power steering / servosterzo	B26					S 8790 PO
42/20 GR			S 1220 R	S 7411 N		
some / alcuni				S 7111 NC		
42/20 ND	B26			S 7111 NC	S 2450 A	
power steering / servosterzo	B26					S 8790 PO
42/35				S 7411 N	S 7550 A	
cartridge / immersione				S 7411 N	S 7550 A	
42/38	B36			S 7111 NC		
some / alcuni	B36	07/77 >	S 1220 R	S 7111 NC		
42/38 R	B36			S 7111 NC		
some / alcuni	B36	07/77 >	S 1220 R	S 7111 NC		
42/38 RB Turbo 300				S 7411 N		
some / alcuni			S 1220 R	S 7111 NC		
42/38 RD				S 7111 NC		
some / alcuni			S 1220 R	S 7111 NC		
power steering / servosterzo						S 8790 PO
42/38 T	B36			S 7111 NC		
some / alcuni	B36	07/77 >	S 1220 R	S 7111 NC		
42/38 TB				S 7411 N		
some / alcuni			S 1220 R	S 7111 NC		
42/38 TB Turbo 300				S 7411 N		
some / alcuni			S 1220 R	S 7111 NC		
42/38 TD				S 7111 NC		
some / alcuni			S 1220 R	S 7111 NC		
power steering / servosterzo						S 8790 PO
42/45	C60			S 7111 NC		
42/55				S 7411 N	S 7550 A	
some / alcuni				S 7111 NC	S 7550 A	
42/65				S 7411 N	S 7550 A	
some / alcuni				S 7111 NC	S 7550 A	
42/70					S 7550 A	
cartridge / immersione				S 7411 N	S 7550 A	
62 Serie						
62/26				S 7111 NC		
some / alcuni			S 1220 R	S 7111 NC		
power steering / servosterzo						S 8790 PO
62/26	B36			S 7111 NC		
some / alcuni	B36	07/77 >	S 1220 R	S 7111 NC		
64 Serie						
64/26 H				S 7111 NC		
some / alcuni			S 1220 R	S 7111 NC		
power steering / servosterzo						S 8790 PO
64/26 HB (Hormigonera Turbo)				S 7411 N		
some / alcuni			S 1220 R	S 7111 NC		
64/26 HD				S 7111 NC		
some / alcuni			S 1220 R	S 7111 NC		
power steering / servosterzo						S 8790 PO
64/26 V				S 7411 N		
some / alcuni			S 1220 R	S 7111 NC		
64/26 VB (Cabina moderna)				S 7411 N		
some / alcuni			S 1220 R	S 7111 NC		



kW HP



...TALBOT (E) - trucks/autocarri

64/26 VD some / alcuni power steering / servosterzo		S 1220 R	S 7111 NC S 7111 NC		S 8790 PO
64/34 D some / alcuni power steering / servosterzo		S 1220 R	S 7111 NC S 7111 NC		S 8790 PO
64/34 Turbo 300 some / alcuni		S 1220 R	S 7411 N S 7111 NC		
82 Serie					
82/35 some / alcuni		S 1220 R	S 7411 N S 7111 NC		
82/35 B some / alcuni		S 1220 R	S 7411 N S 7111 NC		
82/35 D some / alcuni power steering / servosterzo		S 1220 R	S 7111 NC S 7111 NC		S 8790 PO
82/58 Turbo 300 some / alcuni		S 1220 R	S 7411 N S 7111 NC		
84 Serie					
84/37 Turbo 300 some / alcuni		S 1220 R	S 7411 N S 7111 NC		
Azor					
Azor some / alcuni some / alcuni	07/77 >	S 1220 R	S 7411 N S 7111 NC S 7111 NC	S 5270 A S 5270 A S 5270 A	
C Serie					
C 14 A power steering / servosterzo		S 8600 R		S 2450 A	S 8790 PO
C 14 E power steering / servosterzo		S 8600 R		S 2450 A	S 8790 PO
C 16 Turbo 150 power steering / servosterzo		S 8600 R		S 2450 A	S 8790 PO
Centauro					
Centauro Hormigonera			S 7111 NC		
Condor					
Condor some / alcuni some / alcuni	07/77 >	S 1220 R	S 7411 N S 7111 NC S 7111 NC	S 5270 A S 5270 A S 5270 A	
Dodge					
C 17 A power steering / servosterzo	B26 B26		S 7111 NC	S 2450 A	S 8790 PO
C 17 Turbo 200 power steering / servosterzo	BS16 BS16		S 7111 NC	S 2650 A	S 8790 PO
C 20 power steering / servosterzo	B26 B26		S 7111 NC	S 2450 A	S 8790 PO
C 20 Turbo 200 power steering / servosterzo	BS16 BS16		S 7111 NC	S 2650 A	S 8790 PO
C 2264 power steering / servosterzo	BS16 BS16		S 7111 NC	S 2650 A	S 8790 PO
C 2264 N power steering / servosterzo	BS16 BS16		S 7111 NC	S 2650 A	S 8790 PO
C 2464 C power steering / servosterzo	BS16 BS16		S 7111 NC	S 2650 A	S 8790 PO
C 2464 N power steering / servosterzo	BS16 BS16		S 7111 NC	S 2650 A	S 8790 PO
C 2626 Turbo 300 some / alcuni power steering / servosterzo		S 1220 R	S 7111 NC S 7111 NC		S 8790 PO
C 2662 Turbo 200 power steering / servosterzo	BS16 BS16		S 7111 NC	S 2650 A	S 8790 PO
C 2664 Turbo 200 power steering / servosterzo	BS16 BS16		S 7111 NC	S 2650 A	S 8790 PO
C 3064 some / alcuni power steering / servosterzo		S 1220 R	S 7111 NC S 7111 NC		S 8790 PO
C 3064 Turbo 300 some / alcuni		S 1220 R	S 7111 NC S 7111 NC		

T





kW HP



...TALBOT (E) - trucks/autocarri

T

power steering / servosterzo					S 8790 PO
C 3464 Turbo 300				S 7111 NC	
some / alcuni			S 1220 R	S 7111 NC	
power steering / servosterzo					S 8790 PO
C 3582 Turbo 300				S 7111 NC	
some / alcuni			S 1220 R	S 7111 NC	
power steering / servosterzo					S 8790 PO
C 3784 Turbo 300				S 7111 NC	
some / alcuni			S 1220 R	S 7111 NC	
power steering / servosterzo					S 8790 PO
C 38				S 7111 NC	
some / alcuni			S 1220 R	S 7111 NC	
power steering / servosterzo					S 8790 PO
C 38 T Turbo 300				S 7111 NC	
some / alcuni			S 1220 R	S 7111 NC	
power steering / servosterzo					S 8790 PO
C 38 T Turbo 350				S 7111 NC	
some / alcuni			S 1220 R	S 7111 NC	
power steering / servosterzo					S 8790 PO
C 3820 P				S 7111 NC	
some / alcuni			S 1220 R	S 7111 NC	
power steering / servosterzo					S 8790 PO
R 3784 Turbo 300				S 7111 NC	
some / alcuni			S 1220 R	S 7111 NC	
power steering / servosterzo					S 8790 PO
Halcon					
CA 262				S 7411 N	S 7550 A
some / alcuni				S 7111 NC	S 7550 A
Saeta					
15	D90			S 7411 N	
some / alcuni	D90			S 7111 NC	
25	D90			S 7411 N	
some / alcuni	D90			S 7111 NC	
35	D90			S 7411 N	
some / alcuni	D90			S 7111 NC	
45	A90			S 7411 N	
some / alcuni	A90			S 7111 NC	
45	D34			S 7111 NC	
some / alcuni	D34		S 1220 R	S 7111 NC	
4x4	D90			S 7411 N	
some / alcuni	D90			S 7111 NC	
55	A90			S 7411 N	
some / alcuni	A90			S 7111 NC	
55	D34			S 7111 NC	
some / alcuni	D34		S 1220 R	S 7111 NC	
5T	A16			S 7411 N	
some / alcuni	A16			S 7111 NC	
65	A90			S 7411 N	
some / alcuni	A90			S 7111 NC	
65	D34			S 7111 NC	
some / alcuni	D34		S 1220 R	S 7111 NC	
70	A90			S 7411 N	
some / alcuni	A90			S 7111 NC	
75	A90			S 7411 N	
some / alcuni	A90			S 7111 NC	
75	D34			S 7111 NC	
some / alcuni	D34		S 1220 R	S 7111 NC	
Super	A16			S 7411 N	
some / alcuni	A16			S 7111 NC	
Super Azor					
Super Azor				S 7411 N	S 5270 A
some / alcuni				S 7111 NC	S 5270 A
some / alcuni		07/77 >	S 1220 R	S 7111 NC	S 5270 A



kW HP

**TALBOT (E)**

buses/autobus

2000 Serie

2800 E/E	D34, D36			S 1220 R	S 7111 NC		
some / alcuni	D34, D36				S 7111 NC		
2900					S 7411 N		
some / alcuni					S 7111 NC		
2900	A24				S 7111 NC		
2900	D34				S 7111 NC		
some / alcuni	D34			S 1220 R	S 7111 NC		
2900 E/E	D34, D36				S 7111 NC		
some / alcuni	D34, D36			S 1220 R	S 7111 NC		

4000 Serie

4600					S 7411 N		
some / alcuni					S 7111 NC		
4600	D34, D36				S 7111 NC		
some / alcuni	D34, D36			S 1220 R	S 7111 NC		
4600 V					S 7411 N		
some / alcuni					S 7111 NC		
4601	D34, D36				S 7111 NC		
some / alcuni	D34, D36			S 1220 R	S 7111 NC		

6000 Serie

6000 L			> 06/77		S 7411 N		
			07/77 >		S 7111 NC		
6000 U			> 06/77		S 7411 N		
			07/77 >		S 7111 NC		

A Serie

A 131 B					S 7111 NC		
A 501 B			> 06/77		S 7411 N		
			07/77 >		S 7111 NC		

AEC Serie

AEC tipo/type A 131 V			> 06/77		S 7411 N		
			07/77 >		S 7111 NC		

B Serie

B 210 I					S 7111 NC		
B 212	B26				S 7111 NC	S 5270 A	
B 312	D34			S 1220 R	S 7111 NC		
BS 210 Turbo 200	BS16				S 7111 NC	S 5270 A	
BS 312 Turbo 300	BS36			S 1220 R	S 7111 NC		

C Serie

CLB 245			> 06/77		S 7411 N		
			07/77 >		S 7111 NC		

D Serie

D 309 U	D36				S 7111 NC		
some / alcuni	D36			S 1220 R	S 7111 NC		
D 3091	D36				S 7111 NC		
some / alcuni	D36			S 1220 R	S 7111 NC		

GLA Serie

GLA 265					S 7411 N		
some / alcuni					S 7111 NC		

Gran Ruta Serie

3700 E/E					S 7111 NC		
5000 E/E					S 7111 NC		

S Serie

S 35 V					S 7411 N		
some / alcuni					S 7111 NC		
S 5300 I			> 06/77		S 7411 N		
			07/77 >		S 7111 NC		
SXA 90 F					S 7411 N		
some / alcuni					S 7111 NC		

Saeta Serie

Saeta 75 (Saeta 35)	D34, D36				S 7111 NC		
some / alcuni	D34, D36			S 1220 R	S 7111 NC		

Super Azor Serie

Super Azor			> 06/77		S 7411 N		
			07/77 >		S 7111 NC		

T





kW HP



TATRA

trucks/autocarri

131 Serie

T 131					S 1411 N	S 8950 A	
-------	--	--	--	--	----------	----------	--

148 Serie

T 148					S 1411 N	S 0060 A	
-------	--	--	--	--	----------	----------	--

815 Serie

815	V12				S 1411 N	S 1050 A	
-----	-----	--	--	--	----------	----------	--

815-2	V12				S 1411 N	S 1050 A	
-------	-----	--	--	--	----------	----------	--

Phoenix

360	DAF MX265	265 360	11/11 >		S 5081 PE	S 6024 NE	S 7573 A	S 3139 C
with activated carbons / ai carboni attivi	DAF MX265	265 360	11/11 >					S 4347 CA
with filter SCR-System / con filtro SCR-System	DAF MX265	265 360	11/11 >					S 7A86 A
with filter Urea/Adblue / con filtro Urea/Adblue	DAF MX265	265 360	11/11 >					S 4403 U
dryer filter / filtro essiccatore	DAF MX265	265 360	11/11 >					S 7393 A
prefilter MANN+HUMMEL Preline / prefiltro MANN+HUMMEL Preline	DAF MX265	265 360	11/11 >			S 4142 NR		
rotor for oil centrifuge / rotore per filtro olio centrifugo	DAF MX265	265 360	11/11 >		S 5904 PO			
power steering / servosterzo	DAF MX265	265 360	11/11 >					S 3081 PO
370	DAF MX11 Euro6	271 368	01/15 >		S 5240 PE		S 7573 A	S 3139 C
with activated carbons / ai carboni attivi	DAF MX11 Euro6	271 368	01/15 >					S 4347 CA
with filter Urea/Adblue / con filtro Urea/Adblue	DAF MX11 Euro6	271 368	01/15 >					S 4405 U
dryer filter / filtro essiccatore	DAF MX11 Euro6	271 368	01/15 >					S 7F14 A
prefilter MANN+HUMMEL Preline / prefiltro MANN+HUMMEL Preline	DAF MX11 Euro6	271 368	01/15 >			S 4142 NR		
rotor for oil centrifuge / rotore per filtro olio centrifugo	DAF MX11 Euro6	271 368	01/15 >		S 5905 PO			
power steering / servosterzo	DAF MX11 Euro6	271 368	01/15 >					S 3081 PO
power steering ZF Servocom RAS-EC / servosterzo ZF Servocom RAS-EC	DAF MX11 Euro6	271 368	01/15 >					S 5664 PO
400	DAF MX11 Euro6	291 396	01/15 >		S 5240 PE		S 7573 A	S 3139 C
with activated carbons / ai carboni attivi	DAF MX11 Euro6	291 396	01/15 >					S 4347 CA
with filter Urea/Adblue / con filtro Urea/Adblue	DAF MX11 Euro6	291 396	01/15 >					S 4405 U
dryer filter / filtro essiccatore	DAF MX11 Euro6	291 396	01/15 >					S 7F14 A
prefilter MANN+HUMMEL Preline / prefiltro MANN+HUMMEL Preline	DAF MX11 Euro6	291 396	01/15 >			S 4142 NR		
rotor for oil centrifuge / rotore per filtro olio centrifugo	DAF MX11 Euro6	291 396	01/15 >		S 5905 PO			
power steering / servosterzo	DAF MX11 Euro6	291 396	01/15 >					S 3081 PO
power steering ZF Servocom RAS-EC / servosterzo ZF Servocom RAS-EC	DAF MX11 Euro6	291 396	01/15 >					S 5664 PO
410	DAF MX13 Euro6	303 412	01/15 >		S 5081 PE		S 7573 A	S 3139 C
with activated carbons / ai carboni attivi	DAF MX13 Euro6	303 412	01/15 >					S 4347 CA
with filter Urea/Adblue / con filtro Urea/Adblue	DAF MX13 Euro6	303 412	01/15 >					S 4405 U
dryer filter / filtro essiccatore	DAF MX13 Euro6	303 412	01/15 >					S 7F14 A
prefilter MANN+HUMMEL Preline / prefiltro MANN+HUMMEL Preline	DAF MX13 Euro6	303 412	01/15 >			S 4142 NR		
power steering / servosterzo	DAF MX13 Euro6	303 412	01/15 >					S 3081 PO
power steering ZF Servocom RAS-EC / servosterzo ZF Servocom RAS-EC	DAF MX13 Euro6	303 412	01/15 >					S 5664 PO
410	DAF MX300	300 408	11/11 >		S 5081 PE	S 6024 NE	S 7573 A	S 3139 C
with activated carbons / ai carboni attivi	DAF MX300	300 408	11/11 >					S 4347 CA
with filter SCR-System / con filtro SCR-System	DAF MX300	300 408	11/11 >					S 7A86 A
with filter Urea/Adblue / con filtro Urea/Adblue	DAF MX300	300 408	11/11 >					S 4403 U
dryer filter / filtro essiccatore	DAF MX300	300 408	11/11 >					S 7393 A
prefilter MANN+HUMMEL Preline / prefiltro MANN+HUMMEL Preline	DAF MX300	300 408	11/11 >			S 4142 NR		
rotor for oil centrifuge / rotore per filtro olio centrifugo	DAF MX300	300 408	11/11 >		S 5904 PO			
power steering / servosterzo	DAF MX300	300 408	11/11 >					S 3081 PO
440	DAF MX11 Euro6	320 435	01/15 >		S 5240 PE		S 7573 A	S 3139 C
with activated carbons / ai carboni attivi	DAF MX11 Euro6	320 435	01/15 >					S 4347 CA
with filter Urea/Adblue / con filtro Urea/Adblue	DAF MX11 Euro6	320 435	01/15 >					S 4405 U
dryer filter / filtro essiccatore	DAF MX11 Euro6	320 435	01/15 >					S 7F14 A
prefilter MANN+HUMMEL Preline / prefiltro MANN+HUMMEL Preline	DAF MX11 Euro6	320 435	01/15 >			S 4142 NR		
rotor for oil centrifuge / rotore per filtro olio centrifugo	DAF MX11 Euro6	320 435	01/15 >		S 5905 PO			
power steering / servosterzo	DAF MX11 Euro6	320 435	01/15 >					S 3081 PO
power steering ZF Servocom RAS-EC / servosterzo ZF Servocom RAS-EC	DAF MX11 Euro6	320 435	01/15 >					S 5664 PO
460	DAF MX13 Euro6	340 462	01/15 >		S 5081 PE		S 7573 A	S 3139 C
with activated carbons / ai carboni attivi	DAF MX13 Euro6	340 462	01/15 >					S 4347 CA
with filter Urea/Adblue / con filtro Urea/Adblue	DAF MX13 Euro6	340 462	01/15 >					S 4405 U
dryer filter / filtro essiccatore	DAF MX13 Euro6	340 462	01/15 >					S 7F14 A
prefilter MANN+HUMMEL Preline / prefiltro MANN+HUMMEL Preline	DAF MX13 Euro6	340 462	01/15 >			S 4142 NR		
power steering / servosterzo	DAF MX13 Euro6	340 462	01/15 >					S 3081 PO
power steering ZF Servocom RAS-EC / servosterzo ZF Servocom RAS-EC	DAF MX13 Euro6	340 462	01/15 >					S 5664 PO
460	DAF MX340	340 462	11/11 >		S 5081 PE	S 6024 NE	S 7573 A	S 3139 C
with activated carbons / ai carboni attivi	DAF MX340	340 462	11/11 >					S 4347 CA
with filter SCR-System / con filtro SCR-System	DAF MX340	340 462	11/11 >					S 7A86 A
with filter Urea/Adblue / con filtro Urea/Adblue	DAF MX340	340 462	11/11 >					S 4403 U
dryer filter / filtro essiccatore	DAF MX340	340 462	11/11 >					S 7393 A

**KW HP****...TATRA - trucks/autocarri**

prefilter MANN+HUMMEL PreLine / prefiltrato MANN+HUMMEL PreLine	DAF MX340	340	462	11/11	>		S 4142 NR		
rotor for oil centrifuge / rotore per filtro olio centrifugo	DAF MX340	340	462	11/11	>	S 5904 PO			
power steering / servosterzo	DAF MX340	340	462	11/11	>				S 3081 PO
510	DAF MX13 Euro6	375	510	01/15	>	S 5081 PE		S 7573 A	S 3139 C
with activated carbons / ai carboni attivi	DAF MX13 Euro6	375	510	01/15	>				S 4347 CA
with filter Urea/Adblue / con filtro Urea/Adblue	DAF MX13 Euro6	375	510	01/15	>				S 4405 U
dryer filter / filtro essiccatore	DAF MX13 Euro6	375	510	01/15	>				S 7F14 A
prefilter MANN+HUMMEL PreLine / prefiltrato MANN+HUMMEL PreLine	DAF MX13 Euro6	375	510	01/15	>		S 4142 NR		
power steering / servosterzo	DAF MX13 Euro6	375	510	01/15	>				S 3081 PO
power steering ZF Servocom RAS-EC / servosterzo ZF Servocom RAS-EC	DAF MX13 Euro6	375	510	01/15	>				S 5664 PO
510	DAF MX375	375	510	11/11	>	S 5081 PE	S 6024 NE	S 7573 A	S 3139 C
with activated carbons / ai carboni attivi	DAF MX375	375	510	11/11	>				S 4347 CA
with filter SCR-System / con filtro SCR-System	DAF MX375	375	510	11/11	>				S 7A86 A
with filter Urea/Adblue / con filtro Urea/Adblue	DAF MX375	375	510	11/11	>				S 4403 U
dryer filter / filtro essiccatore	DAF MX375	375	510	11/11	>				S 7393 A
prefilter MANN+HUMMEL PreLine / prefiltrato MANN+HUMMEL PreLine	DAF MX375	375	510	11/11	>		S 4142 NR		
rotor for oil centrifuge / rotore per filtro olio centrifugo	DAF MX375	375	510	11/11	>	S 5904 PO			
power steering / servosterzo	DAF MX375	375	510	11/11	>				S 3081 PO

TEMESA**buses/autobus****Diamond**

13	MAN D2066LOH04	324	440	10/06	>	S 5046 PE	S 6011 NE	S 7644 A	
with air-conditioner Webasto Aerosphere World / con climatizzatore Webasto Aerosphere World	MAN D2066LOH04	324	440	10/06	>				S 3283 C
dryer filter / filtro essiccatore	MAN D2066LOH04	324	440	10/06	>				S 7A66 A
inner / interno	MAN D2066LOH04	324	440	10/06	>			S 7646 A	
power steering / servosterzo	MAN D2066LOH04	324	440	10/06	>				S 3081 PO
13	MAN D2676LOH	353	480	10/06	>	S 5046 PE	S 6011 NE	S 7644 A	
with air-conditioner Webasto Aerosphere World / con climatizzatore Webasto Aerosphere World	MAN D2676LOH	353	480	10/06	>				S 3283 C
dryer filter / filtro essiccatore	MAN D2676LOH	353	480	10/06	>				S 7A66 A
inner / interno	MAN D2676LOH	353	480	10/06	>			S 7646 A	
power steering / servosterzo	MAN D2676LOH	353	480	10/06	>				S 3081 PO
13	MAN D2876 LOH02 Euro3	338	460	09/04	>	S 5016 PE	S 6004 NE	S 7644 A	
with air-conditioner Webasto Aerosphere World / con climatizzatore Webasto Aerosphere World	MAN D2876 LOH02 Euro3	338	460	09/04	>				S 3283 C
with filter SEPAR 2000 / con filtro SEPAR 2000	MAN D2876 LOH02 Euro3	338	460	09/04	>		S 6063 NE		
dryer filter / filtro essiccatore	MAN D2876 LOH02 Euro3	338	460	09/04	>				S 7A66 A
inner / interno	MAN D2876 LOH02 Euro3	338	460	09/04	>			S 7646 A	
power steering / servosterzo	MAN D2876 LOH02 Euro3	338	460	09/04	>				S 3081 PO
14	MAN D2066LOH04	324	440	10/06	>	S 5046 PE	S 6011 NE	S 7644 A	
with air-conditioner Webasto Aerosphere World / con climatizzatore Webasto Aerosphere World	MAN D2066LOH04	324	440	10/06	>				S 3283 C
dryer filter / filtro essiccatore	MAN D2066LOH04	324	440	10/06	>				S 7A66 A
inner / interno	MAN D2066LOH04	324	440	10/06	>			S 7646 A	
power steering / servosterzo	MAN D2066LOH04	324	440	10/06	>				S 3081 PO
14	MAN D2676LOH	353	480	10/06	>	S 5046 PE	S 6011 NE	S 7644 A	
with air-conditioner Webasto Aerosphere World / con climatizzatore Webasto Aerosphere World	MAN D2676LOH	353	480	10/06	>				S 3283 C
dryer filter / filtro essiccatore	MAN D2676LOH	353	480	10/06	>				S 7A66 A
inner / interno	MAN D2676LOH	353	480	10/06	>			S 7646 A	
power steering / servosterzo	MAN D2676LOH	353	480	10/06	>				S 3081 PO
14	MAN D2876 LOH02 Euro3	338	460	09/04	>	S 5016 PE	S 6004 NE	S 7644 A	
with air-conditioner Webasto Aerosphere World / con climatizzatore Webasto Aerosphere World	MAN D2876 LOH02 Euro3	338	460	09/04	>				S 3283 C
with filter SEPAR 2000 / con filtro SEPAR 2000	MAN D2876 LOH02 Euro3	338	460	09/04	>		S 6063 NE		
dryer filter / filtro essiccatore	MAN D2876 LOH02 Euro3	338	460	09/04	>				S 7A66 A
inner / interno	MAN D2876 LOH02 Euro3	338	460	09/04	>			S 7646 A	
power steering / servosterzo	MAN D2876 LOH02 Euro3	338	460	09/04	>				S 3081 PO

MD

MD 9 C	MAN D0836LOH65 E5/EEV	184	250	10/10	>	S 3292 R	S 6011 NE	S 2650 A	
dryer filter / filtro essiccatore	MAN D0836LOH65 E5/EEV	184	250	10/10	>				S 7A66 A
inner / interno	MAN D0836LOH65 E5/EEV	184	250	10/10	>			S 7129 A	
power steering / servosterzo	MAN D0836LOH65 E5/EEV	184	250	10/10	>				S 3081 PO
MD 9 IC	MAN D0836LOH65 E5/EEV	184	250	10/10	>	S 3292 R	S 6011 NE	S 2650 A	
dryer filter / filtro essiccatore	MAN D0836LOH65 E5/EEV	184	250	10/10	>				S 7A66 A
inner / interno	MAN D0836LOH65 E5/EEV	184	250	10/10	>			S 7129 A	
power steering / servosterzo	MAN D0836LOH65 E5/EEV	184	250	10/10	>				S 3081 PO

Metropol

Intercity	MAN D0834LOH51	152	206	10/06	>	S 3292 R	S 6011 NE	S 2650 A	
dryer filter / filtro essiccatore	MAN D0834LOH51	152	206	10/06	>				S 7A66 A
inner / interno	MAN D0834LOH51	152	206	10/06	>			S 7129 A	
power steering / servosterzo	MAN D0834LOH51	152	206	10/06	>				S 3081 PO

**KW HP****...TEMSA - buses/autobus**

Intercity		MAN D0836LOH52	176	240	10/06 >	S 3292 R	S 6011 NE	S 2650 A	
dryer filter / filtro essiccatore		MAN D0836LOH52	176	240	10/06 >				S 7A66 A
inner / interno		MAN D0836LOH52	176	240	10/06 >			S 7129 A	
power steering / servosterzo		MAN D0836LOH52	176	240	10/06 >				S 3081 PO
Opalin									
8		MAN D0834LOH51	152	206	09/05 >	S 3292 R	S 6011 NE		
dryer filter / filtro essiccatore		MAN D0834LOH51	152	206	09/05 >				S 7A66 A
power steering / servosterzo		MAN D0834LOH51	152	206	09/05 >				S 3081 PO
9		MAN D0836LOH52	176	240	09/05 >	S 3292 R	S 6011 NE		
dryer filter / filtro essiccatore		MAN D0836LOH52	176	240	09/05 >				S 7A66 A
power steering / servosterzo		MAN D0836LOH52	176	240	09/05 >				S 3081 PO
Safari									
10		MAN D2866LOH28 Euro3	265	360	01/01 >	S 7260 PO		S 1050 A	
spheros aeroshere world SPHEROS / con climatizzatore sul tetto SPHEROS		MAN D2866LOH28 Euro3	265	360	01/01 >				S 3457 C
dryer filter / filtro essiccatore		MAN D2866LOH28 Euro3	265	360	01/01 >				S 7259 A
2 filters / N.2 filtri		MAN D2866LOH28 Euro3	265	360	01/01 >		S 4378 NR		
power steering / servosterzo		MAN D2866LOH28 Euro3	265	360	01/01 >				S 3081 PO
12		MAN D2866LOH28 Euro3	265	360	01/01 >	S 7260 PO		S 1050 A	
spheros aeroshere world SPHEROS / con climatizzatore sul tetto SPHEROS		MAN D2866LOH28 Euro3	265	360	01/01 >				S 3457 C
dryer filter / filtro essiccatore		MAN D2866LOH28 Euro3	265	360	01/01 >				S 7259 A
2 filters / N.2 filtri		MAN D2866LOH28 Euro3	265	360	01/01 >		S 4378 NR		
power steering / servosterzo		MAN D2866LOH28 Euro3	265	360	01/01 >				S 3081 PO
13		MAN D2866LOH28 Euro3	265	360	01/01 >	S 7260 PO		S 1050 A	
dryer filter / filtro essiccatore		MAN D2866LOH28 Euro3	265	360	01/01 >				S 7259 A
2 filters / N.2 filtri		MAN D2866LOH28 Euro3	265	360	01/01 >		S 4378 NR		
power steering / servosterzo		MAN D2866LOH28 Euro3	265	360	01/01 >				S 3081 PO
Safari HD									
12		DAF MX300S	300	410	10/06 >	S 5081 PE	S 6024 NE	S 7A59 A	
spheros aeroshere world SPHEROS / con climatizzatore sul tetto SPHEROS		DAF MX300S	300	410	10/06 >				S 3457 C
with air-conditioner Webasto Aerosphere World / con climatizzatore Webasto Aerosphere World		DAF MX300S	300	410	10/06 >				S 3283 C
with filter SCR-System / con filtro SCR-System		DAF MX300S	300	410	10/06 >				S 7A86 A
with filter Urea/Adblue / con filtro Urea/Adblue		DAF MX300S	300	410	10/06 >				S 4401 U
dryer filter / filtro essiccatore		DAF MX300S	300	410	10/06 >				S 7A66 A
power steering / servosterzo		DAF MX300S	300	410	10/06 >				S 3081 PO
13		DAF MX300S	300	410	10/06 >	S 5081 PE	S 6024 NE	S 7A59 A	
spheros aeroshere world SPHEROS / con climatizzatore sul tetto SPHEROS		DAF MX300S	300	410	10/06 >				S 3457 C
with air-conditioner Webasto Aerosphere World / con climatizzatore Webasto Aerosphere World		DAF MX300S	300	410	10/06 >				S 3283 C
with filter SCR-System / con filtro SCR-System		DAF MX300S	300	410	10/06 >				S 7A86 A
with filter Urea/Adblue / con filtro Urea/Adblue		DAF MX300S	300	410	10/06 >				S 4401 U
dryer filter / filtro essiccatore		DAF MX300S	300	410	10/06 >				S 7A66 A
power steering / servosterzo		DAF MX300S	300	410	10/06 >				S 3081 PO
Safari IC									
12		MAN D2866LOH28 Euro3	265	360	01/01 >	S 7260 PO	S 4378 NR	S 1050 A	
spheros aeroshere world SPHEROS / con climatizzatore sul tetto SPHEROS		MAN D2866LOH28 Euro3	265	360	01/01 >				S 3457 C
dryer filter / filtro essiccatore		MAN D2866LOH28 Euro3	265	360	01/01 >				S 7259 A
power steering / servosterzo		MAN D2866LOH28 Euro3	265	360	01/01 >				S 3081 PO
13		MAN D2866LOH28 Euro3	265	360	01/01 >	S 7260 PO	S 4378 NR	S 1050 A	
spheros aeroshere world SPHEROS / con climatizzatore sul tetto SPHEROS		MAN D2866LOH28 Euro3	265	360	01/01 >				S 3457 C
dryer filter / filtro essiccatore		MAN D2866LOH28 Euro3	265	360	01/01 >				S 7259 A
power steering / servosterzo		MAN D2866LOH28 Euro3	265	360	01/01 >				S 3081 PO
Safari RD									
12		DAF PR265S Euro4	265	360	10/06 >	S 5234 PE	S 6024 NE	S 7A59 A	
spheros aeroshere world SPHEROS / con climatizzatore sul tetto SPHEROS		DAF PR265S Euro4	265	360	10/06 >				S 3457 C
with air-conditioner Webasto Aerosphere World / con climatizzatore Webasto Aerosphere World		DAF PR265S Euro4	265	360	10/06 >				S 3283 C
with filter SCR-System / con filtro SCR-System		DAF PR265S Euro4	265	360	10/06 >				S 7A86 A
with filter Urea/Adblue / con filtro Urea/Adblue		DAF PR265S Euro4	265	360	10/06 >				S 4401 U
dryer filter / filtro essiccatore		DAF PR265S Euro4	265	360	10/06 >				S 7A66 A
power steering / servosterzo		DAF PR265S Euro4	265	360	10/06 >				S 3081 PO
13		DAF PR265S Euro4	265	360	10/06 >	S 5234 PE	S 6024 NE	S 7A59 A	
spheros aeroshere world / con climatizzatore sul tetto		DAF PR265S Euro4	265	360	10/06 >				S 3457 C
with air-conditioner Webasto Aerosphere World / con climatizzatore Webasto Aerosphere World		DAF PR265S Euro4	265	360	10/06 >				S 3283 C
with filter SCR-System / con filtro SCR-System		DAF PR265S Euro4	265	360	10/06 >				S 7A86 A
with filter Urea/Adblue / con filtro Urea/Adblue		DAF PR265S Euro4	265	360	10/06 >				S 4401 U
dryer filter / filtro essiccatore		DAF PR265S Euro4	265	360	10/06 >				S 7A66 A
power steering / servosterzo		DAF PR265S Euro4	265	360	10/06 >				S 3081 PO
Samba									
7		MAN D0834LFL03	132	180	01/01 >	S 3292 R		S 2650 A	



kW HP



...TEMSA - buses/autobus

dryer filter / filtro essiccatore	MAN D0834LFL03	132	180	01/01	>			S 7259 A
2 filters / N.2 filtri	MAN D0834LFL03	132	180	01/01	>		S 4378 NR	
power steering / servosterzo	MAN D0834LFL03	132	180	01/01	>			S 3081 PO
Tourmalin								
12	DAF PE228C Euro3	228	310	09/05	>		S 5234 PE	
power steering / servosterzo	DAF PE228C Euro3	228	310	09/05	>			S 3081 PO
13	DAF PE228C Euro3	228	310	09/05	>		S 5234 PE	
power steering / servosterzo	DAF PE228C Euro3	228	310	09/05	>			S 3081 PO
Intercity 12	DAF PR228S2 Euro5	228	310	10/06	>		S 5234 PE	S 6024 NE S 7A59 A
with filter SCR-System / con filtro SCR-System	DAF PR228S2 Euro5	228	310	10/06	>			S 7A86 A
with filter Urea/Adblue / con filtro Urea/Adblue	DAF PR228S2 Euro5	228	310	10/06	>			S 4401 U
dryer filter / filtro essiccatore	DAF PR228S2 Euro5	228	310	10/06	>			S 7A66 A
power steering / servosterzo	DAF PR228S2 Euro5	228	310	10/06	>			S 3081 PO
Intercity 13	DAF PR265 Euro5	265	360	05/07	>		S 5234 PE	S 6024 NE S 7A59 A
with filter SCR-System / con filtro SCR-System	DAF PR265 Euro5	265	360	05/07	>			S 7A86 A
with filter Urea/Adblue / con filtro Urea/Adblue	DAF PR265 Euro5	265	360	05/07	>			S 4401 U
dryer filter / filtro essiccatore	DAF PR265 Euro5	265	360	05/07	>			S 7A66 A
power steering / servosterzo	DAF PR265 Euro5	265	360	05/07	>			S 3081 PO
TEREX								
dump trucks/autocarri ribaltabili								
33 Serie								
33-09	Detroit Diesel 16V-71						S 3301 PO	S 7315 A
inner / interno	Detroit Diesel 16V-71							S 7314 A
33-09	Detroit Diesel 16V-71T						S 3301 PO	S 4270 A
33-11 C	Detroit Diesel 16V-92TA							S 7313 A
inner / interno	Detroit Diesel 16V-92TA							S 7312 A
drive / trasmissione	Detroit Diesel 16V-92TA							S 3301 PO
33-11 D	Detroit Diesel 16V-92TA							S 7313 A
inner / interno	Detroit Diesel 16V-92TA							S 7312 A
drive / trasmissione	Detroit Diesel 16V-92TA							S 3301 PO
33-15	Detroit Diesel 16V-149T						S 3301 PO	S 7313 A
inner / interno	Detroit Diesel 16V-149T							S 7312 A
drive / trasmissione	Detroit Diesel 16V-149T							S 3301 PO
33-15 B	Detroit Diesel 16V-149T						S 3301 PO	S 7313 A
inner / interno	Detroit Diesel 16V-149T							S 7312 A
drive / trasmissione	Detroit Diesel 16V-149T							S 3301 PO
R 17 Serie								
R 17	Cummins						S 4510 NR	S 6550 A
some / alcuni	Cummins						S 4510 NR	S 7011 A
inner / interno	Cummins							S 2840 A
steering / sterzo	Cummins							S 3301 PO
R 17	Detroit Diesel 6-71N						S 3301 PO	S 9990 A
1st passage / 1.passaggio	Detroit Diesel 6-71N						S 3301 PO	
2nd passage / 2.passaggio	Detroit Diesel 6-71N						S 3301 PO	
some / alcuni	Detroit Diesel 6-71N						S 3301 PO	S 7945 A
full-flow	Detroit Diesel 6-71N						S 3301 PO	
R 22 Serie								
R 22	Detroit Diesel 6-71T						S 3301 PO	S 9990 A
1st passage / 1.passaggio	Detroit Diesel 6-71T						S 3301 PO	
2nd passage / 2.passaggio	Detroit Diesel 6-71T						S 3301 PO	
outer / esterno	Detroit Diesel 6-71T						S 3301 PO	S 7945 A
full-flow	Detroit Diesel 6-71T						S 3301 PO	
inner / interno	Detroit Diesel 6-71T						S 3301 PO	S 7024 A
R 25 Serie								
R 25	Cummins NT 855						S 4510 NR	
spin-on / avvitabile	Cummins NT 855						S 4510 NR	S 9990 A
with 9387554 / con 9387554	Cummins NT 855							
R 35 Serie								
R 35	Cummins							S 9990 A
some / alcuni	Cummins							S 5450 A
R 35	Detroit Diesel 12V-71N						S 3301 PO	S 9990 A
with 9029638 / con 9029638	Detroit Diesel 12V-71N						S 3301 PO	S 7010 A
with 9030854 / con 9030854	Detroit Diesel 12V-71N						S 3301 PO	S 3450 A
inner / interno	Detroit Diesel 12V-71N							S 3301 PO
drive / trasmissione	Detroit Diesel 12V-71N							S 3301 PO
R 35	Detroit Diesel 16V-71N						S 3301 PO	S 5450 A
with 9029638 / con 9029638	Detroit Diesel 16V-71N						S 3301 PO	S 9990 A





kW HP



...TEREX - dump trucks/autocarri ribaltabili

R 70	Detroit Diesel 16V-71T		S 3301 PO		
THERMO KING		refrigeration units/gruppi refrigeranti			
AO Serie					
2961	Mercedes Benz OM636V1E		S 3081 PO	S 0201 N	
2nd passage / 2.passaggio	Mercedes Benz OM636V1E			S 1411 N	
some / alcuni	Mercedes Benz OM636V1E			S 0201 N	
CGM Serie					
CGM 43			S 5800 R	S 0810 NR	
CGSM Serie					
122			S 5800 R	S 0810 NR	
spin-on / avvitabile					
129			S 5800 R	S 0810 NR	
spin-on / avvitabile					
142			S 5800 R	S 0810 NR	
spin-on / avvitabile					
145			S 5800 R	S 0810 NR	
spin-on / avvitabile					
147			S 5800 R	S 0810 NR	
spin-on / avvitabile					
150			S 5800 R	S 0810 NR	
spin-on / avvitabile					
151			S 5800 R	S 0810 NR	
spin-on / avvitabile					
152			S 5800 R	S 0810 NR	
spin-on / avvitabile					
18			S 5800 R		
spin-on / avvitabile					
19			S 5800 R		
spin-on / avvitabile					
253			S 5800 R	S 0810 NR	
spin-on / avvitabile					
29			S 5800 R		
spin-on / avvitabile					
31			S 5800 R		
spin-on / avvitabile					
Crown Serie					
500	Isuzu C 201 PT		S 5800 R		
1st passage spin-on / 1.passaggio avvitabile	Isuzu C 201 PT		S 5800 R	S 0810 NR	
500	Mercedes Benz OM636		S 0300 O		
1st passage / 1.passaggio	Mercedes Benz OM636		S 0300 O	S 0810 NR	
500	Mercedes Benz OM636V1E		S 3081 PO	S 0201 N	
2nd passage / 2.passaggio	Mercedes Benz OM636V1E			S 1411 N	
GS Serie					
1250 D	Mercedes Benz OM636		S 0300 O		
1st passage spin-on / 1.passaggio avvitabile	Mercedes Benz OM636		S 0300 O	S 0810 NR	
1250 D	Mercedes Benz OM636V1E		S 3081 PO	S 0201 N	
2nd passage / 2.passaggio	Mercedes Benz OM636V1E			S 1411 N	
Super GS 1250 D	C 201 PT		S 5800 R	S 0810 NR	
MD Serie					
MD 1 SS 11	Diesel			S 0810 NR	
MD 1 SS II	Diesel			S 0810 NR	
XMD	RDJA	01/79 >	S 5800 R		
NWD Serie					
NWD	Mercedes Benz OM636		S 0300 O		
1st passage spin-on / 1.passaggio avvitabile	Mercedes Benz OM636		S 0300 O	S 0810 NR	
NWD	Mercedes Benz OM636V1E		S 3081 PO	S 0201 N	
2nd passage / 2.passaggio	Mercedes Benz OM636V1E			S 1411 N	
Super NWD	Isuzu C 201 PT		S 5800 R		
1st passage spin-on / 1.passaggio avvitabile	Isuzu C 201 PT		S 5800 R	S 0810 NR	
XNWD 30	C 201 PT		S 5800 R	S 0810 NR	
RCD Serie					
50			S 5800 R		
spin-on / avvitabile					
S Serie					
SRL			S 0012 O		
SB Serie					

T





kW HP



...THERMO KING - refrigeration units/gruppi refrigeranti

SB 1	C 201		S 5800 R	S 0810 NR		
SB 1	Isuzu		S 5800 R	S 0810 NR		
SB 2			S 5800 R			
TWD Serie						
30	C 201 PT			S 0810 NR		
50	C 201 PT			S 0810 NR		
U Serie						
UL			S 0012 O			
UWD Serie						
UWD	Mercedes Benz OM636		S 0300 O			
1st passage spin-on / 1.passaggio avvitabile	Mercedes Benz OM636		S 0300 O	S 0810 NR		
UWD	Mercedes Benz OM636V1E		S 3081 PO	S 0201 N		
2nd passage / 2.passaggio	Mercedes Benz OM636V1E			S 1411 N		
VWD Serie						
30 C			S 3081 PO			
with double filter, 1st passage / con filtro doppio, 1.passaggio			S 3081 PO	S 7411 N		
with single filter / con filtro singolo			S 3081 PO	S 0201 N		
30 C	Mercedes Benz			S 1411 N		
2nd passage / 2.passaggio	Mercedes Benz					
Windjammer Serie						
500	Isuzu C 201 PT		S 5800 R			
1st passage spin-on / 1.passaggio avvitabile	Isuzu C 201 PT		S 5800 R	S 0810 NR		
500	Mercedes Benz OM636		S 0300 O			
1st passage / 1.passaggio	Mercedes Benz OM636		S 0300 O	S 0810 NR		
500	Mercedes Benz OM636V1E		S 3081 PO	S 0201 N		
2nd passage / 2.passaggio	Mercedes Benz OM636V1E			S 1411 N		

UMBRAMECCANICA

trucks/autocarri

Cobra's

35	Ford	51	70	S 3280 R	S 9960 NC	S 3330 A
35 4x4 GT	Ford	51	70	S 3280 R	S 9960 NC	S 3330 A

Dollaro

Dollaro	Aifo-Iveco			S 3003 DR	S 7111 NC	S 1540 A
Dollaro Turbo	Aifo-Iveco			S 3003 DR	S 8500 NR	S 4940 A
with fuel oil heater / con riscaldatore nafta	Aifo-Iveco			S 3003 DR	S 8501 NR	S 4940 A

VAN HOOL

buses/autobus

1000 Serie

1165TR				S 8600 R		
some / alcuni	Renault MID 06.20.30			S 8600 R	S 3010 N	
some / alcuni	Renault MID 06.20.30			S 8600 R	S 4323 NR	
spin-on / avvitabile	Renault MID 06.20.30					
1205TR				S 8600 R	S 3010 N	
some / alcuni	Renault MIDS 06.20.30			S 8600 R	S 3010 N	
some / alcuni	Renault MIDS 06.20.30			S 8600 R	S 4323 NR	
spin-on / avvitabile	Renault MIDS 06.20.30					
1245TR				S 8600 R	S 3010 N	
some / alcuni	Renault MIDS 06.20.30			S 8600 R	S 3010 N	
some / alcuni	Renault MIDS 06.20.30			S 8600 R	S 4323 NR	
spin-on / avvitabile	Renault MIDS 06.20.30					

2000 Serie

2165TR				S 8600 R	S 3010 N	
some / alcuni	Renault MID 06.20.30			S 8600 R	S 3010 N	
some / alcuni	Renault MID 06.20.30			S 8600 R	S 4323 NR	
spin-on / avvitabile	Renault MID 06.20.30					
2185				S 8600 R	S 3010 N	
some / alcuni	Renault MIDS 06.20.30			S 8600 R	S 3010 N	
some / alcuni	Renault MIDS 06.20.30			S 8600 R	S 4323 NR	
spin-on / avvitabile	Renault MIDS 06.20.30					
2205TR				S 8600 R	S 3010 N	
some / alcuni	Renault MIDS 06.20.30			S 8600 R	S 3010 N	
some / alcuni	Renault MIDS 06.20.30			S 8600 R	S 4323 NR	
spin-on / avvitabile	Renault MIDS 06.20.30					
2245				S 8600 R	S 3010 N	
some / alcuni	Renault MIDS 06.20.30			S 8600 R	S 3010 N	
some / alcuni	Renault MIDS 06.20.30			S 8600 R	S 4323 NR	
spin-on / avvitabile	Renault MIDS 06.20.30					



kW HP



...VAN HOOL - buses/autobus

2245TR								
some / alcuni	Renault MIDS 06.20.30			S 8600 R	S 3010 N			
some / alcuni	Renault MIDS 06.20.30			S 8600 R				
spin-on / avvitabile	Renault MIDS 06.20.30			S 8600 R	S 4323 NR			
4000 Serie								
4165TR								
some / alcuni	Renault MID 06.20.30			S 8600 R	S 3010 N			
some / alcuni	Renault MID 06.20.30			S 8600 R				
spin-on / avvitabile	Renault MID 06.20.30			S 8600 R	S 4323 NR			
4205								
some / alcuni	Renault MIDS 06.20.30			S 8600 R				
some / alcuni	Renault MIDS 06.20.30			S 8600 R	S 3010 N			
spin-on / avvitabile	Renault MIDS 06.20.30			S 8600 R	S 4323 NR			
4205TR								
some / alcuni	Renault MIDS 06.20.30			S 8600 R				
some / alcuni	Renault MIDS 06.20.30			S 8600 R	S 3010 N			
spin-on / avvitabile	Renault MIDS 06.20.30			S 8600 R	S 4323 NR			
4245								
some / alcuni	Renault MIDS 06.20.30			S 8600 R	S 3010 N			
some / alcuni	Renault MIDS 06.20.30			S 8600 R				
spin-on / avvitabile	Renault MIDS 06.20.30			S 8600 R	S 4323 NR			
4245TR								
some / alcuni	Renault MIDS 06.20.30			S 8600 R	S 3010 N			
some / alcuni	Renault MIDS 06.20.30			S 8600 R				
spin-on / avvitabile	Renault MIDS 06.20.30			S 8600 R	S 4323 NR			
A Serie								
A120	DAF DKL1160		01/79 >	S 8600 R	S 8110 NR			
power steering / servosterzo	DAF DKL1160		01/79 >					S 8790 PO
A120	MAN D2566MUH		01/79 >	S 7260 PO	S 0201 N			
2nd passage / 2.passaggio	MAN D2566MUH		01/79 >		S 1411 N			
power steering / servosterzo	MAN D2566MUH		01/79 >					S 8790 PO
A120P Intercity	MAN D2566MUH		01/79 >	S 7260 PO	S 0201 N			
2nd passage / 2.passaggio	MAN D2566MUH		01/79 >		S 1411 N			
power steering / servosterzo	MAN D2566MUH		01/79 >					S 8790 PO
A300T								
with air-conditioner Webasto Aerosphere World / con climatizzatore Webasto Aerosphere World	Electric	200 272	01/05 >					S 3283 C
dryer filter / filtro essiccatore	Electric	200 272	01/05 >					S 7A66 A
power steering / servosterzo	Electric	200 272	01/05 >					S 3081 PO
A308	MAN D0836LOH	176 239	05/06 >	S 3292 R	S 6011 NE	S 7564 A		
with air-conditioner Webasto Aerosphere World / con climatizzatore Webasto Aerosphere World	MAN D0836LOH	176 239	05/06 >					S 3283 C
dryer filter / filtro essiccatore	MAN D0836LOH	176 239	05/06 >					S 7A66 A
power steering / servosterzo	MAN D0836LOH	176 239	05/06 >					S 3081 PO
A309	Cummins ISBe225	165 225	05/06 >		S 2220 NR			
with air-conditioner Webasto Aerosphere World / con climatizzatore Webasto Aerosphere World	Cummins ISBe225	165 225	05/06 >					S 3283 C
with filter SCR-System / con filtro SCR-System	Cummins ISBe225	165 225	05/06 >					S 7A86 A
with filter Urea/Adblue / con filtro Urea/Adblue	Cummins ISBe225	165 225	05/06 >					S 4401 U
dryer filter / filtro essiccatore	Cummins ISBe225	165 225	05/06 >					S 7A66 A
power steering / servosterzo	Cummins ISBe225	165 225	05/06 >					S 3081 PO
A330	DAF PR183 Euro5	183 249	09/08 >	S 5234 PE	S 6146 NE	S 7564 A		
with air-conditioner Webasto Aerosphere World / con climatizzatore Webasto Aerosphere World	DAF PR183 Euro5	183 249	09/08 >					S 3283 C
with filter SCR-System / con filtro SCR-System	DAF PR183 Euro5	183 249	09/08 >					S 7A86 A
with filter Urea/Adblue / con filtro Urea/Adblue	DAF PR183 Euro5	183 249	09/08 >					S 4401 U
dryer filter / filtro essiccatore	DAF PR183 Euro5	183 249	09/08 >					S 7A66 A
rotor for oil centrifuge / rotore per filtro olio centrifugo	DAF PR183 Euro5	183 249	09/08 >	S 5902 PO				
power steering / servosterzo	DAF PR183 Euro5	183 249	09/08 >					S 3081 PO
A330	DAF PR228 Euro5/EEV	228 310	09/08 >	S 5234 PE	S 6146 NE	S 7564 A		
with air-conditioner Webasto Aerosphere World (4 filters) / con climatizzatore Webasto Aerosphere World (N.4 filtri)	DAF PR228 Euro5/EEV	228 310	09/08 >					S 3283 C
with filter SCR-System / con filtro SCR-System	DAF PR228 Euro5/EEV	228 310	09/08 >					S 7A86 A
with filter Urea/Adblue / con filtro Urea/Adblue	DAF PR228 Euro5/EEV	228 310	09/08 >					S 4401 U
dryer filter / filtro essiccatore	DAF PR228 Euro5/EEV	228 310	09/08 >					S 7A66 A
rotor for oil centrifuge / rotore per filtro olio centrifugo	DAF PR228 Euro5/EEV	228 310	09/08 >	S 5902 PO				
power steering / servosterzo	DAF PR228 Euro5/EEV	228 310	09/08 >					S 3081 PO
A330	MAN D2066LOH E5/EEV	235 320	05/08 >	S 5046 PE	S 6011 NE	S 7564 A		
with air-conditioner Webasto Aerosphere World / con climatizzatore Webasto Aerosphere World	MAN D2066LOH E5/EEV	235 320	05/08 >					S 3283 C
dryer filter / filtro essiccatore	MAN D2066LOH E5/EEV	235 320	05/08 >					S 7A66 A
power steering / servosterzo	MAN D2066LOH E5/EEV	235 320	05/08 >					S 3081 PO
A360	DAF PR183 Euro5	183 249	09/08 >	S 5234 PE	S 6146 NE			

V



**KW HP****...VAN HOOL - buses/autobus**

with air-conditioner Webasto Aerosphere World / con climatizzatore Webasto Aerosphere World	DAF PR183 Euro5	183	249	09/08	>				S 3283 C
with filter SCR-System / con filtro SCR-System	DAF PR183 Euro5	183	249	09/08	>				S 7A86 A
with filter Urea/Adblue / con filtro Urea/Adblue	DAF PR183 Euro5	183	249	09/08	>				S 4401 U
dryer filter / filtro essiccatore	DAF PR183 Euro5	183	249	09/08	>				S 7A66 A
rotor for oil centrifuge / rotore per filtro olio centrifugo	DAF PR183 Euro5	183	249	09/08	>	S 5902 PO			
power steering / servosterzo	DAF PR183 Euro5	183	249	09/08	>				S 3081 PO
A360	MAN D2066LOH E5/EEV	235	320	05/08	>	S 5046 PE	S 6011 NE		
with air-conditioner Webasto Aerosphere World / con climatizzatore Webasto Aerosphere World	MAN D2066LOH E5/EEV	235	320	05/08	>				S 3283 C
dryer filter / filtro essiccatore	MAN D2066LOH E5/EEV	235	320	05/08	>				S 7A66 A
power steering / servosterzo	MAN D2066LOH E5/EEV	235	320	05/08	>				S 3081 PO
AG300	DAF PE228C Euro3	228	310	03/03	>	S 5045 PE	S 6009 NE	S 7641 A	
with air-conditioner Webasto Aerosphere World / con climatizzatore Webasto Aerosphere World	DAF PE228C Euro3	228	310	03/03	>				S 3283 C
LONG LIFE	DAF PE228C Euro3	228	310	03/03	>	S 5234 PE	S 6146 NE		
rotor for oil centrifuge / rotore per filtro olio centrifugo	DAF PE228C Euro3	228	310	03/03	>	S 5902 PO			
power steering / servosterzo	DAF PE228C Euro3	228	310	03/03	>				S 3081 PO
AG300	DAF PE265C Euro3	265	360	03/03	>	S 5045 PE	S 6009 NE	S 7641 A	
with air-conditioner Webasto Aerosphere World / con climatizzatore Webasto Aerosphere World	DAF PE265C Euro3	265	360	03/03	>				S 3283 C
LONG LIFE	DAF PE265C Euro3	265	360	03/03	>	S 5234 PE	S 6146 NE		
rotor for oil centrifuge / rotore per filtro olio centrifugo	DAF PE265C Euro3	265	360	03/03	>	S 5902 PO			
power steering / servosterzo	DAF PE265C Euro3	265	360	03/03	>				S 3081 PO
AG300	DAF PR228 Euro5/EEV	228	310	09/08	>	S 5234 PE	S 6146 NE	S 7564 A	
with air-conditioner Webasto Aerosphere World / con climatizzatore Webasto Aerosphere World	DAF PR228 Euro5/EEV	228	310	09/08	>				S 3283 C
with filter SCR-System / con filtro SCR-System	DAF PR228 Euro5/EEV	228	310	09/08	>				S 7A86 A
with filter Urea/Adblue / con filtro Urea/Adblue	DAF PR228 Euro5/EEV	228	310	09/08	>				S 4401 U
dryer filter / filtro essiccatore	DAF PR228 Euro5/EEV	228	310	09/08	>				S 7A66 A
rotor for oil centrifuge / rotore per filtro olio centrifugo	DAF PR228 Euro5/EEV	228	310	09/08	>	S 5902 PO			
power steering / servosterzo	DAF PR228 Euro5/EEV	228	310	09/08	>				S 3081 PO
AG300	DAF PR265 Euro5/EEV	265	360	09/08	>	S 5234 PE	S 6146 NE		
with air-conditioner Webasto Aerosphere World / con climatizzatore Webasto Aerosphere World	DAF PR265 Euro5/EEV	265	360	09/08	>				S 3283 C
with filter SCR-System / con filtro SCR-System	DAF PR265 Euro5/EEV	265	360	09/08	>				S 7A86 A
with filter Urea/Adblue / con filtro Urea/Adblue	DAF PR265 Euro5/EEV	265	360	09/08	>				S 4401 U
dryer filter / filtro essiccatore	DAF PR265 Euro5/EEV	265	360	09/08	>				S 7A66 A
rotor for oil centrifuge / rotore per filtro olio centrifugo	DAF PR265 Euro5/EEV	265	360	09/08	>	S 5902 PO			
power steering / servosterzo	DAF PR265 Euro5/EEV	265	360	09/08	>				S 3081 PO
AG300	MAN D2066LOH E5/EEV	265	360	05/08	>	S 5046 PE	S 6011 NE	S 7564 A	
with air-conditioner Webasto Aerosphere World / con climatizzatore Webasto Aerosphere World	MAN D2066LOH E5/EEV	265	360	05/08	>				S 3283 C
dryer filter / filtro essiccatore	MAN D2066LOH E5/EEV	265	360	05/08	>				S 7259 A
power steering / servosterzo	MAN D2066LOH E5/EEV	265	360	05/08	>				S 3081 PO
AG300	MAN D2865LOH	235	320	07/92	>	S 7260 PO			S 3283 C
with air-conditioner Webasto Aerosphere World / con climatizzatore Webasto Aerosphere World	MAN D2865LOH	235	320	07/92	>		S 4378 NR		
2 filters / N.2 filtri	MAN D2865LOH	235	320	07/92	>				
AG300	MAN D2866LOH27	228	310	09/03	>	S 5016 PE		S 7641 A	
with air-conditioner Webasto Aerosphere World / con climatizzatore Webasto Aerosphere World	MAN D2866LOH27	228	310	09/03	>				S 3283 C
dryer filter / filtro essiccatore	MAN D2866LOH27	228	310	09/03	>				S 7A66 A
2 filters / N.2 filtri	MAN D2866LOH27	228	310	09/03	>		S 4378 NR		
power steering / servosterzo	MAN D2866LOH27	228	310	09/03	>				S 3081 PO
AGG300	DAF PE265C Euro3	265	360	10/02	>	S 5045 PE	S 6009 NE	S 7641 A	
with air-conditioner Webasto Aerosphere World (4 filters) / con climatizzatore Webasto Aerosphere World (N.4 filtri)	DAF PE265C Euro3	265	360	10/02	>				S 3283 C
LONG LIFE	DAF PE265C Euro3	265	360	10/02	>	S 5234 PE	S 6146 NE		
rotor for oil centrifuge / rotore per filtro olio centrifugo	DAF PE265C Euro3	265	360	10/02	>	S 5902 PO			
power steering / servosterzo	DAF PE265C Euro3	265	360	10/02	>				S 3081 PO
AGG300	DAF PR265 Euro5/EEV	265	360	09/08	>	S 5234 PE	S 6146 NE		
with air-conditioner Webasto Aerosphere World / con climatizzatore Webasto Aerosphere World	DAF PR265 Euro5/EEV	265	360	09/08	>				S 3283 C
with filter SCR-System / con filtro SCR-System	DAF PR265 Euro5/EEV	265	360	09/08	>				S 7A86 A
with filter Urea/Adblue / con filtro Urea/Adblue	DAF PR265 Euro5/EEV	265	360	09/08	>				S 4401 U
dryer filter / filtro essiccatore	DAF PR265 Euro5/EEV	265	360	09/08	>				S 7A66 A
rotor for oil centrifuge / rotore per filtro olio centrifugo	DAF PR265 Euro5/EEV	265	360	09/08	>	S 5902 PO			
power steering / servosterzo	DAF PR265 Euro5/EEV	265	360	09/08	>				S 3081 PO
AGG300	MAN D2866LOH	265	360	05/03	>	S 5016 PE		S 7641 A	
with air-conditioner Webasto Aerosphere World / con climatizzatore Webasto Aerosphere World	MAN D2866LOH	265	360	05/03	>				S 3283 C
dryer filter / filtro essiccatore	MAN D2866LOH	265	360	05/03	>				S 7A66 A
2 filters / N.2 filtri	MAN D2866LOH	265	360	05/03	>		S 4378 NR		
power steering / servosterzo	MAN D2866LOH	265	360	05/03	>				S 3081 PO
AU138 Midibus	Renault 798			01/80	>	S 3241 R	S 7111 NC		
Alizée Serie									
750	Aifo-Iveco 8220.20					S 8600 R	S 5401 NR	S 0150 A	
or / oppure	Aifo-Iveco 8220.20						S 5400 NR		



kW HP



...VAN HOOL - buses/autobus

power steering / servosterzo	Aifo-Iveco 8220.20						S 8790 PO
760	Aifo-Iveco 8210.02				S 0230 R	S 0710 NR	
power steering / servosterzo	Aifo-Iveco 8210.02						S 8790 PO
760	Daf DKT1160				S 8600 R	S 8110 NR	
cartridge / immersione	Daf DKT1160				S 8600 R	S 1411 N	
power steering / servosterzo	Daf DKT1160						S 8790 PO
760	MAN D2566MTH				S 7260 PO	S 0201 N	
2nd passage / 2.passaggio	MAN D2566MTH					S 1411 N	
90F	Aifo-Iveco 8060.04				S 0700 R	S 7111 NC	
with antidraining pipe / con tubo antisvuotamento	Aifo-Iveco 8060.04				S 9610 R		
CL Serie							
CL 915	DAF MX340	340	462	09/05 >	S 5081 PE	S 6024 NE	
with filter SCR-System / con filtro SCR-System	DAF MX340	340	462	09/05 >			S 7A86 A
with filter Urea/Adblue / con filtro Urea/Adblue	DAF MX340	340	462	09/05 >			S 4401 U
dryer filter / filtro essiccatore	DAF MX340	340	462	09/05 >			S 7F14 A
prefilter / prefiltra	DAF MX340	340	462	09/05 >		S 4142 NR	
rotor for oil centrifuge / rotore per filtro olio centrifugo	DAF MX340	340	462	09/05 >	S 5904 PO		
power steering / servosterzo	DAF MX340	340	462	09/05 >			S 3081 PO
CL 915	MAN D2066LOH28	294	400	09/05 >	S 5046 PE	S 6011 NE	
dryer filter / filtro essiccatore	MAN D2066LOH28	294	400	09/05 >			S 7A66 A
prefilter / prefiltra	MAN D2066LOH28	294	400	09/05 >		S 6088 NE	
power steering / servosterzo	MAN D2066LOH28	294	400	09/05 >			S 3081 PO
CL 916	DAF MX300S	300	410	09/08 >	S 5081 PE	S 6024 NE	
with filter SCR-System / con filtro SCR-System	DAF MX300S	300	410	09/08 >			S 7A86 A
with filter Urea/Adblue / con filtro Urea/Adblue	DAF MX300S	300	410	09/08 >			S 4401 U
dryer filter / filtro essiccatore	DAF MX300S	300	410	09/08 >			S 7F14 A
prefilter / prefiltra	DAF MX300S	300	410	09/08 >		S 4142 NR	
rotor for oil centrifuge / rotore per filtro olio centrifugo	DAF MX300S	300	410	09/08 >	S 5904 PO		
power steering / servosterzo	DAF MX300S	300	410	09/08 >			S 3081 PO
CL 916	DAF MX340	340	462	09/05 >	S 5081 PE	S 6024 NE	
with filter SCR-System / con filtro SCR-System	DAF MX340	340	462	09/05 >			S 7A86 A
with filter Urea/Adblue / con filtro Urea/Adblue	DAF MX340	340	462	09/05 >			S 4401 U
dryer filter / filtro essiccatore	DAF MX340	340	462	09/05 >			S 7F14 A
prefilter / prefiltra	DAF MX340	340	462	09/05 >		S 4142 NR	
rotor for oil centrifuge / rotore per filtro olio centrifugo	DAF MX340	340	462	09/05 >	S 5904 PO		
power steering / servosterzo	DAF MX340	340	462	09/05 >			S 3081 PO
CL 916	DAF XE355C	355	483	09/04 >	S 5234 PE	S 6146 NE	S 7641 A
dryer filter / filtro essiccatore	DAF XE355C	355	483	09/04 >			S 7A66 A
inner / interno	DAF XE355C	355	483	09/04 >			S 0768 A
rotor for oil centrifuge / rotore per filtro olio centrifugo	DAF XE355C	355	483	09/04 >	S 5902 PO		
power steering / servosterzo	DAF XE355C	355	483	09/04 >			S 3081 PO
CL 916	MAN D2066LOH07	294	400	09/08 >	S 5046 PE	S 6011 NE	
with filter Urea/Adblue / con filtro Urea/Adblue	MAN D2066LOH07	294	400	09/08 >			S 4401 U
dryer filter / filtro essiccatore	MAN D2066LOH07	294	400	09/08 >			S 7A66 A
power steering / servosterzo	MAN D2066LOH07	294	400	09/08 >			S 3081 PO
CL 916	MAN D2066LOH28	294	400	09/05 >	S 5046 PE	S 6011 NE	
dryer filter / filtro essiccatore	MAN D2066LOH28	294	400	09/05 >			S 7A66 A
prefilter / prefiltra	MAN D2066LOH28	294	400	09/05 >		S 6088 NE	
power steering / servosterzo	MAN D2066LOH28	294	400	09/05 >			S 3081 PO
CL 916	MAN D2676LOH27 EEV	353	480	09/08 >	S 5046 PE	S 6011 NE	
dryer filter / filtro essiccatore	MAN D2676LOH27 EEV	353	480	09/08 >			S 7A66 A
prefilter / prefiltra	MAN D2676LOH27 EEV	353	480	09/08 >		S 6088 NE	
power steering / servosterzo	MAN D2676LOH27 EEV	353	480	09/08 >			S 3081 PO
S Serie							
S315	Aifo-Iveco 8060.04				S 0700 R	S 7111 NC	
with antidraining pipe / con tubo antisvuotamento	Aifo-Iveco 8060.04				S 9610 R		
T8 Acron Serie							
T815	Aifo-Iveco 8210.02				S 0230 R	S 0710 NR	
power steering / servosterzo	Aifo-Iveco 8210.02						S 8790 PO
T815	Daf DKT1160				S 8600 R	S 8110 NR	
cartridge / immersione	Daf DKT1160				S 8600 R	S 1411 N	
power steering / servosterzo	Daf DKT1160						S 8790 PO
T8 Alizée Serie							
T815	Aifo-Iveco 8210.02				S 0230 R	S 0710 NR	
power steering / servosterzo	Aifo-Iveco 8210.02						S 8790 PO
T815	Daf DKT1160				S 8600 R	S 8110 NR	
cartridge / immersione	Daf DKT1160				S 8600 R	S 1411 N	

V





kW HP



...VAN HOOL - buses/autobus

power steering / servosterzo	Daf DKT1160						S 8790 PO
T815	MAN D2566MTH				S 7260 PO	S 0201 N	
2nd passage / 2.passeggio	MAN D2566MTH					S 1411 N	
T8 Astron Serie							
T818	MAN D2566MTUH				S 7260 PO	S 0201 N	
2nd passage / 2.passeggio	MAN D2566MTUH					S 1411 N	
power steering / servosterzo	MAN D2566MTUH						S 8790 PO
T9 Acron Serie							
T917 Acron	MAN D2866LOH29	301 410	09/04 >		S 5016 PE		S 7A13 A
2 filters / N.2 filtri	MAN D2866LOH29	301 410	09/04 >			S 4378 NR	
power steering / servosterzo	MAN D2866LOH29	301 410	09/04 >				S 3081 PO
T9 Altano Serie							
T917 Altano	MAN D2866LOH29	301 410	09/04 >		S 5016 PE		S 7A13 A
2 filters / N.2 filtri	MAN D2866LOH29	301 410	09/04 >			S 4378 NR	
power steering / servosterzo	MAN D2866LOH29	301 410	09/04 >				S 3081 PO
T917 Altano	MAN D2876LOH02	338 460	09/04 >		S 5016 PE		S 7A13 A
2 filters / N.2 filtri	MAN D2876LOH02	338 460	09/04 >			S 4378 NR	
power steering / servosterzo	MAN D2876LOH02	338 460	09/04 >				S 3081 PO
T9 Altino Serie							
T915 Altino	DAF PR265	265 360	10/11 >		S 5234 PE	S 6146 NE	
with filter SCR-System / con filtro SCR-System	DAF PR265	265 360	10/11 >				S 7A86 A
with filter Urea/Adblue / con filtro Urea/Adblue	DAF PR265	265 360	10/11 >				S 4401 U
prefilter / prefiltra	DAF PR265	265 360	10/11 >			S 4142 NR	
rotor for oil centrifuge / rotore per filtro olio centrifugo	DAF PR265	265 360	10/11 >		S 5902 PO		
power steering / servosterzo	DAF PR265	265 360	10/11 >				S 3081 PO
T915 Altino	MAN D2066LOH28	294 400	10/11 >		S 5046 PE	S 6011 NE	
prefilter / prefiltra	MAN D2066LOH28	294 400	10/11 >			S 6088 NE	
power steering / servosterzo	MAN D2066LOH28	294 400	10/11 >				S 3081 PO
T916 Altino	DAF PR265	265 360	10/11 >		S 5234 PE	S 6146 NE	
with filter SCR-System / con filtro SCR-System	DAF PR265	265 360	10/11 >				S 7A86 A
with filter Urea/Adblue / con filtro Urea/Adblue	DAF PR265	265 360	10/11 >				S 4401 U
prefilter / prefiltra	DAF PR265	265 360	10/11 >			S 4142 NR	
rotor for oil centrifuge / rotore per filtro olio centrifugo	DAF PR265	265 360	10/11 >		S 5902 PO		
power steering / servosterzo	DAF PR265	265 360	10/11 >				S 3081 PO
T916 Altino	MAN D2066LOH28	294 400	10/11 >		S 5046 PE	S 6011 NE	
prefilter / prefiltra	MAN D2066LOH28	294 400	10/11 >			S 6088 NE	
power steering / servosterzo	MAN D2066LOH28	294 400	10/11 >				S 3081 PO
T9 Alton Serie							
T915 Alton	DAF PR265	265 360	10/11 >		S 5234 PE	S 6146 NE	
with filter SCR-System / con filtro SCR-System	DAF PR265	265 360	10/11 >				S 7A86 A
with filter Urea/Adblue / con filtro Urea/Adblue	DAF PR265	265 360	10/11 >				S 4401 U
prefilter / prefiltra	DAF PR265	265 360	10/11 >			S 4142 NR	
rotor for oil centrifuge / rotore per filtro olio centrifugo	DAF PR265	265 360	10/11 >		S 5902 PO		
power steering / servosterzo	DAF PR265	265 360	10/11 >				S 3081 PO
T915 Alton	MAN D2066LOH28	294 400	10/11 >		S 5046 PE	S 6011 NE	
prefilter / prefiltra	MAN D2066LOH28	294 400	10/11 >			S 6088 NE	
power steering / servosterzo	MAN D2066LOH28	294 400	10/11 >				S 3081 PO
T916 Alton	DAF PR265	265 360	10/11 >		S 5234 PE	S 6146 NE	
with filter SCR-System / con filtro SCR-System	DAF PR265	265 360	10/11 >				S 7A86 A
with filter Urea/Adblue / con filtro Urea/Adblue	DAF PR265	265 360	10/11 >				S 4401 U
prefilter / prefiltra	DAF PR265	265 360	10/11 >			S 4142 NR	
rotor for oil centrifuge / rotore per filtro olio centrifugo	DAF PR265	265 360	10/11 >		S 5902 PO		
power steering / servosterzo	DAF PR265	265 360	10/11 >				S 3081 PO
T916 Alton	MAN D2066LOH28	294 400	10/11 >		S 5046 PE	S 6011 NE	
prefilter / prefiltra	MAN D2066LOH28	294 400	10/11 >			S 6088 NE	
power steering / servosterzo	MAN D2066LOH28	294 400	10/11 >				S 3081 PO
T9 Astron Serie							
T916 Astron	DAF XE355C	355 483	09/04 >		S 5234 PE	S 6146 NE	S 7641 A
dryer filter / filtro essiccatore	DAF XE355C	355 483	09/04 >				S 7A66 A
inner / interno	DAF XE355C	355 483	09/04 >				S 0768 A
rotor for oil centrifuge / rotore per filtro olio centrifugo	DAF XE355C	355 483	09/04 >		S 5902 PO		
power steering / servosterzo	DAF XE355C	355 483	09/04 >				S 3081 PO
T9 Serie							
T911	DAF PR265S	265 360	09/06 >		S 5234 PE	S 6146 NE	S 7564 A
prefilter / prefiltra	DAF PR265S	265 360	09/06 >			S 4142 NR	
rotor for oil centrifuge / rotore per filtro olio centrifugo	DAF PR265S	265 360	09/06 >		S 5902 PO		
T911	MAN D2066LF27	265 360	09/05 >		S 5046 PE	S 6011 NE	S 7564 A



KW HP



...VAN HOOL - buses/autobus

prefilter / prefiltrato	MAN D2066LF27	265	360	09/05	>		S 6088 NE		
T915	MAN D2866LOH06	309	420	09/96	>	S 7260 PO		S 7A13 A	
dryer filter / filtro essiccatore	MAN D2866LOH06	309	420	09/96	>				S 7259 A
power steering / servosterzo	MAN D2866LOH06	309	420	09/96	>				S 3081 PO
T915	MAN D2866LOH07	274	373	09/96	>	S 7260 PO		S 7A13 A	
dryer filter / filtro essiccatore	MAN D2866LOH07	274	373	09/96	>				S 7259 A
power steering / servosterzo	MAN D2866LOH07	274	373	09/96	>				S 3081 PO
T915	MAN D2866LOH24	230	313	09/96	>	S 7260 PO		S 7A13 A	
dryer filter / filtro essiccatore	MAN D2866LOH24	230	313	09/96	>				S 7259 A
power steering / servosterzo	MAN D2866LOH24	230	313	09/96	>				S 3081 PO
TD8 Astromega Serie									
TD824	Mercedes Benz OM422					S 7261 PO	S 0101 N		
2nd passage / 2.passaggio	Mercedes Benz OM422						S 7411 N		
power steering / servosterzo	Mercedes Benz OM422								S 8790 PO
TD9 Astromega Serie									
TD924 Astromega	MAN D2876LOH02	338	460	09/04	>	S 5016 PE		S 7A13 A	
2 filters / N.2 filtri	MAN D2876LOH02	338	460	09/04	>		S 4378 NR		
power steering / servosterzo	MAN D2876LOH02	338	460	09/04	>				S 3081 PO
TD927 Astromega	DAF XE355C	355	483	09/04	>	S 5234 PE	S 6146 NE	S 7641 A	
dryer filter / filtro essiccatore	DAF XE355C	355	483	09/04	>				S 7A66 A
inner / interno	DAF XE355C	355	483	09/04	>			S 0768 A	
rotor for oil centrifuge / rotore per filtro olio centrifugo	DAF XE355C	355	483	09/04	>	S 5902 PO			
power steering / servosterzo	DAF XE355C	355	483	09/04	>				S 3081 PO
TD927 Astromega	MAN D2676LOH27	353	480	09/08	>	S 5046 PE	S 6011 NE		
TL9 Serie									
TL915	MAN D2866LOH06	309	420	09/96	>	S 7260 PO		S 7A13 A	
dryer filter / filtro essiccatore	MAN D2866LOH06	309	420	09/96	>				S 7259 A
power steering / servosterzo	MAN D2866LOH06	309	420	09/96	>				S 3081 PO
TL915	MAN D2866LOH07	274	373	09/96	>	S 7260 PO		S 7A13 A	
dryer filter / filtro essiccatore	MAN D2866LOH07	274	373	09/96	>				S 7259 A
power steering / servosterzo	MAN D2866LOH07	274	373	09/96	>				S 3081 PO
TL915	MAN D2866LOH24	230	313	09/96	>	S 7260 PO		S 7A13 A	
dryer filter / filtro essiccatore	MAN D2866LOH24	230	313	09/96	>				S 7259 A
power steering / servosterzo	MAN D2866LOH24	230	313	09/96	>				S 3081 PO
VDL BUS & COACH buses/autobus									
Citea									
CLF 120	Cummins ISBe4-250	184	250	05/07	>		S 2220 NR		
with filter Urea/Adblue / con filtro Urea/Adblue	Cummins ISBe4-250	184	250	05/07	>				S 4401 U
power steering / servosterzo	Cummins ISBe4-250	184	250	05/07	>				S 3081 PO
CLF 120	DAF PR183S Euro4	183	250	05/07	>	S 5045 PE	S 6024 NE		
with filter SCR-System / con filtro SCR-System	DAF PR183S Euro4	183	250	05/07	>				S 7A86 A
with filter Urea/Adblue / con filtro Urea/Adblue	DAF PR183S Euro4	183	250	05/07	>				S 4401 U
power steering / servosterzo	DAF PR183S Euro4	183	250	05/07	>				S 3081 PO
CLF 120	DAF PR228S Euro4	228	310	05/07	>	S 5234 PE	S 6146 NE		
with filter SCR-System / con filtro SCR-System	DAF PR228S Euro4	228	310	05/07	>				S 7A86 A
with filter Urea/Adblue / con filtro Urea/Adblue	DAF PR228S Euro4	228	310	05/07	>				S 4401 U
power steering / servosterzo	DAF PR228S Euro4	228	310	05/07	>				S 3081 PO
VISION BUS buses/autobus									
C-Serie									
C10	MAN D0836LOH60 E5/EEV	213	290	05/10	>	S 3292 R	S 6011 NE		
with air-conditioner Aerosphere World 24/32 kW, N. 6 PCS / con climatizzatore Aerosphere World 24/32 kW, N. 6 PZ	MAN D0836LOH60 E5/EEV	213	290	05/10	>				S 3283 C
with air-conditioner Aerosphere World 39 kW, N. 4 PCS (short) / con climatizzatore Aerosphere World 39 kW, N. 4 PZ (corto)	MAN D0836LOH60 E5/EEV	213	290	05/10	>				S 3283 C
with air-conditioner Konvekta P700, N. 8 pcs / con climatizzatore Konvekta P700, N. 8 PZ	MAN D0836LOH60 E5/EEV	213	290	05/10	>				S 3279 C
spheros aeroshere world KONVEKTA / con climatizzatore sul tetto KONVEKTA	MAN D0836LOH60 E5/EEV	213	290	05/10	>				S 3458 C
spheros aeroshere world SPHEROS / con climatizzatore sul tetto SPHEROS	MAN D0836LOH60 E5/EEV	213	290	05/10	>				S 3457 C
spheros aeroshere world WEBASTO / con climatizzatore sul tetto WEBASTO	MAN D0836LOH60 E5/EEV	213	290	05/10	>				S 3444 C
power steering / servosterzo	MAN D0836LOH60 E5/EEV	213	290	05/10	>				S 3081 PO
C10	MAN D2066LOH28	294	400	07/11	>	S 5046 PE	S 6011 NE	S 7644 A	
with air-conditioner Aerosphere World 39 kW, N. 4 PCS (short) / con climatizzatore Aerosphere World 39 kW, N. 4 PZ (corto)	MAN D2066LOH28	294	400	07/11	>				S 3283 C
spheros aeroshere world KONVEKTA / con climatizzatore sul tetto KONVEKTA	MAN D2066LOH28	294	400	07/11	>				S 3458 C
spheros aeroshere world SPHEROS / con climatizzatore sul tetto SPHEROS	MAN D2066LOH28	294	400	07/11	>				S 3457 C
spheros aeroshere world WEBASTO / con climatizzatore sul tetto WEBASTO	MAN D2066LOH28	294	400	07/11	>				S 3444 C
inner / interno	MAN D2066LOH28	294	400	07/11	>			S 7646 A	
power steering / servosterzo	MAN D2066LOH28	294	400	07/11	>				S 3081 PO
C11	MAN D2066LOH28	294	400	11/10	>	S 5046 PE	S 6011 NE	S 7644 A	





kW HP



...VISEON BUS - buses/autobus

with air-conditioner Aerosphere World 39 kW, N. 4 PCS (short) / con climatizzatore Aerosphere World 39 kW, N. 4 PZ (corto)	MAN D2066LOH28	294	400	11/10	>				S 3283 C
spheros aeroshere world KONVEKTA / con climatizzatore sul tetto KONVEKTA	MAN D2066LOH28	294	400	11/10	>				S 3458 C
spheros aeroshere world SPHEROS / con climatizzatore sul tetto SPHEROS	MAN D2066LOH28	294	400	11/10	>				S 3457 C
spheros aeroshere world WEBASTO / con climatizzatore sul tetto WEBASTO	MAN D2066LOH28	294	400	11/10	>				S 3444 C
inner / interno	MAN D2066LOH28	294	400	11/10	>			S 7646 A	
power steering / servosterzo	MAN D2066LOH28	294	400	11/10	>				S 3081 PO
C11	MAN D2676LOH26 EEV	321	440	07/11	>	S 5046 PE	S 6011 NE	S 7644 A	
with air-conditioner Aerosphere World 39 kW, N. 4 PCS (short) / con climatizzatore Aerosphere World 39 kW, N. 4 PZ (corto)	MAN D2676LOH26 EEV	321	440	07/11	>				S 3283 C
spheros aeroshere world KONVEKTA / con climatizzatore sul tetto KONVEKTA	MAN D2676LOH26 EEV	321	440	07/11	>				S 3458 C
spheros aeroshere world SPHEROS / con climatizzatore sul tetto SPHEROS	MAN D2676LOH26 EEV	321	440	07/11	>				S 3457 C
spheros aeroshere world WEBASTO / con climatizzatore sul tetto WEBASTO	MAN D2676LOH26 EEV	321	440	07/11	>				S 3444 C
inner / interno	MAN D2676LOH26 EEV	321	440	07/11	>			S 7646 A	
power steering / servosterzo	MAN D2676LOH26 EEV	321	440	07/11	>				S 3081 PO
C13	MAN D2066LOH28	294	400	10/10	>	S 5046 PE	S 6011 NE	S 7644 A	
with air-conditioner Aerosphere World 39 kW, N. 4 PCS (short) / con climatizzatore Aerosphere World 39 kW, N. 4 PZ (corto)	MAN D2066LOH28	294	400	10/10	>				S 3283 C
spheros aeroshere world KONVEKTA / con climatizzatore sul tetto KONVEKTA	MAN D2066LOH28	294	400	10/10	>				S 3458 C
spheros aeroshere world SPHEROS / con climatizzatore sul tetto SPHEROS	MAN D2066LOH28	294	400	10/10	>				S 3457 C
spheros aeroshere world WEBASTO / con climatizzatore sul tetto WEBASTO	MAN D2066LOH28	294	400	10/10	>				S 3444 C
inner / interno	MAN D2066LOH28	294	400	10/10	>			S 7646 A	
power steering / servosterzo	MAN D2066LOH28	294	400	10/10	>				S 3081 PO

LDD-Serie

LDD13	MAN D2066LOH28	294	400	06/12	>	S 5046 PE	S 6011 NE	S 7644 A	
with air-conditioner Aerosphere World, N. 4 PZ (short) / con climatizzatore Aerosphere World, N. 4 PZ (corto)	MAN D2066LOH28	294	400	06/12	>				S 3283 C
spheros aeroshere world KONVEKTA / con climatizzatore sul tetto KONVEKTA	MAN D2066LOH28	294	400	06/12	>				S 3458 C
spheros aeroshere world SPHEROS / con climatizzatore sul tetto SPHEROS	MAN D2066LOH28	294	400	06/12	>				S 3457 C
spheros aeroshere world WEBASTO / con climatizzatore sul tetto WEBASTO	MAN D2066LOH28	294	400	06/12	>				S 3444 C
dryer filter / filtro essiccatore	MAN D2066LOH28	294	400	06/12	>				S 7A66 A
inner / interno	MAN D2066LOH28	294	400	06/12	>			S 7646 A	
prefilter / prefiltrato	MAN D2066LOH28	294	400	06/12	>		S 6088 NE		
power steering / servosterzo	MAN D2066LOH28	294	400	06/12	>				S 3081 PO
LDD14	MAN D2066LOH28	294	400	10/10	>	S 5046 PE	S 6011 NE	S 7644 A	
with air-conditioner Aerosphere World 39 kW, N. 4 PCS (short) / con climatizzatore Aerosphere World 39 kW, N. 4 PZ (corto)	MAN D2066LOH28	294	400	10/10	>				S 3283 C
spheros aeroshere world KONVEKTA / con climatizzatore sul tetto KONVEKTA	MAN D2066LOH28	294	400	10/10	>				S 3458 C
spheros aeroshere world SPHEROS / con climatizzatore sul tetto SPHEROS	MAN D2066LOH28	294	400	10/10	>				S 3457 C
spheros aeroshere world WEBASTO / con climatizzatore sul tetto WEBASTO	MAN D2066LOH28	294	400	10/10	>				S 3444 C
inner / interno	MAN D2066LOH28	294	400	10/10	>			S 7646 A	
power steering / servosterzo	MAN D2066LOH28	294	400	10/10	>				S 3081 PO

VOLKSWAGEN

trucks/autocarri

G Serie

6.90	MAN D 0224, D 0226			09/79	>	S 5536 PO	S 4378 NR	S 0950 A	
8.90	MAN D 0224, D 0226			09/79	>	S 5536 PO	S 4378 NR	S 0950 A	

G90 Serie

10.150	MAN D 0826					S 3292 R	S 4378 NR	S 2450 A	
6.100	MAN D 0824					S 3292 R	S 4378 NR	S 2450 A	
8.100	MAN D 0824					S 3292 R	S 4378 NR	S 2450 A	
8.136	MAN D 0224, D 0226			09/79	>	S 5536 PO	S 4378 NR	S 0950 A	
8.150	MAN D 0826					S 3292 R	S 4378 NR	S 2450 A	
9.136	MAN D 0224, D 0226			09/79	>	S 5536 PO	S 4378 NR	S 0950 A	
9.150	MAN D 0826					S 3292 R	S 4378 NR	S 2450 A	

L80 Serie

4.3 TDI	AGF (MWM 4.10)			07/97	>		S 7600 NR		
dryer filter / filtro essiccatore	AGF (MWM 4.10)			07/97	>				S 7259 A
power steering / servosterzo	AGF (MWM 4.10)			07/97	>				S 3081 PO

VOLVO

trucks/autocarri

CH Serie

CH 230	TD120G, TD121G					S 0900 R	S 4323 NR	S 2070 A	
bleed / sfiato	TD120G, TD121G								S 7091 A

F10 Serie

F 10						S 5800 R	S 4323 NR		S 3051 A
to engine No. 128999 / a motore N. 128999	TD100A						S 4323 NR	S 2070 A	S 3051 A
to frame No. 344407 / a telaio N. 344407	TD100A						S 4323 NR	S 7161 A	S 3051 A
with outer two-stage filter / con filtro a doppio stadio, esterno	TD100A						S 4323 NR		S 5800 R
with oil radiator for gearbox (2) / con radiatore dell'olio per il cambio (2)	TD100A								S 3257 R
with oil radiator for gearbox (4/7, R/SR 1400/1700) / con radiatore dell'olio per il cambio (4/7, R/SR 1400/1700)	TD100A								S 3051 A
from engine No. 129000 / da motore N. 129000	TD100A					S 0900 R	S 4323 NR		

**KW HP****...VOLVO - trucks/autocarri**

from frame No. 344408 / da telaio N. 344408	TD100A			S 4323 NR	S 7277 A	S 3051 A
inner / interno	TD100A				S 7160 A	
power steering (Ø 60) / servosterzo (Ø 60)	TD100A					S 3081 PO
power steering (Ø 80) / servosterzo (Ø 80)	TD100A					S 8790 PO
bleed / sfiato	TD100A					S 7091 A
bleed / sfiato	TD100A					S 7092 A
F 10						
to engine No. 132399 / a motore N. 132399	TD100B		S 5800 R	S 4323 NR		S 3051 A
to frame No. 344407 / a telaio N. 344407	TD100B			S 4323 NR	S 2070 A	S 3051 A
with outer two-stage filter / con filtro a doppio stadio, esterno	TD100B			S 4323 NR	S 7161 A	S 3051 A
with oil radiator for gearbox (2) / con radiatore dell'olio per il cambio (2)	TD100B					S 5800 R
with oil radiator for gearbox (4/7, R/SR 1400/1700) / con radiatore dell'olio per il cambio (4/7, R/SR 1400/1700)	TD100B					S 3257 R
from engine No. 132400 / da motore N. 132400	TD100B		S 0900 R	S 4323 NR		S 3051 A
from frame No. 344408 / da telaio N. 344408	TD100B			S 4323 NR	S 7277 A	S 3051 A
inner / interno	TD100B				S 7160 A	
power steering (Ø 60) / servosterzo (Ø 60)	TD100B					S 3081 PO
power steering (Ø 80) / servosterzo (Ø 80)	TD100B					S 8790 PO
bleed / sfiato	TD100B					S 7091 A
bleed / sfiato	TD100B					S 7092 A
F 10						
to frame No. 344407 / a telaio N. 344407	TD100G, TD101F, TD101G		S 0900 R	S 4323 NR	S 2070 A	S 3051 A
with outer two-stage filter / con filtro a doppio stadio, esterno	TD100G, TD101F, TD101G		S 0900 R	S 4323 NR	S 7161 A	S 3051 A
with oil radiator for gearbox (2) / con radiatore dell'olio per il cambio (2)	TD100G, TD101F, TD101G					S 5800 R
with oil radiator for gearbox (4/7, R/SR 1400/1700) / con radiatore dell'olio per il cambio (4/7, R/SR 1400/1700)	TD100G, TD101F, TD101G					S 3257 R
from frame No. 344408 / da telaio N. 344408	TD100G, TD101F, TD101G		S 0900 R	S 4323 NR	S 7277 A	S 3051 A
inner / interno	TD100G, TD101F, TD101G				S 7160 A	
power steering (Ø 60) / servosterzo (Ø 60)	TD100G, TD101F, TD101G					S 3081 PO
power steering (Ø 80) / servosterzo (Ø 80)	TD100G, TD101F, TD101G					S 8790 PO
bleed / sfiato	TD100G, TD101F, TD101G					S 7091 A
bleed / sfiato	TD100G, TD101F, TD101G					S 7092 A
F 10						
to frame No. 344407 / a telaio N. 344407	TD102F, TD102FD, TD102FL, TD103ES	10/87 > 12/91	S 0900 R	S 4323 NR	S 2070 A	S 3051 A
with outer two-stage filter / con filtro a doppio stadio, esterno	TD102F, TD102FD, TD102FL, TD103ES		S 0900 R	S 4323 NR	S 7161 A	S 3051 A
with oil radiator for gearbox (2) / con radiatore dell'olio per il cambio (2)	TD102F, TD102FD, TD102FL, TD103ES					S 5800 R
with oil radiator for gearbox (4/7, R/SR 1400/1700) / con radiatore dell'olio per il cambio (4/7, R/SR 1400/1700)	TD102F, TD102FD, TD102FL, TD103ES					S 3257 R
from frame No. 344408 / da telaio N. 344408	TD102F, TD102FD, TD102FL, TD103ES		S 0900 R	S 4323 NR	S 7277 A	S 3051 A
inner to frame No. 344407 / interno a telaio N. 344407	TD102F, TD102FD, TD102FL, TD103ES	10/87 > 12/91			S 7160 A	
inner from frame No. 344408 / interno da telaio N. 344408	TD102F, TD102FD, TD102FL, TD103ES	01/92 > 12/94			S 7572 A	
power steering (Ø 60) / servosterzo (Ø 60)	TD102F, TD102FD, TD102FL, TD103ES					S 3081 PO
power steering (Ø 80) / servosterzo (Ø 80)	TD102F, TD102FD, TD102FL, TD103ES					S 8790 PO
bleed / sfiato	TD102F, TD102FD, TD102FL, TD103ES					S 7091 A
bleed / sfiato	TD102F, TD102FD, TD102FL, TD103ES					S 7092 A
F12 Serie						
F 12						
to frame No. 344404 / a telaio N. 344404	TD120C	08/77 > 10/84	S 0900 R	S 4323 NR		S 3051 A
with outer two-stage filter / con filtro a doppio stadio, esterno	TD120C	08/77 > 10/84			S 7161 A	
with inner two-stage filter / con filtro a doppio stadio, interno	TD120C	08/77 > 10/84			S 7160 A	
with oil radiator for gearbox (2) / con radiatore dell'olio per il cambio (2)	TD120C	08/77 > 10/84				S 5800 R
with oil radiator for gearbox (3, 4, R/SR 62, R/SR 70) / con radiatore dell'olio per il cambio (3, 4, R/SR 62, R/SR 70)	TD120C	08/77 > 10/84				S 3257 R
with oil radiator for gearbox (5/7, R/SR 1400/1700) / con radiatore dell'olio per il cambio (5/7, R/SR 1400/1700)	TD120C	08/77 > 10/84				S 3257 R
with oil radiator for gearbox (AUS) (3/5, 8 x 4 SR 70) / con radiatore dell'olio per il cambio (AUS) (3/5, 8 x 4 SR 70)	TD120C	08/77 > 10/84				S 3257 R
with oil radiator for gearbox, without retarder (7) / con radiatore dell'olio per il cambio, senza rallentatore (7)	TD120C	08/77 > 10/84				S 3257 R
power steering (Ø 60) / servosterzo (Ø 60)	TD120C	08/77 > 10/84				S 3081 PO
power steering (Ø 80) / servosterzo (Ø 80)	TD120C	08/77 > 10/84				S 8790 PO
bleed / sfiato	TD120C	08/77 > 10/84				S 7091 A
bleed / sfiato	TD120C	08/77 > 10/84				S 7092 A
F 12						
to frame No. 344404 / a telaio N. 344404	TD121F		S 0900 R	S 4323 NR	S 2070 A	S 3051 A
with outer two-stage filter / con filtro a doppio stadio, esterno	TD121F				S 7161 A	
with inner two-stage filter / con filtro a doppio stadio, interno	TD121F				S 7160 A	
with oil radiator for gearbox (2) / con radiatore dell'olio per il cambio (2)	TD121F	10/83 > 05/88				S 5800 R
with oil radiator for gearbox (3, 4, R/SR 62, R/SR 70) / con radiatore dell'olio per il cambio (3, 4, R/SR 62, R/SR 70)	TD121F	10/83 > 05/88				S 3257 R
with oil radiator for gearbox (5/7, R/SR 1400/1700) / con radiatore dell'olio per il cambio (5/7, R/SR 1400/1700)	TD121F	10/83 > 05/88				S 3257 R
with oil radiator for gearbox (AUS) (3/5, 8 x 4 SR 70) / con radiatore dell'olio per il cambio (AUS) (3/5, 8 x 4 SR 70)	TD121F	10/83 > 05/88				S 3257 R
with oil radiator for gearbox, without retarder (7) / con radiatore dell'olio per il cambio, senza rallentatore (7)	TD121F	10/83 > 05/88				S 3257 R
from frame No. 344405 / da telaio N. 344405	TD121F		S 0900 R	S 4323 NR	S 7277 A	S 3051 A
inner from frame No. 344405 / interno da telaio N. 344405	TD121F				S 7572 A	
power steering (Ø 60) / servosterzo (Ø 60)	TD121F	10/83 > 05/88				S 3081 PO





kW HP



...VOLVO - trucks/autocarri

power steering (Ø 80) / servosterzo (Ø 80)	TD121F	10/83 > 05/88				S 8790 PO
bleed / sfiato	TD121F	10/83 > 05/88				S 7091 A
bleed / sfiato	TD121F	10/83 > 05/88				S 7092 A
F 12						
to frame No. 344404 / a telaio N. 344404	TD122	10/87 > 10/91	S 0900 R	S 4323 NR	S 2070 A	S 3051 A
with outer two-stage filter / con filtro a doppio stadio, esterno	TD122	10/87 > 12/94	S 0900 R	S 4323 NR	S 7161 A	S 3051 A
with inner two-stage filter / con filtro a doppio stadio, interno	TD122	10/87 > 12/94			S 7160 A	
with oil radiator for gearbox (2) / con radiatore dell'olio per il cambio (2)	TD122	10/87 > 12/94				S 5800 R
with oil radiator for gearbox (3, 4, R/SR 62, R/SR 70) / con radiatore dell'olio per il cambio (3, 4, R/SR 62, R/SR 70)	TD122	10/87 > 12/94				S 3257 R
with oil radiator for gearbox (5/7, R/SR 1400/1700) / con radiatore dell'olio per il cambio (5/7, R/SR 1400/1700)	TD122	10/87 > 12/94				S 3257 R
with oil radiator for gearbox (AUS) (3/5, 8 x 4 SR 70) / con radiatore dell'olio per il cambio (AUS) (3/5, 8 x 4 SR 70)	TD122	10/87 > 12/94				S 3257 R
with oil radiator for gearbox, without retarder (7) / con radiatore dell'olio per il cambio, senza rallentatore (7)	TD122	10/87 > 12/94				S 3257 R
from frame No. 344405 / da telaio N. 344405	TD122	01/92 > 12/94	S 0900 R	S 4323 NR	S 7277 A	S 3051 A
inner from frame No. 344405 / interno da telaio N. 344405	TD122	01/92 > 12/94			S 7572 A	
power steering (Ø 60) / servosterzo (Ø 60)	TD122	10/87 > 12/94				S 3081 PO
power steering (Ø 80) / servosterzo (Ø 80)	TD122	10/87 > 12/94				S 8790 PO
bleed / sfiato	TD122	10/87 > 12/94				S 7091 A
bleed / sfiato	TD122	10/87 > 12/94				S 7092 A
F 12						
to frame No. 344404 / a telaio N. 344404	TD123E	07/91 > 10/91	S 0900 R	S 4323 NR	S 2070 A	S 3051 A
with outer two-stage filter / con filtro a doppio stadio, esterno	TD123E	07/91 > 12/94	S 0900 R	S 4323 NR	S 7161 A	S 3051 A
with inner two-stage filter / con filtro a doppio stadio, interno	TD123E	07/91 > 12/94			S 7160 A	
with oil radiator for gearbox (2) / con radiatore dell'olio per il cambio (2)	TD123E	07/91 > 12/94				S 5800 R
with oil radiator for gearbox (3, 4, R/SR 62, R/SR 70) / con radiatore dell'olio per il cambio (3, 4, R/SR 62, R/SR 70)	TD123E	07/91 > 12/94				S 3257 R
with oil radiator for gearbox (5/7, R/SR 1400/1700) / con radiatore dell'olio per il cambio (5/7, R/SR 1400/1700)	TD123E	07/91 > 12/94				S 3257 R
with oil radiator for gearbox (AUS) (3/5, 8 x 4 SR 70) / con radiatore dell'olio per il cambio (AUS) (3/5, 8 x 4 SR 70)	TD123E	07/91 > 12/94				S 3257 R
with oil radiator for gearbox, without retarder (7) / con radiatore dell'olio per il cambio, senza rallentatore (7)	TD123E	07/91 > 12/94				S 3257 R
from frame No. 344405 / da telaio N. 344405	TD123E	01/92 > 12/94	S 0900 R	S 4323 NR	S 7277 A	S 3051 A
inner from frame No. 344405 / interno da telaio N. 344405	TD123E	01/92 > 12/94			S 7572 A	
power steering (Ø 60) / servosterzo (Ø 60)	TD123E	07/91 > 12/94				S 3081 PO
power steering (Ø 80) / servosterzo (Ø 80)	TD123E	07/91 > 12/94				S 8790 PO
bleed / sfiato	TD123E	07/91 > 12/94				S 7091 A
bleed / sfiato	TD123E	07/91 > 12/94				S 7092 A
F16 Serie						
F 16	TD162F, TD163ES		S 0900 R	S 4323 NR		S 3051 A
by-pass	TD162F, TD163ES		S 4120 R			
with oil radiator for gearbox, without retarder (SR2000) / con radiatore dell'olio per il cambio, senza rallentatore (SR2000)	TD162F, TD163ES					S 3257 R
water filter / filtro acqua	TD162F, TD163ES					S 9006 AR
dryer filter / filtro essiccatore	TD162F, TD163ES					S 7259 A
power steering (Ø 60) / servosterzo (Ø 60)	TD162F, TD163ES					S 3081 PO
power steering (Ø 80) / servosterzo (Ø 80)	TD162F, TD163ES					S 8790 PO
bleed / sfiato	TD162F, TD163ES					S 7091 A
bleed / sfiato	TD162F, TD163ES					S 7092 A
F4 Serie						
F 4	D39C		S 9400 R	S 7111 NC		
power steering (Ø 60) / servosterzo (Ø 60)	D39C					S 3081 PO
power steering (Ø 80) / servosterzo (Ø 80)	D39C					S 8790 PO
F 4						
power steering (Ø 60) / servosterzo (Ø 60)	TD40			S 8500 NR		S 3081 PO
power steering (Ø 80) / servosterzo (Ø 80)	TD40					S 8790 PO
F6 Serie						
F 6	D60/A, TD60/A/B/C		S 5800 R	S 4323 NR		
to engine No. 47589 / a motore N. 47589	D60/A, TD60/A/B/C		S 0900 R	S 4323 NR		
from engine No. 47590 / da motore N. 47590	D60/A, TD60/A/B/C					S 3081 PO
power steering (Ø 60) / servosterzo (Ø 60)	D60/A, TD60/A/B/C					S 8790 PO
power steering (Ø 80) / servosterzo (Ø 80)	D60/A, TD60/A/B/C					S 7091 A
bleed / sfiato	D60/A, TD60/A/B/C					
F 6						
power steering (Ø 60) / servosterzo (Ø 60)	TD61GE	01/87 >	S 0900 R	S 4323 NR		S 3081 PO
power steering (Ø 80) / servosterzo (Ø 80)	TD61GE					S 8790 PO
bleed / sfiato	TD61GE					S 7091 A
F 6 S						
to engine No. 47589 / a motore N. 47589	TD60A, TD60B		S 5800 R	S 4323 NR		S 3051 A
from engine No. 47590 / da motore N. 47590	TD60A, TD60B		S 0900 R	S 4323 NR		S 3051 A
power steering (Ø 60) / servosterzo (Ø 60)	TD60A, TD60B					S 3081 PO
power steering (Ø 80) / servosterzo (Ø 80)	TD60A, TD60B					S 8790 PO
bleed / sfiato	TD60A, TD60B					S 7091 A



kW HP



...VOLVO - trucks/autocarri

F7 Serie							
F 7	TD70F, TD70FS, TD70G			S 0900 R	S 4323 NR		S 3051 A
power steering (Ø 60) / servosterzo (Ø 60)	TD70F, TD70FS, TD70G						S 3081 PO
power steering (Ø 80) / servosterzo (Ø 80)	TD70F, TD70FS, TD70G						S 8790 PO
bleed / sfiato	TD70F, TD70FS, TD70G						S 7091 A
bleed / sfiato	TD70F, TD70FS, TD70G						S 7092 A
F8 Serie							
F 8	TD70E			S 5800 R	S 4323 NR	S 4450 A	
F 89				S 5800 R	S 4323 NR	S 8450 A	
power steering (Ø 80) / servosterzo (Ø 80)							S 8790 PO
F80 Serie							
F 82	D36A			S 7380 PO	S 6481 N		
F 82 S				S 1080 PO	S 7111 NC		
to engine No. 2364/112269 / a motore N. 2364/112269				S 9400 R	S 7111 NC		
from engine No. 2364/112270 / da motore N. 2364/112270							
F 83 S				S 1080 PO	S 7111 NC		
to engine No. 2364/112269 / a motore N. 2364/112269				S 9400 R	S 7111 NC		
from engine No. 2364/112270 / da motore N. 2364/112270							
F 84				S 5800 R	S 1411 N	S 4450 A	
to engine No. 21065 / a motore N. 21065	D50, TD50			S 5800 R	S 4323 NR	S 4450 A	
from engine No. 21066 / da motore N. 21066	D50, TD50						S 8790 PO
power steering (Ø 80) / servosterzo (Ø 80)	D50, TD50						
F 84	TD60			S 5800 R	S 4323 NR	S 4450 A	
power steering (Ø 80) / servosterzo (Ø 80)	TD60						S 8790 PO
F 85				S 5800 R	S 1411 N	S 4450 A	
to engine No. 21065 / a motore N. 21065	D50, TD50			S 5800 R	S 4323 NR	S 4450 A	
from engine No. 21066 / da motore N. 21066	D50, TD50						S 8790 PO
power steering (Ø 80) / servosterzo (Ø 80)	D50, TD50						
F 85	TD60			S 5800 R	S 4323 NR	S 4450 A	
power steering (Ø 80) / servosterzo (Ø 80)	TD60						S 8790 PO
F 86	D70A, D70B			S 5800 R	S 7111 NC	S 4450 A	
power steering (Ø 80) / servosterzo (Ø 80)	D70A, D70B						S 8790 PO
F 86				S 5800 R	S 4323 NR	S 4450 A	
injection BOSCH / iniezione BOSCH	TD70A			S 5800 R	S 7111 NC	S 4450 A	
injection DELPHI / iniezione DELPHI	TD70A						S 8790 PO
power steering (Ø 80) / servosterzo (Ø 80)	TD70A						
F 86	TD70B/C/D/E			S 5800 R	S 4323 NR	S 4450 A	
power steering (Ø 80) / servosterzo (Ø 80)	TD70B/C/D/E						S 8790 PO
F 87	D70A, D70B			S 5800 R	S 7111 NC	S 4450 A	
power steering (Ø 80) / servosterzo (Ø 80)	D70A, D70B						S 8790 PO
F 87				S 5800 R	S 4323 NR	S 4450 A	
injection BOSCH / iniezione BOSCH	TD70A			S 5800 R	S 7111 NC	S 4450 A	
injection DELPHI / iniezione DELPHI	TD70A						S 8790 PO
power steering (Ø 80) / servosterzo (Ø 80)	TD70A						
F 87	TD70B/C/D/E			S 5800 R	S 4323 NR	S 4450 A	
power steering (Ø 80) / servosterzo (Ø 80)	TD70B/C/D/E						S 8790 PO
F 88				S 5800 R	S 1411 N		
to engine No. 19896 / a motore N. 19896				S 5800 R		S 6450 A	
to frame No. 30000 / a telaio N. 30000				S 5800 R	S 4323 NR		
from engine No. 19897 / da motore N. 19897				S 5800 R		S 8450 A	
from frame No. 30001 / da telaio N. 30001							S 8790 PO
power steering (Ø 80) / servosterzo (Ø 80)							
F 89 T	TD120A	243 330	10/70 > 06/77	S 5800 R	S 4323 NR	S 8450 A	
power steering (Ø 80) / servosterzo (Ø 80)	TD120A	243 330	10/70 > 06/77				S 8790 PO
FB 86	D70A, D70B			S 5800 R	S 7111 NC	S 4450 A	
power steering (Ø 80) / servosterzo (Ø 80)	D70A, D70B						S 8790 PO
FB 86				S 5800 R	S 4323 NR	S 4450 A	
injection BOSCH / iniezione BOSCH	TD70A			S 5800 R	S 7111 NC	S 4450 A	
injection DELPHI / iniezione DELPHI	TD70A						S 8790 PO
power steering (Ø 80) / servosterzo (Ø 80)	TD70A						
FB 86	TD70B/C/D/E			S 5800 R	S 4323 NR	S 4450 A	
power steering (Ø 80) / servosterzo (Ø 80)	TD70B/C/D/E						S 8790 PO
FB 88				S 5800 R	S 1411 N		
to engine No. 19896 / a motore N. 19896				S 5800 R		S 6450 A	
to frame No. 30000 / a telaio N. 30000				S 5800 R	S 4323 NR		
from engine No. 19897 / da motore N. 19897				S 5800 R		S 8450 A	
from frame No. 30001 / da telaio N. 30001							S 8790 PO

V





...VOLVO - trucks/autocarri

V

power steering (Ø 80) / servosterzo (Ø 80)								S 8790 PO
FAH								
FAH some / alcuni								S 0201 N S 1411 N
FBH								
FBH some / alcuni								S 0201 N S 1411 N
FE Serie II								
FE240	D7E	177 240	05/06 >	S 5097 PE	S 6039 NE	S 7B10 A		
with filter Urea/Adblue / con filtro Urea/Adblue	D7E	177 240	05/06 >					S 4402 U
prefilter / prefiltro	D7E	177 240	05/06 >		S 4158 NR			
FE260	D7F	191 260	04/09 >	S 5097 PE	S 6039 NE	S 7645 A		
with filter Urea/Adblue / con filtro Urea/Adblue	D7F	191 260	04/09 >					S 4402 U
inner / interno	D7F	191 260	04/09 >			S 7404 A		
prefilter / prefiltro	D7F	191 260	04/09 >		S 4158 NR			
FE280	D7E	206 280	05/06 >	S 5097 PE	S 6039 NE	S 7643 A		
with filter Urea/Adblue / con filtro Urea/Adblue	D7E	206 280	05/06 >					S 4402 U
inner / interno	D7E	206 280	05/06 >			S 7406 A		
prefilter / prefiltro	D7E	206 280	05/06 >		S 4158 NR			
FE300	D7F	221 300	04/09 >	S 5097 PE	S 6039 NE	S 7645 A		
with filter Urea/Adblue / con filtro Urea/Adblue	D7F	221 300	04/09 >					S 4402 U
inner / interno	D7F	221 300	04/09 >			S 7404 A		
prefilter / prefiltro	D7F	221 300	04/09 >		S 4158 NR			
FE320	D7E	235 320	05/06 >	S 5097 PE	S 6039 NE	S 7645 A		
with filter Urea/Adblue / con filtro Urea/Adblue	D7E	235 320	05/06 >					S 4402 U
inner / interno	D7E	235 320	05/06 >			S 7404 A		
prefilter / prefiltro	D7E	235 320	05/06 >		S 4158 NR			
FE340	D7F	250 340	04/09 >	S 5097 PE	S 6039 NE	S 7645 A		
with filter Urea/Adblue / con filtro Urea/Adblue	D7F	250 340	04/09 >					S 4402 U
inner / interno	D7F	250 340	04/09 >			S 7404 A		
prefilter / prefiltro	D7F	250 340	04/09 >		S 4158 NR			
FE Serie III								
250								
with automatic gearbox / con cambio automatico	D8K	184 250	09/13 >					S 5238 PE
280								
with automatic gearbox / con cambio automatico	D8K	206 280	09/13 >					S 5238 PE
320								
with automatic gearbox / con cambio automatico	D8K	235 320	09/13 >					S 5238 PE
350								
with automatic gearbox / con cambio automatico	D8K	257 350	08/17 >					S 5238 PE
FH Serie								
FH400								
with activated carbons / ai carboni attivi	D13A/B-400	294 400	09/05 > 08/08					S 4260 CA
some / alcuni	D13A/B-400	294 400	09/05 > 08/08		S 9320 NR	S 7345 A		S 3089 C
some / alcuni	D13A/B-400	294 400	09/05 > 08/08		S 9320 NR	S 7347 A		S 3089 C
by-pass	D13A/B-400	294 400	09/05 > 08/08	S 4120 R				
with automatic gearbox / con cambio automatico	D13A/B-400	294 400	09/05 > 07/08					S 5238 PE
water filter / filtro acqua	D13A/B-400	294 400	09/05 > 08/08					S 9006 AR
inner some / interno alcuni	D13A/B-400	294 400	09/05 > 08/08			S 7576 A		
LONG LIFE	D13A/B-400	294 400	09/05 > 08/08		S 4120 NR			
2 filters / N.2 filtri	D13A/B-400	294 400	09/05 > 08/08	S 4402 R				
prefilter short filter / prefiltro filtro corto	D13A/B-400	294 400	09/05 > 08/08		S 4461 NR			
prefilter long filter / prefiltro filtro lungo	D13A/B-400	294 400	09/05 > 08/08		S 4146 NR			
power steering / servosterzo	D13A/B-400	294 400	09/05 > 08/08					S 3081 PO
FH400	D13B-400	294 400	09/08 >		S 9320 NR	S 7345 A		S 3089 C
with activated carbons / ai carboni attivi	D13B-400	294 400	09/08 >					S 4260 CA
by-pass	D13B-400	294 400	09/08 >	S 4120 R				
with automatic gearbox / con cambio automatico	D13B-400	294 400	09/08 >					S 5238 PE
with filter Urea/Adblue/SCR system / con filtro Urea/Adblue/SCR system	D13B-400	294 400	09/08 >					S 4402 U
water filter / filtro acqua	D13B-400	294 400	09/08 >					S 9006 AR
inner / interno	D13B-400	294 400	09/08 >			S 7576 A		
LONG LIFE	D13B-400	294 400	09/08 >		S 4120 NR			
2 filters / N.2 filtri	D13B-400	294 400	09/08 >	S 4402 R				
prefilter short filter / prefiltro filtro corto	D13B-400	294 400	09/08 >		S 4461 NR			
prefilter long filter / prefiltro filtro lungo	D13B-400	294 400	09/08 >		S 4146 NR			
power steering / servosterzo	D13B-400	294 400	09/08 >					S 3081 PO
FH420	D13C-420	309 420	04/09 >		S 9320 NR	S 7A03 A		S 3089 C

**KW HP****...VOLVO - trucks/autocarri**

with activated carbons / ai carboni attivi	D13C-420	309 420	04/09 >				S 4260 CA
by-pass	D13C-420	309 420	04/09 >		S 4120 R		
with automatic gearbox / con cambio automatico	D13C-420	309 420	04/09 >				S 5238 PE
with filter Urea/Adblue/SCR system / con filtro Urea/Adblue/SCR system	D13C-420	309 420	04/09 >				S 4402 U
water filter / filtro acqua	D13C-420	309 420	04/09 >				S 9006 AR
inner / interno	D13C-420	309 420	04/09 >			S 7A04 A	
LONG LIFE	D13C-420	309 420	04/09 >			S 4120 NR	
2 filters / N.2 filtri	D13C-420	309 420	04/09 >		S 4402 R		
prefilter short filter / prefilto filtro corto	D13C-420	309 420	04/09 >			S 4461 NR	
prefilter long filter / prefilto filtro lungo	D13C-420	309 420	04/09 >			S 4146 NR	
power steering / servosterzo	D13C-420	309 420	04/09 >				S 3081 PO
FH440							
with activated carbons / ai carboni attivi	D13A/B-440	324 440	09/05 > 08/08				S 4260 CA
some / alcuni	D13A/B-440	324 440	09/05 > 08/08		S 9320 NR	S 7347 A	S 3089 C
some / alcuni	D13A/B-440	324 440	09/05 > 08/08		S 9320 NR	S 7345 A	S 3089 C
by-pass	D13A/B-440	324 440	09/05 > 08/08		S 4120 R		
with automatic gearbox / con cambio automatico	D13A/B-440	324 440	09/05 > 08/08				S 5238 PE
water filter / filtro acqua	D13A/B-440	324 440	09/05 > 08/08				S 9006 AR
inner some / interno alcuni	D13A/B-440	324 440	09/05 > 08/08			S 7576 A	
LONG LIFE	D13A/B-440	324 440	09/05 > 08/08			S 4120 NR	
2 filters / N.2 filtri	D13A/B-440	324 440	09/05 > 08/08		S 4402 R		
prefilter short filter / prefilto filtro corto	D13A/B-440	324 440	09/05 > 08/08			S 4461 NR	
prefilter long filter / prefilto filtro lungo	D13A/B-440	324 440	09/05 > 08/08			S 4146 NR	
power steering / servosterzo	D13A/B-440	324 440	09/05 > 08/08				S 3081 PO
FH440							
	D13B-440	324 440	09/08 >			S 9320 NR	S 7345 A
with activated carbons / ai carboni attivi	D13B-440	324 440	09/08 >				S 4260 CA
by-pass	D13B-440	324 440	09/08 >		S 4120 R		
with filter Urea/Adblue/SCR system / con filtro Urea/Adblue/SCR system	D13B-440	324 440	09/08 >				S 4402 U
water filter / filtro acqua	D13B-440	324 440	09/08 >				S 9006 AR
inner / interno	D13B-440	324 440	09/08 >			S 7576 A	
LONG LIFE	D13B-440	324 440	09/08 >			S 4120 NR	
2 filters / N.2 filtri	D13B-440	324 440	09/08 >		S 4402 R		
prefilter short filter / prefilto filtro corto	D13B-440	324 440	09/08 >			S 4461 NR	
prefilter long filter / prefilto filtro lungo	D13B-440	324 440	09/08 >			S 4146 NR	
power steering / servosterzo	D13B-440	324 440	09/08 >				S 3081 PO
FH460							
	D13C-460	338 460	04/09 >			S 9320 NR	S 7A03 A
with activated carbons / ai carboni attivi	D13C-460	338 460	04/09 >				S 3089 C
by-pass	D13C-460	338 460	04/09 >		S 4120 R		S 4260 CA
with automatic gearbox / con cambio automatico	D13C-460	338 460	04/09 >				S 5238 PE
with filter Urea/Adblue/SCR system / con filtro Urea/Adblue/SCR system	D13C-460	338 460	04/09 >				S 4402 U
water filter / filtro acqua	D13C-460	338 460	04/09 >				S 9006 AR
inner / interno	D13C-460	338 460	04/09 >			S 7A04 A	
LONG LIFE	D13C-460	338 460	04/09 >			S 4120 NR	
2 filters / N.2 filtri	D13C-460	338 460	04/09 >		S 4402 R		
prefilter short filter / prefilto filtro corto	D13C-460	338 460	04/09 >			S 4461 NR	
prefilter long filter / prefilto filtro lungo	D13C-460	338 460	04/09 >			S 4146 NR	
power steering / servosterzo	D13C-460	338 460	04/09 >				S 3081 PO
FH480							
with activated carbons / ai carboni attivi	D13A-480	353 480	09/05 > 08/08				S 4260 CA
some / alcuni	D13A-480	353 480	09/05 > 08/08		S 9320 NR	S 7345 A	S 3089 C
some / alcuni	D13A-480	353 480	09/05 > 08/08		S 9320 NR	S 7347 A	S 3089 C
by-pass	D13A-480	353 480	09/05 > 08/08		S 4120 R		
with automatic gearbox / con cambio automatico	D13A-480	353 480	09/05 > 08/08				S 5238 PE
water filter / filtro acqua	D13A-480	353 480	09/05 > 08/08				S 9006 AR
inner some / interno alcuni	D13A-480	353 480	09/05 > 08/08			S 7576 A	
LONG LIFE	D13A-480	353 480	09/05 > 08/08			S 4120 NR	
2 filters / N.2 filtri	D13A-480	353 480	09/05 > 08/08		S 4402 R		
prefilter long filter / prefilto filtro lungo	D13A-480	353 480	09/05 > 08/08			S 4461 NR	
prefilter long filter / prefilto filtro lungo	D13A-480	353 480	09/05 > 08/08			S 4146 NR	
power steering / servosterzo	D13A-480	353 480	09/05 > 08/08				S 3081 PO
FH480							
	D13B-480	353 480	09/08 >			S 9320 NR	S 7345 A
with activated carbons / ai carboni attivi	D13B-480	353 480	09/08 >				S 4260 CA
by-pass	D13B-480	353 480	09/08 >		S 4120 R		
with filter Urea/Adblue/SCR system / con filtro Urea/Adblue/SCR system	D13B-480	353 480	09/08 >				S 4402 U
water filter / filtro acqua	D13B-480	353 480	09/08 >				S 9006 AR
inner / interno	D13B-480	353 480	09/08 >			S 7576 A	
LONG LIFE	D13B-480	353 480	09/08 >			S 4120 NR	





kW HP



...VOLVO - trucks/autocarri

2 filters / N.2 filtri	D13B-480	353	480	09/08 >	S 4402 R			
prefilter short filter / prefiltro filtro corto	D13B-480	353	480	09/08 >		S 4461 NR		
prefilter long filter / prefiltro filtro lungo	D13B-480	353	480	09/08 >		S 4146 NR		
power steering / servosterzo	D13B-480	353	480	09/08 >				S 3081 PO
FH500	D13B-500	368	500	09/07 > 08/08		S 9320 NR	S 7345 A	S 3089 C
with activated carbons / ai carboni attivi	D13B-500	368	500	09/07 > 08/08				S 4260 CA
by-pass	D13B-500	368	500	09/07 > 08/08	S 4120 R			
with filter Urea/Adblue/SCR system / con filtro Urea/Adblue/SCR system	D13B-500	368	500	09/07 > 08/08				S 4402 U
water filter / filtro acqua	D13B-500	368	500	09/07 > 08/08				S 9006 AR
inner / interno	D13B-500	368	500	09/07 > 08/08			S 7576 A	
LONG LIFE	D13B-500	368	500	09/07 > 08/08		S 4120 NR		
2 filters / N.2 filtri	D13B-500	368	500	09/07 > 08/08	S 4402 R			
prefilter short filter / prefiltro filtro corto	D13B-500	368	500	09/07 > 08/08		S 4461 NR		
prefilter long filter / prefiltro filtro lungo	D13B-500	368	500	09/07 > 08/08		S 4146 NR		
power steering / servosterzo	D13B-500	368	500	09/07 > 08/08				S 3081 PO
FH500	D13C-500	368	500	04/09 >		S 9320 NR	S 7A03 A	S 3089 C
with activated carbons / ai carboni attivi	D13C-500	368	500	04/09 >				S 4260 CA
by-pass	D13C-500	368	500	04/09 >	S 4120 R			
with filter Urea/Adblue/SCR system / con filtro Urea/Adblue/SCR system	D13C-500	368	500	04/09 >				S 4402 U
water filter / filtro acqua	D13C-500	368	500	04/09 >				S 9006 AR
inner / interno	D13C-500	368	500	04/09 >			S 7A04 A	
LONG LIFE	D13C-500	368	500	04/09 >		S 4120 NR		
2 filters / N.2 filtri	D13C-500	368	500	04/09 >	S 4402 R			
prefilter short filter / prefiltro filtro corto	D13C-500	368	500	04/09 >		S 4461 NR		
prefilter long filter / prefiltro filtro lungo	D13C-500	368	500	04/09 >		S 4146 NR		
power steering / servosterzo	D13C-500	368	500	04/09 >				S 3081 PO
FH520	D13A-520	382	520	09/05 > 08/08				S 4260 CA
with activated carbons / ai carboni attivi	D13A-520	382	520	09/05 > 08/08		S 9320 NR	S 7345 A	S 3089 C
some / alcuni	D13A-520	382	520	09/05 > 08/08		S 9320 NR	S 7347 A	S 3089 C
by-pass	D13A-520	382	520	09/05 > 08/08	S 4120 R			
with automatic gearbox / con cambio automatico	D13A-520	382	520	09/05 > 08/08				S 5238 PE
inner some / interno alcuni	D13A-520	382	520	09/05 > 08/08			S 7576 A	
LONG LIFE	D13A-520	382	520	09/05 > 08/08		S 4120 NR		
2 filters / N.2 filtri	D13A-520	382	520	09/05 > 08/08	S 4402 R			
prefilter short filter / prefiltro filtro corto	D13A-520	382	520	09/05 > 08/08		S 4461 NR		
prefilter long filter / prefiltro filtro lungo	D13A-520	382	520	09/05 > 08/08		S 4146 NR		
power steering / servosterzo	D13A-520	382	520	09/05 > 08/08				S 3081 PO
FH520	D13B-520	382	520	09/08 >		S 9320 NR	S 7345 A	S 3089 C
with activated carbons / ai carboni attivi	D13B-520	382	520	09/08 >				S 4260 CA
by-pass	D13B-520	382	520	09/08 >	S 4120 R			
with automatic gearbox / con cambio automatico	D13B-520	382	520	09/08 >				S 5238 PE
with filter Urea/Adblue/SCR system / con filtro Urea/Adblue/SCR system	D13B-520	382	520	09/08 >				S 4402 U
water filter / filtro acqua	D13B-520	382	520	09/08 >				S 9006 AR
inner / interno	D13B-520	382	520	09/08 >			S 7576 A	
LONG LIFE	D13B-520	382	520	09/08 >		S 4120 NR		
2 filters / N.2 filtri	D13B-520	382	520	09/08 >	S 4402 R			
prefilter short filter / prefiltro filtro corto	D13B-520	382	520	09/08 >		S 4461 NR		
prefilter long filter / prefiltro filtro lungo	D13B-520	382	520	09/08 >		S 4146 NR		
power steering / servosterzo	D13B-520	382	520	09/08 >				S 3081 PO
FH540	D13C-540	397	540	04/09 >		S 9320 NR	S 7A03 A	S 3089 C
with activated carbons / ai carboni attivi	D13C-540	397	540	04/09 >				S 4260 CA
by-pass	D13C-540	397	540	04/09 >	S 4120 R			
with automatic gearbox / con cambio automatico	D13C-540	397	540	04/09 >				S 5238 PE
with filter Urea/Adblue/SCR system / con filtro Urea/Adblue/SCR system	D13C-540	397	540	04/09 >				S 4402 U
water filter / filtro acqua	D13C-540	397	540	04/09 >				S 9006 AR
inner / interno	D13C-540	397	540	04/09 >			S 7A04 A	
LONG LIFE	D13C-540	397	540	04/09 >		S 4120 NR		
2 filters / N.2 filtri	D13C-540	397	540	04/09 >	S 4402 R			
prefilter short filter / prefiltro filtro corto	D13C-540	397	540	04/09 >		S 4461 NR		
prefilter long filter / prefiltro filtro lungo	D13C-540	397	540	04/09 >		S 4146 NR		
power steering / servosterzo	D13C-540	397	540	04/09 >				S 3081 PO
FH Serie II								
FH 420	D13C-420 E5/EEV	309	420	01/13 >		S 4120 NR	S 7A03 A	S 9006 AR
by-pass	D13C-420 E5/EEV	309	420	01/13 >	S 4120 R			
inner / interno	D13C-420 E5/EEV	309	420	01/13 >			S 7A04 A	
2 filters / N.2 filtri	D13C-420 E5/EEV	309	420	01/13 >	S 4402 R			

**KW HP****...VOLVO - trucks/autocarri**

prefilter short filter / prefiltra filtro corto	D13C-420 E5/EEV	309	420	01/13	>		S 4157 NR		
prefilter long filter / prefiltra filtro lungo	D13C-420 E5/EEV	309	420	01/13	>		S 4146 NR		
prefilter RACOR / prefiltra RACOR	D13C-420 E5/EEV	309	420	01/13	>		S 4477 NR		
power steering / servosterzo	D13C-420 E5/EEV	309	420	01/13	>				S 3081 PO
FH 420	D13K-420 E6	309	420	05/14	>			S 7A03 A	S 9006 AR
by-pass	D13K-420 E6	309	420	05/14	>	S 4120 R			
inner / interno	D13K-420 E6	309	420	05/14	>			S 7A04 A	
2 filters / N.2 filtri	D13K-420 E6	309	420	05/14	>	S 4402 R			
prefilter / prefiltra	D13K-420 E6	309	420	05/14	>		S 4477 NR		
prefilter RACOR / prefiltra RACOR	D13K-420 E6	309	420	05/14	>		S 4477 NR		
power steering / servosterzo	D13K-420 E6	309	420	05/14	>				S 3081 PO
FH 460	D13C-460 E5/EEV	338	460	01/13	>		S 4120 NR	S 7A03 A	S 9006 AR
by-pass	D13C-460 E5/EEV	338	460	01/13	>	S 4120 R			
inner / interno	D13C-460 E5/EEV	338	460	01/13	>			S 7A04 A	
2 filters / N.2 filtri	D13C-460 E5/EEV	338	460	01/13	>	S 4402 R			
prefilter short filter / prefiltra filtro corto	D13C-460 E5/EEV	338	460	01/13	>		S 4157 NR		
prefilter long filter / prefiltra filtro lungo	D13C-460 E5/EEV	338	460	01/13	>		S 4146 NR		
prefilter RACOR / prefiltra RACOR	D13C-460 E5/EEV	338	460	01/13	>		S 4477 NR		
power steering / servosterzo	D13C-460 E5/EEV	338	460	01/13	>				S 3081 PO
FH 460	D13K-460 E6	338	460	05/14	>			S 7A03 A	S 9006 AR
by-pass	D13K-460 E6	338	460	05/14	>	S 4120 R			
inner / interno	D13K-460 E6	338	460	05/14	>			S 7A04 A	
2 filters / N.2 filtri	D13K-460 E6	338	460	05/14	>	S 4402 R			
prefilter RACOR / prefiltra RACOR	D13K-460 E6	338	460	05/14	>		S 4477 NR		
power steering / servosterzo	D13K-460 E6	338	460	05/14	>				S 3081 PO
FH 500	D13C-500 E5/EEV	368	500	01/13	>		S 4120 NR	S 7A03 A	S 9006 AR
by-pass	D13C-500 E5/EEV	368	500	01/13	>	S 4120 R			
inner / interno	D13C-500 E5/EEV	368	500	01/13	>			S 7A04 A	
2 filters / N.2 filtri	D13C-500 E5/EEV	368	500	01/13	>	S 4402 R			
prefilter short filter / prefiltra filtro corto	D13C-500 E5/EEV	368	500	01/13	>		S 4157 NR		
prefilter long filter / prefiltra filtro lungo	D13C-500 E5/EEV	368	500	01/13	>		S 4146 NR		
prefilter RACOR / prefiltra RACOR	D13C-500 E5/EEV	368	500	01/13	>		S 4477 NR		
power steering / servosterzo	D13C-500 E5/EEV	368	500	01/13	>				S 3081 PO
FH 500	D13K-500 E6	368	500	05/14	>			S 7A03 A	S 9006 AR
by-pass	D13K-500 E6	368	500	05/14	>	S 4120 R			
inner / interno	D13K-500 E6	368	500	05/14	>			S 7F19 A	
2 filters / N.2 filtri	D13K-500 E6	368	500	05/14	>	S 4402 R			
prefilter RACOR / prefiltra RACOR	D13K-500 E6	368	500	05/14	>		S 4477 NR		
power steering / servosterzo	D13K-500 E6	368	500	05/14	>				S 3081 PO
FH 540	D13C-540 E5	397	540	01/13	>		S 4120 NR	S 7A03 A	S 9006 AR
by-pass	D13C-540 E5	397	540	01/13	>	S 4120 R			
inner / interno	D13C-540 E5	397	540	01/13	>			S 7A04 A	
2 filters / N.2 filtri	D13C-540 E5	397	540	01/13	>	S 4402 R			
prefilter short filter / prefiltra filtro corto	D13C-540 E5	397	540	01/13	>		S 4157 NR		
prefilter long filter / prefiltra filtro lungo	D13C-540 E5	397	540	01/13	>		S 4146 NR		
prefilter RACOR / prefiltra RACOR	D13C-540 E5	397	540	01/13	>		S 4477 NR		
power steering / servosterzo	D13C-540 E5	397	540	01/13	>				S 3081 PO
FH 540	D13K-540 E6	397	540	05/14	>			S 7A03 A	S 9006 AR
by-pass	D13K-540 E6	397	540	05/14	>	S 4120 R			
inner / interno	D13K-540 E6	397	540	05/14	>			S 7A04 A	
2 filters / N.2 filtri	D13K-540 E6	397	540	05/14	>	S 4402 R			
prefilter RACOR / prefiltra RACOR	D13K-540 E6	397	540	05/14	>		S 4477 NR		
power steering / servosterzo	D13K-540 E6	397	540	05/14	>				S 3081 PO
FH 540	D16G-540 E5	397	540	01/13	>		S 4120 NR	S 7F18 A	S 9006 AR
by-pass	D16G-540 E5	397	540	01/13	>	S 4120 R			
2 filters / N.2 filtri	D16G-540 E5	397	540	01/13	>	S 4402 R			
prefilter / prefiltra	D16G-540 E5	397	540	01/13	>		S 4461 NR		
power steering / servosterzo	D16G-540 E5	397	540	01/13	>				S 3081 PO
long version / versione lunga	D16G-540 E5	397	540	01/13	>		S 4476 NR		
FH 550	D13K-550 E6	405	550	05/14	>			S 7F18 A	S 9006 AR
by-pass	D13K-550 E6	405	550	05/14	>	S 4120 R			
2 filters / N.2 filtri	D13K-550 E6	405	550	05/14	>	S 4402 R			
power steering / servosterzo	D13K-550 E6	405	550	05/14	>				S 3081 PO
FH 600	D16G-600 E5	441	600	01/13	>		S 4120 NR	S 7F18 A	S 9006 AR
by-pass	D16G-600 E5	441	600	01/13	>	S 4120 R			
2 filters / N.2 filtri	D16G-600 E5	441	600	01/13	>	S 4402 R			
prefilter / prefiltra	D16G-600 E5	441	600	01/13	>		S 4461 NR		

V



...VOLVO - trucks/autocarri

V

power steering / servosterzo	D16G-600 E5	441	600	01/13	>			S 3081 PO
long version / versione lunga	D16G-600 E5	441	600	01/13	>		S 4476 NR	
FH 650	D16K-650 E6	478	650	05/14	>			S 7F18 A
by-pass	D16K-650 E6	478	650	05/14	>	S 4120 R		S 9006 AR
2 filters / N.2 filtri	D16K-650 E6	478	650	05/14	>	S 4402 R		
power steering / servosterzo	D16K-650 E6	478	650	05/14	>			S 3081 PO
FH 700	D16G-700 E5	515	700	01/13	>		S 4120 NR	S 7F18 A
by-pass	D16G-700 E5	515	700	01/13	>	S 4120 R		S 9006 AR
2 filters / N.2 filtri	D16G-700 E5	515	700	01/13	>	S 4402 R		
prefilter / prefiltra	D16G-700 E5	515	700	01/13	>		S 4461 NR	
power steering / servosterzo	D16G-700 E5	515	700	01/13	>			S 3081 PO
long version / versione lunga	D16G-700 E5	515	700	01/13	>		S 4476 NR	
FH 750	D16G-750 E5	551	750	01/13	>		S 4120 NR	S 7F18 A
by-pass	D16G-750 E5	551	750	01/13	>	S 4120 R		S 9006 AR
2 filters / N.2 filtri	D16G-750 E5	551	750	01/13	>	S 4402 R		
prefilter / prefiltra	D16G-750 E5	551	750	01/13	>		S 4461 NR	
power steering / servosterzo	D16G-750 E5	551	750	01/13	>			S 3081 PO
long version / versione lunga	D16G-750 E5	551	750	01/13	>		S 4476 NR	
FH 750	D16G-750 E5/EEV	551	750	01/13	>		S 4120 NR	S 7F18 A
by-pass	D16G-750 E5/EEV	551	750	01/13	>	S 4120 R		S 9006 AR
2 filters / N.2 filtri	D16G-750 E5/EEV	551	750	01/13	>	S 4402 R		
prefilter / prefiltra	D16G-750 E5/EEV	551	750	01/13	>		S 4461 NR	
power steering / servosterzo	D16G-750 E5/EEV	551	750	01/13	>			S 3081 PO
FH 750	D16K-750 E6	552	750	05/14	>			S 7F18 A
by-pass	D16K-750 E6	552	750	05/14	>	S 4120 R		S 9006 AR
2 filters / N.2 filtri	D16K-750 E6	552	750	05/14	>	S 4402 R		
power steering / servosterzo	D16K-750 E6	552	750	05/14	>			S 3081 PO
long version / versione lunga	D16K-750 E6	552	750	05/14	>		S 4476 NR	
FH12 Serie								
FH12-340	D12A/B/C340	250	340	08/93	> 03/02		S 5020 NR	S 3089 C
with activated carbons / ai carboni attivi	D12A/B/C340	250	340	08/93	> 03/02			S 4260 CA
by-pass	D12A/B/C340	250	340	08/93	> 03/02	S 4120 R		
with outer front air intake / con presa aria frontale, esterno	D12A/B/C340	250	340	08/93	> 03/02			S 7285 A
water filter / filtro acqua	D12A/B/C340	250	340	08/93	> 03/02			S 9006 AR
dryer filter WABCO / filtro essiccatore WABCO	D12A/B/C340	250	340	08/93	> 03/02			S 7259 A
inner / interno	D12A/B/C340	250	340	08/93	> 03/02			S 7576 A
2 filters / N.2 filtri	D12A/B/C340	250	340	08/93	> 03/02	S 0900 R		
2 filters LONG LIFE / N.2 filtri LONG LIFE	D12A/B/C340	250	340	08/93	> 03/02	S 4402 R		
power steering / servosterzo	D12A/B/C340	250	340	08/93	> 03/02			S 3081 PO
FH12-380	D12A/B/C380	279	380	08/93	> 03/02		S 5020 NR	S 3089 C
with activated carbons / ai carboni attivi	D12A/B/C380	279	380	08/93	> 03/02			S 4260 CA
by-pass	D12A/B/C380	279	380	08/93	> 03/02	S 4120 R		
with outer front air intake / con presa aria frontale, esterno	D12A/B/C380	279	380	08/93	> 03/02			S 7285 A
water filter / filtro acqua	D12A/B/C380	279	380	08/93	> 03/02			S 9006 AR
dryer filter WABCO / filtro essiccatore WABCO	D12A/B/C380	279	380	08/93	> 03/02			S 7259 A
inner / interno	D12A/B/C380	279	380	08/93	> 03/02			S 7576 A
2 filters / N.2 filtri	D12A/B/C380	279	380	08/93	> 03/02	S 0900 R		
2 filters LONG LIFE / N.2 filtri LONG LIFE	D12A/B/C380	279	380	08/93	> 03/02	S 4402 R		
power steering / servosterzo	D12A/B/C380	279	380	08/93	> 03/02			S 3081 PO
FH12-380	D12D380	279	380	11/01	> 12/05		S 9320 NR	S 7345 A
with activated carbons / ai carboni attivi	D12D380	279	380	11/01	> 12/05			S 3089 C
by-pass	D12D380	279	380	11/01	> 12/05	S 4120 R		S 4260 CA
dryer filter WABCO / filtro essiccatore WABCO	D12D380	279	380	11/01	> 12/05			S 7259 A
inner / interno	D12D380	279	380	11/01	> 12/05			S 7576 A
LONG LIFE	D12D380	279	380	11/01	> 12/05		S 4120 NR	
2 filters / N.2 filtri	D12D380	279	380	11/01	> 12/05	S 0900 R		
2 filters LONG LIFE / N.2 filtri LONG LIFE	D12D380	279	380	11/01	> 12/05	S 4402 R		
prefilter / prefiltra	D12D380	279	380	11/01	> 12/05		S 4461 NR	
power steering / servosterzo	D12D380	279	380	11/01	> 12/05			S 3081 PO
FH12-420	D12A/B/C420	309	420	08/93	> 03/02		S 5020 NR	S 3089 C
with activated carbons / ai carboni attivi	D12A/B/C420	309	420	08/93	> 03/02			S 4260 CA
by-pass	D12A/B/C420	309	420	08/93	> 03/02	S 4120 R		
with outer front air intake / con presa aria frontale, esterno	D12A/B/C420	309	420	08/93	> 03/02			S 7285 A
water filter / filtro acqua	D12A/B/C420	309	420	08/93	> 03/02			S 9006 AR
dryer filter WABCO / filtro essiccatore WABCO	D12A/B/C420	309	420	08/93	> 03/02			S 7259 A
inner / interno	D12A/B/C420	309	420	08/93	> 03/02			S 7576 A
2 filters / N.2 filtri	D12A/B/C420	309	420	08/93	> 03/02	S 0900 R		



...VOLVO - trucks/autocarri

2 filters LONG LIFE / N.2 filtri LONG LIFE	D12A/B/C420	309 420	08/93 > 03/02	S 4402 R			
power steering / servosterzo	D12A/B/C420	309 420	08/93 > 03/02				S 3081 PO
FH12-420	D12D420	309 420	11/01 > 12/05		S 9320 NR	S 7345 A	S 3089 C
with activated carbons / ai carboni attivi	D12D420	309 420	11/01 > 12/05				S 4260 CA
by-pass	D12D420	309 420	11/01 > 12/05	S 4120 R			
dryer filter WABCO / filtro essiccatore WABCO	D12D420	309 420	11/01 > 12/05				S 7259 A
inner / interno	D12D420	309 420	11/01 > 12/05			S 7576 A	
LONG LIFE	D12D420	309 420	11/01 > 12/05		S 4120 NR		
2 filters / N.2 filtri	D12D420	309 420	11/01 > 12/05	S 0900 R			
2 filters LONG LIFE / N.2 filtri LONG LIFE	D12D420	309 420	11/01 > 12/05	S 4402 R			
prefilter / prefiltra	D12D420	309 420	11/01 > 12/05		S 4461 NR		
power steering / servosterzo	D12D420	309 420	11/01 > 12/05				S 3081 PO
FH12-460	D12C460	338 460	08/98 > 03/02		S 5020 NR		S 3089 C
with activated carbons / ai carboni attivi	D12C460	338 460	08/98 > 03/02				S 4260 CA
by-pass	D12C460	338 460	08/98 > 03/02	S 4120 R			
water filter / filtro acqua	D12C460	338 460	08/98 > 03/02				S 9006 AR
dryer filter WABCO / filtro essiccatore WABCO	D12C460	338 460	08/98 > 03/02				S 7259 A
outer filter with cover / filtro esterno con coperchio	D12C460	338 460	08/98 > 03/02			S 7285 A	
outer filter without cover / filtro esterno senza coperchio	D12C460	338 460	08/98 > 03/02			S 7345 A	
inner / interno	D12C460	338 460	08/98 > 03/02			S 7576 A	
2 filters / N.2 filtri	D12C460	338 460	08/98 > 03/02	S 0900 R			
2 filters LONG LIFE / N.2 filtri LONG LIFE	D12C460	338 460	08/98 > 03/02	S 4402 R			
power steering / servosterzo	D12C460	338 460	08/98 > 03/02				S 3081 PO
FH12-460	D12D460	338 460	11/01 > 12/05		S 9320 NR	S 7345 A	S 3089 C
with activated carbons / ai carboni attivi	D12D460	338 460	11/01 > 12/05				S 4260 CA
by-pass	D12D460	338 460	11/01 > 12/05	S 4120 R			
dryer filter WABCO / filtro essiccatore WABCO	D12D460	338 460	11/01 > 12/05				S 7259 A
inner / interno	D12D460	338 460	11/01 > 12/05			S 7576 A	
LONG LIFE	D12D460	338 460	11/01 > 12/05		S 4120 NR		
2 filters / N.2 filtri	D12D460	338 460	11/01 > 12/05	S 0900 R			
2 filters LONG LIFE / N.2 filtri LONG LIFE	D12D460	338 460	11/01 > 12/05	S 4402 R			
prefilter / prefiltra	D12D460	338 460	11/01 > 12/05		S 4461 NR		
power steering / servosterzo	D12D460	338 460	11/01 > 12/05				S 3081 PO
FH12-500	D12D500	368 500	11/01 > 12/05		S 9320 NR	S 7345 A	S 3089 C
with activated carbons / ai carboni attivi	D12D500	368 500	11/01 > 12/05				S 4260 CA
by-pass	D12D500	368 500	11/01 > 12/05	S 4120 R			
dryer filter WABCO / filtro essiccatore WABCO	D12D500	368 500	11/01 > 12/05				S 7259 A
inner / interno	D12D500	368 500	11/01 > 12/05			S 7576 A	
LONG LIFE	D12D500	368 500	11/01 > 12/05		S 4120 NR		
2 filters / N.2 filtri	D12D500	368 500	11/01 > 12/05	S 0900 R			
2 filters LONG LIFE / N.2 filtri LONG LIFE	D12D500	368 500	11/01 > 12/05	S 4402 R			
prefilter / prefiltra	D12D500	368 500	11/01 > 12/05		S 4461 NR		
power steering / servosterzo	D12D500	368 500	11/01 > 12/05				S 3081 PO
FH16 Serie							
FH 16-470	D16A/B470	346 470	08/93 > 12/03			S 7278 A	S 3089 C
with activated carbons / ai carboni attivi	D16A/B470	346 470	08/93 > 12/03				S 4260 CA
by-pass	D16A/B470	346 470	08/93 > 12/03	S 4120 R			
with automatic gearbox / con cambio automatico	D16A/B470	346 470	08/93 > 12/03				S 5238 PE
water filter / filtro acqua	D16A/B470	346 470	08/93 > 12/03				S 9006 AR
inner / interno	D16A/B470	346 470	08/93 > 12/03			S 7576 A	
LONG LIFE 2 filters / LONG LIFE N.2 filtri	D16A/B470	346 470	08/93 > 12/03	S 4402 R			
2 filters / N.2 filtri	D16A/B470	346 470	08/93 > 12/03	S 0900 R	S 4323 NR		
power steering (Ø 60) / servosterzo (Ø 60)	D16A/B470	346 470	08/93 > 12/03				S 3081 PO
FH16-520	D16A/B520	382 520	08/93 > 12/03			S 7278 A	S 3089 C
with activated carbons / ai carboni attivi	D16A/B520	382 520	08/93 > 12/03				S 4260 CA
by-pass	D16A/B520	382 520	08/93 > 12/03	S 4120 R			
with automatic gearbox / con cambio automatico	D16A/B520	382 520	08/93 > 12/03				S 5238 PE
inner / interno	D16A/B520	382 520	08/93 > 12/03			S 7576 A	
LONG LIFE 2 filters / LONG LIFE N.2 filtri	D16A/B520	382 520	08/93 > 12/03	S 4402 R			
2 filters / N.2 filtri	D16A/B520	382 520	08/93 > 12/03	S 0900 R	S 4323 NR		
power steering (Ø 60) / servosterzo (Ø 60)	D16A/B520	382 520	08/93 > 12/03				S 3081 PO
FH16-540	D16E/G540	397 540	09/08 >			S 7F18 A	S 3089 C
with activated carbons / ai carboni attivi	D16E/G540	397 540	09/08 >				S 4260 CA
by-pass	D16E/G540	397 540	09/08 >	S 4120 R			
with automatic gearbox / con cambio automatico	D16E/G540	397 540	09/08 >				S 5238 PE
with filter Urea/Adblue / con filtro Urea/Adblue	D16E/G540	397 540	09/08 >				S 4402 U
water filter / filtro acqua	D16E/G540	397 540	09/08 >				S 9006 AR

V



...VOLVO - trucks/autocarri

2 filters / N.2 filtri	D16E/G540	397 540	09/08 >	S 4402 R		
prefilter / prefiltrato	D16E/G540	397 540	09/08 >		S 4461 NR	
power steering (Ø 60) / servosterzo (Ø 60)	D16E/G540	397 540	09/08 >			S 3081 PO
long version / versione lunga	D16E/G540	397 540	09/08 >		S 4476 NR	
FH16-540	D16E540	397 540	02/06 > 08/08		S 9320 NR	S 7F18 A
with activated carbons / ai carboni attivi	D16E540	397 540	02/06 > 08/08			S 4260 CA
by-pass	D16E540	397 540	02/06 > 08/08	S 4120 R		
with automatic gearbox / con cambio automatico	D16E540	397 540	02/06 > 08/08			S 5238 PE
with filter Urea/Adblue / con filtro Urea/Adblue	D16E540	397 540	02/06 > 08/08			S 4402 U
water filter / filtro acqua	D16E540	397 540	02/06 > 08/08			S 9006 AR
2 filters / N.2 filtri	D16E540	397 540	02/06 > 08/08	S 4402 R		
prefilter / prefiltrato	D16E540	397 540	02/06 > 08/08		S 4461 NR	
power steering (Ø 60) / servosterzo (Ø 60)	D16E540	397 540	02/06 > 08/08			S 3081 PO
long version / versione lunga	D16E540	397 540	02/06 > 08/08		S 4476 NR	
FH16-550	D16C550	405 550	06/03 > 08/08		S 9320 NR	S 7F18 A
with activated carbons / ai carboni attivi	D16C550	405 550	06/03 > 08/08			S 4260 CA
by-pass	D16C550	405 550	06/03 > 08/08	S 4120 R		
with automatic gearbox / con cambio automatico	D16C550	405 550	06/03 > 08/08			S 5238 PE
with filter Urea/Adblue / con filtro Urea/Adblue	D16C550	405 550	04/05 > 08/08			S 4402 U
water filter / filtro acqua	D16C550	405 550	06/03 > 08/08			S 9006 AR
2 filters / N.2 filtri	D16C550	405 550	06/03 > 08/08	S 4402 R		
prefilter / prefiltrato	D16C550	405 550	06/03 > 08/08		S 4461 NR	
power steering (Ø 60) / servosterzo (Ø 60)	D16C550	405 550	06/03 > 08/08			S 3081 PO
long version / versione lunga	D16C550	405 550	06/03 > 08/08		S 4476 NR	
FH16-580	D16E/G580	426 580	09/08 >			S 7F18 A
with activated carbons / ai carboni attivi	D16E/G580	426 580	09/08 >			S 4260 CA
by-pass	D16E/G580	426 580	09/08 >	S 4120 R		
with automatic gearbox / con cambio automatico	D16E/G580	426 580	09/08 >			S 5238 PE
with filter Urea/Adblue / con filtro Urea/Adblue	D16E/G580	426 580	09/08 >			S 4402 U
water filter / filtro acqua	D16E/G580	426 580	09/08 >			S 9006 AR
2 filters / N.2 filtri	D16E/G580	426 580	09/08 >	S 4402 R		
prefilter / prefiltrato	D16E/G580	426 580	09/08 >		S 4461 NR	
power steering (Ø 60) / servosterzo (Ø 60)	D16E/G580	426 580	09/08 >			S 3081 PO
long version / versione lunga	D16E/G580	426 580	09/08 >		S 4476 NR	
FH16-580	D16E580	426 580	02/06 > 08/08		S 9320 NR	S 7F18 A
with activated carbons / ai carboni attivi	D16E580	426 580	02/06 > 08/08			S 4260 CA
by-pass	D16E580	426 580	02/06 > 08/08	S 4120 R		
with automatic gearbox / con cambio automatico	D16E580	426 580	02/06 > 08/08			S 5238 PE
with filter Urea/Adblue / con filtro Urea/Adblue	D16E580	426 580	02/06 > 08/08			S 4402 U
water filter / filtro acqua	D16E580	426 580	02/06 > 08/08			S 9006 AR
2 filters / N.2 filtri	D16E580	426 580	02/06 > 08/08	S 4402 R		
prefilter / prefiltrato	D16E580	426 580	02/06 > 08/08		S 4461 NR	
power steering (Ø 60) / servosterzo (Ø 60)	D16E580	426 580	02/06 > 08/08			S 3081 PO
long version / versione lunga	D16E580	426 580	02/06 > 08/08		S 4476 NR	
FH16-600	D16G600	441 600	01/09 >			S 7F18 A
with activated carbons / ai carboni attivi	D16G600	441 600	01/09 >			S 4260 CA
by-pass	D16G600	441 600	01/09 >	S 4120 R		
with automatic gearbox / con cambio automatico	D16G600	441 600	01/09 >			S 5238 PE
with filter Urea/Adblue / con filtro Urea/Adblue	D16G600	441 600	01/09 >			S 4402 U
water filter / filtro acqua	D16G600	441 600	01/09 >			S 9006 AR
2 filters / N.2 filtri	D16G600	441 600	01/09 >	S 4402 R		
prefilter / prefiltrato	D16G600	441 600	01/09 >		S 4461 NR	
power steering (Ø 60) / servosterzo (Ø 60)	D16G600	441 600	01/09 >			S 3081 PO
long version / versione lunga	D16G600	441 600	01/09 >		S 4476 NR	
FH16-610	D16C610	449 610	06/03 > 08/08		S 9320 NR	S 7F18 A
with activated carbons / ai carboni attivi	D16C610	449 610	06/03 > 08/08			S 4260 CA
by-pass	D16C610	449 610	06/03 > 08/08	S 4120 R		
with automatic gearbox / con cambio automatico	D16C610	449 610	06/03 > 08/08			S 5238 PE
with filter Urea/Adblue / con filtro Urea/Adblue	D16C610	449 610	04/05 > 08/08			S 4402 U
water filter / filtro acqua	D16C610	449 610	06/03 > 08/08			S 9006 AR
2 filters / N.2 filtri	D16C610	449 610	06/03 > 08/08	S 4402 R		
prefilter / prefiltrato	D16C610	449 610	06/03 > 08/08		S 4461 NR	
power steering (Ø 60) / servosterzo (Ø 60)	D16C610	449 610	06/03 > 08/08			S 3081 PO
long version / versione lunga	D16C610	449 610	06/03 > 08/08		S 4476 NR	
FH16-660	D16E/G660	485 660	09/08 >			S 7F18 A
with activated carbons / ai carboni attivi	D16E/G660	485 660	09/08 >			S 4260 CA
by-pass	D16E/G660	485 660	09/08 >	S 4120 R		

**KW HP****...VOLVO - trucks/autocarri**

with automatic gearbox / con cambio automatico	D16E/G660	485 660	09/08 >				S 5238 PE	
with filter Urea/Adblue / con filtro Urea/Adblue	D16E/G660	485 660	09/08 >				S 4402 U	
water filter / filtro acqua	D16E/G660	485 660	09/08 >				S 9006 AR	
dryer filter / filtro essiccatore	D16E/G660	485 660	09/08 >			S 4476 NR		
2 filters / N.2 filtri	D16E/G660	485 660	09/08 >	S 4402 R				
prefilter / prefiltra	D16E/G660	485 660	09/08 >		S 4461 NR			
power steering (Ø 60) / servosterzo (Ø 60)	D16E/G660	485 660	09/08 >				S 3081 PO	
FH16-660	D16E660	485 660	02/06 > 08/08		S 9320 NR	S 7F18 A	S 3089 C	
with activated carbons / ai carboni attivi	D16E660	485 660	02/06 > 08/08				S 4260 CA	
by-pass	D16E660	485 660	02/06 > 08/08	S 4120 R				
with automatic gearbox / con cambio automatico	D16E660	485 660	02/06 > 08/08				S 5238 PE	
with filter Urea/Adblue / con filtro Urea/Adblue	D16E660	485 660	02/06 > 08/08				S 4402 U	
water filter / filtro acqua	D16E660	485 660	02/06 > 08/08				S 9006 AR	
2 filters / N.2 filtri	D16E660	485 660	02/06 > 08/08	S 4402 R				
prefilter / prefiltra	D16E660	485 660	02/06 > 08/08		S 4461 NR			
power steering (Ø 60) / servosterzo (Ø 60)	D16E660	485 660	02/06 > 08/08				S 3081 PO	
long version / versione lunga	D16E660	485 660	02/06 > 08/08		S 4476 NR			
FH16-700	D16G700	515 700	05/09 >			S 7F18 A	S 3089 C	
with activated carbons / ai carboni attivi	D16G700	515 700	05/09 >				S 4260 CA	
by-pass	D16G700	515 700	05/09 >	S 4120 R				
with automatic gearbox / con cambio automatico	D16G700	515 700	05/09 >				S 5238 PE	
with filter Urea/Adblue / con filtro Urea/Adblue	D16G700	515 700	05/09 >				S 4402 U	
water filter / filtro acqua	D16G700	515 700	05/09 >				S 9006 AR	
2 filters / N.2 filtri	D16G700	515 700	05/09 >	S 4402 R				
prefilter / prefiltra	D16G700	515 700	05/09 >		S 4461 NR			
power steering (Ø 60) / servosterzo (Ø 60)	D16G700	515 700	05/09 >				S 3081 PO	
long version / versione lunga	D16G700	515 700	05/09 >		S 4476 NR			
FH16-750	D16G750	552 750	01/12 >			S 7F18 A	S 3089 C	
with activated carbons / ai carboni attivi	D16G750	552 750	01/12 >				S 4260 CA	
by-pass	D16G750	552 750	01/12 >	S 4120 R				
with automatic gearbox / con cambio automatico	D16G750	552 750	01/12 >				S 5238 PE	
with filter / con filtro	D16G750	552 750	01/12 >				S 4402 U	
water filter / filtro acqua	D16G750	552 750	01/12 >				S 9006 AR	
dryer filter / filtro essiccatore	D16G750	552 750	01/12 >		S 4476 NR			
2 filters / N.2 filtri	D16G750	552 750	01/12 >	S 4402 R				
prefilter / prefiltra	D16G750	552 750	01/12 >		S 4461 NR			
power steering (Ø 60) / servosterzo (Ø 60)	D16G750	552 750	01/12 >				S 3081 PO	
FL Serie I								
FL180	D6B180	132 180	05/00 > 07/06	S 0900 R	S 5020 NR			
by-pass	D6B180	132 180	05/00 > 07/06	S 4120 R				
FL220	D6B220	162 220	05/00 > 07/06	S 0900 R	S 5020 NR			
by-pass	D6B220	162 220	05/00 > 07/06	S 4120 R				
FL250	D6B250	184 250	05/00 > 07/06	S 0900 R	S 5020 NR			
by-pass	D6B250	184 250	05/00 > 07/06	S 4120 R				
FL Serie II								
FL240	D7E	177 240	04/06 >	S 5097 PE	S 6039 NE	S 7B10 A		
with filter Urea/Adblue / con filtro Urea/Adblue	D7E	177 240	04/06 >		S 4158 NR		S 4402 U	
prefilter / prefiltra	D7E	177 240	04/06 >		S 4158 NR			
FL260	D7F	191 260	04/09 >	S 5097 PE	S 6039 NE	S 7643 A		
with filter Urea/Adblue / con filtro Urea/Adblue	D7F	191 260	04/09 >				S 4402 U	
inner / interno	D7F	191 260	04/09 >			S 7406 A		
prefilter / prefiltra	D7F	191 260	04/09 >		S 4158 NR			
FL280	D7E/D7F	206 280	04/06 >	S 5097 PE	S 6039 NE	S 7643 A		
with filter Urea/Adblue / con filtro Urea/Adblue	D7E/D7F	206 280	04/06 >				S 4402 U	
inner / interno	D7E/D7F	206 280	04/06 >			S 7406 A		
prefilter / prefiltra	D7E/D7F	206 280	04/06 >		S 4158 NR			
FL290	D7F	213 290	04/09 >	S 5097 PE	S 6039 NE	S 7643 A		
with filter Urea/Adblue / con filtro Urea/Adblue	D7F	213 290	04/09 >				S 4402 U	
inner / interno	D7F	213 290	04/09 >			S 7406 A		
prefilter / prefiltra	D7F	213 290	04/09 >		S 4158 NR			
FL Serie III								
FL 210	D5K	154 210	09/13 >			S 7B10 A		
dryer filter KNORR EAC1/EAC2 / filtro essiccatore KNORR EAC1/EAC2	D5K	154 210	09/13 >				S 7F23 A	
FL 240	D5K	177 240	09/13 >			S 7B10 A		
dryer filter KNORR EAC1/EAC2 / filtro essiccatore KNORR EAC1/EAC2	D5K	177 240	09/13 >				S 7F23 A	
FL 250	D8K	184 250	09/13 >			S 7B10 A		
dryer filter KNORR EAC1/EAC2 / filtro essiccatore KNORR EAC1/EAC2	D8K	184 250	09/13 >				S 7F23 A	





...VOLVO - trucks/autocarri

V

FL 280	D8K	206	280	09/13	>			S 7B10 A	
dryer filter KNORR EAC1/EAC2 / filtro essiccatore KNORR EAC1/EAC2	D8K	206	280	09/13	>				S 7F23 A
FL10 Serie									
FL10	D10A 310/320/350/360			02/95	>	12/98			
by-pass	D10A 310/320/350/360			02/95	>	12/98	S 4120 R		S 7548 A
with oil radiator for gearbox (4/7) / con radiatore dell'olio per il cambio (4/7)	D10A 310/320/350/360			02/95	>	12/98			S 3051 A
inner / interno	D10A 310/320/350/360			02/95	>	12/98		S 7549 A	
LONG LIFE 2 filters / LONG LIFE N.2 filtri	D10A 310/320/350/360			02/95	>	12/98	S 4402 R		
2 filters / N.2 filtri	D10A 310/320/350/360			02/95	>	12/98	S 0900 R	S 4323 NR	
power steering (Ø 60) / servosterzo (Ø 60)	D10A 310/320/350/360			02/95	>	12/98			S 3081 PO
power steering (Ø 80) / servosterzo (Ø 80)	D10A 310/320/350/360			02/95	>	12/98			S 8790 PO
bleed / sfiato	D10A 310/320/350/360			02/95	>	12/98			S 7091 A
bleed / sfiato	D10A 310/320/350/360			02/95	>	12/98			S 7092 A
drive (R/SR 1400/1700) / trasmissione (R/SR 1400/1700)	D10A 310/320/350/360			02/95	>	12/98			S 3257 R
FL10	TD101F/TD102F/TD103E			09/85	>	05/96			S 3051 A
to frame No. 324580 / a telaio N. 324580	TD101F/TD102F/TD103E			09/85	>	12/89		S 7578 A	
with oil radiator for gearbox (4/7) / con radiatore dell'olio per il cambio (4/7)	TD101F/TD102F/TD103E			09/85	>	05/96			S 3257 R
from frame No. 324581 / da telaio N. 324581	TD101F/TD102F/TD103E			01/90	>	05/96		S 7548 A	
inner from frame No. 324581 / interno da telaio N. 324581	TD101F/TD102F/TD103E			01/90	>	05/96		S 7549 A	
LONG LIFE 2 filters / LONG LIFE N.2 filtri	TD101F/TD102F/TD103E			09/85	>	05/96	S 4402 R		
2 filters / N.2 filtri	TD101F/TD102F/TD103E			09/85	>	05/96	S 0900 R	S 4323 NR	
power steering (Ø 60) / servosterzo (Ø 60)	TD101F/TD102F/TD103E			09/85	>	05/96			S 3081 PO
power steering (Ø 80) / servosterzo (Ø 80)	TD101F/TD102F/TD103E			09/85	>	05/96			S 8790 PO
bleed / sfiato	TD101F/TD102F/TD103E			09/85	>	05/96			S 7091 A
bleed / sfiato	TD101F/TD102F/TD103E			09/85	>	05/96			S 7092 A
drive (R/SR 1400/1700) / trasmissione (R/SR 1400/1700)	TD101F/TD102F/TD103E			09/85	>	05/96			S 3257 R
FL10H	TD101, TD102, TD103						S 0900 R	S 4323 NR	S 3051 A
with oil radiator for gearbox (4/7) / con radiatore dell'olio per il cambio (4/7)	TD101, TD102, TD103								S 3257 R
power steering (Ø 60) / servosterzo (Ø 60)	TD101, TD102, TD103								S 3081 PO
power steering (Ø 80) / servosterzo (Ø 80)	TD101, TD102, TD103								S 8790 PO
bleed / sfiato	TD101, TD102, TD103								S 7091 A
bleed / sfiato	TD101, TD102, TD103								S 7092 A
drive (R/SR 1400/1700) / trasmissione (R/SR 1400/1700)	TD101, TD102, TD103								S 3257 R
FL12 Serie									
FL12	D12A380	279	380	09/95	>	09/98	S 0900 R	S 5020 NR	S 7277 A
by-pass	D12A380	279	380	09/95	>	09/98	S 4120 R		
water filter / filtro acqua	D12A380	279	380	09/95	>	09/98			S 9006 AR
inner / interno	D12A380	279	380	09/95	>	09/98		S 7572 A	
LONG LIFE	D12A380	279	380	09/95	>	09/98	S 4402 R		
power steering / servosterzo	D12A380	279	380	09/95	>	09/98			S 3081 PO
FL12	D12A420	309	420	09/95	>	09/98	S 0900 R	S 5020 NR	S 7277 A
by-pass	D12A420	309	420	09/95	>	09/98	S 4120 R		
water filter / filtro acqua	D12A420	309	420	09/95	>	09/98			S 9006 AR
LONG LIFE	D12A420	309	420	09/95	>	09/98	S 4402 R		
power steering / servosterzo	D12A420	309	420	09/95	>	09/98			S 3081 PO
FL4 Serie									
FL4 (FL4.07)	TD41G			02/86	>	12/95	S 5800 R	S 8500 NR	S 6870 A
power steering / servosterzo	TD41G			02/86	>	12/95			S 3081 PO
FL4 (FL4.08)	TD41G			02/86	>	12/95	S 5800 R	S 8500 NR	S 6870 A
power steering / servosterzo	TD41G			02/86	>	12/95			S 3081 PO
FL6 Serie									
FL6		132	180	12/95	>		S 0900 R	S 4323 NR	
by-pass		132	180	12/95	>		S 4120 R		
dryer filter / filtro essiccatore		132	180	12/95	>				S 7259 A
power steering / servosterzo		132	180	12/95	>				S 3081 PO
FL6		154	210	12/95	>		S 0900 R	S 4323 NR	
by-pass		154	210	12/95	>		S 4120 R		
dryer filter / filtro essiccatore		154	210	12/95	>				S 7259 A
power steering / servosterzo		154	210	12/95	>				S 3081 PO
FL6		183	250	12/95	>		S 0900 R	S 4323 NR	
by-pass		183	250	12/95	>		S 4120 R		
dryer filter / filtro essiccatore		183	250	12/95	>				S 7259 A
power steering / servosterzo		183	250	12/95	>				S 3081 PO
FL6	TD61F/TD61GS/TD61S			09/85	>		S 0900 R	S 4323 NR	S 6870 A
power steering / servosterzo	TD61F/TD61GS/TD61S			09/85	>				S 3081 PO
bleed / sfiato	TD61F/TD61GS/TD61S			09/85	>				S 7091 A
drive (R1000) / trasmissione (R1000)	TD61F/TD61GS/TD61S			09/85	>				S 3257 R

**kW HP****...VOLVO - trucks/autocarri**

FL6	TD63E, TD63ES			01/91 >	S 0900 R	S 4323 NR		S 3081 PO
power steering / servosterzo	TD63E, TD63ES			01/91 >				S 7091 A
bleed / sfiato	TD63E, TD63ES			01/91 >				S 3257 R
drive (R1000) / trasmissione (R1000)	TD63E, TD63ES			01/91 >				
FL7 Serie								
FL7	D7A285	210 286		10/93 > 12/99	S 0900 R		S 7548 A	S 3051 A
by-pass	D7A285	210 286		10/93 > 12/99	S 4120 R			
inner / interno	D7A285	210 286		10/93 > 12/99		S 4323 NR	S 7549 A	
2 filters / N.2 filtri	D7A285	210 286		10/93 > 12/99				
power steering / servosterzo	D7A285	210 286		10/93 > 12/99				S 3081 PO
bleed / sfiato	D7A285	210 286		10/93 > 12/99				S 7091 A
drive / trasmissione	D7A285	210 286		10/93 > 12/99				S 3257 R
FL7	TD71/TD71F/TD71FS	169 230		09/85 > 10/94	S 0900 R			S 3051 A
to frame No. 324538 / a telaio N. 324538	TD71/TD71F/TD71FS	169 230		09/85 > 12/89			S 7578 A	
by-pass	TD71/TD71F/TD71FS	169 230		09/85 > 10/94	S 4120 R			S 3257 R
with oil radiator for gearbox (4) / con radiatore dell'olio per il cambio (4)	TD71/TD71F/TD71FS	169 230		09/85 > 10/94				
from frame No. 324539 / da telaio N. 324539	TD71/TD71F/TD71FS	169 230		01/90 > 10/94			S 7548 A	
inner to frame No. 324538 / interno a telaio N. 324538	TD71/TD71F/TD71FS	169 230		09/85 > 12/89			S 7549 A	
2 filters / N.2 filtri	TD71/TD71F/TD71FS	169 230		09/85 > 10/94		S 4323 NR		
power steering / servosterzo	TD71/TD71F/TD71FS	169 230		09/85 > 10/94				S 3081 PO
bleed / sfiato	TD71/TD71F/TD71FS	169 230		09/85 > 10/94				S 7091 A
bleed / sfiato	TD71/TD71F/TD71FS	169 230		09/85 > 10/94				S 7092 A
drive (R1000, SR1400, SR1700) / trasmissione (R1000, SR1400, SR1700)	TD71/TD71F/TD71FS	169 230		09/85 > 10/94				S 3257 R
FL7	TD73E/D7B260	191 260		11/91 > 12/99	S 0900 R		S 7548 A	S 3051 A
by-pass	TD73E/D7B260	191 260		11/91 > 12/99	S 4120 R			
inner / interno	TD73E/D7B260	191 260		11/91 > 12/99		S 4323 NR	S 7549 A	
2 filters / N.2 filtri	TD73E/D7B260	191 260		11/91 > 12/99				
power steering / servosterzo	TD73E/D7B260	191 260		11/91 > 12/99				S 3081 PO
bleed / sfiato	TD73E/D7B260	191 260		11/91 > 12/99				S 7091 A
drive / trasmissione	TD73E/D7B260	191 260		11/91 > 12/99				S 3257 R
FL7 (AUS)				09/85 > 12/99	S 0900 R			S 3051 A
by-pass				09/85 > 12/99	S 4120 R			
with oil radiator for gearbox (4) / con radiatore dell'olio per il cambio (4)				09/85 > 12/99				S 3257 R
2 filters / N.2 filtri				09/85 > 12/99		S 4323 NR		
power steering / servosterzo				09/85 > 12/99				S 3081 PO
bleed / sfiato				09/85 > 12/99				S 7091 A
bleed / sfiato				09/85 > 12/99				S 7092 A
drive (R1000, SR1400, SR1700) / trasmissione (R1000, SR1400, SR1700)				09/85 > 12/99				S 3257 R
FLC Serie								
FLC140	D4A 140			09/96 > 09/00	S 0420 R	S 8500 NR	S 2450 A	
power steering / servosterzo	D4A 140			09/96 > 09/00				S 3081 PO
FM Serie								
FM 300	D9B-300	220 300		09/05 > 07/09		S 9320 NR	S 7347 A	S 3089 C
with activated carbons / ai carboni attivi	D9B-300	220 300		09/05 > 07/09				S 4260 CA
by-pass	D9B-300	220 300		09/05 > 07/09	S 4120 R			
with automatic gearbox / con cambio automatico	D9B-300	220 300		09/05 > 07/09				S 5238 PE
with filter AdBlue/SCR Denoxtronic 2.0 / con filtro AdBlue/SCR Denoxtronic 2.0	D9B-300	220 300		09/05 > 07/09				S 4402 U
water filter / filtro acqua	D9B-300	220 300		09/05 > 07/09				S 9006 AR
inner / interno	D9B-300	220 300		09/05 > 07/09			S 7484 A	
LONG LIFE	D9B-300	220 300		09/05 > 07/09		S 4120 NR		
2 filters / N.2 filtri	D9B-300	220 300		09/05 > 07/09	S 4402 R			
prefilter short filter / prefilto filtro corto	D9B-300	220 300		09/05 > 07/09		S 4461 NR		
prefilter long filter / prefilto filtro lungo	D9B-300	220 300		09/05 > 07/09		S 4146 NR		
power steering / servosterzo	D9B-300	220 300		09/05 > 07/09				S 3081 PO
FM 330	D11C-330 E5/EEV	243 330		04/09 >		S 9320 NR	S 7347 A	S 3089 C
with activated carbons / ai carboni attivi	D11C-330 E5/EEV	243 330		04/09 >				S 4260 CA
by-pass	D11C-330 E5/EEV	243 330		04/09 >	S 4120 R			
with automatic gearbox / con cambio automatico	D11C-330 E5/EEV	243 330		04/09 >				S 5238 PE
with filter AdBlue/SCR Denoxtronic 2.0 / con filtro AdBlue/SCR Denoxtronic 2.0	D11C-330 E5/EEV	243 330		04/09 >				S 4402 U
water filter / filtro acqua	D11C-330 E5/EEV	243 330		04/09 >				S 9006 AR
inner / interno	D11C-330 E5/EEV	243 330		04/09 >			S 7484 A	
LONG LIFE	D11C-330 E5/EEV	243 330		04/09 >		S 4120 NR		
2 filters / N.2 filtri	D11C-330 E5/EEV	243 330		04/09 >	S 4402 R			
prefilter short filter / prefilto filtro corto	D11C-330 E5/EEV	243 330		04/09 >		S 4157 NR		
prefilter long filter / prefilto filtro lungo	D11C-330 E5/EEV	243 330		04/09 >		S 4146 NR		
power steering / servosterzo	D11C-330 E5/EEV	243 330		04/09 >				S 3081 PO
FM 330	D11K-330 Euro6	243 330		07/13 >				S 9006 AR



**KW HP****...VOLVO - trucks/autocarri**

by-pass	D11K-330 Euro6	243	330	07/13	>	S 4120 R		
outer / esterno	D11K-330 Euro6	243	330	07/13	>		S 7B39 A	
2 filters / N.2 filtri	D11K-330 Euro6	243	330	07/13	>	S 4402 R		
power steering / servosterzo	D11K-330 Euro6	243	330	07/13	>			S 3081 PO
FM 340	D9B-340	250	340	09/05	> 07/09		S 9320 NR	S 7347 A
with activated carbons / ai carboni attivi	D9B-340	250	340	09/05	> 07/09			S 3089 C
by-pass	D9B-340	250	340	09/05	> 07/09	S 4120 R		S 4260 CA
with automatic gearbox / con cambio automatico	D9B-340	250	340	09/05	> 08/08			S 5238 PE
with filter AdBlue/SCR Denoxtronic 2.0 / con filtro AdBlue/SCR Denoxtronic 2.0	D9B-340	250	340	09/05	> 07/09			S 4402 U
water filter / filtro acqua	D9B-340	250	340	09/05	> 07/09			S 9006 AR
inner / interno	D9B-340	250	340	09/05	> 07/09		S 7484 A	
LONG LIFE	D9B-340	250	340	09/05	> 07/09		S 4120 NR	
2 filters / N.2 filtri	D9B-340	250	340	09/05	> 07/09	S 4402 R		
prefilter short filter / prefiltra filtro corto	D9B-340	250	340	09/05	> 07/09		S 4461 NR	
prefilter long filter / prefiltra filtro lungo	D9B-340	250	340	09/05	> 07/09		S 4146 NR	
power steering / servosterzo	D9B-340	250	340	09/05	> 07/09			S 3081 PO
FM 360	D13A/D13B-360	264	360	09/05	> 07/09		S 9320 NR	S 7345 A
with activated carbons / ai carboni attivi	D13A/D13B-360	264	360	09/05	> 07/09			S 3089 C
by-pass	D13A/D13B-360	264	360	09/05	> 07/09	S 4120 R		S 4260 CA
with automatic gearbox / con cambio automatico	D13A/D13B-360	264	360	09/08	> 07/09			S 5238 PE
with filter AdBlue/SCR Denoxtronic 2.0 / con filtro AdBlue/SCR Denoxtronic 2.0	D13A/D13B-360	264	360	09/05	> 07/09			S 4402 U
water filter / filtro acqua	D13A/D13B-360	264	360	09/05	> 07/09			S 9006 AR
inner / interno	D13A/D13B-360	264	360	09/05	> 07/09		S 7576 A	
LONG LIFE	D13A/D13B-360	264	360	09/05	> 07/09		S 4120 NR	
2 filters / N.2 filtri	D13A/D13B-360	264	360	09/05	> 07/09	S 4402 R		
prefilter short filter / prefiltra filtro corto	D13A/D13B-360	264	360	09/05	> 07/09		S 4461 NR	
prefilter long filter / prefiltra filtro lungo	D13A/D13B-360	264	360	09/05	> 07/09		S 4146 NR	
power steering / servosterzo	D13A/D13B-360	264	360	09/05	> 07/09			S 3081 PO
FM 370	D11C-370 E5/EEV	272	370	04/09	>		S 9320 NR	S 7347 A
with activated carbons / ai carboni attivi	D11C-370 E5/EEV	272	370	04/09	>			S 3089 C
by-pass	D11C-370 E5/EEV	272	370	04/09	>	S 4120 R		S 4260 CA
with automatic gearbox / con cambio automatico	D11C-370 E5/EEV	272	370	04/09	>			S 5238 PE
with filter AdBlue/SCR Denoxtronic 2.0 / con filtro AdBlue/SCR Denoxtronic 2.0	D11C-370 E5/EEV	272	370	04/09	>			S 4402 U
water filter / filtro acqua	D11C-370 E5/EEV	272	370	04/09	>			S 9006 AR
inner / interno	D11C-370 E5/EEV	272	370	04/09	>		S 7484 A	
LONG LIFE	D11C-370 E5/EEV	272	370	04/09	>		S 4120 NR	
2 filters / N.2 filtri	D11C-370 E5/EEV	272	370	04/09	>	S 4402 R		
prefilter short filter / prefiltra filtro corto	D11C-370 E5/EEV	272	370	04/09	>		S 4157 NR	
prefilter long filter / prefiltra filtro lungo	D11C-370 E5/EEV	272	370	04/09	>		S 4146 NR	
power steering / servosterzo	D11C-370 E5/EEV	272	370	04/09	>			S 3081 PO
FM 370	D11K-370 Euro6	272	370	07/13	>			S 9006 AR
by-pass	D11K-370 Euro6	272	370	07/13	>	S 4120 R		
outer / esterno	D11K-370 Euro6	272	370	07/13	>		S 7B39 A	
2 filters / N.2 filtri	D11K-370 Euro6	272	370	07/13	>	S 4402 R		
power steering / servosterzo	D11K-370 Euro6	272	370	07/13	>			S 3081 PO
FM 380	D13C-380 E5/EEV	280	380	04/09	>		S 9320 NR	S 7345 A
with activated carbons / ai carboni attivi	D13C-380 E5/EEV	280	380	04/09	>			S 3089 C
by-pass	D13C-380 E5/EEV	280	380	04/09	>	S 4120 R		S 4260 CA
with automatic gearbox / con cambio automatico	D13C-380 E5/EEV	280	380	04/09	>			S 5238 PE
with filter AdBlue/SCR Denoxtronic 2.0 / con filtro AdBlue/SCR Denoxtronic 2.0	D13C-380 E5/EEV	280	380	04/09	>			S 4402 U
water filter / filtro acqua	D13C-380 E5/EEV	280	380	04/09	>			S 9006 AR
inner / interno	D13C-380 E5/EEV	280	380	04/09	>		S 7576 A	
LONG LIFE	D13C-380 E5/EEV	280	380	04/09	>		S 4120 NR	
2 filters / N.2 filtri	D13C-380 E5/EEV	280	380	04/09	>	S 4402 R		
prefilter short filter / prefiltra filtro corto	D13C-380 E5/EEV	280	380	04/09	>		S 4157 NR	
prefilter long filter / prefiltra filtro lungo	D13C-380 E5/EEV	280	380	04/09	>		S 4146 NR	
power steering / servosterzo	D13C-380 E5/EEV	280	380	04/09	>			S 3081 PO
FM 380	D9B-380	280	380	09/05	> 07/09		S 9320 NR	S 7347 A
with activated carbons / ai carboni attivi	D9B-380	280	380	09/05	> 07/09			S 3089 C
by-pass	D9B-380	280	380	09/05	> 07/09	S 4120 R		S 4260 CA
with automatic gearbox / con cambio automatico	D9B-380	280	380	09/05	> 07/09			S 5238 PE
with filter AdBlue/SCR Denoxtronic 2.0 / con filtro AdBlue/SCR Denoxtronic 2.0	D9B-380	280	380	09/05	> 07/09			S 4402 U
water filter / filtro acqua	D9B-380	280	380	09/05	> 07/09			S 9006 AR
inner / interno	D9B-380	280	380	09/05	> 07/09		S 7484 A	
LONG LIFE	D9B-380	280	380	09/05	> 07/09		S 4120 NR	
2 filters / N.2 filtri	D9B-380	280	380	09/05	> 07/09	S 4402 R		
prefilter short filter / prefiltra filtro corto	D9B-380	280	380	09/05	> 07/09		S 4461 NR	

**KW HP****...VOLVO - trucks/autocarri**

prefilter long filter / prefiltro filtro lungo	D9B-380	280	380	09/05	>	07/09		S 4146 NR		
power steering / servosterzo	D9B-380	280	380	09/05	>	07/09				S 3081 PO
FM 390	D11B-390	287	390	06/08	>	07/09		S 9320 NR	S 7347 A	S 3089 C
with activated carbons / ai carboni attivi	D11B-390	287	390	06/08	>	07/09				S 4260 CA
by-pass	D11B-390	287	390	06/08	>	07/09	S 4120 R			
with automatic gearbox / con cambio automatico	D11B-390	287	390	09/08	>	07/09				S 5238 PE
with filter AdBlue/SCR Denoxtronic 2.0 / con filtro AdBlue/SCR Denoxtronic 2.0	D11B-390	287	390	06/08	>	07/09				S 4402 U
water filter / filtro acqua	D11B-390	287	390	06/08	>	07/09				S 9006 AR
inner / interno	D11B-390	287	390	06/08	>	07/09			S 7484 A	
LONG LIFE	D11B-390	287	390	06/08	>	07/09		S 4120 NR		
2 filters / N.2 filtri	D11B-390	287	390	06/08	>	07/09	S 4402 R			
prefilter short filter / prefiltro filtro corto	D11B-390	287	390	06/08	>	07/09		S 4157 NR		
prefilter long filter / prefiltro filtro lungo	D11B-390	287	390	06/08	>	07/09		S 4146 NR		
power steering / servosterzo	D11B-390	287	390	06/08	>	07/09				S 3081 PO
FM 400	D13A/D13B-400	294	400	09/05	>			S 9320 NR	S 7345 A	S 3089 C
with activated carbons / ai carboni attivi	D13A/D13B-400	294	400	09/05	>					S 4260 CA
by-pass	D13A/D13B-400	294	400	09/05	>		S 4120 R			
with automatic gearbox / con cambio automatico	D13A/D13B-400	294	400	09/05	>	07/09				S 5238 PE
with filter AdBlue/SCR Denoxtronic 2.0 / con filtro AdBlue/SCR Denoxtronic 2.0	D13A/D13B-400	294	400	09/05	>					S 4402 U
water filter / filtro acqua	D13A/D13B-400	294	400	09/05	>					S 9006 AR
inner / interno	D13A/D13B-400	294	400	09/05	>				S 7576 A	
LONG LIFE	D13A/D13B-400	294	400	09/05	>			S 4120 NR		
2 filters / N.2 filtri	D13A/D13B-400	294	400	09/05	>		S 4402 R			
prefilter short filter / prefiltro filtro corto	D13A/D13B-400	294	400	09/05	>	08/08		S 4461 NR		
prefilter short filter / prefiltro filtro corto	D13A/D13B-400	294	400	09/08	>			S 4157 NR		
prefilter long filter / prefiltro filtro lungo	D13A/D13B-400	294	400	09/08	>			S 4146 NR		
power steering / servosterzo	D13A/D13B-400	294	400	09/05	>					S 3081 PO
FM 410	D11K-410 Euro6	302	410	07/13	>					S 9006 AR
by-pass	D11K-410 Euro6	302	410	07/13	>		S 4120 R			
outer / esterno	D11K-410 Euro6	302	410	07/13	>				S 7B39 A	
2 filters / N.2 filtri	D11K-410 Euro6	302	410	07/13	>		S 4402 R			
power steering / servosterzo	D11K-410 Euro6	302	410	07/13	>					S 3081 PO
FM 420	D13C-420 E5/EEV	309	420	04/09	>			S 9320 NR	S 7345 A	S 3089 C
with activated carbons / ai carboni attivi	D13C-420 E5/EEV	309	420	04/09	>					S 4260 CA
by-pass	D13C-420 E5/EEV	309	420	04/09	>		S 4120 R			
with automatic gearbox / con cambio automatico	D13C-420 E5/EEV	309	420	04/09	>					S 5238 PE
with filter AdBlue/SCR Denoxtronic 2.0 / con filtro AdBlue/SCR Denoxtronic 2.0	D13C-420 E5/EEV	309	420	04/09	>					S 4402 U
water filter / filtro acqua	D13C-420 E5/EEV	309	420	04/09	>					S 9006 AR
inner / interno	D13C-420 E5/EEV	309	420	04/09	>				S 7576 A	
LONG LIFE	D13C-420 E5/EEV	309	420	04/09	>			S 4120 NR		
2 filters / N.2 filtri	D13C-420 E5/EEV	309	420	04/09	>		S 4402 R			
prefilter short filter / prefiltro filtro corto	D13C-420 E5/EEV	309	420	04/09	>			S 4157 NR		
prefilter long filter / prefiltro filtro lungo	D13C-420 E5/EEV	309	420	04/09	>			S 4146 NR		
power steering / servosterzo	D13C-420 E5/EEV	309	420	04/09	>					S 3081 PO
FM 420	D13K-420 Euro6	309	420	07/13	>					S 9006 AR
by-pass	D13K-420 Euro6	309	420	07/13	>		S 4120 R			
outer / esterno	D13K-420 Euro6	309	420	07/13	>				S 7B39 A	
2 filters / N.2 filtri	D13K-420 Euro6	309	420	07/13	>		S 4402 R			
power steering / servosterzo	D13K-420 Euro6	309	420	07/13	>					S 3081 PO
FM 430	D11B-430	316	430	06/08	>	07/09		S 9320 NR	S 7347 A	S 3089 C
with activated carbons / ai carboni attivi	D11B-430	316	430	06/08	>	07/09				S 4260 CA
by-pass	D11B-430	316	430	06/08	>	07/09	S 4120 R			
with automatic gearbox / con cambio automatico	D11B-430	316	430	09/08	>	07/09				S 5238 PE
with filter AdBlue/SCR Denoxtronic 2.0 / con filtro AdBlue/SCR Denoxtronic 2.0	D11B-430	316	430	06/08	>	07/09				S 4402 U
water filter / filtro acqua	D11B-430	316	430	06/08	>	07/09				S 9006 AR
inner / interno	D11B-430	316	430	06/08	>	07/09			S 7484 A	
LONG LIFE	D11B-430	316	430	06/08	>	07/09		S 4120 NR		
2 filters / N.2 filtri	D11B-430	316	430	06/08	>	07/09	S 4402 R			
prefilter short filter / prefiltro filtro corto	D11B-430	316	430	06/08	>	07/09		S 4157 NR		
prefilter long filter / prefiltro filtro lungo	D11B-430	316	430	06/08	>	07/09		S 4146 NR		
power steering / servosterzo	D11B-430	316	430	06/08	>	07/09				S 3081 PO
FM 440	D13A/D13B-440	324	440	09/05	>	07/09		S 9320 NR	S 7345 A	S 3089 C
with activated carbons / ai carboni attivi	D13A/D13B-440	324	440	09/05	>	07/09				S 4260 CA
by-pass	D13A/D13B-440	324	440	09/05	>	07/09	S 4120 R			
with automatic gearbox / con cambio automatico	D13A/D13B-440	324	440	09/08	>	07/09				S 5238 PE
with filter AdBlue/SCR Denoxtronic 2.0 / con filtro AdBlue/SCR Denoxtronic 2.0	D13A/D13B-440	324	440	09/05	>	07/09				S 4402 U
water filter / filtro acqua	D13A/D13B-440	324	440	09/05	>	07/09				S 9006 AR

V



KW HP



...VOLVO - trucks/autocarri



inner / interno	D13A/D13B-440	324	440	09/05 >	07/09			S 7576 A	
LONG LIFE	D13A/D13B-440	324	440	09/05 >	07/09				
2 filters / N.2 filtri	D13A/D13B-440	324	440	09/05 >	07/09	S 4402 R	S 4120 NR		
prefilter short filter / prefiltra filtro corto	D13A/D13B-440	324	440	09/05 >	08/08		S 4461 NR		
prefilter short filter / prefiltra filtro corto	D13A/D13B-440	324	440	09/08 >	07/09		S 4157 NR		
prefilter long filter / prefiltra filtro lungo	D13A/D13B-440	324	440	09/05 >	07/09		S 4146 NR		
power steering / servosterzo	D13A/D13B-440	324	440	09/05 >	07/09				S 3081 PO
FM 450	D11K-450 Euro6	331	450	07/13 >					S 9006 AR
by-pass	D11K-450 Euro6	331	450	07/13 >		S 4120 R			
outer / esterno	D11K-450 Euro6	331	450	07/13 >				S 7B39 A	
2 filters / N.2 filtri	D11K-450 Euro6	331	450	07/13 >		S 4402 R			
power steering / servosterzo	D11K-450 Euro6	331	450	07/13 >					S 3081 PO
FM 460	D13C-460 E5/EEV	338	460	04/09 >			S 9320 NR	S 7345 A	S 3089 C
with activated carbons / ai carboni attivi	D13C-460 E5/EEV	338	460	04/09 >					S 4260 CA
by-pass	D13C-460 E5/EEV	338	460	04/09 >		S 4120 R			
with automatic gearbox / con cambio automatico	D13C-460 E5/EEV	338	460	04/09 >					S 5238 PE
with filter AdBlue/SCR Denoxtronic 2.0 / con filtro AdBlue/SCR Denoxtronic 2.0	D13C-460 E5/EEV	338	460	04/09 >					S 4402 U
water filter / filtro acqua	D13C-460 E5/EEV	338	460	04/09 >					S 9006 AR
inner / interno	D13C-460 E5/EEV	338	460	04/09 >				S 7576 A	
LONG LIFE	D13C-460 E5/EEV	338	460	04/09 >			S 4120 NR		
2 filters / N.2 filtri	D13C-460 E5/EEV	338	460	04/09 >		S 4402 R			
prefilter short filter / prefiltra filtro corto	D13C-460 E5/EEV	338	460	04/09 >			S 4157 NR		
prefilter long filter / prefiltra filtro lungo	D13C-460 E5/EEV	338	460	04/09 >			S 4146 NR		
power steering / servosterzo	D13C-460 E5/EEV	338	460	04/09 >					S 3081 PO
FM 460	D13K-460 Euro6	338	460	07/13 >					S 9006 AR
by-pass	D13K-460 Euro6	338	460	07/13 >		S 4120 R			
outer / esterno	D13K-460 Euro6	338	460	07/13 >				S 7B39 A	
2 filters / N.2 filtri	D13K-460 Euro6	338	460	07/13 >		S 4402 R			
power steering / servosterzo	D13K-460 Euro6	338	460	07/13 >					S 3081 PO
FM 480	D13A/D13B-480	353	480	09/05 >	07/09		S 9320 NR	S 7345 A	S 3089 C
with activated carbons / ai carboni attivi	D13A/D13B-480	353	480	09/05 >	07/09				S 4260 CA
by-pass	D13A/D13B-480	353	480	09/05 >	07/09	S 4120 R			
with automatic gearbox / con cambio automatico	D13A/D13B-480	353	480	09/05 >	07/09				S 5238 PE
with filter AdBlue/SCR Denoxtronic 2.0 / con filtro AdBlue/SCR Denoxtronic 2.0	D13A/D13B-480	353	480	09/05 >	07/09				S 4402 U
water filter / filtro acqua	D13A/D13B-480	353	480	09/05 >	07/09				S 9006 AR
inner / interno	D13A/D13B-480	353	480	09/05 >	07/09			S 7576 A	
LONG LIFE	D13A/D13B-480	353	480	09/05 >	07/09		S 4120 NR		
2 filters / N.2 filtri	D13A/D13B-480	353	480	09/05 >	07/09	S 4402 R			
prefilter short filter / prefiltra filtro corto	D13A/D13B-480	353	480	09/05 >	08/08		S 4461 NR		
prefilter short filter / prefiltra filtro corto	D13A/D13B-480	353	480	09/08 >	07/09		S 4157 NR		
prefilter long filter / prefiltra filtro lungo	D13A/D13B-480	353	480	09/05 >	07/09		S 4146 NR		
power steering / servosterzo	D13A/D13B-480	353	480	09/05 >	07/09				S 3081 PO
FM 500	D13B-500	368	500	05/07 >	08/08		S 9320 NR	S 7345 A	S 3089 C
with activated carbons / ai carboni attivi	D13B-500	368	500	05/07 >	08/08				S 4260 CA
by-pass	D13B-500	368	500	05/07 >	08/08	S 4120 R			
with automatic gearbox / con cambio automatico	D13B-500	368	500	05/07 >	08/08				S 5238 PE
with filter AdBlue/SCR Denoxtronic 2.0 / con filtro AdBlue/SCR Denoxtronic 2.0	D13B-500	368	500	05/07 >	08/08				S 4402 U
water filter / filtro acqua	D13B-500	368	500	05/07 >	08/08				S 9006 AR
inner / interno	D13B-500	368	500	05/07 >	08/08			S 7576 A	
LONG LIFE	D13B-500	368	500	05/07 >	08/08		S 4120 NR		
2 filters / N.2 filtri	D13B-500	368	500	05/07 >	08/08	S 4402 R			
prefilter short filter / prefiltra filtro corto	D13B-500	368	500	05/07 >	08/08		S 4461 NR		
prefilter long filter / prefiltra filtro lungo	D13B-500	368	500	05/07 >	08/08		S 4146 NR		
power steering / servosterzo	D13B-500	368	500	05/07 >	08/08				S 3081 PO
FM 500	D13C-500 E5/EEV	368	500	04/09 >			S 9320 NR	S 7345 A	S 3089 C
with activated carbons / ai carboni attivi	D13C-500 E5/EEV	368	500	04/09 >					S 4260 CA
by-pass	D13C-500 E5/EEV	368	500	04/09 >		S 4120 R			
with filter AdBlue/SCR Denoxtronic 2.0 / con filtro AdBlue/SCR Denoxtronic 2.0	D13C-500 E5/EEV	368	500	04/09 >					S 4402 U
water filter / filtro acqua	D13C-500 E5/EEV	368	500	04/09 >					S 9006 AR
inner / interno	D13C-500 E5/EEV	368	500	04/09 >				S 7576 A	
LONG LIFE	D13C-500 E5/EEV	368	500	04/09 >			S 4120 NR		
2 filters / N.2 filtri	D13C-500 E5/EEV	368	500	04/09 >		S 4402 R			
prefilter short filter / prefiltra filtro corto	D13C-500 E5/EEV	368	500	04/09 >			S 4157 NR		
prefilter long filter / prefiltra filtro lungo	D13C-500 E5/EEV	368	500	04/09 >			S 4146 NR		
power steering / servosterzo	D13C-500 E5/EEV	368	500	04/09 >					S 3081 PO
FM 500	D13K-500 Euro6	368	500	07/13 >					S 9006 AR
by-pass	D13K-500 Euro6	368	500	07/13 >		S 4120 R			

**kW HP****...VOLVO - trucks/autocarri**

outer / esterno	D13K-500 Euro6	368	500	07/13	>			S 7B39 A	
2 filters / N.2 filtri	D13K-500 Euro6	368	500	07/13	>	S 4402 R			
power steering / servosterzo	D13K-500 Euro6	368	500	07/13	>				S 3081 PO
FM 540	D13K-540 Euro6	368	540	07/13	>				S 9006 AR
by-pass	D13K-540 Euro6	368	540	07/13	>	S 4120 R			
outer / esterno	D13K-540 Euro6	368	540	07/13	>			S 7B39 A	
2 filters / N.2 filtri	D13K-540 Euro6	368	540	07/13	>	S 4402 R			
power steering / servosterzo	D13K-540 Euro6	368	540	07/13	>				S 3081 PO
FM10 Serie									
FM10-320	D10C	235	320	08/98	>			S 5020 NR	S 7347 A
with activated carbons / ai carboni attivi	D10C	235	320	08/98	>				S 3089 C
by-pass	D10C	235	320	08/98	>	S 4120 R			S 4260 CA
inner / interno	D10C	235	320	08/98	>			S 7484 A	
LONG LIFE 2 filters / LONG LIFE N.2 filtri	D10C	235	320	08/98	>	S 4402 R			
2 filters / N.2 filtri	D10C	235	320	08/98	>	S 0900 R			
power steering / servosterzo	D10C	235	320	08/98	>				S 3081 PO
FM10-360	D10C	265	360	08/98	>			S 5020 NR	S 7347 A
with activated carbons / ai carboni attivi	D10C	265	360	08/98	>				S 3089 C
by-pass	D10C	265	360	08/98	>	S 4120 R			S 4260 CA
inner / interno	D10C	265	360	08/98	>			S 7484 A	
LONG LIFE 2 filters / LONG LIFE N.2 filtri	D10C	265	360	08/98	>	S 4402 R			
2 filters / N.2 filtri	D10C	265	360	08/98	>	S 0900 R			
power steering / servosterzo	D10C	265	360	08/98	>				S 3081 PO
FM12 Serie									
FM12-340	D12C340	250	340	08/98	> 01/02			S 5020 NR	S 7345 A
by-pass	D12C340	250	340	08/98	> 01/02	S 4120 R			✗
with oil radiator for gearbox / con radiatore dell'olio per il cambio	D12C340	250	340	08/98	> 01/02				S 3257 R
water filter / filtro acqua	D12C340	250	340	08/98	> 01/02				S 9006 AR
inner / interno	D12C340	250	340	08/98	> 01/02			S 7576 A	
2 filters / N.2 filtri	D12C340	250	340	08/98	> 01/02	S 0900 R			
2 filters LONG LIFE / N.2 filtri LONG LIFE	D12C340	250	340	08/98	> 01/02	S 4402 R			
power steering / servosterzo	D12C340	250	340	08/98	> 01/02				S 3081 PO
FM12-340	D12D340	250	340	11/01	> 09/05			S 9320 NR	S 7347 A
with activated carbons / ai carboni attivi	D12D340	250	340	11/01	> 09/05				S 3089 C
by-pass	D12D340	250	340	11/01	> 09/05	S 4120 R			S 4260 CA
water filter / filtro acqua	D12D340	250	340	11/01	> 09/05				S 9006 AR
inner / interno	D12D340	250	340	11/01	> 09/05			S 7484 A	
LONG LIFE	D12D340	250	340	11/01	> 09/05			S 4120 NR	
2 filters / N.2 filtri	D12D340	250	340	11/01	> 09/05	S 0900 R			
2 filters LONG LIFE / N.2 filtri LONG LIFE	D12D340	250	340	11/01	> 09/05	S 4402 R			
prefilter long filter / prefilto filtro lungo	D12D340	250	340	11/01	> 09/05			S 4138 NR	
FM12-380	D12C380	279	380	08/98	> 01/02			S 5020 NR	S 7345 A
by-pass	D12C380	279	380	08/98	> 01/02	S 4120 R			✗
with oil radiator for gearbox / con radiatore dell'olio per il cambio	D12C380	279	380	08/98	> 01/02				S 3257 R
water filter / filtro acqua	D12C380	279	380	08/98	> 01/02				S 9006 AR
inner / interno	D12C380	279	380	08/98	> 01/02			S 7576 A	
2 filters / N.2 filtri	D12C380	279	380	08/98	> 01/02	S 0900 R			
2 filters LONG LIFE / N.2 filtri LONG LIFE	D12C380	279	380	08/98	> 01/02	S 4402 R			
power steering / servosterzo	D12C380	279	380	08/98	> 01/02				S 3081 PO
FM12-380	D12D380	279	380	11/01	> 09/05			S 9320 NR	S 7347 A
with activated carbons / ai carboni attivi	D12D380	279	380	11/01	> 09/05				S 3089 C
by-pass	D12D380	279	380	11/01	> 09/05	S 4120 R			S 4260 CA
water filter / filtro acqua	D12D380	279	380	11/01	> 09/05				S 9006 AR
inner / interno	D12D380	279	380	11/01	> 09/05			S 7484 A	
LONG LIFE	D12D380	279	380	11/01	> 09/05			S 4120 NR	
2 filters / N.2 filtri	D12D380	279	380	11/01	> 09/05	S 0900 R			
2 filters LONG LIFE / N.2 filtri LONG LIFE	D12D380	279	380	11/01	> 09/05	S 4402 R			
prefilter long filter / prefilto filtro lungo	D12D380	279	380	11/01	> 09/05			S 4138 NR	
FM12-420	D12C420	309	420	08/98	> 01/02			S 5020 NR	S 7345 A
by-pass	D12C420	309	420	08/98	> 01/02	S 4120 R			✗
with oil radiator for gearbox / con radiatore dell'olio per il cambio	D12C420	309	420	08/98	> 01/02				S 3257 R
water filter / filtro acqua	D12C420	309	420	08/98	> 01/02				S 9006 AR
inner / interno	D12C420	309	420	08/98	> 01/02			S 7576 A	
2 filters / N.2 filtri	D12C420	309	420	08/98	> 01/02	S 0900 R			
2 filters LONG LIFE / N.2 filtri LONG LIFE	D12C420	309	420	08/98	> 01/02	S 4402 R			
power steering / servosterzo	D12C420	309	420	08/98	> 01/02				S 3081 PO
FM12-420	D12D420	309	420	11/01	> 09/05			S 9320 NR	S 7347 A
									S 3089 C

V



...VOLVO - trucks/autocarri

V

with activated carbons / ai carboni attivi	D12D420	309 420	11/01 > 09/05				S 4260 CA
by-pass	D12D420	309 420	11/01 > 09/05	S 4120 R			
water filter / filtro acqua	D12D420	309 420	11/01 > 09/05				S 9006 AR
inner / interno	D12D420	309 420	11/01 > 09/05			S 7484 A	
LONG LIFE	D12D420	309 420	11/01 > 09/05		S 4120 NR		
2 filters / N.2 filtri	D12D420	309 420	11/01 > 09/05	S 0900 R			
2 filters LONG LIFE / N.2 filtri LONG LIFE	D12D420	309 420	11/01 > 09/05	S 4402 R			
prefilter long filter / prefiltra filtro lungo	D12D420	309 420	11/01 > 09/05		S 4138 NR		
FM12-460	D12D460	338 460	05/03 > 09/05		S 9320 NR	S 7347 A	S 3089 C
with activated carbons / ai carboni attivi	D12D460	338 460	05/03 > 09/05				S 4260 CA
by-pass	D12D460	338 460	05/03 > 09/05	S 4120 R			
water filter / filtro acqua	D12D460	338 460	05/03 > 09/05				S 9006 AR
inner / interno	D12D460	338 460	05/03 > 09/05			S 7484 A	
LONG LIFE	D12D460	338 460	05/03 > 09/05		S 4120 NR		
2 filters / N.2 filtri	D12D460	338 460	05/03 > 09/05	S 0900 R			
2 filters LONG LIFE / N.2 filtri LONG LIFE	D12D460	338 460	05/03 > 09/05	S 4402 R			
prefilter long filter / prefiltra filtro lungo	D12D460	338 460	05/03 > 09/05		S 4138 NR		
FM7 Serie							
FM7-230	D7A	169 230	01/99 > 02/02	S 0900 R	S 5020 NR		S 3089 C
with activated carbons / ai carboni attivi	D7A	169 230	01/99 > 02/02				S 4260 CA
some / alcuni	D7A	169 230	01/99 > 02/02	S 0900 R	S 5020 NR	S 7347 A	S 3089 C
by-pass	D7A	169 230	01/99 > 02/02	S 4120 R			
water filter / filtro acqua	D7A	169 230	01/99 > 02/02				S 9006 AR
LONG LIFE	D7A	169 230	01/99 > 02/02	S 4402 R			
power steering / servosterzo	D7A	169 230	01/99 > 02/02				S 3081 PO
FM7-250	D7C	183 250	08/98 > 02/02	S 0900 R	S 5020 NR		S 3089 C
with activated carbons / ai carboni attivi	D7C	183 250	08/98 > 02/02				S 4260 CA
some / alcuni	D7C	183 250	08/98 > 02/02	S 0900 R	S 5020 NR	S 7347 A	S 3089 C
by-pass	D7C	183 250	08/98 > 02/02	S 4120 R			
water filter / filtro acqua	D7C	183 250	08/98 > 02/02				S 9006 AR
LONG LIFE	D7C	183 250	08/98 > 02/02	S 4402 R			
power steering / servosterzo	D7C	183 250	08/98 > 02/02				S 3081 PO
FM7-260	D7A	191 260	01/99 > 02/02	S 0900 R	S 5020 NR		S 3089 C
with activated carbons / ai carboni attivi	D7A	191 260	01/99 > 02/02				S 4260 CA
some / alcuni	D7A	191 260	01/99 > 02/02	S 0900 R	S 5020 NR	S 7347 A	S 3089 C
by-pass	D7A	191 260	01/99 > 02/02	S 4120 R			
water filter / filtro acqua	D7A	191 260	01/99 > 02/02				S 9006 AR
LONG LIFE	D7A	191 260	01/99 > 02/02	S 4402 R			
power steering / servosterzo	D7A	191 260	01/99 > 02/02				S 3081 PO
FM7-290	D7C	213 290	08/98 > 02/02	S 0900 R	S 5020 NR		S 3089 C
with activated carbons / ai carboni attivi	D7C	213 290	08/98 > 02/02				S 4260 CA
some / alcuni	D7C	213 290	08/98 > 02/02	S 0900 R	S 5020 NR	S 7347 A	S 3089 C
by-pass	D7C	213 290	08/98 > 02/02	S 4120 R			
water filter / filtro acqua	D7C	213 290	08/98 > 02/02				S 9006 AR
LONG LIFE	D7C	213 290	08/98 > 02/02	S 4402 R			
power steering / servosterzo	D7C	213 290	08/98 > 02/02				S 3081 PO
FM9 Serie							
FM9-260	D9A260	191 260	11/01 > 10/05	S 0900 R	S 9320 NR		S 3089 C
with activated carbons / ai carboni attivi	D9A260	191 260	11/01 > 10/05				S 4260 CA
by-pass	D9A260	191 260	11/01 > 10/05	S 4120 R			
LONG LIFE	D9A260	191 260	11/01 > 10/05	S 4402 R			
prefilter long filter / prefiltra filtro lungo	D9A260	191 260	11/01 > 10/05		S 4138 NR		
FM9-300	D9A300	220 300	11/01 > 10/05	S 0900 R	S 9320 NR		S 3089 C
with activated carbons / ai carboni attivi	D9A300	220 300	11/01 > 10/05				S 4260 CA
by-pass	D9A300	220 300	11/01 > 10/05	S 4120 R			
LONG LIFE	D9A300	220 300	11/01 > 10/05	S 4402 R			
prefilter long filter / prefiltra filtro lungo	D9A300	220 300	11/01 > 10/05		S 4138 NR		
FM9-340	D9A340	250 340	11/01 > 10/05	S 0900 R	S 9320 NR		S 3089 C
with activated carbons / ai carboni attivi	D9A340	250 340	11/01 > 10/05				S 4260 CA
by-pass	D9A340	250 340	11/01 > 10/05	S 4120 R			
LONG LIFE	D9A340	250 340	11/01 > 10/05	S 4402 R			
prefilter long filter / prefiltra filtro lungo	D9A340	250 340	11/01 > 10/05		S 4138 NR		
FM9-380	D9A380	279 380	11/01 > 10/05	S 0900 R	S 9320 NR		S 3089 C
with activated carbons / ai carboni attivi	D9A380	279 380	11/01 > 10/05				S 4260 CA
by-pass	D9A380	279 380	11/01 > 10/05	S 4120 R			
LONG LIFE	D9A380	279 380	11/01 > 10/05	S 4402 R			
prefilter long filter / prefiltra filtro lungo	D9A380	279 380	11/01 > 10/05		S 4138 NR		

**KW HP**

...VOLVO - trucks/autocarri

FMX Serie									
FMX 330	D11C-330 E5/EEV	243	330	04/09	>		S 9320 NR	S 7347 A	S 3089 C
with activated carbons / ai carboni attivi	D11C-330 E5/EEV	243	330	04/09	>				S 4260 CA
by-pass	D11C-330 E5/EEV	243	330	04/09	>	S 4120 R			
with filter AdBlue/SCR Denoxtronic 2.0 / con filtro AdBlue/SCR Denoxtronic 2.0	D11C-330 E5/EEV	243	330	04/09	>				S 4402 U
water filter / filtro acqua	D11C-330 E5/EEV	243	330	04/09	>				S 9006 AR
inner / interno	D11C-330 E5/EEV	243	330	04/09	>			S 7484 A	
LONG LIFE	D11C-330 E5/EEV	243	330	04/09	>		S 4120 NR		
2 filters / N.2 filtri	D11C-330 E5/EEV	243	330	04/09	>	S 4402 R			
prefilter short filter / prefiltra filtro corto	D11C-330 E5/EEV	243	330	04/09	>		S 4157 NR		
prefilter long filter / prefiltra filtro lungo	D11C-330 E5/EEV	243	330	04/09	>		S 4146 NR		
power steering / servosterzo	D11C-330 E5/EEV	243	330	04/09	>				S 3081 PO
FMX 330	D11K-330 Euro6	243	330	07/13	>				S 9006 AR
by-pass	D11K-330 Euro6	243	330	07/13	>	S 4120 R			
dryer filter KNORR EAC1/EAC2 / filtro essiccatore KNORR EAC1/EAC2	D11K-330 Euro6	243	330	07/13	>				S 7F23 A
DONALDSON assembly outer / montaggio DONALDSON esterno	D11K-330 Euro6	243	330	07/13	>			S 7B39 A	
2 filters / N.2 filtri	D11K-330 Euro6	243	330	07/13	>	S 4402 R			
prefilter RACOR / prefiltra RACOR	D11K-330 Euro6	243	330	07/13	>		S 4477 NR		
power steering / servosterzo	D11K-330 Euro6	243	330	07/13	>				S 3081 PO
FMX 370	D11C-370 E5/EEV	272	370	04/09	>		S 9320 NR	S 7347 A	S 3089 C
with activated carbons / ai carboni attivi	D11C-370 E5/EEV	272	370	04/09	>				S 4260 CA
by-pass	D11C-370 E5/EEV	272	370	04/09	>	S 4120 R			
with filter AdBlue/SCR Denoxtronic 2.0 / con filtro AdBlue/SCR Denoxtronic 2.0	D11C-370 E5/EEV	272	370	04/09	>				S 4402 U
water filter / filtro acqua	D11C-370 E5/EEV	272	370	04/09	>				S 9006 AR
inner / interno	D11C-370 E5/EEV	272	370	04/09	>			S 7484 A	
LONG LIFE	D11C-370 E5/EEV	272	370	04/09	>		S 4120 NR		
2 filters / N.2 filtri	D11C-370 E5/EEV	272	370	04/09	>	S 4402 R			
prefilter short filter / prefiltra filtro corto	D11C-370 E5/EEV	272	370	04/09	>		S 4157 NR		
prefilter long filter / prefiltra filtro lungo	D11C-370 E5/EEV	272	370	04/09	>		S 4146 NR		
power steering / servosterzo	D11C-370 E5/EEV	272	370	04/09	>				S 3081 PO
FMX 370	D11K-370 Euro6	272	370	07/13	>				S 9006 AR
by-pass	D11K-370 Euro6	272	370	07/13	>	S 4120 R			
DONALDSON assembly outer / montaggio DONALDSON esterno	D11K-370 Euro6	272	370	07/13	>			S 7B39 A	
2 filters / N.2 filtri	D11K-370 Euro6	272	370	07/13	>	S 4402 R			
prefilter RACOR / prefiltra RACOR	D11K-370 Euro6	272	370	07/13	>		S 4477 NR		
power steering / servosterzo	D11K-370 Euro6	272	370	07/13	>				S 3081 PO
FMX 380	D13C-380 E5/EEV	280	380	04/09	>		S 9320 NR	S 7345 A	S 3089 C
with activated carbons / ai carboni attivi	D13C-380 E5/EEV	280	380	04/09	>				S 4260 CA
by-pass	D13C-380 E5/EEV	280	380	04/09	>	S 4120 R			
with filter AdBlue/SCR Denoxtronic 2.0 / con filtro AdBlue/SCR Denoxtronic 2.0	D13C-380 E5/EEV	280	380	04/09	>				S 4402 U
water filter / filtro acqua	D13C-380 E5/EEV	280	380	04/09	>				S 9006 AR
inner / interno	D13C-380 E5/EEV	280	380	04/09	>			S 7576 A	
LONG LIFE	D13C-380 E5/EEV	280	380	04/09	>		S 4120 NR		
2 filters / N.2 filtri	D13C-380 E5/EEV	280	380	04/09	>	S 4402 R			
prefilter short filter / prefiltra filtro corto	D13C-380 E5/EEV	280	380	04/09	>		S 4157 NR		
prefilter long filter / prefiltra filtro lungo	D13C-380 E5/EEV	280	380	04/09	>		S 4146 NR		
power steering / servosterzo	D13C-380 E5/EEV	280	380	04/09	>				S 3081 PO
FMX 410	D11C-410 E5/EEV	302	410	04/09	>		S 9320 NR	S 7347 A	S 3089 C
with activated carbons / ai carboni attivi	D11C-410 E5/EEV	302	410	04/09	>				S 4260 CA
by-pass	D11C-410 E5/EEV	302	410	04/09	>	S 4120 R			
with filter AdBlue/SCR Denoxtronic 2.0 / con filtro AdBlue/SCR Denoxtronic 2.0	D11C-410 E5/EEV	302	410	04/09	>				S 4402 U
water filter / filtro acqua	D11C-410 E5/EEV	302	410	04/09	>				S 9006 AR
inner / interno	D11C-410 E5/EEV	302	410	04/09	>			S 7484 A	
LONG LIFE	D11C-410 E5/EEV	302	410	04/09	>		S 4120 NR		
2 filters / N.2 filtri	D11C-410 E5/EEV	302	410	04/09	>	S 4402 R			
prefilter short filter / prefiltra filtro corto	D11C-410 E5/EEV	302	410	04/09	>		S 4157 NR		
prefilter long filter / prefiltra filtro lungo	D11C-410 E5/EEV	302	410	04/09	>		S 4146 NR		
power steering / servosterzo	D11C-410 E5/EEV	302	410	04/09	>				S 3081 PO
FMX 410	D11K-410 Euro6	302	410	07/13	>				S 9006 AR
by-pass	D11K-410 Euro6	302	410	07/13	>	S 4120 R			
DONALDSON assembly outer / montaggio DONALDSON esterno	D11K-410 Euro6	302	410	07/13	>			S 7B39 A	
2 filters / N.2 filtri	D11K-410 Euro6	302	410	07/13	>	S 4402 R			
prefilter RACOR / prefiltra RACOR	D11K-410 Euro6	302	410	07/13	>		S 4477 NR		
power steering / servosterzo	D11K-410 Euro6	302	410	07/13	>				S 3081 PO
FMX 420	D13C-420 E5/EEV	309	420	04/09	>		S 9320 NR	S 7345 A	S 3089 C
with activated carbons / ai carboni attivi	D13C-420 E5/EEV	309	420	04/09	>				S 4260 CA
by-pass	D13C-420 E5/EEV	309	420	04/09	>	S 4120 R			

V



...VOLVO - trucks/autocarri



with filter AdBlue/SCR Denoxtronic 2.0 / con filtro AdBlue/SCR Denoxtronic 2.0	D13C-420 E5/EEV	309	420	04/09	>				S 4402 U
water filter / filtro acqua	D13C-420 E5/EEV	309	420	04/09	>				S 9006 AR
inner / interno	D13C-420 E5/EEV	309	420	04/09	>				
LONG LIFE	D13C-420 E5/EEV	309	420	04/09	>			S 4120 NR	S 7576 A
2 filters / N.2 filtri	D13C-420 E5/EEV	309	420	04/09	>	S 4402 R			
prefilter short filter / prefiltra filtro corto	D13C-420 E5/EEV	309	420	04/09	>		S 4157 NR		
prefilter long filter / prefiltra filtro lungo	D13C-420 E5/EEV	309	420	04/09	>		S 4146 NR		
power steering / servosterzo	D13C-420 E5/EEV	309	420	04/09	>				S 3081 PO
FMX 420	D13K-420 Euro6	309	420	07/13	>				S 9006 AR
by-pass	D13K-420 Euro6	309	420	07/13	>	S 4120 R			
DONALDSON assembly outer / montaggio DONALDSON esterno	D13K-420 Euro6	309	420	07/13	>			S 7B39 A	
2 filters / N.2 filtri	D13K-420 Euro6	309	420	07/13	>	S 4402 R			
prefilter RACOR / prefiltra RACOR	D13K-420 Euro6	309	420	07/13	>		S 4477 NR		
power steering / servosterzo	D13K-420 Euro6	309	420	07/13	>				S 3081 PO
FMX 450	D11C-450 E5/EEV	331	450	04/09	>		S 9320 NR	S 7347 A	S 3089 C
with activated carbons / ai carboni attivi	D11C-450 E5/EEV	331	450	04/09	>				S 4260 CA
by-pass	D11C-450 E5/EEV	331	450	04/09	>	S 4120 R			
with filter AdBlue/SCR Denoxtronic 2.0 / con filtro AdBlue/SCR Denoxtronic 2.0	D11C-450 E5/EEV	331	450	04/09	>				S 4402 U
water filter / filtro acqua	D11C-450 E5/EEV	331	450	04/09	>				S 9006 AR
inner / interno	D11C-450 E5/EEV	331	450	04/09	>			S 7484 A	
LONG LIFE	D11C-450 E5/EEV	331	450	04/09	>		S 4120 NR		
2 filters / N.2 filtri	D11C-450 E5/EEV	331	450	04/09	>	S 4402 R			
prefilter short filter / prefiltra filtro corto	D11C-450 E5/EEV	331	450	04/09	>		S 4157 NR		
prefilter long filter / prefiltra filtro lungo	D11C-450 E5/EEV	331	450	04/09	>		S 4146 NR		
power steering / servosterzo	D11C-450 E5/EEV	331	450	04/09	>				S 3081 PO
FMX 450	D11K-450 Euro6	331	450	07/13	>				S 9006 AR
by-pass	D11K-450 Euro6	331	450	07/13	>	S 4120 R			
DONALDSON assembly outer / montaggio DONALDSON esterno	D11K-450 Euro6	331	450	07/13	>			S 7B39 A	
2 filters / N.2 filtri	D11K-450 Euro6	331	450	07/13	>	S 4402 R			
prefilter RACOR / prefiltra RACOR	D11K-450 Euro6	331	450	07/13	>		S 4477 NR		
power steering / servosterzo	D11K-450 Euro6	331	450	07/13	>				S 3081 PO
FMX 460	D13C-460 E5/EEV	338	460	04/09	>		S 9320 NR	S 7345 A	S 3089 C
with activated carbons / ai carboni attivi	D13C-460 E5/EEV	338	460	04/09	>				S 4260 CA
by-pass	D13C-460 E5/EEV	338	460	04/09	>	S 4120 R			
with filter AdBlue/SCR Denoxtronic 2.0 / con filtro AdBlue/SCR Denoxtronic 2.0	D13C-460 E5/EEV	338	460	04/09	>				S 4402 U
water filter / filtro acqua	D13C-460 E5/EEV	338	460	04/09	>				S 9006 AR
inner / interno	D13C-460 E5/EEV	338	460	04/09	>			S 7576 A	
LONG LIFE	D13C-460 E5/EEV	338	460	04/09	>		S 4120 NR		
2 filters / N.2 filtri	D13C-460 E5/EEV	338	460	04/09	>	S 4402 R			
prefilter short filter / prefiltra filtro corto	D13C-460 E5/EEV	338	460	04/09	>		S 4157 NR		
prefilter long filter / prefiltra filtro lungo	D13C-460 E5/EEV	338	460	04/09	>		S 4146 NR		
power steering / servosterzo	D13C-460 E5/EEV	338	460	04/09	>				S 3081 PO
FMX 460	D13K-460 Euro6	338	460	07/13	>				S 9006 AR
by-pass	D13K-460 Euro6	338	460	07/13	>	S 4120 R			
DONALDSON assembly outer / montaggio DONALDSON esterno	D13K-460 Euro6	338	460	07/13	>			S 7B39 A	
2 filters / N.2 filtri	D13K-460 Euro6	338	460	07/13	>	S 4402 R			
prefilter RACOR / prefiltra RACOR	D13K-460 Euro6	338	460	07/13	>		S 4477 NR		
power steering / servosterzo	D13K-460 Euro6	338	460	07/13	>				S 3081 PO
FMX 500	D13C-500 E5/EEV	368	500	04/09	>		S 9320 NR	S 7345 A	S 3089 C
with activated carbons / ai carboni attivi	D13C-500 E5/EEV	368	500	04/09	>				S 4260 CA
by-pass	D13C-500 E5/EEV	368	500	04/09	>	S 4120 R			
with filter AdBlue/SCR Denoxtronic 2.0 / con filtro AdBlue/SCR Denoxtronic 2.0	D13C-500 E5/EEV	368	500	04/09	>				S 4402 U
water filter / filtro acqua	D13C-500 E5/EEV	368	500	04/09	>				S 9006 AR
inner / interno	D13C-500 E5/EEV	368	500	04/09	>			S 7576 A	
LONG LIFE	D13C-500 E5/EEV	368	500	04/09	>		S 4120 NR		
2 filters / N.2 filtri	D13C-500 E5/EEV	368	500	04/09	>	S 4402 R			
prefilter short filter / prefiltra filtro corto	D13C-500 E5/EEV	368	500	04/09	>		S 4157 NR		
prefilter long filter / prefiltra filtro lungo	D13C-500 E5/EEV	368	500	04/09	>		S 4146 NR		
power steering / servosterzo	D13C-500 E5/EEV	368	500	04/09	>				S 3081 PO
FMX 500	D13K-500 Euro6	368	500	07/13	>				S 9006 AR
by-pass	D13K-500 Euro6	368	500	07/13	>	S 4120 R			
dryer filter KNORR EAC1/EAC2 / filtro essiccatore KNORR EAC1/EAC2	D13K-500 Euro6	368	500	07/13	>			S 7B39 A	S 7F23 A
DONALDSON assembly outer / montaggio DONALDSON esterno	D13K-500 Euro6	368	500	07/13	>				
2 filters / N.2 filtri	D13K-500 Euro6	368	500	07/13	>	S 4402 R			
prefilter RACOR / prefiltra RACOR	D13K-500 Euro6	368	500	07/13	>		S 4477 NR		
power steering / servosterzo	D13K-500 Euro6	368	500	07/13	>				S 3081 PO
FMX 540	D13K-540 Euro6	397	540	07/13	>				S 9006 AR



kW HP



...VOLVO - trucks/autocarri

by-pass	D13K-540 Euro6	397	540	07/13	>	S 4120 R			
DONALDSON assembly outer / montaggio DONALDSON esterno	D13K-540 Euro6	397	540	07/13	>			S 7B39 A	
2 filters / N.2 filtri	D13K-540 Euro6	397	540	07/13	>	S 4402 R			
prefilter RACOR / prefiltrato RACOR	D13K-540 Euro6	397	540	07/13	>		S 4477 NR		
power steering / servosterzo	D13K-540 Euro6	397	540	07/13	>				S 3081 PO
FS10 Serie									
FS10	TD101F/TD102F/TD103ES			01/87	>	12/89	S 0900 R	S 4323 NR	S 3051 A
to frame No. 324580 / a telaio N. 324580	TD101F/TD102F/TD103ES			01/87	>	12/89		S 7578 A	
with oil radiator for gearbox (R/SR 1400/1700) / con radiatore dell'olio per il cambio (R/SR 1400/1700)	TD101F/TD102F/TD103ES			01/87	>	12/89			S 3257 R
inner to frame No. 324580 / interno a telaio N. 324580	TD101F/TD102F/TD103ES			01/87	>	12/89		S 7549 A	
power steering (Ø 60) / servosterzo (Ø 60)	TD101F/TD102F/TD103ES			01/87	>	12/89			S 3081 PO
power steering (Ø 80) / servosterzo (Ø 80)	TD101F/TD102F/TD103ES			01/87	>	12/89			S 8790 PO
bleed / sfiato	TD101F/TD102F/TD103ES			01/87	>	12/89			S 7091 A
bleed / sfiato	TD101F/TD102F/TD103ES			01/87	>	12/89			S 7092 A
FS7 Serie									
FS7	TD73E			11/91	>	10/94	S 0900 R	S 4323 NR	
by-pass	TD73E			11/91	>	10/94	S 4120 R		
power steering / servosterzo	TD73E			11/91	>	10/94			S 3081 PO
bleed / sfiato	TD73E			11/91	>	10/94			S 7091 A
FS718-230	D7B	169	230	09/94	>	03/96	S 0900 R	S 4323 NR	
by-pass	D7B	169	230	09/94	>	03/96	S 4120 R		
power steering / servosterzo	D7B	169	230	09/94	>	03/96			S 3081 PO
bleed / sfiato	D7B	169	230	09/94	>	03/96			S 7091 A
FS718-260	D7B	191	260	09/94	>	03/96	S 0900 R	S 4323 NR	
by-pass	D7B	191	260	09/94	>	03/96	S 4120 R		
power steering / servosterzo	D7B	191	260	09/94	>	03/96			S 3081 PO
bleed / sfiato	D7B	191	260	09/94	>	03/96			S 7091 A
G80 Serie									
G88							S 5800 R	S 1411 N	
to engine No. 19896 / a motore N. 19896							S 5800 R		S 6450 A
to frame No. 30000 / a telaio N. 30000							S 5800 R	S 4323 NR	
from engine No. 19897 / da motore N. 19897							S 5800 R		S 8450 A
from frame No. 30001 / da telaio N. 30001									S 8790 PO
power steering (Ø 80) / servosterzo (Ø 80)									S 8790 PO
G89							S 5800 R	S 4323 NR	S 8450 A
power steering (Ø 80) / servosterzo (Ø 80)									S 8790 PO
L Serie									
L385								S 0201 N	
L389 Viking								S 0201 N	
LV Serie									
LV125								S 0201 N	
some / alcuni								S 1411 N	
LV128								S 0201 N	
some / alcuni								S 1411 N	
LV245								S 0201 N	
some / alcuni								S 1411 N	
LV292								S 0201 N	
some / alcuni								S 1411 N	
LV370								S 8381 NC	
some / alcuni								S 7411 N	
LV375								S 8381 NC	
some / alcuni								S 7411 N	
N10 Serie									
N10									
to engine No. 132654 / a motore N. 132654	TD100A	202	275	09/73	>	04/85	S 5800 R	S 4323 NR	S 0070 A
with oil radiator for gearbox / con radiatore dell'olio per il cambio	TD100A	202	275	09/73	>	04/85			S 3257 R
from engine No. 132655 / da motore N. 132655	TD100A	202	275	>	04/85		S 0900 R	S 4323 NR	S 0070 A
inner from frame No. 306000 / interno da telaio N. 306000	TD100A	202	275	>	04/85				S 7A34 A
inner from frame No. 48279 / interno da telaio N. 48279	TD100A	202	275	>	04/85				S 7338 A
power steering (Ø 60) / servosterzo (Ø 60)	TD100A	202	275	09/73	>	04/85			S 3081 PO
power steering (Ø 80) / servosterzo (Ø 80)	TD100A	202	275	09/73	>	04/85			S 8790 PO
bleed / sfiato	TD100A	202	275	09/73	>	04/85			S 7091 A
N10									
to engine No. 132461 / a motore N. 132461	TD100B	221	301	09/73	>	04/85	S 5800 R	S 4323 NR	S 0070 A
with oil radiator for gearbox / con radiatore dell'olio per il cambio	TD100B	221	301	09/73	>	04/85			S 3257 R
from engine No. 132462 / da motore N. 132462	TD100B	221	301	09/73	>	04/85	S 0900 R	S 4323 NR	S 0070 A
inner from frame No. 306000 / interno da telaio N. 306000	TD100B	221	301	>	04/85				S 7A34 A

V





kW HP



...VOLVO - trucks/autocarri

inner from frame No. 48279 / interno da telaio N. 48279	TD100B	221 301	> 04/85			S 7338 A	
power steering (Ø 60) / servosterzo (Ø 60)	TD100B	221 301	09/73 > 04/85				S 3081 PO
power steering (Ø 80) / servosterzo (Ø 80)	TD100B	221 301	09/73 > 04/85				S 8790 PO
bleed / sfiato	TD100B	221 301	09/73 > 04/85				S 7091 A
N10	TD100G, TD101F/G		08/84 >	S 0900 R	S 4323 NR	S 0070 A	✗
with oil radiator for gearbox / con radiatore dell'olio per il cambio	TD100G, TD101F/G		08/84 >				S 3257 R
inner from frame No. 306000 / interno da telaio N. 306000	TD100G, TD101F/G					S 7A34 A	
inner from frame No. 48279 / interno da telaio N. 48279	TD100G, TD101F/G		08/84 >			S 7338 A	
power steering (Ø 60) / servosterzo (Ø 60)	TD100G, TD101F/G		08/84 >				S 3081 PO
power steering (Ø 80) / servosterzo (Ø 80)	TD100G, TD101F/G		08/84 >				S 8790 PO
bleed / sfiato	TD100G, TD101F/G		08/84 >				S 7091 A
N10	TD102F, TD102FL		08/84 >	S 0900 R	S 4323 NR	S 0070 A	✗
with oil radiator for gearbox / con radiatore dell'olio per il cambio	TD102F, TD102FL		08/84 >				S 3257 R
inner from frame No. 306000 / interno da telaio N. 306000	TD102F, TD102FL					S 7A34 A	
inner from frame No. 48279 / interno da telaio N. 48279	TD102F, TD102FL		08/84 >			S 7338 A	
power steering (Ø 60) / servosterzo (Ø 60)	TD102F, TD102FL		08/84 >				S 3081 PO
power steering (Ø 80) / servosterzo (Ø 80)	TD102F, TD102FL		08/84 >				S 8790 PO
bleed / sfiato	TD102F, TD102FL		08/84 >				S 7091 A
N12 Serie							
N12	TD120A		09/86 >	S 5800 R	S 4323 NR	S 0070 A	✗
with oil radiator for gearbox (3, R/SR 70/1400/1700) / con radiatore dell'olio per il cambio (3, R/SR 70/1400/1700)	TD120A		09/86 >				S 3257 R
inner to frame No. 305999 / interno a telaio N. 305999	TD120A		09/86 >			S 7338 A	
inner from frame No. 306000 / interno da telaio N. 306000	TD120A					S 7A34 A	
power steering (Ø 60) / servosterzo (Ø 60)	TD120A		09/86 >				S 3081 PO
power steering (Ø 80) / servosterzo (Ø 80)	TD120A		09/86 >				S 8790 PO
bleed / sfiato	TD120A		09/86 >				S 7091 A
N12	TD120E/G/GA		09/86 >	S 0900 R	S 4323 NR	S 0070 A	✗
with oil radiator for gearbox (3, R/SR 70/1400/1700) / con radiatore dell'olio per il cambio (3, R/SR 70/1400/1700)	TD120E/G/GA		09/86 >				S 3257 R
inner to frame No. 305999 / interno a telaio N. 305999	TD120E/G/GA		09/86 >			S 7338 A	
inner from frame No. 306000 / interno da telaio N. 306000	TD120E/G/GA					S 7A34 A	
power steering (Ø 60) / servosterzo (Ø 60)	TD120E/G/GA		09/86 >				S 3081 PO
power steering (Ø 80) / servosterzo (Ø 80)	TD120E/G/GA		09/86 >				S 8790 PO
bleed / sfiato	TD120E/G/GA		09/86 >				S 7091 A
N12	TD121, TD122		09/86 >			S 7337 A	✗
with intercooler / con intercooler	TD121, TD122		09/86 >				S 3257 R
with oil radiator for gearbox (3, R/SR 70/1400/1700) / con radiatore dell'olio per il cambio (3, R/SR 70/1400/1700)	TD121, TD122		09/86 >			S 7338 A	
inner to frame No. 305999 / interno a telaio N. 305999	TD121, TD122		09/86 >			S 7A34 A	
inner from frame No. 306000 / interno da telaio N. 306000	TD121, TD122						
2 filters / N.2 filtri	TD121, TD122		09/86 >	S 0900 R	S 4323 NR		
without intercooler / senza intercooler	TD121, TD122		09/86 >			S 0070 A	✗
power steering (Ø 60) / servosterzo (Ø 60)	TD121, TD122		09/86 >				S 3081 PO
power steering (Ø 80) / servosterzo (Ø 80)	TD121, TD122		09/86 >				S 8790 PO
bleed / sfiato	TD121, TD122		09/86 >				S 7091 A
N12	TD121F	283 385	09/86 >			S 7337 A	✗
with oil radiator for gearbox (3, R/SR 70/1400/1700) / con radiatore dell'olio per il cambio (3, R/SR 70/1400/1700)	TD121F	283 385	09/86 >				S 3257 R
inner to frame No. 305999 / interno a telaio N. 305999	TD121F	283 385	09/86 >			S 7338 A	
inner from frame No. 306000 / interno da telaio N. 306000	TD121F	283 385				S 7A34 A	
2 filters / N.2 filtri	TD121F	283 385	09/86 >	S 0900 R	S 4323 NR		
without intercooler / senza intercooler	TD121F	283 385	09/86 >			S 0070 A	✗
power steering (Ø 60) / servosterzo (Ø 60)	TD121F	283 385	09/86 >				S 3081 PO
power steering (Ø 80) / servosterzo (Ø 80)	TD121F	283 385	09/86 >				S 8790 PO
bleed / sfiato	TD121F	283 385	09/86 >				S 7091 A
N7 Serie							
N7	TD70B, TD70E		09/73 > 11/87	S 5800 R	S 4323 NR	S 0070 A	
inner / interno	TD70B, TD70E		09/73 > 11/87			S 7338 A	
power steering (Ø 60) / servosterzo (Ø 60)	TD70B, TD70E		09/73 > 11/87				S 3081 PO
power steering (Ø 80) / servosterzo (Ø 80)	TD70B, TD70E		09/73 > 11/87				S 8790 PO
bleed / sfiato	TD70B, TD70E		09/73 > 11/87				S 7091 A
N7	TD70G		08/78 > 11/87	S 5800 R	S 4323 NR	S 0070 A	
inner / interno	TD70G		08/78 > 11/87			S 7338 A	
power steering (Ø 60) / servosterzo (Ø 60)	TD70G		08/78 > 11/87				S 3081 PO
power steering (Ø 80) / servosterzo (Ø 80)	TD70G		08/78 > 11/87				S 8790 PO
bleed / sfiato	TD70G		08/78 > 11/87				S 7091 A
N80 Serie							
N84				S 5800 R	S 1411 N	S 4450 A	
to engine No. 21065 / a motore N. 21065							



kW HP



...VOLVO - trucks/autocarri

from engine No. 21066 / da motore N. 21066					S 5800 R	S 4323 NR	S 4450 A	
N86	D70A, D70B				S 5800 R	S 7111 NC	S 4450 A	
N86	TD70A				S 5800 R	S 7111 NC	S 4450 A	
injection BOSCH / iniezione BOSCH	TD70A				S 5800 R	S 4323 NR	S 4450 A	
N86	TD70B				S 5800 R	S 4323 NR	S 4450 A	
N88								
to engine No. 19896 / a motore N. 19896	D100A				S 5800 R	S 1411 N	S 4450 A	
from engine No. 19897 / da motore N. 19897	D100A				S 5800 R	S 4323 NR	S 4450 A	
N88								
to engine No. 19896 / a motore N. 19896	D100B, TD100A				S 5800 R	S 1411 N	S 6450 A	
from engine No. 19897 / da motore N. 19897	D100B, TD100A				S 5800 R	S 4323 NR	S 6450 A	
NB86	D70A, D70B				S 5800 R	S 7111 NC	S 4450 A	
NB86	TD70A				S 5800 R	S 7111 NC	S 4450 A	
injection BOSCH / iniezione BOSCH	TD70A				S 5800 R	S 4323 NR	S 4450 A	
NB86	TD70B				S 5800 R	S 4323 NR	S 4450 A	
NB88								
to engine No. 19896 / a motore N. 19896	D100A				S 5800 R	S 1411 N	S 4450 A	
from engine No. 19897 / da motore N. 19897	D100A				S 5800 R	S 4323 NR	S 4450 A	
NB88								
to engine No. 19896 / a motore N. 19896	D100B, TD100A				S 5800 R	S 1411 N	S 6450 A	
from engine No. 19897 / da motore N. 19897	D100B, TD100A				S 5800 R	S 4323 NR	S 6450 A	
NH12 Serie								
NH12-380	D12C380	279	380	07/99 >		S 5020 NR	S 7285 A	✗
by-pass	D12C380	279	380	07/99 >	S 4120 R			
water filter / filtro acqua	D12C380	279	380	07/99 >				S 9006 AR
inner / interno	D12C380	279	380	07/99 >			S 7576 A	
2 filters / N.2 filtri	D12C380	279	380	07/99 >	S 0900 R			
2 filters LONG LIFE / N.2 filtri LONG LIFE	D12C380	279	380	07/99 >	S 4402 R			
NH12-420	D12C420	308	420	07/99 >		S 5020 NR	S 7285 A	✗
by-pass	D12C420	308	420	07/99 >	S 4120 R			
water filter / filtro acqua	D12C420	308	420	07/99 >				S 9006 AR
inner / interno	D12C420	308	420	07/99 >			S 7576 A	
2 filters / N.2 filtri	D12C420	308	420	07/99 >	S 0900 R			
2 filters LONG LIFE / N.2 filtri LONG LIFE	D12C420	308	420	07/99 >	S 4402 R			
NH12-460	D12C460	337	460	07/99 >		S 5020 NR	S 7285 A	✗
by-pass	D12C460	337	460	07/99 >	S 4120 R			
water filter / filtro acqua	D12C460	337	460	07/99 >				S 9006 AR
inner / interno	D12C460	337	460	07/99 >			S 7576 A	
2 filters / N.2 filtri	D12C460	337	460	07/99 >	S 0900 R			
2 filters LONG LIFE / N.2 filtri LONG LIFE	D12C460	337	460	07/99 >	S 4402 R			
NL10 Serie								
NL 10-280	TD100G	202	275	06/89 >			S 7337 A	✗
with oil radiator for gearbox / con radiatore dell'olio per il cambio	TD100G	202	275	06/89 >				S 3257 R
inner from frame No. 373632 / interno da telaio N. 373632	TD100G	202	275				S 7A34 A	
LONG LIFE 2 filters / LONG LIFE N.2 filtri	TD100G	202	275	06/89 >	S 4402 R			
2 filters / N.2 filtri	TD100G	202	275	06/89 >	S 0900 R	S 4323 NR		
power steering / servosterzo	TD100G	202	275	06/89 >				S 3081 PO
bleed / sfiato	TD100G	202	275	06/89 >				S 7091 A
NL 10-280	TD101G	202	275	06/89 >			S 7337 A	✗
with oil radiator for gearbox / con radiatore dell'olio per il cambio	TD101G	202	275	06/89 >				S 3257 R
inner from frame No. 373632 / interno da telaio N. 373632	TD101G	202	275				S 7A34 A	
LONG LIFE 2 filters / LONG LIFE N.2 filtri	TD101G	202	275	06/89 >	S 4402 R			
2 filters / N.2 filtri	TD101G	202	275	06/89 >	S 0900 R	S 4323 NR		
power steering / servosterzo	TD101G	202	275	06/89 >				S 3081 PO
bleed / sfiato	TD101G	202	275	06/89 >				S 7091 A
NL 10-280	TD102F	202	275	06/89 >			S 7337 A	✗
with oil radiator for gearbox / con radiatore dell'olio per il cambio	TD102F	202	275	06/89 >				S 3257 R
inner from frame No. 373632 / interno da telaio N. 373632	TD102F	202	275				S 7A34 A	
LONG LIFE 2 filters / LONG LIFE N.2 filtri	TD102F	202	275	06/89 >	S 4402 R			
2 filters / N.2 filtri	TD102F	202	275	06/89 >	S 0900 R	S 4323 NR		
power steering / servosterzo	TD102F	202	275	06/89 >				S 3081 PO
bleed / sfiato	TD102F	202	275	06/89 >				S 7091 A
NL 10-300	TD101F	221	301	06/89 >			S 7337 A	✗
with oil radiator for gearbox / con radiatore dell'olio per il cambio	TD101F	221	301	06/89 >				S 3257 R
inner from frame No. 373632 / interno da telaio N. 373632	TD101F	221	301				S 7A34 A	
LONG LIFE 2 filters / LONG LIFE N.2 filtri	TD101F	221	301	06/89 >	S 4402 R			
2 filters / N.2 filtri	TD101F	221	301	06/89 >	S 0900 R	S 4323 NR		

V





...VOLVO - trucks/autocarri



power steering / servosterzo	TD101F	221 301	06/89 >				S 3081 PO
bleed / sfiato	TD101F	221 301	06/89 >				S 7091 A
NL 10-310	TD102FT	228 310	12/92 >			S 7337 A	✗
with oil radiator for gearbox / con radiatore dell'olio per il cambio	TD102FT	228 310	12/92 >				S 3257 R
inner / interno	TD102FT	228 310	12/92 >			S 7A34 A	
LONG LIFE 2 filters / LONG LIFE N.2 filtri	TD102FT	228 310	12/92 >	S 4402 R			
2 filters / N.2 filtri	TD102FT	228 310	12/92 >	S 0900 R	S 4323 NR		
power steering / servosterzo	TD102FT	228 310	12/92 >				S 3081 PO
bleed / sfiato	TD102FT	228 310	12/92 >				S 7091 A
NL 10-320	D10A	235 320	01/96 >	S 0900 R	S 5020 NR	S 7337 A	✗
by-pass	D10A	235 320	01/96 >	S 4120 R			
inner / interno	D10A	235 320	01/96 >			S 7A34 A	
power steering / servosterzo	D10A	235 320	01/96 >				S 3081 PO
NL 10-340	TD102FS	250 340	06/89 >			S 7337 A	✗
with oil radiator for gearbox / con radiatore dell'olio per il cambio	TD102FS	250 340	06/89 >				S 3257 R
inner from frame No. 373632 / interno da telaio N. 373632	TD102FS	250 340				S 7A34 A	
LONG LIFE 2 filters / LONG LIFE N.2 filtri	TD102FS	250 340	06/89 >	S 4402 R			
2 filters / N.2 filtri	TD102FS	250 340	06/89 >	S 0900 R	S 4323 NR		
power steering / servosterzo	TD102FS	250 340	06/89 >				S 3081 PO
bleed / sfiato	TD102FS	250 340	06/89 >				S 7091 A
NL12 Serie							
NL12-360	TD122F	265 360	12/92 >			S 7337 A	✗
some outer / alcuni esterno	TD122F	265 360	12/92 >			S 0070 A	
with oil radiator for gearbox / con radiatore dell'olio per il cambio	TD122F	265 360	12/92 >				S 3257 R
inner / interno	TD122F	265 360	12/92 >			S 7A34 A	
2 filters / N.2 filtri	TD122F	265 360	12/92 >	S 0900 R	S 4323 NR		
power steering / servosterzo	TD122F	265 360	12/92 >				S 3081 PO
bleed / sfiato	TD122F	265 360	12/92 >				S 7091 A
NL12-360	TD123E	265 360	01/96 >			S 7337 A	✗
with oil radiator for gearbox / con radiatore dell'olio per il cambio	TD123E	265 360	01/96 >				S 3257 R
inner / interno	TD123E	265 360	01/96 >			S 7A34 A	
2 filters / N.2 filtri	TD123E	265 360	01/96 >	S 0900 R	S 4323 NR		
power steering / servosterzo	TD123E	265 360	01/96 >				S 3081 PO
bleed / sfiato	TD123E	265 360	01/96 >				S 7091 A
NL12-380	TD121F	282 384	10/89 >			S 7337 A	✗
some outer / alcuni esterno	TD121F	282 384	10/89 >			S 0070 A	
with oil radiator for gearbox / con radiatore dell'olio per il cambio	TD121F	282 384	10/89 >				S 3257 R
inner / interno	TD121F	282 384	10/89 >			S 7A34 A	
2 filters / N.2 filtri	TD121F	282 384	10/89 >	S 0900 R	S 4323 NR		
power steering / servosterzo	TD121F	282 384	10/89 >				S 3081 PO
bleed / sfiato	TD121F	282 384	10/89 >				S 7091 A
NL12-400	TD122FS	294 400	06/89 >			S 7337 A	✗
some outer / alcuni esterno	TD122FS	294 400	06/89 >			S 0070 A	
with oil radiator for gearbox / con radiatore dell'olio per il cambio	TD122FS	294 400	06/89 >				S 3257 R
inner / interno	TD122FS	294 400	06/89 >			S 7A34 A	
2 filters / N.2 filtri	TD122FS	294 400	06/89 >	S 0900 R	S 4323 NR		
power steering / servosterzo	TD122FS	294 400	06/89 >				S 3081 PO
bleed / sfiato	TD122FS	294 400	06/89 >				S 7091 A
NL12-410	TD122FR	302 411	12/92 >			S 7337 A	✗
some outer / alcuni esterno	TD122FR	302 411	12/92 >			S 0070 A	
with oil radiator for gearbox / con radiatore dell'olio per il cambio	TD122FR	302 411	12/92 >				S 3257 R
inner / interno	TD122FR	302 411	12/92 >			S 7A34 A	
2 filters / N.2 filtri	TD122FR	302 411	12/92 >	S 0900 R	S 4323 NR		
power steering / servosterzo	TD122FR	302 411	12/92 >				S 3081 PO
bleed / sfiato	TD122FR	302 411	12/92 >				S 7091 A
NL12-420	TD123ES	309 420	01/96 >			S 7337 A	✗
with oil radiator for gearbox / con radiatore dell'olio per il cambio	TD123ES	309 420	01/96 >				S 3257 R
inner / interno	TD123ES	309 420	01/96 >			S 7A34 A	
2 filters / N.2 filtri	TD123ES	309 420	01/96 >	S 0900 R	S 4323 NR		
power steering / servosterzo	TD123ES	309 420	01/96 >				S 3081 PO
bleed / sfiato	TD123ES	309 420	01/96 >				S 7091 A
TL Serie							
TL385	D67					S 8381 NC	
VDB							
VDB						S 0201 N	
some / alcuni						S 1411 N	
VN Serie							



kW HP



...VOLVO - trucks/autocarri

VN630	VED12			08/02 >		S 9320 NR	S 7F18 A	
by-pass	VED12			08/02 >	S 4120 R			
inner / interno	VED12			08/02 >			S 7F19 A	
2 filters / N.2 filtri	VED12			08/02 >	S 4402 R			
prefilter / prefiltra	VED12			08/02 >		S 4461 NR		
VN670	VED12			08/02 >		S 9320 NR	S 7F18 A	
by-pass	VED12			08/02 >	S 4120 R			
inner / interno	VED12			08/02 >			S 7F19 A	
2 filters / N.2 filtri	VED12			08/02 >	S 4402 R			
prefilter / prefiltra	VED12			08/02 >		S 4461 NR		
VN730	VED12			01/06 >		S 9320 NR	S 7F18 A	
by-pass	VED12			01/06 >	S 4120 R			
inner / interno	VED12			01/06 >			S 7F19 A	
2 filters / N.2 filtri	VED12			01/06 >	S 4402 R			
prefilter / prefiltra	VED12			01/06 >		S 4461 NR		
VN780	VED12			08/02 >		S 9320 NR	S 7F18 A	
by-pass	VED12			08/02 >	S 4120 R			
inner / interno	VED12			08/02 >			S 7F19 A	
2 filters / N.2 filtri	VED12			08/02 >	S 4402 R			
prefilter / prefiltra	VED12			08/02 >		S 4461 NR		
VT Serie								
VT880	D16D-625	460 625		02/06 >			S 7F18 A	S 9006 AR
by-pass	D16D-625	460 625		02/06 >	S 4120 R			
inner / interno	D16D-625	460 625		02/06 >			S 7F19 A	
2 filters / N.2 filtri	D16D-625	460 625		02/06 >	S 4402 R			
prefilter / prefiltra	D16D-625	460 625		02/06 >		S 4461 NR		
VOLVO buses/autobus								
5000 Serie								
5000	D7C215	158 215		08/99 >	S 0900 R	S 5020 NR		
	D7C215	158 215		09/06 >	S 5097 PE		S 7347 A	
by-pass	D7C215	158 215		08/99 >	S 4120 R			
with filter AdBlue/SCR Denoxtronic 1 / con filtro AdBlue/SCR Denoxtronic 1	D7C215	158 215		09/06 >				S 4401 U
dryer filter / filtro essiccatore	D7C215	158 215		08/99 >				S 7259 A
inner / interno	D7C215	158 215		09/06 >			S 7484 A	
LONG LIFE	D7C215	158 215		08/99 >	S 4402 R			
5000	D7C250	183 250		08/99 >	S 0900 R	S 5020 NR		
by-pass	D7C250	183 250		08/99 >	S 4120 R			
dryer filter / filtro essiccatore	D7C250	183 250		08/99 >				S 7259 A
LONG LIFE	D7C250	183 250		08/99 >	S 4402 R			
5000	D7C290	213 290		08/99 >	S 0900 R	S 5020 NR		
by-pass	D7C290	213 290		08/99 >	S 4120 R			
dryer filter / filtro essiccatore	D7C290	213 290		08/99 >				S 7259 A
LONG LIFE	D7C290	213 290		08/99 >	S 4402 R			
7000 Serie								
7000	D7C215	158 215		08/98 >	S 0900 R	S 5020 NR		
by-pass	D7C215	158 215		08/98 >	S 4120 R			
with automatic gearbox / con cambio automatico	D7C215	158 215		08/98 >				S 5238 PE
dryer filter / filtro essiccatore	D7C215	158 215		08/98 >				S 7259 A
LONG LIFE	D7C215	158 215		08/98 >	S 4402 R			
7000	D7C250	183 250		08/98 >	S 0900 R	S 5020 NR		
by-pass	D7C250	183 250		08/98 >	S 4120 R			
with automatic gearbox / con cambio automatico	D7C250	183 250		08/98 >				S 5238 PE
dryer filter / filtro essiccatore	D7C250	183 250		08/98 >				S 7259 A
LONG LIFE	D7C250	183 250		08/98 >	S 4402 R			
7000	D7C290	213 290		08/98 >	S 0900 R	S 5020 NR		
by-pass	D7C290	213 290		08/98 >	S 4120 R			
with automatic gearbox / con cambio automatico	D7C290	213 290		08/98 >				S 5238 PE
dryer filter / filtro essiccatore	D7C290	213 290		08/98 >				S 7259 A
LONG LIFE	D7C290	213 290		08/98 >	S 4402 R			
7450	D12A/C420	309 421		04/99 >	S 0900 R	S 5020 NR		
by-pass	D12A/C420	309 421		04/99 >	S 4120 R			
with automatic gearbox / con cambio automatico	D12A/C420	309 421		04/99 >				S 5238 PE
dryer filter / filtro essiccatore	D12A/C420	309 421		04/99 >				S 7259 A
LONG LIFE	D12A/C420	309 421		04/99 >	S 4402 R			
7500	D9A340	250 340		03/06 >		S 9320 NR	S 7337 A	
by-pass	D9A340	250 340		03/06 >	S 4120 R			

V



**KW HP****...VOLVO - buses/autobus**

with automatic gearbox / con cambio automatico	D9A340	250	340	03/06	>				S 5238 PE
LONG LIFE	D9A340	250	340	03/06	>				
2 filters / N.2 filtri	D9A340	250	340	03/06	>	S 4402 R	S 4120 NR		
prefilter / prefiltrato	D9A340	250	340	03/06	>		S 4461 NR		
7700	D9B260 Euro 4/5	191	260	09/06	>		S 9320 NR	S 7337 A	
by-pass	D9B260 Euro 4/5	191	260	09/06	>	S 4120 R			
with automatic gearbox / con cambio automatico	D9B260 Euro 4/5	191	260	09/06	>				S 5238 PE
with filter Urea/Adblue / con filtro Urea/Adblue	D9B260 Euro 4/5	191	260	09/06	>				S 4401 U
LONG LIFE	D9B260 Euro 4/5	191	260	09/06	>		S 4120 NR		
2 filters / N.2 filtri	D9B260 Euro 4/5	191	260	09/06	>	S 4402 R			
prefilter / prefiltrato	D9B260 Euro 4/5	191	260	09/06	>		S 4461 NR		
7700	D9B310 Euro 4/5	228	310	09/06	>		S 9320 NR	S 7337 A	
by-pass	D9B310 Euro 4/5	228	310	09/06	>	S 4120 R			
with automatic gearbox / con cambio automatico	D9B310 Euro 4/5	228	310	09/06	>				S 5238 PE
with filter Urea/Adblue / con filtro Urea/Adblue	D9B310 Euro 4/5	228	310	09/06	>				S 4401 U
LONG LIFE	D9B310 Euro 4/5	228	310	09/06	>		S 4120 NR		
2 filters / N.2 filtri	D9B310 Euro 4/5	228	310	09/06	>	S 4402 R			
prefilter / prefiltrato	D9B310 Euro 4/5	228	310	09/06	>		S 4461 NR		
7700	D9B360 Euro 4/5	265	360	09/06	>		S 9320 NR	S 7337 A	
by-pass	D9B360 Euro 4/5	265	360	09/06	>	S 4120 R			
with automatic gearbox / con cambio automatico	D9B360 Euro 4/5	265	360	09/06	>				S 5238 PE
with filter Urea/Adblue / con filtro Urea/Adblue	D9B360 Euro 4/5	265	360	09/06	>				S 4401 U
LONG LIFE	D9B360 Euro 4/5	265	360	09/06	>		S 4120 NR		
2 filters / N.2 filtri	D9B360 Euro 4/5	265	360	09/06	>	S 4402 R			
prefilter / prefiltrato	D9B360 Euro 4/5	265	360	09/06	>		S 4461 NR		
7700 Hybrid	D5E/F210 E5/EEV	154	210	10/09	>	S 5097 PE	S 6039 NE	S 7A29 A	S 9006 AR
with automatic gearbox VOITH D854.3, D864.3 / con cambio automatico VOITH D854.3, D864.3	D5E/F210 E5/EEV	154	210	10/09	>				S 6449 PO
with automatic gearbox VOITH D854.3E, D864.3E / con cambio automatico VOITH D854.3E, D864.3E	D5E/F210 E5/EEV	154	210	10/09	>				S 5663 PO
with air-conditioner WEBASTO Aerosphere (6 filters) / con climatizzatore WEBASTO Aerosphere (N.6 filtri)	D5E/F210 E5/EEV	154	210	10/09	>				S 3081 C
with filter AdBlue/SCR Denoxtronic 1 / con filtro AdBlue/SCR Denoxtronic 1	D5E/F210 E5/EEV	154	210	10/09	>				S 4401 U
with filter AdBlue/SCR Denoxtronic 2 / con filtro AdBlue/SCR Denoxtronic 2	D5E/F210 E5/EEV	154	210	10/09	>				S 4402 U
dryer filter WABCO / filtro essiccatore WABCO	D5E/F210 E5/EEV	154	210	10/09	>				S 7A66 A
7700 Hybrid	D5E/F215 E5/EEV	161	215	10/11	>	S 5097 PE	S 6039 NE	S 7A29 A	
with automatic gearbox VOITH D854.3, D864.3 / con cambio automatico VOITH D854.3, D864.3	D5E/F215 E5/EEV	161	215	10/11	>				S 6449 PO
with automatic gearbox VOITH D854.3E, D864.3E / con cambio automatico VOITH D854.3E, D864.3E	D5E/F215 E5/EEV	161	215	10/11	>				S 5663 PO
with air-conditioner WEBASTO Aerosphere (6 filters) / con climatizzatore WEBASTO Aerosphere (N.6 filtri)	D5E/F215 E5/EEV	161	215	10/11	>				S 3081 C
with filter AdBlue/SCR Denoxtronic 2 / con filtro AdBlue/SCR Denoxtronic 2	D5E/F215 E5/EEV	161	215	10/11	>				S 4402 U
dryer filter WABCO / filtro essiccatore WABCO	D5E/F215 E5/EEV	161	215	10/11	>				S 7A66 A
7700A	D9B310 Euro 4/5	228	310	09/06	>		S 9320 NR	S 7337 A	
by-pass	D9B310 Euro 4/5	228	310	09/06	>	S 4120 R			
with filter Urea/Adblue / con filtro Urea/Adblue	D9B310 Euro 4/5	228	310	09/06	>				S 4401 U
LONG LIFE	D9B310 Euro 4/5	228	310	09/06	>		S 4120 NR		
2 filters / N.2 filtri	D9B310 Euro 4/5	228	310	09/06	>	S 4402 R			
prefilter / prefiltrato	D9B310 Euro 4/5	228	310	09/06	>		S 4461 NR		
7700A	D9B360 Euro 4/5	265	360	09/06	>		S 9320 NR	S 7337 A	
by-pass	D9B360 Euro 4/5	265	360	09/06	>	S 4120 R			
with filter Urea/Adblue / con filtro Urea/Adblue	D9B360 Euro 4/5	265	360	09/06	>				S 4401 U
LONG LIFE	D9B360 Euro 4/5	265	360	09/06	>		S 4120 NR		
2 filters / N.2 filtri	D9B360 Euro 4/5	265	360	09/06	>	S 4402 R			
prefilter / prefiltrato	D9B360 Euro 4/5	265	360	09/06	>		S 4461 NR		
7900	D9B-260 E5/EEV	191	260	10/11	>		S 4120 NR	S 7A29 A	
by-pass	D9B-260 E5/EEV	191	260	10/11	>	S 4120 R			
with automatic gearbox / con cambio automatico	D9B-260 E5/EEV	191	260	10/11	>				S 5238 PE
with air-conditioner WEBASTO Aerosphere (6 filters) / con climatizzatore WEBASTO Aerosphere (N.6 filtri)	D9B-260 E5/EEV	191	260	10/11	>				S 3081 C
with filter AdBlue/SCR Denoxtronic 2 / con filtro AdBlue/SCR Denoxtronic 2	D9B-260 E5/EEV	191	260	10/11	>				S 4402 U
dryer filter WABCO / filtro essiccatore WABCO	D9B-260 E5/EEV	191	260	10/11	>				S 7A66 A
2 filters / N.2 filtri	D9B-260 E5/EEV	191	260	10/11	>	S 4402 R			
7900	D9B-310 E5/EEV	228	310	10/11	>		S 4120 NR	S 7A29 A	
by-pass	D9B-310 E5/EEV	228	310	10/11	>	S 4120 R			
with automatic gearbox / con cambio automatico	D9B-310 E5/EEV	228	310	10/11	>				S 5238 PE
with air-conditioner WEBASTO Aerosphere (6 filters) / con climatizzatore WEBASTO Aerosphere (N.6 filtri)	D9B-310 E5/EEV	228	310	10/11	>				S 3081 C
with filter AdBlue/SCR Denoxtronic 2 / con filtro AdBlue/SCR Denoxtronic 2	D9B-310 E5/EEV	228	310	10/11	>				S 4402 U
dryer filter WABCO / filtro essiccatore WABCO	D9B-310 E5/EEV	228	310	10/11	>				S 7A66 A
2 filters / N.2 filtri	D9B-310 E5/EEV	228	310	10/11	>	S 4402 R			
7900	D9B-360 E5/EEV	265	360	10/11	>		S 4120 NR	S 7A29 A	
by-pass	D9B-360 E5/EEV	265	360	10/11	>	S 4120 R			
with automatic gearbox / con cambio automatico	D9B-360 E5/EEV	265	360	10/11	>				S 5238 PE

**kW HP****...VOLVO - buses/autobus**

with air-conditioner WEBASTO Aerosphere (6 filters) / con climatizzatore WEBASTO Aerosphere (N.6 filtri)	D9B-360 E5/EEV	265	360	10/11	>				S 3081 C
with filter AdBlue/SCR Denoxtronic 2 / con filtro AdBlue/SCR Denoxtronic 2	D9B-360 E5/EEV	265	360	10/11	>				S 4402 U
dryer filter WABCO / filtro essiccatore WABCO	D9B-360 E5/EEV	265	360	10/11	>				S 7A66 A
2 filters / N.2 filtri	D9B-360 E5/EEV	265	360	10/11	>		S 4402 R		
7900 Hybrid	D6E/F215 E5/E6/EEV	161	215	10/11	>		S 5097 PE	S 6039 NE	S 7A29 A
with automatic gearbox / con cambio automatico	D6E/F215 E5/E6/EEV	161	215	10/11	>				S 5238 PE
with automatic gearbox VOITH D854.3, D864.3 / con cambio automatico VOITH D854.3, D864.3	D6E/F215 E5/E6/EEV	161	215	10/11	>				S 6449 PO
with automatic gearbox VOITH D854.3E, D864.3E / con cambio automatico VOITH D854.3E, D864.3E	D6E/F215 E5/E6/EEV	161	215	10/11	>				S 5663 PO
with air-conditioner WEBASTO Aerosphere (6 filters) / con climatizzatore WEBASTO Aerosphere (N.6 filtri)	D6E/F215 E5/E6/EEV	161	215	10/11	>				S 3081 C
with filter AdBlue/SCR Denoxtronic 2 / con filtro AdBlue/SCR Denoxtronic 2	D6E/F215 E5/E6/EEV	161	215	10/11	>				S 4402 U
dryer filter WABCO / filtro essiccatore WABCO	D6E/F215 E5/E6/EEV	161	215	10/11	>				S 7A66 A
8000 Serie									
8500 (TX)	DH12D	249	340	01/99	>	08/05		S 9320 NR	S 9006 AR
	DH12D	249	340	09/05	>			S 9320 NR	S 7337 A
by-pass	DH12D	249	340	01/99	>		S 4120 R		
with automatic gearbox / con cambio automatico	DH12D	249	340	01/99	>				S 5238 PE
with automatic gearbox VOITH D854.3, D864.3 / con cambio automatico VOITH D854.3, D864.3	DH12D	249	340	01/99	>				S 6449 PO
with automatic gearbox VOITH D854.3E, D864.3E / con cambio automatico VOITH D854.3E, D864.3E	DH12D	249	340	01/99	>				S 5663 PO
dryer filter / filtro essiccatore	DH12D	249	340	01/99	>				S 7259 A
dryer filter WABCO / filtro essiccatore WABCO	DH12D	249	340	01/99	>				S 7A66 A
inner / interno	DH12D	249	340	09/05	>			S 7A34 A	
LONG LIFE	DH12D	249	340	01/99	>			S 4120 NR	
LONG LIFE 2 filters / LONG LIFE N.2 filtri	DH12D	249	340	01/99	>		S 4402 R		
2 filters / N.2 filtri	DH12D	249	340	01/99	>		S 0900 R		
prefilter / prefiltra	DH12D	249	340	01/99	>			S 4461 NR	
8500 (TX)	DH12E340 Euro4/5	250	340	06/06	>			S 9320 NR	S 7337 A
by-pass	DH12E340 Euro4/5	250	340	06/06	>		S 4120 R		
with automatic gearbox / con cambio automatico	DH12E340 Euro4/5	250	340	06/06	>				S 5238 PE
with automatic gearbox VOITH D854.3, D864.3 / con cambio automatico VOITH D854.3, D864.3	DH12E340 Euro4/5	250	340	06/06	>				S 6449 PO
with automatic gearbox VOITH D854.3E, D864.3E / con cambio automatico VOITH D854.3E, D864.3E	DH12E340 Euro4/5	250	340	06/06	>				S 5663 PO
with filter Urea/Adblue Denoxtronic 1 / con filtro Urea/Adblue Denoxtronic 1	DH12E340 Euro4/5	250	340	06/06	>				S 4401 U
LONG LIFE	DH12E340 Euro4/5	250	340	06/06	>			S 4120 NR	
2 filters / N.2 filtri	DH12E340 Euro4/5	250	340	06/06	>		S 4402 R		
prefilter / prefiltra	DH12E340 Euro4/5	250	340	06/06	>			S 4461 NR	
8700	D7E-340 Euro 4/5	250	340	09/06	>		S 5097 PE		S 7347 A
with automatic gearbox / con cambio automatico	D7E-340 Euro 4/5	250	340	09/06	>				S 5238 PE
with automatic gearbox VOITH D854.3, D864.3 / con cambio automatico VOITH D854.3, D864.3	D7E-340 Euro 4/5	250	340	09/06	>				S 6449 PO
with filter AdBlue/SCR Denoxtronic 1 / con filtro AdBlue/SCR Denoxtronic 1	D7E-340 Euro 4/5	250	340	09/06	>				S 4401 U
8700 (TX)	D7C-275	202	275	09/04	>	08/05	S 0900 R	S 5020 NR	S 9006 AR
	D7C-275	202	275	09/05	>		S 0900 R	S 5020 NR	S 7337 A
by-pass	D7C-275	202	275	09/04	>		S 4120 R		
with automatic gearbox / con cambio automatico	D7C-275	202	275	09/04	>				S 5238 PE
with automatic gearbox VOITH D854.3, D864.3 / con cambio automatico VOITH D854.3, D864.3	D7C-275	202	275	09/04	>				S 6449 PO
with automatic gearbox VOITH D854.3E, D864.3E / con cambio automatico VOITH D854.3E, D864.3E	D7C-275	202	275	09/04	>				S 5663 PO
dryer filter WABCO / filtro essiccatore WABCO	D7C-275	202	275	09/04	>				S 7A66 A
inner / interno	D7C-275	202	275	09/05	>			S 7A34 A	
LONG LIFE	D7C-275	202	275	09/04	>		S 4402 R		
prefilter / prefiltra	D7C-275	202	275	09/04	>			S 4461 NR	
8700 (TX)	D7C-310	228	310	09/04	>	08/05	S 0900 R	S 5020 NR	S 9006 AR
	D7C-310	228	310	09/05	>		S 0900 R	S 5020 NR	S 7337 A
by-pass	D7C-310	228	310	09/04	>		S 4120 R		
with automatic gearbox / con cambio automatico	D7C-310	228	310	09/04	>				S 5238 PE
with automatic gearbox VOITH D854.3, D864.3 / con cambio automatico VOITH D854.3, D864.3	D7C-310	228	310	09/04	>				S 6449 PO
with automatic gearbox VOITH D854.3E, D864.3E / con cambio automatico VOITH D854.3E, D864.3E	D7C-310	228	310	09/04	>				S 5663 PO
dryer filter WABCO / filtro essiccatore WABCO	D7C-310	228	310	09/04	>				S 7A66 A
inner / interno	D7C-310	228	310	09/05	>			S 7A34 A	
LONG LIFE	D7C-310	228	310	09/04	>		S 4402 R		
prefilter / prefiltra	D7C-310	228	310	09/04	>			S 4461 NR	
8700 (TX)	D7E-290 Euro 4/5	213	290	09/06	>		S 5097 PE		S 7347 A
with automatic gearbox / con cambio automatico	D7E-290 Euro 4/5	213	290	09/06	>				S 5238 PE
with automatic gearbox VOITH D854.3, D864.3 / con cambio automatico VOITH D854.3, D864.3	D7E-290 Euro 4/5	213	290	09/06	>				S 6449 PO
with filter AdBlue/SCR Denoxtronic 1 / con filtro AdBlue/SCR Denoxtronic 1	D7E-290 Euro 4/5	213	290	09/06	>				S 4401 U
8700 (TX)	DH12D-340	250	340	09/03	>	08/05		S 9320 NR	S 9006 AR
	DH12D-340	250	340	09/05	>			S 9320 NR	S 7337 A
by-pass	DH12D-340	250	340	09/03	>		S 4120 R		
with automatic gearbox / con cambio automatico	DH12D-340	250	340	09/03	>				S 5238 PE
with automatic gearbox VOITH D854.3, D864.3 / con cambio automatico VOITH D854.3, D864.3	DH12D-340	250	340	09/03	>				S 6449 PO

V



...VOLVO - buses/autobus



with automatic gearbox VOITH D854.3E, D864.3E / con cambio automatico VOITH D854.3E, D864.3E	DH12D-340	250	340	09/03	>				S 5663 PO
dryer filter WABCO / filtro essiccatore WABCO	DH12D-340	250	340	09/03	>				S 7A66 A
inner / interno	DH12D-340	250	340	09/05	>			S 7A34 A	
LONG LIFE	DH12D-340	250	340	09/03	>		S 4120 NR		
LONG LIFE 2 filters / LONG LIFE N.2 filtri	DH12D-340	250	340	09/03	>	S 4402 R			
2 filters / N.2 filtri	DH12D-340	250	340	09/03	>	S 0900 R			
prefilter / prefiltrato	DH12D-340	250	340	09/03	>		S 4461 NR		
8700 (TX)	DH12D-380	279	380	09/01	>	08/05		S 9320 NR	S 9006 AR
	DH12D-380	279	380	09/05	>			S 9320 NR	S 7337 A
by-pass	DH12D-380	279	380	09/01	>		S 4120 R		
with automatic gearbox / con cambio automatico	DH12D-380	279	380	09/01	>				S 5238 PE
with automatic gearbox VOITH D854.3, D864.3 / con cambio automatico VOITH D854.3, D864.3	DH12D-380	279	380	09/01	>				S 6449 PO
with automatic gearbox VOITH D854.3E, D864.3E / con cambio automatico VOITH D854.3E, D864.3E	DH12D-380	279	380	09/01	>				S 5663 PO
dryer filter / filtro essiccatore	DH12D-380	279	380	09/01	>				S 7259 A
dryer filter WABCO / filtro essiccatore WABCO	DH12D-380	279	380	09/01	>				S 7A66 A
inner / interno	DH12D-380	279	380	09/05	>			S 7A34 A	
LONG LIFE	DH12D-380	279	380	09/01	>		S 4402 R		
LONG LIFE 2 filters / LONG LIFE N.2 filtri	DH12D-380	279	380	09/01	>		S 4402 R		
2 filters / N.2 filtri	DH12D-380	279	380	09/01	>		S 0900 R		
prefilter / prefiltrato	DH12D-380	279	380	09/01	>			S 4461 NR	
8700 (TX)	DH12D-420	309	420	09/04	>	08/05		S 9320 NR	S 9006 AR
	DH12D-420	309	420	09/05	>			S 9320 NR	S 7337 A
by-pass	DH12D-420	309	420	09/04	>		S 4120 R		
with automatic gearbox / con cambio automatico	DH12D-420	309	420	09/04	>				S 5238 PE
with automatic gearbox VOITH D854.3, D864.3 / con cambio automatico VOITH D854.3, D864.3	DH12D-420	309	420	09/04	>				S 6449 PO
with automatic gearbox VOITH D854.3E, D864.3E / con cambio automatico VOITH D854.3E, D864.3E	DH12D-420	309	420	09/04	>				S 5663 PO
dryer filter WABCO / filtro essiccatore WABCO	DH12D-420	309	420	09/04	>				S 7A66 A
inner / interno	DH12D-420	309	420	09/05	>			S 7A34 A	
LONG LIFE	DH12D-420	309	420	09/04	>		S 4120 NR		
LONG LIFE 2 filters / LONG LIFE N.2 filtri	DH12D-420	309	420	09/04	>		S 4402 R		
2 filters / N.2 filtri	DH12D-420	309	420	09/04	>		S 0900 R		
prefilter / prefiltrato	DH12D-420	309	420	09/04	>			S 4461 NR	
8700 (TX)	DH12E340 Euro4/5	250	340	06/06	>			S 9320 NR	S 7337 A
by-pass	DH12E340 Euro4/5	250	340	06/06	>		S 4120 R		
with automatic gearbox / con cambio automatico	DH12E340 Euro4/5	250	340	06/06	>				S 5238 PE
with automatic gearbox VOITH D854.3, D864.3 / con cambio automatico VOITH D854.3, D864.3	DH12E340 Euro4/5	250	340	06/06	>				S 6449 PO
with automatic gearbox VOITH D854.3E, D864.3E / con cambio automatico VOITH D854.3E, D864.3E	DH12E340 Euro4/5	250	340	06/06	>				S 5663 PO
with air-conditioner SUETRAK / con climatizzatore SUETRAK	DH12E340 Euro4/5	250	340	06/06	>				S 3445 C
with filter AdBlue/SCR Denoxtronic 1 / con filtro AdBlue/SCR Denoxtronic 1	DH12E340 Euro4/5	250	340	06/06	>				S 4401 U
with filter AdBlue/SCR Denoxtronic 2 / con filtro AdBlue/SCR Denoxtronic 2	DH12E340 Euro4/5	250	340	06/06	>				S 4402 U
dryer filter WABCO / filtro essiccatore WABCO	DH12E340 Euro4/5	250	340	06/06	>				S 7A66 A
LONG LIFE	DH12E340 Euro4/5	250	340	06/06	>		S 4120 NR		
2 filters / N.2 filtri	DH12E340 Euro4/5	250	340	06/06	>		S 4402 R		
prefilter / prefiltrato	DH12E340 Euro4/5	250	340	06/06	>			S 4461 NR	
8700 (TX)	DH12E380 Euro4/5	279	380	06/06	>			S 9320 NR	S 7337 A
by-pass	DH12E380 Euro4/5	279	380	06/06	>		S 4120 R		
with filter Urea/Adblue / con filtro Urea/Adblue	DH12E380 Euro4/5	279	380	06/06	>				S 4401 U
2 filters / N.2 filtri	DH12E380 Euro4/5	279	380	06/06	>		S 4402 R		
prefilter / prefiltrato	DH12E380 Euro4/5	279	380	06/06	>			S 4461 NR	
8700 LE (TX)	D7E-290 Euro 4/5	213	290	09/06	>		S 5097 PE		S 7347 A
with automatic gearbox VOITH D854.3, D864.3 / con cambio automatico VOITH D854.3, D864.3	D7E-290 Euro 4/5	213	290	09/06	>				S 6449 PO
with filter AdBlue/SCR Denoxtronic 1 / con filtro AdBlue/SCR Denoxtronic 1	D7E-290 Euro 4/5	213	290	09/06	>				S 4401 U
8900	D7E-290 E5	213	290	10/10	>		S 5097 PE		S 7347 A
some outer / alcuni esterno	D7E-290 E5	213	290	10/10	>				S 7A29 A
with automatic gearbox / con cambio automatico	D7E-290 E5	213	290	10/10	>				S 5238 PE
with automatic gearbox VOITH D854.3, D864.3 / con cambio automatico VOITH D854.3, D864.3	D7E-290 E5	213	290	10/10	>				S 6449 PO
with filter AdBlue/SCR Denoxtronic 1 / con filtro AdBlue/SCR Denoxtronic 1	D7E-290 E5	213	290	10/10	>				S 4401 U
8900	D9B-380 E5	279	380	10/10	>			S 4120 NR	S 7347 A
some outer / alcuni esterno	D9B-380 E5	279	380	10/10	>				S 7A29 A
by-pass	D9B-380 E5	279	380	10/10	>		S 4120 R		
with automatic gearbox / con cambio automatico	D9B-380 E5	279	380	10/10	>				S 5238 PE
with automatic gearbox VOITH D854.3, D864.3 / con cambio automatico VOITH D854.3, D864.3	D9B-380 E5	279	380	10/10	>				S 6449 PO
with filter AdBlue/SCR Denoxtronic 1 / con filtro AdBlue/SCR Denoxtronic 1	D9B-380 E5	279	380	10/10	>				S 4401 U
with filter AdBlue/SCR Denoxtronic 2 / con filtro AdBlue/SCR Denoxtronic 2	D9B-380 E5	279	380	10/10	>				S 4402 U
dryer filter WABCO / filtro essiccatore WABCO	D9B-380 E5	279	380	10/10	>				S 7A66 A
inner / interno	D9B-380 E5	279	380	10/10	>			S 7484 A	
2 filters / N.2 filtri	D9B-380 E5	279	380	10/10	>		S 4402 R		

**KW HP****...VOLVO - buses/autobus**

9000 Serie										
9500	spheros aeroshere world SPHEROS / con climatizzatore sul tetto SPHEROS	D8K E6	235	320	02/14	>				S 3458 C
9500	spheros aeroshere world SPHEROS / con climatizzatore sul tetto SPHEROS	D8K E6	257	350	02/14	>				S 3457 C
9700	by-pass	DH12E340 Euro4/5	250	340	09/06	>			S 9320 NR	S 7337 A
	with automatic gearbox / con cambio automatico	DH12E340 Euro4/5	250	340	09/06	>	S 4120 R			S 5238 PE
	spheros aeroshere world SPHEROS / con climatizzatore sul tetto SPHEROS	DH12E340 Euro4/5	250	340	09/06	>				S 3457 C
	with filter Urea/Adblue / con filtro Urea/Adblue	DH12E340 Euro4/5	250	340	09/06	>				S 4401 U
	2 filters / N.2 filtri	DH12E340 Euro4/5	250	340	09/06	>	S 4402 R			
	prefilter / prefiltrato	DH12E340 Euro4/5	250	340	09/06	>			S 4461 NR	
9700	by-pass	DH12E380 Euro4/5	279	380	09/06	>			S 9320 NR	S 7337 A
	with automatic gearbox / con cambio automatico	DH12E380 Euro4/5	279	380	09/06	>	S 4120 R			S 5238 PE
	spheros aeroshere world SPHEROS / con climatizzatore sul tetto SPHEROS	DH12E380 Euro4/5	279	380	09/06	>				S 3457 C
	with filter Urea/Adblue / con filtro Urea/Adblue	DH12E380 Euro4/5	279	380	09/06	>				S 4401 U
	2 filters / N.2 filtri	DH12E380 Euro4/5	279	380	09/06	>	S 4402 R			
	prefilter / prefiltrato	DH12E380 Euro4/5	279	380	09/06	>			S 4461 NR	
9700	by-pass	DH12E420 Euro4/5	309	420	09/06	>			S 9320 NR	S 7337 A
	with automatic gearbox / con cambio automatico	DH12E420 Euro4/5	309	420	09/06	>	S 4120 R			S 5238 PE
	spheros aeroshere world SPHEROS / con climatizzatore sul tetto SPHEROS	DH12E420 Euro4/5	309	420	09/06	>				S 3457 C
	with filter Urea/Adblue / con filtro Urea/Adblue	DH12E420 Euro4/5	309	420	09/06	>				S 4401 U
	2 filters / N.2 filtri	DH12E420 Euro4/5	309	420	09/06	>	S 4402 R			
	prefilter / prefiltrato	DH12E420 Euro4/5	309	420	09/06	>			S 4461 NR	
9700	by-pass	DH12E460 Euro4/5	338	460	09/06	>			S 9320 NR	S 7337 A
	with automatic gearbox / con cambio automatico	DH12E460 Euro4/5	338	460	09/06	>	S 4120 R			S 5238 PE
	spheros aeroshere world SPHEROS / con climatizzatore sul tetto SPHEROS	DH12E460 Euro4/5	338	460	09/06	>				S 3457 C
	with filter Urea/Adblue / con filtro Urea/Adblue	DH12E460 Euro4/5	338	460	09/06	>				S 4401 U
	2 filters / N.2 filtri	DH12E460 Euro4/5	338	460	09/06	>	S 4402 R			
	prefilter / prefiltrato	DH12E460 Euro4/5	338	460	09/06	>			S 4461 NR	
9700 (TX)		DH12D340	250	340	09/01	> 08/05	S 0900 R		S 9320 NR	
		DH12D340	250	340	09/05	> 09/06	S 0900 R		S 9320 NR	S 7337 A
	by-pass	DH12D340	250	340	09/01	> 09/06	S 4120 R			
	with automatic gearbox / con cambio automatico	DH12D340	250	340	09/01	> 09/06				S 5238 PE
	spheros aeroshere world SPHEROS / con climatizzatore sul tetto SPHEROS	DH12D340	250	340	09/01	> 09/06				S 3457 C
	dryer filter / filtro essiccatore	DH12D340	250	340	09/01	> 09/06				S 7259 A
	inner / interno	DH12D340	250	340	09/05	> 09/06				S 7A34 A
	LONG LIFE	DH12D340	250	340	09/01	> 09/06	S 4402 R			
9700 (TX)		DH12D380	280	380	09/01	> 08/05	S 0900 R		S 9320 NR	
		DH12D380	280	380	09/05	> 09/06	S 0900 R		S 9320 NR	S 7337 A
	by-pass	DH12D380	280	380	09/01	> 09/06	S 4120 R			
	with automatic gearbox / con cambio automatico	DH12D380	280	380	09/01	> 09/06				S 5238 PE
	spheros aeroshere world SPHEROS / con climatizzatore sul tetto SPHEROS	DH12D380	280	380	09/01	> 09/06				S 3457 C
	dryer filter / filtro essiccatore	DH12D380	280	380	09/01	> 09/06				S 7259 A
	inner / interno	DH12D380	280	380	09/05	> 09/06				S 7A34 A
	LONG LIFE	DH12D380	280	380	09/01	> 09/06	S 4402 R			
9700 (TX)		DH12D420	308	420	09/01	> 08/05	S 0900 R		S 9320 NR	
		DH12D420	308	420	09/05	> 09/06	S 0900 R		S 9320 NR	S 7337 A
	by-pass	DH12D420	308	420	09/01	> 09/06	S 4120 R			
	with automatic gearbox / con cambio automatico	DH12D420	308	420	09/01	> 09/06				S 5238 PE
	spheros aeroshere world SPHEROS / con climatizzatore sul tetto SPHEROS	DH12D420	308	420	09/01	> 09/06				S 3457 C
	dryer filter / filtro essiccatore	DH12D420	308	420	09/01	> 09/06				S 7259 A
	inner / interno	DH12D420	308	420	09/05	> 09/06				S 7A34 A
	LONG LIFE	DH12D420	308	420	09/01	> 09/06	S 4402 R			
9900	by-pass	DH12E340 Euro4/5	250	340	09/06	>			S 9320 NR	S 7337 A
	with automatic gearbox / con cambio automatico	DH12E340 Euro4/5	250	340	09/06	>	S 4120 R			S 5238 PE
	spheros aeroshere world SPHEROS / con climatizzatore sul tetto SPHEROS	DH12E340 Euro4/5	250	340	09/06	>				S 3457 C
	with filter Urea/Adblue / con filtro Urea/Adblue	DH12E340 Euro4/5	250	340	09/06	>				S 4401 U
	2 filters / N.2 filtri	DH12E340 Euro4/5	250	340	09/06	>	S 4402 R			
	prefilter / prefiltrato	DH12E340 Euro4/5	250	340	09/06	>			S 4461 NR	
9900	by-pass	DH12E380 Euro4/5	279	380	09/06	>			S 9320 NR	S 7337 A
	with automatic gearbox / con cambio automatico	DH12E380 Euro4/5	279	380	09/06	>	S 4120 R			S 5238 PE

V



KW HP



...VOLVO - buses/autobus

V	spheros aeroshere world SPHEROS / con climatizzatore sul tetto SPHEROS	DH12E380 Euro4/5	279	380	09/06 >				S 3457 C
	with filter Urea/Adblue / con filtro Urea/Adblue	DH12E380 Euro4/5	279	380	09/06 >				S 4401 U
	2 filters / N.2 filtri	DH12E380 Euro4/5	279	380	09/06 >	S 4402 R			
	prefilter / prefiltrato	DH12E380 Euro4/5	279	380	09/06 >		S 4461 NR		
	9900	DH12E420 Euro4/5	309	420	09/06 >		S 9320 NR	S 7337 A	
	by-pass	DH12E420 Euro4/5	309	420	09/06 >	S 4120 R			
	with automatic gearbox / con cambio automatico	DH12E420 Euro4/5	309	420	09/06 >				S 5238 PE
	spheros aeroshere world SPHEROS / con climatizzatore sul tetto SPHEROS	DH12E420 Euro4/5	309	420	09/06 >				S 3457 C
	with filter Urea/Adblue / con filtro Urea/Adblue	DH12E420 Euro4/5	309	420	09/06 >				S 4401 U
	2 filters / N.2 filtri	DH12E420 Euro4/5	309	420	09/06 >	S 4402 R			
	prefilter / prefiltrato	DH12E420 Euro4/5	309	420	09/06 >		S 4461 NR		
	9900	DH12E460 Euro4/5	338	460	09/06 >		S 9320 NR	S 7337 A	
	by-pass	DH12E460 Euro4/5	338	460	09/06 >	S 4120 R			
	with automatic gearbox / con cambio automatico	DH12E460 Euro4/5	338	460	09/06 >				S 5238 PE
	spheros aeroshere world / con climatizzatore sul tetto	DH12E460 Euro4/5	338	460	09/06 >				S 3457 C
	with filter Urea/Adblue / con filtro Urea/Adblue	DH12E460 Euro4/5	338	460	09/06 >				S 4401 U
	2 filters / N.2 filtri	DH12E460 Euro4/5	338	460	09/06 >	S 4402 R			
	prefilter / prefiltrato	DH12E460 Euro4/5	338	460	09/06 >		S 4461 NR		
	9900 (TX)	DH12D380	280	380	09/01 > 08/05	S 0900 R	S 9320 NR		
		DH12D380	280	380	09/05 > 09/06	S 0900 R	S 9320 NR	S 7337 A	
	by-pass	DH12D380	280	380	09/01 > 09/06	S 4120 R			
	spheros aeroshere world SPHEROS / con climatizzatore sul tetto SPHEROS	DH12D380	280	380	09/01 > 09/06				S 3457 C
	dryer filter / filtro essiccatore	DH12D380	280	380	09/01 > 09/06				S 7259 A
	inner / interno	DH12D380	280	380	09/05 > 09/06			S 7A34 A	
	LONG LIFE	DH12D380	280	380	09/01 > 09/06	S 4402 R			
	9900 (TX)	DH12D420	308	420	09/01 > 08/05	S 0900 R	S 9320 NR		
		DH12D420	308	420	09/05 > 09/06	S 0900 R	S 9320 NR	S 7337 A	
	by-pass	DH12D420	308	420	09/01 > 09/06	S 4120 R			
	spheros aeroshere world SPHEROS / con climatizzatore sul tetto SPHEROS	DH12D420	308	420	09/01 > 09/06				S 3457 C
	dryer filter / filtro essiccatore	DH12D420	308	420	09/01 > 09/06				S 7259 A
	inner / interno	DH12D420	308	420	09/05 > 09/06			S 7A34 A	
	LONG LIFE	DH12D420	308	420	09/01 > 09/06	S 4402 R			
B 10 Serie									
	B10B	THD101GC/GD				S 0900 R	S 4323 NR	S 0070 A	S 9006 AR
	by-pass	THD101GC/GD				S 4120 R			
	LONG LIFE	THD101GC/GD				S 4402 R			
	power steering / servosterzo	THD101GC/GD							S 3081 PO
	bleed / sfiato	THD101GC/GD							S 7092 A
	drive / trasmissione	THD101GC/GD							S 3257 R
	B10B	THD102KB/KD/KF				S 0900 R	S 4323 NR	S 0070 A	S 9006 AR
	by-pass	THD102KB/KD/KF				S 4120 R			
	LONG LIFE	THD102KB/KD/KF				S 4402 R			
	power steering / servosterzo	THD102KB/KD/KF							S 3081 PO
	bleed / sfiato	THD102KB/KD/KF							S 7092 A
	drive / trasmissione	THD102KB/KD/KF							S 3257 R
	B10B	THD103KB/KD/KF				S 0900 R	S 4323 NR	S 0070 A	S 9006 AR
	with automatic gearbox ZF HP500/590 / con cambio automatico ZF HP500/590	THD103KB/KD/KF							S 2234 Z
	LONG LIFE	THD103KB/KD/KF				S 4402 R			
	power steering / servosterzo	THD103KB/KD/KF							S 3081 PO
	bleed / sfiato	THD103KB/KD/KF							S 7092 A
	drive / trasmissione	THD103KB/KD/KF							S 3257 R
	B10K/M-NFH	DH10A			08/96 >	S 0900 R	S 5020 NR		
	by-pass	DH10A			08/96 >	S 4120 R			
	dryer filter / filtro essiccatore	DH10A			08/96 >				S 7259 A
	B10M	DH10A			08/95 > 12/00	S 0900 R		S 0070 A	S 9006 AR
	some outer / alcuni esterno	DH10A			08/95 > 12/00			S 7337 A	
	by-pass	DH10A			08/95 > 12/00	S 4120 R			
	dryer filter / filtro essiccatore	DH10A			08/95 > 12/00				S 7259 A
	inner / interno	DH10A			08/95 > 12/00			S 7A34 A	
	2 filters / N.2 filtri	DH10A			08/95 > 12/00		S 4323 NR		
	B10M	THD100DC/DD				S 5800 R	S 4323 NR	S 0070 A	S 9006 AR
	to frame No. 39999 / a telaio N. 39999	THD100DC/DD				S 5800 R	S 4323 NR	S 7337 A	S 9006 AR
	from frame No. 40000 / da telaio N. 40000	THD100DC/DD							S 3081 PO
	power steering (Ø 60) / servosterzo (Ø 60)	THD100DC/DD							S 8790 PO
	power steering (Ø 80) / servosterzo (Ø 80)	THD100DC/DD							S 3257 R
	drive (G7 EGS, G8 MGS) / trasmissione (G7 EGS, G8 MGS)	THD100DC/DD							S 3301 PO
	drive ALLISON / trasmissione ALLISON	THD100DC/DD							



KW HP



...VOLVO - buses/autobus

B10M							
to frame No. 39999 / a telaio N. 39999	THD100EA/EB/EC/ED/EE/EK	10/79 >	S 5800 R		S 0070 A	✗	
from frame No. 40000 / da telaio N. 40000	THD100EA/EB/EC/ED/EE/EK	> 10/85	S 5800 R		S 7337 A	✗	
water filter / filtro acqua	THD100EA/EB/EC/ED/EE/EK	10/79 > 10/85				S 9006 AR	
inner / interno	THD100EA/EB/EC/ED/EE/EK	10/79 > 10/85			S 7A34 A		
2 filters / N.2 filtri	THD100EA/EB/EC/ED/EE/EK	10/79 > 10/85		S 4323 NR			
power steering (Ø 60) / servosterzo (Ø 60)	THD100EA/EB/EC/ED/EE/EK	10/79 > 10/85				S 3081 PO	
power steering (Ø 80) / servosterzo (Ø 80)	THD100EA/EB/EC/ED/EE/EK	10/79 > 10/85				S 8790 PO	
drive (G7 EGS, G8 MGS) / trasmissione (G7 EGS, G8 MGS)	THD100EA/EB/EC/ED/EE/EK	10/79 > 10/85				S 3257 R	
drive ALLISON / trasmissione ALLISON	THD100EA/EB/EC/ED/EE/EK	10/79 > 10/85				S 3301 PO	
B10M	THD101GB/GC/GD/KC/KE/KF	06/81 > 06/94				✗	
to frame No. 39999 / a telaio N. 39999	THD101GB/GC/GD/KC/KE/KF	06/81 >	S 0900 R		S 0070 A	S 9006 AR	
by-pass	THD101GB/GC/GD/KC/KE/KF	06/81 > 08/99	S 4120 R				
from frame No. 40000 / da telaio N. 40000	THD101GB/GC/GD/KC/KE/KF	> 08/99	S 0900 R		S 7337 A	S 9006 AR	
2 filters / N.2 filtri	THD101GB/GC/GD/KC/KE/KF	06/81 > 08/99		S 4323 NR			
power steering (Ø 60) / servosterzo (Ø 60)	THD101GB/GC/GD/KC/KE/KF	06/81 > 08/99				S 3081 PO	
power steering (Ø 80) / servosterzo (Ø 80)	THD101GB/GC/GD/KC/KE/KF	06/81 > 08/99				S 8790 PO	
drive (G7 EGS, G8 MGS) / trasmissione (G7 EGS, G8 MGS)	THD101GB/GC/GD/KC/KE/KF	06/81 > 08/99				S 3257 R	
B10M	THD102KA/KB/KD/KF	06/81 > 08/99				✗	
to frame No. 39999 / a telaio N. 39999	THD102KA/KB/KD/KF	06/81 >	S 0900 R		S 0070 A	S 9006 AR	
by-pass	THD102KA/KB/KD/KF	06/81 > 08/99	S 4120 R				
from frame No. 40000 / da telaio N. 40000	THD102KA/KB/KD/KF	> 08/99	S 0900 R		S 7337 A	S 9006 AR	
2 filters / N.2 filtri	THD102KA/KB/KD/KF	06/81 > 08/99		S 4323 NR			
power steering (Ø 60) / servosterzo (Ø 60)	THD102KA/KB/KD/KF	06/81 > 08/99				S 3081 PO	
power steering (Ø 80) / servosterzo (Ø 80)	THD102KA/KB/KD/KF	06/81 > 08/99				S 8790 PO	
drive (G7 EGS, G8 MGS) / trasmissione (G7 EGS, G8 MGS)	THD102KA/KB/KD/KF	06/81 > 08/99				S 3257 R	
B10M	THD103KB/KD/KF	249 340	07/92 >				
to frame No. 39999 / a telaio N. 39999	THD103KB/KD/KF	249 340	> 12/01		S 0070 A	S 9006 AR	
from frame No. 40000 / da telaio N. 40000	THD103KB/KD/KF	249 340	> 12/01		S 7337 A	S 9006 AR	
inner / interno	THD103KB/KD/KF	249 340	07/92 > 12/01		S 7A34 A		
LONG LIFE 2 filters / LONG LIFE N.2 filtri	THD103KB/KD/KF	249 340	07/92 > 12/01	S 4402 R			
2 filters / N.2 filtri	THD103KB/KD/KF	249 340	07/92 > 12/01	S 0900 R	S 4323 NR		
power steering (Ø 60) / servosterzo (Ø 60)	THD103KB/KD/KF	249 340	07/92 > 12/01			S 3081 PO	
power steering (Ø 80) / servosterzo (Ø 80)	THD103KB/KD/KF	249 340	07/92 > 12/01			S 8790 PO	
drive (G7 EGS, G8 MGS) / trasmissione (G7 EGS, G8 MGS)	THD103KB/KD/KF	249 340	07/92 > 12/01			S 3257 R	
B10R	THD100DA/DB/DC/DD	06/78 > 09/92	S 5800 R			✗	
with automatic gearbox ZF 4HP500 / con cambio automatico ZF 4HP500	THD100DA/DB/DC/DD	06/78 > 09/92				S 2234 Z	
from frame No. 4173 / da telaio N. 4173	THD100DA/DB/DC/DD	> 09/92			S 0070 A		
2 filters / N.2 filtri	THD100DA/DB/DC/DD	06/78 > 09/92		S 4323 NR			
power steering (Ø 60) / servosterzo (Ø 60)	THD100DA/DB/DC/DD	06/78 > 09/92				S 3081 PO	
power steering (Ø 80) / servosterzo (Ø 80)	THD100DA/DB/DC/DD	06/78 > 09/92				S 8790 PO	
drive ALLISON / trasmissione ALLISON	THD100DA/DB/DC/DD	06/78 > 09/92				S 3301 PO	
B10R	THD100EB/EC	06/78 > 09/92	S 5800 R			✗	
with automatic gearbox ZF 4HP500 / con cambio automatico ZF 4HP500	THD100EB/EC	06/78 > 09/92				S 2234 Z	
from frame No. 4173 / da telaio N. 4173	THD100EB/EC	> 09/92			S 0070 A		
power steering (Ø 60) / servosterzo (Ø 60)	THD100EB/EC	06/78 > 09/92				S 3081 PO	
power steering (Ø 80) / servosterzo (Ø 80)	THD100EB/EC	06/78 > 09/92				S 8790 PO	
drive ALLISON / trasmissione ALLISON	THD100EB/EC	06/78 > 09/92				S 3301 PO	
B10R	THD102K/KF	06/78 > 09/92	S 5800 R			✗	
with automatic gearbox ZF 4HP500 / con cambio automatico ZF 4HP500	THD102K/KF	06/78 > 09/92				S 2234 Z	
from frame No. 4173 / da telaio N. 4173	THD102K/KF	> 09/92			S 0070 A		
2 filters / N.2 filtri	THD102K/KF	06/78 > 09/92		S 4323 NR			
power steering (Ø 60) / servosterzo (Ø 60)	THD102K/KF	06/78 > 09/92				S 3081 PO	
power steering (Ø 80) / servosterzo (Ø 80)	THD102K/KF	06/78 > 09/92				S 8790 PO	
drive ALLISON / trasmissione ALLISON	THD102K/KF	06/78 > 09/92				S 3301 PO	
B 12 Serie							
B12	D12A	08/96 >		S 5020 NR	S 7337 A	S 9006 AR	
by-pass	D12A	08/96 >	S 4120 R				
with automatic gearbox ZF HP500/590 / con cambio automatico ZF HP500/590	D12A	08/96 >				S 2234 Z	
inner / interno	D12A	08/96 >			S 7A34 A		
LONG LIFE 2 filters / LONG LIFE N.2 filtri	D12A	08/96 >	S 4402 R				
2 filters / N.2 filtri	D12A	08/96 >	S 0900 R				
power steering / servosterzo	D12A	08/96 >				S 3081 PO	
B12	TD122FH/FL	09/91 > 09/96			S 7337 A	S 9006 AR	
by-pass	TD122FH/FL	09/91 > 09/96	S 4120 R				
with automatic gearbox ZF HP500/590 / con cambio automatico ZF HP500/590	TD122FH/FL	09/91 > 09/96				S 2234 Z	
inner / interno	TD122FH/FL	09/91 > 09/96			S 7A34 A		

V





kW HP



...VOLVO - buses/autobus

LONG LIFE 2 filters / LONG LIFE N.2 filtri	TD122FH/FL			09/91 >	09/96	S 4402 R			
2 filters / N.2 filtri	TD122FH/FL			09/91 >	09/96	S 0900 R	S 4323 NR		
power steering / servosterzo	TD122FH/FL			09/91 >	09/96				S 3081 PO
bleed / sfiato	TD122FH/FL			09/91 >	09/96				S 7092 A
drive / trasmissione	TD122FH/FL			09/91 >	09/96				S 3257 R
B12	TD123E/ES			09/91 >	09/96			S 7337 A	S 9006 AR
by-pass	TD123E/ES			09/91 >	09/96	S 4120 R			
with automatic gearbox ZF HP500/590 / con cambio automatico ZF HP500/590	TD123E/ES			09/91 >	09/96				S 2234 Z
inner / interno	TD123E/ES			09/91 >	09/96			S 7A34 A	
LONG LIFE 2 filters / LONG LIFE N.2 filtri	TD123E/ES			09/91 >	09/96	S 4402 R			
2 filters / N.2 filtri	TD123E/ES			09/91 >	09/96	S 0900 R	S 4323 NR		
power steering / servosterzo	TD123E/ES			09/91 >	09/96				S 3081 PO
bleed / sfiato	TD123E/ES			09/91 >	09/96				S 7092 A
drive / trasmissione	TD123E/ES			09/91 >	09/96				S 3257 R
B12M	DH12C	249	340	09/00 >			S 5020 NR	S 7337 A	S 9006 AR
by-pass	DH12C	249	340	09/00 >		S 4120 R			
with automatic gearbox ZF HP500/590 / con cambio automatico ZF HP500/590	DH12C	249	340	09/00 >					S 2234 Z
inner / interno	DH12C	249	340	09/00 >				S 7A34 A	
LONG LIFE 2 filters / LONG LIFE N.2 filtri	DH12C	249	340	09/00 >		S 4402 R			
2 filters / N.2 filtri	DH12C	249	340	09/00 >		S 0900 R			
power steering / servosterzo	DH12C	249	340	09/00 >					S 3081 PO
B 1200 Serie									
B1200	D70B					S 5800 R	S 4323 NR		
B 13 Serie									
B13R	DH13C460 E5	338	460	09/09 >			S 9320 NR	S 7337 A	S 9006 AR
by-pass	DH13C460 E5	338	460	09/09 >		S 4120 R			
with automatic gearbox / con cambio automatico	DH13C460 E5	338	460	09/09 >					S 5238 PE
with air-conditioner SUETRAK / con climatizzatore SUETRAK	DH13C460 E5	338	460	09/09 >					S 3445 C
with filter AdBlue/SCR Denoxtronic 1 / con filtro AdBlue/SCR Denoxtronic 1	DH13C460 E5	338	460	09/09 >					S 4401 U
with filter AdBlue/SCR Denoxtronic 2 / con filtro AdBlue/SCR Denoxtronic 2	DH13C460 E5	338	460	09/09 >					S 4402 U
dryer filter / filtro essiccatore	DH13C460 E5	338	460	09/09 >					S 7A66 A
LONG LIFE	DH13C460 E5	338	460	09/09 >			S 4120 NR		
2 filters / N.2 filtri	DH13C460 E5	338	460	09/09 >		S 4402 R			
prefilter short filter / prefiltra filtro corto	DH13C460 E5	338	460	09/09 >			S 4157 NR		
prefilter long filter / prefiltra filtro lungo	DH13C460 E5	338	460	09/09 >			S 4461 NR		
hydraulic drive with automatic gearbox / trasmissione idraulica con cambio automatico	DH13C460 E5	338	460	09/09 >					S 5238 PE
B 5 Serie									
B5 LH									
with automatic gearbox / con cambio automatico	D5K240	177	240	09/13 >					S 5238 PE
B5 TL									
with automatic gearbox / con cambio automatico	D5K240	177	240	09/13 >					S 5238 PE
B 54 Serie									
B54									
to engine No. 21065 / a motore N. 21065	D50, TD50					S 5800 R	S 1411 N	S 4450 A	
from engine No. 21066 / da motore N. 21066	D50, TD50					S 5800 R	S 4323 NR	S 4450 A	
power steering (Ø 80) / servosterzo (Ø 80)	D50, TD50								S 8790 PO
B 55 Serie									
B55 Ailsa									
from frame No. 80040 / da telaio N. 80040	TD70H					S 0900 R	S 4323 NR		
B 57 Serie									
B57	D70/A, TD70/A					S 5800 R	S 7111 NC	S 7281 A	
power steering (Ø 80) / servosterzo (Ø 80)	D70/A, TD70/A								S 8790 PO
B57	D70B, TD70B, TD70E					S 5800 R	S 4323 NR	S 7281 A	
power steering (Ø 80) / servosterzo (Ø 80)	D70B, TD70B, TD70E								S 8790 PO
B57	TD70H/HA					S 0900 R	S 4323 NR	S 7281 A	
power steering (Ø 80) / servosterzo (Ø 80)	TD70H/HA								S 8790 PO
BB57	D70/A, TD70/A					S 5800 R	S 7111 NC	S 7281 A	
power steering (Ø 80) / servosterzo (Ø 80)	D70/A, TD70/A								S 8790 PO
BB57	D70B, TD70B, TD70E					S 5800 R	S 4323 NR	S 7281 A	
power steering (Ø 80) / servosterzo (Ø 80)	D70B, TD70B, TD70E								S 8790 PO
BB57	TD70H/HA					S 0900 R	S 4323 NR	S 7281 A	
power steering (Ø 80) / servosterzo (Ø 80)	TD70H/HA								S 8790 PO
B 58 Serie									
B58									
to engine No. 2631 / a motore N. 2631	HD100/A, THD100/A					S 5800 R	S 1411 N		
to frame No. 9764 / a telaio N. 9764	HD100/A, THD100/A					S 5800 R		S 7281 A	
to frame No. 9765 / a telaio N. 9765	HD100/A, THD100/A					S 5800 R		S 7276 A	



kW HP



...VOLVO - buses/autobus

from engine No. 2632 / da motore N. 2632 power steering (Ø 80) / servosterzo (Ø 80)	HD100/A, THD100/A HD100/A, THD100/A		S 5800 R	S 4323 NR		S 8790 PO
B58E						
to engine No. 2631 / a motore N. 2631 to frame No. 9764 / a telaio N. 9764 to frame No. 9765 / a telaio N. 9765 from engine No. 2632 / da motore N. 2632 power steering (Ø 80) / servosterzo (Ø 80)	HD100/A, THD100/A HD100/A, THD100/A HD100/A, THD100/A HD100/A, THD100/A HD100/A, THD100/A		S 5800 R S 5800 R S 5800 R S 5800 R	S 1411 N S 4323 NR	S 7281 A S 7276 A	S 8790 PO
B58T						
to engine No. 2631 / a motore N. 2631 to frame No. 9764 / a telaio N. 9764 to frame No. 9765 / a telaio N. 9765 from engine No. 2632 / da motore N. 2632 power steering (Ø 80) / servosterzo (Ø 80)	HD100/A, THD100/A HD100/A, THD100/A HD100/A, THD100/A HD100/A, THD100/A HD100/A, THD100/A		S 5800 R S 5800 R S 5800 R S 5800 R	S 1411 N S 4323 NR	S 7281 A S 7276 A	S 8790 PO
B 59 Serie						
B59						
to frame No. 1442/2073 / a telaio N. 1442/2073 from frame No. 1443/2074 / da telaio N. 1443/2074 power steering (Ø 80) / servosterzo (Ø 80)	THD100, THD100A THD100, THD100A THD100, THD100A		S 5800 R S 5800 R	S 4323 NR S 4323 NR	S 7281 A S 7276 A	S 8790 PO
B59T						
to frame No. 1442/2073 / a telaio N. 1442/2073 from frame No. 1443/2074 / da telaio N. 1443/2074 power steering (Ø 80) / servosterzo (Ø 80)	THD100, THD100A THD100, THD100A THD100, THD100A		S 5800 R S 5800 R	S 4323 NR S 4323 NR	S 7281 A S 7276 A	S 8790 PO
B 6 Serie						
B6						
to engine No. 47589 / a motore N. 47589 from engine No. 47590 / da motore N. 47590 power steering (Ø 80) / servosterzo (Ø 80) bleed / sfiato	D60A, TD60A/B D60A, TD60A/B D60A, TD60A/B D60A, TD60A/B		S 5800 R S 0900 R	S 4323 NR S 4323 NR		S 8790 PO S 7091 A
B6						
by-pass	D6A D6A	03/96 > 03/96 >	S 0900 R S 4120 R	S 4323 NR		
B6 (telaio/chassis N.5000 -)						
power steering / servosterzo bleed / sfiato	TD63E TD63E TD63E		S 0900 R	S 4323 NR	S 0070 A	S 3081 PO S 7092 A
B6 (telaio/chassis N.5000 -)						
power steering / servosterzo bleed / sfiato	TD63ES TD63ES TD63ES		S 0900 R		S 0070 A	S 3081 PO S 7092 A
B6F						
to engine No. 47589 / a motore N. 47589 with automatic gearbox ZF 4HP500 / con cambio automatico ZF 4HP500 from engine No. 47590 / da motore N. 47590 power steering (Ø 80) / servosterzo (Ø 80) bleed / sfiato	D60A, TD60A/B/C 132 180 D60A, TD60A/B/C 132 180 D60A, TD60A/B/C 132 180 D60A, TD60A/B/C 132 180 D60A, TD60A/B/C 132 180	11/78 > 10/80 11/78 > 12/95 11/80 > 12/95 11/78 > 12/95 11/78 > 12/95	S 5800 R S 0900 R	S 4323 NR S 4323 NR		✗ S 2234 Z ✗ S 8790 PO S 7091 A
B6R						
by-pass with automatic gearbox ZF 4HP500 / con cambio automatico ZF 4HP500 inner / interno 2 filters / N.2 filtri power steering / servosterzo	D6A180, TD63E 132 180 D6A180, TD63E 132 180 D6A180, TD63E 132 180 D6A180, TD63E 132 180 D6A180, TD63E 132 180	11/91 > 11/91 > 11/91 > 11/91 > 11/91 >	S 0900 R S 4120 R		S 0070 A	S 9006 AR S 2234 Z S 7A34 A
B6R						
by-pass with automatic gearbox ZF 4HP500 / con cambio automatico ZF 4HP500 inner / interno 2 filters / N.2 filtri power steering / servosterzo	D6A210, TD63ES 154 210 D6A210, TD63ES 154 210 D6A210, TD63ES 154 210 D6A210, TD63ES 154 210 D6A210, TD63ES 154 210	11/91 > 11/91 > 11/91 > 11/91 > 11/91 >	S 0900 R S 4120 R		S 0070 A	S 9006 AR S 2234 Z S 7A34 A
B6RLE						
by-pass with automatic gearbox ZF 4HP500 / con cambio automatico ZF 4HP500 inner / interno 2 filters / N.2 filtri power steering / servosterzo	D6A180, TD63E 132 180 D6A180, TD63E 132 180 D6A180, TD63E 132 180 D6A180, TD63E 132 180 D6A180, TD63E 132 180	11/91 > 11/91 > 11/91 > 11/91 > 11/91 >	S 0900 R S 4120 R		S 0070 A	S 9006 AR S 2234 Z S 7A34 A
B6RLE						
by-pass with automatic gearbox ZF 4HP500 / con cambio automatico ZF 4HP500 inner / interno 2 filters / N.2 filtri power steering / servosterzo	D6A210, TD63ES 154 210 D6A210, TD63ES 154 210 D6A210, TD63ES 154 210 D6A210, TD63ES 154 210 D6A210, TD63ES 154 210	11/91 > 11/91 > 11/91 > 11/91 > 11/91 >	S 0900 R S 4120 R		S 0070 A	S 9006 AR S 2234 Z S 7A34 A

V





KW HP



...VOLVO - buses/autobus

B 615 Serie							
B615	D67A				S 8381 NC		
B 635 Serie							
B635	VDF, D96AS, D96B				S 0201 N		
1st passage / 1.passaggio	VDF, D96AS, D96B				S 0101 N		
2nd passage / 2.passaggio	VDF, D96AS, D96B				S 1411 N		
2nd passage / 2.passaggio	VDF, D96AS, D96B				S 7411 N		
B 655 Serie							
B655					S 0201 N		
2nd passage / 2.passaggio					S 1411 N		
B 7 Serie							
B7	D70, TD70				S 5800 R	S 7111 NC	S 7281 A
power steering (Ø 60) / servosterzo (Ø 60)	D70, TD70						S 3081 PO
power steering (Ø 80) / servosterzo (Ø 80)	D70, TD70						S 8790 PO
bleed / sfiato	D70, TD70						S 7091 A
bleed / sfiato	D70, TD70						S 7092 A
B7	TD70A/B/H/HA				S 0900 R	S 4323 NR	
power steering (Ø 60) / servosterzo (Ø 60)	TD70A/B/H/HA						S 3081 PO
power steering (Ø 80) / servosterzo (Ø 80)	TD70A/B/H/HA						S 8790 PO
bleed / sfiato	TD70A/B/H/HA						S 7091 A
bleed / sfiato	TD70A/B/H/HA						S 7092 A
B7	TD71G				S 0900 R	S 4323 NR	
power steering (Ø 80) / servosterzo (Ø 80)	TD71G						S 8790 PO
B7F	TD70A/B/H/HA				S 0900 R	S 4323 NR	
power steering (Ø 60) / servosterzo (Ø 60)	TD70A/B/H/HA						S 3081 PO
power steering (Ø 80) / servosterzo (Ø 80)	TD70A/B/H/HA						S 8790 PO
bleed / sfiato	TD70A/B/H/HA						S 7092 A
bleed / sfiato	TD70A/B/H/HA						S 7091 A
B7FA	TD70A/B/H/HA				S 0900 R	S 4323 NR	
power steering (Ø 60) / servosterzo (Ø 60)	TD70A/B/H/HA						S 3081 PO
power steering (Ø 80) / servosterzo (Ø 80)	TD70A/B/H/HA						S 8790 PO
bleed / sfiato	TD70A/B/H/HA						S 7091 A
bleed / sfiato	TD70A/B/H/HA						S 7092 A
B7L	D7C	08/99 >			S 0900 R	S 5020 NR	
by-pass	D7C	08/99 >			S 4120 R		
B7R	D7E-290 Euro 4/5	213 290	09/06 >		S 5097 PE		S 7347 A
with filter AdBlue/SCR Denoxtronic 1 / con filtro AdBlue/SCR Denoxtronic 1	D7E-290 Euro 4/5	213 290	09/06 >				S 4401 U
inner / interno	D7E-290 Euro 4/5	213 290	09/06 >				S 7484 A
B7R	D7E-340 Euro 4/5	250 340	09/06 >		S 5097 PE		S 7347 A
with automatic gearbox / con cambio automatico	D7E-340 Euro 4/5	250 340	09/06 >				S 5238 PE
with filter AdBlue/SCR Denoxtronic 1 / con filtro AdBlue/SCR Denoxtronic 1	D7E-340 Euro 4/5	250 340	09/06 >				S 4401 U
inner / interno	D7E-340 Euro 4/5	250 340	09/06 >				S 7484 A
B7RLE	D7E-290 Euro 4/5	213 290	09/06 >		S 5097 PE		S 7347 A
with automatic gearbox / con cambio automatico	D7E-290 Euro 4/5	213 290	09/06 >				S 5238 PE
with filter AdBlue/SCR Denoxtronic 1 / con filtro AdBlue/SCR Denoxtronic 1	D7E-290 Euro 4/5	213 290	09/06 >				S 4401 U
inner / interno	D7E-290 Euro 4/5	213 290	09/06 >				S 7484 A
B7RLE	D7E-340 Euro 4/5	250 340	09/06 >		S 5097 PE		S 7347 A
with automatic gearbox / con cambio automatico	D7E-340 Euro 4/5	250 340	09/06 >				S 5238 PE
with filter AdBlue/SCR Denoxtronic 1 / con filtro AdBlue/SCR Denoxtronic 1	D7E-340 Euro 4/5	250 340	09/06 >				S 4401 U
inner / interno	D7E-340 Euro 4/5	250 340	09/06 >				S 7484 A
B 705 Serie							
B705	TD47A					S 7411 N	
B 715 Serie							
B715	D67A					S 8381 NC	
B 725 Serie							
B725						S 0201 N	
2nd passage / 2.passaggio						S 1411 N	
B 755 Serie							
B755						S 0201 N	
2nd passage / 2.passaggio						S 1411 N	
B 8 Serie							
B8R	D8K E6	206 280	09/13 >				S 5238 PE
with automatic gearbox / con cambio automatico	D8K E6	206 280	09/13 >				S 5238 PE
B8R	D8K E6	235 320	09/13 >				S 5238 PE
with automatic gearbox / con cambio automatico	D8K E6	235 320	09/13 >				S 5238 PE
B8R	D8K E6	257 350	09/13 >				S 5238 PE
with automatic gearbox / con cambio automatico	D8K E6	257 350	09/13 >				S 5238 PE

**KW HP****...VOLVO - buses/autobus**

B8RLE with automatic gearbox / con cambio automatico	D8K E6	206 280	09/13 >				S 5238 PE
B8RLE with automatic gearbox / con cambio automatico	D8K E6	235 320	09/13 >				S 5238 PE
B8RLE with automatic gearbox / con cambio automatico	D8K E6	257 350	09/13 >				S 5238 PE
B 9 Serie							
B9L some / alcuni	D9B-260	191 260	09/06 >		S 9320 NR	S 7337 A	S 9006 AR
by-pass	D9B-260	191 260	06/10 >	S 4120 R		S 7A29 A	
with automatic gearbox / con cambio automatico	D9B-260	191 260	09/06 >				S 5238 PE
with filter AdBlue/SCR Denoxtronic 1 / con filtro AdBlue/SCR Denoxtronic 1	D9B-260	191 260	09/06 >				S 4401 U
dryer filter / filtro essiccatore	D9B-260	191 260	09/06 >				S 7A66 A
LONG LIFE	D9B-260	191 260	09/06 >		S 4120 NR		
2 filters / N.2 filtri	D9B-260	191 260	09/06 >	S 4402 R			
prefilter / prefiltra	D9B-260	191 260	09/06 >		S 4461 NR		
B9L some / alcuni	D9B-310	226 310	09/06 >		S 9320 NR	S 7337 A	S 9006 AR
by-pass	D9B-310	226 310	06/10 >	S 4120 R		S 7A29 A	
with automatic gearbox / con cambio automatico	D9B-310	226 310	09/06 >				S 5238 PE
with filter AdBlue/SCR Denoxtronic 1 / con filtro AdBlue/SCR Denoxtronic 1	D9B-310	226 310	09/06 >				S 4401 U
dryer filter / filtro essiccatore	D9B-310	226 310	09/06 >				S 7A66 A
LONG LIFE	D9B-310	226 310	09/06 >		S 4120 NR		
2 filters / N.2 filtri	D9B-310	226 310	09/06 >	S 4402 R			
prefilter / prefiltra	D9B-310	226 310	09/06 >		S 4461 NR		
B9M inner / interno	THD100DC/DD/EA/EB/EC		08/82 > 07/94	S 5800 R	S 4323 NR	S 0070 A	S 9006 AR
power steering (Ø 60) / servosterzo (Ø 60)	THD100DC/DD/EA/EB/EC		08/82 > 07/94			S 7A34 A	
power steering (Ø 80) / servosterzo (Ø 80)	THD100DC/DD/EA/EB/EC		08/82 > 07/94				S 3081 PO
drive (G7 EGS, G8 MGS) / trasmissione (G7 EGS, G8 MGS)	THD100DC/DD/EA/EB/EC		08/82 > 07/94				S 8790 PO
drive ALLISON / trasmissione ALLISON	THD100DC/DD/EA/EB/EC		08/82 > 07/94				S 3257 R
B9M with automatic gearbox / con cambio automatico	THD100ED/EE/EK		08/82 > 07/94	S 5800 R	S 4323 NR	S 0070 A	S 9006 AR
inner / interno	THD100ED/EE/EK		08/82 > 07/94			S 7A34 A	S 5238 PE
power steering (Ø 60) / servosterzo (Ø 60)	THD100ED/EE/EK		08/82 > 07/94				S 3081 PO
power steering (Ø 80) / servosterzo (Ø 80)	THD100ED/EE/EK		08/82 > 07/94				S 8790 PO
drive (G7 EGS, G8 MGS) / trasmissione (G7 EGS, G8 MGS)	THD100ED/EE/EK		08/82 > 07/94				S 3257 R
drive ALLISON / trasmissione ALLISON	THD100ED/EE/EK		08/82 > 07/94				S 3301 PO
B9M by-pass	THD101GB/GC/GD		08/82 > 07/94	S 0900 R	S 4323 NR	S 0070 A	S 9006 AR
with automatic gearbox / con cambio automatico	THD101GB/GC/GD		08/82 > 07/94	S 4120 R			S 5238 PE
inner / interno	THD101GB/GC/GD		08/82 > 07/94			S 7A34 A	
power steering (Ø 60) / servosterzo (Ø 60)	THD101GB/GC/GD		08/82 > 07/94				S 3081 PO
power steering (Ø 80) / servosterzo (Ø 80)	THD101GB/GC/GD		08/82 > 07/94				S 8790 PO
drive (G7 EGS, G8 MGS) / trasmissione (G7 EGS, G8 MGS)	THD101GB/GC/GD		08/82 > 07/94				S 3257 R
B9M by-pass	THD101KC/KE/KF		08/82 > 07/94	S 0900 R	S 4323 NR	S 0070 A	S 9006 AR
inner / interno	THD101KC/KE/KF		08/82 > 07/94	S 4120 R		S 7A34 A	
power steering (Ø 60) / servosterzo (Ø 60)	THD101KC/KE/KF		08/82 > 07/94				S 3081 PO
power steering (Ø 80) / servosterzo (Ø 80)	THD101KC/KE/KF		08/82 > 07/94				S 8790 PO
drive (G7 EGS, G8 MGS) / trasmissione (G7 EGS, G8 MGS)	THD101KC/KE/KF		08/82 > 07/94				S 3257 R
B9M by-pass	THD102KA/KB/KD/KF		08/82 > 07/94	S 0900 R	S 4323 NR	S 0070 A	S 9006 AR
with automatic gearbox / con cambio automatico	THD102KA/KB/KD/KF		08/82 > 07/94	S 4120 R			S 5238 PE
inner / interno	THD102KA/KB/KD/KF		08/82 > 07/94			S 7A34 A	
power steering (Ø 60) / servosterzo (Ø 60)	THD102KA/KB/KD/KF		08/82 > 07/94				S 3081 PO
power steering (Ø 80) / servosterzo (Ø 80)	THD102KA/KB/KD/KF		08/82 > 07/94				S 8790 PO
drive (G7 EGS, G8 MGS) / trasmissione (G7 EGS, G8 MGS)	THD102KA/KB/KD/KF		08/82 > 07/94				S 3257 R
B9M by-pass	THD103KB/KD/KF		08/90 > 06/96	S 0900 R	S 4323 NR	S 0070 A	S 9006 AR
with automatic gearbox / con cambio automatico	THD103KB/KD/KF		08/90 > 06/96	S 4120 R			S 5238 PE
inner / interno	THD103KB/KD/KF		08/90 > 06/96			S 7A34 A	
power steering (Ø 60) / servosterzo (Ø 60)	THD103KB/KD/KF		08/90 > 06/96				S 3081 PO
power steering (Ø 80) / servosterzo (Ø 80)	THD103KB/KD/KF		08/90 > 06/96				S 8790 PO
drive (G7 EGS, G8 MGS) / trasmissione (G7 EGS, G8 MGS)	THD103KB/KD/KF		08/90 > 06/96				S 3257 R
B9M by-pass	THD104KB/KF		08/90 > 06/96	S 0900 R	S 4323 NR	S 0070 A	S 9006 AR
	THD104KB/KF		08/90 > 06/96	S 4120 R			

V



KW HP



...VOLVO - buses/autobus

with automatic gearbox / con cambio automatico	THD104KB/KF			08/90 > 06/96				S 5238 PE
inner / interno	THD104KB/KF			08/90 > 06/96			S 7A34 A	
power steering (Ø 60) / servosterzo (Ø 60)	THD104KB/KF			08/90 > 06/96				S 3081 PO
power steering (Ø 80) / servosterzo (Ø 80)	THD104KB/KF			08/90 > 06/96				S 8790 PO
drive (G7 EGS, G8 MGS) / trasmissione (G7 EGS, G8 MGS)	THD104KB/KF			08/90 > 06/96				S 3257 R
B9R Elegance	D9A-340	250	340	10/06 >		S 9320 NR	S 7337 A	S 9006 AR
by-pass	D9A-340	250	340	10/06 >	S 4120 R			
with automatic gearbox / con cambio automatico	D9A-340	250	340	10/06 >				S 5238 PE
dryer filter WABCO / filtro essiccatore WABCO	D9A-340	250	340	10/06 >				S 7A66 A
LONG LIFE	D9A-340	250	340	10/06 >		S 4120 NR		
2 filters / N.2 filtri	D9A-340	250	340	10/06 >	S 4402 R			
prefilter / prefiltrato	D9A-340	250	340	10/06 >		S 4461 NR		
B9R Elegance	D9A-380	279	380	10/06 >		S 9320 NR	S 7337 A	S 9006 AR
by-pass	D9A-380	279	380	10/06 >	S 4120 R			
with automatic gearbox / con cambio automatico	D9A-380	279	380	10/06 >				S 5238 PE
dryer filter WABCO / filtro essiccatore WABCO	D9A-380	279	380	10/06 >				S 7A66 A
LONG LIFE	D9A-380	279	380	10/06 >		S 4120 NR		
2 filters / N.2 filtri	D9A-380	279	380	10/06 >	S 4402 R			
prefilter / prefiltrato	D9A-380	279	380	10/06 >		S 4461 NR		
B9TL	D9B-260	191	260	09/06 >		S 9320 NR	S 7337 A	S 9006 AR
some / alcuni	D9B-260	191	260	06/10 >			S 7A29 A	
by-pass	D9B-260	191	260	09/06 >	S 4120 R			
with automatic gearbox / con cambio automatico	D9B-260	191	260	09/06 >				S 5238 PE
with filter AdBlue/SCR Denoxtronic 1 / con filtro AdBlue/SCR Denoxtronic 1	D9B-260	191	260	09/06 >				S 4401 U
dryer filter / filtro essiccatore	D9B-260	191	260	09/06 >				S 7A66 A
LONG LIFE	D9B-260	191	260	09/06 >		S 4120 NR		
2 filters / N.2 filtri	D9B-260	191	260	09/06 >	S 4402 R			
prefilter / prefiltrato	D9B-260	191	260	09/06 >		S 4461 NR		
B9TL	D9B-310	226	310	09/06 >		S 9320 NR	S 7337 A	S 9006 AR
some / alcuni	D9B-310	226	310	06/10 >			S 7A29 A	
by-pass	D9B-310	226	310	09/06 >	S 4120 R			
with automatic gearbox / con cambio automatico	D9B-310	226	310	09/06 >				S 5238 PE
with filter AdBlue/SCR Denoxtronic 1 / con filtro AdBlue/SCR Denoxtronic 1	D9B-310	226	310	09/06 >				S 4401 U
dryer filter / filtro essiccatore	D9B-310	226	310	09/06 >				S 7A66 A
LONG LIFE	D9B-310	226	310	09/06 >		S 4120 NR		
2 filters / N.2 filtri	D9B-310	226	310	09/06 >	S 4402 R			
prefilter / prefiltrato	D9B-310	226	310	09/06 >		S 4461 NR		
C 10 Serie								
C10M	THD101GD	202	276	10/81 > 12/87	S 0900 R	S 4323 NR	S 0070 A	S 3051 A
by-pass	THD101GD	202	276	10/81 > 12/87	S 4120 R			
power steering / servosterzo	THD101GD	202	276	10/81 > 12/87				S 3081 PO
C10M	THD101KC	228	310	10/81 > 12/85	S 0900 R	S 4323 NR	S 0070 A	S 3051 A
by-pass	THD101KC	228	310	10/81 > 12/85	S 4120 R			
power steering / servosterzo	THD101KC	228	310	10/81 > 12/85				S 3081 PO
Olympian Serie								
Olympian	DH10A245	180	245	07/97 >	S 0900 R	S 5020 NR		
by-pass	DH10A245	180	245	07/97 >	S 4120 R			
dryer filter / filtro essiccatore	DH10A245	180	245	07/97 >				S 7259 A
LONG LIFE	DH10A245	180	245	07/97 >	S 4402 R	S 5020 NR		
Olympian	TD102KF	180	245	07/95 >	S 0900 R	S 4323 NR		
by-pass	TD102KF	180	245	07/95 >	S 4120 R			
dryer filter / filtro essiccatore	TD102KF	180	245	07/95 >				S 7259 A
Super Olympian	D10A285	210	286	07/98 >	S 0900 R	S 5020 NR		
by-pass	D10A285	210	286	07/98 >	S 4120 R			
dryer filter / filtro essiccatore	D10A285	210	286	07/98 >				S 7259 A
LONG LIFE	D10A285	210	286	07/98 >	S 4402 R	S 5020 NR		
VOLVO CONSTRUCTION EQUIPMENT								
dump trucks/autocarri ribaltabili								
400 Serie								
411 B	Ford 2704 E				S 4380 PO	S 7112 NC		
some / alcuni	Ford 2704 E				S 4380 PO	S 6481 N		
or DELPHI / oppure DELPHI	Ford 2704 E				S 4380 PO	S 7111 NC		
412	Scania D8					S 4323 NR	S 6550 A	
some / alcuni	Scania D8					S 4323 NR	S 7839 A	
inner / interno	Scania D8						S 2840 A	
power steering / servosterzo	Scania D8							S 3081 PO
412	Scania DS8					S 4323 NR	S 6550 A	



KW HP



...VOLVO CONSTRUCTION EQUIPMENT - dump trucks/autocarri ribaltabili

some / alcuni	Scania DS8			S 4323 NR	S 7839 A	S 3081 PO	
inner / interno	Scania DS8				S 2840 A		
power steering / servosterzo	Scania DS8						
turbocompressor / turbocompressore	Scania DS8		S 2329 R				
412 T	Scania D8			S 4323 NR	S 6550 A	S 3081 PO	
some / alcuni	Scania D8			S 4323 NR	S 7839 A		
inner / interno	Scania D8				S 2840 A		
power steering / servosterzo	Scania D8						
412 T	Scania DS8			S 4323 NR	S 6550 A	S 3081 PO	
some / alcuni	Scania DS8			S 4323 NR	S 7839 A		
inner / interno	Scania DS8				S 2840 A		
power steering / servosterzo	Scania DS8						
turbocompressor / turbocompressore	Scania DS8		S 2329 R				
414	Scania			S 4323 NR	S 6550 A	S 3081 PO	
some / alcuni	Scania			S 4323 NR	S 0550 A		
inner / interno	Scania				S 2840 A		
power steering / servosterzo	Scania						
turbocompressor / turbocompressore	Scania		S 2329 R				
414 B	Scania			S 4323 NR	S 6550 A	S 3081 PO	
some / alcuni	Scania			S 4323 NR	S 0550 A		
inner / interno	Scania				S 2840 A		
power steering / servosterzo	Scania						
turbocompressor / turbocompressore	Scania		S 2329 R				
420	Scania			S 4323 NR		S 3301 PO	
1st passage / 1.passaggio	Scania			S 0201 N			
2nd passage / 2.passaggio	Scania			S 1411 N			
drive / trasmissione	Scania						
turbocompressor / turbocompressore	Scania		S 2329 R				
425	Scania DS11			S 4323 NR	S 4270 A	S 3301 PO	
drive / trasmissione	Scania DS11						
turbocompressor / turbocompressore	Scania DS11		S 2329 R				
425 B	Scania DS11			S 4323 NR	S 4270 A	S 3301 PO	
drive / trasmissione	Scania DS11						
turbocompressor / turbocompressore	Scania DS11		S 2329 R				
435	Cummins KT 1150		S 3409 R		S 7010 A	S 3301 PO	
drive / trasmissione	Cummins KT 1150						
440	Cummins NT 855		S 3409 R		S 9990 A	S 3301 PO	
drive / trasmissione	Cummins NT 855						
441	Scania DS14, DS14A			S 4323 NR		S 3301 PO	
drive / trasmissione	Scania DS14, DS14A						
turbocompressor / turbocompressore	Scania DS14, DS14A		S 2329 R				
442	Scania DS14, DS14A			S 4323 NR		S 3301 PO	
drive / trasmissione	Scania DS14, DS14A						
turbocompressor / turbocompressore	Scania DS14, DS14A		S 2329 R				
442 B	Scania DS14, DS14A			S 4323 NR		S 3301 PO	
drive / trasmissione	Scania DS14, DS14A						
turbocompressor / turbocompressore	Scania DS14, DS14A		S 2329 R				
443	Scania DS14, DS14A			S 4323 NR		S 3301 PO	
drive / trasmissione	Scania DS14, DS14A						
turbocompressor / turbocompressore	Scania DS14, DS14A		S 2329 R				
445	Detroit Diesel 12V-71T		S 3301 PO		S 5450 A	S 3301 PO	
inner / interno	Detroit Diesel 12V-71T				S 3450 A		
drive / trasmissione	Detroit Diesel 12V-71T						
500 Serie							
540	Cummins KT 1150		S 3409 R		S 5450 A	S 3301 PO	
inner / interno	Cummins KT 1150				S 3450 A		
drive / trasmissione	Cummins KT 1150						
550	Detroit Diesel 16V-71N		S 3301 PO		S 5450 A	S 3301 PO	
inner / interno	Detroit Diesel 16V-71N				S 3450 A		
drive / trasmissione	Detroit Diesel 16V-71N						
BM 540	Scania DSI 14			S 4323 NR		S 3301 PO	
with drain / con spurgo	Scania DSI 14	01/84 >		S 8501 NR			
turbocompressor / turbocompressore	Scania DSI 14		S 2329 R				
A 20 Serie							
A 20 (6x4)	TD71G		S 0900 R	S 4323 NR	S 0450 A	S 5569 PO	
hydraulic / idraulico	TD71G						
inner / interno	TD71G				S 1450 A		

V





kW HP



...VOLVO CONSTRUCTION EQUIPMENT - dump trucks/autocarri ribaltabili

bleed / sfiato	TD71G					S 7091 A
A 20 (6x6)	TD71G		S 0900 R	S 4323 NR	S 0450 A	
hydraulic / idraulico	TD71G					S 5569 PO
inner / interno	TD71G				S 1450 A	
bleed / sfiato	TD71G					S 7091 A
A 25 Serie						
A 25 (4x4)	TD71K		S 0900 R	S 4323 NR	S 0450 A	
hydraulic / idraulico	TD71K					S 5569 PO
inner / interno	TD71K				S 1450 A	
bleed / sfiato	TD71K					S 7091 A
A 25 (6x4)	TD71K		S 0900 R	S 4323 NR	S 0450 A	
hydraulic / idraulico	TD71K					S 5569 PO
inner / interno	TD71K				S 1450 A	
bleed / sfiato	TD71K					S 7091 A
A 25 C	TD73KCE	01/95 >	S 0900 R	S 4323 NR	S 0450 A	S 3051 A
by-pass	TD73KCE	01/95 >	S 4120 R			
fan cooling filter / filtro raffreddamento ventola	TD73KCE	01/95 >				S 8600 R
inner / interno	TD73KCE	01/95 >			S 1450 A	
LONG LIFE	TD73KCE	01/95 >	S 4402 R			
bleed / sfiato	TD73KCE	01/95 >				S 7091 A
drive / trasmissione	TD73KCE	01/95 >				S 2234 Z
A 35 Serie						
A 35 (6x6)	TD121G, TD122GA, TD122K		S 0900 R	S 4323 NR	S 5450 A	S 3051 A
some / alcuni	TD121G, TD122GA, TD122K		S 0900 R	S 4323 NR		S 3051 A
by-pass	TD121G, TD122GA, TD122K		S 4120 R			
water filter / filtro acqua	TD121G, TD122GA, TD122K					S 9006 AR
fan cooling filter / filtro raffreddamento ventola	TD121G, TD122GA, TD122K					S 8600 R
hydraulic / idraulico	TD121G, TD122GA, TD122K					S 5569 PO
inner / interno	TD121G, TD122GA, TD122K				S 7308 A	
inner / interno	TD121G, TD122GA, TD122K				S 3450 A	
LONG LIFE	TD121G, TD122GA, TD122K		S 4402 R			
bleed / sfiato	TD121G, TD122GA, TD122K					S 7091 A
A 35 C	TD121G, TD122GA, TD122K		S 0900 R	S 4323 NR	S 5450 A	S 3051 A
some / alcuni	TD121G, TD122GA, TD122K		S 0900 R	S 4323 NR		S 3051 A
by-pass	TD121G, TD122GA, TD122K		S 4120 R			
water filter / filtro acqua	TD121G, TD122GA, TD122K					S 9006 AR
fan cooling filter / filtro raffreddamento ventola	TD121G, TD122GA, TD122K					S 8600 R
hydraulic / idraulico	TD121G, TD122GA, TD122K					S 5569 PO
inner / interno	TD121G, TD122GA, TD122K				S 3450 A	
inner / interno	TD121G, TD122GA, TD122K				S 7308 A	
LONG LIFE	TD121G, TD122GA, TD122K		S 4402 R			
bleed / sfiato	TD121G, TD122GA, TD122K					S 7091 A
A 40 Serie						
A 40			S 0900 R	S 4323 NR		S 3051 A
by-pass			S 4120 R			
fan cooling filter / filtro raffreddamento ventola						S 8600 R
inner / interno					S 7308 A	
bleed / sfiato						S 7091 A
DD Serie						
DD 10						
to engine No. 20647 / a motore N. 20647	1113		S 0580 PO	S 7411 N		
from engine No. 20648 / da motore N. 20648	1113		S 0420 R	S 7411 N		
DD 1524	1114		S 0580 PO	S 7411 N		
DR Serie						
DR 5350	TD70G		S 0900 R	S 4323 NR	S 0450 A	
some / alcuni	TD70G		S 0900 R	S 0810 NR	S 0450 A	
hydraulic / idraulico	TD70G					S 5569 PO
inner / interno	TD70G				S 1450 A	
bleed / sfiato	TD70G					S 7091 A
drive / trasmissione	TD70G					S 3301 PO
DR 5350 B	TD70G		S 0900 R	S 4323 NR	S 0450 A	
some / alcuni	TD70G		S 0900 R	S 0810 NR	S 0450 A	
hydraulic / idraulico	TD70G					S 5569 PO
inner / interno	TD70G				S 1450 A	
bleed / sfiato	TD70G					S 7091 A
drive / trasmissione	TD70G					S 3301 PO
DR 630						



kW HP



...VOLVO CONSTRUCTION EQUIPMENT - dump trucks/autocarri ribaltabili

to engine No. 20647 / a motore N. 20647	1113		S 0580 PO	S 7411 N		
from engine No. 20648 / da motore N. 20648	1113		S 0420 R	S 7411 N		
DR 631						
to engine No. 20647 / a motore N. 20647	1113		S 0580 PO	S 7411 N		
from engine No. 20648 / da motore N. 20648	1113		S 0420 R	S 7411 N		
DR 631	1113 A		S 0420 R	S 7111 NC		
DR 826	TD50B		S 5800 R	S 7411 N	S 2450 A	
some / alcuni	TD50B		S 5800 R	S 7111 NC	S 2570 A	
hydraulic / idraulico	TD50B					S 5569 PO
inner / interno	TD50B				S 3940 A	
inner / interno	TD50B				S 4370 A	
DR 860	D50A		S 5800 R	S 7411 N	S 4450 A	
some / alcuni	D50A		S 5800 R	S 0810 NR	S 0450 A	
inner / interno	D50A				S 1450 A	
DR 860 S	TD60A		S 5800 R	S 4323 NR	S 2650 A	
some / alcuni	TD60A		S 5800 R	S 0810 NR	S 0450 A	
hydraulic / idraulico	TD60A					S 5569 PO
inner / interno	TD60A				S 1450 A	
inner / interno	TD60A				S 7129 A	
DR 860 T	TD50B		S 5800 R	S 7411 N	S 4450 A	
some / alcuni	TD50B		S 5800 R	S 7111 NC	S 2570 A	
inner / interno	TD50B				S 3940 A	
inner / interno	TD50B				S 4370 A	
DR 860 TL	TD50B		S 5800 R	S 7411 N	S 2450 A	
some / alcuni	TD50B		S 5800 R	S 7111 NC	S 2570 A	
hydraulic / idraulico	TD50B					S 5569 PO
inner / interno	TD50B				S 3940 A	
inner / interno	TD50B				S 4370 A	
DR 861	TD60B		S 5800 R	S 4323 NR	S 2650 A	
some / alcuni	TD60B		S 5800 R	S 0810 NR	S 0450 A	
hydraulic / idraulico	TD60B					S 5569 PO
inner / interno	TD60B				S 7129 A	
inner / interno	TD60B				S 1450 A	
DR 861 S	TD60A		S 5800 R	S 4323 NR	S 2650 A	
some / alcuni	TD60A		S 5800 R	S 4323 NR	S 2570 A	
hydraulic / idraulico	TD60A					S 5569 PO
inner / interno	TD60A				S 7129 A	
inner / interno	TD60A				S 4370 A	
DR 861 T	TD60B		S 5800 R	S 4323 NR	S 2650 A	
some / alcuni	TD60B		S 5800 R	S 0810 NR	S 0450 A	
hydraulic / idraulico	TD60B					S 5569 PO
inner / interno	TD60B				S 7129 A	
inner / interno	TD60B				S 1450 A	
DS Serie						
DS 630						
to engine No. 20647 / a motore N. 20647	1113		S 0580 PO	S 7411 N		
from engine No. 20648 / da motore N. 20648	1113		S 0420 R	S 7411 N		
TC Serie						
TC 860 T	TD50B		S 5800 R	S 7411 N	S 2450 A	
some / alcuni	TD50B		S 5800 R	S 7111 NC	S 2570 A	
hydraulic / idraulico	TD50B					S 5569 PO
inner / interno	TD50B				S 3940 A	
inner / interno	TD50B				S 4370 A	
TC 860 TL	TD50B		S 5800 R	S 7411 N	S 2450 A	
some / alcuni	TD50B		S 5800 R	S 7111 NC	S 2570 A	
hydraulic / idraulico	TD50B					S 5569 PO
inner / interno	TD50B				S 3940 A	
inner / interno	TD50B				S 4370 A	
ZASTAVA (YUGO)						
trucks/autocarri						
616						
616	Perkins		S 9400 R	S 7111 NC		
616N2			S 9710 R	S 7111 NC		
619						
619N1P			S 0230 R	S 0710 NR		
635						
635			S 9710 R	S 0610 NR		

Z





kW HP



...ZASTAVA (YUGO) - trucks/autocarri

Z



640					
640			S 9710 R	S 0610 NR	
645					
645			S 9710 R	S 0610 NR	
650					
650			S 9710 R	S 0610 NR	
Campagnola					
1107/A			S 5700 R		
ZETTELMAYER			dump trucks/autocarri ribaltabili		
ZD Serie					
3000				S 5270 A	S 0530 PO
hydraulic / idraulico					
3000 F	KHD		S 8600 R	S 6710 NR	S 5270 A
3000 FA	KHD		S 8600 R	S 6710 NR	S 5270 A
3001	Mercedes Benz OM422		S 7261 PO	S 2162 N	S 7839 A
3001 SK	Mercedes Benz OM422		S 7261 PO	S 2162 N	S 7839 A
ZF			transmissions/trasmissioni		
Ecomat (HP Serie)					
500 (4/5/6HP500)					S 2234 Z
502 C (4/5/6HP502C)					S 2234 Z
552 C (4/5/6HP552C)					S 2234 Z
590 (4/5/6HP590)					S 2234 Z
592 C (4/5/6HP592C)					S 2234 Z
600 (4/5/6HP600)					S 2234 Z
602 C (4/5/6HP602C)					S 2234 Z
Ecosplit					
Ecosplit + Intarder		01/94 >			S 2234 Z

WEB CATALOGUE

Updated in real time.

Available in **8 languages**.

Possibility of browsing by catalogue type, brand, model and version.

Possibility to browse the **New Filters included** in the range by selecting the period of interest.

Simple and clear symbols to identify the type of product and to see which filters are "available", "in preparation" or "under review".

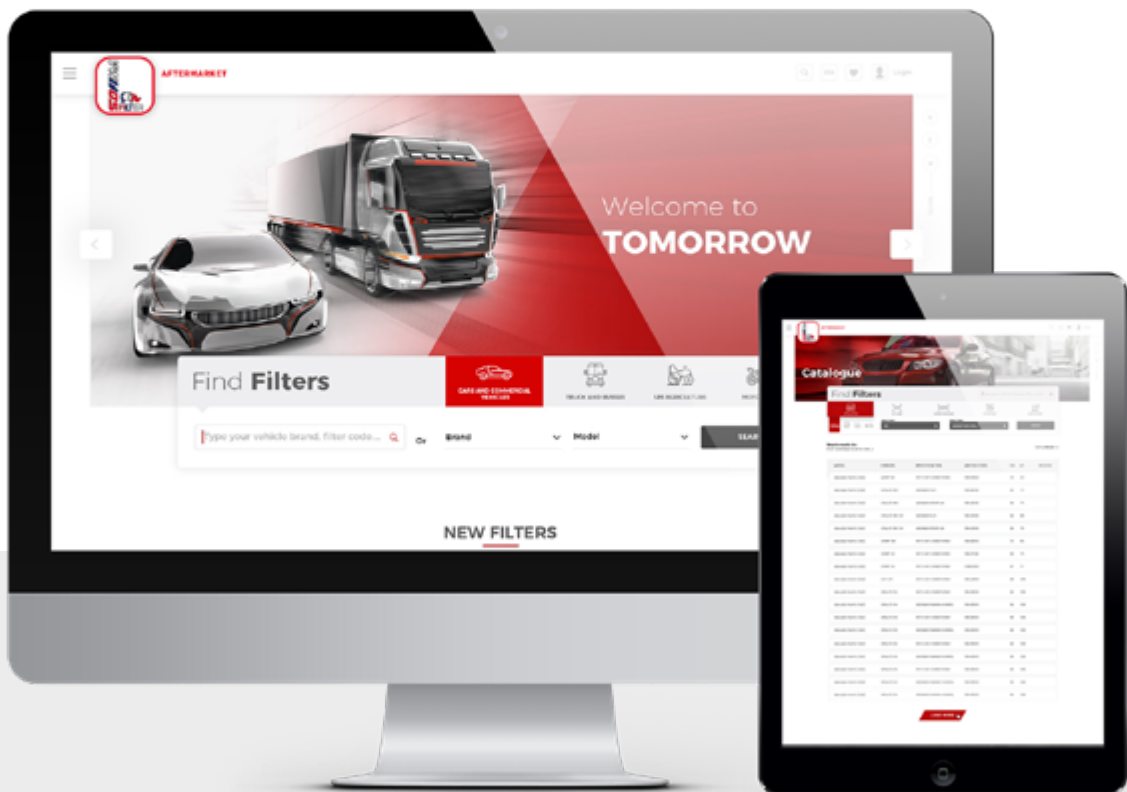

BROWSE OUR ONLINE CATALOGUE

with over 68,700 vehicles and 137,000 cross references at:

www.sofima-aftermarket.com



SOFIMA FILTER
CHOSEN BY THE BEST

www.ufifilters.com



For further information, please check our catalogue:

www.sofima-aftermarket.com

Catalogo gratuito fuori commercio.

Esente I.V.A. ai sensi art 2-3 comma lett. c D.P.R. 26/10/72 n° 633



Cod. 09.92.100.104

LEGAL AND ADMINISTRATIVE OFFICES

Via Europa, 26
46047 Porto Mantovano (MN) - Italy
T +39 0376 386811 - F +39 0376 386812
ammin@it.uffilters.com

TECHNICAL/SALES DIVISION AND OFFICES

Via dell'Industria, 4
37060 Nogarole Rocca (VR) - Italy
T +39 045 6339911 - F +39 045 6395011
commerc@it.uffilters.com